

> IFP9850-3

Commercial Touch Display User Guide

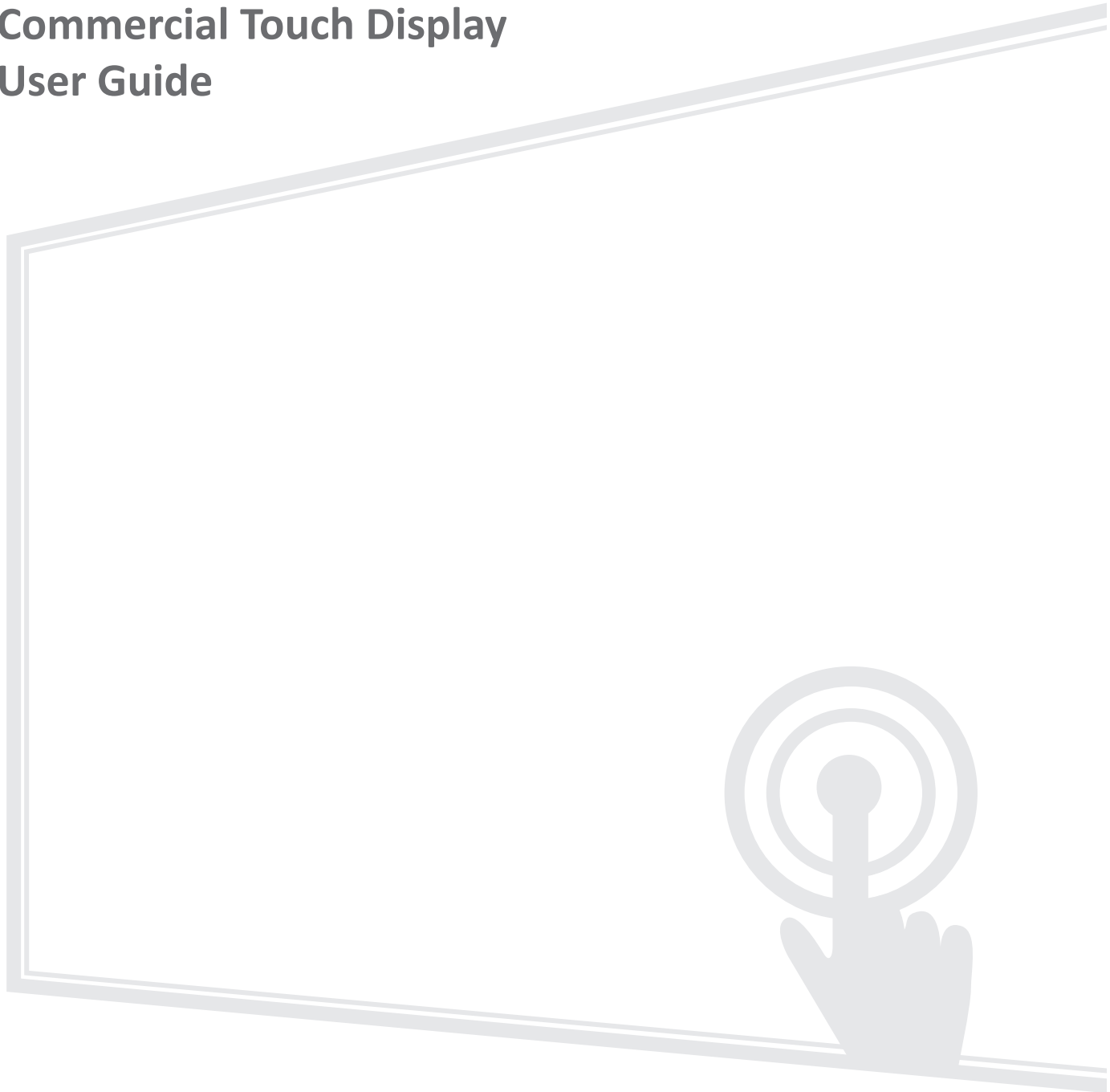

IMPORTANT: Please read this User Guide to obtain important information on installing and using your product in a safe manner, as well as registering your product for future service. Warranty information contained in this User Guide will describe your limited coverage from ViewSonic® Corporation, which is also found on our web site at <http://www.viewsonic.com> in English, or in specific languages using the Regional selection box in the upper right corner of our website. "Antes de operar su equipo lea cuidadosamente las instrucciones en este manual"

Model No. VS17853
P/N: IFP9850-3

Thank you for choosing ViewSonic®

As a world-leading provider of visual solutions, ViewSonic® is dedicated to exceeding the world's expectations for technological evolution, innovation, and simplicity. At ViewSonic®, we believe that our products have the potential to make a positive impact in the world, and we are confident that the ViewSonic® product you have chosen will serve you well.

Once again, thank you for choosing ViewSonic®!

> Safety Precautions

Please read the following **Safety Precautions** before you start using the device.

- Keep this user guide in a safe place for later reference.
- Read all warnings and follow all instructions.
- Do not use the device near water. To reduce the risk of fire or electric shock, do not expose the device to moisture.
- Never remove the rear cover. This display contains high-voltage parts. You may be seriously injured if you touch them.
- Avoid exposing the device to direct sunlight or other sources of sustained heat.
- Do not install near any heat sources such as radiators, heat registers, stoves, or other devices (including amplifiers) that may increase the temperature of the device to dangerous levels.
- Use a soft, dry cloth to clean the external housing. For more information, refer to the "Maintenance" section on page 116.
- When moving the device, be careful not to drop or bump the device on anything.
- Do not place the device on an uneven or unstable surface. The device may fall over resulting in an injury or a malfunction.
- Do not place any heavy objects on the device or connection cables.
- If smoke, an abnormal noise, or a strange odor is present, immediately turn the device off and call your dealer or ViewSonic®. It is dangerous to continue using the device.
- The device is a monitor with an LED backlight intended for general office use.
- Do not attempt to circumvent the safety provisions of the polarized or grounding-type plug. A polarized plug has two blades with one wider than the other. A grounding-type plug has two blades and a third grounding prong. The wide blade and the third prong are provided for your safety. If the plug does not fit into your outlet, obtain an adapter and do not attempt to force the plug into the outlet.
- When connecting to a power outlet, DO NOT remove the grounding prong. Please ensure grounding prongs are NEVER REMOVED.
- Protect the power cord from being treaded upon or pinched, particularly at the plug, and at the point where it emerges from the equipment. Ensure that the power outlet is located near the equipment so that it is easily accessible.

- Only use attachments/accessories specified by the manufacturer.
- When a cart is used, use with caution when moving the cart/equipment combination to avoid injury from tipping over.
- Disconnect the power plug from the AC outlet if the device is not being used for a long period of time.
- Place the device in a well-ventilated area. Do not place anything on the device that prevents heat dissipation.

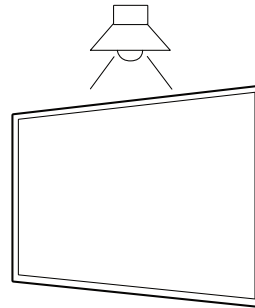
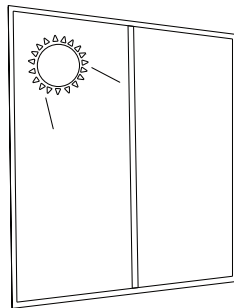
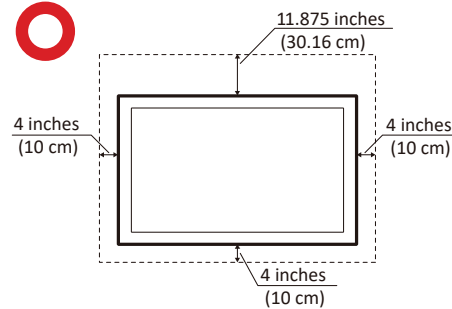
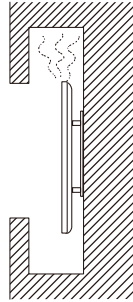

- Refer all servicing to qualified service personnel. Service will be required when the unit has been damaged in any way, such as:
 - » if the power supply cord or plug is damaged
 - » if liquid is spilled onto or objects fall in the unit
 - » if the unit is exposed to moisture
 - » if the unit does not operate normally or has been dropped





> Contents

Safety Precautions.....	3
Introduction	10
Package Contents	10
Wall Mount Kit Specifications (VESA)	11
Product Overview	12
Control Panel.....	12
I/O Panel.....	13
Remote Control	14
Using Gestures	17
Select and Deselect an Object (Clicking)	17
Display Menu Options (Right-Clicking)	17
Double-Clicking	17
Moving an Object	18
Erasing Digital Ink	18
Swipe Up for General Settings.....	18
Making Connections	19
Connecting External Devices	19
VGA Connection	19
HDMI Connection	19
RS232 Connection	20
USB, Networking, and Microphone Connections.....	21
Media Player Connection	22
SPDIF Connection	23
Video Output Connection	24

Using Your ViewBoard..... 25

Powering On/Off your ViewBoard.....	25
Initial Launch Setup	26
vLauncher - Customizable Welcome Screen.....	28
Tool Bar	29
ViewBoard On-Screen Display (OSD) Menu	35
General Settings	36
Audio Settings	38
Screen Settings.....	39
Display Settings	40
Adjust Settings	41
Advanced Settings.....	42
Wireless & Networks	42
Wi-Fi	43
Ethernet	44
Wireless Hotspot.....	45
BT	46
VPN.....	47
Share	49
Device.....	51
Theme	51
Display.....	51
Wallpaper	52
HDMI Out Encryption Setting	53
Burn-in Protection Interval.....	54
Storage	54
Sound	54
Personal.....	55
Security.....	55
Trusted Credentials.....	55
Clear Credentials	56
Unknown Sources.....	56
Language & Input	57
Language	57
Current Keyboard	57
Existing Keyboard	58
Startup and Shutdown	59
Startup Channel.....	59

Built-in PC Startup Option	59
Standby Mode	60
Black Screen After Startup.....	61
Close Power Off Reminder	61
Password for Screen Lock.....	62
Input Setting.....	63
Input Alias Switch	63
Wake on Active Source.....	64
Auto Search	64
Channel Auto Switch	64
No Signal Power Off.....	64
HDMI CEC Settings.....	64
Other Settings.....	65
Side Toolbar Channel.....	65
ECO Mode	65
System	66
Date & Time	66
About Device	68
System Update	68
Advanced.....	70
Mode	70
APP	71
Password	72
USB Disk Enable.....	72
Privacy	72

Embedded Applications and Settings.....	73
Embedded Digital Whiteboard App.....	73
myViewBoard	73
Floating Bar	73
Toolbar	73
vBoard Lite	75
User Interface:.....	75
Menu Options:	75
Watercolor Feature	76
ViewBoard Cast	77
Cast Sender from Windows-based Devices, Macbook, and Chrome devices.	78
Cast Sender from Mobile Devices: iOS-based (iPhone, iPad) and Android OS based phone/tablet.	79
Cast Out from a Mobile Device that Supports Annotation	80
Air Class	81
 Voter.....	82
 Responder.....	84
 Message	84
 Manager.....	84
 Exit.....	84
Other Default Applications.....	85
Zoom	85
Join a Meeting.....	86
Start an Instant Meeting.....	87
Sweeper	88
Screen Lock	89
Set Password	89
Screen Lock Enabled.....	89
Chromium.....	90
Folders.....	91

RS-232 Protocol	93
Description	93
RS232 Hardware Specification	93
LAN Hardware Specification.....	94
RS232 Communication Setting.....	94
LAN Communication Setting	94
Command Message Reference.....	94
Protocol	95
Set-Function Listing.....	95
Get-Function Listing	101
Remote Control Pass-through Mode	109
Appendix	112
Specifications.....	112
Display Modes	113
VGA Mode	113
HDMI Mode.....	113
Troubleshooting	114
Maintenance.....	116
General Precautions.....	116
Cleaning the Screen.....	116
Cleaning the Case	116
Regulatory and Service Information	117
Compliance Information.....	117
FCC Compliance Statement.....	117
Industry Canada Statement.....	117
CE Conformity for European Countries.....	117
Declaration of RoHS2 Compliance.....	118
ENERGY STAR statement.....	119
Indian Restriction of Hazardous Substances	119
Product Disposal at End of Product Life	119
Copyright Information	120
Customer Service	121
Limited Warranty	122
Mexico Limited Warranty.....	125

> Introduction

Package Contents

- HDMI cable
- Power cable x 4
- Remote control
- AAA battery x 2
- USB cable
- AV cable
- Stylus pen x 2
- Quick start guide
- RS232 adapter
- Clamp x 5
- Plate
- Screw x 8

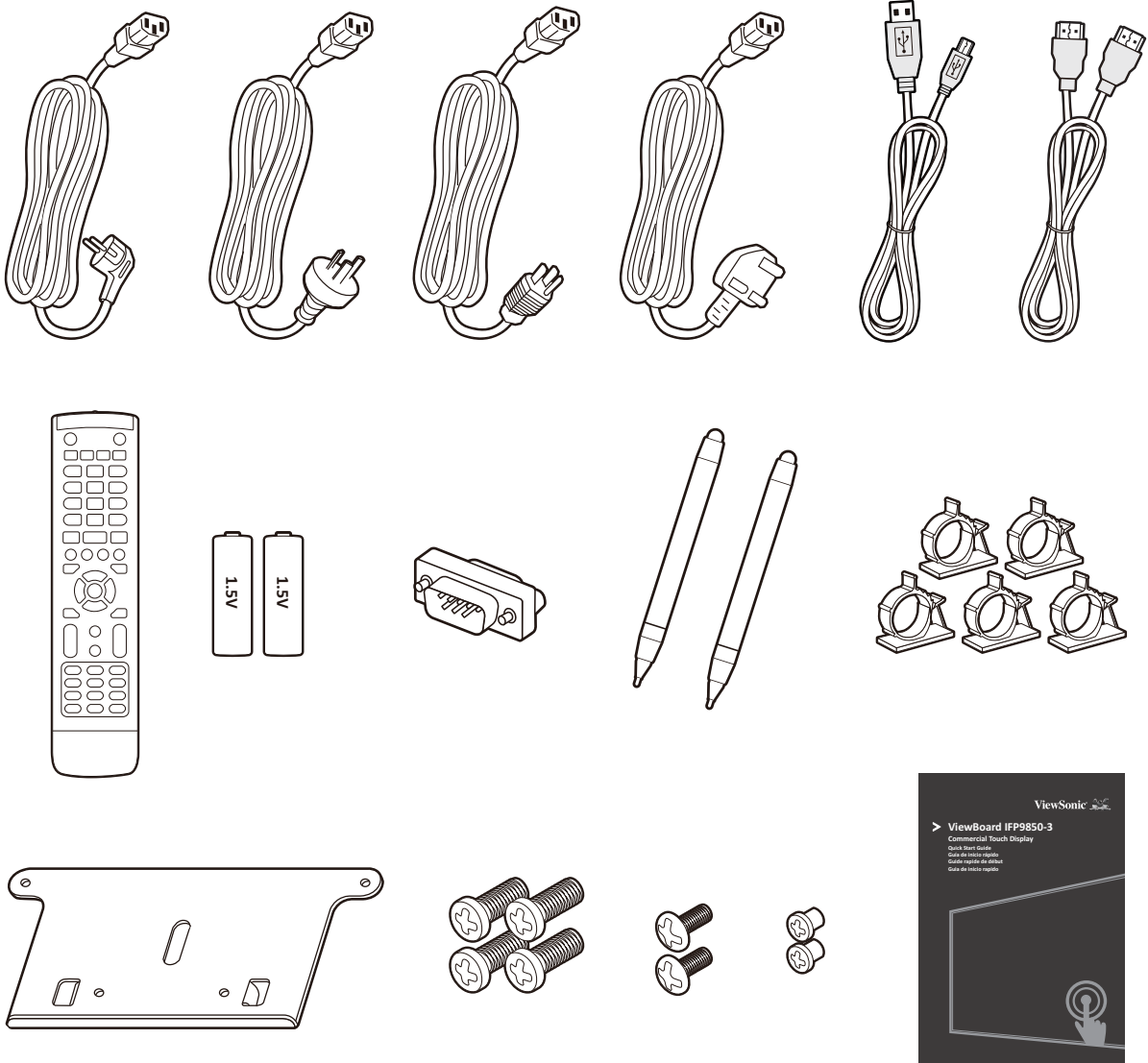

NOTE: The power cord and video cables included in your package may vary depending on your country. Please contact your local reseller for more information.

Wall Mount Kit Specifications (VESA)

NOTE: Please follow the instructions in the wall mount installation guide to install your wall mount or mobile mount bracket. If attaching to other building materials, please contact your nearest dealer.

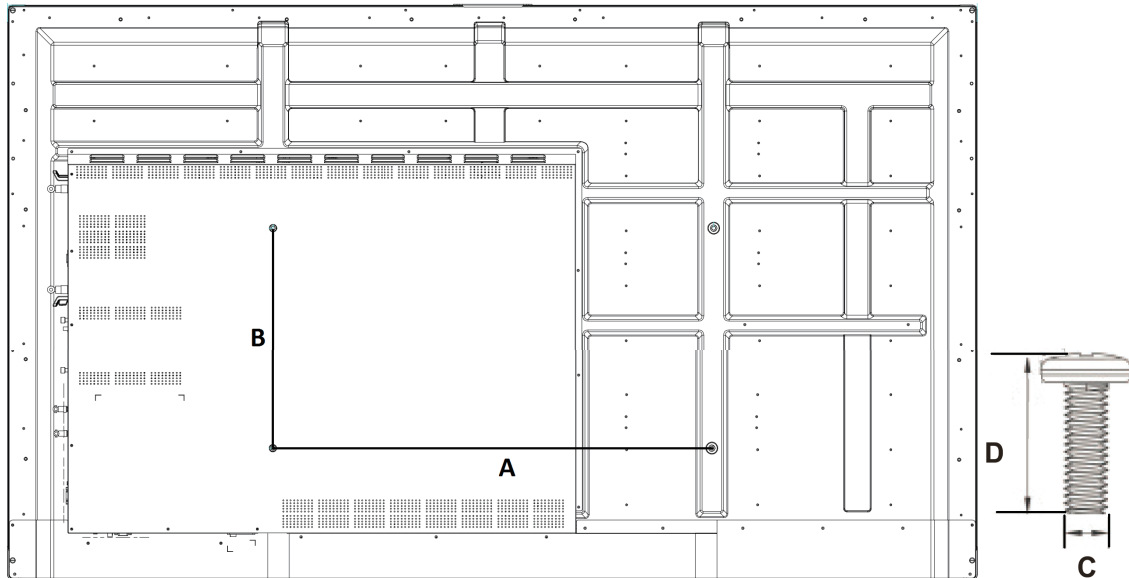

Model	VESA Spec. (A x B)	Standard Screw (C x D)	Quantity
IFP9850-3 - 98"	800 x 600 mm	M8 x 25 mm	4

NOTE: Do not use screws that are longer than the standard dimension, as they may cause damage to the inside of the display.

Product Overview

Control Panel

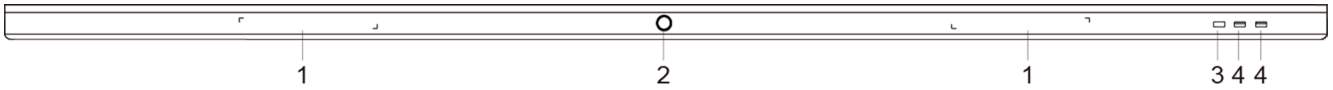

Number	Description
1	Areas for placing touching pen
2	<ul style="list-style-type: none">• Press the key to turn on the device• Press the key to turn off/on the display backlight only Press and hold the key to turn off the device
3	Remote control receiver
4	USB port for Embedded Player and internal PC

I/O Panel

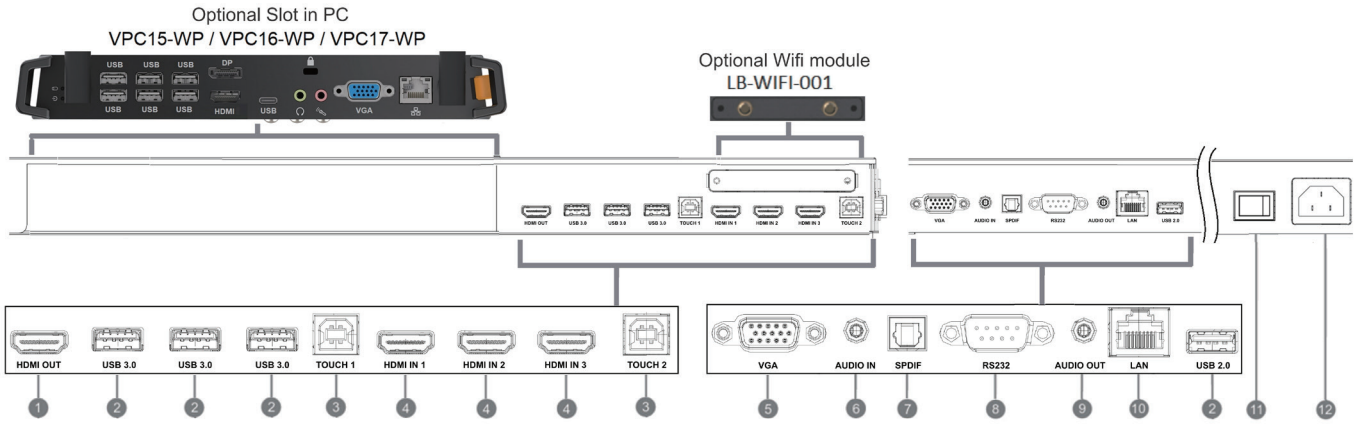

Number	Description
1	Extend content out to another display device
2	USB port for Embedded Player and internal PC
3	<ul style="list-style-type: none"> • Touch signal output to the external PC • Touch 1 for HDMI IN 2 and 3 • Touch 2 for HDMI IN 1 and VGA IN
4	<ul style="list-style-type: none"> • High-definition multimedia interface signal input, connect to PC with HDMI output, set-top box, or other video device • HDMI 1, 2, 3 support up to 3840x2160@60Hz, HDCP 2.2 • HDMI 1, 2, 3 support HDMI CEC(One Touch Play, System Standby, partial Remote Control Pass Through)
5	External computer image input
6	External computer audio input
7	SPDIF output
8	Serial interface, used for mutual transfer of data between devices
9	Audio output to the external speaker
10	Standard RJ45 (10M/100M/1G) Internet connection interface <ul style="list-style-type: none"> • Used for the Embedded Player and Slot-in PC
11	Power On / Off switch
12	AC power input

Remote Control

- 1 :
Press to turn the display ON/OFF
- 2 :
Mute / Unmute
- 3 DISPLAY :
Display information of the current input source
- 4 P.MODE :
Blank screen
- 5 FREEZE :
Freeze screen
- 6 Numeric button:
Numeric input button
- 7 -/--, ALT+TAB:
Press to switch between PC applications
- 8 0:
Numeric input button
- 9 , ALT+F4 :
Close current PC window
- 10 INPUT:
Source selection button
- 11 MENU:
Press to display Menu
- 12 RED+ALT:
Screen capture
- 13 GREEN+TAB:
PC 'Tab' button
- 14 YELLOW+DESKTOP:
Switch to slot in PC desktop
- 15 BLUE+BACKSPACE:
PC 'Backspace' button
- 16 , 19 MENU:
PC 'Windows' button
- 17 , D. TITLE:
PC 'Menu' button
- 18 :
Press to scroll up
- :
Press to scroll left
- 20 :
Press to scroll right
- 21 :
Press to scroll down
- 22 ENTER:
Enter button. Press it to select options.
- 23 , D. USB:
Writing software startup
- 24 ESC/EXIT, D. SETUP:
Shortcut button to exit dialog boxes
- 25 EPG:
Back
- 26 FAV, SPACE:
PC 'Space' button
- 27 CH. +, CH. -:
CH+ : PC previous page
CH- : PC next page
- 28 VOL+, VOL-:
Increase / Decrease volume
- 29 F1:
Windows F1 Function
- 30 F2:
Windows F2 Function
- 31 F3:
Windows F3 Function
- 32 F4:
Windows F4 Function
- 33 F5:
Windows F5 Function
- 34 F6:
Windows F6 Function
- 35 F7:
Windows F7 Function
- 36 F8:
Windows F8 Function
- 37 F9:
Windows F9 Function
- 38 F10:
Windows F10 Function
- 39 F11:
Windows F11 Function
- 40 F12:
Windows F12 Function

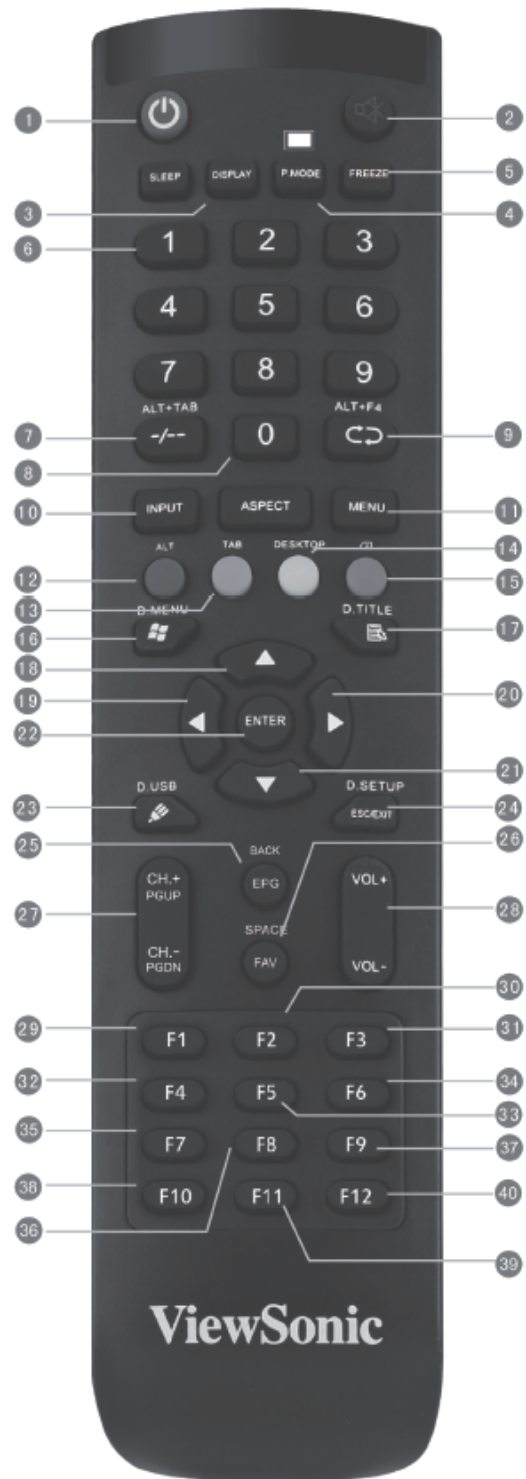

Inserting Remote Control Batteries

To insert batteries into the remote control:

1. Remove the cover on the rear of the remote control.
2. Insert two “AAA” batteries, ensuring the “+” symbol on the battery matches the “+” on the battery post.
3. Replace the cover by aligning it with the slot on the remote control and snapping the latch shut.

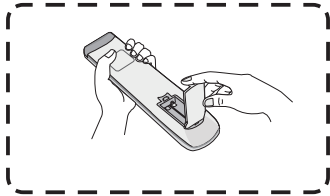

(1)

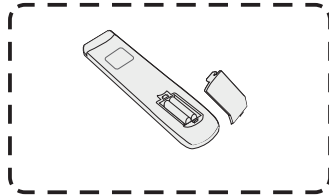

(2)

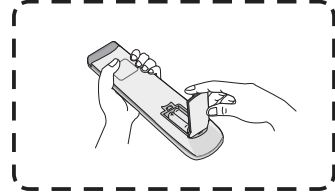

(3)

WARNING: There is a risk of explosion if batteries are replaced with the incorrect type.

NOTE:

- It is recommended that you do not mix battery types.
- Always dispose of old batteries in an environmentally friendly way. Contact your local government for more information on how to dispose of batteries safely.

Remote Control Receiver Range

The working range of the remote control is shown here. It has an effective range of 8 meters. Ensure there is nothing obstructing the remote control's signal to the receiver.

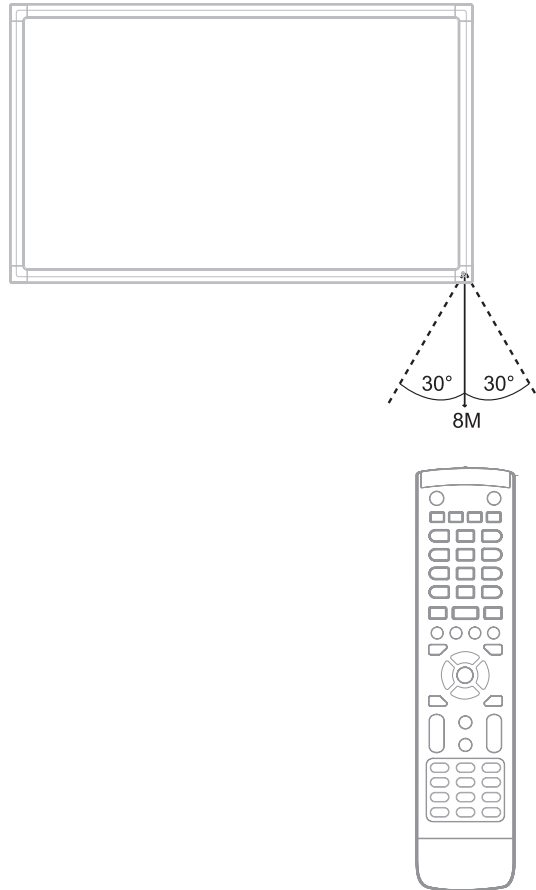

Using Gestures

Touch gestures allow the user to use pre-determined commands without using a keyboard or mouse. Using gestures on the ViewBoard, the user can select/deselect objects, change the location of an object, access settings, erase digital ink, and much more.

Select and Deselect an Object (Clicking)

Press and release the ViewBoard to select/deselect options or objects. This is like a single, standard left mouse click.

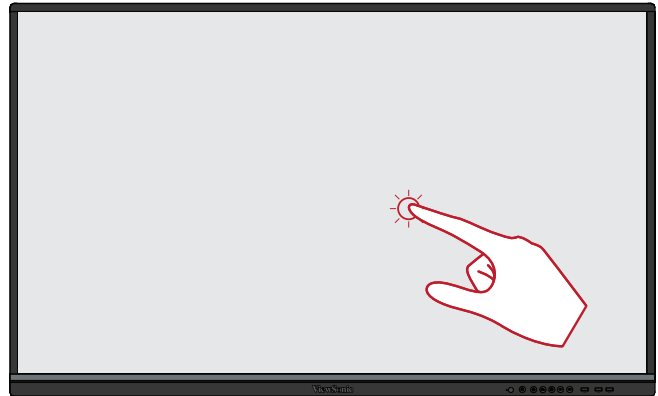

Display Menu Options (Right-Clicking)

Press and hold the ViewBoard with your finger. This is like a single, standard right mouse click.

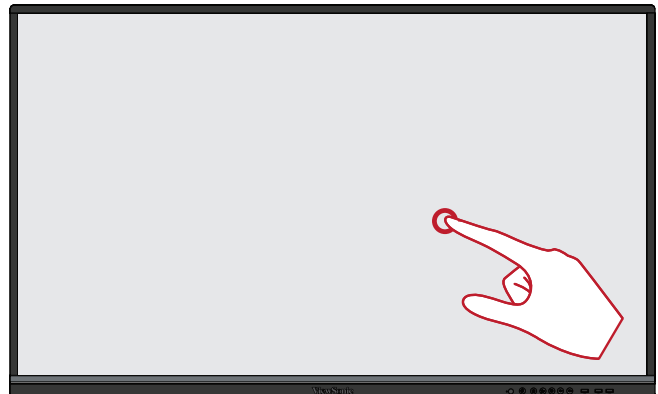

Double-Clicking

Quickly press and release twice in the same location on the ViewBoard. This is like a double, standard left mouse click.

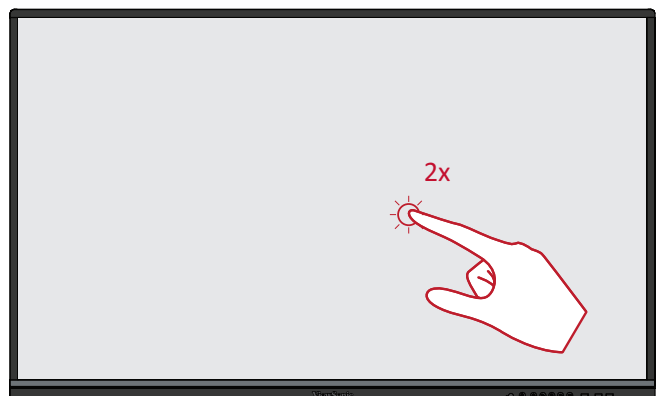

Moving an Object

Press and hold the object on the ViewBoard and slowly drag it with your finger to your desired location.



Erasing Digital Ink

Use your flattened hand, palm, or fist on the ViewBoard and move your hand across the area which you wish to erase.

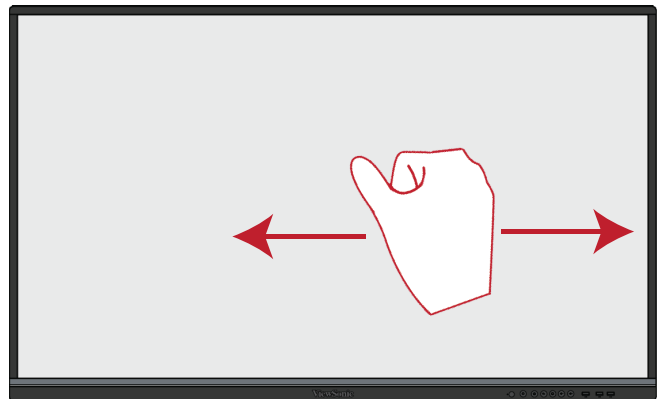

Swipe Up for General Settings

Swipe up from the bottom of the ViewBoard to launch the General Settings. To learn more see page 35.

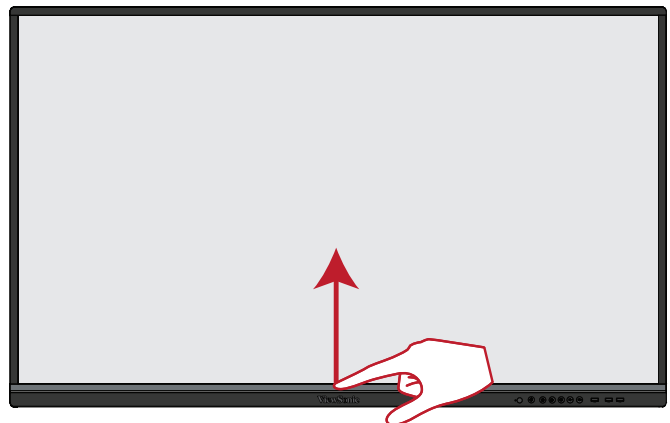

> Making Connections

This section guides you on how to connect the ViewBoard with other equipment.

Connecting External Devices

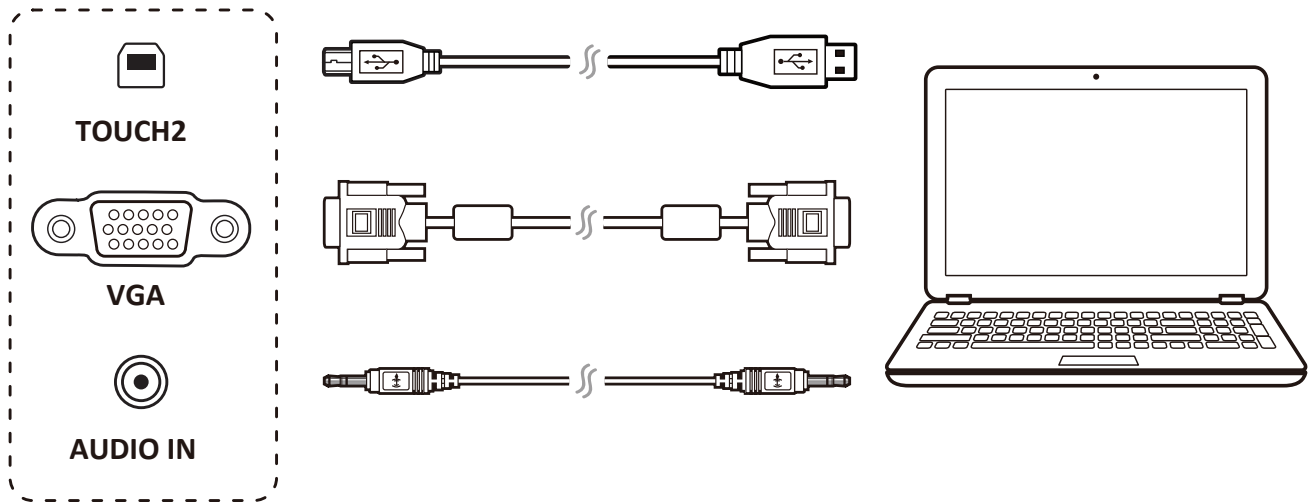

VGA Connection

To connect via VGA:

1. Connect a VGA cable (15-pin) from your external device to the **VGA IN** port on the display.
2. Connect an audio cable from the **AUDIO OUT** port on your external device to the **AUDIO IN** port on the display.
3. Connect a USB cable to the external device from the **TOUCH OUT** port of the display.

HDMI Connection

To connect via HDMI:

1. Connect an HDMI cable from your external device to the **HDMI IN** port on the display.
2. Connect a USB cable to the external device from the **TOUCH OUT** port of the display.

RS232 Connection

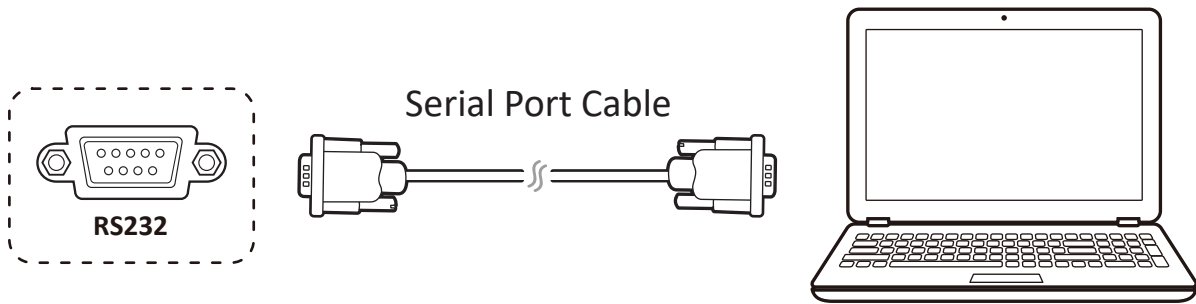

When you use a RS232 serial port cable to connect your display to an external computer certain functions can be controlled remotely by the PC, including Power On/Off, Volume adjustment, Input select, Brightness, and more.

ViewSonic also offers a complimentary software, vController, that allows users to control their ViewSonic commercial displays from a remote PC.

USB, Networking, and Microphone Connections

Just like any PC, it is easy to connect various USB devices and other peripherals to your ViewBoard.

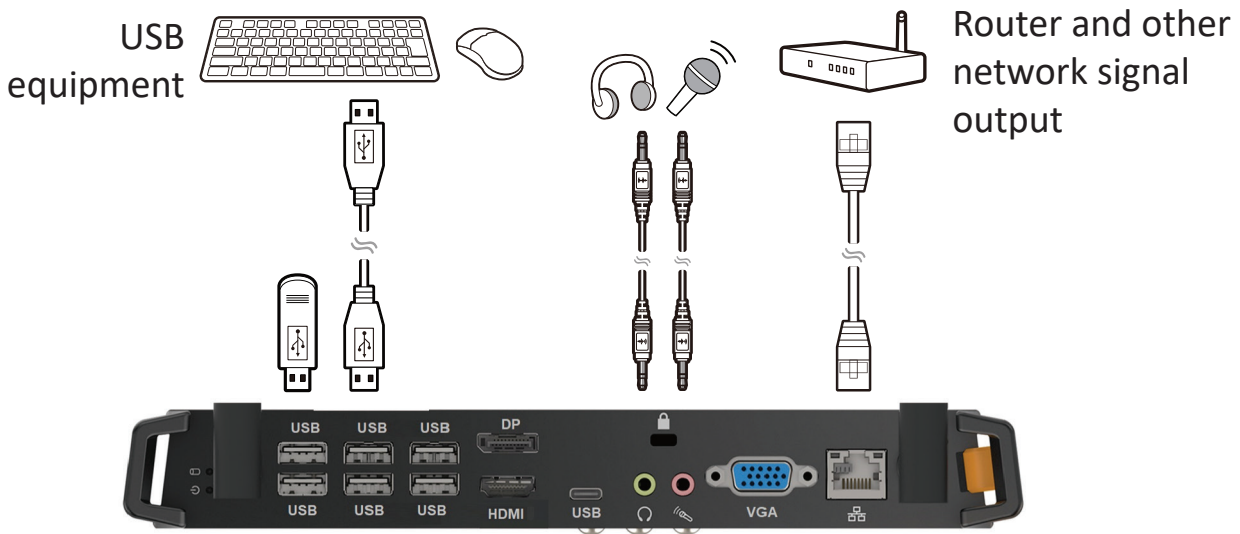

USB Peripherals

Plug the USB device cable into the **USB IN** port.

Networking and Modem cables

Plug the router cable into the **LAN IN** port.

Microphone

Plug the microphone cable into the **MIC** port.

Media Player Connection

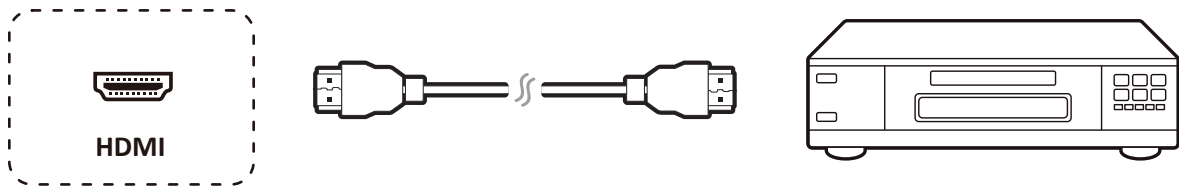

To connect to a media player:

1. Connect the HDMI cable to the **HDMI** ports on your ViewBoard and peripheral device.
2. Plug in the power cord of your ViewBoard, and turn on the rear-panel power supply switch.
3. Press the **Power** button on the right-hand side of the ViewBoard to turn the screen on.
4. Press the **INPUT** button to switch to the “HDMI” input source.

NOTE:

- HDMI 1/2/3 supports up to 3840 x 2160 @ 60Hz
- HDMI 1/2/3 supports HDMI CEC

SPDIF Connection

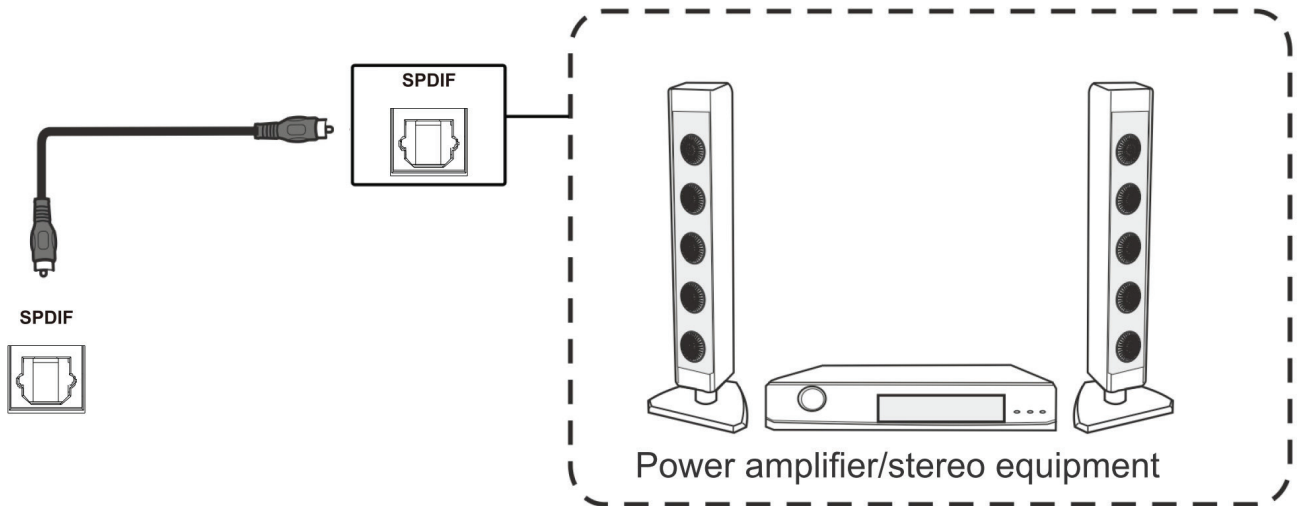

To connect to an external sound system:

1. Connect an optical cable from **DIGITAL OUT** to your sound system's optical connector.
2. Plug in the power cord of your ViewBoard, and turn on the rear-panel power supply switch.
3. Press the **Power** button on the right-hand side of the ViewBoard to turn the screen on.

Video Output Connection

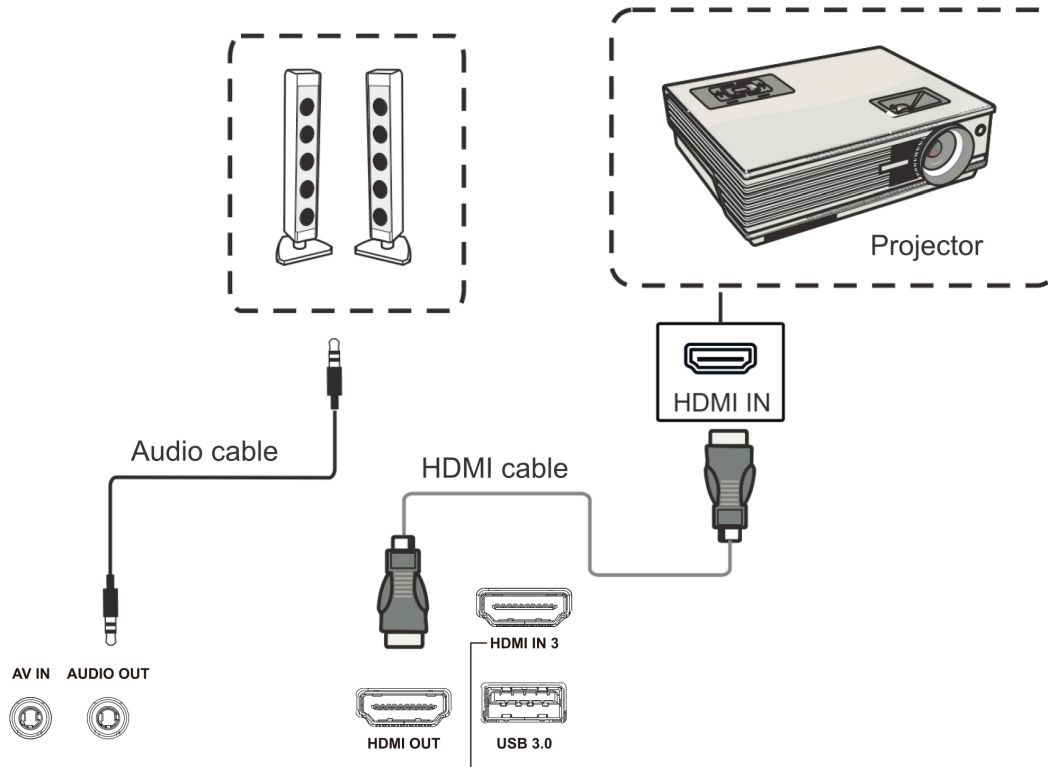

To output video via a display device:

1. Connect an HDMI cable to the **HDMI IN** port of your display device, and the other end to the **HDMI OUT** port of your ViewBoard.
2. For audio, connect one end of an audio cable to your ViewBoard's **AUDIO OUT** port and the other end to your speakers.
3. Plug in the power cord of your ViewBoard, and turn on the rear-panel power supply switch.
4. Press the **Power** button on the right-hand side of the ViewBoard to turn the screen on.

NOTE: The **HDMI OUT** port can output a resolution of 1920 x 1080 @ 60Hz.

> Using Your ViewBoard

Powering On/Off your ViewBoard

1. Ensure the power cord is connected, plugged into a power outlet, and the power switch is in the “On” position.

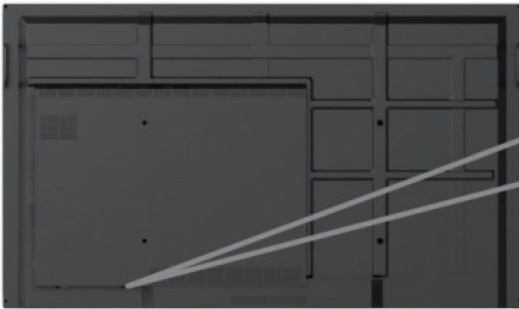

The AC Power input and switch button are located at the bottom of the unit.



2. Press the **⏻ Power** button to turn on the ViewBoard.



Press the **⏻ Power** button to turn on the ViewBoard.

3. To turn the ViewBoard off, press and hold the **⏻ Power** button again.

Initial Launch Setup

When you first turn on your ViewBoard, an initial setup wizard will launch.

1. Select your Language:

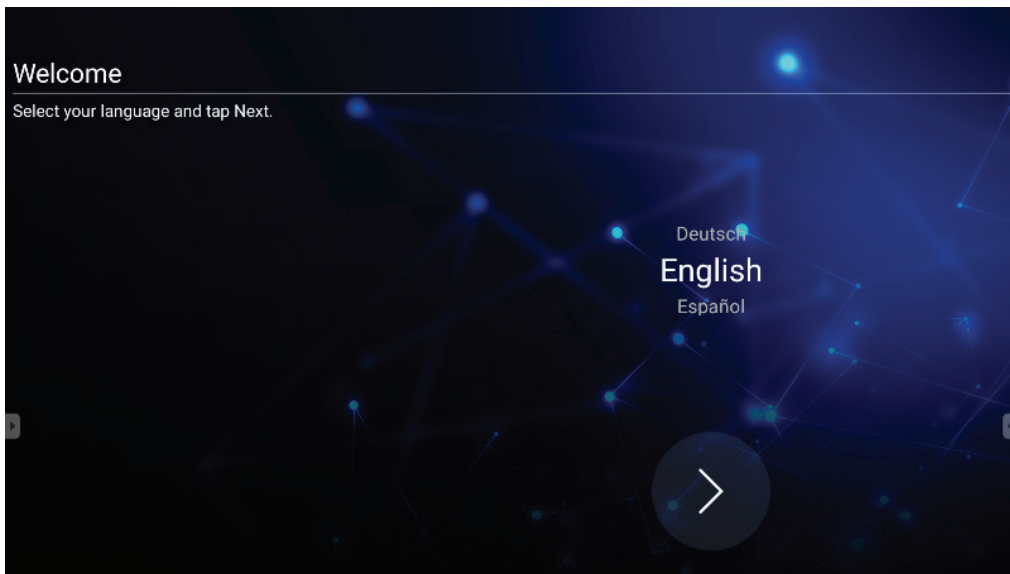

2. Setup and verify your LAN connection:

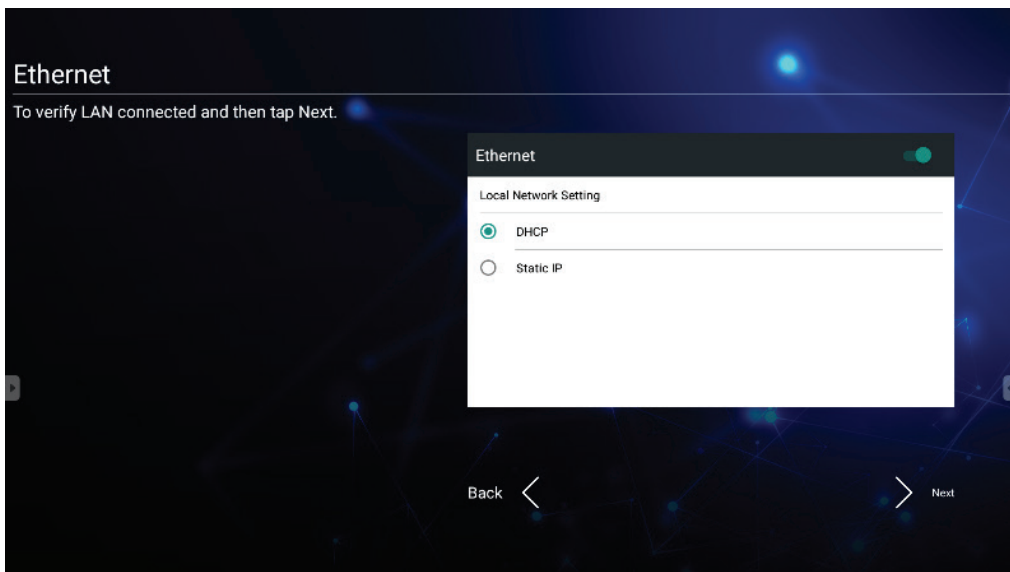

3. Select your Time Zone to set the Date and Time:

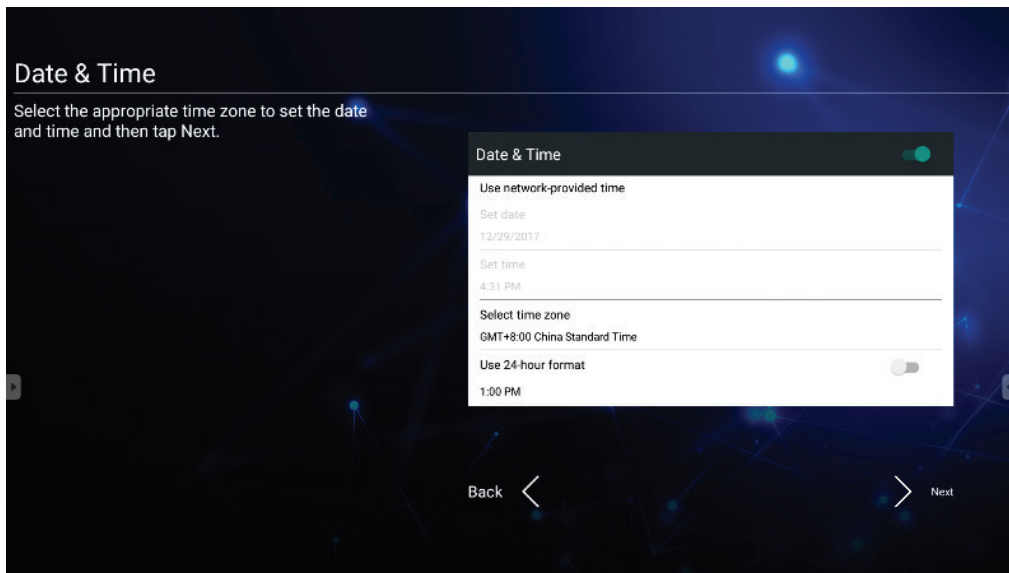

4. Select your preferred System Mode:

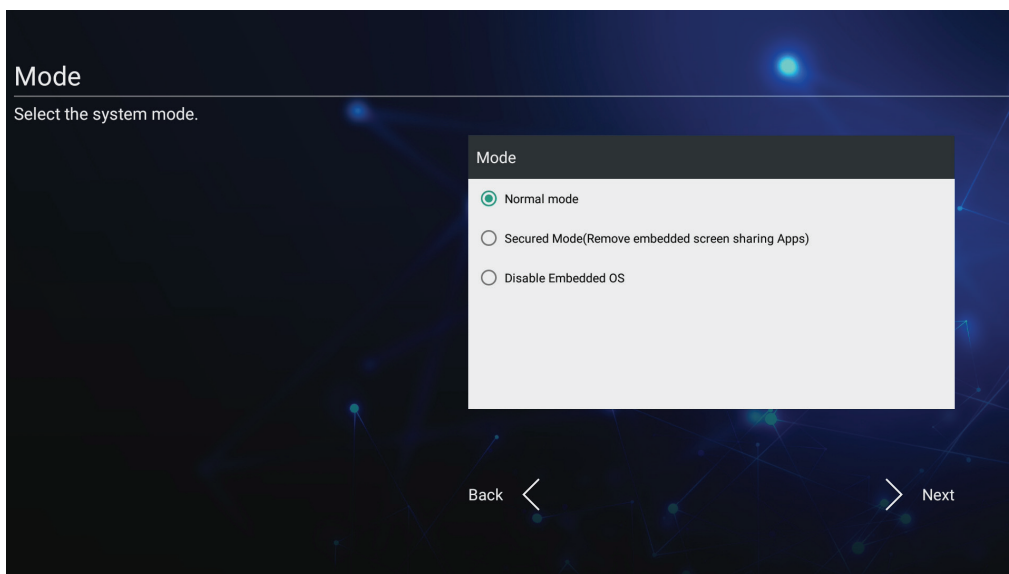



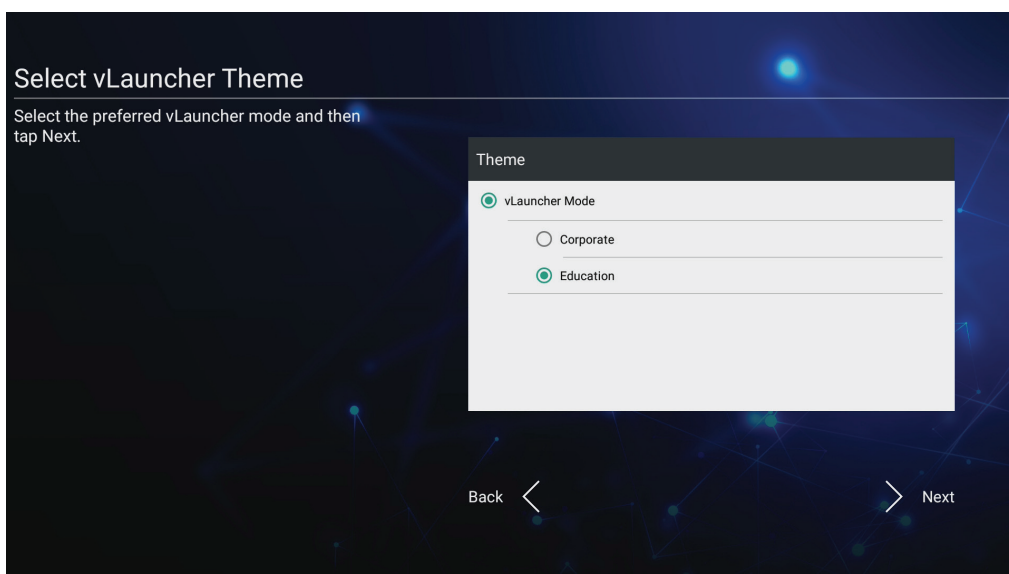



5. Select your preferred vLauncher mode:



vLauncher - Customizable Welcome Screen



Icon	Description
	Launches the myViewBoard annotation application
	Launch wireless screen sharing application, vCastReceiver
	Switch to slot-in PC source
	Open web browser
	Open cloud meeting
	Application list

NOTE: ViewBoard offers two background themes, Corporate and Education.

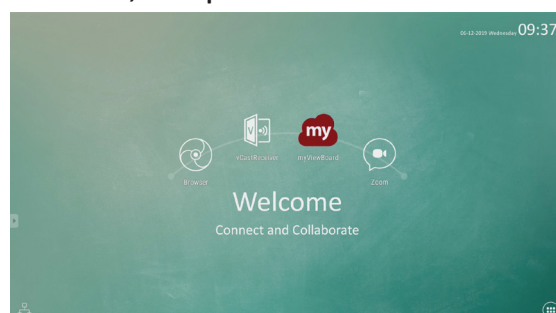
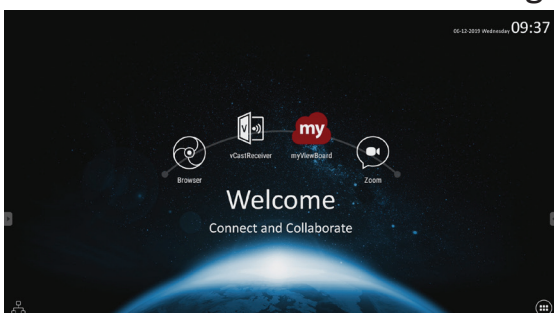

Tool Bar

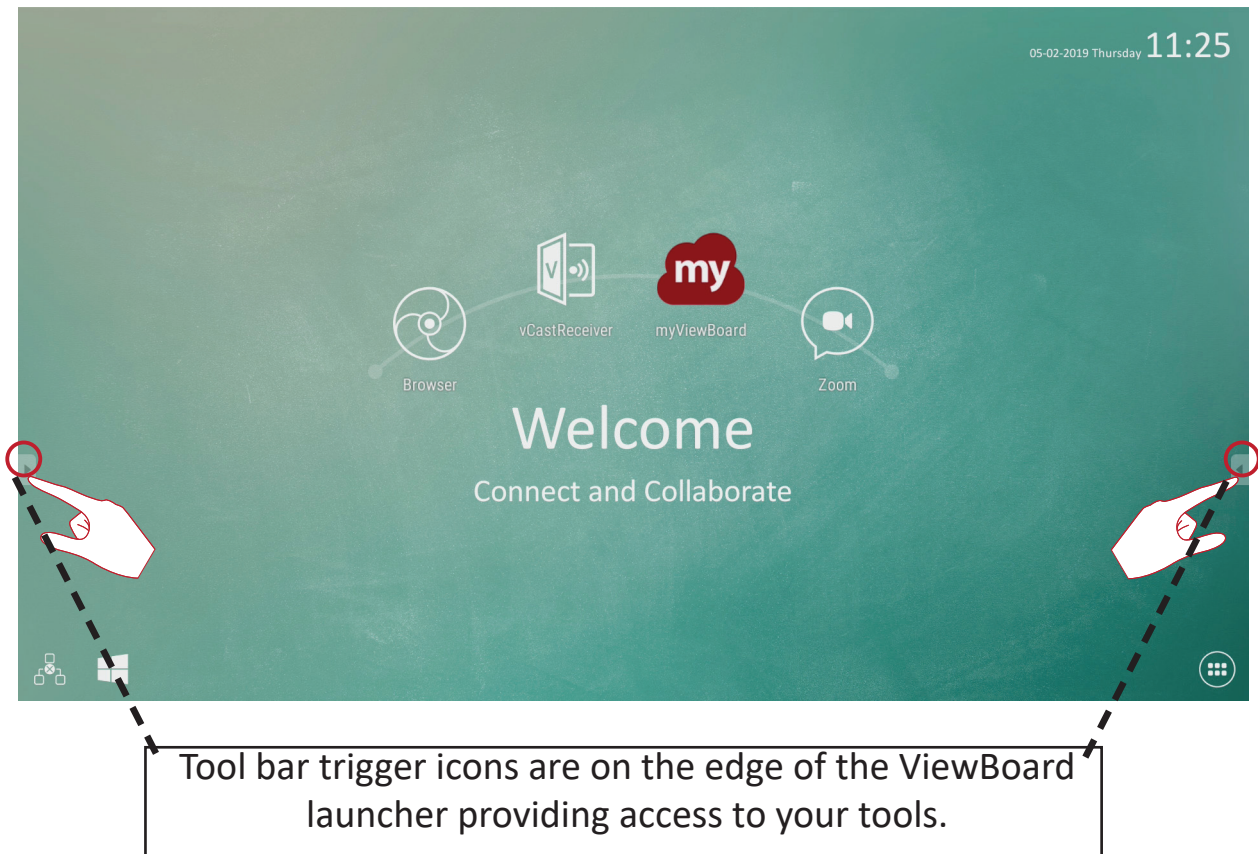





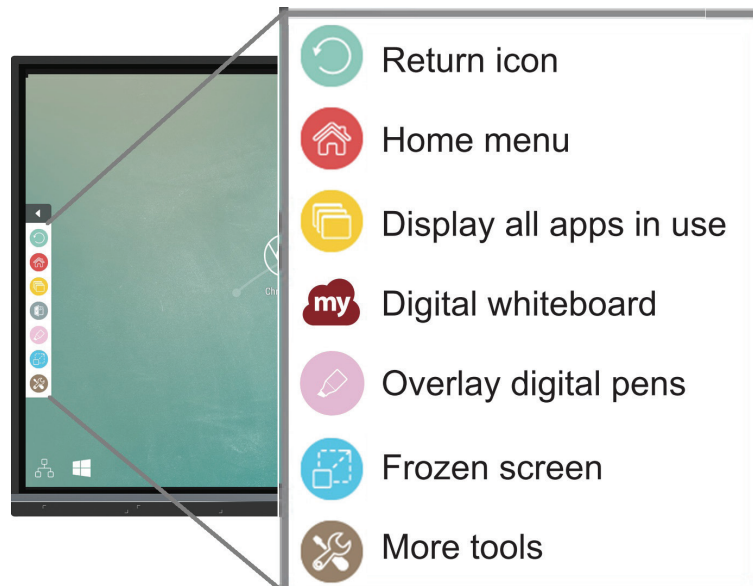

To launch a tool:









1. Tap a Tool bar trigger icon.
2. Tap on your desired tool icon.





NOTE: The default tool bar setting is to be available for all input sources; however, users can go to **Advanced Settings** to adjust the options: (1) available for all input sources, (2) available for all input sources, except for PC, and (3) disable the tool bar.

Icon	Description
	Return to the previous operation screen NOTE: Only for Embedded Player source
	Return to the home screen of the Embedded Player
	Display all embedded applications that are being used
	Launch the myViewBoard software

Icon	Description
	Access the pen, highlighter, clear, and save options 
	<p>1. <u>Digital Pen</u> Annotate the overlay of any input source with red, black, blue, or green ink. NOTE: The default digital pen setting supports up to 10-point writing.</p>
	<p>2. <u>Digital Highlighter</u> Mark and highlight with four colors: yellow, orange, blue, and green. NOTE: The default digital highlighter setting supports up to 10-point marking.</p>
	<p>3. <u>Brush</u> Clears all the digital ink on the screen.</p>
	<p>4. <u>Save As</u> Save the on-screen image onto the internal storage.</p>
	<p>5. <u>Writing Mode</u> Transparent mode: Screen won't be frozen, the screen resolution won't be reduced to 1080p.</p>
	<p>6. <u>Picture Save Setting</u> Speed priority: Save the on-screen image as 1920 x 1080; fast save speed. Quality priority: Save the on-screen image as 3840 x 2160; save time will take up to 10 seconds. NOTE: In opaque mode, the user cannot select the picture save setting.</p>
	<p>7. <u>Close</u> Close the digital pen icon.</p>

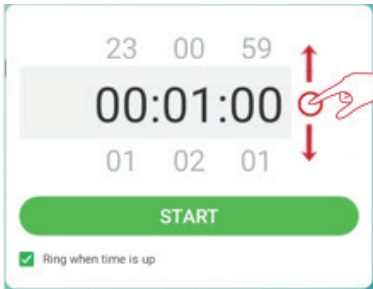
Icon	Description
	<p>Convert the currently displayed content into a still image; then you can zoom in or zoom out</p> <div style="text-align: center;">     </div> <p>① ② ③ ④</p> <p>NOTE: The ViewBoard will take a few seconds to reduce the screen resolution to 1080p.</p>
	<p>1. <u>Zoom In</u> Enlarge the captured image. NOTE: The screen resolution will be reduced after zooming in.</p>
	<p>2. <u>Zoom Out</u> Shrink the captured image.</p>
	<p>3. <u>Back to Full Screen</u> Reset the Zoom In/Zoom Out effects to the original full screen.</p>
	<p>4. <u>Close</u> Close the icon.</p>
	<p>View more applications within the ViewBoard tool bar</p> <div style="text-align: center;">  </div> <p>① ② ③ ④ ⑤</p>
	<p>1. <u>Spotlight</u> Highlight the focus content zone. Tap the Setting icon to adjust the spotlight size and alpha blending effect.</p> <div style="text-align: center;">  </div>

Icon	Description
	<p data-bbox="339 197 555 232">2. Countdown</p> <p data-bbox="368 250 1374 336">Access the countdown timer with an optional alarm setting. Touch and swipe to adjust the numeric values, then click Start.</p> <div data-bbox="679 349 1053 636" style="border: 1px solid #ccc; padding: 10px; margin: 10px auto; width: fit-content;">  </div> <p data-bbox="368 658 1315 741">At any time, the countdown timer can be paused, resumed, or reset.</p> <div data-bbox="475 757 1267 976" style="display: flex; justify-content: space-around; align-items: center; margin: 10px auto;"> <div style="border: 1px solid #ccc; padding: 10px; text-align: center;"> <p data-bbox="509 801 826 880" style="font-size: 2em;">00:00:45</p> <div data-bbox="491 920 844 965" style="display: flex; justify-content: space-around;"> PAUSE RESET </div> </div> <div style="border: 1px solid #ccc; padding: 10px; text-align: center;"> <p data-bbox="922 801 1235 880" style="font-size: 2em;">00:00:30</p> <div data-bbox="900 920 1252 965" style="display: flex; justify-content: space-around;"> RESUME RESET </div> </div> </div> <p data-bbox="368 999 1406 1126">The timer will reduce in size and move to the lower-center of the screen automatically when the user touches another area. Touching the timer again will return it to its normal size and original location.</p> <div data-bbox="756 1144 987 1223" style="border: 1px solid #ccc; padding: 5px; text-align: center; margin: 10px auto; width: fit-content;"> <p data-bbox="772 1155 971 1211" style="font-size: 1.5em;">00:00:18</p> </div>

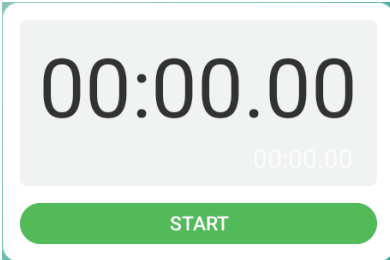
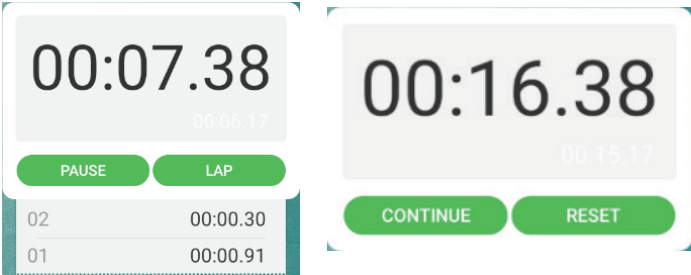
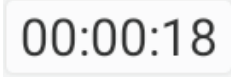
Icon	Description				
	<p>3. <u>Stopwatch</u> Tapping Start will initiate the stopwatch.</p>  <p>At any time, the stopwatch can be paused, resumed, split, or reset.</p>  <table border="1" data-bbox="528 837 823 909"> <tbody> <tr> <td>02</td> <td>00:00.30</td> </tr> <tr> <td>01</td> <td>00:00.91</td> </tr> </tbody> </table> <p>The stopwatch will reduce in size and move to the lower-center of the screen automatically when the user touches another area. Touching the stopwatch again will return it to its normal size and original location.</p> 	02	00:00.30	01	00:00.91
	02	00:00.30			
	01	00:00.91			
<p>4. <u>Air Class</u> Interactive teaching tool for classroom usage. For more information, see page 81.</p>					
<p>5. <u>Folder</u> Access the Folder function and retrieve documents. For more information, see page 91.</p>					

ViewBoard On-Screen Display (OSD) Menu

ViewBoard has two options for opening the OSD Menu:

Option 1

Swipe up from the bottom of the screen.

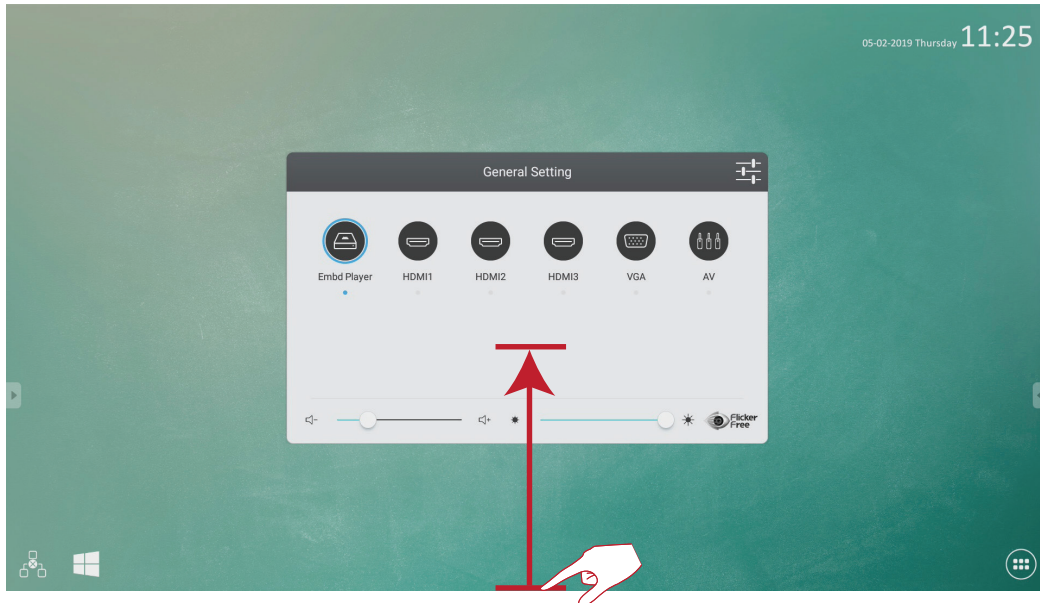

Option 2

Press the **Setting** button on the control panel.

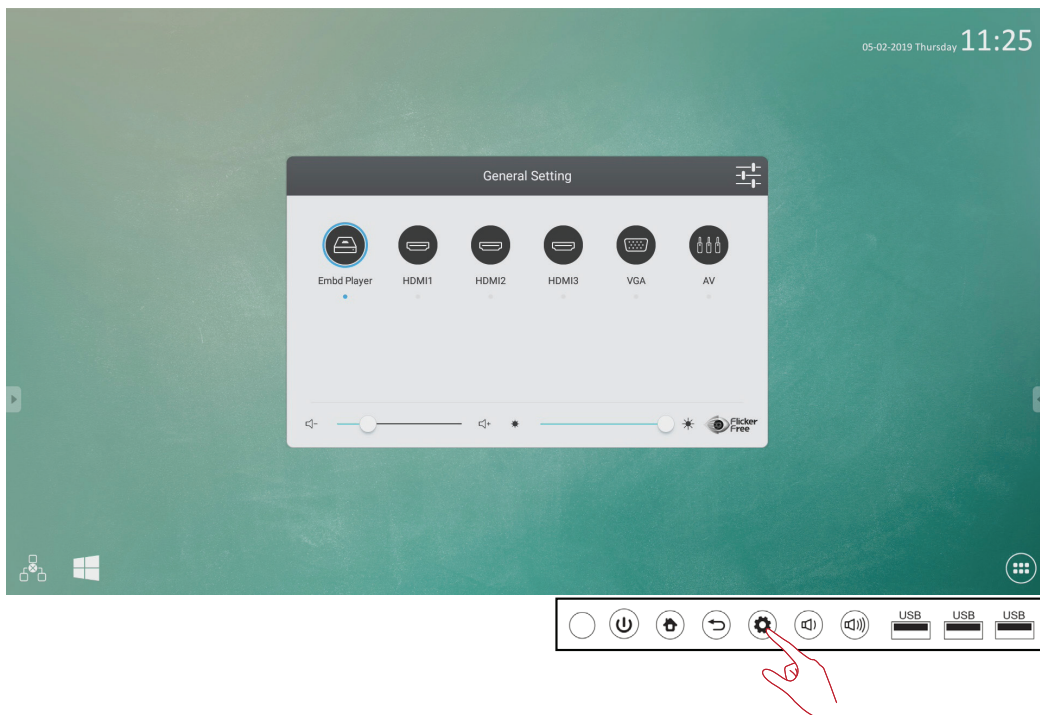

General Settings

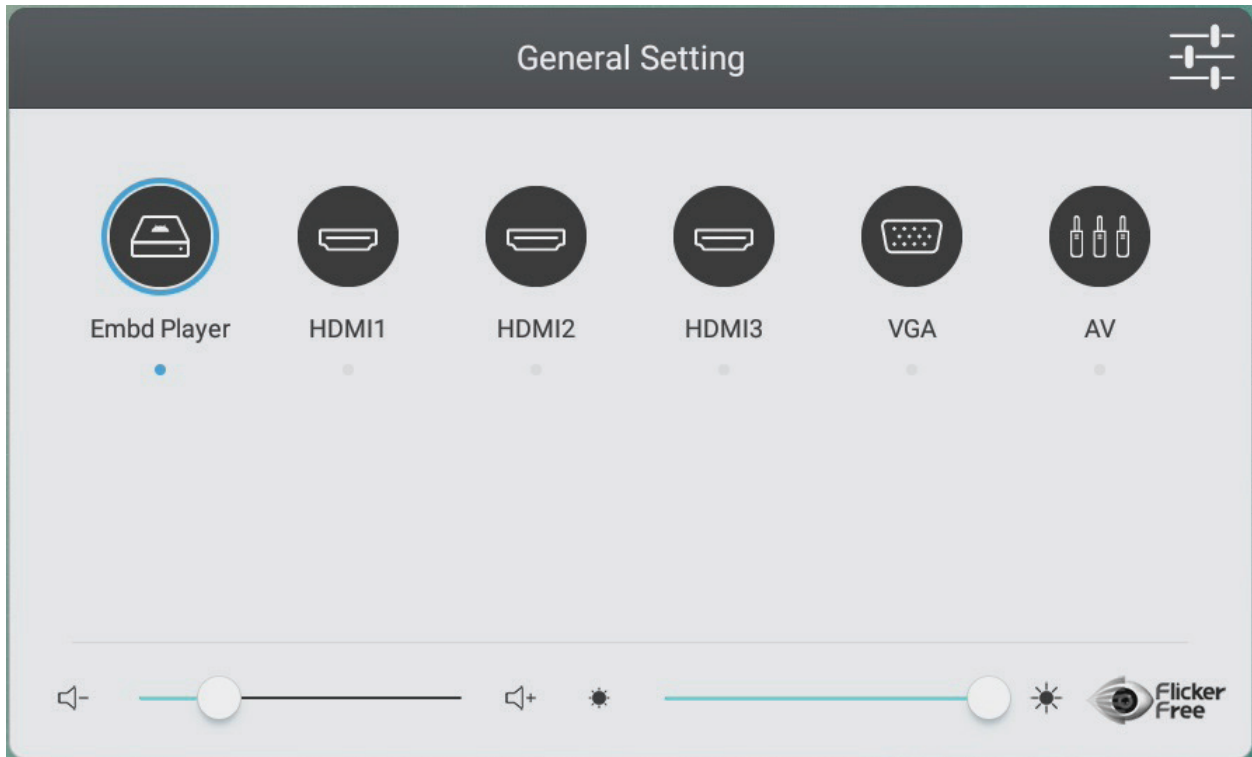

To select an Input Source:

1. Press **INPUT** on the remote control to display the **General Setting** menu, then press **DOWN** to enter the **Input Source** menu.
2. Press **DOWN/UP/LEFT/RIGHT** to select the input source you want.
3. Press **ENTER** on the remote control, or touch the input source.
4. Press **EXIT** on the remote control, or touch a blank area outside of the menu to exit.

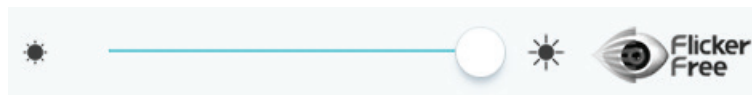

To adjust the Backlight and enable/disable Flicker Free:

1. Press **INPUT** on the remote control to display the **General Setting** menu.
2. Drag the brightness slider directly to adjust the backlight value, and/or touch the Flicker Free icon to enable/disable the function.
3. Press **EXIT** on the remote control, or touch a blank area outside of the menu to exit.



To adjust the Volume:

1. Press **INPUT** on the remote control to display the **General Setting** menu.
2. Drag the volume slider directly to adjust the value.
3. Press **MUTE** on the remote control to enable or disable the mute function.
4. Press **EXIT** on the remote control, or touch a blank area outside of the menu to exit.

Audio Settings

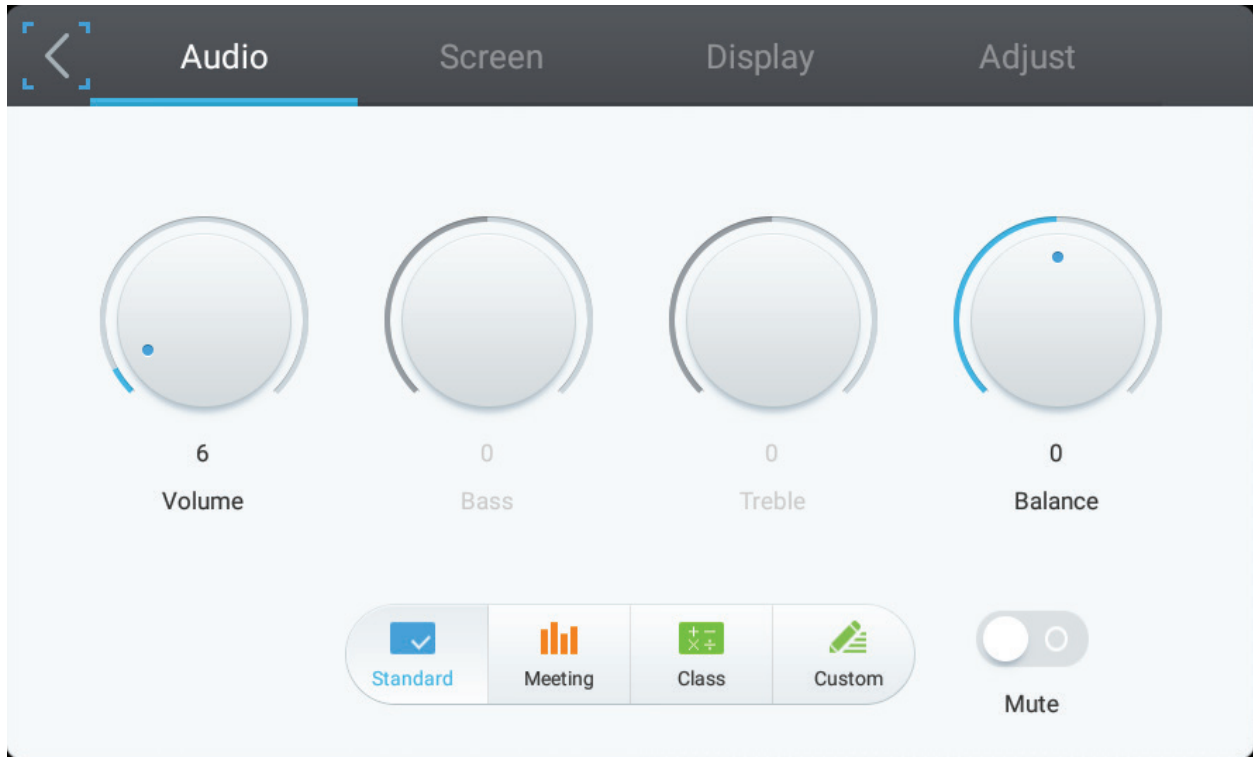

1. Press **MENU** on the remote control and select the **Audio** menu.
2. Adjust the Volume, Bass, Treble, and Balance directly by touching and adjusting each value. Additionally, you can use the remote control and press **DOWN/UP/LEFT/RIGHT** to select a value, then press **VOL+/VOL-** to adjust it.
3. To adjust the audio efficacy choose from: **Standard, Meeting, Class, and Custom.**
4. Touch the Mute slider directly to enable/disable mute.

Screen Settings

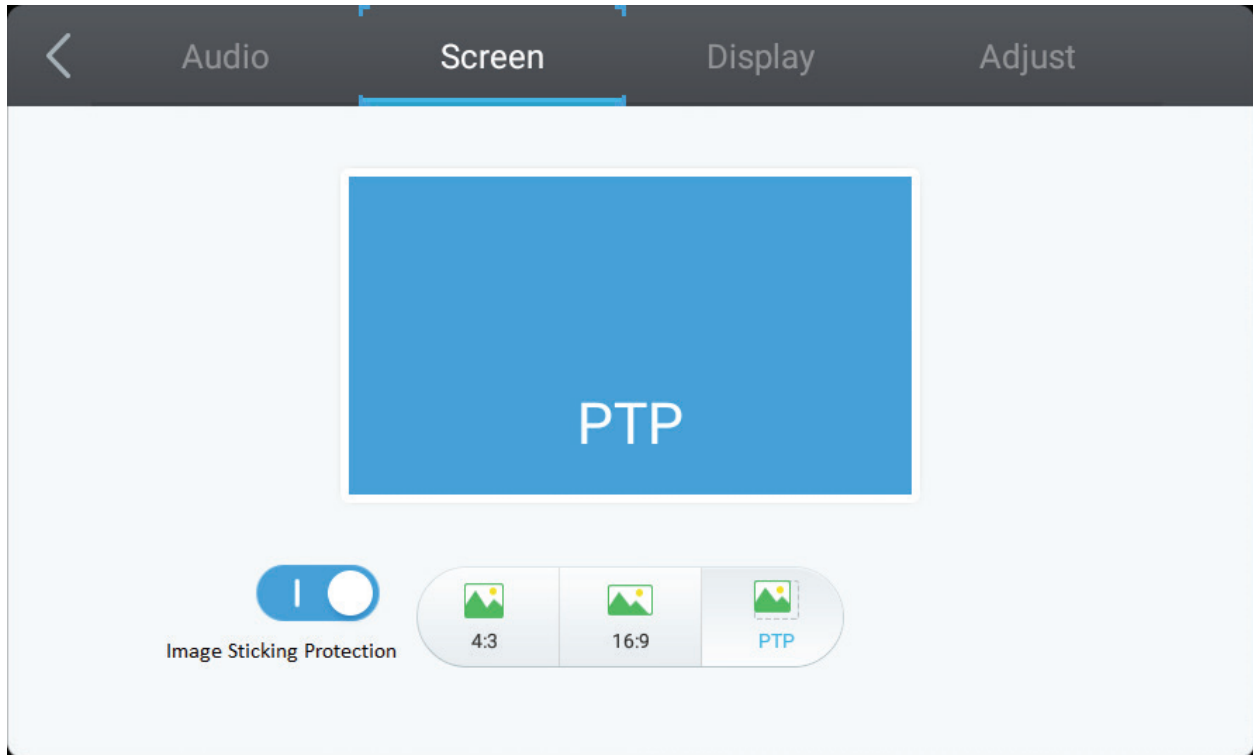

1. Press **MENU** on the remote control and select the **Screen** menu.

2. Image Sticking Protection

To reduce the possibility of screen burn-in, this unit is equipped with image sticking protection technology.

If the screen displays a still image for a certain period of time you define, the device activates a screen saver to prevent the formation of burnt in ghost images on the screen.

Image sticking protection moves the picture slightly on the screen. The image sticking protection time setting allows you to program the time between movements of the picture in minutes.

3. To change the screen ratio, directly select **4:3**, **16:9**, or **PTP**.

Display Settings



1. Press **MENU** on the remote control and select the **Display** menu.
2. Adjust the Brightness, Contrast, Hue, and Sharpness directly by touching and adjusting each value. Additionally, you can use the remote control and press **DOWN/UP/LEFT/RIGHT** to select a value, then press **VOL+/VOL-** to adjust it.
3. To adjust the display efficacy choose from: **Standard**, **Bright**, **Soft**, and **Custom**.
4. Touch the **Standard**, **Cold**, or **Warm** icon to adjust the color temperature.
5. Drag the blue light slider directly to adjust the blue light value.



Adjust Settings

NOTE: Only available when the input source is VGA.

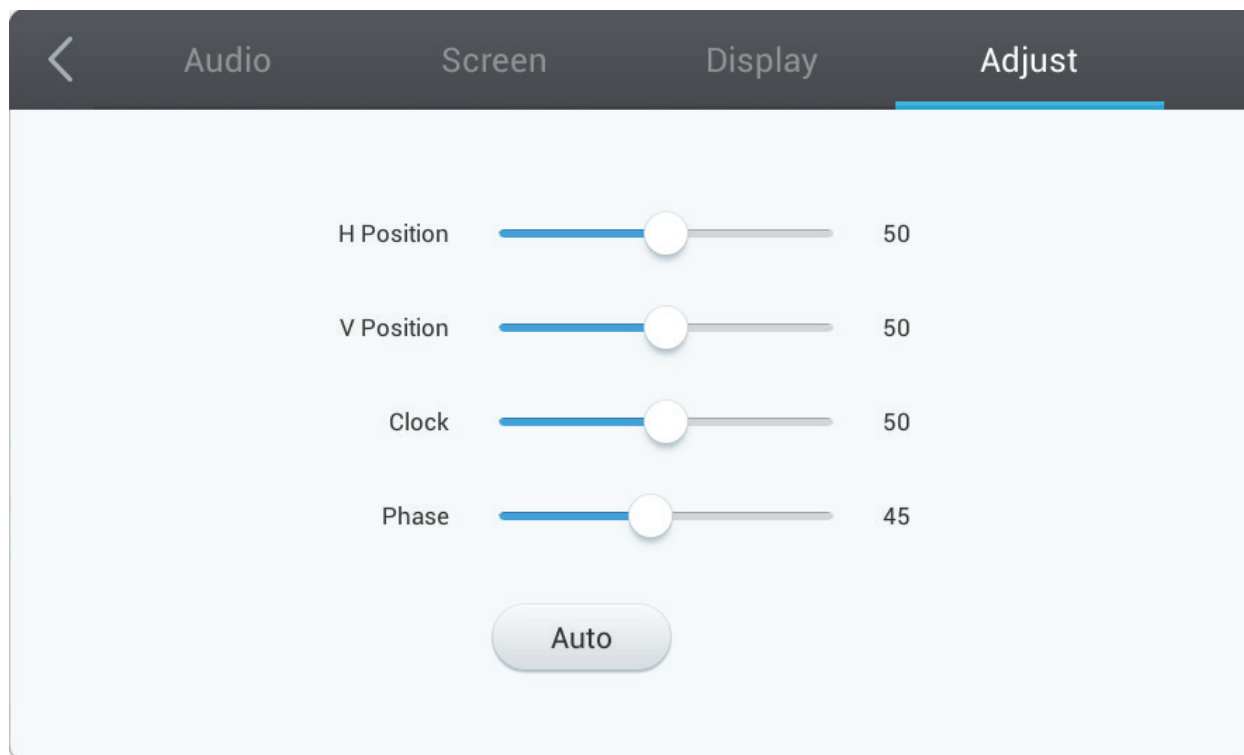

1. Press **MENU** on the remote control and select the **Adjust** menu.
2. Adjust the H. Position, V. Position, Clock, and Phase directly by touching and adjusting each value.
3. To automatically adjust, touch the **Auto** icon.

Advanced Settings

When the ViewBoard is in Embd Player source, tap the Advanced Settings icon in the On-Screen Display (OSD) Menu to enter the Advanced Settings Menu.

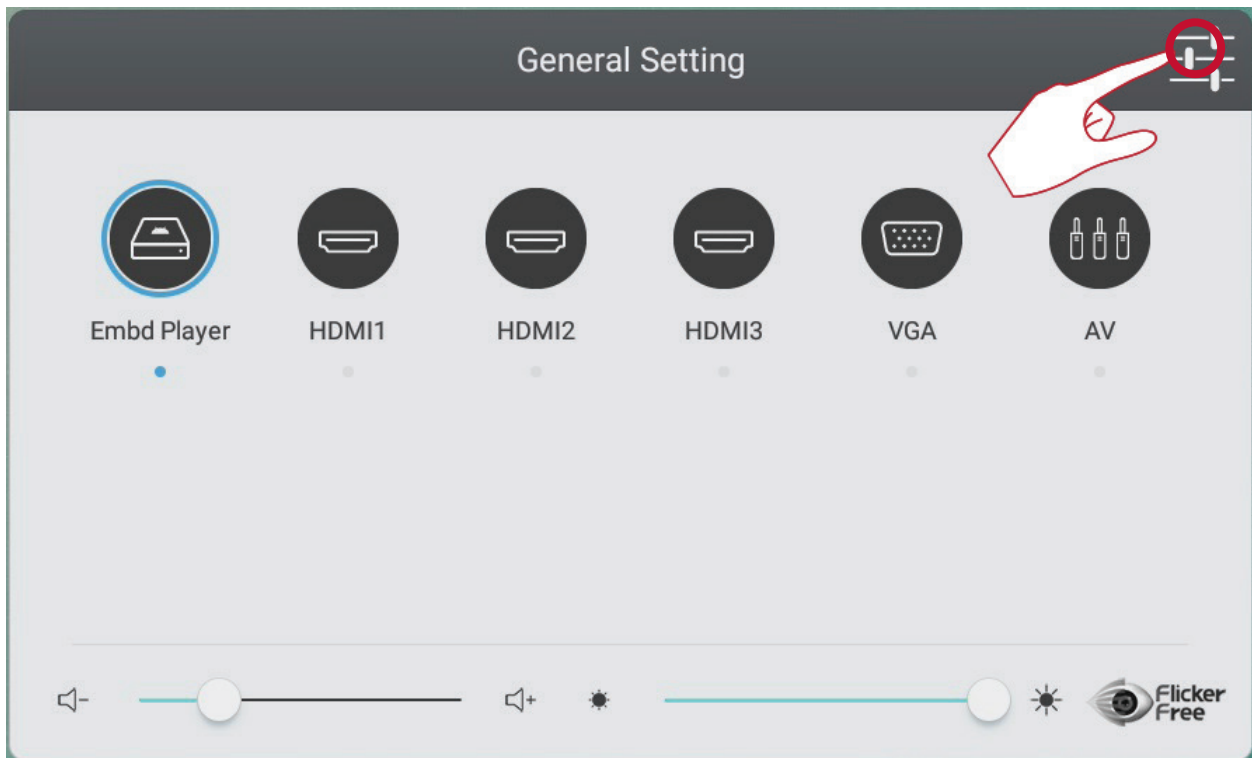

Wireless & Networks

Check current network connection status, Wi-Fi, BT, and establish a Wireless hotspot.

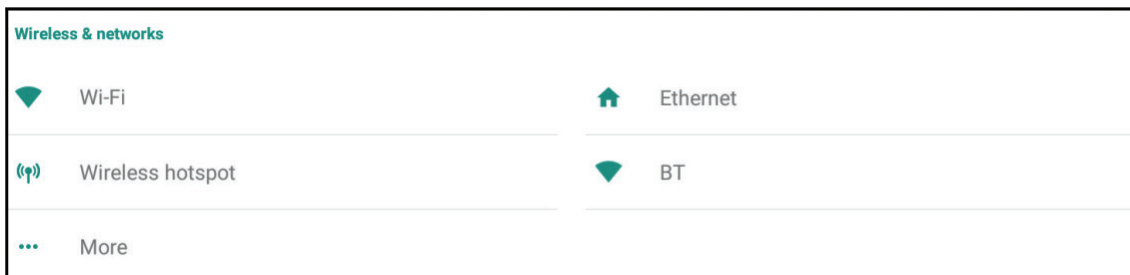

NOTE:

- Wi-Fi, Wireless hotspot and BT settings will appear when LB-WIFI-001(optional) has been installed.
- Ethernet will disable automatically when Wi-Fi is enabled. Wi-Fi will disable automatically when Ethernet is enabled. Wi-Fi will disable when Wireless hotspot is enabled.
- The device cannot connect to the Internet when Wireless hotspot is enabled.

Wi-Fi

Tap the **On** toggle to toggle Wi-Fi on or off.

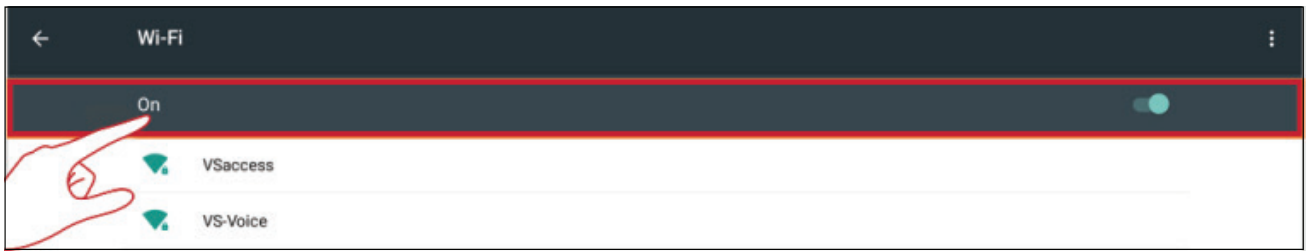

Tap the more settings icon to: Add Network, view Saved Networks, Refresh the network list, or view Advanced settings.

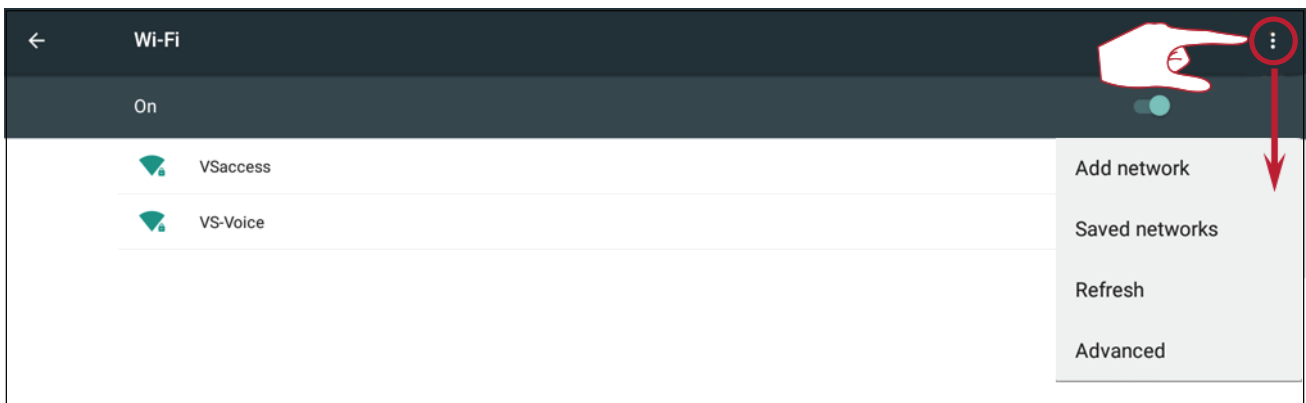

In Advanced settings, you can set Proxy and IP settings.

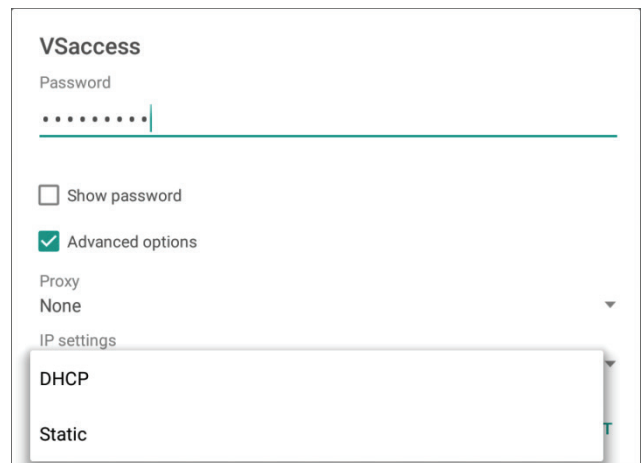
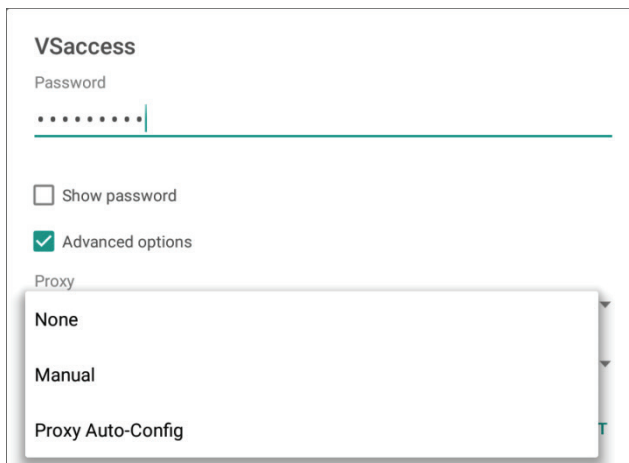

Ethernet

Tap the **On** toggle to toggle Ethernet on or off.

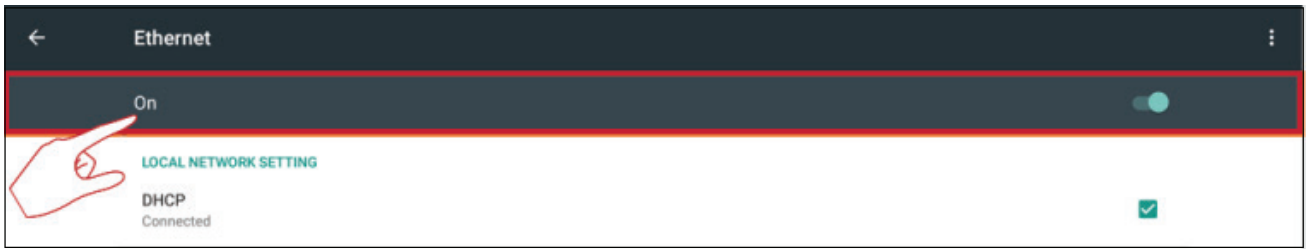

Tap the more settings icon to view Advanced settings.

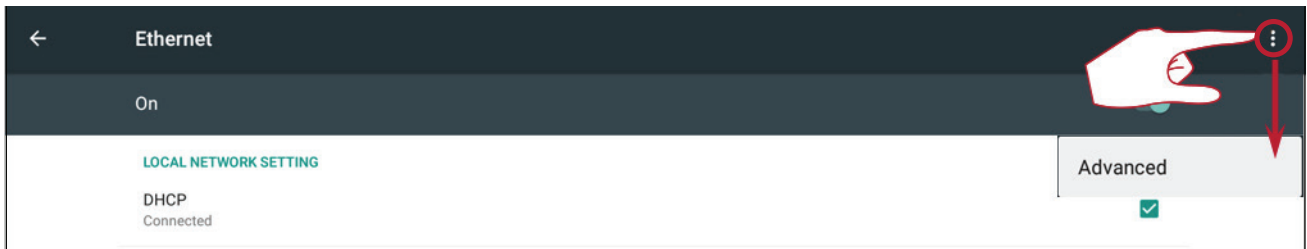

In Advanced settings, you can adjust Static IP and Proxy settings.

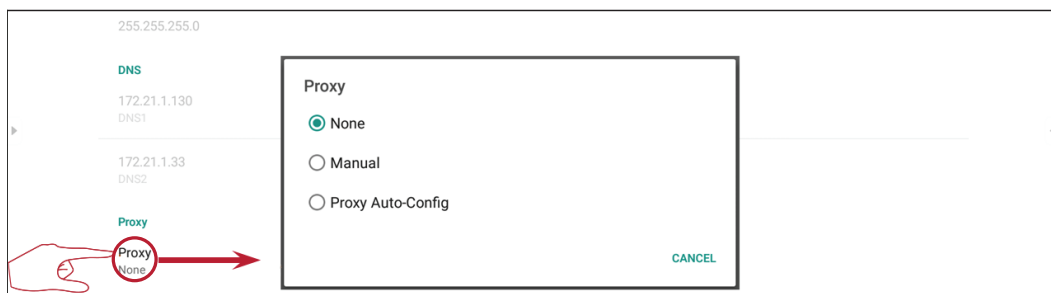
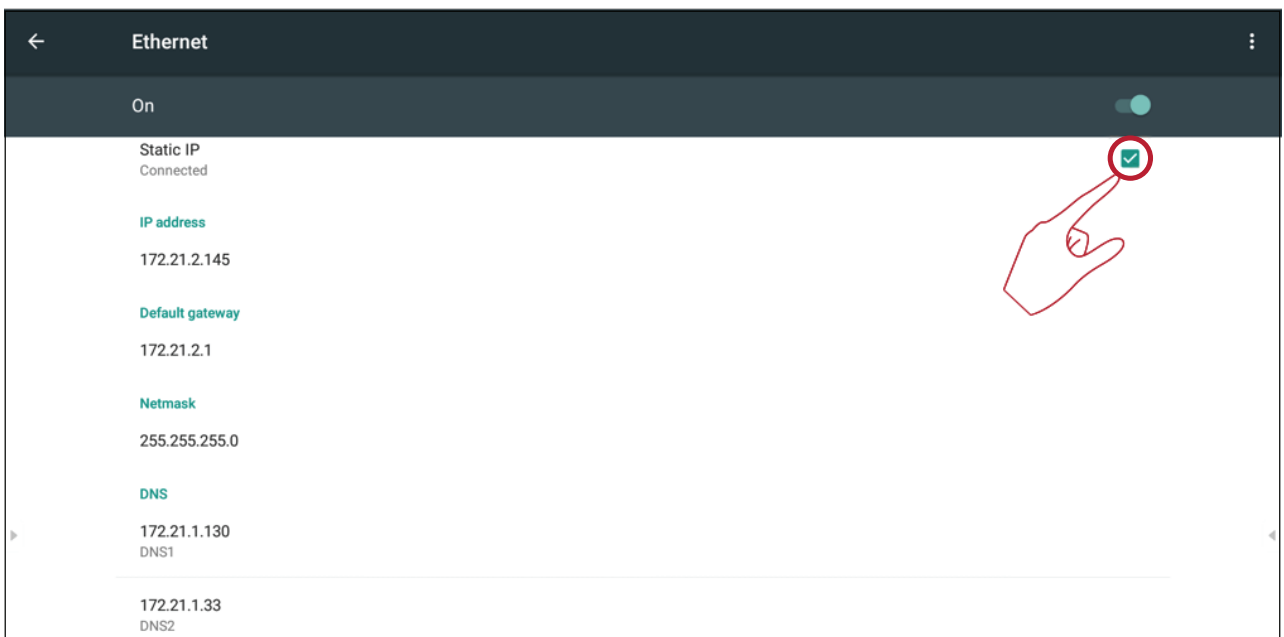

Wireless Hotspot

Tap the Portable Wi-Fi hotspot toggle to turn it on or off.

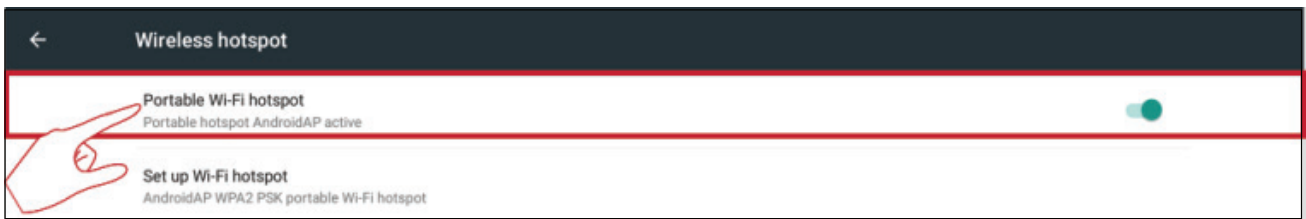

Tap "Set up Wi-Fi hotspot" to set Network name, Security, and Password.

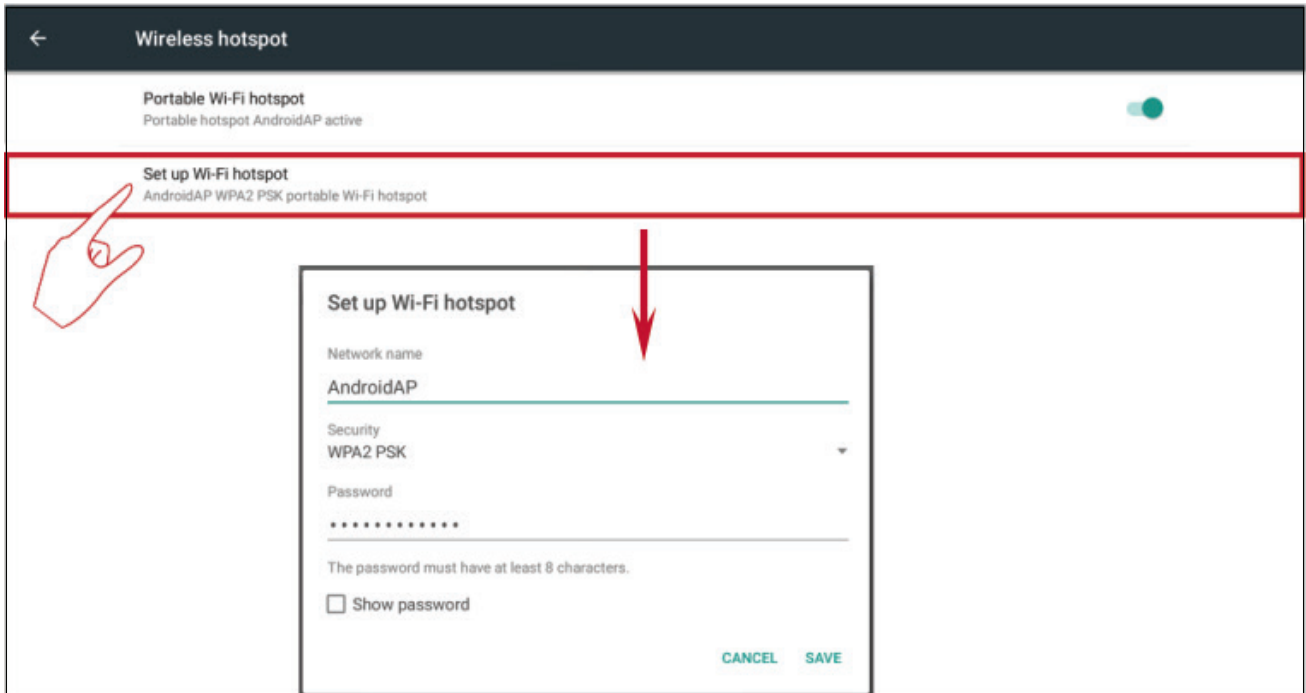

BT

Tap the **On** toggle to toggle BT on or off.

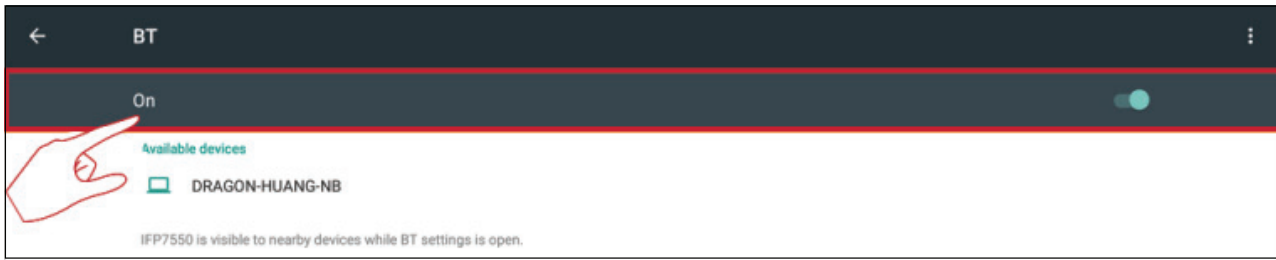

Select a listed device to pair and connect.

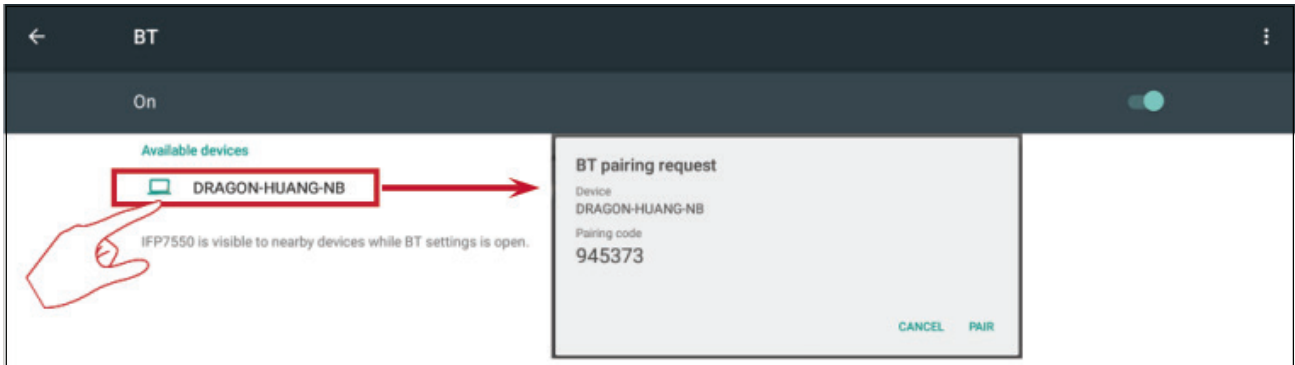

Tap the more settings icon to: Refresh, Rename the device, and Show received files.

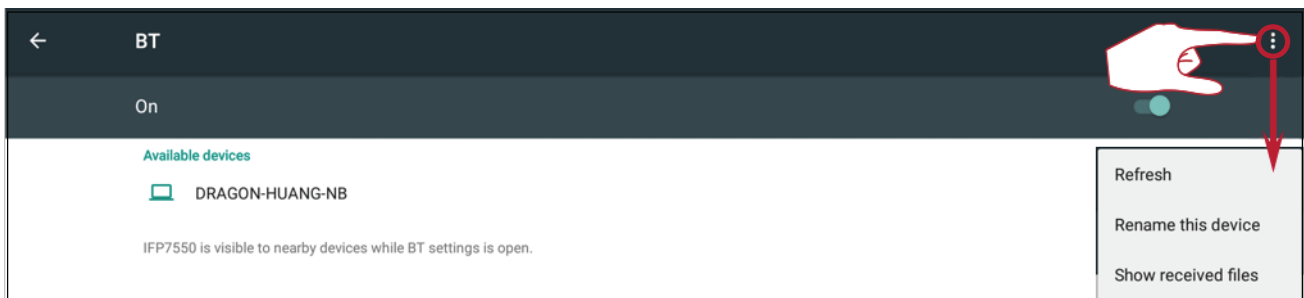

VPN

To create a VPN profile:

1. Tap the “+” icon.

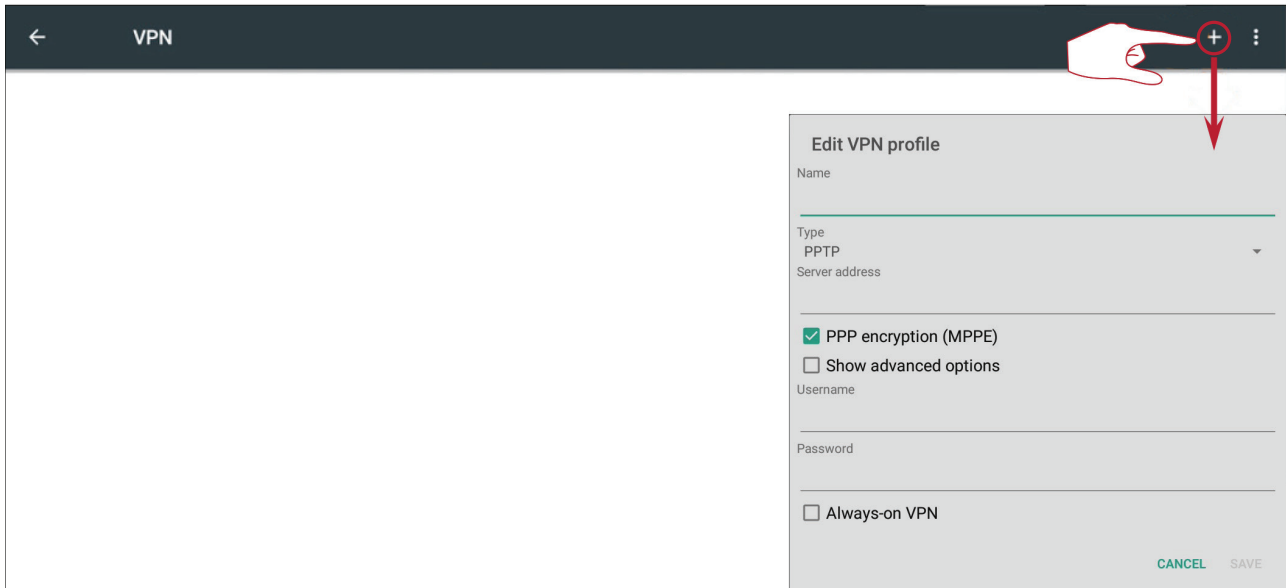

2. Key in the desired name.

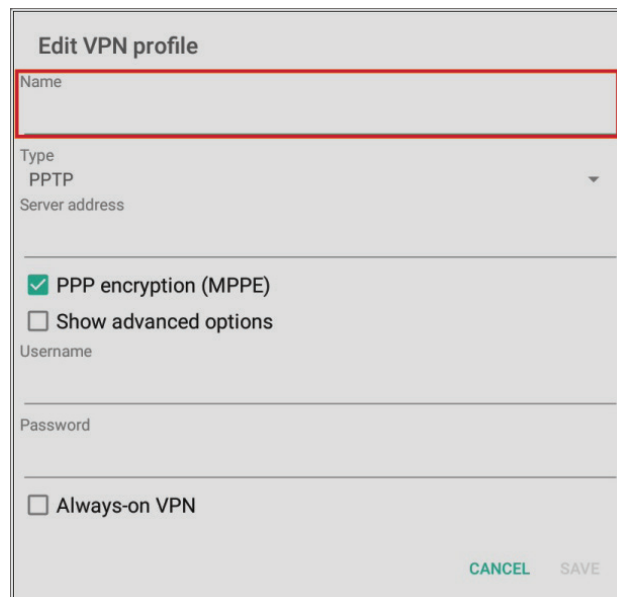

3. Select the VPN Type.

The screenshot shows the 'Edit VPN profile' form. The 'Type' dropdown menu is open, displaying a list of VPN protocols: PPTP, L2TP/IPSec PSK, L2TP/IPSec RSA, IPSec Xauth PSK, IPSec Xauth RSA, and IPSec Hybrid RSA. A red hand icon points to the dropdown menu. The form also includes fields for Name, Server address, Username, Password, and an 'Always-on VPN' checkbox. The 'PPP encryption (MPPE)' checkbox is checked, and the 'Show advanced options' checkbox is unchecked. 'CANCEL' and 'SAVE' buttons are at the bottom right.

4. Choose to enable/disable PPP encryption and show advanced options.

This screenshot shows the 'Edit VPN profile' form with the 'PPP encryption (MPPE)' and 'Show advanced options' checkboxes highlighted by a red box. The 'Type' dropdown is set to 'PPTP'. The form includes fields for Name, Server address, Username, Password, and an 'Always-on VPN' checkbox. 'CANCEL' and 'SAVE' buttons are at the bottom right.

Share

The SAMBA Service provides file sharing via LAN. When the SAMBA Service is enabled, the user can explore the ViewBoard file system with a PC or mobile equipment.



1. Tap the box to enable the SAMBA Service, then set a password if needed.

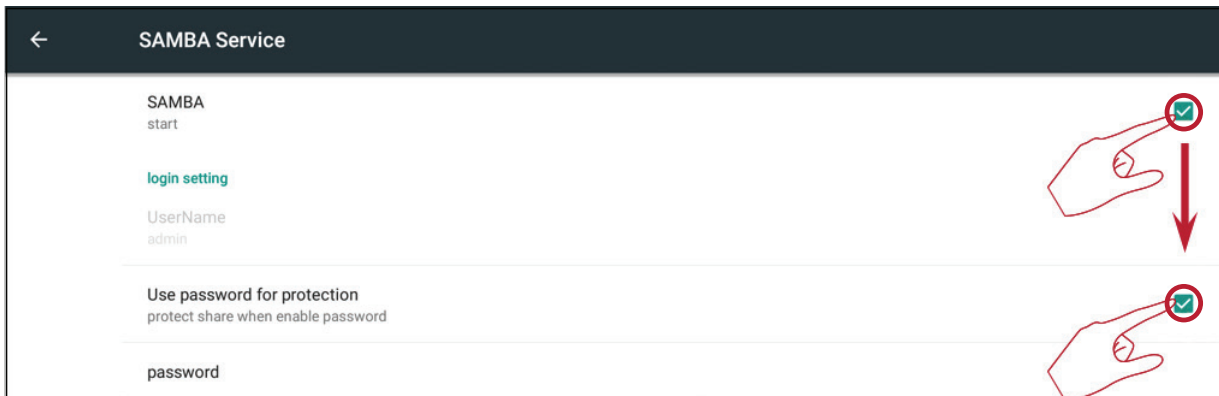

2. Connect the ViewBoard and client equipment to the same network.

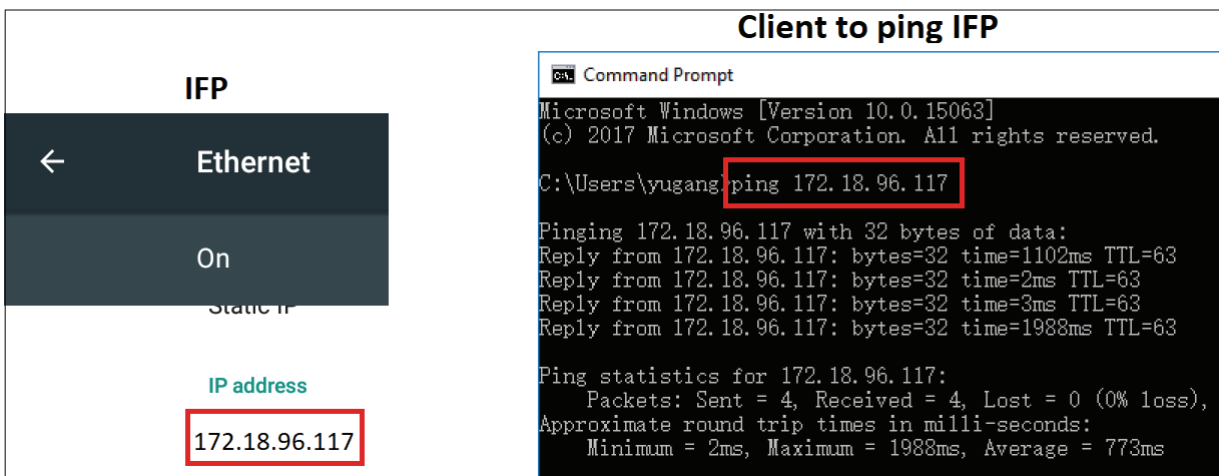

3. Log in to the ViewBoard with the client equipment. Input the ViewBoard's/IFP's IP address.

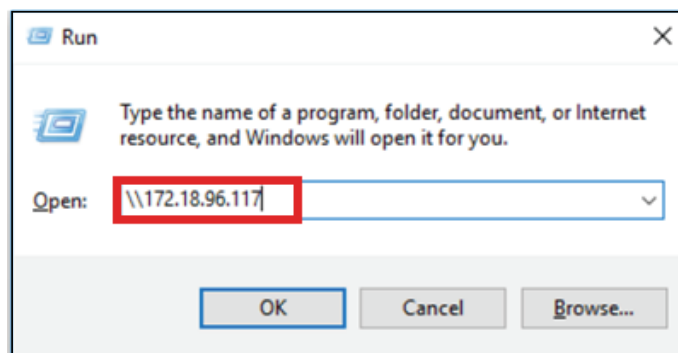

4. Key in the user name and password, then select **OK**.



5. After a successful log in, the ViewBoard files will be available.

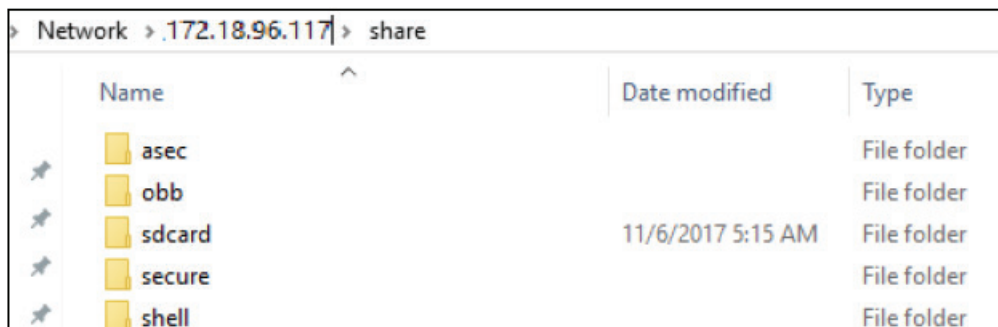

Device

Adjust the Theme, Display, Storage, and Sound settings.

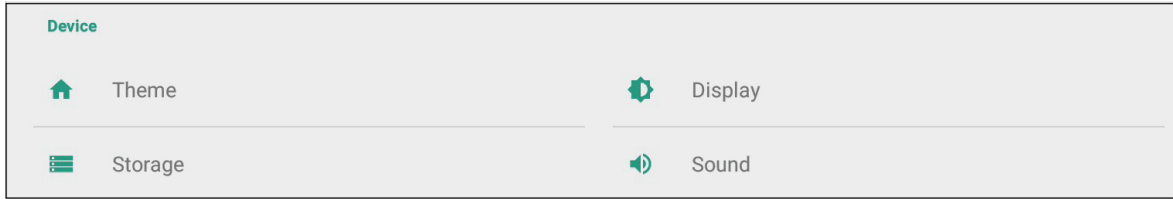

Theme

Users can change their home launcher theme.

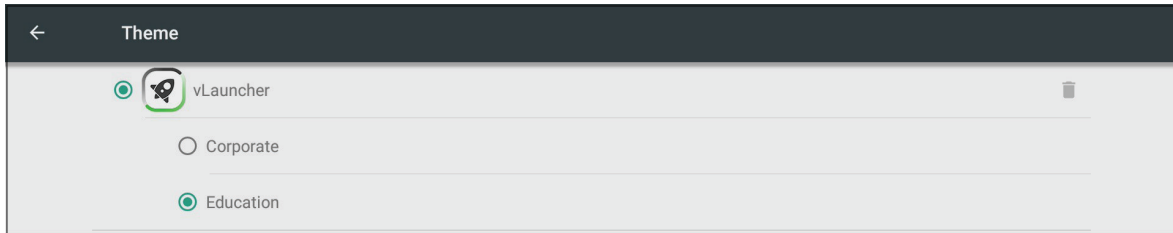

NOTE: vLauncher cannot be removed.

Display

Adjust the Wallpaper, HDMI Out Encryption setting, and Burn-in Protection Interval.

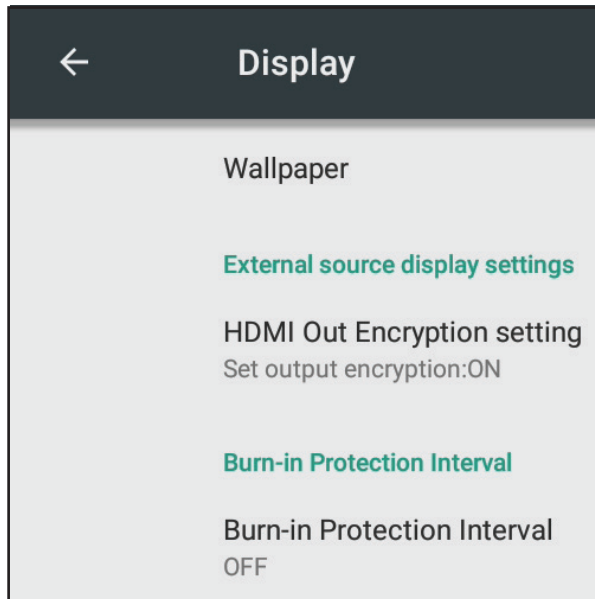

Wallpaper

Users can change their wallpaper with default images, or

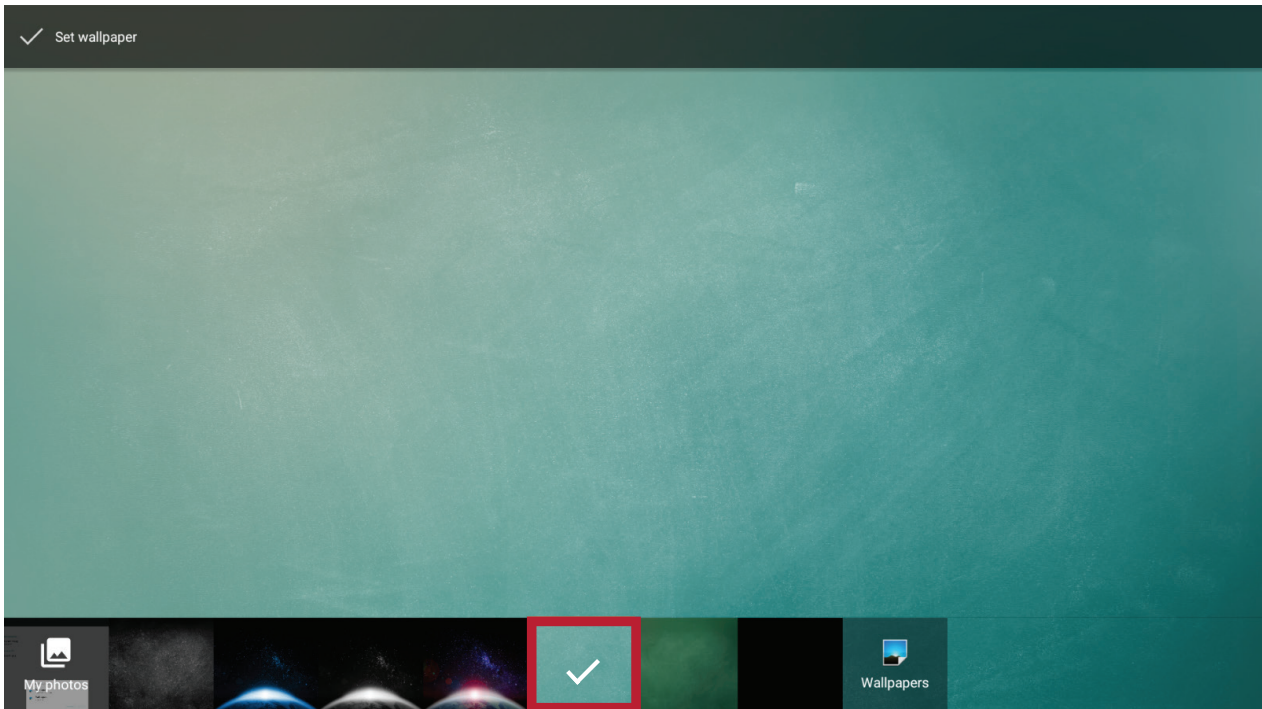

can use their own by tapping **My photos** and selecting the image file.

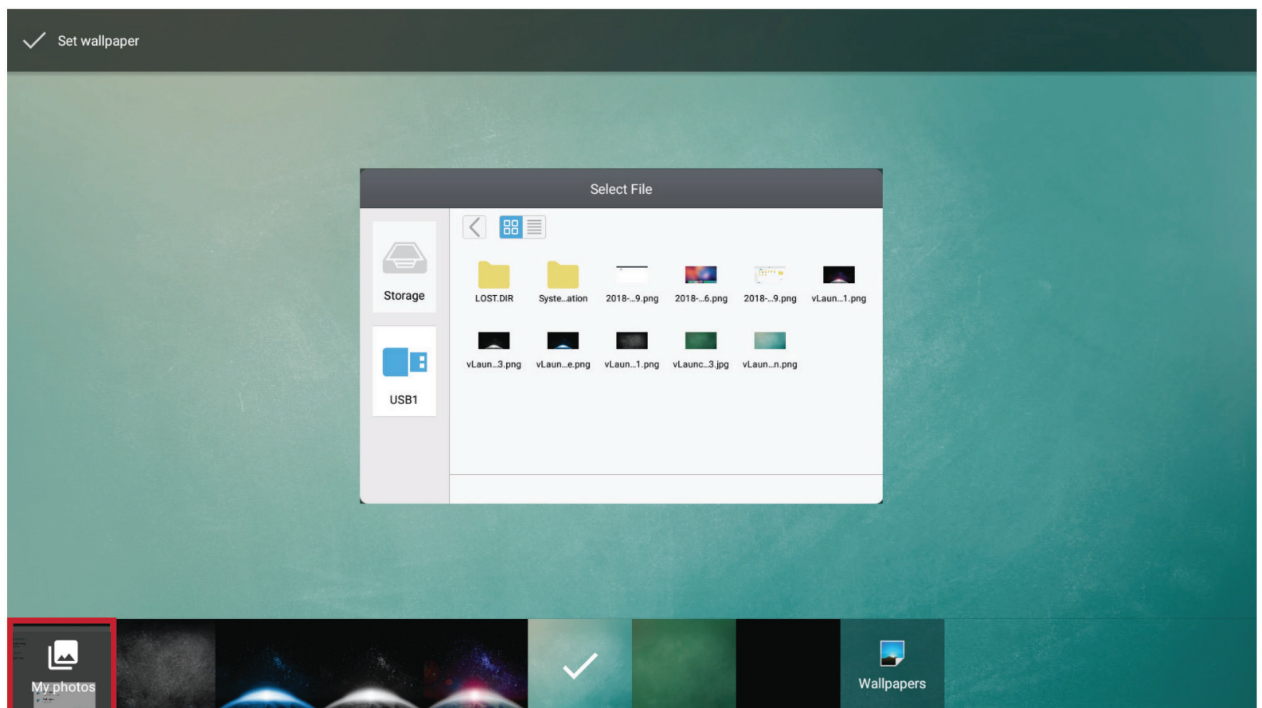

HDMI Out Encryption Setting

Users can turn on or off the encryption function.

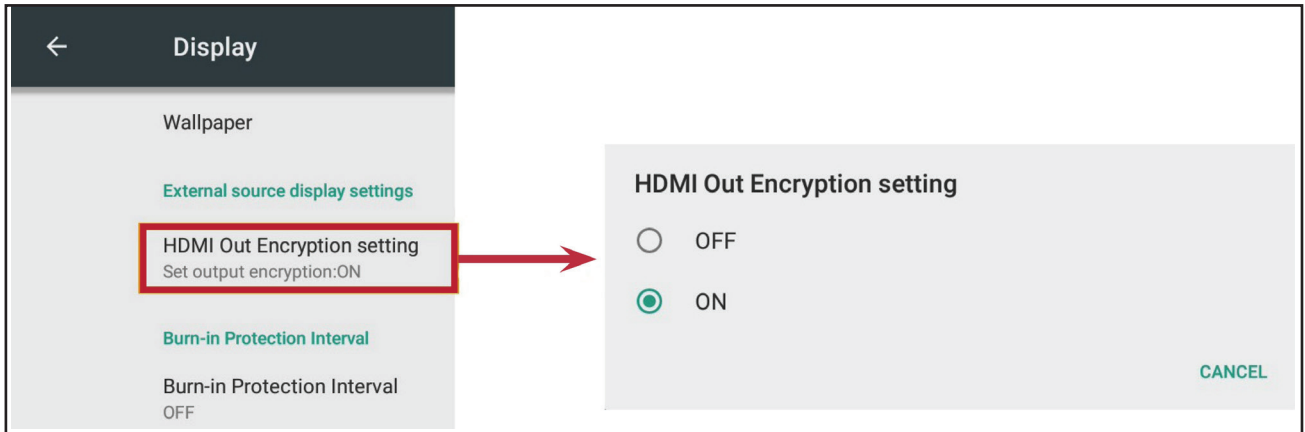

Burn-in Protection Interval

This setting allows the user to program the time between movements of the picture in minutes.

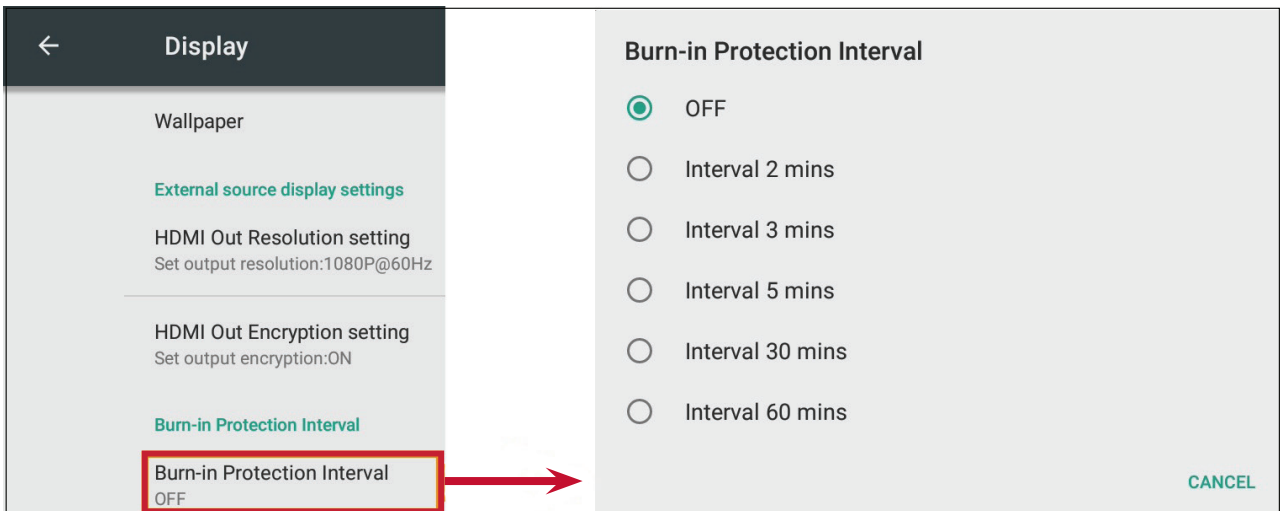

NOTE: Burn-in Protection must be enabled in the OSD Menu first.

Storage

Users can check the storage status of their ViewBoard.

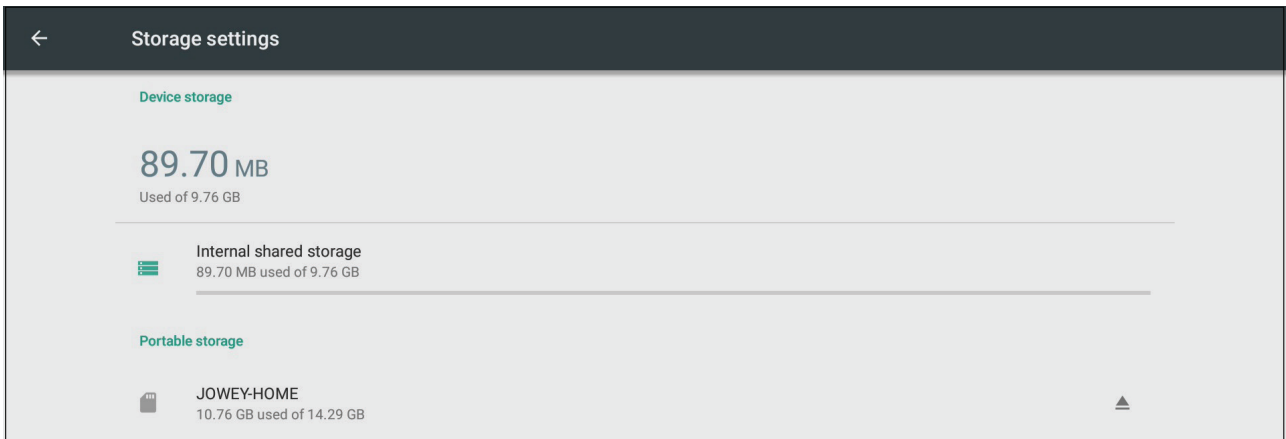

Sound

Users can enable or disable touch sounds.

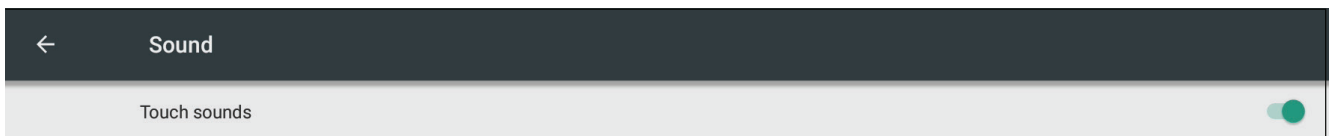

Personal

View and adjust Security, Startup & Shutdown, Language & Input, Password for screen lock, Input, and Other Settings.

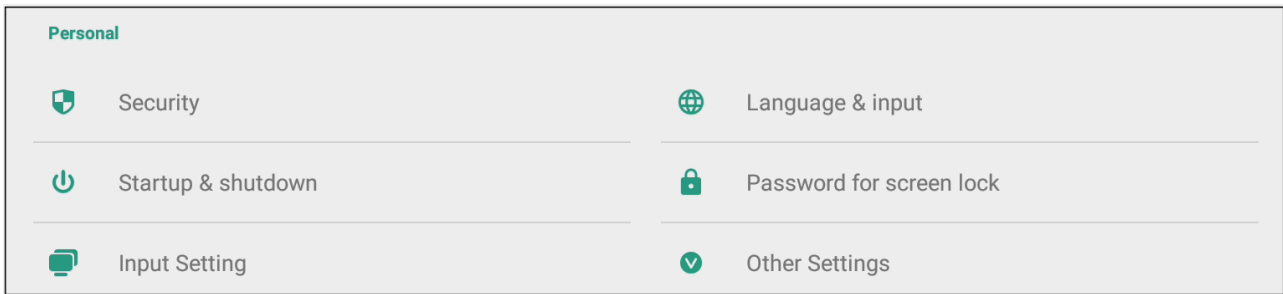

Security

Review Credential storage and Unknown sources Install settings.

Trusted Credentials

Show all trusted AC credentials that have been installed on the ViewBoard.

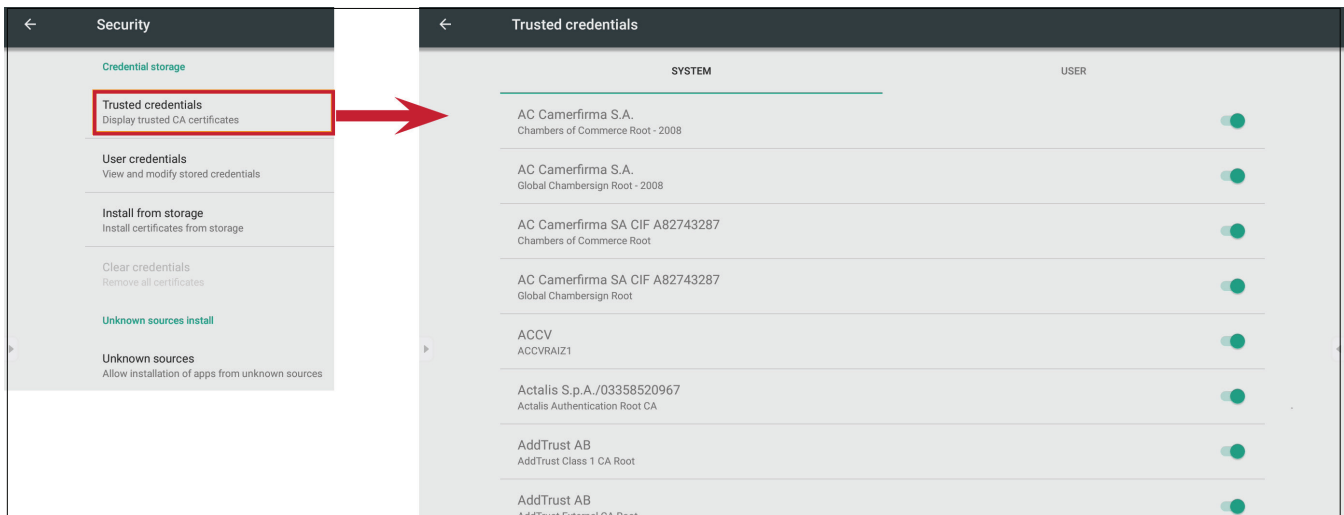

Clear Credentials

Clear any previously installed credentials.

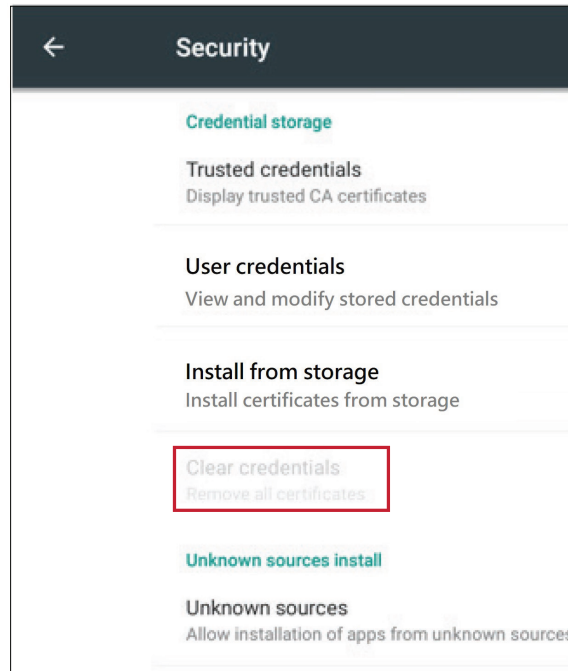

NOTE: Pre-loaded credentials cannot be cleared.

Unknown Sources

Enable the installation of apps from unknown sources.

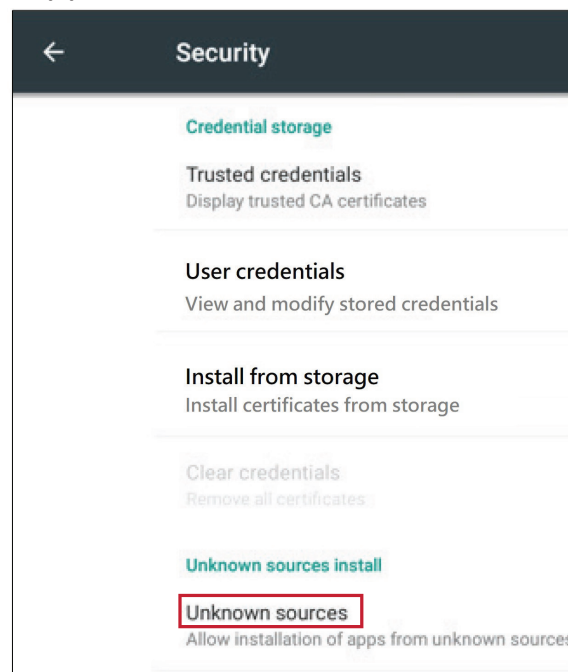

NOTE: Apps from unknown sources may not be compatible.

Language & Input

Adjust the Language and Input method of the Embedded Player.

Language

Choose from the available languages.

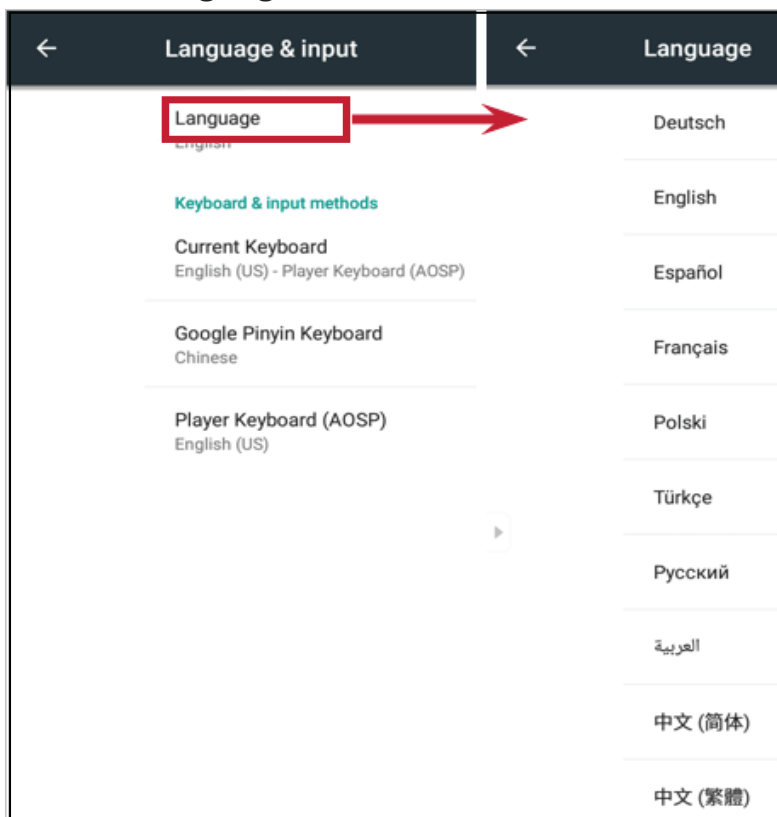

Current Keyboard

Enable/disable the visual keyboard or change the default input method.

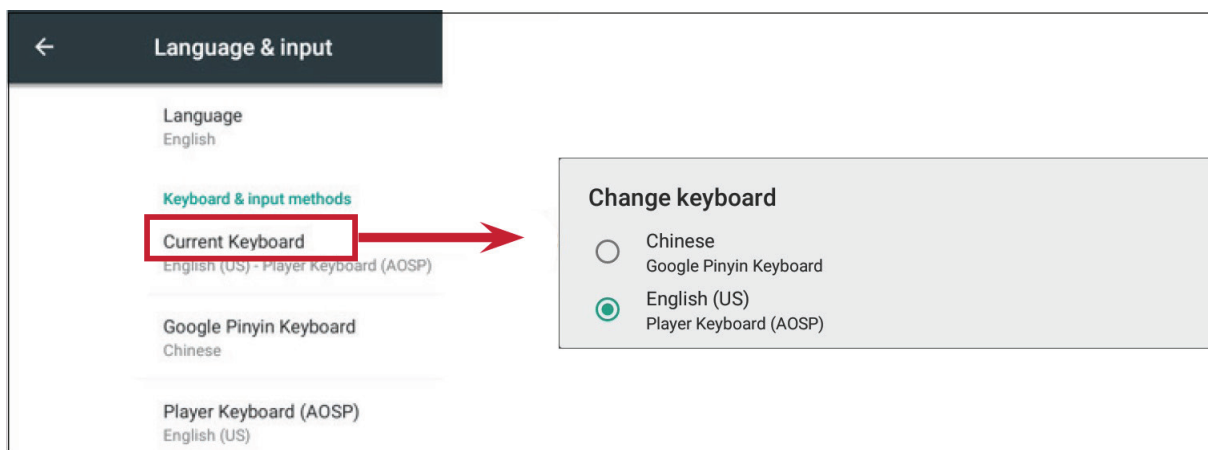

Existing Keyboard

View and adjust advanced entry settings.

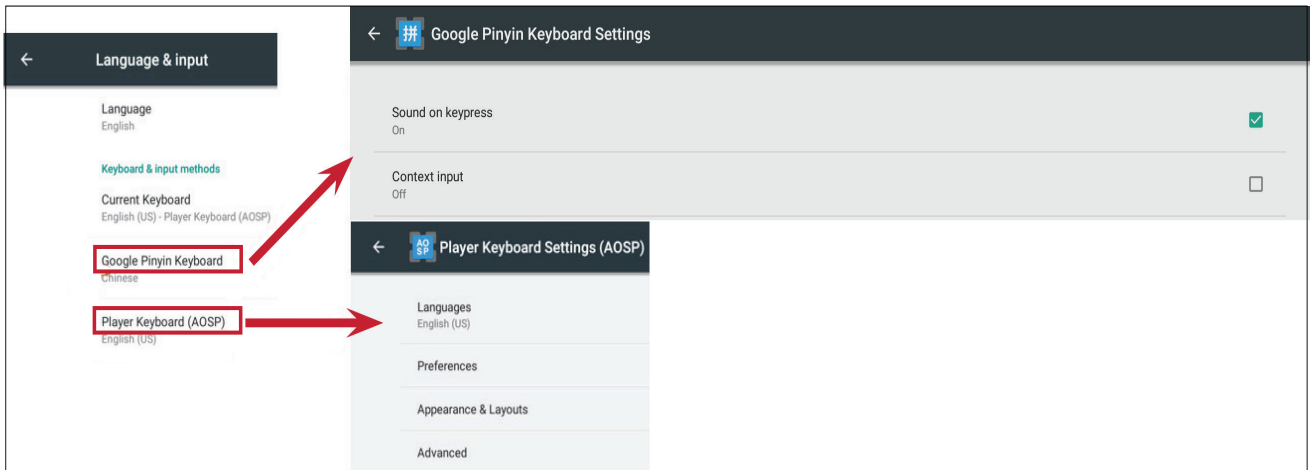

Startup and Shutdown

Set the Startup Channel, Standby Mode, Black Screen After Startup, and adjust Timer settings.

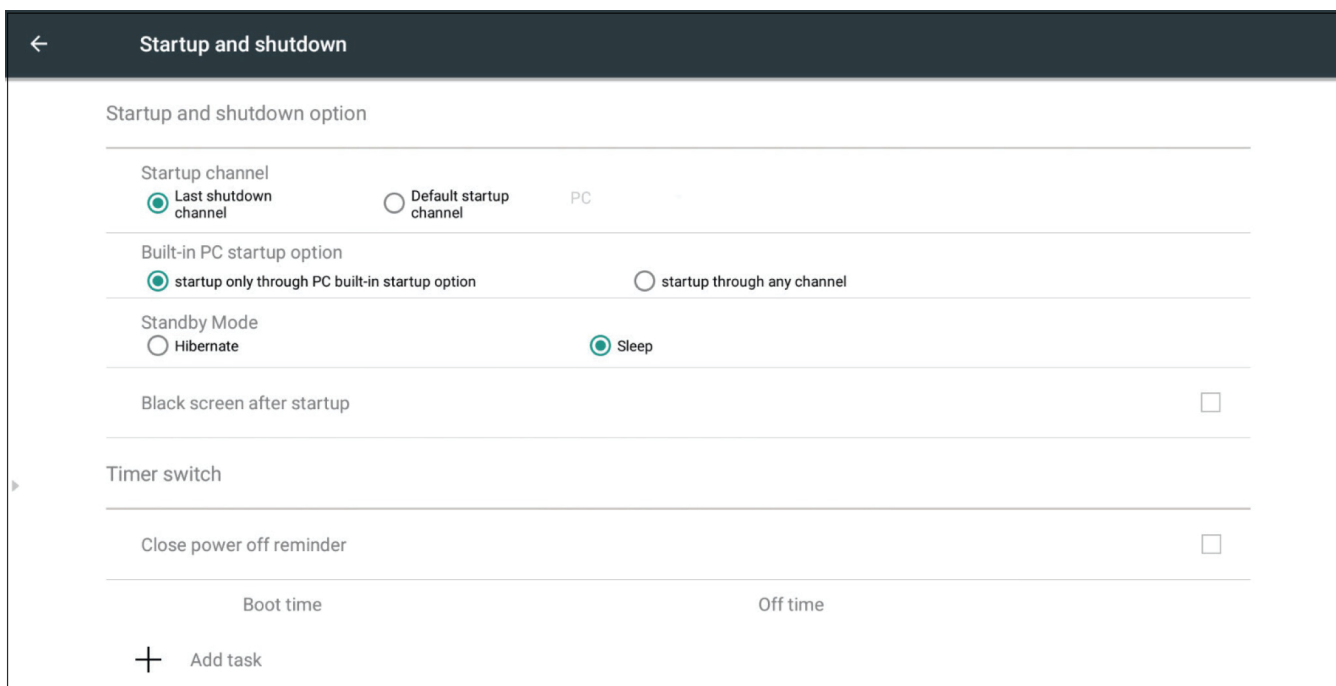

Startup Channel

Adjust the startup channel preference.

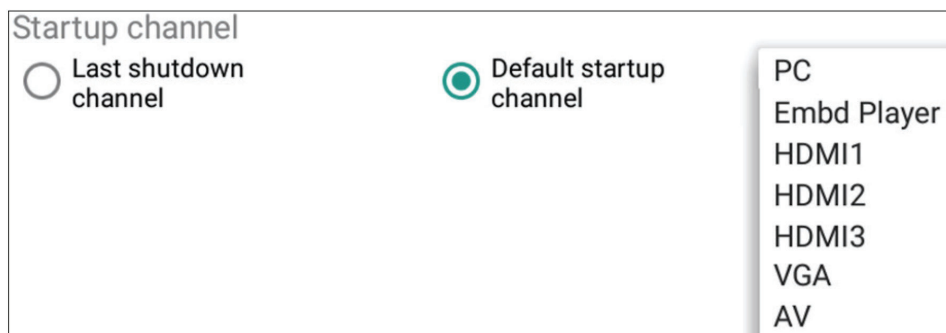

Built-in PC Startup Option

Adjust the built-in PC startup preference.

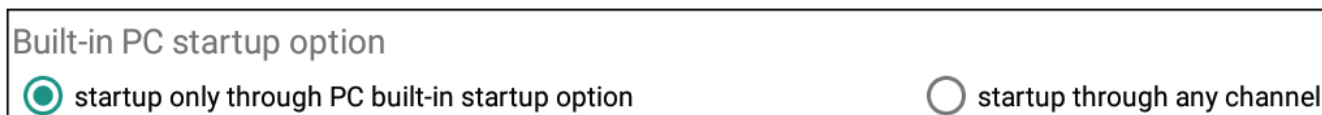

Standby Mode

Decide what happens when you press the **Power** button while the ViewBoard is On.



Hibernate

When enabled, pressing the **Power** button will turn off the ViewBoard and the system.

Sleep

When enabled, pressing the **Power** button will turn off the ViewBoard's backlight, but the system will remain on.

To enable sleep mode:

1. The user needs to provide their ViewBoard's serial number (S/N) to ViewSonic. The S/N label is located near the I/O side.



2. ViewSonic will then provide the KEY (FakePowerOff) file to the user.

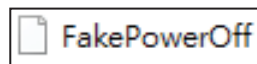

3. After receiving the KEY file, copy the file to a USB drive.
4. Insert the USB drive into the USB port of the ViewBoard.

NOTE: The KEY file MUST match the ViewBoard's S/N.

5. Select "Sleep".

NOTE:

- The user does not need to restart the system.
- If the user sets the **Standby Mode** to **Hibernate** then to **Sleep** again, the user needs to repeat steps 3 to 5.

Black Screen After Startup

When enabled, the ViewBoard will turn off the backlight automatically after the scheduled boot time.

Black screen after startup

Close Power Off Reminder

When enabled, the ViewBoard will turn off the directory without any reminder after the scheduled off time.

Close power off reminder

To add a schedule:

1. Tap the “+” icon.

The screenshot shows a task scheduler interface with two columns: 'Boot time' and 'Off time'. At the top left, a red box highlights a '+' icon, with a red arrow pointing down to the 'Boot time' section. The 'Boot time' section shows a time picker set to 11:00 AM. Below the time picker are seven checkboxes for days of the week (Sun-Sat) and two radio buttons for 'Everyday' and 'Working day'. The 'Off time' section shows a time picker set to 12:01 PM, with similar day and frequency options. On the right side, there are two circular buttons: a blue checkmark and a blue trash can.

2. Adjust the desired times and days. Then tap the to save.

The screenshot shows the same task scheduler interface as above, but with adjustments. In the 'Boot time' section, the time is now 8:50 AM. A red hand icon is shown adjusting the minutes from 49 to 50. The 'Working day' radio button is selected. In the 'Off time' section, the time is now 8:00 PM. A red hand icon is shown tapping the blue checkmark button to save the task.

Password for Screen Lock

Set a screen lock password by selecting **Set**, inputting a password, and selecting **OK**.

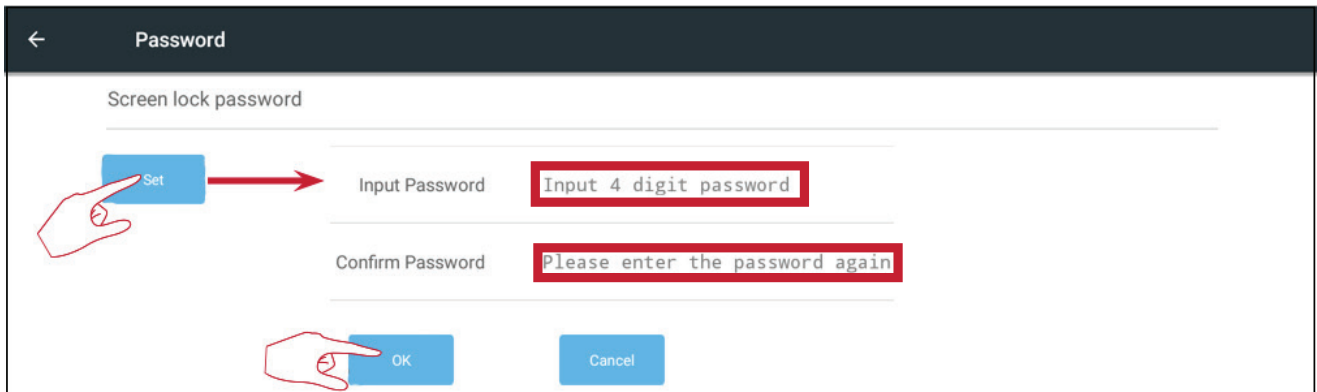

The screenshot shows a mobile interface titled "Password" with a back arrow on the left. Below the title is a "Screen lock password" label. There are two input fields: "Input Password" and "Confirm Password". The "Input Password" field contains the text "Input 4 digit password" and is highlighted with a red box. The "Confirm Password" field contains the text "Please enter the password again" and is also highlighted with a red box. A blue "Set" button is located to the left of the "Input Password" field, with a red hand icon pointing to it and a red arrow pointing to the input field. At the bottom, there are two blue buttons: "OK" and "Cancel". A red hand icon is pointing to the "OK" button.

Input Setting

Enable/disable Input Alias Switch, Wake on Active Source, Channel Auto Switch, Auto Search, and set No Signal Power off.

Input Alias Switch

Once enabled, the user can edit input aliases and when the **Display** button is pressed the source information (located in the upper left side) will also be changed.

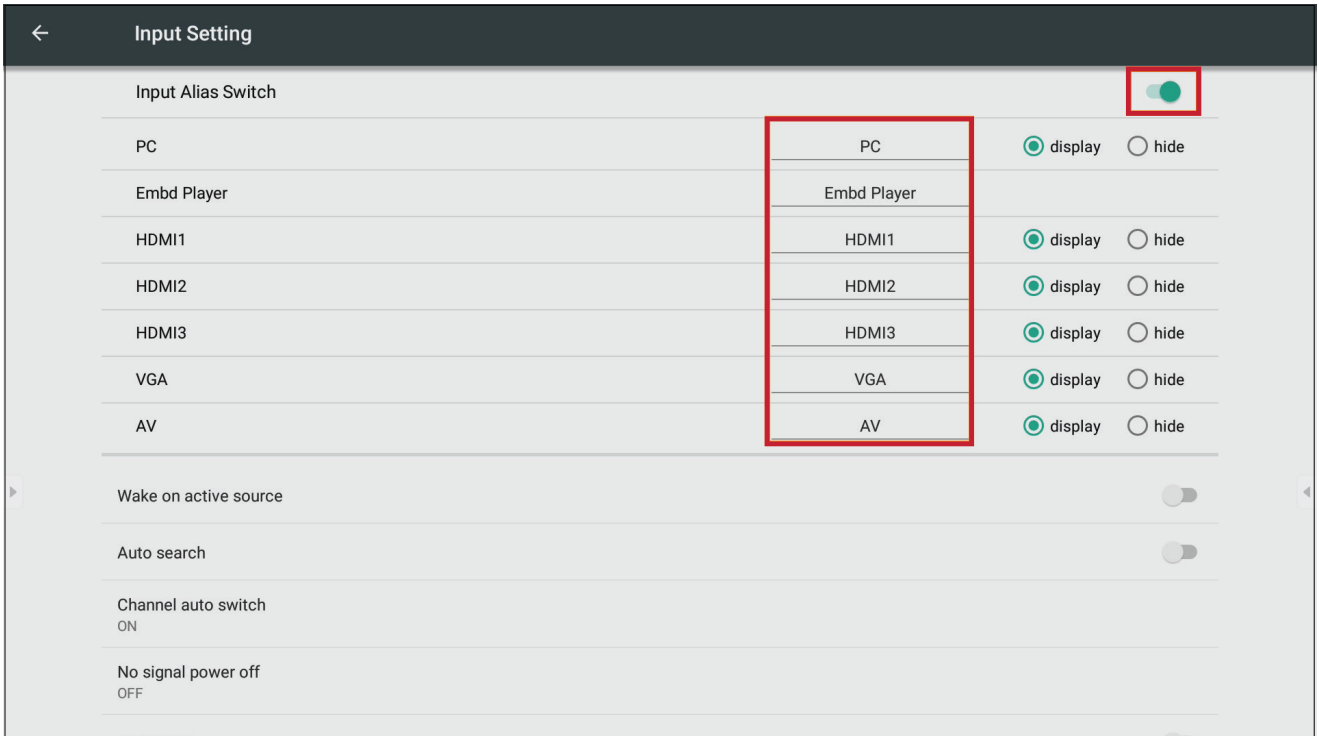

Users can also choose to Display or Hide the input source.



NOTE: Embd Player cannot be hidden.

Wake on Active Source

The ViewBoard will detect HDMI and VGA signals in Standby mode. If HDMI or VGA has a signal output, the ViewBoard will power on automatically.

Auto Search

When enabled, if the current source does not have a signal, the ViewBoard will automatically search the input sources one time.

Channel Auto Switch

When enabled, if the ViewBoard detects a new signal input it will switch the input source automatically.

No Signal Power Off

Adjust the “No Signal” power off timer.

HDMI CEC Settings

Enable/disable HDMI CEC functions.

HDMI CEC	<input checked="" type="checkbox"/>
Player on then display on(Need to set Standby Mode to Sleep first)	<input checked="" type="checkbox"/>
Display off then player off	<input checked="" type="checkbox"/>
Player off then display off	<input type="checkbox"/>
Display on then player on	<input type="checkbox"/>
IR pass through	<input checked="" type="checkbox"/>

Other Settings

Adjust Side Toolbar Channel and Eco Mode settings.

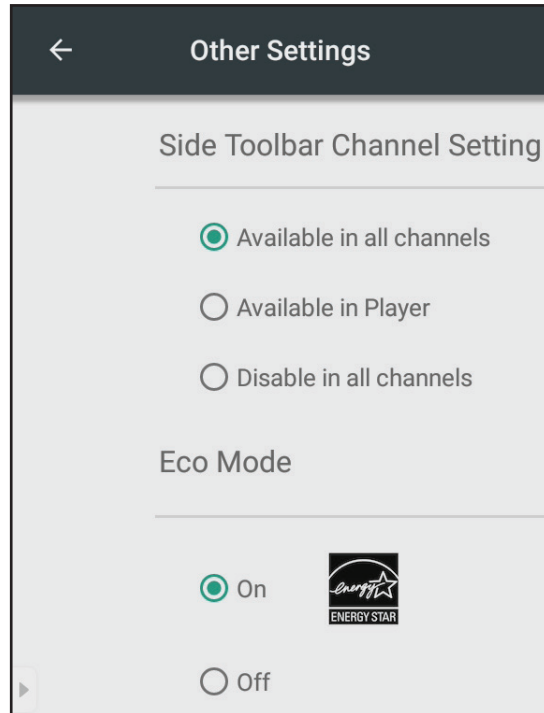

Side Toolbar Channel

Adjust the side toolbar availability.

ECO Mode

When enabled, the ViewBoard will turn off automatically after sixty (60) minutes of Embedded Player source being idle or after five (5) minutes of other input source without signal.

System

Adjust Date & Time, view About Device, and Advanced Settings.

Date & Time

Set the system time and format.

Automatic Date & Time

When enabled, the ViewBoard will automatically synchronize the date and time via the Internet.



NOTE: Ethernet or Wi-Fi connection is needed.

Set Date

Adjust the values then select **OK** when finished.

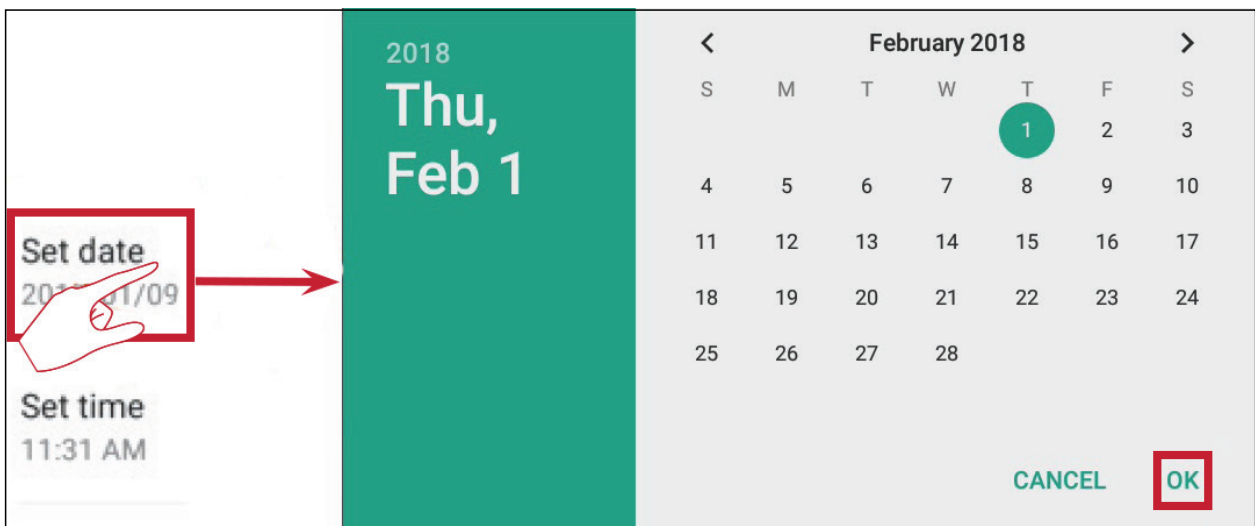

Set Time

Adjust the values then select **OK** when finished.

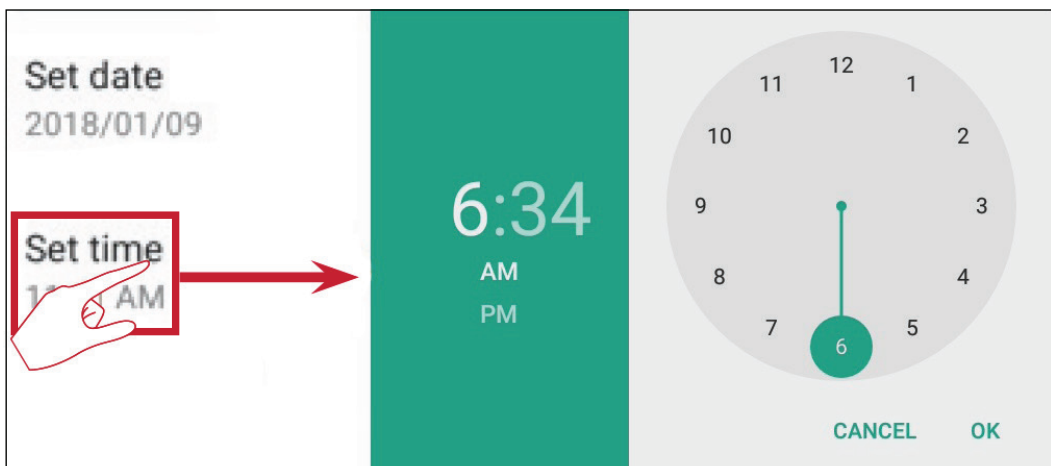

Select Time Zone

Choose from the available time zones.



Select Time Format

Choose from 12 hour and 24 hour time format.

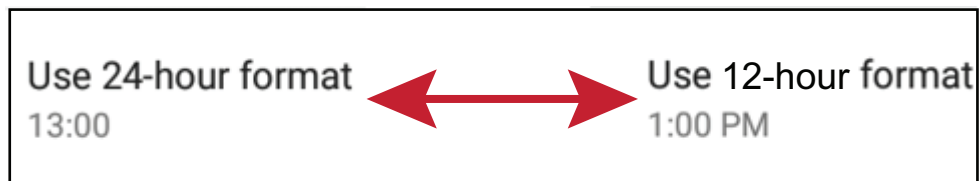

Choose Date Format

Select from the available date formats.

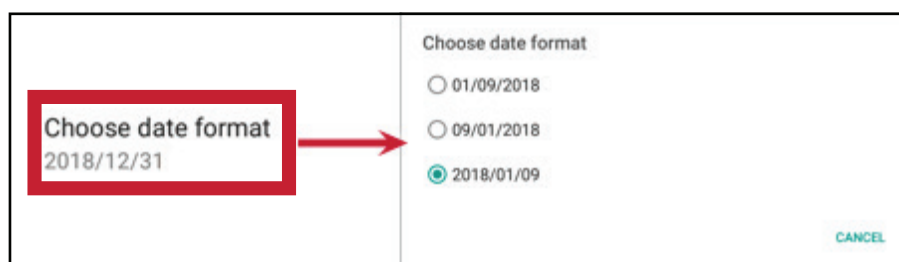

About Device

Display Embedded Player information, System Updates, Display ID Setting, and Asset Tag Setting.

System Update

Upgrade the firmware via OTA.

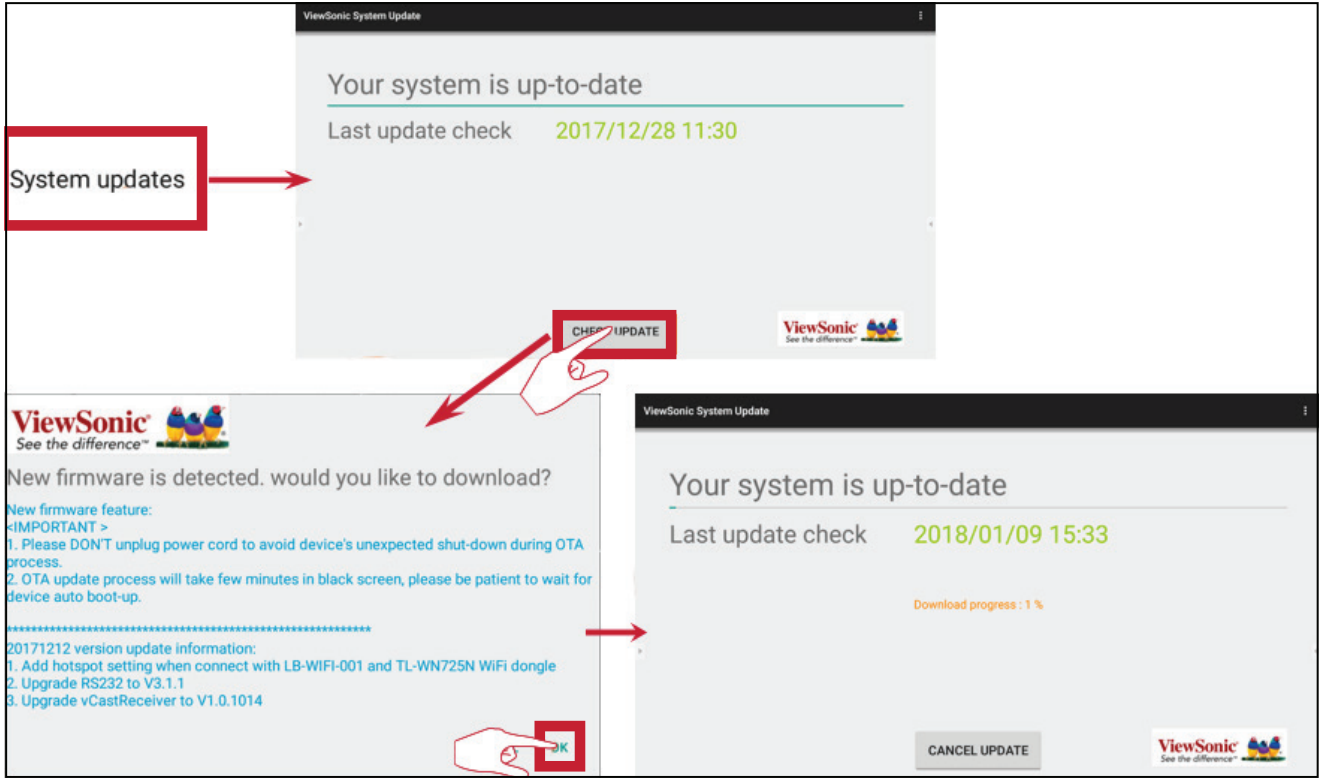

Legal Information

Check open source licenses.

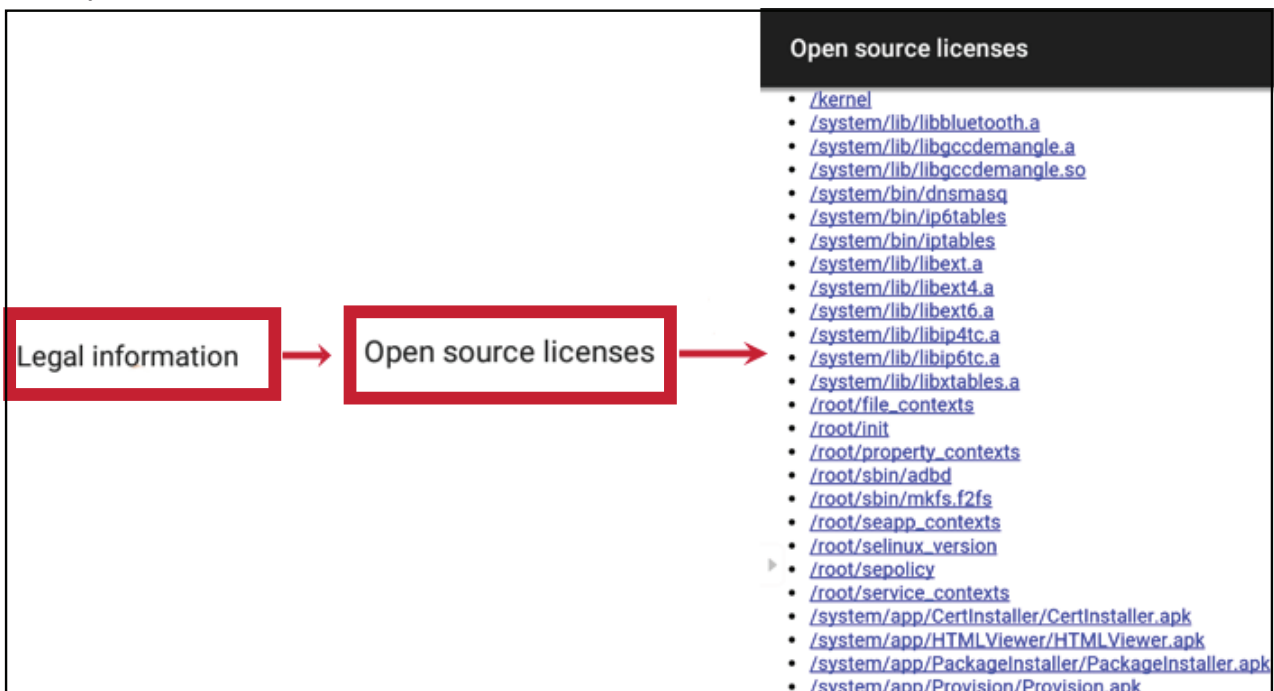

Display ID

Change the Display ID.

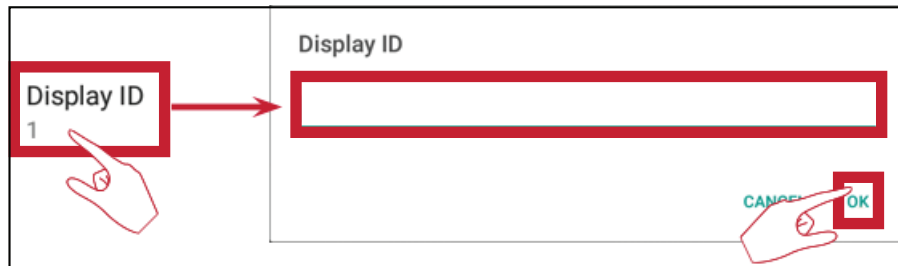

NOTE: The Display ID is for RS232 users, and the range is 01~98.

Asset Tag

Key in the asset information.

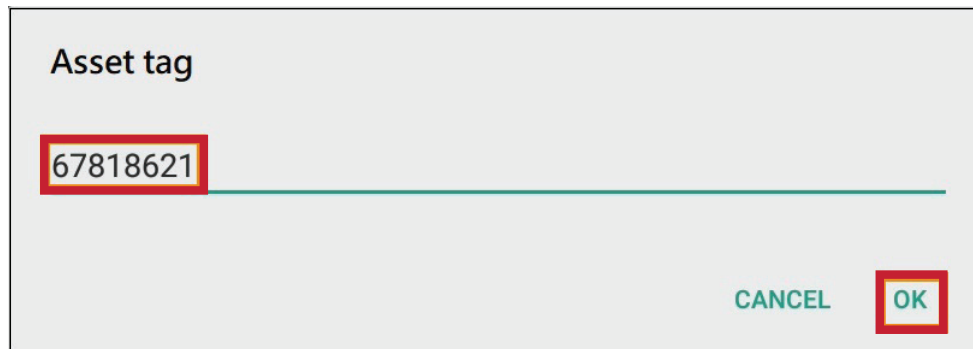

Advanced

Set the Mode, check Apps, modify Passwords, and enable/disable USB disk connection.

Mode

- **Normal Mode:** The embedded screen sharing apps will run normally.
- **Security Mode:** The embedded screen sharing apps will be removed.
- **Disable Embedded OS:** The system will automatically reboot, and then the Embedded OS will not appear.

Mode

Normal mode

Secured Mode(Remove embedded screen sharing Apps)

Disable Embedded OS

APP

The user can view app information and force stop, uninstall, move to USB storage, clear data, clear cache, and clear defaults.

NOTE:

- Pre-loaded apps cannot be uninstalled.
- Not all apps support the move to USB storage feature.
- Not all apps support Clear Defaults.

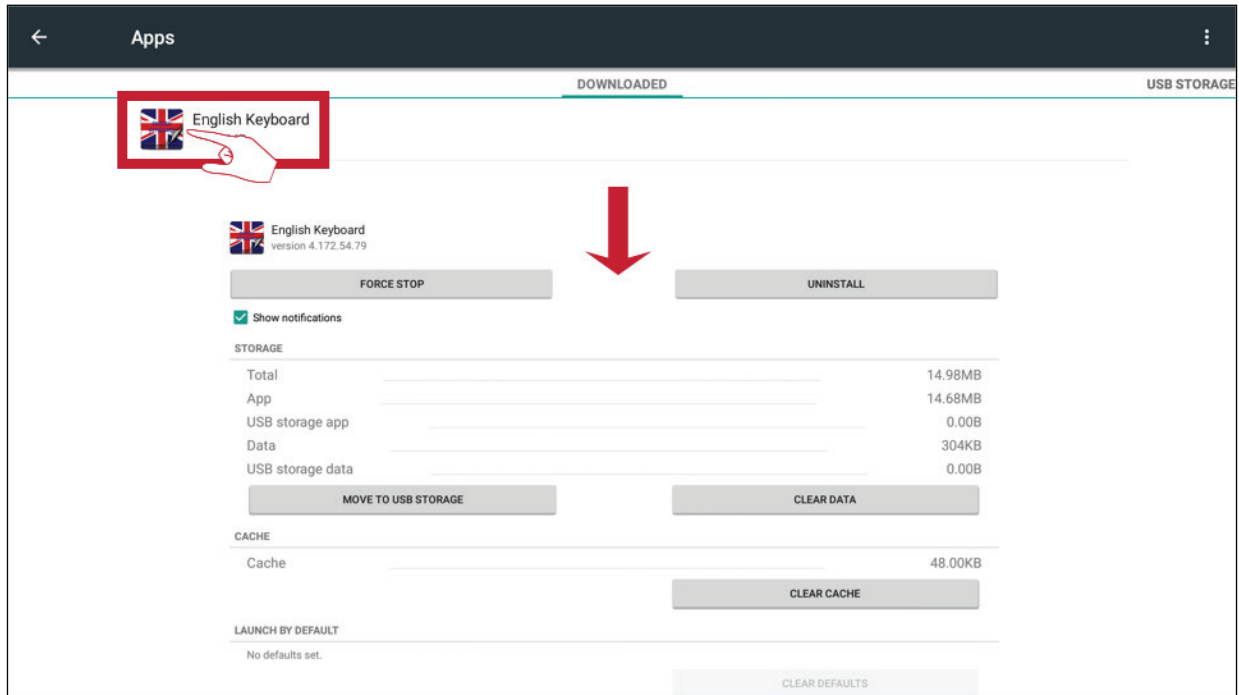

Select the right upper icon for additional options.

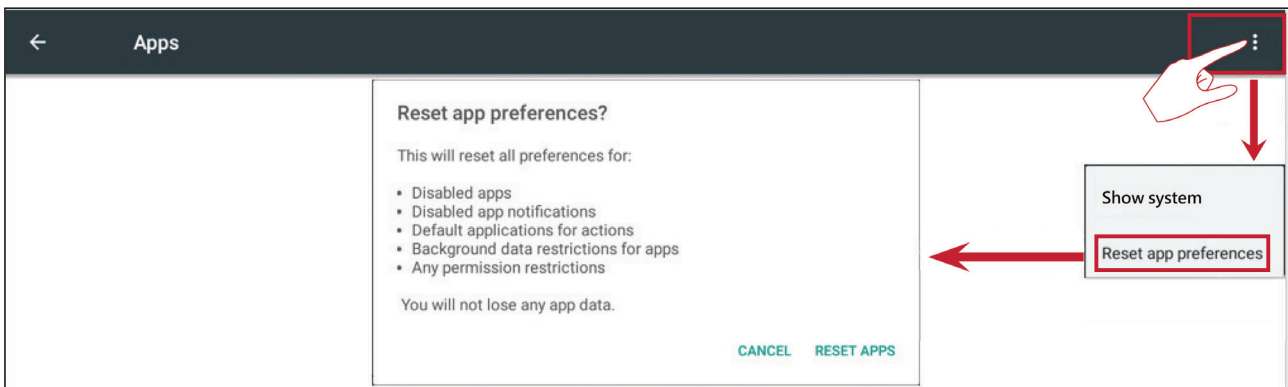

Password

Modify the Advanced setting entry password.

USB Disk Enable

Enable/disable USB disk connection.

Privacy

Set the interval for local file storage access.

- » **Never:** Local storage will be cleaned, and no longer able to save files.
- » **1 Hour:** Files saved to local storage will be deleted after 1 hour.
- » **1 Day:** Files saved to local storage will be deleted after 1 day.
- » **Always:** Local storage is available, and no files will be deleted.

Privacy

Set the interval for local storage file access

Never

1 Hour

1 Day

Always (Local storage is available, no files will be deleted)

[Cancel](#) [Confirm](#)







> Embedded Applications and Settings

Embedded Digital Whiteboard App









Within ViewBoard, ViewSonic offers two versions of the embedded digital whiteboard app, myViewBoard and vBoard Lite, for users to choose from and annotate with.







myViewBoard

Floating Bar

	Move the Floating Bar.
	Switch between presentation and preparation modes.
	Paste from the clipboard onto the canvas.
	Click to open the web browser
	Go to the previous canvas.
	Go to the next canvas.
	Add a new canvas.
	<ol style="list-style-type: none"> 1. New myViewBoard File 2. Open File 3. Save File

Toolbar

	Full Screen Capture
	Toolbar Move Button Select and hold to move the toolbar to the left side, right side, or bottom of the screen.
	<p style="text-align: center;">File Button</p>  <ol style="list-style-type: none"> 1. New myViewBoard File 2. Open File 3. Save File 4. Save as File 5. Export 6. Email
	Import resources (image, video, audio, etc.) to the whiteboard.
	Infinite Canvas Button Select – Use two hands to zoom in/out on/of the working panel.
	Selection Button Select objects, text, and pictures to get other tools.
	Pen Button Writing tools, changing colors, transparency, thickness, etc.
	Eraser to erase objects or clear the page.







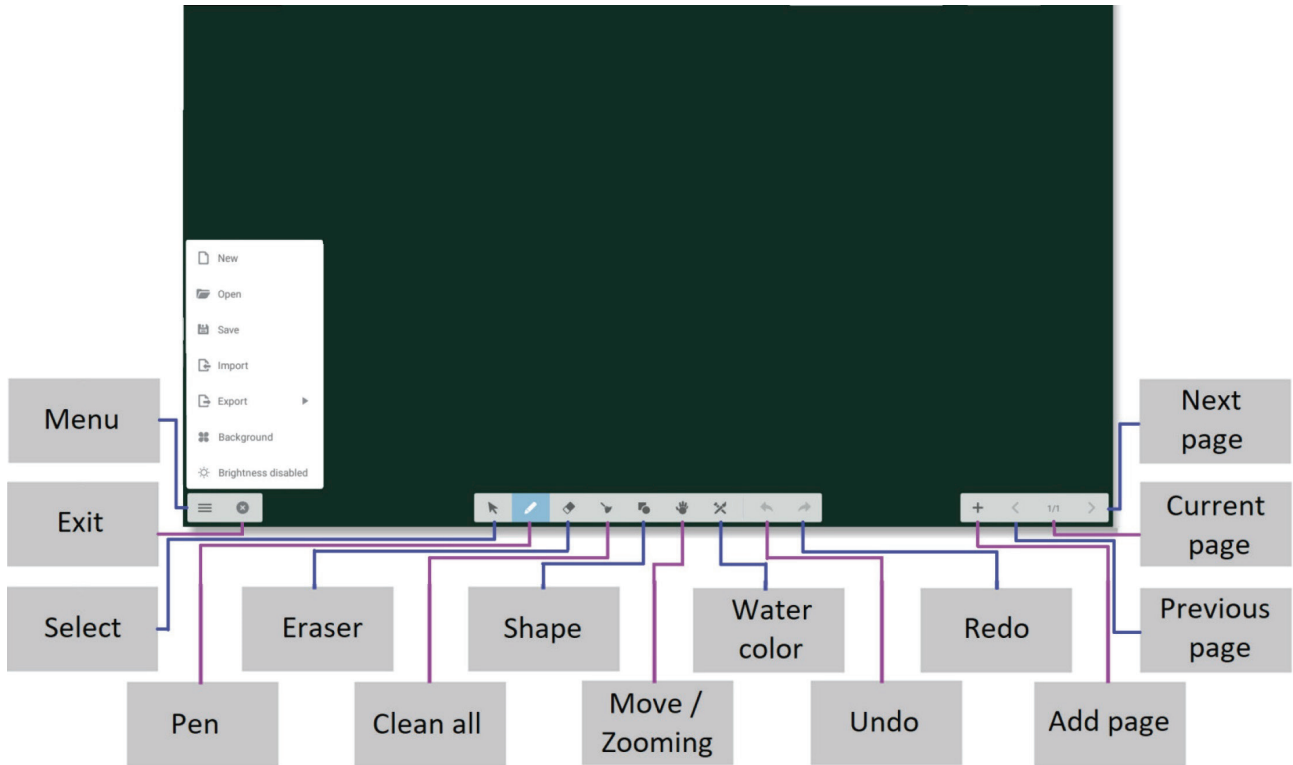







	Shape/Line Button	Create shapes, select shape colors, insert arrows.
	Text Box	Creates a Text box.
	Undo Button	Undo previous actions.
	Redo Button	Redo previous actions.
	Page Toggle Button	Select pages, sort pages, delete pages.
	Show or hide the current host information.	
	Whiteboard background management menu.	

vBoard Lite

User Interface:







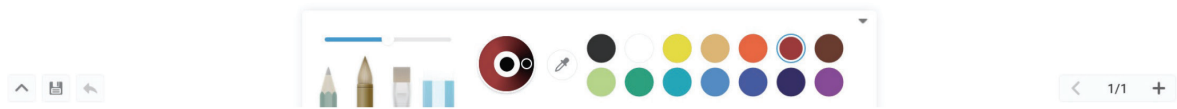

Menu Options:

 New	 New	Click to create new file
 Open	 Open	Click to open *.enb format file
 Save	 Save	Click to save current content to *.enb format
 Import	 Import	Click to import *.jpg format file
 Export	 Export	Click to export current content
 Background	 Background	Click to change background
 Brightness disabled	 Auto brightness	Click to enable/disable auto brightness

Watercolor Feature

Additional annotation tool option within vBoard lite.



Item	Description
 Pen	Click to select different type Note: In pen mode, it supports up to 10 points for writing
 Thickness	Click to change thickness
 Palette	Select color then press and rotate the circle on palette to adjust color
 Dipper	Click dipper to dip up color for pen
 Color disc	Click to change pen color

ViewBoard Cast

Working with ViewBoard® Cast software, the vCastReceiver app, will allow the ViewBoard® to receive vCastSender laptop screens (Windows/Mac/Chrome) and mobile (iOS/Android) users' screens, photos, videos, annotations, and camera(s).

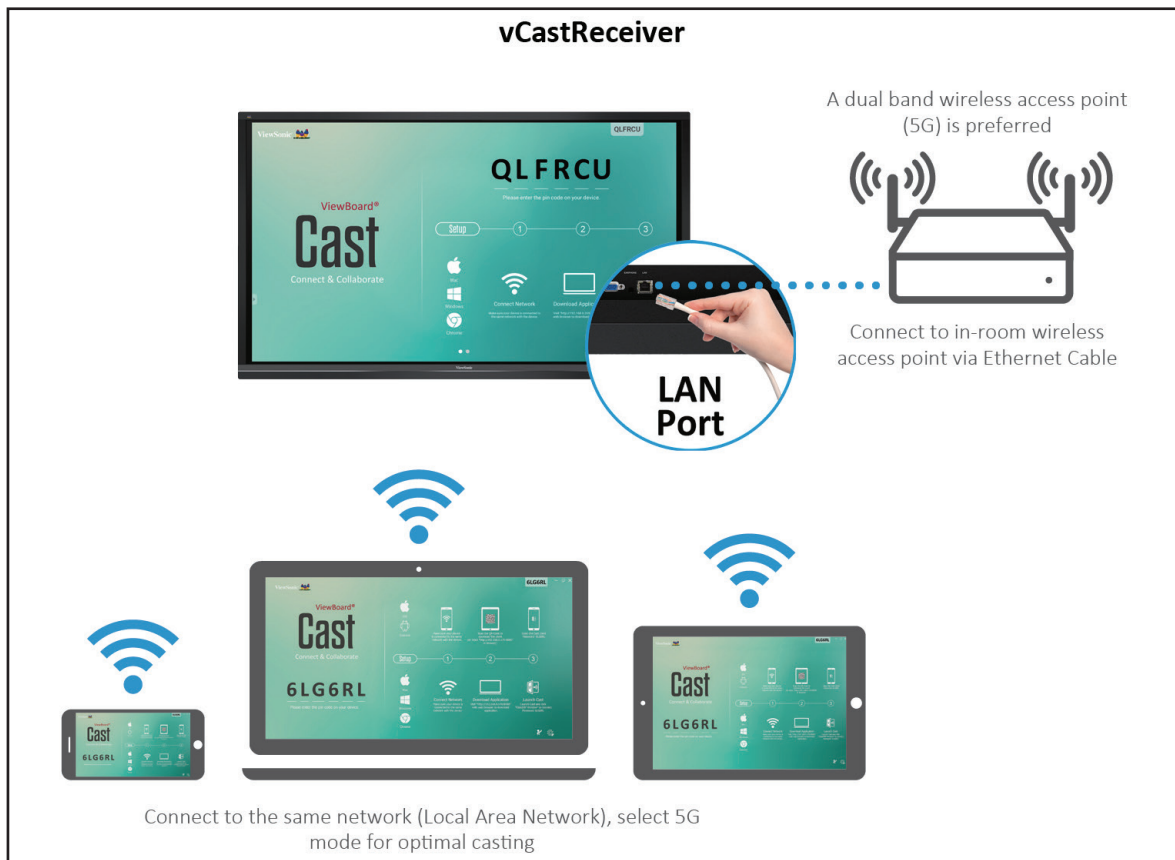

Network Information

- ViewBoard® Cast software, laptops, and mobile devices can connect to both the same subnet and across the subnet network.
- Connected devices will show up under “Device List” on the same subnet connection.
- If the device does not show up under “Device List”, users will need to key-in the on-screen PIN-code.

ViewBoard Cast is a wireless peer to peer data communication, therefore the below port settings are required:

Ports:

- CP: 56789, 25123, 8121, and 8000
- UDP: 48689 and 25123

Port and DNS activation:

- Port: 8001
- DNS: h1.ee-share.com

Cast Sender from Windows-based Devices, Macbook, and Chrome devices.



Mac, Windows, Chrome Devices

1. Make sure your device is connected to the same network as the ViewBoard.
2. Visit the address that is shown on the ViewBoard to download the application.
3. Launch ViewBoard Cast and click the icon number that is shown on the ViewBoard.

Cast Sender from Mobile Devices: iOS-based (iPhone, iPad) and Android OS based phone/tablet.

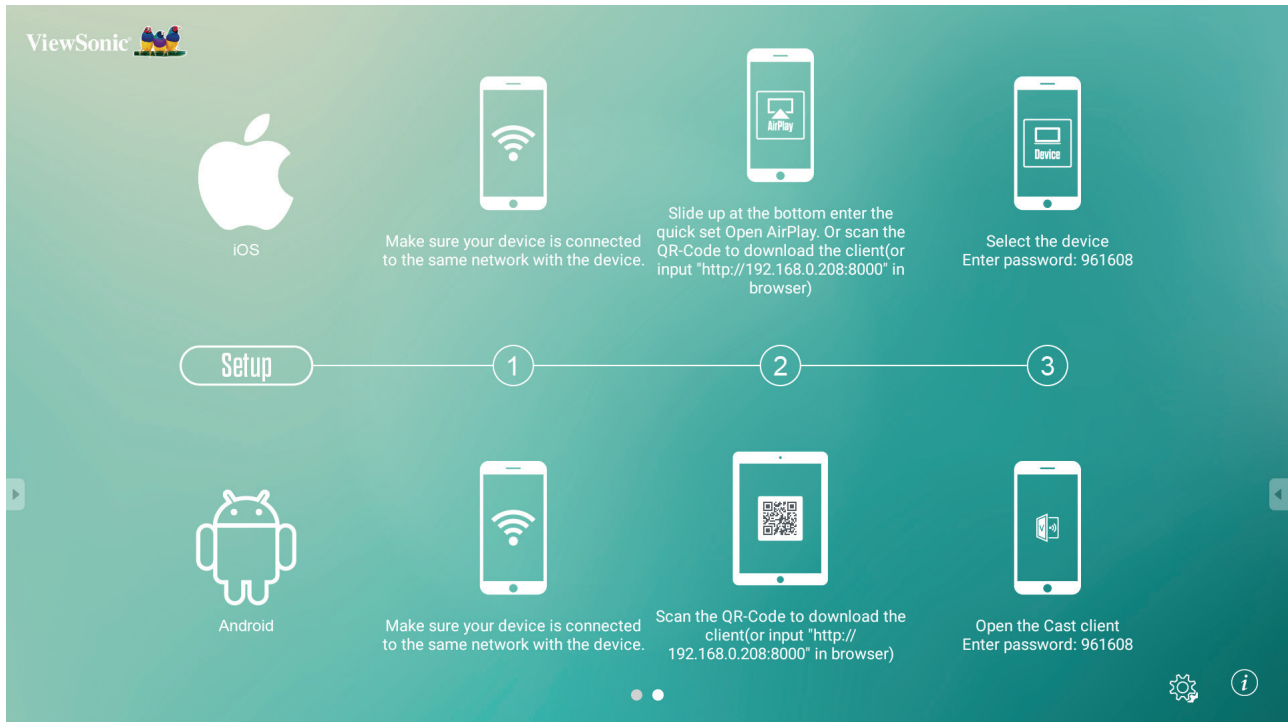

Android:







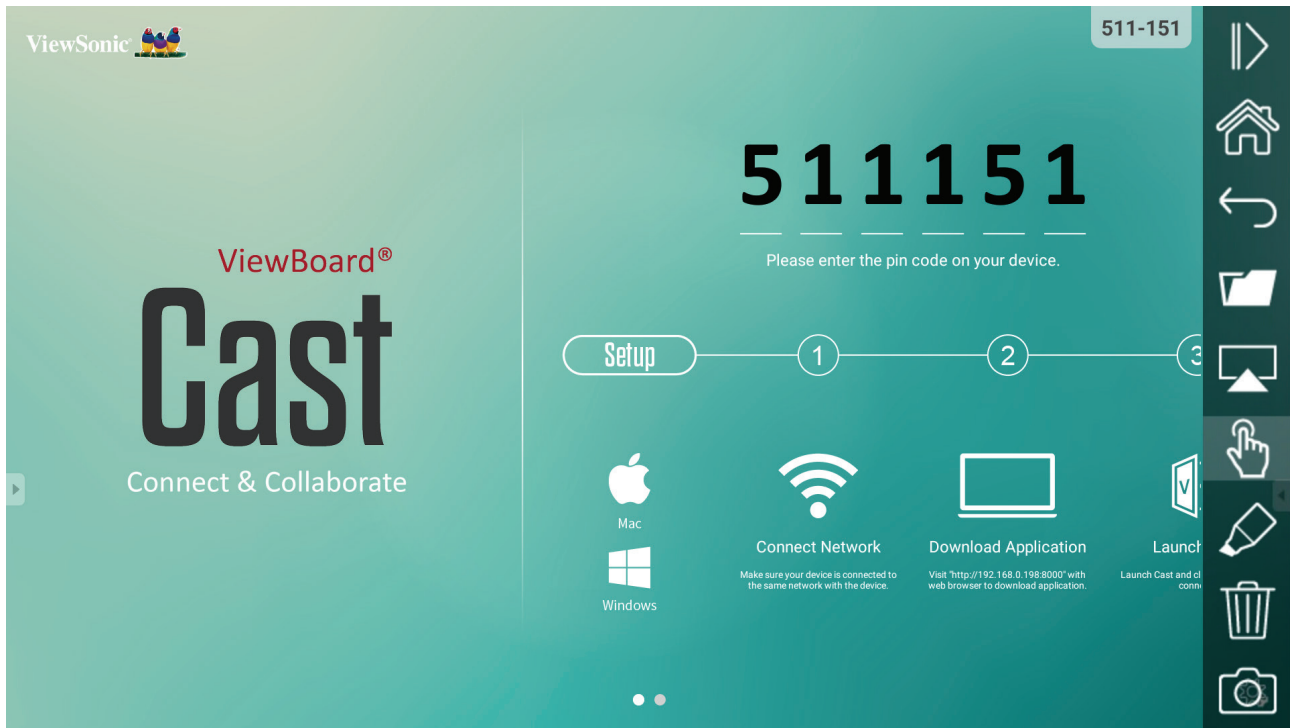

1. Make sure your device is connected to the same network as the ViewBoard.
2. Enter the password that is shown on the ViewBoard.
3. Scan the QR Code that is shown on the ViewBoard to download the client.
4. Open the ViewBoard Cast client.

iOS:

1. Make sure your device is connected to the same network as the ViewBoard.
2. Enter the password that is shown on the ViewBoard.
3. Select the device, then the iOS operation interface will appear.

Cast Out from a Mobile Device that Supports Annotation



Item	Description
 Toggle	Click to hide or display tool bar
 Home	Click to return to home interface
 Return	Click to return to previous operation interface
 Folder	Click to view or open mobile device internal file
 Screen sharing	Click to share screen (Android 5.0 above supported)
 Touch	Click to change to touch mode
 Pen	Click to make annotation in the picture Click to change color or thickness
 Clear	Click to clean all the elements
 Camera	Click to use camera then send the image to IFP50

Air Class

Display quiz questions on the ViewBoard and allow up to 30 mobile users to submit answers remotely. Whether deploying single or multiple choice questions, the ViewBoard will record the results for each device being used.

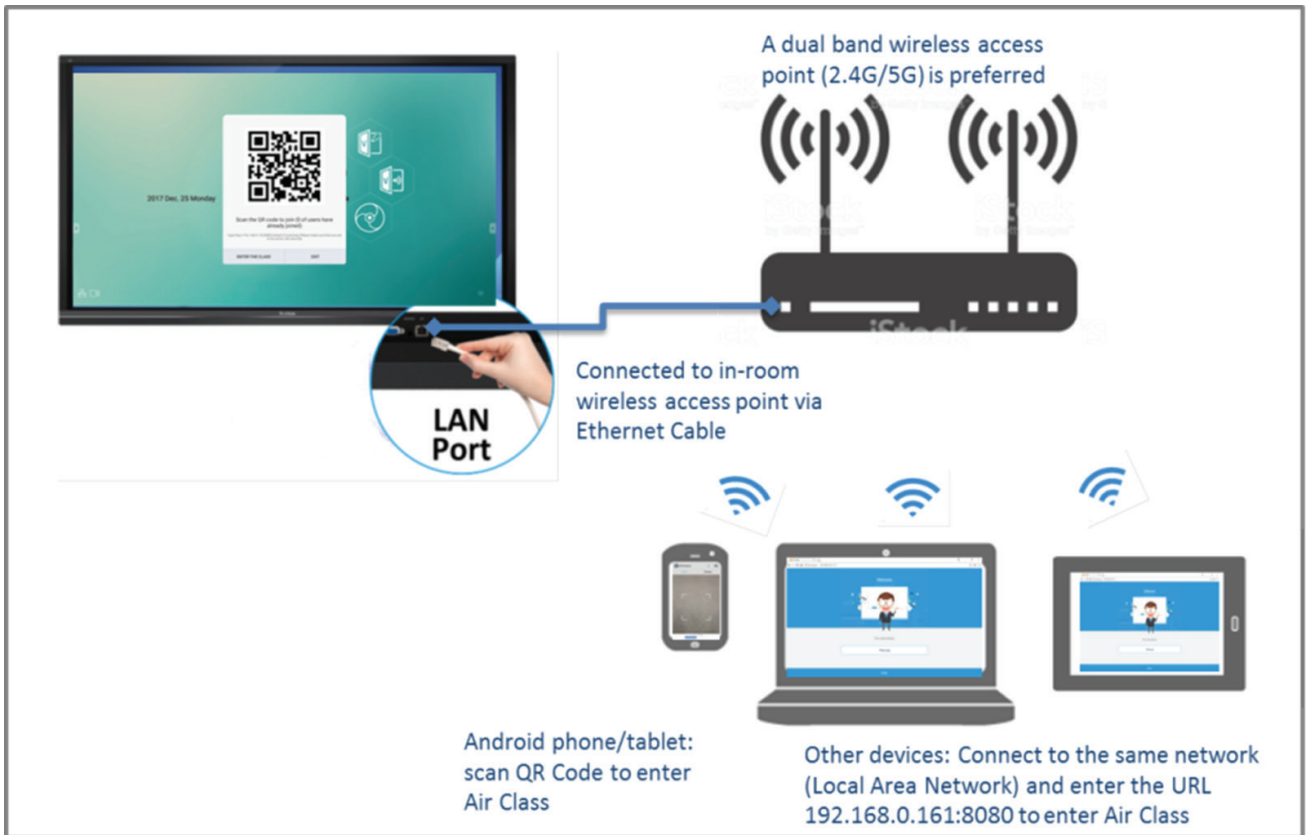

Network Information

- PC (Windows/Mac/Chromebook) and tablet/mobile (iOS/Android) devices, as well as the ViewBoard need to be linked to the same LAN network subnet.
- Ports: TCP 8080

Select “Enter Air Class” on the ViewBoard and select one of the interactive functions to open the Air Class interface.



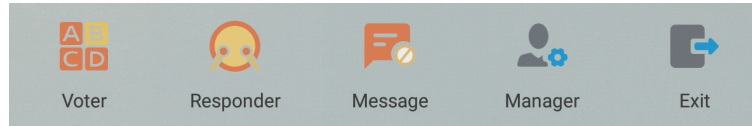

Voter

1. Click the **Single choice** or **Multiple choice** icon to select the preferred answer type.

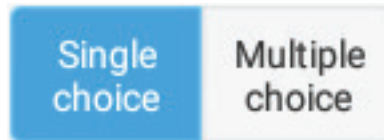

2. Click the **BEGIN** icon to let the participants start.



3. After the participants are finished and press the **OK** icon, the ViewBoard will show the participant's name on screen.

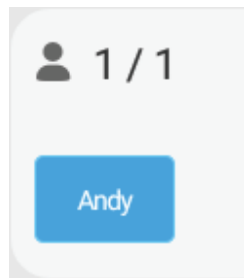

4. Click the **Finish** icon to close the quiz, then the "Answer Statistics" will be displayed.

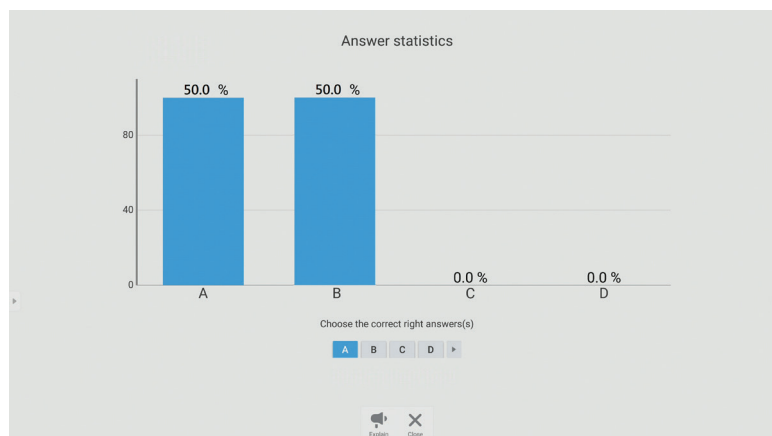

5. Choose the right answer to show the correct rate.

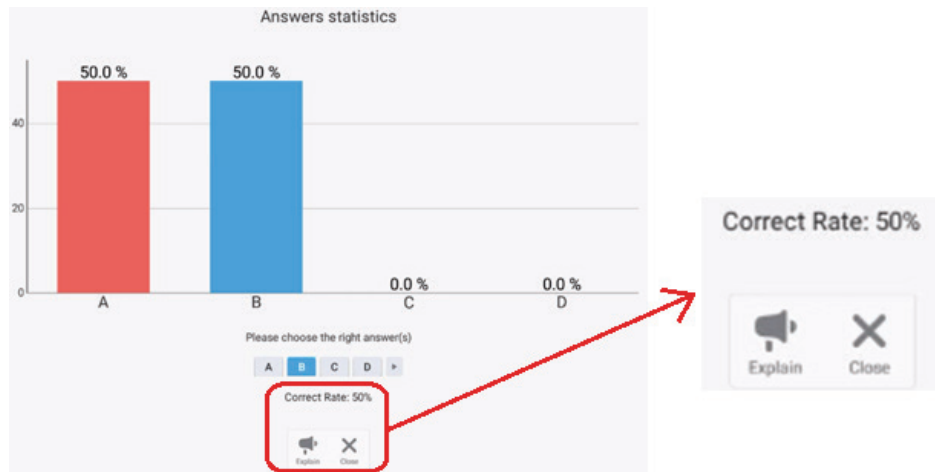

6. Click the  icon to explain and further analyze the topic.

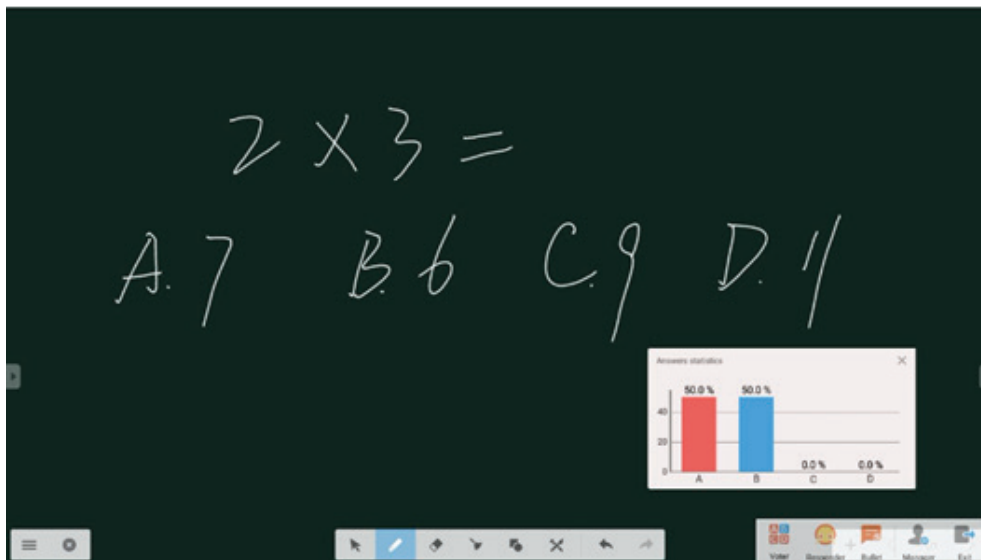

Responder

Participants need to select the **OK** icon to answer.

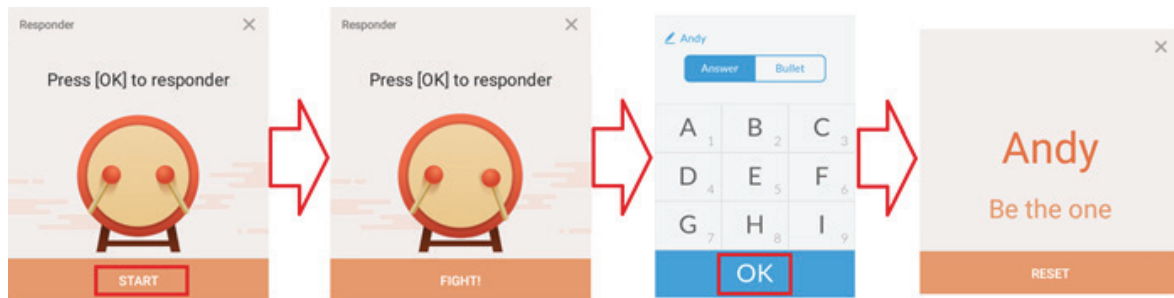

Message

Click to enable/disable the message function.

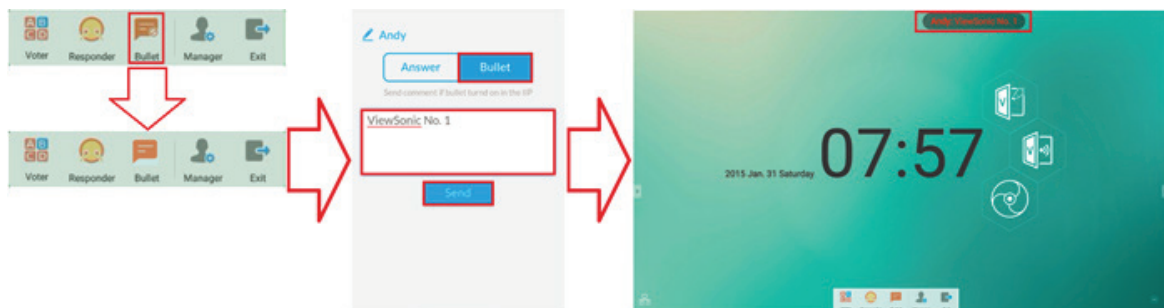

Message operation:

1. Click the Message icon to enable the function.
2. Participants select the Message icon to change the Message interface.
3. Participants key in their message then click the **Send** icon.
4. The message will appear at the top of the ViewBoard.

Manager

Select the icon to display a QR Code to let more participants join the class.

Exit

Select to exit the Air Class interface.

Other Default Applications

Zoom

Select  to launch the Zoom application for video conferencing.

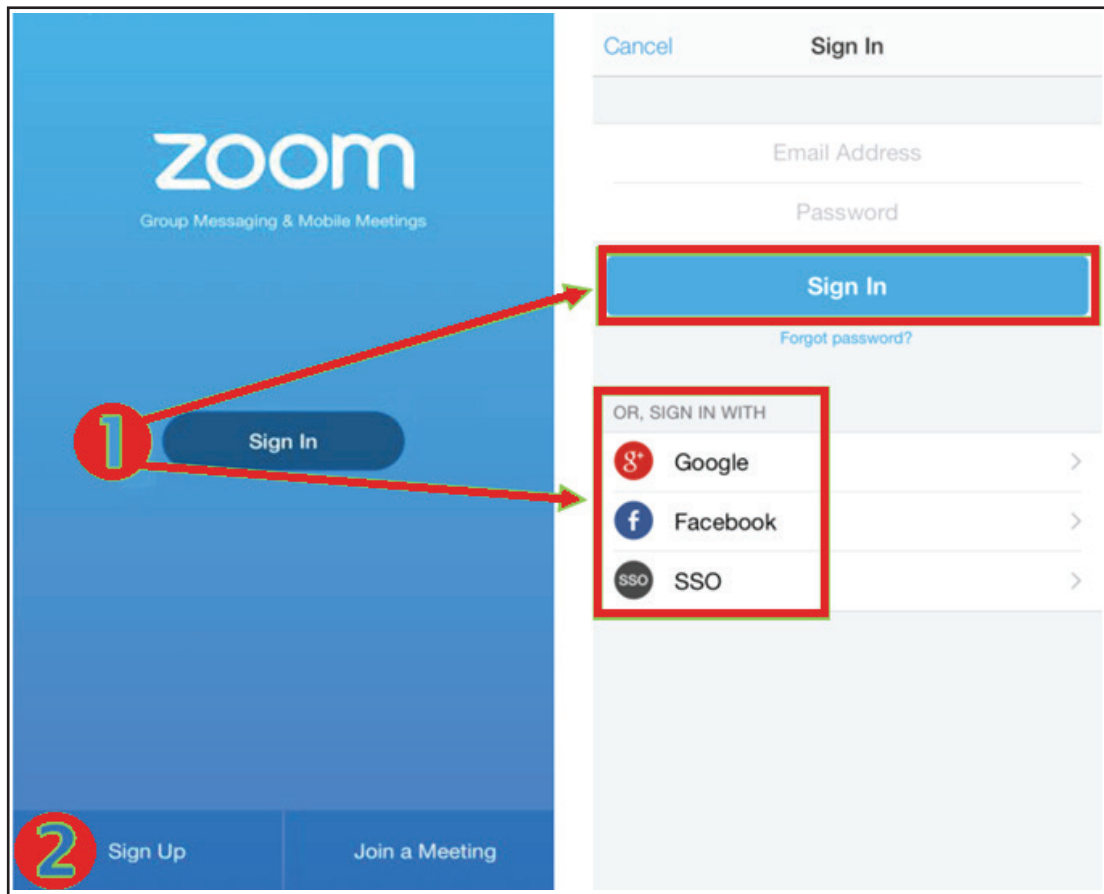

1. Select **Sign In**. Enter your email and password or sign in with your Google, Facebook, or SSO account.
2. If you do not have a Zoom account, you will need to select **Sign Up**.

Join a Meeting

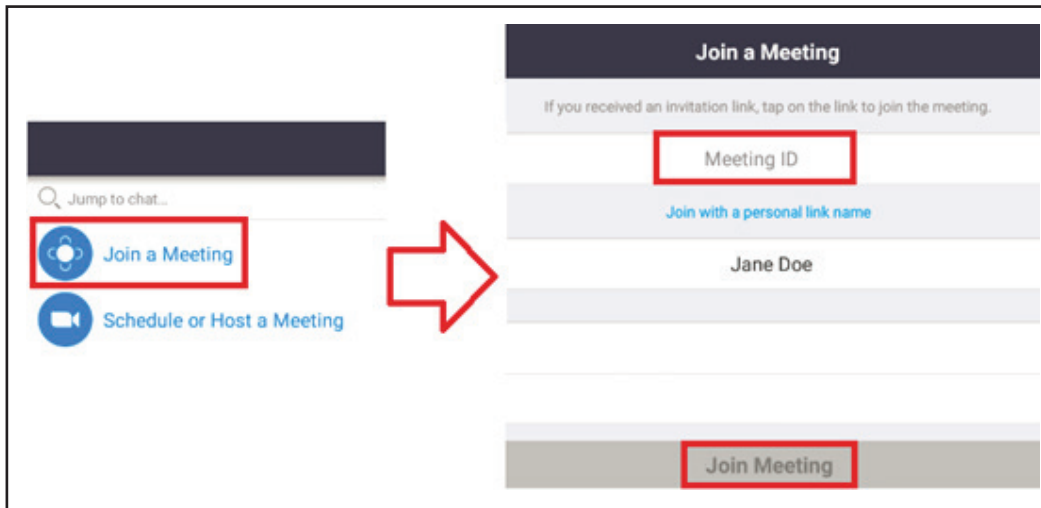

1. Select **Join a Meeting**.
2. Enter the Meeting ID of the meeting you want to join.
3. Select **Join Meeting**.

Start an Instant Meeting

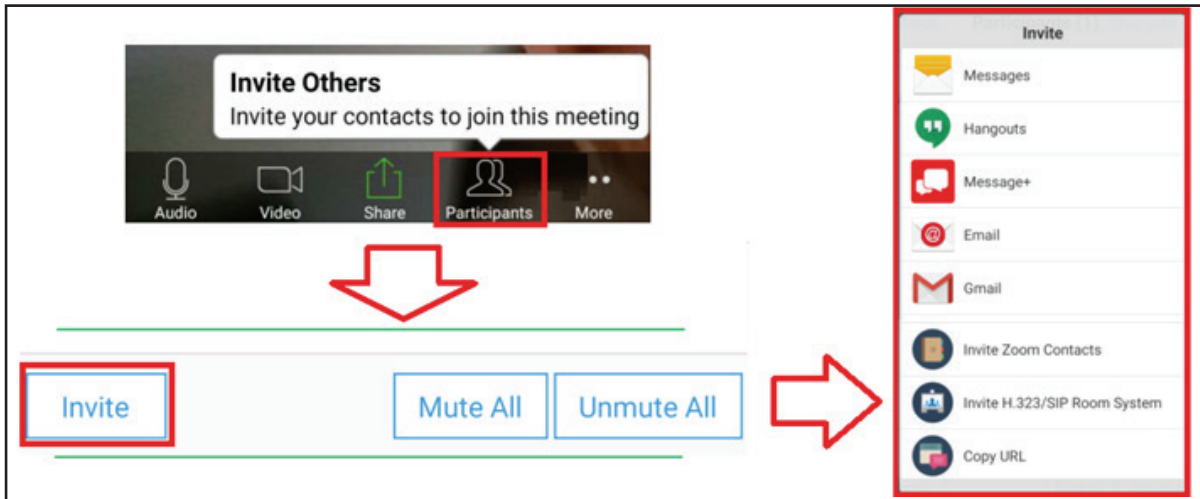
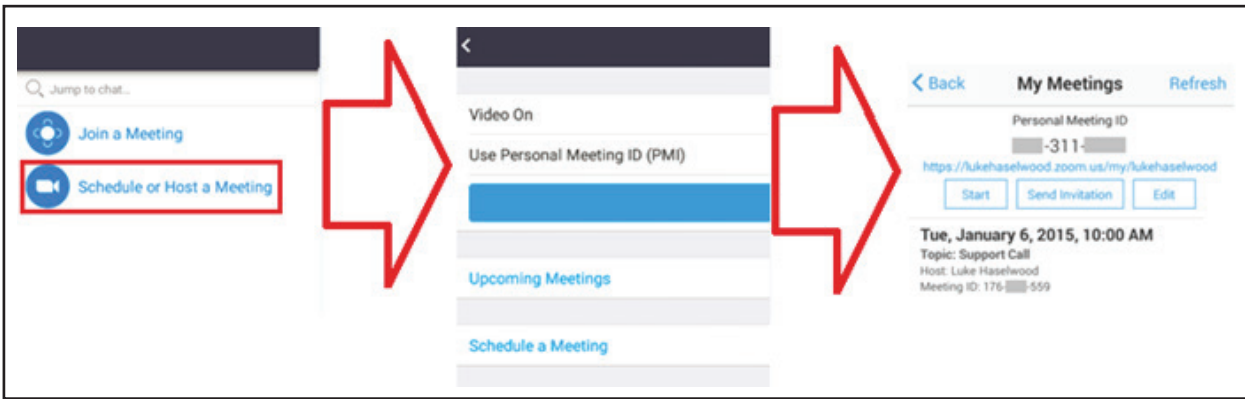

1. Select **Schedule or Host a Meeting**.
2. Choose the meeting options:
 - » Choose to have Video On or Off.
 - » Choose to Use Personal Meeting ID or a unique meeting ID.
3. Select **Start a Meeting**.
4. Invite meeting participants by selecting **Participants** at the bottom of the screen.
5. Select **Invite** at the bottom of the Participants screen.
6. Choose participants by using the contact method you prefer.

Sweeper

Select the  icon to launch the Sweeper application and clear unnecessary data and unwanted files.

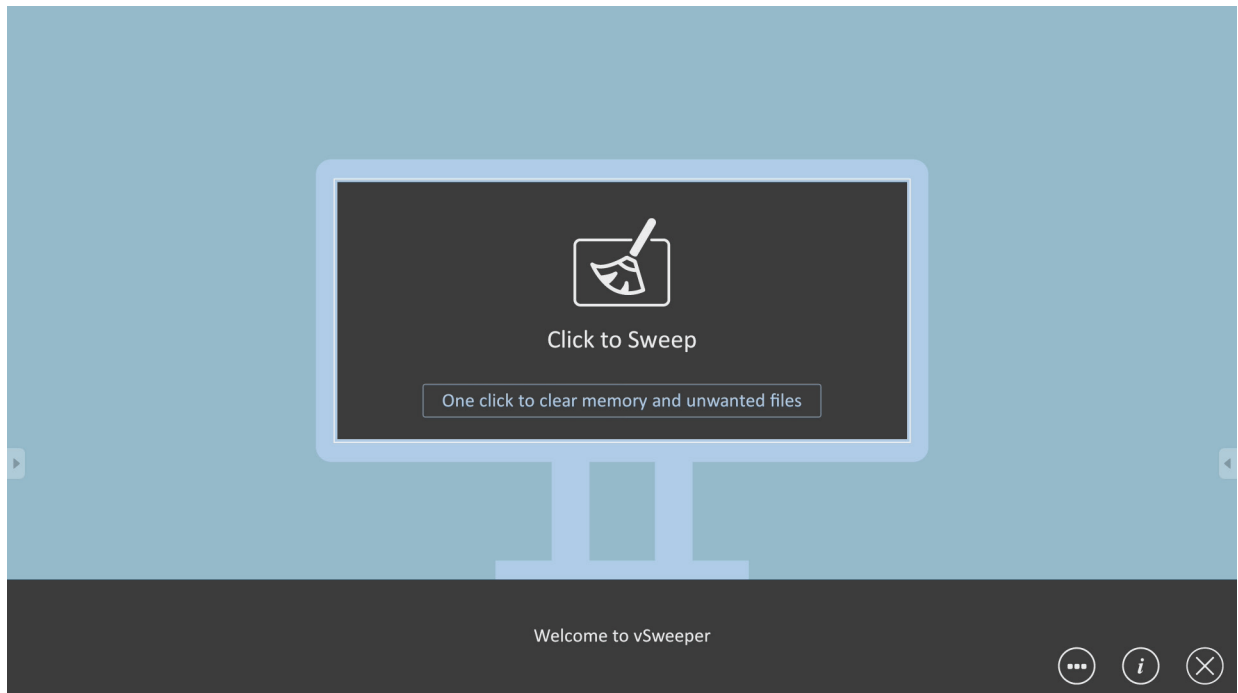

Screen Lock

Select the  icon to set a screen lock password or enable screen lock.

NOTE: If the user forgets the password, use the remote control and press **INPUT 0214** to restore the password to default.

Set Password

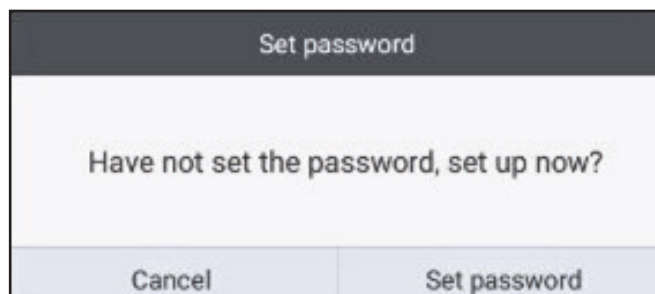

Screen Lock Enabled



Chromium

Web browser for surfing the Internet.

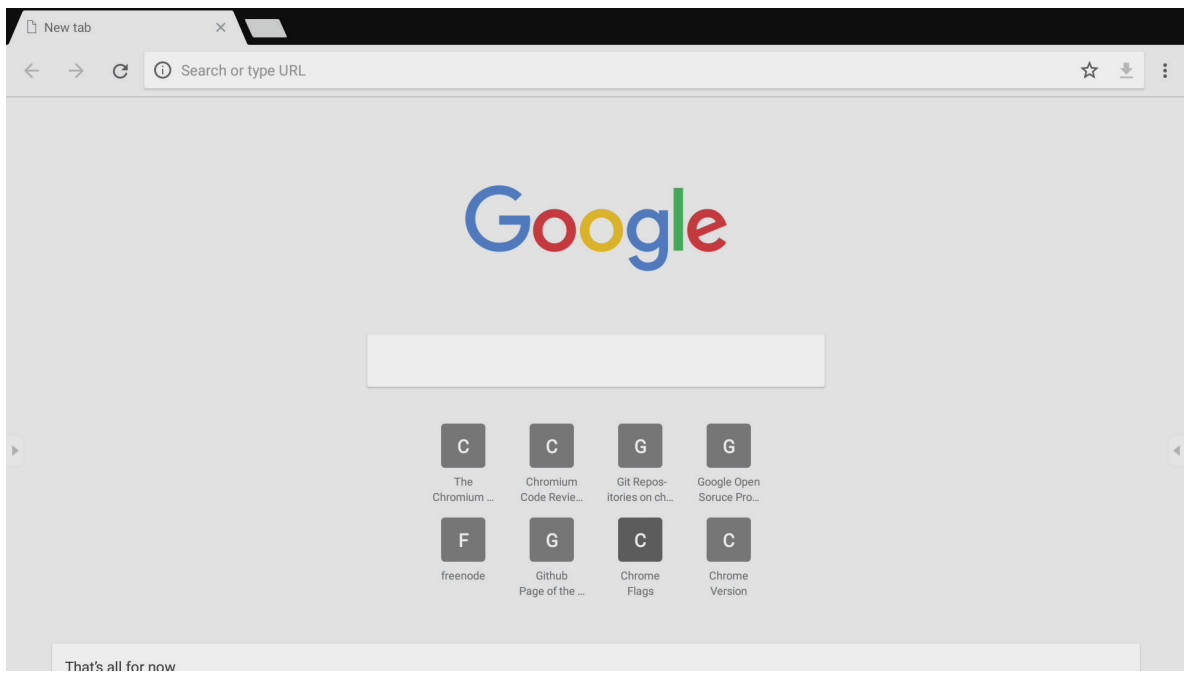

Folders

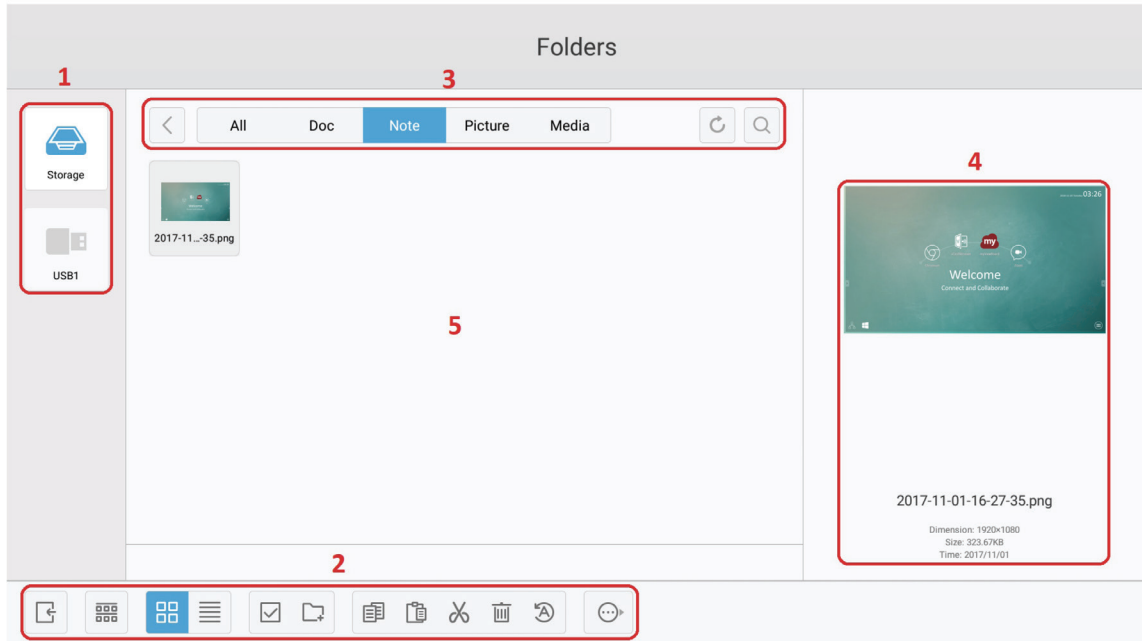

1. Storage Device Display

Select the appropriate storage device.

2. Icons

Item	Description
Exit	Click to exit.
Sort	Click to sort file.
Thumbnail	Click to display file by thumbnail mode.
List	Click to display file by list mode.
Select	Click to select file.
Add folder	Click to add folder.
Copy	Click to copy file.
Paste	Click to paste file.
Cut	Click to cut file.
Delete	Click to delete file.
Rename	Click to rename file.
More	Click to show more functions.

3. File Type Menu

Item	Description
All	All types
Doc	OFFICE files
Note	Image stored by vBoard Lite, Side Tool Bar, and remote control Screen Capture button.
Picture	Image files
Media	Audio and Video files

4. File Information

Preview the image, show the image's name, size, resolution, and creation date.

5. Main Display Area

Display files of corresponding type.

> RS-232 Protocol

This document describes the hardware interface spec and software protocols of RS232 interface communication between ViewSonic LFD and PC or other control units with RS232 protocol.

The protocol contains three command sections:

- Set-Function
- Get-Function
- Remote control pass-through mode

NOTE: Below, “PC” represents all the control units that can send or receive the RS232 protocol command.

Description

RS232 Hardware Specification

ViewSonic LFD communication port on the rear side:

1. Connector type: DSUB 9-Pin Male (or 3.5 mm barrel connector)
2. Use of crossover (null modem) cable for connection
3. Pin Assignment:

Female DSUB 9-Pin

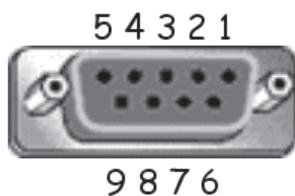

Male DSUB 9-Pin



3.5 mm barrel connector (alternative for limited space)



Pin #	Signal	Remark
1	NC	
2	RXD	Input to Display
3	TXD	Output from Display
4	NC	
5	GND	
6	NC	
7	NC	
8	NC	
9	NC	Provide +5V/2A power for external specific dongle *3.0
frame	GND	

Item	Signal	Remark
Tip	TXD	Output from Display
Ring	RXD	Input to Display
Sleeve	GND	

LAN Hardware Specification

ViewSonic LFD communication port on the rear side:

1. Connector type: 8P8C RJ45
2. Pin Assignment:

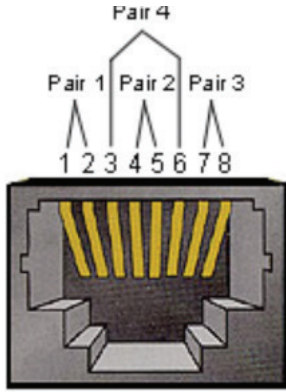

Pin #	Signal	Remark
1	TX+	Output from Display
2	TX-	Output from Display
3	RX+	Input to Display
4	BI_D3+	For 1G case
5	BI_D3-	For 1G case
6	RX-	Input to Display
7	BI_D4+	For 1G case
8	BI_D4-	For 1G case
frame	GND	

RS232 Communication Setting

- Baud Rate Select: 9600bps (fixed)
- Data bits: 8 bits (fixed)
- Parity: None (fixed)
- Stop Bits: 1(fixed)

LAN Communication Setting

- Type: Ethernet
- Protocol: TCP/IP
- Port: 5000 (fixed)
- Cross subnet: No
- Logon Credentials: No

Command Message Reference

PC sends to LFD command packet followed by “CR”. Every time PC sends control command to Display, the Display shall respond as follows:

1. If the message is received correctly it will send “+” (02Bh) followed by “CR” (00Dh)
2. If the message is received incorrectly it will send “-” (02Dh) followed by “CR” (00Dh)

Protocol

Set-Function Listing

The PC can control the Display for specific actions. The Set-Function command allows you to control the Display behavior at a remote site through the RS232 port. The Set-Function packet format consists of 9 bytes.

Set-Function Description:

- Length:** Total Byte of Message excluding "CR"
- LFD ID** Identification for each of Display (01~98; default is 01)
ID "99" means to apply the set command for all connected displays. Under such circumstances, only ID#1 display has to reply.
The LFD ID can be set via the OSD menu for each Display.
- Command Type** Identify command type,
"s" (0x73h): Set Command
"+" (0x2Bh): Valid command Reply
"- " (0x2Dh): Invalid command Reply
- Command:** Function command code: One byte ASCII code.
- Value[1~3]:** Three bytes ASCII that defines the value.
- CR** 0x0D

Set-Function Format

Send: (Command Type="s")

Name	Length	ID	Command Type	Command	Value1	Value2	Value3	CR
Byte Count	1 Byte	2 Byte	1 Byte	1 Byte	1 Byte	1 Byte	1 Byte	1 Byte
Bytes order	1	2~3	4	5	6	7	8	9

Reply: (Command Type="+" or "-")

Name	Length	ID	Command Type	CR
Byte Count	1 Byte	2 Byte	1 Byte	1 Byte
Bytes order	1	2~3	4	5

NOTE: When PC applies command to all displays (ID=99), only the #1 set needs to reply by the name of ID=1.

Example 1: Set Brightness as 76 for Display (#02) and this command is valid

Send (Hex Format)

Name	Length	ID	Command Type	Command	Value1	Value2	Value3	CR
Hex	0x38	0x30 0x32	0x73	0x24	0x30	0x37	0x36	0x0D

Reply (Hex Format)

Name	Length	ID	Command Type	CR
Hex	0x34	0x30 0x32	0x2B	0x0D

Example 2: Set Brightness as 75 for Display (#02) and this command is NOT valid

Send (Hex Format)

Name	Length	ID	Command Type	Command	Value1	Value2	Value3	CR
Hex	0x38	0x30 0x32	0x73	0x24	0x30	0x37	0x35	0x0D

Reply (Hex Format)

Name	Length	ID	Command Type	CR
Hex	0x34	0x30 0x32	0x2D	0x0D

Set-Function Table

A. Basic Function

Set Function	Length	ID	Command	Command		Value Range (Three ASCII bytes)	Comments
			Type (ASCII)	Code (ASCII)	Code (Hex)		
Power on/ off (standby)	8		s	!	21	000: STBY 001: ON	1. The Power-on via LAN control may work only under specific mode. To see display UG for details. *3.1.1 2. "WOL by MAC address" may available as alternative.*3.2.1
Input Select	8		s	"	22	000: TV 001: AV 002: S-Video 003: YPbPr 004: HDMI1 014: HDMI2 024: HDMI3 034: HDMI4 005: DVI 006: VGA1 016: VGA2 026: VGA3 007: Slot-in PC (OPS/SDM)/HDBT 008: Internal memory 009: DP 00A: Embedded/ Main (Android)	1. No need for USB 2. For the case of two more same sources, the 2nd digital is used to indicate the extension. 3. The HEX of 00A is 30 30 41.
Brightness	8		s	\$	24	000 ~ 100 900: Bright down (-1) 901: Bright up (+1) *3.1.1	
Backlight*3.2.0	8		A	B	42	000 ~ 100	1. For Android platform whose main mode is controlled by backlight and the other sources are controlled by brightness. 2. Derived from Color calibration. *3.2.0
Power lock	8		s	4	34	000: Unlock 001: Lock	*See note in details
Volume	8		s	5	35	000 ~ 100 900: Volume down(-1) 901:Volume up(+1)	
Mute	8		s	6	36	000: OFF 001: ON (mute)	

Button lock	8		s	8	38	000: Unlock 001: Lock	*See note in details
Menu lock	8		s	>	3E	000: Unlock 001: Lock	*See note in details
Number *3.1.1	8		s	@	40	000~009	
Key Pad *3.1.1	8		s	A	41	000: UP 001: DOWN 002: LEFT 003: RIGHT 004: ENTER 005: INPUT 006: MENU/(EXIT) 007: EXIT	
Remote Control	8		s	B	42	000: Disable 001: Enable 002: Pass through	Disable: RCU will be no function Enabled: RCU controls normally Pass through: Display will bypass the RC code to connected device via the RS232 port, but not react itself.
Restore default	8		s	~	7E	000	Recover to factory setting

NOTE:

1. Behavior at Lock Modes

Lock Mode	Behavior
Button Lock	<ol style="list-style-type: none"> Lock all buttons on the front panel and RCU, except for "Power" All the SET functions should be workable via RS32, even the ones with according hot key in RCU like Mute,...etc.
MENU Lock	<ol style="list-style-type: none"> Lock "MENU" key of front panel and RCU The Factory and Hospitality modes should not be blocked for the model using MENU-combined key to enter these two modes. Alternative approach will be indicated separately if any limitation by model.
POWER Lock	<ol style="list-style-type: none"> Lock "POWER" key on the front and RCU. The SET_POWER on/off should be workable via RS232, but does not mean the POWER lock will be released under this case. Can not be unlocked by reset in OSD setting Will auto AC power-on in power-lock Under power-lock, the set will not enter power saving when no PC signal and neither not turn off when no other video signals after 15 minutes.
Remote control disable	Lock the RCU keys, but keep the front panel buttons workable.

2. Wake-on-LAN by MAC address as alternative for SET Power on

(Length=126 Bytes)

6 Bytes	6 Bytes (#1)	6 Bytes (#2)	...	6 Bytes (#16)	24 Bytes
0xFF FF ... FF	MAC address	MAC address	...	MAC address	0x00 00 ... 00

B. Optional Function

Set Function	Length	ID	Command		Value Range (Three ASCII bytes)	Comments	
			Type (ASCII)	Code (ASCII) Code (Hex)			
Contrast	8		s	#	23	000 ~ 100	
Sharpness	8		s	%	25	000 ~ 100	
Color	8		s	&	26	000 ~ 100	
Tint	8		s	'	27	000 ~ 100	
Backlight On_Off	8		s	(29	000: Off 001: On	
Color mode	8		s)	29	000: Normal 001: Warm 002: Cold 003: Personal	
Surround sound	8		s	-	2D	000: OFF 001: ON	
Bass	8		s	.	2E	000 ~ 100	
Treble	8		s	/	2F	000 ~ 100	
Balance	8		s	0	30	000 ~ 100	050 is central
Picture Size	8		s	1	31	000: FULL (16:9) 001: NORMAL (4:3) 002: REAL (1:1) *3.1.0	
OSD language	8		s	2	32	000: English 001: French 002: Spanish	Could be extended for more supported languages by model
PIP-Mode	8		s	9	39	000: OFF 001: PIP(POP) 002: PBP	
PIP-Sound select	8		s	:	3A	000: Main 001: Sub	
PIP-Position	8		s	;	3B	000: Up 001: Down 002: Left 003: Right	
PIP-Input	8		s	7	37 *2.9	000: TV 001: AV 002: S-Video 003: YPbPr 004: HDMI1 014: HDMI2 024: HDMI3 034: HDMI4 005: DVI 006: VGA1 016: VGA2 026: VGA3 007: Slot-in PC (OPS/SDM)/HDBT 008: Internal memory 009: DP 00A: Embedded/Main (Android)	Value range is same as SET-Input select

Tiling-Mode	8		s	P	50	000: OFF 001: ON	(for video wall)
Tiling-Compensation	8		s	Q	51	000: OFF 001: ON	(for video wall) Bezel width compensation
Tiling-H by V Monitors	8		s	R	52	01x~09x: H 0x1~0x9: V	(for video wall) 1. 2nd digital for H monitors 2. 3rd digital for V monitors
Tiling-Position	8		s	S	53	001~025	(for Video wall) Copy the screen of Position# to identified display
Date: Year	8		s	V	56	Y17~Y99	Last 2 digits (20)17~(20)99
Date: Month	8		s	V	56	M01~M12	2 digits
Date: Day	8		s	V	56	D01~D31	2 digits
Time: Hour	8		s	W	57	H00~H23	24-hr format. 2 digits.
Time: Min	8		s	W	57	M00~M59	2 digits
Time: Sec	8		s	W	57	S00~S59	2 digits

NOTE:

1. Tiling definition of H Monitors, V Monitors, and Position

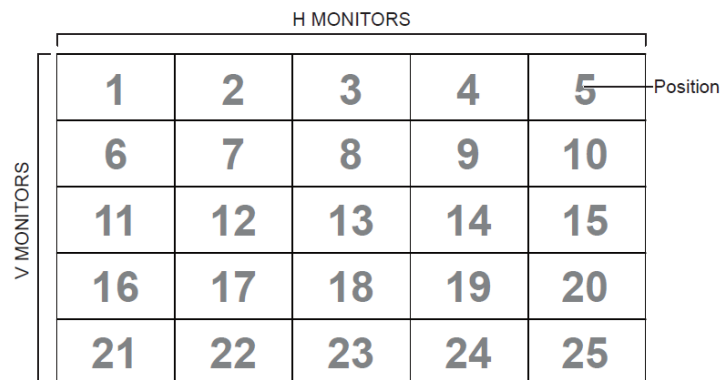

2. Set Date example

Date: 2017-3/15

Send: 0x 38 30 31 73 56 59 31 37 0D ("Y17")

Send: 0x 38 30 31 73 56 4D 30 33 0D ("M03")

Send: 0x 38 30 31 73 56 44 31 35 0D ("D15")

3. Set Time example

Time: 16:27:59

Send: 0x 38 30 31 73 57 48 31 36 0D ("H16")

Send: 0x 38 30 31 73 57 4D 32 37 0D ("M27")

Send: 0x 38 30 31 73 57 53 35 39 0D ("S59")

Get-Function Listing

The PC can interrogate the LFD for specific information. The Get-Function packet format consists of 9 bytes which is similar to the Set-Function packet structure. Note that the “Value” byte is always = 000.

Get-Function Description:

- Length:** Total Byte of Message excluding “CR”.
- TV/DS ID** Identification for each of TV/DS (01~98; default is 01).
- Command Type** Identify command type,
 “g” (0x67h) : Get Command
 “r” (0x72h) : Valid command Reply
 “-” (0x2Dh) : Invalid command Reply
- Command:** Function command code: One byte ASCII code.
- Value[1~3]:** Three bytes ASCII that defines the value.
- CR** 0x0D

Get-Function Format

Send: (Command Type=“g”)

Name	Length	ID	Command Type	Command	Value1	Value2	Value3	CR
Byte Count	1 Byte	2 Byte	1 Byte	1 Byte	1 Byte	1 Byte	1 Byte	1 Byte
Bytes order	1	2~3	4	5	6	7	8	9

Reply: (Command Type=“r” or “-”)

If the Command is valid, Command Type = “r”

Name	Length	ID	Command Type	Command	Value1	Value2	Value3	CR
Byte Count	1 Byte	2 Byte	1 Byte	1 Byte	1 Byte	1 Byte	1 Byte	1 Byte
Bytes order	1	2~3	4	5	6	7	8	9

If the Command is NOT valid, Command Type = “-”

Name	Length	ID	Command Type	CR
Byte Count	1 Byte	2 Byte	1 Byte	1 Byte
Bytes order	1	2~3	4	5

Example 1: Get Brightness from TV-05 and this command is valid. The Brightness value is 67.

Send (Hex Format)

Name	Length	ID	Command Type	Command	Value1	Value2	Value3	CR
Hex	0x38	0x30 0x35	0x67	0x62	0x30	0x30	0x30	0x0D

Reply (Hex Format)

Name	Length	ID	Command Type	Command	Value1	Value2	Value3	CR
Hex	0x38	0x30 0x35	0x72	0x62	0x30	0x36	0x37	0x0D

Example 2: Get Color from Display (#05), but the Color command is not supported by this model.

Send (Hex Format)

Name	Length	ID	Command Type	Command	Value1	Value2	Value3	CR
Hex	0x38	0x30 0x35	0x67	0x26	0x30	0x30	0x30	0x0D

Reply (Hex Format)

Name	Length	ID	Command Type	CR
Hex	0x34	0x30 0x35	0x2D	0x0D

Get-Function Table

A. Basic Function

Get Function	Length	ID	Command		Response Range	Comments
			Type (ASCII)	Code (ASCII) Code (Hex)		
Get-Brightness	8		g	b 62	000 ~ 100	
Get-Backlight*3.2.0	8		a	B 42	000 ~ 100	1. For Android platform whose main mode is controlled by backlight and the other sources are controlled by brightness. 2. Derived from Color calibration. *3.2.0
Get-Volume	8		g	f 66	000 ~ 100	
Get-Mute	8		g	g 67	000: Off 001: On (muted)	
Get-Input select	8		g	j 6A	000~ 100~	1. 1st digit for signal detection: 0 means "no signal"; 1 means "signal detected" 2. 2nd & 3rd digit: See Set-function table
Get-Power status: ON/ STBY	8		g	l 6C	001: ON 000: STBY	
Get-Remote control	S		g	n 6E	000: Disable 001: Enable 002: Pass through	Get RCU mode status
Get-Power lock	8		g	o 6F	000: Unlock 001: Lock	
Get-Button lock	8		g	p 70	000: Unlock 001: Lock	
Get-Menu lock	8		g	l 6C	000: Unlock 001: Lock	
Get-ACK	8		g	z 7A	000	This command is used to test the communication link
Get-Thermal	8		g	0 30	000~100: 0~+100 deg C -01~-99: -1~-99 deg C	
Get-Operation time*3.2.0	8		g	1 31	000	1. Accumulated hours in 6-digit integer (000,001~999,999)*3.2.0 2. Can not be reset when FW update and Factory initiation*3.2.2 3. Reply in new 32-byte format*3.2.0
Get-Device name	8		g	4 34	000	Reply in new 32-byte format *3.2.0

Get-MAC address	8		g	5	35	000	(for the model with LAN) Reply in new 32-byte format*3.2.0
Get-IP address *3.2.0	8		g	6	36	000	(for the model with LAN) Reply in new 32-byte format*3.2.0
Get-Serial number *3.2.0	8		g	7	37	000	Reply in new 32-byte format *3.2.0
Get-FW version *3.2.0	8		g	8	38	000	Reply in new 32-byte format *3.2.0

NOTE:

1. Get Operation Hour example

Assumed the accumulated operation hour is 123,456 hrs

Send: 0x 38 30 31 67 31 30 30 30 0D (Get Operation hour)

Reply: 0x 32 30 31 72 31 31 32 33 34 35 36 00 00 ... 00 00 0D

2. Get Device Name example

Assumed the device name is CDE-5500

Send: 0x 38 30 31 67 34 30 30 30 0D (Get Device Name)

Reply: 0x 32 30 31 72 34 43 44 45 2D 35 35 30 30 00 00 ... 00 00 0D

Assumed the device name is "NMP-302#1"

Send: 0x 38 30 31 67 34 30 30 30 0D (Get Device Name)

Reply: 0x 32 30 31 72 34 4E 4D 50 2D 33 30 32 23 31 00 00 ...00 00 0D

3. Get MAC address example

Assumed the MAC address is 00:11:22:aa:bb:cc

Send: 0x 38 30 31 67 35 30 30 30 0D (Get MAC add)

Reply: 0x 32 30 31 72 35 30 30 31 31 32 32 61 61 62 62 63 63 00 00...00 00 0D

4. Get IP address example

Assumed the IP address is 192.168.100.2

Send: 0x 38 30 31 67 36 30 30 30 0D (Get IP address)

Reply: 0x 32 30 31 72 36 31 39 32 2E 31 36 38 2E 31 30 30 2E 32 00 00...00 00 0D

5. Get Serial number example

Assumed the Serial number is ABC180212345

Send: 0x 38 30 31 67 37 30 30 30 0D (Get Serial number)

Reply: 0x 32 30 31 72 37 41 42 43 31 38 30 32 31 32 33 34 35 00 00...00 00 0D

6. Get FW version example

Assumed the FW version is 3.02.001

Send: 0x 38 30 31 67 38 30 30 30 0D (Get FW version)

Reply: 0x 32 30 31 72 38 33 2E 30 32 2E 30 30 31 00 00...00 00 0D

B. Optional Function

Get Function	Length	ID	Command		Response Range	Comments
			Type (ASCII)	Code (ASCII) Code (Hex)		
Get-Contrast	8		g	a 61	000 ~ 100	
Get-Sharpness	8		g	c 63	000 ~ 100	
Get-Color	8		g	d 64	000 ~ 100	
Get-Tint	8		g	e 65	000 ~ 100	
Get-Backlight On_Off	8		g	h 68	000: Off 001: On	
Get-PIP mode	8		g	t 74	000: OFF 001: PIP (POP) 002: PBP	
Get-PIP input	8		g	u 75	000 ~	See Set-input select
Get-Tiling Mode	8		g	v 76	000: OFF 001: ON	(for Video wall)
Get-Tiling Compensation	8		g	w 77	000: OFF 001: ON	(for Video wall) Bezel width compensation
Get-Tiling H by V monitors	8		g	x 78	01x~09x: H monitors 0x1~0x9: V monitors	(for Video wall) 1. 2nd digital for H monitors 2. 3rd digital for V monitors
Get-Tiling position	8		g	y 79	000: OFF 001~025	(for Video wall) Copy the screen of Position# to identified display
Get-Date: Year	8		g	2 32	Y00~Y00	Last 2 digits (20)17~(20)99
Get-Date: Month	8		g	2 32	M00~M00	2 digits
Get-Date: Day	8		g	2 32	D00~M00	2 digits
Get-Time: Hour	8		g	3 33	H00~H00	24-hr format. 2 digits
Get-Time: Min	8		g	3 33	M00~M00	2 digits
Get-Time: Sec	8		g	3 33	S00~S00	2 digits

NOTE:

1. Get Date example

Assumed the current date of display#01 as below:

Date: 2017-3/15

Send: 0x 38 30 31 67 32 59 30 30 0D (Get Date:Year)

Reply: 0x 38 30 31 72 32 59 31 37 0D ("Y17")

Send: 0x 38 30 31 67 32 4D 30 30 0D (Get Date:Month)

Reply: 0x 38 30 31 72 32 4D 30 33 0D ("M03")

Send: 0x 38 30 31 67 32 44 30 30 0D (Get Date:Day)

Reply: 0x 38 30 31 72 32 44 31 35 0D ("D15")

2. Get Time example

Assumed the current time of display#01 as below:

Time: 16:27:59

Send: 0x 38 30 31 67 33 48 30 30 0D (Get Time:Hour)

Reply: 0x 38 30 31 72 33 48 31 36 0D ("H16")

Send: 0x 38 30 31 67 33 4D 30 30 0D (Get Time:Min)

Reply: 0x 38 30 31 72 33 4D 32 37 0D ("M27")

Send: 0x 38 30 31 67 33 53 30 30 0D (Get Time:Sec)

Reply: 0x 38 30 31 72 33 53 35 39 0D ("S59")

3. Get RS232 Version example

Assumed the version is 3.0.1

Send: 0x 38 30 31 67 36 30 30 30 0D (Get RS232 version)

Reply: 0x 38 30 31 72 36 33 30 31 0D ("301")

C. Auto Reply *3.2.1

The display will send out the updated data/status automatically without getting a query from the host whenever the following data/status is changed by the user through any of the available ways like: remote control unit, front keys, or touch screen.

- Power On/Off
- Input Select
- Brightness
- Backlight
- Volume
- Mute On/Off

Remote Control Pass-through Mode

When the PC sets the Display to Remote Control Pass through mode, the Display shall send a 7-byte packet (followed by “CR”) in response to remote control unit (RCU) button activation. In this mode the remote control shall have no effect on the Display function. For example: “Volume+” will not change the volume of the Display, but instead only sends the “Volume+” code to the PC over the RS232 port.

IR Pass Through-Function format

Reply: (Command Type=“p”)

Name	Length	ID	Command Type	RCU Code1 (MSB)	RCU Code2 (LSB)	CR
Byte Count	1 Byte	2 Byte	1 Byte	1 Byte	1 Byte	1 Byte
Bytes order	1	2~3	4	5	6	7

Example 1: Remote Control Pass-through when “VOL+” key is pressed for Display (#5)

Send (Hex Format)

Name	Length	ID	Command Type	RCU Code1 (MSB)	RCU Code2 (LSB)	CR
Hex	0x36	0x30 0x35	0x70	0x31	0x30	0x0D

Key	Code (HEX)	Basic *3.1.1	Optional *3.1.1
1	01	V	
2	02	V	
3	03	V	
4	04	V	
5	05	V	
6	06	V	
7	07	V	
8	08	V	
9	09	V	
0	0A	V	
-	0B		V
RECALL (LAST)	0C		V
INFO (DISPLAY)	0D		V
	0E		
ASPECT (ZOOM, SIZE)	0F		V
VOLUME UP (+)	10	V	

VOLUME DOWN (-)	11	V	
MUTE	12	V	
CHANNEL/PAGE UP (+)/ BRIGHTNESS+	13		V
CHANNEL/PAGE DOWN (-)/ BRIGHTNESS-	14		V
POWER	15	V	
SOURCES (INPUTS)	16	V	
	17		
	18		
SLEEP	19		V
MENU	1A	V	
UP	1B	V	
DOWN	1C	V	
LEFT (-)	1D	V	
RIGHT (+)	1E	V	
OK (ENTER, SET)	1F	V	
EXIT	20	V	
	21		
	22		
	23		
	24		
	25		
	26		
	27		
	28		
	29		
	2A		
	2B		
RED ■ (F1)	2C		
GREEN ■ (F2)	2D		
YELLOW ■ (F3)	2E		
BLUE ■ (F4)	2F		

NOTE:

1. This IR-pass-through code is different from the RCU key code.
2. Special control sequence for POWER key under IR-pass through mode.
- 2-1. When Display is OFF and receives the IR POWER code: Display will turn itself on, then forward the POWER code to the host via RS232.

- 2-2. When Display is ON and receives the IR POWER code: Display will forward the POWER code to the host via RS232, then turn off itself.
- 2-3. When SET-POWER LOCK is enabled, the Display will not respond to POWER key pressing.
3. The VOLUME UP and VOLUME DOWN code will repeatedly output when you press and hold the keys.

> Appendix

Specifications

Item	Category	Specifications
Model		IFP9850-3
Screen Size		97.52"
Input Signal		3 x HDMI 1 x VGA 1 x PC audio
Output Signal		1 x HDMI 1 x Earphone 1 x SPDIF
Speaker Output		12W x 2
RS232		RS232 Communication
Power	Voltage	100V-240V AC 50/60Hz
Operating Conditions	Temperature	32° F to 104° F (0° C to 40° C)
	Humidity	20%~80% non-condensing
	Altitude	≤ 2,000 m
Storage Conditions	Temperature	-4° F to 140° F (-20° C to 60° C)
	Humidity	10%~90% non-condensing
	Altitude	≤ 2,000 m
Dimensions	Physical (mm)	2245 x 1323 x 91
Weight	Physical (kg)	101.5
Power Consumption	On	171W
	Off	<0.5W

NOTE: Product specifications are subject to change without notice.

Display Modes

VGA Mode

Resolution	Refresh Rate (@)
640 x 480	60Hz, 72Hz, 75Hz
720 x 400	70Hz
800 x 600	56Hz, 60Hz, 72Hz, 75Hz
1024 x 768	60Hz, 70Hz, 75Hz
1152 x 864	60Hz, 75Hz
1152 x 870	75Hz
1280 x 768	60Hz, 75Hz
1280 x 960	60Hz
1280 x 1024	60Hz, 75Hz
1360 x 768	60Hz
1366 x 768	60Hz
1440 x 900	60Hz, 75Hz
1600 x 1200	60Hz
1680 x 1050	60Hz
1920 x 1080	60Hz
1920 x 1200	60Hz

HDMI Mode

Resolution	Refresh Rate (@)
640 x 480	60Hz, 72Hz
720 x 400	70Hz
800 x 600	60Hz, 72Hz
1024x768	60Hz, 70Hz, 75Hz
1280x800	60Hz
1280x1024	60Hz
1360x768	60Hz
1440x900	60Hz
1680x1050	60Hz
1920x1080	60Hz
3840x2160	30Hz, 60Hz
480i	60Hz
480p	59Hz, 60Hz
576i	50Hz
720p	50Hz, 60Hz
576p	50Hz
1080i	50Hz, 60Hz
1080p	50Hz, 60Hz

Troubleshooting

This section describes some common problems that you may experience when using the ViewBoard.

Problem or Issue	Possible Solutions
Remote Control is not working	<ol style="list-style-type: none">1. Check whether something is obstructing the display's remote control receiver.2. Check whether the batteries in the remote control are installed correctly.3. Check whether the batteries need to be replaced.
The unit turns off unexpectedly	<ol style="list-style-type: none">1. Check whether Sleep mode is enabled.2. Check if there is a power outage in your area.3. Turn on the display and see if the problem is with the signal and control system.

PC Mode

Problem or Issue	Possible Solutions
No PC signal	<ol style="list-style-type: none">1. Check the display settings.2. Check the display resolution.3. Adjust the Hs & Vs (synchronization) settings using the OSD menu.
Background streaking	<ol style="list-style-type: none">1. Choose auto adjust.2. Adjust clock and phase.
False color	<ol style="list-style-type: none">1. Check the VGA connection.2. Adjust the chroma, brightness, and contrast settings.
Unsupported format	<ol style="list-style-type: none">1. Choose auto adjust.2. Adjust clock and phase settings.

Touch Function

Problem or Issue	Possible Solutions
Touch function does not work	<ol style="list-style-type: none">1. Check that drivers are installed correctly.2. Reinstall driver(s).3. Check setup and align it.4. Check whether the touch pen is working properly.

Video Not Working Properly

Problem or Issue	Possible Solutions
No picture/ No sound	<ol style="list-style-type: none">1. Check the Power status.2. Check the signal cable.3. Check that the internal PC is installed correctly.
Picture is unclear or cuts in and out	<ol style="list-style-type: none">1. Check the signal cable.2. Check if other electronics are interrupting the signal.
Poor picture	<ol style="list-style-type: none">1. Adjust chroma, brightness, and contrast settings in the menu.2. Check the signal cable.

Audio Not Working Properly

Problem or Issue	Possible Solutions
No sound	<ol style="list-style-type: none">1. Press the Mute/Unmute button.2. Adjust the volume.3. Check the audio cable.
One speaker only	<ol style="list-style-type: none">1. Adjust the sound balance in the menu.2. Check the sound control panel settings of the computer.3. Check the audio cable.

Maintenance

General Precautions

- Make sure the device is turned off and the power cable is unplugged from the power outlet.
- Never spray or pour any liquid directly onto the screen or case.
- Handle the device with care, as a darker-colored device, if scuffed, may show marks more clearly than a lighter-colored device.
- Do not use the system continuously for long periods of time.

Cleaning the Screen

- Wipe the screen with a clean, soft, lint-free cloth. This removes dust and other particles.
- If the screen is still not clean, apply a small amount of non-ammonia, non-alcohol based glass cleaner onto a clean, soft, lint-free cloth; then wipe the screen.

Cleaning the Case

- Use a soft, dry cloth.
- If the case is still not clean, apply a small amount of non-ammonia, non-alcohol based, mild non-abrasive detergent onto a clean, soft, lint-free cloth, then wipe the surface.

Disclaimer

- ViewSonic® does not recommend the use of any ammonia or alcohol-based cleaners on the display screen or case. Some chemical cleaners have been reported to damage the screen and/or case of the device.
- ViewSonic® will not be liable for damage resulting from use of any ammonia or alcohol-based cleaners.

NOTE: If condensation appears between the glass and the panel, keep the display turned on until the moisture disappears.

> Regulatory and Service Information

Compliance Information

This section addresses all connected requirements and statements regarding regulations. Confirmed corresponding applications shall refer to nameplate labels and relevant markings on the unit.

FCC Compliance Statement

This device complies with part 15 of FCC Rules. Operation is subject to the following two conditions: (1) this device may not cause harmful interference, and (2) this device must accept any interference received, including interference that may cause undesired operation. This equipment has been tested and found to comply with the limits for a Class B digital device, pursuant to part 15 of the FCC Rules.

These limits are designed to provide reasonable protection against harmful interference in a residential installation. This equipment generates, uses, and can radiate radio frequency energy, and if not installed and used in accordance with the instructions, may cause harmful interference to radio communications. However, there is no guarantee that interference will not occur in a particular installation. If this equipment does cause harmful interference to radio or television reception, which can be determined by turning the equipment off and on, the user is encouraged to try to correct the interference by one or more of the following measures:

- Reorient or relocate the receiving antenna.
- Increase the separation between the equipment and receiver.
- Connect the equipment into an outlet on a circuit different from that to which the receiver is connected.
- Consult the dealer or an experienced radio/TV technician for help.

Warning: You are cautioned that changes or modifications not expressly approved by the party responsible for compliance could void your authority to operate the equipment.

Industry Canada Statement

CAN ICES-3 (B)/NMB-3(B)

CE Conformity for European Countries



The device complies with the EMC Directive 2014/30/EU and Low Voltage Directive 2014/35/EU.

The following information is only for EU-member states:

The mark shown to the right is in compliance with the Waste Electrical and Electronic Equipment Directive 2012/19/EU (WEEE). The mark indicates the requirement NOT to dispose of the equipment as unsorted municipal waste, but use the return and collection systems according to local law.



Declaration of RoHS2 Compliance

This product has been designed and manufactured in compliance with Directive 2011/65/EU of the European Parliament and the Council on restriction of the use of certain hazardous substances in electrical and electronic equipment (RoHS2 Directive) and is deemed to comply with the maximum concentration values issued by the European Technical Adaptation Committee (TAC) as shown below:

Substance	Proposed Maximum Concentration	Actual Concentration
Lead (Pb)	0.1%	< 0.1%
Mercury (Hg)	0.1%	< 0.1%
Cadmium (Cd)	0.01%	< 0.01%
Hexavalent Chromium (Cr6 ⁺)	0.1%	< 0.1%
Polybrominated biphenyls (PBB)	0.1%	< 0.1%
Polybrominated diphenyl ethers (PBDE)	0.1%	< 0.1%
Bis (2-ethylhexyl) phthalate (DEHP)	0.1%	< 0.1%
Butyl benzyl phthalate (BBP)	0.1%	< 0.1%
Dibutyl phthalate (DBP)	0.1%	< 0.1%
Diisobutyl phthalate (DIBP)	0.1%	< 0.1%

Certain components of products as stated above are exempted under the Annex III of the RoHS2 Directives as noted below:

- Copper alloy containing up to 4% lead by weight.
- Lead in high melting temperature type solders (i.e. lead-based alloys containing 85% by weight or more lead).
- Electrical and electronic components containing lead in a glass or ceramic other than dielectric ceramic in capacitors, e.g. piezoelectronic devices, or in a glass or ceramic matrix compound.
- Lead in dielectric ceramic in capacitors for a rated voltage of 125V AC or 250V DC or higher.

ENERGY STAR statement

ENERGY STAR is a U.S. Environmental Protection Agency voluntary program that helps businesses and individuals save money and protect our climate through superior energy efficiency. Products that earn the ENERGY STAR prevent greenhouse gas emissions by meeting strict energy efficiency criteria or requirements set by the U.S. Environmental Protection Agency.

As an ENERGY STAR Partner, ViewSonic is determined to meet the Energy star Guidelines and mark all certified models with the ENERGY STAR logo.

The following logo appears on all ENERGY STAR-certified models:



NOTE: The power management features significantly reduce energy consumption when the product is not in use. Power management allows the device to automatically enter a low power “sleep” mode after a defined period of inactivity. And the power management features also enter Sleep Mode or Off Mode within 5 minutes of being disconnected from a host computer. Please note any change in energy settings will increase energy consumption.

Indian Restriction of Hazardous Substances

Restriction on Hazardous Substances statement (India). This product complies with the “India E-waste Rule 2011” and prohibits use of lead, mercury, hexavalent chromium, polybrominated biphenyls or polybrominated diphenyl ethers in concentrations exceeding 0.1 weight % and 0.01 weight % for cadmium, except for the exemptions set in Schedule 2 of the Rule.

Product Disposal at End of Product Life

ViewSonic® respects the environment and is committed to working and living green. Thank you for being part of Smarter, Greener Computing. Please visit the ViewSonic® website to learn more.

USA & Canada:

<http://www.viewsonic.com/company/green/recycle-program/>

Europe:

<http://www.viewsoniceurope.com/eu/support/call-desk/>

Taiwan:

<https://recycle.epa.gov.tw/>

Copyright Information

Copyright© ViewSonic® Corporation, 2019. All rights reserved.

Macintosh and Power Macintosh are registered trademarks of Apple Inc.

Microsoft, Windows, and the Windows logo are registered trademarks of Microsoft Corporation in the United States and other countries.

ViewSonic®, the three birds logo, OnView, ViewMatch, and ViewMeter are registered trademarks of ViewSonic® Corporation.

VESA is a registered trademark of the Video Electronics Standards Association. DPMS, DisplayPort, and DDC are trademarks of VESA.

Disclaimer: ViewSonic® Corporation shall not be liable for technical or editorial errors or omissions contained herein; nor for incidental or consequential damages resulting from furnishing this material, or the performance or use of this product.

In the interest of continuing product improvement, ViewSonic® Corporation reserves the right to change product specifications without notice. Information in this document may change without notice.

No part of this document may be copied, reproduced, or transmitted by any means, for any purpose without prior written permission from ViewSonic® Corporation.

Customer Service

For technical support or product service, see the table below or contact your reseller.

NOTE: You will need the product's serial number.

Country/ Region	Website	Country/ Region	Website
Asia Pacific & Africa			
Australia	www.viewsonic.com/au/	Bangladesh	www.viewsonic.com/bd/
中国 (China)	www.viewsonic.com.cn	香港 (繁體中文)	www.viewsonic.com/hk/
Hong Kong (English)	www.viewsonic.com/hk-en/	India	www.viewsonic.com/in/
Indonesia	www.viewsonic.com/id/	Israel	www.viewsonic.com/il/
日本 (Japan)	www.viewsonic.com/jp/	Korea	www.viewsonic.com/kr/
Malaysia	www.viewsonic.com/my/	Middle East	www.viewsonic.com/me/
Myanmar	www.viewsonic.com/mm/	Nepal	www.viewsonic.com/np/
New Zealand	www.viewsonic.com/nz/	Pakistan	www.viewsonic.com/pk/
Philippines	www.viewsonic.com/ph/	Singapore	www.viewsonic.com/sg/
臺灣 (Taiwan)	www.viewsonic.com/tw/	ประเทศไทย	www.viewsonic.com/th/
Việt Nam	www.viewsonic.com/vn/	South Africa & Mauritius	www.viewsonic.com/za/
Americas			
United States	www.viewsonic.com/us	Canada	www.viewsonic.com/us
Latin America	www.viewsonic.com/la		
Europe			
Europe	www.viewsonic.com/eu/	France	www.viewsonic.com/fr/
Deutschland	www.viewsonic.com/de/	Қазақстан	www.viewsonic.com/kz/
Россия	www.viewsonic.com/ru/	España	www.viewsonic.com/es/
Türkiye	www.viewsonic.com/tr/	Україна	www.viewsonic.com/ua/
United Kingdom	www.viewsonic.com/uk/		

Limited Warranty

ViewSonic® Smart White Board

What the warranty covers:

ViewSonic® warrants its products to be free from defects in material and workmanship during the warranty period. If a product proves to be defective in material or workmanship during the warranty period, ViewSonic® will, at its sole option, and as your sole remedy, repair or replace the product with a similar product. Replacement Product or parts may include remanufactured or refurbished parts or components. The repair or replacement unit or parts or components will be covered by the balance of the time remaining on the customer's original limited warranty and the warranty period will not be extended. ViewSonic® provides no warranty for any third-party software whether included with the product or installed by the customer, installation of any unauthorized hardware parts or components (e.g. Projector Lamps). (Please refer to: "What the warranty excludes and does not cover" section).

Who the warranty protects:

This warranty is valid only for the first consumer purchaser.

What the warranty excludes and does not cover:

- Any product on which the serial number has been defaced, modified, or removed.
- Damage, deterioration, or malfunction resulting from:
 - » Accident, misuse, neglect, fire, water, lightning, or other acts of nature, unauthorized product modification, or failure to follow instructions supplied with the product.
 - » Repair or attempted repair by anyone not authorized by ViewSonic®.
 - » Damage to or loss of any programs, data, or removable storage media.
 - » Normal wear and tear.
 - » Removal or installation of the product.
- Software or data loss occurring during repair or replacement.
- Any damage of the product due to shipment.
- Causes external to the product, such as electric power fluctuations or failure.
- Use of supplies or parts not meeting ViewSonic's specifications.
- Failure of owner to perform periodic product maintenance as stated in the User Guide.
- Any other cause which does not relate to a product defect.

- Damage caused by static (non-moving) images displayed for lengthy periods of time (also referred to as image burn-in).
- Software - Any third-party software included with the product or installed by the customer.
- Hardware/Accessories/Parts/Components – Installation of any unauthorized hardware, accessories, consumable parts or components (e.g. Projector Lamps).
- Damage to, or abuse of, the coating on the surface of the display through inappropriate cleaning as described in the product User Guide.
- Removal, installation, and set-up service charges, including wall-mounting of the product.

How to get service:

- For information about receiving service under warranty, contact ViewSonic® Customer Support (Please refer to the “Customer Service” page). You will need to provide your product’s serial number.
- To obtain warranty service, you will be required to provide: (a) the original dated sales slip, (b) your name, (c) your address, (d) a description of the problem, and (e) the serial number of the product.
- Take or ship the product, freight prepaid, in the original container to an authorized ViewSonic® service center or ViewSonic®.
- For additional information or the name of the nearest ViewSonic® service center, contact ViewSonic®.

Limitation of implied warranties:

There are no warranties, express or implied, which extend beyond the description contained herein including the implied warranty of merchantability and fitness for a particular purpose.

Exclusion of damages:

ViewSonic's liability is limited to the cost of repair or replacement of the product. ViewSonic® shall not be liable for:

- Damage to other property caused by any defects in the product, damages based upon inconvenience, loss of use of the product, loss of time, loss of profits, loss of business opportunity, loss of goodwill, interference with business relationships, or other commercial loss, even if advised of the possibility of such damages.
- Any other damages, whether incidental, consequential or otherwise.
- Any claim against the customer by any other party.
- Repair or attempted repair by anyone not authorized by ViewSonic®.

Effect of state law:

This warranty gives you specific legal rights, and you may also have other rights which vary from state to state. Some states do not allow limitations on implied warranties and/or do not allow the exclusion of incidental or consequential damages, so the above limitations and exclusions may not apply to you.

Sales outside the U.S.A. and Canada:

For warranty information and service on ViewSonic® products sold outside of the U.S.A. and Canada, contact ViewSonic® or your local ViewSonic® dealer.

The warranty period for this product in mainland China (Hong Kong, Macao, and Taiwan Excluded) is subject to the terms and conditions of the Maintenance Guarantee Card.

For users in Europe and Russia, full details of warranty provided can be found at: <http://www.viewsonic.com/eu/> under "Support/Warranty Information".

Mexico Limited Warranty

ViewSonic® Smart White Board

What the warranty covers:

ViewSonic® warrants its products to be free from defects in material and workmanship, under normal use, during the warranty period. If a product proves to be defective in material or workmanship during the warranty period, ViewSonic® will, at its sole option, repair or replace the product with a like product. Replacement product or parts may include remanufactured or refurbished parts or components & accessories.

Who the warranty protects:

This warranty is valid only for the first consumer purchaser.

What the warranty excludes and does not cover:

- Any product on which the serial number has been defaced, modified or removed.
- Damage, deterioration, or malfunction resulting from:
 - » Accident, misuse, neglect, fire, water, lightning, or other acts of nature, unauthorized product modification, unauthorized attempted repair, or failure to follow instructions supplied with the product.
 - » Causes external to the product, such as electrical power fluctuations or failure.
 - » Use of supplies or parts not meeting ViewSonic®'s specifications.
 - » Normal wear and tear.
 - » Any other cause which does not relate to a product defect.
- Any product exhibiting a condition commonly known as “image burn-in” which results when a static image is displayed on the product for an extended period of time.
- Removal, installation, insurance, and set-up service charges.

How to get service:

For information about receiving service under warranty, contact ViewSonic® Customer Support (Please refer to the attached “Customer Service” page). You will need to provide your product’s serial number, so please record the product information in the space provided below on your purchase for your future use. Please retain your receipt of proof of purchase to support your warranty claim.

For Your Records

Product Name: _____ Model Number: _____
Document Number: _____ Serial Number: _____
Purchase Date: _____ Extended Warranty Purchase? _____(Y/N)
If so, what date does warranty expire? _____

- To obtain warranty service, you will be required to provide (a) the original dated sales slip, (b) your name, (c) your address, (d) a description of the problem, and (e) the serial number of the product.
- Take or ship the product, in the original container packaging, to an authorized ViewSonic® service center.
- Round trip transportation costs for in-warranty products will be paid by ViewSonic®.

Limitation of implied warranties:

There are no warranties, express or implied, which extend beyond the description contained herein including the implied warranty of merchantability and fitness for a particular purpose.

Exclusion of damages:

ViewSonic®’s liability is limited to the cost of repair or replacement of the product. ViewSonic® shall not be liable for:

- Damage to other property caused by any defects in the product, damages based upon inconvenience, loss of use of the product, loss of time, loss of profits, loss of business opportunity, loss of goodwill, interference with business relationships, or other commercial loss, even if advised of the possibility of such damages.
- Any other damages, whether incidental, consequential or otherwise.
- Any claim against the customer by any other party.
- Repair or attempted repair by anyone not authorized by ViewSonic®.

Contact Information for Sales & Authorized Service (Centro Autorizado de Servicio) within Mexico:	
Name, address, of manufacturer and importers: México, Av. de la Palma #8 Piso 2 Despacho 203, Corporativo Interpalmas, Col. San Fernando Huixquilucan, Estado de México Tel: (55) 3605-1099 http://www.viewsonic.com/la/soporte/index.htm	
NÚMERO GRATIS DE ASISTENCIA TÉCNICA PARA TODO MÉXICO: 001.866.823.2004	
Hermosillo: Distribuciones y Servicios Computacionales SA de CV. Calle Juarez 284 local 2 Col. Bugambilias C.P: 83140 Tel: 01-66-22-14-9005 E-Mail: disc2@hmo.megared.net.mx	Villahermosa: Compumantenimientos Garantizados, S.A. de C.V. AV. GREGORIO MENDEZ #1504 COL, FLORIDA C.P. 86040 Tel: 01 (993) 3 52 00 47 / 3522074 / 3 52 20 09 E-Mail: compumantenimientos@prodigy.net.mx
Puebla, Pue. (Matriz): RENTA Y DATOS, S.A. DE C.V. Domicilio: 29 SUR 721 COL. LA PAZ 72160 PUEBLA, PUE. Tel: 01(52).222.891.55.77 CON 10 LINEAS E-Mail: datos@puebla.megared.net.mx	Veracruz, Ver.: CONEXION Y DESARROLLO, S.A DE C.V. Av. Americas # 419 ENTRE PINZÓN Y ALVARADO Fracc. Reforma C.P. 91919 Tel: 01-22-91-00-31-67 E-Mail: gacosta@qplus.com.mx
Chihuahua: Soluciones Globales en Computación C. Magisterio # 3321 Col. Magisterial Chihuahua, Chih. Tel: 4136954 E-Mail: Cefeo@soluglobales.com	Cuernavaca: Compusupport de Cuernavaca SA de CV Francisco Leyva # 178 Col. Miguel Hidalgo C.P. 62040, Cuernavaca Morelos Tel: 01 777 3180579 / 01 777 3124014 E-Mail: aquevedo@compusupportcva.com
Distrito Federal: QPLUS, S.A. de C.V. Av. Coyoacán 931 Col. Del Valle 03100, México, D.F. Tel: 01(52)55-50-00-27-35 E-Mail : gacosta@qplus.com.mx	Guadalajara, Jal.: SERVICRECE, S.A. de C.V. Av. Niños Héroes # 2281 Col. Arcos Sur, Sector Juárez 44170, Guadalajara, Jalisco Tel: 01(52)33-36-15-15-43 E-Mail: mmiranda@servicrece.com
Guerrero Acapulco: GS Computación (Grupo Sesicomp) Progreso #6-A, Colo Centro 39300 Acapulco, Guerrero Tel: 744-48-32627	Monterrey: Global Product Services Mar Caribe # 1987, Esquina con Golfo Pérsico Fracc. Bernardo Reyes, CP 64280 Monterrey N.L. México Tel: 8129-5103 E-Mail: aydeem@gps1.com.mx
MERIDA: ELECTROSER Av Reforma No. 403Gx39 y 41 Mérida, Yucatán, México CP97000 Tel: (52) 999-925-1916 E-Mail: rrrb@sureste.com	Oaxaca, Oax.: CENTRO DE DISTRIBUCION Y SERVICIO, S.A. de C.V. Murguía # 708 P.A., Col. Centro, 68000, Oaxaca Tel: 01(52)95-15-15-22-22 Fax: 01(52)95-15-13-67-00 E-Mail: gpotai2001@hotmail.com
Tijuana: STD Av Ferrocarril Sonora #3780 L-C Col 20 de Noviembr Tijuana, Mexico	FOR USA SUPPORT: ViewSonic® Corporation 381 Brea Canyon Road, Walnut, CA. 91789 USA Tel: 800-688-6688 E-Mail: http://www.viewsonic.com



ViewSonic®