



User's Manual

1. Usage Notice

2. Introduction

3. Basic Operations

4. User Settings

5. LAN Control

6. Troubleshooting

7. Replacing the lamp

8. Appendices

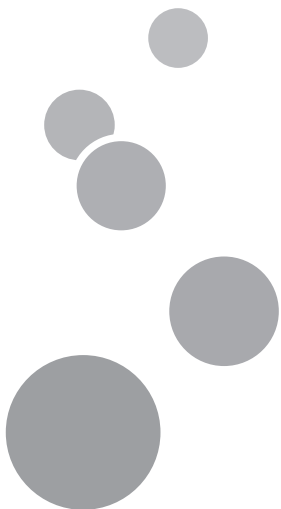

Read this manual carefully before you use this machine and keep it handy for future reference. For safe and correct use, be sure to read the Precautions in this manual before using the machine.



Table of Contents

Table of Contents	1	<i>OPTIONS</i>	51
Usage Notice	2	<i>3D</i>	55
<i>Precautions</i>	2	LAN Control	56
<i>Safety Labels of This Machine</i>	12	<i>Controlling this Device with Web</i>	
<i>Regulation & Safety Notices</i>	13	<i>Browser</i>	56
<i>Other Information</i>	18	<i>Connecting to the device</i>	56
Introduction	19	<i>Log in</i>	57
<i>Product Features</i>	19	<i>System Status</i>	58
<i>Package Overview</i>	20	<i>Control</i>	59
<i>Product Overview</i>	21	<i>Network Settings</i>	61
<i>Connection Ports</i>	22	<i>Alert Settings</i>	62
<i>Control Panel</i>	23	<i>Crestron</i>	63
<i>LED Indicators</i>	24	<i>Crestron Tools</i>	64
<i>Remote Control</i>	25	<i>Crestron Info</i>	64
<i>Remote Control Battery Installation</i>	27	<i>Contacting the IT administrator of</i>	
<i>Remote Control Operating Range</i>	28	<i>Crestron</i>	65
Basic Operations	29	<i>Reset to Default</i>	65
<i>Connecting the Projector</i>	29	<i>Reboot System</i>	66
<i>Connect to Computer/Notebook</i>	29	<i>Controlling the Device via the Projector</i>	
<i>Connect to AV Equipment</i>	30	<i>Management Utility</i>	67
<i>Powering On/Off the Projector</i>	31	<i>Projector management utility</i>	67
<i>Powering On the Projector</i>	31	<i>Installing the projector management</i>	
<i>Powering Off the Projector</i>	32	<i>utility</i>	67
<i>Warning Indicator</i>	33	<i>Registering a projector</i>	68
<i>Adjusting the Projected Image</i>	34	<i>Controlling the projector with the projector</i>	
<i>Adjusting the Position of Projector</i>		<i>management utility</i>	71
<i>Image</i>	34	<i>Controlling the projector with the projector</i>	
<i>Adjusting the Projection Position using</i>		<i>management utility via PJ Link</i>	73
<i>Lens Shift</i>	35	Troubleshooting	76
<i>Adjusting the Projector Zoom and</i>		Replacing the lamp	81
<i>Focus</i>	36	Appendices	82
<i>Adjusting Projection Image Size</i>	36	<i>List of Compatible Signals</i>	82
User Settings	38	<i>Configurations of Terminals</i>	87
<i>Using the On Screen Display (OSD)</i>	38	<i>Terminal: Computer In 1/2 (Mini D-sub</i>	
<i>How to operate</i>	38	<i>15 pin) [Monitor Out]</i>	87
<i>PICTURE</i>	39	<i>Terminal: PC Control (D-sub 9 pin)</i>	87
<i>SCREEN</i>	41	<i>Terminal: VESA 3D sync</i>	88
<i>SETTING</i>	46	<i>Specifications</i>	89
<i>VOLUME</i>	50	<i>Cabinet Dimensions</i>	90
		<i>Trademarks</i>	91

Usage Notice

Precautions



Follow all warnings, precautions and maintenance as recommended in this user's guide to maximize the life of your unit.

- **Warning-** **Indicates a potentially hazardous situation which, if instructions are not followed, could result in death or serious injury.**
- **Caution-** **Indicates a potentially hazardous situation which, if instructions are not followed, may result in minor or moderate injury or damage to property.**

- **Warning-** Do not place vases, plant pots, cups, toiletries, medicines, small metal objects, or containers holding water or any other liquids, on or close to this machine. Fire or electric shock could result from spillage or if such objects or substances fall inside this machine
- **Warning-** Keep the machine and attachments out of the reach of children. If the machine is near children, it may cause injury.
- **Warning-** Plastic bags can be dangerous, please do not leave near babies and young children. To avoid the threat of suffocation, please keep away from their nose and mouth.
- **Warning-** Do not use any power sources other than those that match the specifications shown in this manual. Doing so could result in fire or electric shock.
- **Warning-** Do not damage, break, or modify the power cord. Also, do not place heavy objects on the power cord, or pull the cord or bend it severely. Doing so could result in fire or electric shock.
- **Warning-** Touching the prongs of the power cable's plug with anything metallic constitutes a fire and electric shock hazard.
- **Warning-** The supplied power cord is for use with this machine only. Do not use it with other appliances. Doing so could result in fire or electric shock.
- **Warning-** It is dangerous to handle the power cord plug with wet hands. Doing so could result in electric shock.

Usage Notice

- **Warning-** Be sure to disconnect the plug from the wall outlet at least once a year and check for the following:
 - There are burn marks on the plug.
 - The prongs on the plug are deformed.If any of the above conditions exist, do not use the plug and consult your dealer or service representative. Use of the plug could result in fire or electric shock.
- **Warning-** Be sure to disconnect the power cord from the wall outlet at least once a year and check for the following:
 - The power cord's inner wires are exposed, broken, etc.
 - The power cord's coating has a crack or dent.
 - When bending the power cord, the power turns off and on.
 - Part of the power cord becomes hot.
 - The power cord is damaged.If any of the above conditions exist, do not use the power cord and consult your dealer or service representative. Use of the power cord could result in fire or electric shock.
- **Warning-** Do not use the connection cable if it is deformed, cracked, or damaged. Doing so could result in fire or electric shock. If the connection cable is deformed, cracked, or damaged, contact your service representative to request a replacement cable.
- **Warning-** When using an extension cord or power strip, only connect equipment whose total power consumption is within the power rating for the extension cord or power strip. If the power rating is exceeded, it may cause heat buildup and result in fire.
- **Warning-** Plastic bags can be dangerous, please do not leave near babies and young children. To avoid the threat of suffocation, please keep away from their nose and mouth.
- **Warning-** If the machine emits smoke or odours, or if it behaves unusually, you must turn off its power immediately. After turning off the power, be sure to disconnect the power cord plug from the wall outlet. Then contact your service representative and report the problem. Do not use the machine. Doing so could result in fire or electric shock.
- **Warning-** If metal objects, or water or other fluids fall inside this machine, you must turn off its power immediately.

Usage Notice

- After turning off the power, be sure to disconnect the power cord plug from the wall outlet. Then contact your service representative and report the problem. Do not use the machine. Doing so could result in fire or electric shock.
- Warning- Never operate this unit on AC power during a thunderstorm. If you see lightning or hear thunder, never touch the unit, cables and/or peripherals. An electric surge caused by the storm, may result in an electrical shock or damage to the unit.
 - Warning- If the machine topples, or if a cover or other part gets broken, you must turn off its power immediately. After turning off the power, be sure to disconnect the power cord plug from the wall outlet. Then contact your service representative and report the problem. Do not use the machine. Doing so could result in fire or electric shock.
 - Warning- Do not use lens cap when projector is powered on
 - Warning- Never push objects of any kind into this product through openings as they may touch dangerous voltage points or short-out parts that could result in a fire or electric shock. Never spill liquid of any kind on the product.
 - Warning- Do not place or keep the projector within the reach of the children. It may fall or tip over, possibly causing serious injury
 - Warning- Do not remove any covers or screws that are not mentioned in this manual. There are high voltage components inside the machine that may cause electric shock. Contact your service representative if any of the machine's internal components require maintenance, adjustment, or repair.
 - Warning- Do not disassemble or modify the machine. Doing so may cause injury or malfunction.
 - Warning- Installing the Projector on a Wall or Ceiling:
 - a) Do not attempt to clean or replace parts for a machine that is installed in a high location on a wall or ceiling. Doing so may cause it to fall down, resulting in an injury.
 - b) Do not open the lamp cover of a machine that is installed on a wall or ceiling. Doing so may cause the lamp cover to fall down. If the lamp is broken, pieces of glass may fall and cause an injury.

Usage Notice

- c) Contact your sales or service representative to clean or replace parts for a machine that is installed on a wall or ceiling.
- d) If a machine is incorrectly installed on a wall or ceiling, it may fall down and cause an injury. Contact your sales or service representative if you want to install a machine on a wall or ceiling.
- e) Do not obstruct the machine's vents. Doing so risks fire caused by overheated internal components.
- f) For users, do not install the projector by yourself. Contact your sales or service representative if you want to install the projector on a wall or ceiling.
- g) For sales or service representatives:
 - Use brackets that are strong enough to support the projector.
 - * PJ X5580/WU5570 Series weighs less than 6.35kg.
 - The projector must be installed in a location that is sturdy enough to support the full weight of the projector and brackets.
 - Use only the screws (three M4~16 screws) provided with the projector to attach the brackets to the projector.

- Caution- Keep the machine away from humidity and dust. Otherwise a fire or an electric shock might occur.
- Caution- Do not place any objects on the machine. Doing so may cause the machine to topple over, possibly resulting in injury.
- Caution- Do not place the machine on an unstable or tilted surface. If it topples over, an injury might occur.
- Caution- Do not place the machine or use it in an environment where it might get wet such as from snow, rain, or being near water. Doing so could result in fire or electric shock.
- Caution- Do not put your face or hand near the exhaust vents. Doing so could result in burns or an accident due to hot air coming from the exhaust vents.
- Caution- Do not use the machine on soft material such as paper or cloth that might get sucked into the intake vents. Doing so may cause heat buildup inside the machine, resulting in malfunction, burns, or fire.
- Caution- Do not place the machine in a location where air flow is poor. Doing so may cause fire due to internal com-

Usage Notice

- Caution- components becoming overheated.
Do not place or store the machine in a location where direct sunlight or heat generation might occur. The heat may deform or wear out the exterior parts or negatively affect internal parts. Doing so could result in fire.
- Caution- Do not place low heat resistant material near the exhaust vents. Hot air may come from the exhaust vents, resulting in damage to the machine or an accident.
- Caution- Do not obstruct the machine's vents. Doing so risks fire caused by overheated internal components.
- Caution- Push the power plug all the way into the power outlet. Do not use a power outlet with a loose connection. Doing so may result in heat buildup. Plug the power cord in the correct direction into the base. If they are not plugged in correctly, it could result in smoke, fire, or electric shock.
- Caution- If this machine is not going to be used for several days or longer at a time, disconnect its power cord from the wall outlet.
- Caution- When disconnecting the power cord from the wall outlet, always pull the plug, not the cord. Pulling the cord can damage the power cord. Use of damaged power cords could result in fire or electric shock.
- Caution- Be sure to disconnect the plug from the wall outlet and clean the prongs and the area around the prongs at least once a year. Allowing dust to build up on the plug constitutes a fire hazard.
- Caution- When performing maintenance on the machine, always disconnect the power cord from the wall outlet.
- Caution- Do not place the power cord and connection cable in a way that might cause someone to trip and fall. The machine might fall over and cause an injury.
- Caution- The machine may be very hot after it is turned off, especially the vents and the lower part of the unit where the lamp is located. Avoid touching these areas. Doing so may result in burns.
- Caution- Do not place the machine on other equipment or vice versa. Doing so may cause heat buildup inside the machine or cause the other equipment to malfunction.
- Caution- Do not increase the volume unless you are listening while increasing the volume. Also, lower the volume before turning off the power, because a loud sound

Usage Notice

- may be emitted when the power is turned on and cause hearing damage.
- Caution- Do not tilt the machine horizontally more than ± 20 degrees. Doing so may cause the entrance of foreign objects in the housing of the machine which could result in fire or electric shock.
 - Caution- If the machine's interior is not cleaned regularly, dust will accumulate. Fire and breakdown can result from heavy accumulation of dust inside this machine. Contact your sales or service representative for details about and charges for cleaning the machine's interior.
 - Caution- Unplug the power cord from the wall outlet before you move the machine. While moving the machine, take care that the power cord is not damaged under the machine. Failing to take these precautions could result in fire or electric shock.
 - Caution- Do not use attachments not recommended by RICOH. Use of an incompatible attachments could cause hazards or damage to the product.
 - Caution- Unplug this product from the wall outlet and take the product to qualified service personnel if you encounter any of the following conditions:
 - a) The power supply cord or plug is damaged.
 - b) Liquid has been spilled, or objects have fallen into the product.
 - c) The product has been exposed to rain or water.
 - d) The product does not operate normally when following the operating instructions. Adjust only those controls that are covered by the operating instructions.
 - e) The product has been dropped or damaged in any way. (If the cabinet should break, please handle with care to avoid injury.)
 - Caution- This product incorporates glass components, including a lens and a lamp. If these should break, please handle with care to avoid injury and contact your sales representative for repair service. Avoid any broken pieces of glass since they may cause injury. In the unlikely event that the lamp ruptures, thoroughly clean the area around the projector and discard any edible items placed in that area since they may be contaminated.
 - Caution- Do not place anything in front of the lens while the projector is operating. Things placed in front of the

Usage Notice

- Caution- lens may overheat and burn or start a fire. Unauthorized substitutions may result in fire, electric shock, or other hazards. (Only the replacement of the lamp should be made by users.) Upon completion of any service or repairs to this product, ask the service technician to perform safety checks to verify that the product is in proper operating condition.
- Caution- Do not use the product in a closed installation location. Do not place the product in a box or in any other closed installation location. Otherwise it may overheat, which could result in a risk of fire

Usage Notice

ABOUT THE LAMP

- **Warning-** When the lamp reaches the end of its life, it will burn out and may make a loud popping sound. If this happens, the projector will not turn back on until the lamp module has been replaced. To replace the lamp, follow the procedures listed under “Replacing the Lamp”.
- **Warning-** Before replacing the lamp, turn off the power and wait at least one hour to allow the machine to cool completely. If it is not completely cool, you may burn or injure yourself due to the inside of the machine and lamp unit being hot. If you replace the lamp without unplugging the power cord from the power outlet, electric shock or explosion may occur.
- **Warning-** Be careful when handling the used lamp so that it does not break. If it breaks, it may cause injury.

- **Caution-** This projector will detect the life of the lamp itself. Be sure to change the lamp when it shows warning messages.
- **Caution-** The machine’s light uses a mercury vapor lamp that becomes high pressure when it is turned on. The lamp has the following characteristics, so be sure to handle it with care after understanding the contents. If the lamp explodes and you are either injured from broken pieces of glass, think you have gotten glass particles or mercury vapour in your eyes, or have inhaled glass particles or mercury vapour, contact a doctor immediately.
 - Deterioration or shock can cause the lamp’s life span to end or the lamp to explode. If the lamp explodes, it may make a big noise.
 - The time that it takes for the lamp to reach its life span or explode depends on each individual lamp and its operating conditions. It is possible that it might explode the first time it is used.
 - If you use the lamp past its replacement period, the possibility of explosion increases.
 - If the lamp explodes, broken glass pieces may be scattered around the inside of the machine and ejected from the vent or other opening.
 - If the lamp explodes, a very small amount of mer-

Usage Notice

cury vapor in the lamp tube and broken glass pieces may be ejected from the vents or other opening.

What to do if a lamp has exploded

If the lamp explodes, remove the power cord from the projector, leave the room while making sure it is thoroughly ventilated.

If the lamp explodes and you think that you have gotten glass particles or mercury vapor in your eyes or have inhaled either, contact a doctor immediately.

Clean up the area around the projector completely while being careful not to get injured from any broken glass pieces.

Throw away any food that was near the projector.

Ask your service representative to replace the lamp and inspect the projector.

Usage Notice

REMOTE CONTROL BATTERY

Warning

- Never throw batteries into a fire.

Using the batteries improperly may cause them to explode or leak and may result in serious injury. If battery-leaking fluid contacts skin, wash the fluid off immediately with clean water and consult a doctor. If the fluid spills on an instrument, avoid contact and wipe it off using tissue paper. Then dispose of the used tissue paper as flammable garbage after moistening the tissue with water.

- Keep new and used batteries away from children.

If the battery compartment does not close securely, stop using the product and keep it away from children. If you think batteries might have been swallowed or placed inside any part of the body, seek immediate medical attention.

Notes

- Be sure to use AAA (R03) size batteries.
- Dispose of batteries in a designated disposal area.
- Attention should be drawn to the environmental aspects of battery disposal.
- If the remote control does not operate correctly, or if the operating range becomes reduced, replace the batteries.
- Avoid contact with water or liquid.
- Do not expose the remote control to moisture or heat.
- Do not drop the remote control.
- If the batteries have leaked in the remote control, carefully wipe the case clean and install new batteries.
- Dispose of used batteries according to the instructions.
- The remote control may fail to operate if the infrared remote sensor is exposed to bright sunlight or fluorescent lighting.

Important:

Contents of this manual are subject to change without prior notice. In no event will the company be liable for direct, indirect, special, incidental, or consequential damages as a result of handling or operating this product.

Usage Notice

Safety Labels of This Machine

- 1 To replace the lamp, unplug the power cord and then wait for 60 minutes.
- 2 Do not place anything in front of the lens while the projector is operating. Things placed in front of the lens may overheat and burn or start a fire. If you want to temporarily stop the projected image, use the AV mute on the remote control or the keypad.
- 3 Do not look into the lens while the lamp is on. The strong light from the lamp may cause damage to your eyesight.
- 4 This product should be operated only from the type of power source which does not exceed the voltage range specified on the rating label and the power cord.

1

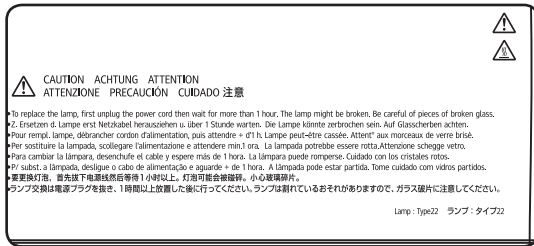

2



3

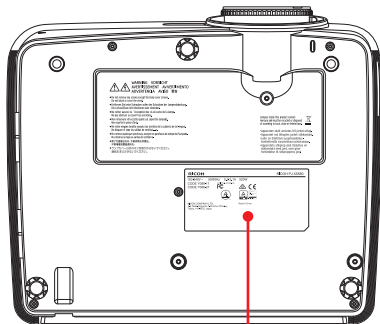

4

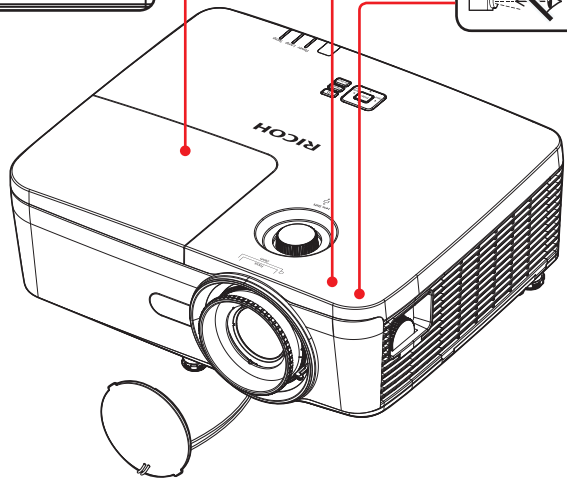

Regulation & Safety Notices

This appendix lists the general notices of your Projector.

Notice: Users in the United States of America ***FCC notice***

MODEL NAME: RICOH PJ X5580/WU5570

TRADE NAME: PROJECTOR MODEL NAME: RICOH PJ X5580/WU5570 Tested To Comply  With FCC Standards FOR HOME OR OFFICE USE
--

This device complies with Part 15 of the FCC Rules. Operation is subject to the following two conditions:

1. This device may not cause harmful interference and
2. This device must accept any interference received, including interference that may cause undesired operation.

This device has been tested and found to comply with the limits for a Class B digital device pursuant to Part 15 of the FCC rules. These limits are designed to provide reasonable protection against harmful interference in a residential installation. This device generates, uses and can radiate radio frequency energy and, if not installed and used in accordance with the instructions, may cause harmful interference to radio communications.

However, there is no guarantee that interference will not occur in a particular installation. If this device does cause harmful interference to radio or television reception, which can be determined by turning the device off and on, the user is encouraged to try to correct the interference by one or more of the following measures:

- Reorient or relocate the receiving antenna.
- Increase the separation between the device and receiver.
- Connect the device into an outlet on a circuit different from that to which the receiver is connected.
- Consult the dealer or an experienced radio/television technician for help.

Usage Notice

RESPONSIBLE PARTY: Ricoh Americas Corporation
5 Dedrick Place, West Caldwell, NJ 07006
Phone: 973-882-2000

Notice: Shielded cables

All connections to other computing devices must be made using shielded cables to maintain compliance with FCC regulations.

Caution

Changes or modifications not expressly approved by the manufacturer could void the user's authority, which is granted by the Federal Communications Commission, to operate this projector.

LAMP(S) INSIDE THIS PRODUCT CONTAIN MERCURY AND MUST BE RECYCLED OR DISPOSED OF ACCORDING TO LOCAL, STATE OR FEDERAL LAWS.

Notes to Users in the State of California

Perchlorate Material - special handling may apply, See www.dtsc.ca.gov/hazardouswaste/perchlorate.

WARNING: Handling the cord on this product will expose you to lead, a chemical known to the State of California to cause cancer, and birth defects or other reproductive harm.
Wash hands after handling.

Notes to Canadian Users

Remarques à l'attention des utilisateurs au Canada

Contains mercury / Contient du mercure

For more information on safe handling procedures, the measures to be taken in case of accidental breakage and safe disposal option visit:

www.ec.gc.ca/mercure-mercury

Dispose of or recycle in accordance with applicable laws.

Pour plus d'informations sur les procédures de manutention sécuritaire, les mesures à prendre en cas de bris accidentel et option d'élimination sécuritaire visitez:

www.ec.gc.ca/mercure-mercury/default.asp?lang=Fr&n=DB6D2996-1

Éliminez ou les recyclez conformément aux lois applicables.

Usage Notice

Declaration of Conformity for EU countries

- EMC Directive 2004/108/EC (including amendments)
- Low Voltage Directive 2006/95/EC

Notice: Users in EU countries

CE Marking Traceability Information (For EU Countries Only)

Manufacturer:
Ricoh Co., Ltd.
3-6 Nakamagome 1-chome, Ohta-ku, Tokyo. 143-8555,
Japan

Importer:
Ricoh Europe PLC
20 Triton Street, London. NW1 3BF, United Kingdom

User Information on Electrical and Electronic Equipment

Users in the countries where this symbol shown in this section has been specified in national law on collection and treatment of E-waste.

Our Products contain high quality components and are designed to facilitate recycling.

Our products or product packaging are marked with the symbol below.



This product contains substances which are harmful to humans and the environment.

Usage Notice

- The lamp contains mercury.

Please dispose of this product or used lamps in accordance with local regulations.

The symbol indicates that the product must not be treated as municipal waste. It must be disposed of separately via the appropriate return and collection systems available. By following these instructions you ensure that this product is treated correctly and help to reduce potential impacts on the environment and human health, which could otherwise result from inappropriate handling. Recycling of products helps to conserve natural resources and protect the environment.

For more detailed information on collection and recycling systems for this product, please contact the shop where you purchased it, your local dealer or sales/service representatives.

Notice: Users in Turkey

EEE Yönetmeliğine Uygundur.

Bu sistem sarf malzemeleri ve yedek parçaları da dahil olmak üzere EEE Yönetmeliğine Uygundur.

All Other Users

If you wish to discard this product, please contact your local authorities, the shop where you bought this product, your local dealer or sales/service representatives.

Usage Notice

Notice: Users in the EU

Note for the Battery and/or Accumulator Symbol



In accordance with the Battery Directive 2006/66/EC Article 20 Information for end-users Annex II, the above symbol is printed on batteries and accumulators. This symbol means that in the European Union, used batteries and accumulators should be disposed of separately from your household waste. In the EU, there are separate collection systems for not only used electrical and electronic products but also batteries and accumulators. Please dispose of them correctly at your local community waste collection/recycling centre.

Notice: Users in Taiwan



廢電池請回收

請勿將電池當作一般垃圾丟棄。這個標誌表示電池不應視為一般垃圾丟棄。僅適用於台灣。

Other Information

Copyrights to Images

When projecting images using the projector, be careful not to infringe the copyright of protected materials.

The following are examples that may infringe the copyright of protected materials.

- Broadcasting images or movies for commercial purposes
- Modifying images or movies using functions such as freeze, magnify, or zoom to broadcast images for commercial purposes or public viewing
- Varying the aspect ratio of images or movies using a function that changes the screen size to broadcast images for commercial purposes or public viewing

Note to Users Viewing 3D Images

Pay attention to the following points when viewing images using 3D glasses with projector:

- How 3D images are viewed may vary according to the individual.
- Do not use 3D glasses for viewing any material other than 3D images.
- Before viewing 3D images, make sure to read the manuals provided with your 3D glasses and 3D compatible content.
- Avoid viewing 3D images for a long period of time. Take a break of 15 minutes or longer after every hour of viewing.
- If you feel sick while viewing 3D images, stop viewing them. If you continue to feel sick, consult a doctor.
- When viewing 3D image in a room where on LED lighting system or fluorescent lights are used, you may feel that the light in the room flickers. If this is the case, dim the lights until you do not notice any flickers, or turn off the lights.
- If you or any member of your family has a history of light-sensitive seizures, consult a doctor before viewing 3D images.

Product Features

Outstanding features include:

- 1024x768(XGA) : X5580/1920x1200(WUXGA) : WU5570
- Weight <6.35kg(14lbs)
- Manual focus and 1.8X manual zoom
- Built-in full screen NTSC/PAL/SECAM video capability with S-video/Composite component through D-sub terminals
- UXGA / WXGA / Quad VGA / SXGA+ / SXGA / XGA / SVGA / VGA / MAC compatibility
- User friendly multilingual on screen display
- Automatic image resizing to 1024 x 768(XGA) / 1920 x 1200(WUXGA) and full screen

Introduction

Package Overview

This projector comes with all the items shown below. Check to make sure your unit is complete. Contact your dealer immediately if anything is missing.

Note

❖ Due to the difference in applications for each country, some regions may have different accessories.

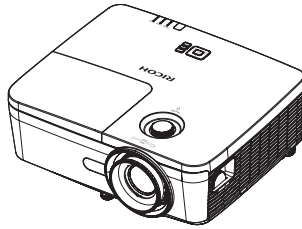

Projector



Lens Cap



Remote Control
(with Batteries,
please see page 27)

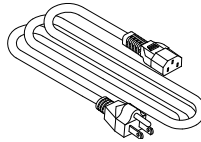

Power Cord

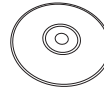

CD-ROM

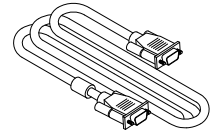

RGB Cable



Read This First

❖ About the CD-ROM

Contains the user's manual in PDF format and the projector management software.

Support languages of the user's manual are English, Japanese and Chinese. For the other languages, visit RICOH Web site.

Introduction

Product Overview

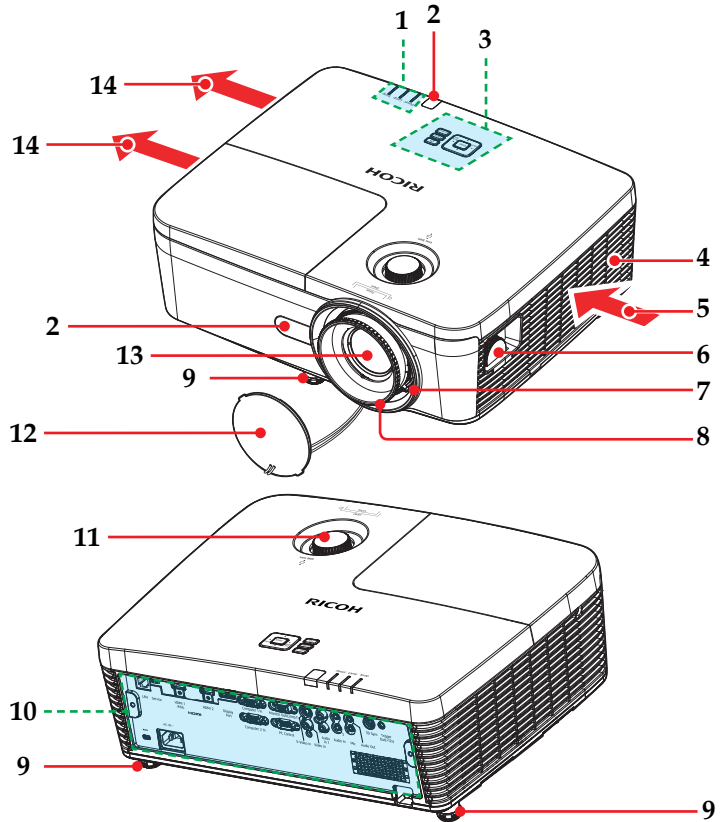

- | | |
|-------------------------------------|-----------------------------------|
| 1. LED indicators | 8. Focus ring |
| 2. Remote Receiver | 9. Adjustable feet |
| 3. Control panel | 10. Connection ports |
| 4. Filter | 11. Lens Shift lever
(up/down) |
| 5. Ventilation (inlet) | 12. Lens cap |
| 6. Lens Shift lever
(left/right) | 13. Lens |
| 7. Zoom lever | 14. Ventilation (outlet) |

Introduction

Connection Ports

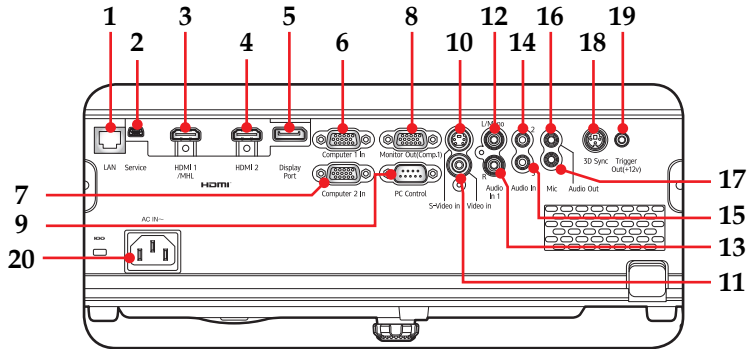

Note

❖ The interface is subject to model's specifications.

❖ When using Video or S-Video input source, connect the audio input cable to the Composite Audio Input (left & right) terminals.

❖ PC Control represents RS232 function, which utilize a PC to control the projector via RS232 command.

❖ Microphone jack supports $\Phi 3.5\text{mm}$ with general dynamic MIC. It does not support condenser MIC.

❖ Compatible with MHL version 2.2, the charging current $5\text{V}@0.9\text{A}$.

1. LAN terminal
2. Service terminal
3. HDMI 1/MHL In terminal
4. HDMI 2 In terminal
5. DisplayPort terminal
6. Computer 1 In terminal
7. Computer 2 In terminal
8. Monitor Out terminal
9. PC Control terminal
10. S-Video In terminal
11. Video In terminal
12. Audio In 1 terminal (Video and S-Video) Left/Mono
13. Audio In 1 terminal (Video and S-Video) Right
14. Audio In 2 terminal (Computer 1)
15. Audio In 3 terminal (Computer 2)
16. Audio Out terminal
17. Microphone jack
18. 3D Sync terminal
19. Trigger Out (+12v) terminal
20. AC In socket

Introduction

Control Panel

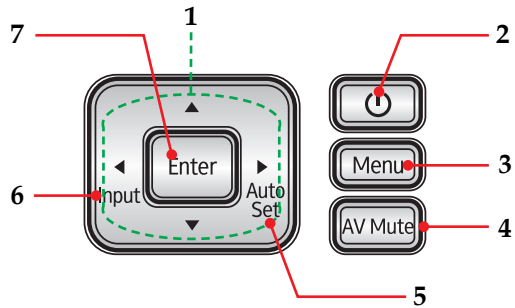

1	Four Directional Select Keys	Use ▲ or ▼ or ◀ or ▶ to select items or make adjustments to your selection.
2	Power	Refer to the “Power On/Off the Projector” section. (See pages 31~32)
3	Menu	Press “Menu” to launch the on screen display (OSD), or go back to the previous menu. (See page 38)
4	AV Mute	Momentarily turn off/on the audio and video.
5	Auto Set	Automatically synchronize the projector to the input source.
6	Input	Select the input source.
7	Enter	Select or confirm settings.

Introduction

LED Indicators

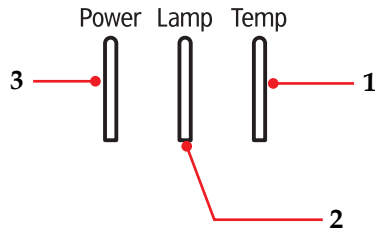

1	Temp indicator	Indicate the inside of the projector's temperature status.
2	Lamp indicator	Indicate the projector's lamp status.
3	Power indicator	Indicate the projector's power status.

Introduction

Remote Control

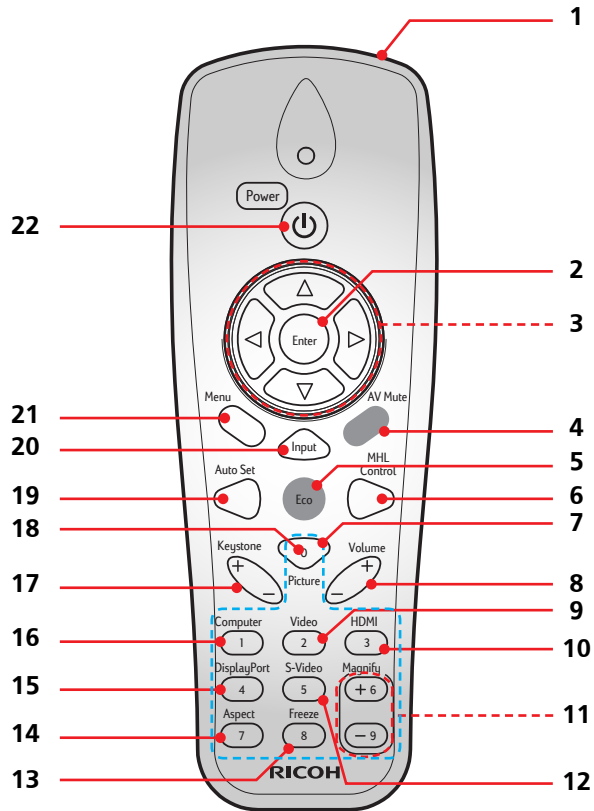

1	Infrared transmitter	Send signals to the projector.
2	Enter	Confirm your selection of items in sub menu operation.
3	Four Directional Select Keys	Use ▲ or ▼ or ◀ or ▶ to select items or make adjustments to your selection.
4	AV Mute	Momentarily turn off/on the audio and video.

Introduction

5	Eco	Dim the projector lamp which will lower power consumption and extend the lamp life.
6	MHL Control	Press "MHL Control" to control your MHL device.
7	Number (0~9)	Input numbers.
8	Volume +/-	Increase/decrease speaker volume.
9	Video	Press "Video" to choose Video in terminal.
10	HDMI	Press "HDMI" to choose HDMI in terminal.
11	Magnify	Zoom in the projector display.
12	S-Video	Press "S-Video" to choose S-Video in terminal.
13	Freeze	Pause the screen image. Press again to resume the screen image.
14	Aspect	Use this function to choose your desired aspect ratio.
15	DisplayPort	Press "DisplayPort" to choose DisplayPort terminal.
16	Computer	Press "Computer" to choose Computer in/Component in terminal.
17	Keystone +/-	Adjust the image to compensate for distortion caused by tilting the projector.
18	Picture	Select the preset picture mode.
19	Auto Set	Automatically synchronize the projector to the input source.
20	Input	Press "Input" to choose your desired input source.
21	Menu	Press "Menu" to launch the On Screen Display (OSD), back to the top level of OSD for the OSD main menu operation. (See page 38)
22	Power	Refer to the "Power On/Off the Projector" section. (See pages 31~32)

Remote Control Battery Installation

1 Press firmly and slide the battery cover off.

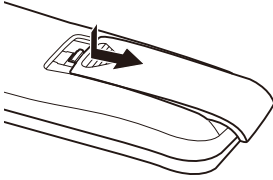

2 Install new batteries (AAA/R03). Ensure that you have the batteries' polarity (+/-) aligned correctly.

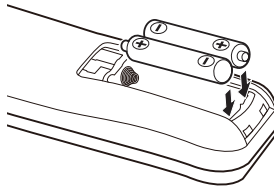

3 Slip the cover back over the batteries until it snaps into place. Do not mix different types of batteries or new and old batteries.

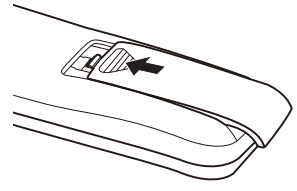

To ensure safe operation, please observe the following precautions :

- Use AAA/R03 type battery.
- Avoid contact with water or liquid.
- Do not expose the remote control to moisture or heat.
- Do not drop the remote control.
- If the battery has leaked in the remote control, carefully wipe the case clean and install new battery.
- Risk of an explosion if battery is replaced by an incorrect type.
- Dispose of used battery according to the instructions.
- Remove batteries from remote control when not using for extended periods.
- The remote control may fail to operate if the infrared remote sensor is exposed to bright sunlight or fluorescent lighting.

Introduction

Remote Control Operating Range

Point the remote control toward the projector (Remote Receiver) when pressing any button.

Maximum operating range for the remote control is about 23.0' (7m) and $\pm 30^\circ$ (horizontally), $\pm 20^\circ$ (vertically) in front of the projector.

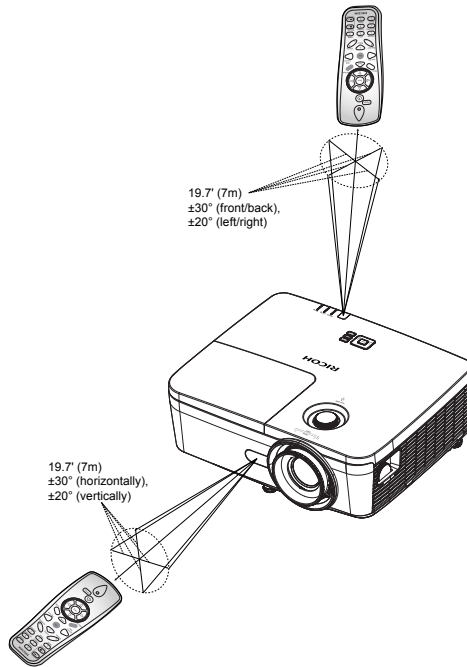

Connecting the Projector

Connect to Computer/Notebook

Note

- ❖ Make sure that the power plug is fully inserted into both the projector AC inlet and the wall outlet.
- ❖ The AC outlet must be near this equipment and must be easily accessible.

Note

- ❖ Due to the difference in applications for each country, some regions may have different accessories.

Note

- ❖ When “Monitor Out (Standby)” is set to “Off”, the monitor out and audio out will be deactivated in standby mode.
- ❖ When Audio Out is connected, the built-in speaker doesn’t produce sound.

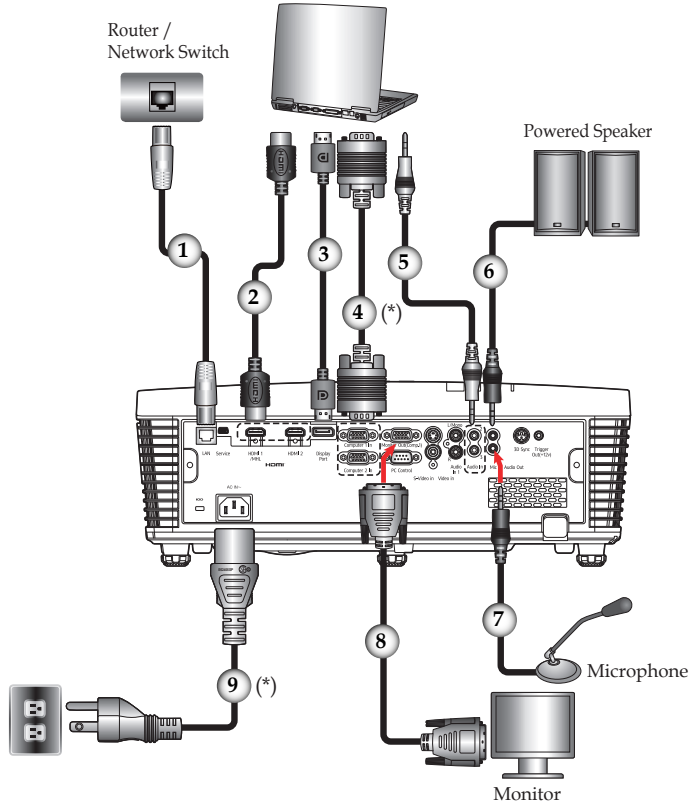

1.....	LAN cable
2.....	HDMI/MHL cable
3.....	DisplayPort cable
4.....	RGB cable (supplied)
5.....	Audio cable
6.....	Audio cable
7.....	Microphone cable
8.....	RGB cable
9.....	Power cord (supplied)

- ❖ To ensure the projector works well with your computer, please make sure the timing of the display mode is compatible with your projector. (See pages 82~86)
- ❖ Use the cables that come with the projector. (*)

Basic Operations

Connect to AV Equipment

Note

- ❖ Make sure that the power plug is fully inserted into both the projector AC inlet and the wall outlet.
- ❖ The AC outlet must be near this equipment and must be easily accessible.

Note

- ❖ Due to the difference in applications for each country, some regions may have different accessories.

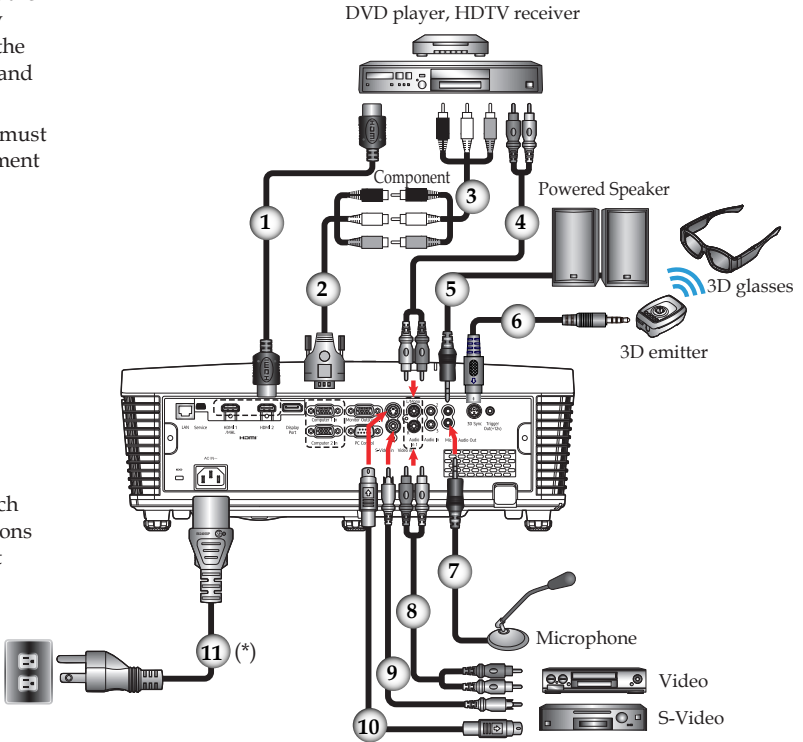

Note

- ❖ When HDMI input is selected, only audio signal with HDMI can be output.
- ❖ When Audio Out is connected, Built-in speaker doesn't sound.

1.....	HDMI/MHL cable
2.....	Component-RGB Cable
3.....	Component Cable
4.....	Audio cable
5.....	Audio cable
6.....	3D emitter cable
7.....	Microphone cable
8.....	Audio cable
9.....	Video cable
10.....	S-Video cable
11.....	Power cord (supplied)

- ❖ Use the cables that come with the projector. (*)

Powering On/Off the Projector

Powering On the Projector

1. Ensure that the power cord and signal cable are securely connected. The Power indicator will turn red.
2. Remove the lens cap. ❶
3. Turn on the lamp by pressing the “⏻” button on the control panel or the remote control. ❷ The Power indicator will flash blue.

The startup screen will display and the Power indicator will turn blue.

4. The first time you use the projector, you will be asked to select the preferred language. Turn on your source (computer, notebook, video player, etc.) The projector will detect your source automatically.

Make sure that the “Auto Source” has been set to “On”.

CAUTION:

- Do not look into the lens while the lamp is on. The strong light from the lamp may cause damage to your eyesight.
- Do not block the air intake or exhaust. Doing so could cause a fire due to internal overheating.
- Do not place your hands, face, or other objects near the air exhaust, the lamp cover or the bottom of the unit. Doing so could result in injury and/or damage the object.

Note

- ❖ If you connect multiple sources at the same time, press “Input” to switch inputs.

Note

- ❖ Turn on the projector first and then the signal sources.

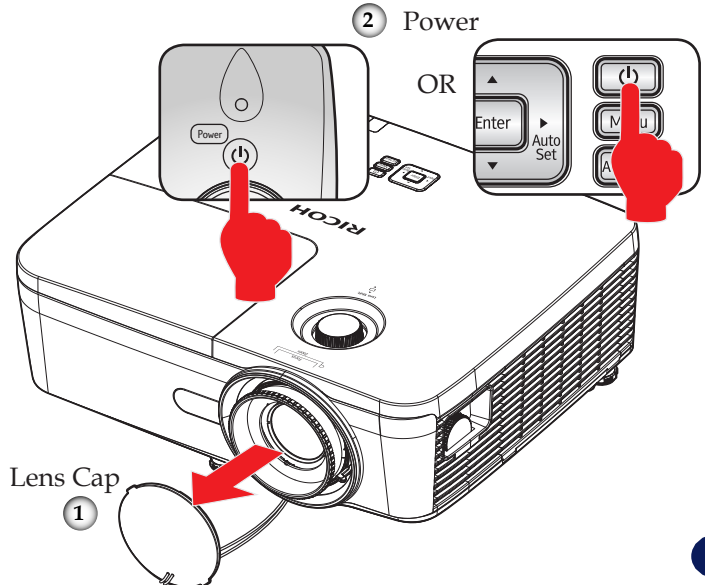

Powering Off the Projector

1. Press the “⏻” button and you will see a message as below on the on-screen display.

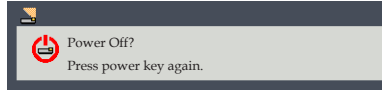

2. Press the “⏻” button again to turn off the projector lamp.
3. The cooling fan continues to operate for about 30 seconds for cooling cycle and the Power indicator will flash red. After cooling down, the light stops flashing, and then the projector will enter the standby mode.

If you wish to turn the projector back on, you must wait until the projector has completed the cooling cycle and has entered standby mode. Once in standby mode, simply press the “⏻” button to restart the projector.

4. Disconnect the power cord from the electrical outlet and the projector.

Warning Indicator

- ❖ When the “Temp” indicator lights red, it indicates the projector has overheated. The projector will automatically shut itself down.



- ❖ When the “Lamp” indicator lights red, and you see the message below displays on-screen, the projector has detected that the lamp is approaching its end of life. Please change the lamp as soon as possible or contact your local dealer or our service center.

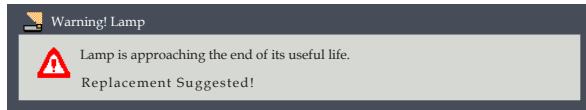

- ❖ When the “Temp” indicator flashes red (0.5 sec on, 0.5 sec off) and the message below displays, it indicates the cooling fan failed. Stop using the projector and disconnect the power cord from the electrical outlet, then contact your local dealer or our service center.

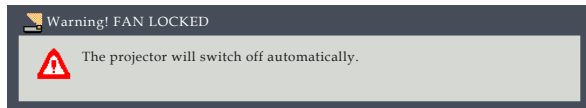

For more information of the warning indicator, please see page 80.

Adjusting the Projected Image

Adjusting the Position of Projector Image

The projector is equipped with adjustable feet to raise and lower the image to fill the screen.

1. Locate the adjustable foot you wish to modify on the underside of the projector.
2. Rotate the adjustable ring clockwise to raise the projector or counter clockwise to lower it. Repeat with the remaining feet as necessary.

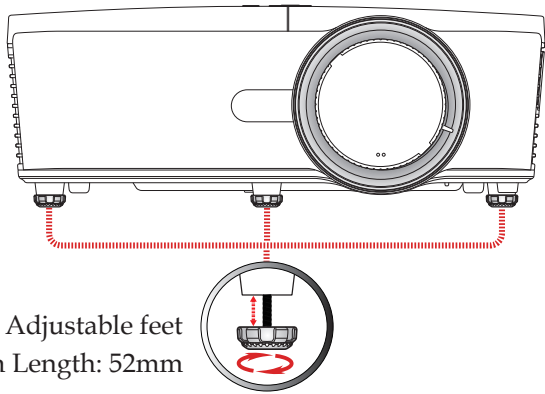

Front Adjustable feet
Maximum Length: 52mm

Adjusting the Projection Position using Lens Shift

This projector is equipped with a lens shift function for adjusting the position of the projected image by turning the Lens Shift dials clockwise or counterclockwise.

- ▶ Use the Lens Shift dial on the upper panel to adjust the projection position in the vertical direction.
- ▶ Use the Lens Shift dial on the side panel to adjust the projection position in the horizontal direction.

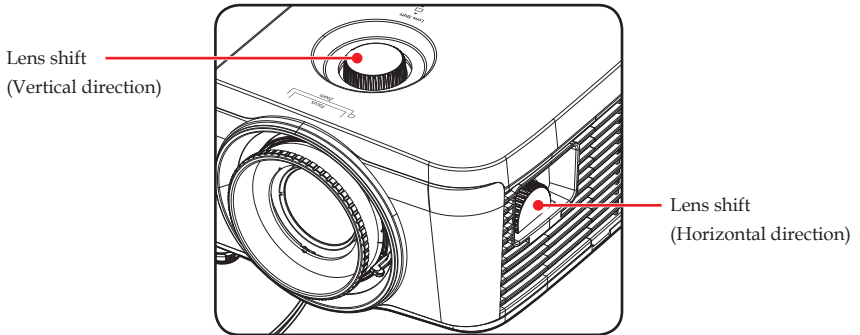

The projection position cannot be moved more than the range indicated in the illustration below.

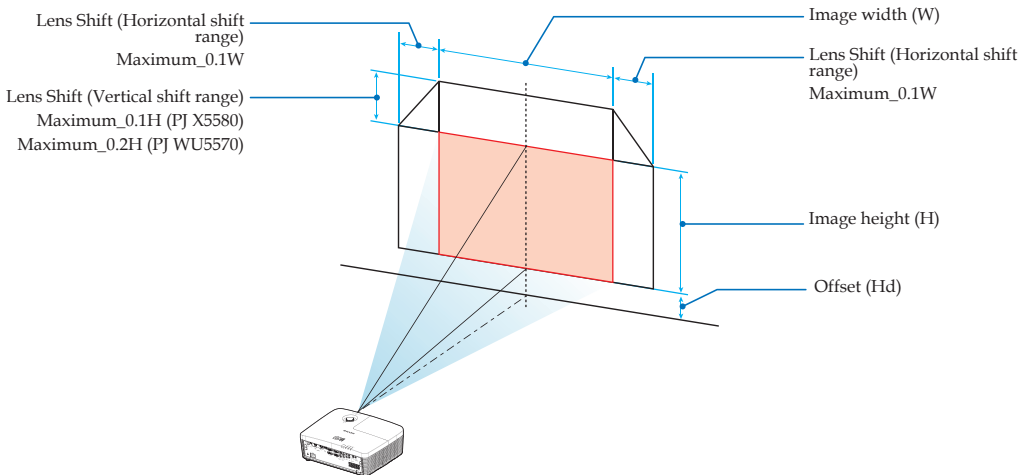

Basic Operations

Adjusting the Projector Zoom and Focus

You may turn the zoom lever to zoom in or out. To focus the image, rotate the focus ring until the image is clear.

- ▶ XGA (PJ X5580): Focus at distances from 3.28 to 44.29 feet (1.0 to 13.5 meters).
- ▶ WUXGA (PJ WU5570): Focus at distances from 3.28 to 45.28 feet (1.0 to 13.8 meters).

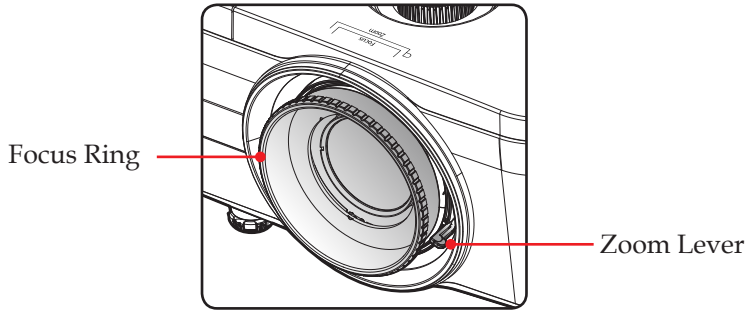

Adjusting Projection Image Size

- ▶ Projection Image Size from 30" to 300" (0.76 to 7.6 meters).

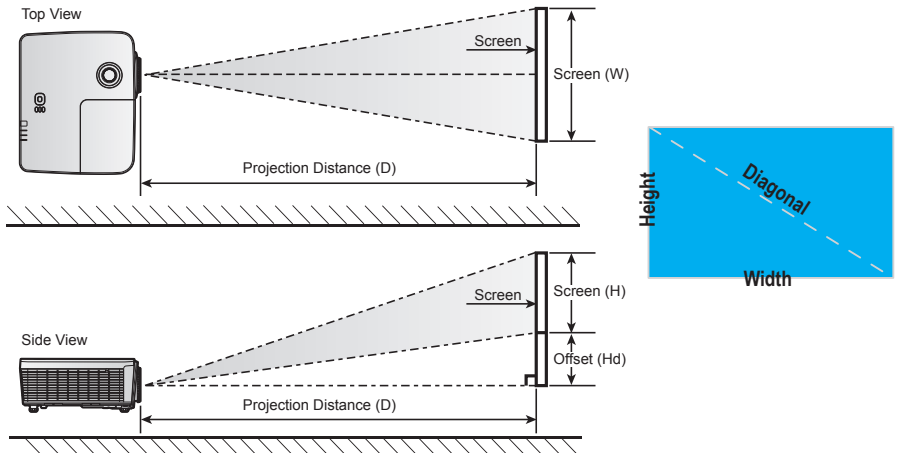

Basic Operations

XGA (PJ X5580)

Diagonal length (inch) size of 4:3 Screen	Screen Size W x H				Projection Distance (D)				Offset (Hd)			
	(m)		(inch)		(m)		(feet)		(cm)		(feet)	
	Width	Height	Width	Height	wide	tele	wide	tele	Max	Max	Max	Min
30	0.61	0.46	24	18	/	1.3	/	4.27	2.286	-2.286	0.075	-0.075
40	0.81	0.61	32	24	1.0	1.8	3.28	5.91	3.048	-3.048	0.100	-0.100
50	1.02	0.76	40	30	1.3	2.2	4.27	7.22	3.810	-3.810	0.125	-0.125
60	1.22	0.91	48	36	1.5	2.7	4.92	8.86	4.572	-4.572	0.150	-0.150
70	1.42	1.07	56	42	1.8	3.1	5.91	10.17	5.334	-5.334	0.175	-0.175
80	1.63	1.22	64	48	2.0	3.6	6.56	11.81	6.096	-6.096	0.200	-0.200
90	1.83	1.37	72	54	2.3	4.0	7.55	13.12	6.858	-6.858	0.225	-0.225
100	2.03	1.52	80	60	2.5	4.5	8.20	14.76	7.620	-7.620	0.250	-0.250
120	2.44	1.83	96	72	3.0	5.4	9.84	17.72	9.144	-9.144	0.300	-0.300
150	3.05	2.29	120	90	3.8	6.7	12.47	21.98	11.430	-11.430	0.375	-0.375
180	3.66	2.74	144	108	4.5	8.1	14.76	26.57	13.716	-13.716	0.450	-0.450
200	4.06	3.05	160	120	5.0	9.0	16.40	29.53	15.240	-15.240	0.500	-0.500
250	5.08	3.81	200	150	6.3	11.2	20.67	20.67	19.050	-19.050	0.625	-0.625
300	6.10	4.57	240	180	7.6	13.5	24.93	24.93	22.860	-22.860	0.750	-0.750

WUXGA (PJ WU5570)

Diagonal length (inch) size of 16:10 Screen	Screen Size W x H				Projection Distance (D)				Offset (Hd)			
	(m)		(inch)		(m)		(feet)		(cm)		(feet)	
	Width	Height	Width	Height	wide	tele	wide	tele	Max	Max	Max	Min
30	0.65	0.40	25.4	15.9	/	1.4	/	4.59	8.07	0.00	0.26	0.00
40	0.86	0.54	33.9	21.2	1.0	1.8	3.28	5.91	10.77	0.00	0.35	0.00
50	1.08	0.67	42.4	26.5	1.3	2.3	4.27	7.55	13.46	0.00	0.44	0.00
60	1.29	0.81	50.9	31.8	1.5	2.8	4.92	9.19	16.16	0.00	0.53	0.00
70	1.51	0.94	59.4	37.1	1.8	3.2	5.91	10.50	18.85	0.00	0.62	0.00
80	1.72	1.08	67.8	42.4	2.1	3.7	6.89	12.14	21.54	0.00	0.71	0.00
90	1.94	1.21	76.3	47.7	2.3	4.1	7.55	13.45	24.23	0.00	0.79	0.00
100	2.15	1.35	84.8	53	2.6	4.6	8.53	15.09	26.92	0.00	0.88	0.00
120	2.58	1.62	101.8	63.6	3.1	5.5	10.17	18.04	32.31	0.00	1.06	0.00
150	3.23	2.02	127.2	79.5	3.9	6.9	12.80	22.64	40.39	0.00	1.33	0.00
180	3.88	2.42	152.6	95.4	4.6	8.3	15.09	27.23	48.46	0.00	1.59	0.00
200	4.31	2.69	169.6	106	5.2	9.2	17.06	30.18	53.85	0.00	1.77	0.00
250	5.38	3.37	212.0	132.5	6.4	11.5	21.00	37.73	67.31	0.00	2.21	0.00
300	6.46	4.04	254.4	159	7.7	13.8	25.26	45.28	80.77	0.00	2.65	0.00

User Settings

Using the On Screen Display (OSD)

The Projector has a multilingual On Screen Display that allows you to make image adjustments and change a variety of settings.

How to operate

1. To open the OSD, press "Menu" on the Control Panel or Remote Control.
2. When OSD is displayed, use ▲ ▼ keys to select any item in the main menu. While making a selection on a particular page, press ► or "Enter" key to enter sub menu.
3. Use ▲ ▼ keys to select the desired item in the sub menu and press ► or "Enter" key to view further settings. Adjust the settings by using ◀▶ key or ▲ ▼ key.
4. Select the next item to be adjusted in the sub menu and adjust as described above.
5. Press "Enter" or "Menu" to confirm, and the screen will return to the previous menu.
6. To exit, press "Menu" again. The OSD menu will close and the projector will automatically save the new settings.

Note

❖ If no button operation is made for 3 - 10 seconds, the OSD will be closed automatically.

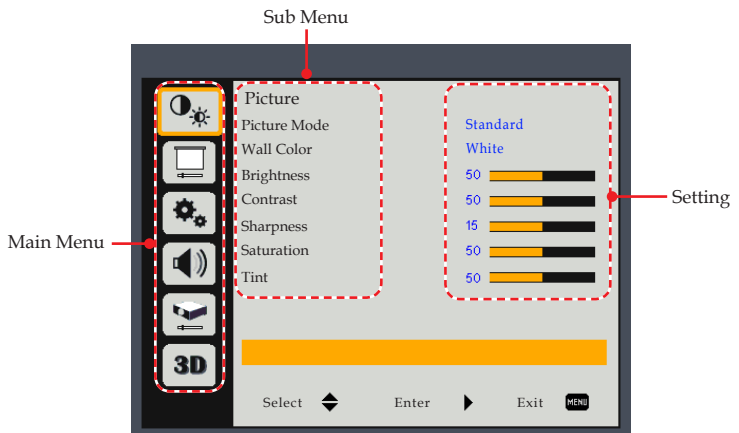

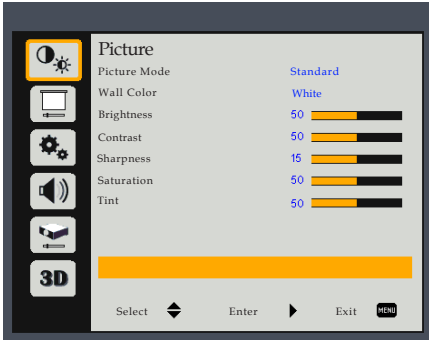

PICTURE

Picture Mode

There are many factory presets optimized for various types of images. The available options:

- ▶ Bright: Mode for emphasizing brightness.
- ▶ Standard: Mode for optimizing the balance between brightness and color reproduction.
- ▶ Natural: Mode for emphasizing color reproduction.
- ▶ Presentation: This mode is suitable for showing PowerPoint presentations when the project is connected to the PC.
- ▶ User: User defined settings.

Wall Color

Use this function to obtain an optimized screen image according to the wall color. The available options: White/ Light Yellow/ Light Blue/ Pink / Dark Green.



Brightness

Adjust the brightness of the image.



- ▶ Press the ◀ key to darken image.
- ▶ Press the ▶ key to lighten the image.

User Settings

Note

❖ “Sharpness”, “Saturation” and “Tint” functions are only supported under Video/S-Video/Composite Signal sources.

Contrast

The contrast controls the degree of difference between the lightest and darkest parts of the picture. Adjusting the contrast changes the amount of black and white in the image.



- ▶ Press the ◀ key to decrease the contrast.
- ▶ Press the ▶ key to increase the contrast.

Sharpness

Adjust the sharpness of the image.



- ▶ Press the ◀ key to decrease the sharpness.
- ▶ Press the ▶ key to increase the sharpness.

Saturation

Adjust the color saturation of the image.



- ▶ Press the ◀ key to decrease the amount of color in the image.
- ▶ Press the ▶ key to increase the amount of color in the image.

Tint

Adjust the color balance of the image.



- ▶ Press the ◀ key to adjust the image color greenish.
- ▶ Press the ▶ key to adjust the image color reddish.

User Settings

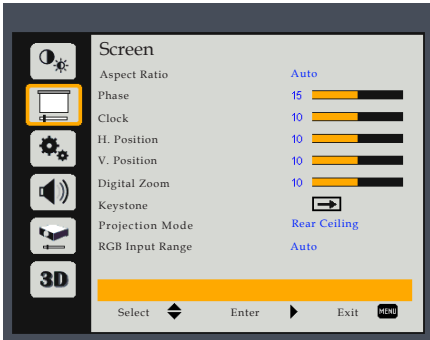

SCREEN

Aspect Ratio

Use this function to choose your desired aspect ratio.

- ▶ Auto: Automatically selects the appropriate display format. When input is 4:3, the image is displayed as 4:3. When input is 16:9 above, the image is displayed as 16:9.
- ▶ 4:3: Displays 4:3 aspect ratio.
- ▶ 16:9: Displays 16:9 aspect ratio.

Phase

Eliminate flicker from the image displayed. Use the ◀ or ▶ key to adjust the value.



Clock

Adjust the number of total dots in one horizontal period. Use the ◀ or ▶ key to adjust number to match your PC image.



User Settings

Note

❖ “H. Position” and “V. Position” functions are only supported under Computer Signal source.

H. Position (Horizontal Position)

Shift the projected image position horizontally.



- ▶ Press the ◀ key to move the image left.
- ▶ Press the ▶ key to move the image right.

V. Position (Vertical Position)

Shift the projected image position vertically.



- ▶ Press the ◀ key to move the image down.
- ▶ Press the ▶ key to move the image up.

Digital Zoom

Adjust the digital zoom ratio of the projected image.



- ▶ Press the ◀ key to reduce the size of an image.
- ▶ Press the ▶ key to magnify an image on the projection screen.

User Settings

Keystone

Use this function to make an image look visually correct when it is projected onto the screen.

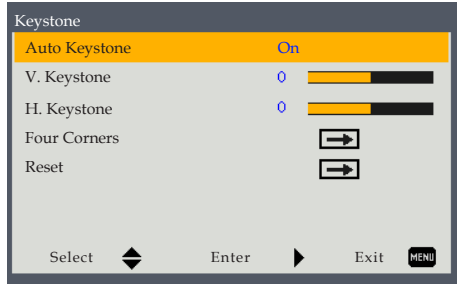

Note

❖ “V. Keystone” function will be disabled when the “Auto Keystone” is set to “On”.

- ▶ Auto Keystone: Automatically adjust the shape of the projected image according to the angle at which the projector is positioned.
- ▶ V. Keystone: Press the ◀ or ▶ key to adjust image distortion vertically. If the image looks trapezoidal, this option can help make the image rectangular.
- ▶ H. Keystone: Press the ◀ or ▶ key to adjust image distortion horizontally.
- ▶ Four Corners: Adjust any distortion in the four corners of the projected image.

To adjust the desired corner, perform the following:

- a. Use the ▲ or ▼ key to select the item to select which corner to adjust and press the “Enter” key to enter its submenu.

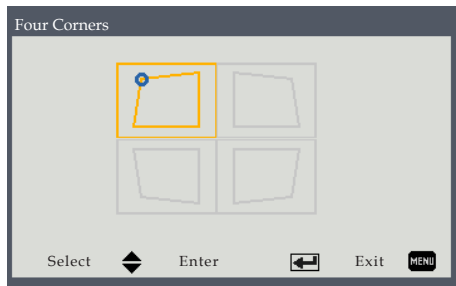

User Settings

b. Use the ◀▶, ▲, or ▼ key to adjust the setting.

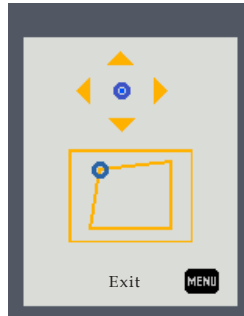

- ▶ Reset: Resets the projected image adjustment to its original settings.

Projection Mode

Use this function to select the projector mode, depending upon how the projector is mounted.



- ▶ Front: This is the default selection. The image is projected straight on the screen.
- ▶ Front Ceiling: When selected, the image will turn upside down.
- ▶ Rear: When selected, the image will appear reversed.
- ▶ Rear Ceiling: When selected, the image will appear reversed in upside down position.

RGB Input Range

Adjust the color range of the HDMI image data.



- ▶ Auto: Automatically detect RGB range.
- ▶ Standard: Process the input image as standard range data.
- ▶ Full: Select this mode when computer signal or full range signal from AV equipment is input.

User Settings

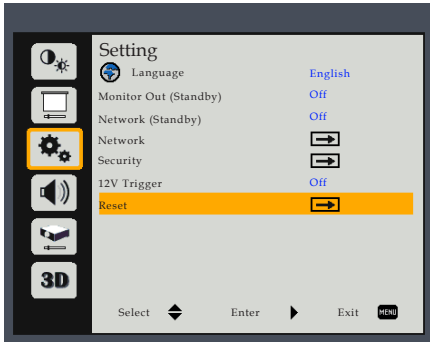

SETTING

Language

Choose the multilingual OSD. Press “Enter” to open the sub menu and then use the ▲ or ▼ or ◀ or ▶ key to select your preferred language. Press “Enter” to finalize the selection.

Monitor Out (Standby)

Enable/Disable the Monitor output function.



- ▶ On: Enable the Monitor Out function at projector standby status.
- ▶ Off: Disable the Monitor Out function at projector standby status.

Network (Standby)

Enable/Disable the network function.



- ▶ On: Enable the network function at projector standby status.
- ▶ Off: Disable the network function at projector standby status.

Note

❖ Consult network administrator for network settings.

Network

Configure the network settings.

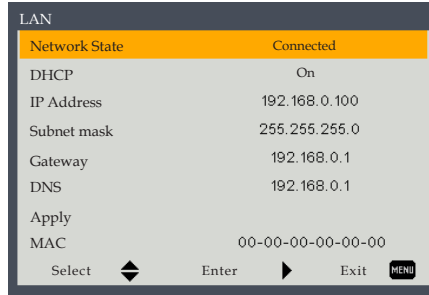

- ▶ Network State: Display the network connection status.
- ▶ DHCP: Select “On” to allow the projector to obtain an IP address automatically from your network. Select “Off” to manually assign IP, Subnet Mask and Gateway configuration.



- ▶ IP Address: Set an IP address or display IP address provided from DHCP server when DHCP is set to “On”.

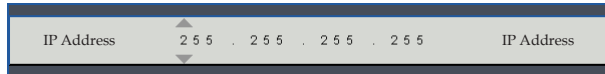

- ▶ Subnet mask: Set subnet mask number or display subnet mask number provided from DHCP server when DHCP is set to “On”.
- ▶ Gateway: Set the default gateway of the network connected to the projector or display the default gateway of the network provided from DHCP server when DHCP is set to “On”.
- ▶ DNS: Display the IP address of the domain name system (DNS) server.
- ▶ Apply: Select “Yes” to apply the changes made in network configuration settings.



- ▶ MAC: Display MAC address.

User Settings

Security

Configure the security settings.

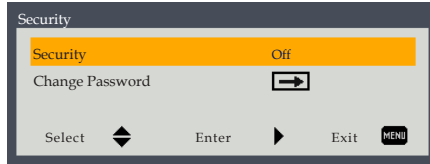

- ▶ Security: Select “On” to use the security verification when the turning on the projector. Select “Off” to be able to switch on the projector without a password verification.



- ▶ Change Password: Set the password.

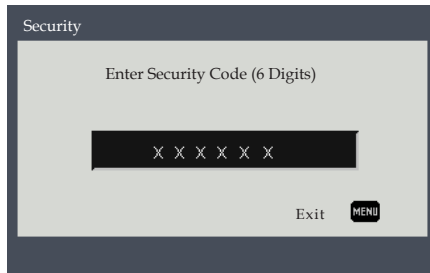

Trigger Output (12V)

Use this function to enable or disable the trigger.

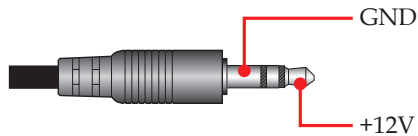

- ▶ Off: Choose “Off” to disable the trigger. When the function is disabled, the power will output 0V.
- ▶ On: Choose “On” to enable the trigger. When the function is enabled, the power will output 12V.

User Settings

Reset

Return the adjustments and settings to the factory default values. Choose "Yes" to return the display parameters on all menus except Language and Lamp Hours Used to the factory default settings. LAN Control settings also return to the factory default. Set again after reset.

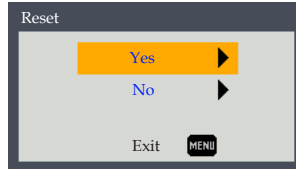

User Settings

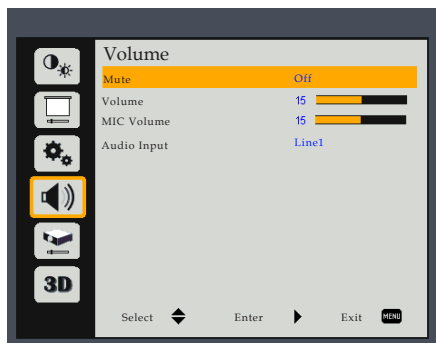

VOLUME

Note

❖ “Mute” function affects both internal and external speaker volume.

Mute

Temporarily turn off the sound.

- ▶ Choose “On” to mute the sound.
- ▶ Choose “Off” to turn mute off.

Volume

Adjust the volume level.

- ▶ Press the ◀ key to decrease the volume.
- ▶ Press the ▶ key to increase the volume.

MIC Volume

Adjust the microphone volume level.



- ▶ Press the ◀ key to decrease the microphone volume.
- ▶ Press the ▶ key to increase the microphone volume.

Audio Input

The default audio settings are on the back panel of the projector. Use this option to reassign any of the Audio Inputs (Line1/Line2/Line3) to the current image source.



User Settings

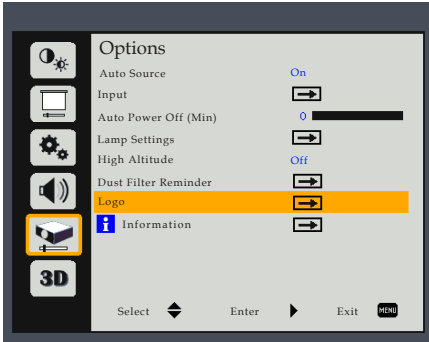

OPTIONS

Auto Source

When this function is turned “On”, the projector will search for other signals if the current input signal is lost. When this function is turned “Off”, it will only search a specified connection port.

Input

Use this option to enable/disable input sources. Press the ► key to enter the sub menu and select which sources you require. Press “Enter” to finalize the selection. The projector will only search for inputs that are enabled.

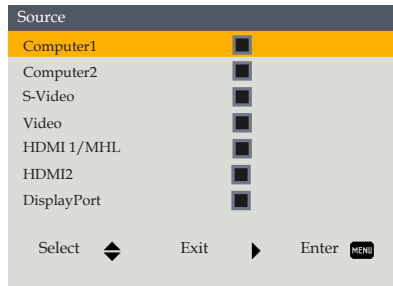

Note

❖ Default value of “Auto Power Off (Min)” is 20 min.

Auto Power Off (Min)

Sets the countdown timer interval. The countdown timer will start, when there is no signal being sent to the projector. The projector will automatically power off when the countdown has finished (in minutes). When countdown timer is selected to “0”, auto power off is disabled.



User Settings

Lamp Settings

Use this option to view the lamp life status and configure the lamp settings. Press the ► key to enter the sub menu and configure the desired settings.

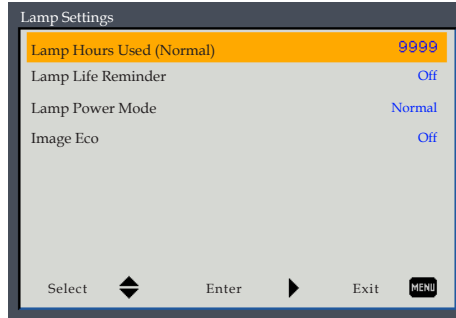

Note

❖ When ambient temperature is over 40°C in operating, the projector will switch to “ECO” automatically.

- ▶ **Lamp Hours Used (Normal):** Display the projection time. Lamp Hours Used in Eco mode or “Image Eco” mode “On” will be converted to Lamp Hours Used in “Normal” mode.
- ▶ **Lamp Life Reminder:** Choose this function to show or to hide the warning message when the changing lamp message is displayed. The message will appear 30 hours before suggested replacement of lamp.
- ▶ **Lamp Power Mode:** Set the brightness mode. Choose “Normal” to increase the brightness or choose “ECO” to dim the projector lamp which will lower power consumption and extend the lamp life.
- ▶ **Image Eco:** Choose “On” to dim the lamp power, depending on the brightness level of images, and significantly reduce the lamp power consumption. The lamp life will be extended.

High Altitude

When “On” is selected, the fans will spin faster. Set High Altitude mode to “On” when the projector is used over 2500ft (750m) elevation.



User Settings

Dust Filter Reminder

Use this option to view the filter status and configure the filter settings. Press the ► key to enter the sub menu and configure the desired settings.

This item is disabled for the projector sold in some regions.

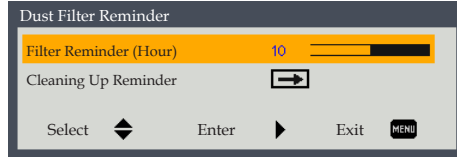

- ▶ Filters Remind (Hour): Set the maximum filter time usage.
- ▶ Cleaning Up Reminder: Choose this function to show or hide the warning message when the changing filter message is displayed.

If the reminder function is enabled and the usage time reached its limit, a message will appear on the screen to remind you to clean or change the filter.

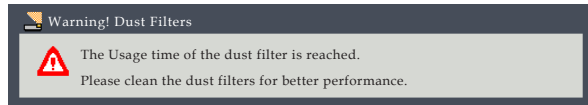

Logo

Use this option to set the desired startup screen. Press the ► key to enter the sub menu and configure the desired settings.

If changes are made they will take effect the next time the projector is powered on.

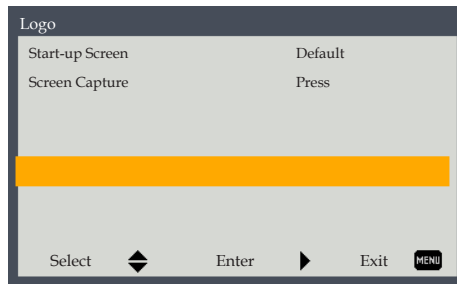

- ▶ Start-up Screen: Select "Default" to use the default startup screen. Select "User" to use a customized startup screen.



User Settings

- ▶ Screen Capture: Press "Enter" to capture an image of the picture currently displayed on screen.

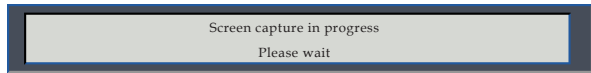

Information

Display the projector information.

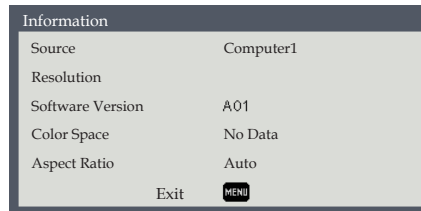

- ▶ Source: Display the input source that is currently connected to.
- ▶ Resolution: Display the resolution setting of the current input source.
- ▶ Software Version: Display the firmware version.
- ▶ Color Space: Display the currently used color matrix type.
- ▶ Aspect Ratio: Display the currently used aspect ratio setting.

User Settings

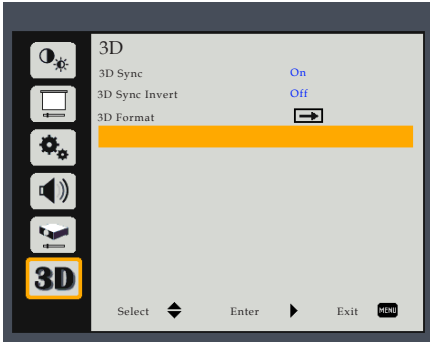

3D

Note

- ❖ “3D Sync Invert” is only available when 3D is enabled.
- ❖ This setting may need to change when re-start running 3D movie.
- ❖ 3D function is turned on automatically when Blu-ray 3D source is input.

3D Sync

Use this option to disable the 3D function or select the appropriate the 3D function.

- ▶ Off: Choose “Off” to display normal (2D) picture.
- ▶ DLP: Choose “DLP” to use optimized settings for DLP Link 3D Glasses.
- ▶ IR: Select “IR” to use optimized setting for IR 3D Glasses.

3D Sync Invert

Use this option to enable/disable the 3D sync invert function.

- ▶ Off: Choose “Off” for default frame contents.
- ▶ On: Choose “On” to invert left and right frame contents.

3D Format

Use this option to select the appropriate 3D format content.

- ▶ Auto: Use this mode to let the system to automatically select the appropriate 3D format content.
- ▶ Side by Side: Use this mode for “Side by Side” format 3D content.
- ▶ Top and Bottom: Use this mode for “Top and Bottom” format 3D content.
- ▶ Frame Sequential: Use this mode for “Frame Sequential” format 3D content.

Note

❖ When you are connecting the device to an existing network, set according to the instructions of the network administrator.

Controlling this Device with Web Browser

You can control this device from a PC by using a web browser.

Connecting to the device

1. Confirmation of the IP address of the device

Select the "Setting" → "Network" in the menu of this device, and verify the IP address.

LAN	
Network State	Connected
DHCP	On
IP Address	192.168.0.100
Subnet mask	255.255.255.0
Gateway	192.168.0.1
DNS	192.168.0.1
Apply	
MAC	00-00-00-00-00-00
Select	◆
Enter	▶
Exit	▶
	MENU

Note

❖ This web page uses Java Script. Turn on and use the Java Script with the settings of the browser you intend to use.

2. Connection

Enter the IP address that was verified by opening the web browser.

For example, enter `http://192.168.0.100/` if the IP address is displayed as shown above.

Log in

1. When you open the web page, you will see a screen like the one below.

If you are controlling by web browser, select "Admin".

When controlling by Crestron, choose "Crestron".

The screenshot shows the RICOH Projector Web Server login interface. At the top left is the RICOH logo. To its right, the text reads 'RICOH Projector Web Server' and 'Projector Name:'. Below this is a dark navigation bar with two buttons: 'Admin' and 'Crestron'. The main area is white and contains a login form. The form has two input fields: 'User Name' with the value 'admin' and 'Password' which is masked with dots. Below the password field is a 'Login' button. A small note below the form states '* Default Password: admin'.

Note

❖ You can use only alphanumeric characters and symbols in the password. The maximum number of characters is 32. If you enter an invalid character, "Invalid Character" warning is displayed.

❖ "B01" displayed on the webpage above indicates the version of the web server. The actual display may not be "B01".

2. Enter the password in the "Password" field.

When a password is enabled, you must enter the password. The initial password is "admin". When a password is disabled, the character of the Password will be dimmed.

Login by clicking the [Login] button.

When you log in, a navigation bar for setting the projector will be displayed on the left side of the home screen.

System Status

The current status of the projector is displayed. You can check information such as firmware version number of the projector and IP address.

Note

❖ The version name displayed on the web page in the diagram may differ from the actual display.

RICOH Projector Web Server	
Projector Name: RICOH PJ X5580	
Admin > System Status	
System Status	
General Setup	
Projector Control	
Network Setup	
Alert Setup	
Crestron	
Reset to Default	
Reboot System	
Model Name	RICOH PJ X5580
Projector Name	RICOH PJ X5580
Version	
Firmware Version	
LAN Version	Ricoh_V0.02
LAN Status	
IP address	10.0.50.100
Subnet mask	255.255.0.0
Default gateway	10.0.0.254
MAC address	00:60:E9:16:DF:EE

- ▶ Language selection
You can change the language of the Web Control screen to English, Japanese and Chinese (Simplified). Select from the pull-down list and press "Apply".

Note

- ❖ The projector name set here is also used in PjLink control.
- ❖ Only alphanumeric characters and symbols can be used as projector name. The maximum number of characters is 32.
- ❖ If the characters of new password and the characters of new password (confirm) do not match, error message will be displayed. In this case, re-enter the password.

General Settings

You can change the projector name and password with this item.

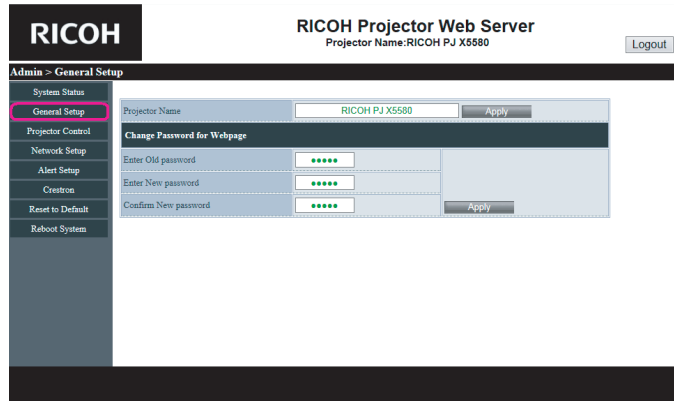

- ▶ Changing projector name.
Enter the new projector name in the projector name field.
Click “reflect”.
- ▶ Changing the password.
Enter the current password in the current password field.
Enter the new password in both the “new password field” and “new password (confirm)” fields.
Click “projection”.

Control

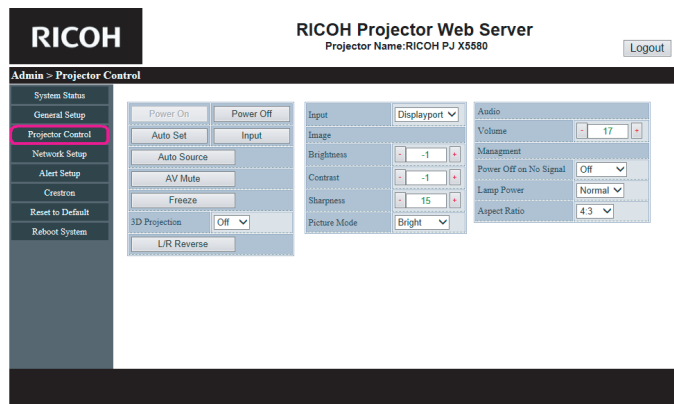

You can control the projector with this item.
The items for control are described in this section.

LAN Control

Control button: When you click a button, the corresponding function will be performed.

Power ON	The power of the projector turns on. To turn ON, click "Settings" → "Network (standby)".
Power OFF	Turns OFF the power of the projector.
Auto Set	The RGB signal from the computer is automatically adjusted.
Input	The input signal of the projector changes to the next signal.

Function button: When you click a button, the corresponding function will turn ON/OFF. (Function of the time of ON is described here.)

Auto signal selection	You will be automatically switched to the next input when the input signal is lost.
AV Mute	The video and audio will turn off temporarily.
Freeze	The images will freeze.
3D	Images that support 3D display will be projected.
Flip horizontal	Left/right video of DLP Link 3D glasses is switched.

Adjustment button: Projector can be adjusted by +/- button.

Input	Select input signal from the pull-down list.
Brightness	Adjust brightness by +/- button. Value will return to the initial value when you click the Reset button.
Contrast	Adjust contrast by +/- button. Value will return to the initial value when you click the Reset button.
Sharpness	Adjust sharpness by +/- button. Value will return to the initial value when you click the Reset button.
Video mode	Select video mode from the pull-down menu. The video modes are Bright, Standard, Natural, Game and User.

Volume	Adjust the volume by +/- button. Value will return to the initial value when you click the Reset button.
No Signal Power Off	Select from the pull-down list the time to automatically turn off the power after signal is displayed. Power turns off automatically if you select Off.
Lamp power	Switch the power of lamp.
Aspect	Switch the aspect ratio.

Network Settings

RICOH RICOH Projector Web Server
Projector Name: RICOH PJ X6580 [Logout](#)

Admin > Network Setup

System Status
General Setup
Projector Control
Network Setup
Alert Setup
Crestron
Reset to Default
Reboot System

IP Setup

Obtain an IP address automatically Use the following IP address

IP Address: 10 0 50 100
Subnet Mask: 255 255 0 0
Default Gateway: 10 0 0 254
DNS Server: 168 95 1 1

Note

❖ IPv6 cannot be used in this device.

Set the network of the projector.

- ▶ Automatically configuring the network settings from DHCP. Check automatic setting and then click "Apply".
- ▶ Configuring the network settings manually. Check manual setting, enter appropriate values in the IP address, Subnet Mask, Default Gateway (Gateway) and DNS Server fields, and then click "Apply".

Note

❖ Only alphanumeric characters and symbols can be used in the password. The maximum number of characters is 32.

❖ If the characters entered in the Current Password field and the characters entered in the Confirm Password field do not match, error message will be displayed. In this case, re-enter the password.

Note

❖ When you have changed the settings, verify that the e-mail settings are done correctly. It is recommended that you send a test mail.

❖ E-mail transmission protocol supports only SMTP. Other protocols cannot be used.

❖ When Japanese or Chinese characters are used in an e-mail content, the e-mail may be received with unreadable characters. In such case, please use English characters for the e-mail content.

Alert Settings

You can send email alerts when an error occurs.
You can carry out settings for alert mail in this section.

- ▶ Alert types
Check the type of error for which you want to send alert mail.
- ▶ Alert mail notification
Check and perform the following settings.
- ▶ SMTP Settings
 - Set the following
 - SMTP: Server address (server name) (SMTP server)
 - From: e-mail address of the sender
 - User name: User name of the mail server
 - Password: Mail server password
- ▶ E-mail Settings
 - Subject
 - Contents
 - To: Enter the e-mail address of the sender.
 - Click "Apply" to fix the value.

Conditions	Conditions for sending	Title of e-mail
[Fan Lock]	Cooling fan has stopped	Fan Lock:xxx.xxx.xxx.xxx*
[Over Temperature]	Temperature of the unit is high	Over Temperature:xxx.xxx.xxx.xxx*
[Lamp Hours Running Out]	Usage time of the lamp has exceeded its life	Lamp Hours Running Out:xxx.xxx.xxx.xxx*
[Lamp Fail]	Lamp does not turn ON	Lamp Fail:xxx.xxx.xxx.xxx*

Enter the IP address of projector in *xxx.xxx.xxx.xxx.

Email Test

When you click [Email Test], test email will be sent.

The text will be "Email Test xxx.xxx.xxx.xxx *".

Even if an error occurs during the e-mail transmission, no error will appear in the web browser.

Crestron

You can use the control of projectors that uses Crestron.

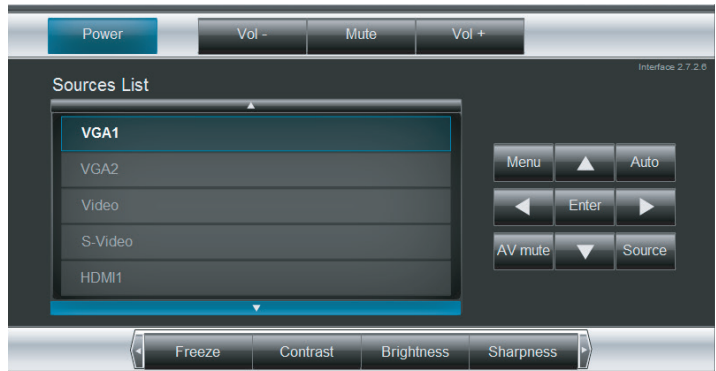

Note

❖ When projector is in standby mode, only the "Power" button will work.

- ▶ Power: Switch ON/OFF the power.
- ▶ Source List: Correspondence between the input display and input terminal of the device is as follows.
 - VGA1: Computer1
 - VGA2: Computer2
 - Video: Video
 - S-Video: S-Video
 - HDMI1: HDMI1/MHL
 - HDMI2: HDMI2
 - Displayport: DisplayPort
- ▶ Other buttons work in the same manner as Projector Control.

Crestron Tools

You can perform settings of the projector network and Crestron Room View.

Note

❖ After setting the user password, you will be able to access Crestron's page by entering the password.

❖ After enabling the Admin password, you will be able to access the page of Crestron tool only upon entering the Admin password.

Tools Info Contact IT Help

Crestron Control
Ip Address: 255.255.255.255
IP ID: 7
Port: 41794
Send

Projector
Projector Name: RICOH PJ X5580
Location:
Assigned To: Ricoh Projector
Send
DHCP: Enabled
Ip Address: 10.0.50.100
Subnet Mask: 255.255.0.0
Default Gateway: 10.0.0.254
DNS Server: 168.95.1.1
Send

User Password
 Enabled
New Password:
Confirm:
Send

Admin Password
 Enabled
New Password:
Confirm:
Send

exit

Crestron Info

You can display information about the firmware version of the projector and status of the lamp.

Tools Info Contact IT Help

Projector Information
DLP Name: RICOH PJ X5580
Location:
Firmware Version:
Mac Address: 00:60:E9:16:DF:EE
Resolution:
Lamp Hours: 0
Assigned To: Ricoh Projector

Projector Status
Power Status: Power On
Source: VGA1
Image: Presentation
Projection: Front-Desktop
Brightness Mode: Bright
Error Status: 0/No Error

exit

Note

❖ Crestron offers the following two types of files.

- a) RoomViewExpress_6_3_3_7.exe
- b) Xpanel.exe

Contacting the IT administrator of Crestron

You can contact the IT administrators who are using X-Panel.

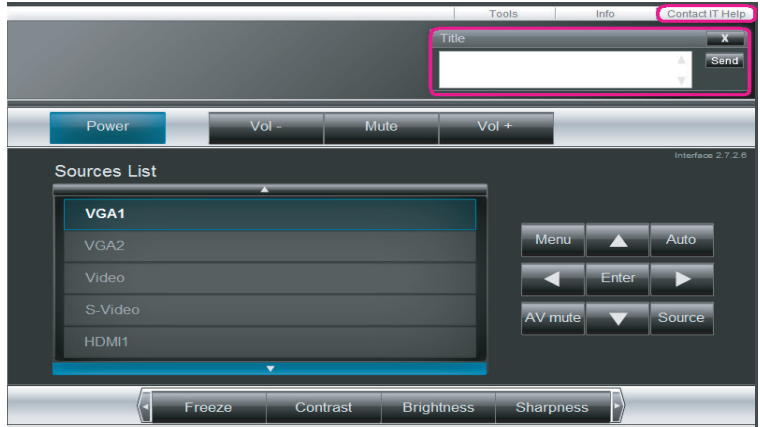

Reset to Default

You can reset the network to factory settings. Press the reflect button.

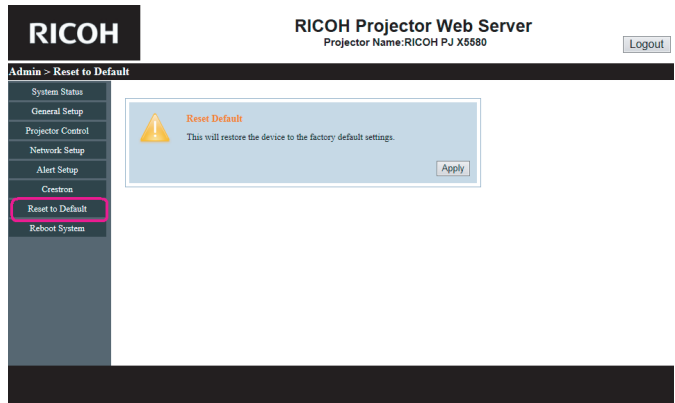

Reboot System

You can restart the system.
Press the restart button.

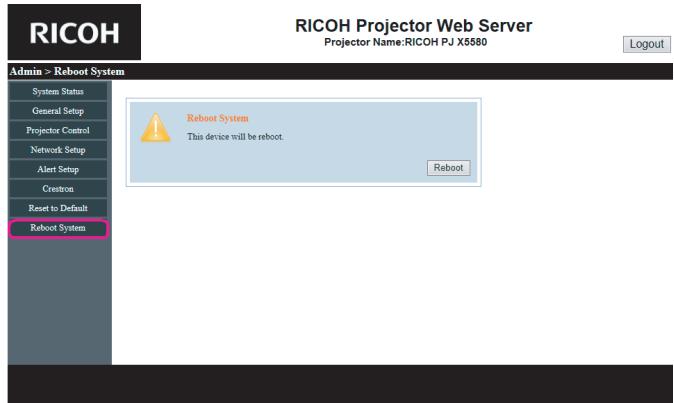

The screenshot displays the RICOH Projector Web Server interface. At the top left is the RICOH logo. To the right, it says "RICOH Projector Web Server" and "Projector Name: RICOH PJ X5580". A "Logout" button is in the top right corner. Below the header is a navigation sidebar with the following menu items: "Admin > Reboot System", "System Status", "General Setup", "Projector Control", "Network Setup", "Alert Setup", "Crestron", "Reset to Default", and "Reboot System". The "Reboot System" item is highlighted with a pink border. The main content area shows a light blue box with a yellow warning triangle icon, the text "Reboot System" in orange, and "This device will be reboot." Below this is a "Reboot" button.

Controlling the Device via the Projector Management Utility

Note

❖ This software is for managing our company's projector. When you manage projectors of other companies, it may not work properly. For more information, please refer to the help section of the utility.

❖ When you uninstall the projector management utility, use the program deletion function in the "Control Panel", and delete "Projector Management Utility".

Projector management utility

Projector management utility conforms with the standards of PJ Link class 1, and supports all the commands of class 1. One computer can manage up to 100 projectors connected to a network.

The operating environment of Projector Management Utility is as follows.

- Supported OS
 - Windows Vista Ultimate / Business / Home Premium / Home Basic (32bit /64bit)
 - Windows 7 Home Premium / Professional /Ultimate / Enterprise (32bit /64bit)
 - Windows 8 Pro / Enterprise (32bit /64bit)
 - Windows 8.1 Pro / Enterprise (32bit /64bit)
 - Windows Server 2008 Standard SP2 and later versions (32bit /64bit)
 - Windows Server 2008 R2 Standard SP1 and later versions (64bit)
- Memory size
Conforms to the recommended memory size of the OS that you are using
- Display resolution
800 × 600 pixels or more

Installing the projector management utility

Projector management utility is stored in the accompanying CD-ROM.

When you install or uninstall the utility, please log in with administrative rights.

1. Close all applications.
2. After setting the CD-ROM into the CD-ROM drive, click [X] in the language selection screen that appears and close the window.

LAN Control

3. Right-click the CD-ROM icon, and then select [Open].
 4. Open the "Projector Management Utility" folder in the CD-ROM.
 5. Double-click the setup.exe file in "Projector Management Utility" folder.
 6. Follow the instructions on the screen and perform the installation.
 7. When the installation is complete, click "Finish".
- Shortcut icon will be created on the desktop.

Registering a projector

1. Registering a projector with automatic search
Click the "Projector Registration" button.

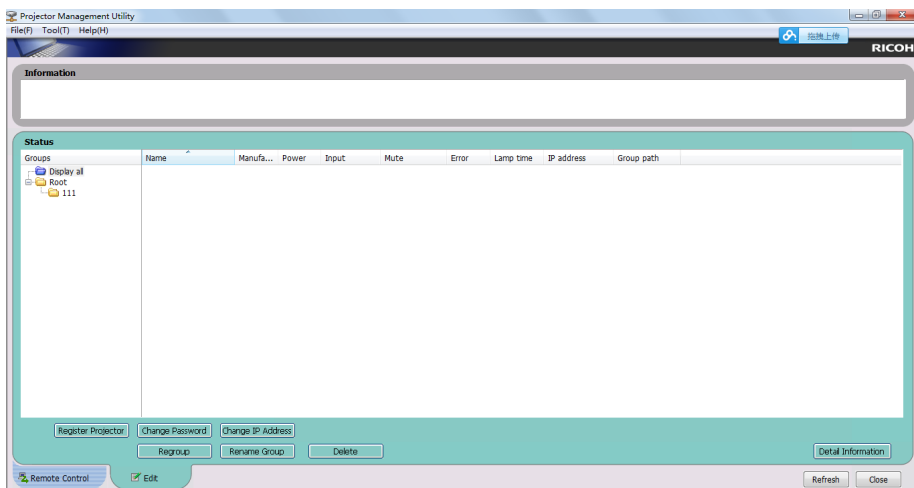

Click the "Auto Search" button.

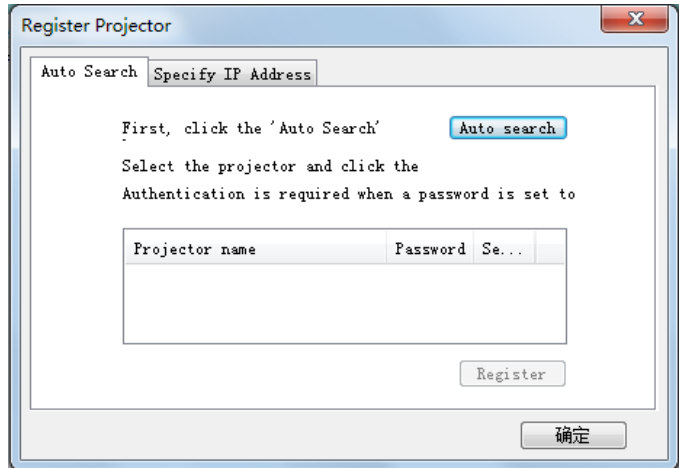

List of PJLink compatible projector in the network will be displayed. Select the projector you want to control, and then click the "Register" button.

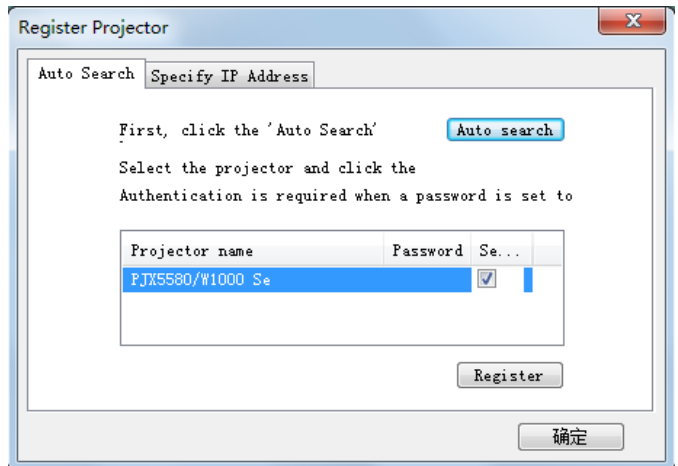

Return to the previous screen by clicking the [OK] button.

The registered projector will be displayed.

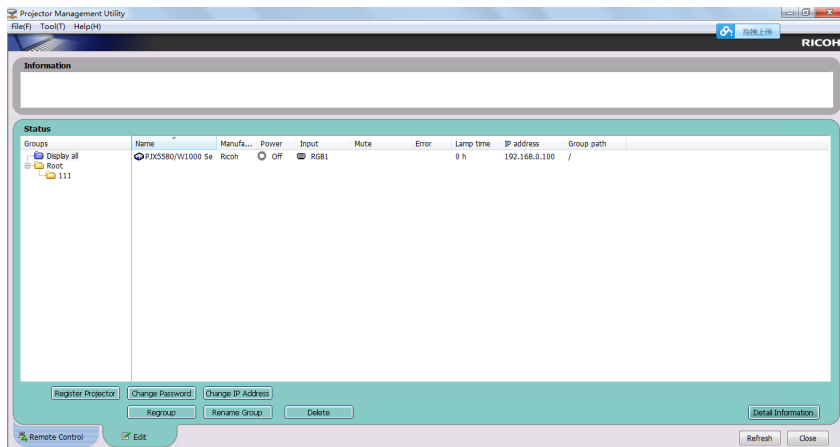

2. Registering a projector by directly entering the IP address.

Upon entering the IP address of the projector and clicking the "Confirm" button, the projector name will be displayed. If there is no problem, click the [Register] button. Projector will be registered.

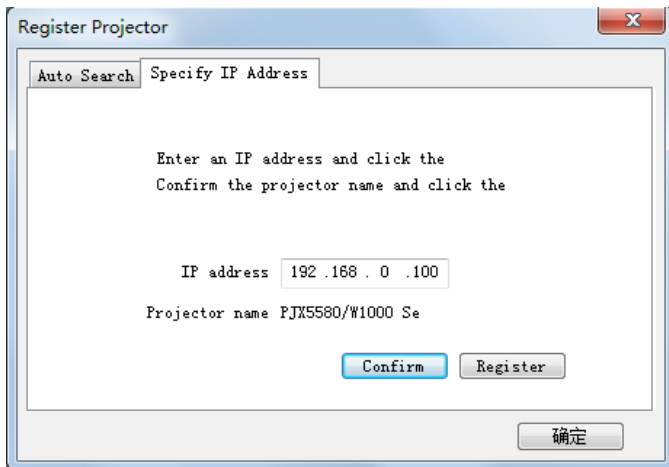

Return to the previous screen by clicking the [OK] button.

Controlling the projector with the projector management utility

To control the projector, switch to remote control screen by pressing the "Remote Control" tab. Select the projector (/ group) that you want to control from displayed list and control with the button at the bottom of the screen.

[Power] button

Turn "on/off" the power of the projector and group selected from the projectors (/ group) list.

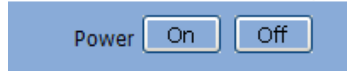

[Input Switch] button

Change the input of projector and group selected from the Projector (/ group) list. The input will not change if projector does not correspond to the specified input.

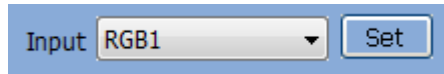

Correspondence between the input display of projector management utility of this device and the actual input signal is as follows.

Input name of this device	Input name of PJLink
Computer 1	RGB1
Computer 2	RGB2
Video	Video1
S-Video	Video2
HDMI1/MHL	Digital1
HDMI2	Digital2
DisplayPort	Digital3

[Mute] button

Turn "on/off" the mute function of the projector and group selected from the projectors (/ group) list. This device supports mute of video only or audio only. Therefore, mute will change upon selecting video or audio.

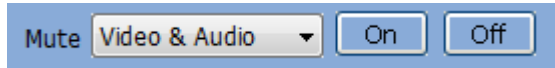

[Information] button

Detailed information screen for the selected projector will be displayed.

Controlling the projector with the projector management utility via PJ Link

1. Open the web page and select **General Setup**. Then configure PJ Link settings.
 - On the *PJLink Password* option, click **Enable** to enable this function.
 - On the *Current password* field, enter the current password.
 - On the *New password* and *Confirm password* fields, enter the new password.

The screenshot displays the RICOH Projector Web Server interface. The top header shows the RICOH logo and the text "RICOH Projector Web Server" with "Projector Name: PJX5580/W1000 Series" and a "Logout" button. A navigation menu on the left includes "System Status", "General Setup" (highlighted with a red box), "Projector Control", "Network Setup", "Alert Setup", "Crestron", "Reset to Default", and "Reboot System". The main content area is titled "Admin > General Setup" and contains several sections: "Projector Name" (PjX5580/W1000 Series), "Change Password for Webpage" (with fields for current, new, and confirm passwords), and "PJLink Setting". The "PJLink Setting" section includes a "PJLink Password" field with radio buttons for "Enable" (selected) and "Disable", and three password input fields (Current, New, Confirm) with an "Apply" button. A red box highlights the "Enable" radio button and the three password input fields.

When done, click **Apply** to save the settings.

2. Open the PJ Link software and click **Register Projector**.

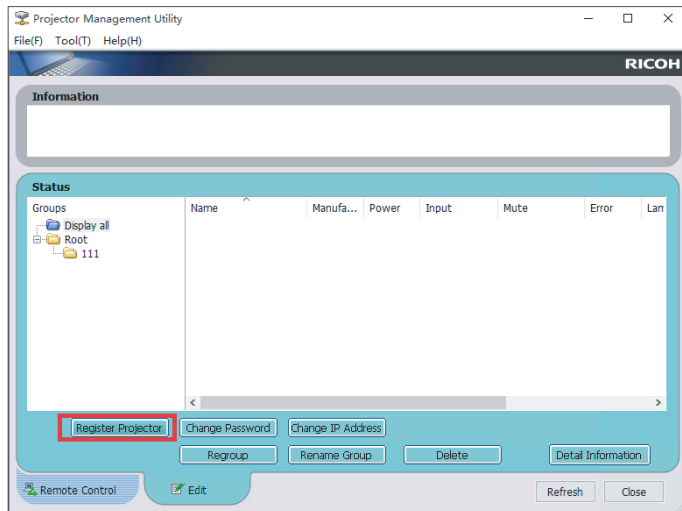

3. Click **Auto search**. List of PJLink compatible projectors in the network will be displayed.

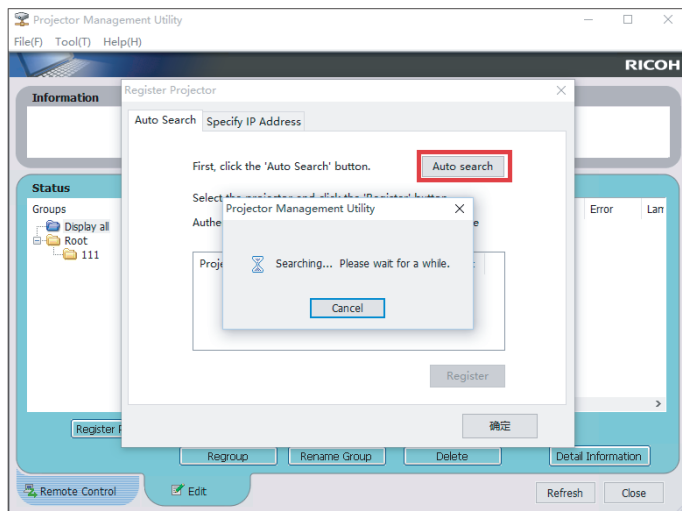

4. Select the projector you want to control and click **Register**.
When prompted, enter your password.

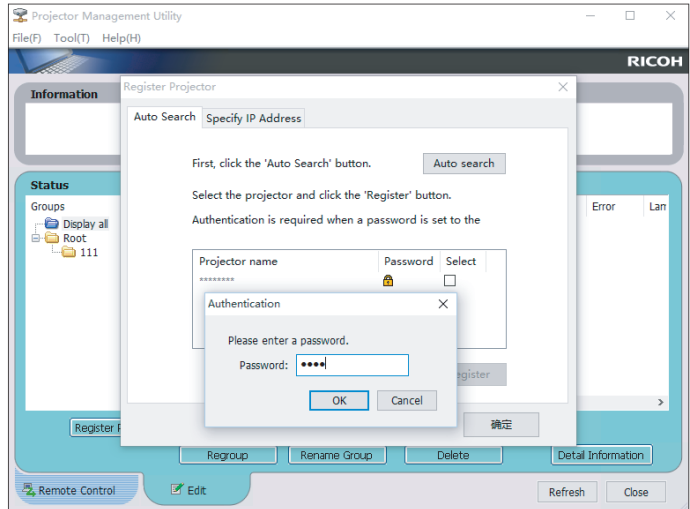

If the password verification is successful, the "unlock" icon will appear on the screen.

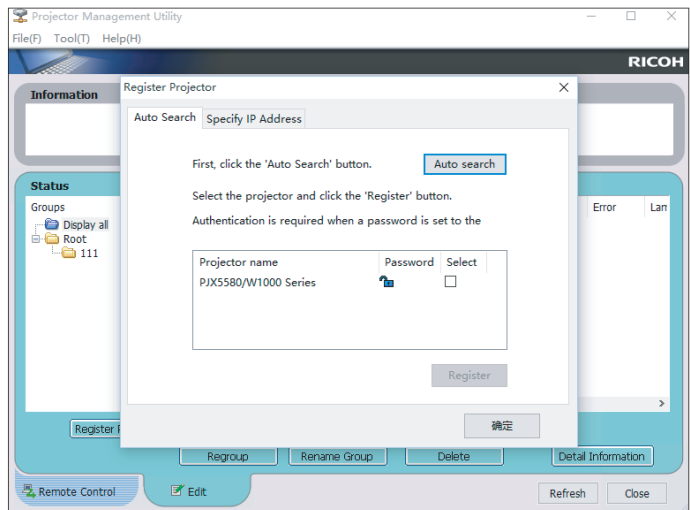

Troubleshooting

If you experience trouble with the projector, refer to the following information. If the problem persists, please contact your local dealer or service center.

Problem: No image appears on screen

- ▶ Ensure all the cables and power connections are correctly and securely connected as described in the “Connecting the Projector” section.
- ▶ Ensure the pins of terminals are not crooked or broken.
- ▶ Check if the projection lamp has been securely installed. Refer to the “Replacing the lamp” section for more information.
- ▶ Make sure you have removed the lens cap and the projector is switched on.
- ▶ Ensure that the “AV Mute” feature is not turned on.

Problem: Partial, scrolling or incorrectly displayed image

- ▶ Press “Auto Set” on the remote control.
- ▶ Adjust the computer display settings. Verify the resolution setting is less than or equal to 1600 x 1200 resolution. See your operating system’s Help file.
- ▶ If you are using a Notebook:
 1. First, follow the steps above to adjust resolution of the computer.
 2. Press the toggle output settings. For example: [Fn]+[F3]

PANASONIC, NEC => Fn+F3
HP, SHARP, TOSHIBA => Fn+F5
IBM, SONY => Fn+F7
DELL, EPSON => Fn+F8
FUJITSU => Fn+F10
APPLE =>F7

- ▶ If you experience difficulty changing resolutions or your monitor freezes, restart all equipment including the projector.

Problem: The screen of the Notebook computer is not displaying a presentation

▶ If you are using a Notebook PC:

Some Notebook PCs may deactivate their own screens when a second display device is in use. Each has a different way to be reactivated. Refer to your computer's documentation for detailed information.

Problem: Image is unstable or flickering

- ▶ Adjust the "Phase" or "Clock" to correct it. Refer to the "H. Position" or "V. Position" section for more information.
- ▶ Check and reconfigure the display mode of your graphic card to make it compatible with the product.

Problem: Image is out of focus

- ▶ Adjust the Focus Ring on the projector lens.
- ▶ Make sure the projection screen is between the required distance. (refer to pages 36~37)

Problem: The image is stretched when displaying 16:9 DVD

Change the aspect ratio by pressing the "Aspect" button on the remote control or select "SCREEN > Aspect Ratio" from the OSD menu to show image with proper aspect ratio.

Problem: Image is too small or too large

- ▶ Adjust the Zoom lever on the top of the projector.
- ▶ Move the projector closer to or further from the screen.
- ▶ Press the "Aspect" button on the remote control or press the "Menu" button on the projector panel, go to "SCREEN > Aspect Ratio" and try the different settings.

Troubleshooting

Problem: Image is reversed





















- ▶ Select "SCREEN > Projection Mode" from the OSD menu to adjust the image.

Problem: Lamp burns out or makes a popping sound



- ▶ When the lamp reaches its end of life, it will burn out and may make a loud popping sound. If this happens, the projector will not turn on until the lamp module has been replaced. To replace the lamp, follow the procedures in the "Replacing the Lamp".

Troubleshooting

Problem: Indicator lighting message

Message	POWER indicator	TEMP indicator	LAMP indicator
	(Red/Blue)	(Red)	(Red)
Standby (Input power cord)	 (Red)		
Normal (Power on)	 (Blue)		
Powering up (Warming up)	Flashing Blue (0.5 sec)		
Power off (Cooling Down)	Flashing Red (0.5 sec)		
Programming	 (Blue and Red)		
Temperature Error (Over temperature)	 (Blue)		
Lamp Error (Lamp failed)	 (Blue)		
Fan Error (Fan failed)	 (Blue)	Flashing (0.5 sec)	

Note

Steady light => 
No light => 

Troubleshooting

Problem: Message Reminders

- ▶ Temperature Error - the projector is overheat inside. Check the environmental condition.

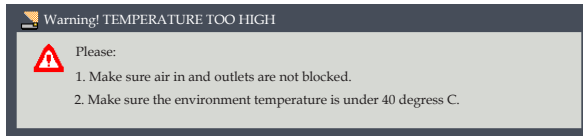

- ▶ Replacing the lamp - the lamp is about to reach its maximum lifetime. Prepare to replace it soon.

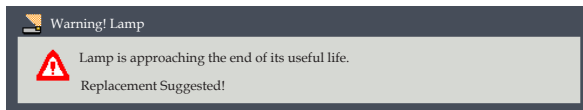

- ▶ Fan Error - the cooling system fan is not working.

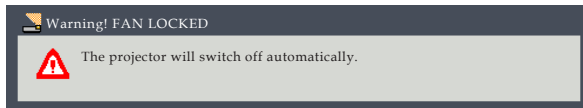

- ▶ Replacing the filter - the filter is about to reach its maximum usage time. Clean or replace the filter soon.



Replacing the lamp

The projector will detect the lamp life itself. It will show you a warning message

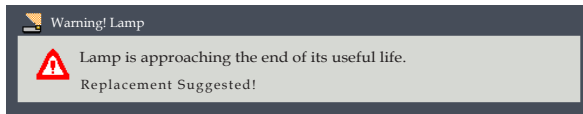

Warning: To avoid burns, allow the projector to cool for at least 60 minutes before you replace the lamp!



Warning: Do not drop the lamp module or touch the glass parts. The glass parts may shatter and cause injury if it is dropped.

Warning: For continued safety replace with Replacement Lamp Type 22.

Caution: If the lamp should break, handle with care to avoid injury due to broken pieces and contact your sales representative for repair service.

When you see this message, change the lamp as soon as possible. Make sure the projector has been cooled down for at least 60 minutes before changing the lamp.

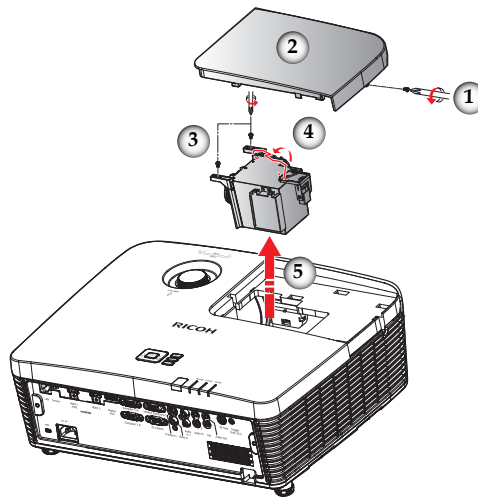

Lamp Replacing Procedure:

1. Switch off the power to the projector by pressing the "O" button.
 2. Allow the projector to cool down at least 60 minutes.
 3. Disconnect the power cord.
 4. Remove the screw on the lamp cover. ①
 5. Slide the lamp cover to the side and remove the cover. ②
 6. Remove the 2 screws on the lamp module. ③
 7. Lift up the lamp handle. ④
 8. Carefully remove the lamp module. ⑤
 9. Install the new lamp module by reversing the previous steps.
- See the lamp's manual for instructions on resetting the lamp time.

Used Lamps

This projector's lamp contains trace amounts of environmentally harmful inorganic mercury. Be careful not to break used lamps, and dispose of them in accordance with local regulations or contact your sales representative.

List of Compatible Signals

A. VGA Analog			
(1) VGA Analog - PC Signal			
Modes	Resolution	V.Frequency (Hz)	H.Frequency (kHz)
VGA	640 x 480	60	31.47
	640 x 480	72	37.86
	640 x 480	75	37.5
	640 x 480	85	43.27
SVGA	800 x 600	56	35.2
	800 x 600	60	37.88
	800 x 600	72	48.08
	800 x 600	75	46.88
	800 x 600	85	53.67
XGA	1024 x 768	60	48.36
	1024 x 768	70	56.48
	1024 x 768	75	60.02
	1024 x 768	85	68.67
SXGA	1152 x 864	70	63.8
	1152 x 864	75	67.5
	1152 x 864	85	77.1
	1280 x 1024	60	63.98
	1280 x 1024	72	77.9
	1280 x 1024	75	79.98
	1280 x 1024	85	91.15
Quad VGA	1280 x 960	60	60
	1280 x 960	75	75
SXGA+	1400 x 1050	60	65.32
UXGA	1600 x 1200	60	75
WUXGA(RB)	1920x1200	60	74.038
PowerBook G4	640 x 480	60	31.5
	640 x 480	66.6(67)	35
	800 x 600	60	37.88
	1024 x 768	60	48.36
	1152 x 870	75	68.68
	1280 x 960	75	75.2
i Mac DV(G3)	1024 x 768	75	60.3

Appendices

A. VGA Analog			
(2) VGA Analog - Extended Wide Timing			
Modes	Resolution	V.Frequency (Hz)	H.Frequency (kHz)
WSVGA	1024 x 600	60	37.3
WXGA	1280 x 768	60	47.78
	1280 x 768	75	60.29
	1280 x 768	85	68.63
	1280 x 720	60	44.8
	1280 x 800	60	49.6
	1366 x 768	60	47.71
WXGA+	1440 x 900	60	55.9
WSXGA	1680 x 1050	60	65.3
WUXGA	1920 x 1080-RB	60	66.6
	1920 x 1080-EIA	60	67.5
(3) VGA Analog - Component Signal			
480i	720 x 480	59.94(29.97)	27
480p	720 x 480	59.94	31.47
576i	720 x 576	50(25)	27
576p	720 x 576	50	31.25
720p	1280 x 720	60	45
720p	1280 x 720	50	37.5
1080i	1920 x 1080	60(30)	33.75
1080i	1920 x 1080	50(25)	33.75
1080p	1920 x 1080	60	67.5
1080p	1920 x 1080	50	56.25

Appendices

B. HDMI			
(1) HDMI and Displayport - PC Signal			
Modes	Resolution	V.Frequency (Hz)	H.Frequency (kHz)
VGA	640 x 480	60	31.47
	640 x 480	72	37.86
	640 x 480	75	37.5
	640 x 480	85	43.27
SVGA	800 x 600	56	35.2
	800 x 600	60	37.88
	800 x 600	72	48.08
	800 x 600	75	46.88
	800 x 600	85	53.67
XGA	1024 x 768	60	48.36
	1024 x 768	70	56.48
	1024 x 768	75	60.02
	1024 x 768	85	68.67
SXGA	1152 x 864	70	63.8
	1152 x 864	75	67.5
	1152 x 864	85	77.1
	1280 x 1024	60	63.98
	1280 x 1024	72	77.9
	1280 x 1024	75	79.98
	1280 x 1024	85	91.15
Quad VGA	1280 x 960	60	60
	1280 x 960	75	75
SXGA+	1400 x 1050	60	65.32
UXGA	1600 x 1200	60	75
WUXGA(RB)	1920x1200	60	74.038
PowerBook G4	640 x 480	60	31.5
	640 x 480	66.6(67)	35
	800 x 600	60	37.88
	1024 x 768	60	48.36
	1152 x 870	75	68.68
	1280 x 960	75	75.2
i Mac DV(G3)	1024 x 768	75	60.3

Appendices

B. HDMI			
(2) HDMI - Extended Wide Timing			
Modes	Resolution	V.Frequency (Hz)	H.Frequency (kHz)
WSVGA	1024 x 600	60	37.3
WXGA	1280 x 768	60	47.78
	1280 x 768	75	60.29
	1280 x 768	85	68.63
	1280 x 720	60	44.8
	1280 x 800	60	49.6
	1366 x 768	60	47.71
WXGA+	1440 x 900	60	55.9
WSXGA	1680 x 1050	60	65.3
WUXGA	1920 x 1080-RB	60	66.6
	1920 x 1080-EIA	60	67.5
	1920 x 1200-RB	59.95	74.04
(3) HDMI - Video Signal			
480i	720 x 480	59.94(29.97)	27
480p	720 x 480	59.94	31.47
576i	720 x 576	50(25)	27
576p	720 x 576	50	31.25
720p	1280 x 720	60	45
720p	1280 x 720	50	37.5
1080i	1920 x 1080	60(30)	33.75
1080i	1920 x 1080	50(25)	33.75
1080p	1920 x 1080	60	67.5
1080p	1920 x 1080	50	56.25
1080p	1920 x 1080	23.97/ 24	27

Appendices

C. 3D Timing				
Input Resolutions	HDMI 3D Input (with 3D Info Frame information)	Input timing		
		1280 X 720P @ 50Hz	Top - and - Bottom	
		1280 X 720P @ 60Hz	Top - and - Bottom	
		1280 X 720P @ 50Hz	Frame packing	
		1280 X 720P @ 60Hz	Frame packing	
		1920 X 1080i @ 50 Hz	Side- by-Side (Half)	
		1920 X 1080i @ 60 Hz	Side- by-Side (Half)	
		1920 X 1080P @ 24 Hz	Top - and - Bottom	
	1920 X 1080P @ 24 Hz	Frame packing		
	HDMI 3D Input (without 3D Info Frame information)	1920 x 1080i @ 50Hz	Side-by-Side (Half)	SBS mode is on
		1920 x1080i @ 60Hz		
		1280 x 720P @ 50Hz		
		1280 x 720P @ 60Hz		
		1920 x 1080i @ 50Hz	Top-and-Bottom	TAB mode is on
		1920 x1080i @ 60Hz		
		1280 x 720P @ 50Hz		
		1280 x 720P @ 60Hz		
	480i	HQFS		
	VGA (PC)	800x600 @ 60Hz	SBS or TAB	
		1024x768 @ 60Hz		
		800x600 @ 120Hz	Frame Sequential	
		1024x768 @ 120Hz		
	Composite	NTSC	HQFS	
	S-Video	NTSC	HQFS	

Configurations of Terminals

Terminal: Computer In 1/2 (Mini D-sub 15 pin) [Monitor Out]

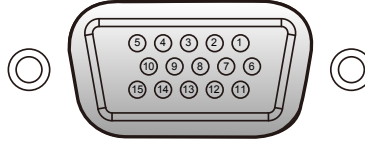

1	Red (R/Cr) Input [R Output]	9	DDC 5V [NC*]
2	Green (G/Y) Input [G Output]	10	Ground (Ver. sync.)
3	Blue (B/Cb) Input [B Output]	11	NC*
4	NC*	12	DDC Data [NC*]
5	Ground (Horiz.sync.)	13	Horiz. sync. Input [Output] (Composite H/V sync. Input)
6	Ground (Red)		
7	Ground (Green)	14	Vert. sync. Input [Output]
8	Ground (Blue)	15	DDC CLK [NC*]

* Do not connect anything.

Terminal: PC Control (D-sub 9 pin)

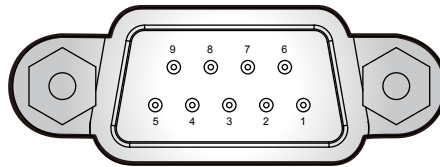

1	NC*	6	NC*
2	TXD (Sending Data)	7	NC*
3	RXD (Receiving Data)	8	NC*
4	NC*	9	NC*
5	GND	* Do not connect anything.	

Note

- ❖ Contact your dealer for control cable and commands.

Terminal: VESA 3D sync

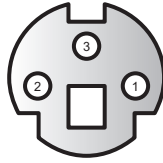

1	+ 5V DC @ 750 mA	3	Stereo Sync(TTL)
2	Ground		

Specifications

■ List of general specifications

Item	PJ X5580	PJ WU5570
DLP chip	0.70" XGA	0.67" WUXGA
Lamp Type	365W	
Projection Lens	1.8X Manual Zoom Lens and Manual Focus	
Projection Distance (Focus range)	1.0~13.5m	1.0~13.8m
Throw Ratio (distance/width @ 80")	1.243 (wide) ~ 2.238 (tele)	1.2 (wide) ~ 2.16 (tele)
Dimension (WxDxH)	424 x 356 x 150 mm (w/o feet)	
	424 x 356 x 160 mm (with feet)	
Weight	Less than 6.35kg	
I/O Terminal	<ul style="list-style-type: none"> • LAN • Service • HDMI 1/MHL • HDMI 2 • DisplayPort • Computer 1 In • Computer 2 In • Monitor Out • PC Control • S-Video In • Video In 	<ul style="list-style-type: none"> • Audio In 1 (Video and S-Video) Left/Mono • Audio In 1 (Video and S-Video) Right • Audio In 2 (Computer 1) • Audio In 3 (Computer 2) • Audio Out • Microphone jack • 3D Sync • Trigger Out (+12v)
Speaker	10W	
Lamp life	Normal: 3000 hours ECO: 4000 hours	
Noise Level (Typ.)	Full: 35dB(A) ECO: 32dB(A)	
Standby Power (Monitor Out Off)	0.5W or less (Monitor Out Off) / 1.0W or less (Monitor Out On)	
Environment	<ul style="list-style-type: none"> • Operational Temperatures: 41° to 104°F (5° to 40°C); 20% to 80% humidity (non-condensing) • Storage Temperatures: -4° to 140°F (-20° to 60°C); 20% to 80% humidity (non-condensing) 	
Power Consumption	<ul style="list-style-type: none"> • Eco Mode: Typ. 360W, max. 395W @ 110Vac; Typ. 350W, max. 385W @ 220Vac • Full Mode: Typ. 450W, max. 495W @ 110Vac; Typ. 425W, max. 470W @ 220Vac 	

Note

- This model complies with the above specifications.
- Designs and specifications are subject to change without notice.
- This model may not be compatible with features and/or specifications that may be added in the future.

■ Separately sold product

PJ Replacement Lamp Type 22

Cabinet Dimensions

Unit: mm

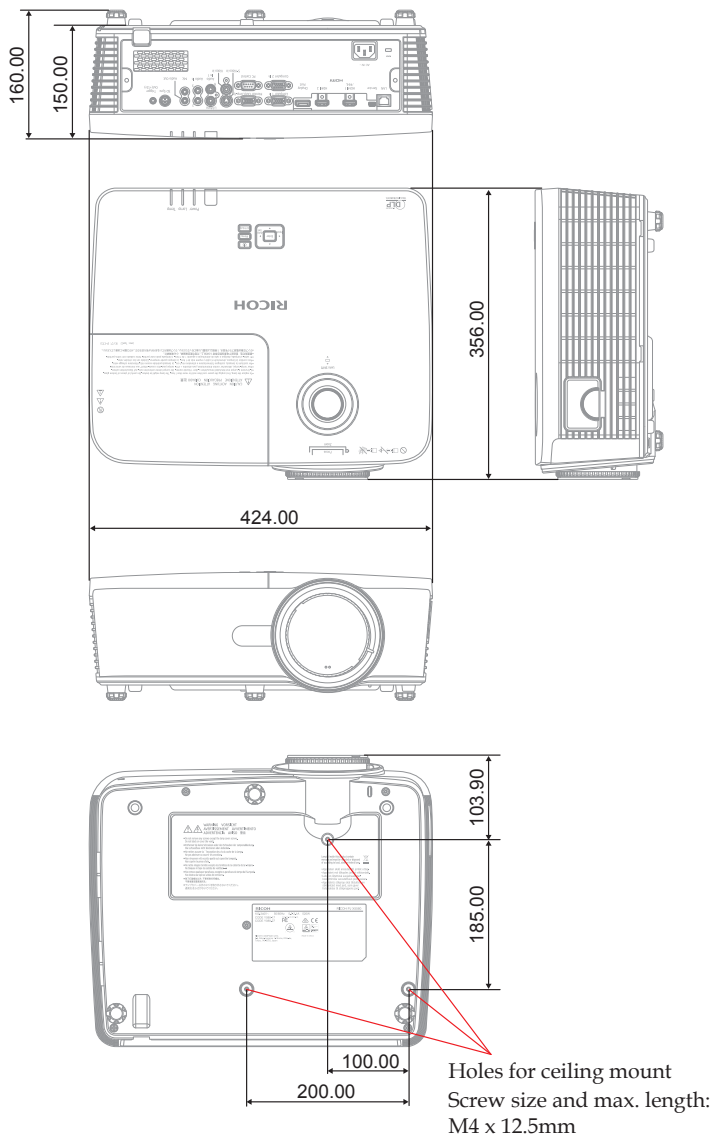

Trademarks

- DLP is trademarks or registered trademark of Texas Instruments.
- IBM is a trademark or registered trademark of International Business Machines Corporation.
- Macintosh, Mac OS X, iMac, and PowerBook are trademarks of Apple Inc., registered in the U.S. and other countries.
- Microsoft, Windows, Windows Vista, Internet Explorer and PowerPoint are either a registered trademark or trademark of Microsoft Corporation in the United States and/or other countries.
- HDMI, the HDMI Logo and High-Definition Multimedia Interface are trademarks or registered trademarks of HDMI Licensing LLC.
- DisplayPort, DisplayPort Compliance Logo are registered trademarks of Video Electronics Standards Association.
- MHL, Mobile High-Definition Link, and MHL Logo are trademarks or registered trademarks of MHL, LLC.
- Kensington is a trademark or registered trademark of ACCO Brands.
- Blu-ray is a trademark of Blu-ray Association.
- Other product and company names mentioned in this user's manual may be the trademarks or registered trademarks of their respective holders.