

# **GIGABYTE™**

# **W331-Z00**

AMD Ryzen™ Tower Entry Workstation

## **User Manual**

Rev. 1.0

## **Copyright**

© 2021 GIGA-BYTE TECHNOLOGY CO., LTD. All rights reserved.

The trademarks mentioned in this manual are legally registered to their respective owners.

## **Disclaimer**

Information in this manual is protected by copyright laws and is the property of GIGABYTE. Changes to the specifications and features in this manual may be made by GIGABYTE without prior notice. No part of this manual may be reproduced, copied, translated, transmitted, or published in any form or by any means without GIGABYTE's prior written permission.

## **Documentation Classifications**

In order to assist in the use of this product, GIGABYTE provides the following types of documentation:

- User Manual: detailed information & steps about the installation, configuration and use of this product (e.g. motherboard, server barebones), covering hardware and BIOS.
- User Guide: detailed information about the installation & use of an add-on hardware or software component (e.g. BMC firmware, rail-kit) compatible with this product.
- Quick Installation Guide: a short guide with visual diagrams that you can reference easily for installation purposes of this product (e.g. motherboard, server barebones).

Please see the support section of the online product page to check the current availability of these documents.

## **For More Information**

For related product specifications, the latest firmware and software, and other information please visit our website at <http://www.gigabyte.com>

For GIGABYTE distributors and resellers, additional sales & marketing materials are available from our reseller portal: <http://reseller.b2b.gigabyte.com>

For further technical assistance, please contact your GIGABYTE representative or visit <https://esupport.gigabyte.com/> to create a new support ticket

For any general sales or marketing enquiries, you may also message GIGABYTE server directly by email: [server.grp@gigabyte.com](mailto:server.grp@gigabyte.com)

## Conventions

The following conventions are used in this user's guide:

	<b>NOTE!</b> Gives bits and pieces of additional information related to the current topic.
	<b>CAUTION!</b> Gives precautionary measures to avoid possible hardware or software problems.
	<b>WARNING!</b> Alerts you to any damage that might result from doing or not doing specific actions.

## Warnings and Cautions

Before installing, be sure that you understand the following warnings and cautions.



### **WARNING!**

**To reduce the risk of electric shock or damage to the equipment:**

- Do not disable the power cord grounding plug. The grounding plug is an important safety feature.
- Plug the power cord into a grounded (earthed) electrical outlet that is easily accessible at all times.
- Unplug all the power cords from the power supplies to disconnect power to the equipment.
- Shock Hazard! Disconnect all power supply cords before servicing.
- Do not route the power cord where it can be walked on or pinched by items placed against it. Pay particular attention to the plug, electrical outlet, and the point where the cord extends from the server.



### **WARNING!**

**To reduce the risk of personal injury from hot surfaces, allow the drives and the internal system components to cool before touching them.**



### **CAUTION!**

- Do not operate the system for long periods with the access panel open or removed. Operating the system in this manner results in improper airflow and improper cooling that can lead to thermal damage.
- Danger of explosion if battery is incorrectly replaced.
- Replace only with the same or equivalent type recommended by the manufacturer.
- Dispose of used batteries according to the manufacturer's instructions.

## Electrostatic Discharge (ESD)



### CAUTION!

ESD CAN DAMAGE DRIVES, BOARDS, AND OTHER PARTS. WE RECOMMEND THAT YOU PERFORM ALL PROCEDURES AT AN ESD WORKSTATION. IF ONE IS NOT AVAILABLE, PROVIDE SOME ESD PROTECTION BY WEARING AN ANTI-STATIC WRIST STRAP ATTACHED TO CHASSIS GROUND -- ANY UNPAINTED METAL SURFACE -- ON YOUR SERVER WHEN HANDLING PARTS.

Always handle boards carefully. They can be extremely sensitive to ESD. Hold boards only by their edges without any component and pin touching. After removing a board from its protective wrapper or from the system, place the board component side up on a grounded, static free surface. Use a conductive foam pad if available but not the board wrapper. Do not slide board over any surface.

**System power on/off:** To remove power from system, you must remove the system from rack. Make sure the system is removed from the rack before opening the chassis, adding, or removing any non hot-plug components.

**Hazardous conditions, devices and cables:** Hazardous electrical conditions may be present on power, telephone, and communication cables. Turn off the system and disconnect the cables attached to the system before servicing it. Otherwise, personal injury or equipment damage can result.

**Electrostatic discharge (ESD) and ESD protection:** ESD can damage drives, boards, and other parts. We recommend that you perform all procedures in this chapter only at an ESD workstation. If one is not available, provide some ESD protection by wearing an antistatic wrist strap attached to chassis ground (any unpainted metal surface on the server) when handling parts.

**ESD and handling boards:** Always handle boards carefully. They can be extremely sensitive to electrostatic discharge (ESD). Hold boards only by their edges. After removing a board from its protective wrapper or from the system, place the board component side up on a grounded, static free surface. Use a conductive foam pad if available but not the board wrapper. Do not slide board over any surface.

**Installing or removing jumpers:** A jumper is a small plastic encased conductor that slips over two jumper pins. Some jumpers have a small tab on top that can be gripped with fingertips or with a pair of fine needle nosed pliers. If the jumpers do not have such a tab, take care when using needle nosed pliers to remove or install a jumper; grip the narrow sides of the jumper with the pliers, never the wide sides. Gripping the wide sides can damage the contacts inside the jumper, causing intermittent problems with the function controlled by that jumper. Take care to grip with, but not squeeze, the pliers or other tool used to remove a jumper, or the pins on the board may bend or break.

**CAUTION!**

Risk of explosion if battery is replaced incorrectly or with an incorrect type. Replace the battery only with the same or equivalent type recommended by the manufacturer. Dispose of used batteries according to the manufacturer's instructions.

## Regulatory Notices

### WEEE Symbol Statement



The symbol shown below is on the product or on its packaging, which indicates that this product must be disposed of with other waste. Instead, the device should be taken to the waste collection centers for activation of the treatment, collection, recycling and disposal procedure. The separate collection and recycling of your waste equipment at the time of disposal will help to conserve natural resources and ensure that it is recycled in a manner that protects human health and the environment.

For more information about where you can drop off your waste equipment for recycling, please contact your local government office, your household waste disposal service or where you purchased the product for details of environmentally safe recycling.

- When your electrical or electronic equipment is no longer useful to you, "take it back" to your local or regional waste collection administration for recycling.

### Restriction of Hazardous Substances (RoHS) Directive Statement

GIGABYTE products have not intended to add and safe from hazardous substances (Cd, Pb, Hg, Cr+6, PBDE and PBB). The parts and components have been carefully selected to meet RoHS requirement. Moreover, we at GIGABYTE are continuing our efforts to develop products that do not use internationally banned toxic chemicals.

### California Proposition 65 Warning



#### **WARNING!**

This product can expose you to chemicals including Lead, which is known to the State of California to cause cancer, and Bisphenol A (BPA), which is known to the State of California to cause birth defects or other reproductive harm. For more information go to [www.P65Warnings.ca.gov](http://www.P65Warnings.ca.gov).



#### **Battery WARNING!**

This product can expose you to chemicals including Lead, which is known to the State of California to cause cancer, and Bisphenol A (BPA), which is known to the State of California to cause birth defects or other reproductive harm. For more information go to [www.P65Warnings.ca.gov](http://www.P65Warnings.ca.gov).

# Table of Contents

Chapter 1	Hardware Installation .....	10
1-1	Installation Precautions .....	10
1-2	Product Specifications .....	11
1-3	System Block Diagram .....	14
Chapter 2	System Appearance .....	15
2-1	Front View .....	15
2-2	Rear View .....	16
2-3	Rear Panel System LAN LEDs .....	17
Chapter 3	System Hardware Installation .....	18
3-1	Removing and Installing the Chassis Cover .....	19
3-2	Installing the CPU .....	20
3-3	Installing the Memory .....	21
3-3-1	Dual Channel Memory Configuration .....	21
3-3-2	Installing the Memory .....	22
3-4	Installing the PCI Expansion Card .....	23
3-5	Installing the Hard Disk Drive .....	24
3-6	Installing and Removing the M.2 SSD Module .....	25
3-7	Installing and Removing the M.2 WiFi Module .....	25
3-8	Peripheral Devices Connection .....	26
Chapter 4	Motherboard Components .....	27
4-1	Motherboard Components .....	27
4-2	Jumper Setting .....	29
Chapter 5	BIOS Setup .....	30
5-1	The Main Menu .....	32
5-2	Advanced Menu .....	34
5-2-1	DASH Configuration .....	35
5-2-2	MCTP Configuration .....	36
5-2-3	Trusted Computing .....	37
5-2-4	ASF Configuration .....	39
5-2-5	Super IO Configuration .....	40
5-2-6	Hardware Monitor .....	42
5-2-7	S5 RTC Wake Settings .....	43
5-2-8	Serial Port Console Redirection .....	44



5-2-9	CPU Configuration.....	48
5-2-10	Network Stack Configuration .....	49
5-2-11	CSM Configuration .....	50
5-2-12	Info Report Configuration .....	51
5-2-13	NVMe Configuration .....	52
5-2-14	Offboard SATA Controller Configuration .....	53
5-2-15	SATA Configuration.....	54
5-2-16	Realtek PCIe GBE Family Controller.....	55
5-3	Chipset Setup Menu.....	56
5-3-1	AMD PSP KVM Configuration .....	58
5-4	Security Menu .....	59
5-4-1	Secure Boot .....	60
5-5	Boot Menu.....	62
5-6	Save & Exit Menu.....	63
5-7	BIOS POST Beep code (AMI standard).....	64
5-7-1	PEI Beep Codes .....	64
5-7-2	DXE Beep Codes .....	64

# Chapter 1 Hardware Installation

## 1-1 Installation Precautions

The motherboard/system contain numerous delicate electronic circuits and components which can become damaged as a result of electrostatic discharge (ESD). Prior to installation, carefully read the user manual and follow these procedures:











- Prior to installation, do not remove or break motherboard S/N (Serial Number) sticker or warranty sticker provided by your dealer. These stickers are required for warranty validation.
- Always remove the AC power by unplugging the power cord from the power outlet before installing or removing the motherboard or other hardware components.
- When connecting hardware components to the internal connectors on the motherboard, make sure they are connected tightly and securely.
- When handling the motherboard, avoid touching any metal leads or connectors.
- It is best to wear an electrostatic discharge (ESD) wrist strap when handling electronic components such as a motherboard, CPU or memory. If you do not have an ESD wrist strap, keep your hands dry and first touch a metal object to eliminate static electricity.
- Prior to installing the motherboard, please have it on top of an antistatic pad or within an electrostatic shielding container.
- Before unplugging the power supply cable from the motherboard, make sure the power supply has been turned off.
- Before turning on the power, make sure the power supply voltage has been set according to the local voltage standard.
- Before using the product, please verify that all cables and power connectors of your hardware components are connected.
- To prevent damage to the motherboard, do not allow screws to come in contact with the motherboard circuit or its components.
- Make sure there are no leftover screws or metal components placed on the motherboard or within the computer casing.
- Do not place the computer system on an uneven surface.
- Do not place the computer system in a high-temperature environment.
- Turning on the computer power during the installation process can lead to damage to system components as well as physical harm to the user.
- If you are uncertain about any installation steps or have a problem related to the use of the product, please consult a certified computer technician.

## 1-2 Product Specifications



### NOTE:

We reserve the right to make any changes to the product specifications and product-related information without prior notice.

 System Dimension	<ul style="list-style-type: none"><li>◆ Mini-Tower</li><li>◆ 375 x 198 x 370 mm</li></ul>
 CPU	<ul style="list-style-type: none"><li>◆ AMD Ryzen™ 5000 Series/ 3rd Gen Ryzen™ Processors</li></ul>
 Chipset	<ul style="list-style-type: none"><li>◆ AMD® B550</li></ul>
 Memory	<ul style="list-style-type: none"><li>◆ 4 x DDR4 DIMM sockets supporting up to 128 GB (32 GB single DIMM capacity) of system memory</li><li>◆ Dual channel memory architecture</li><li>◆ Supported ECC Un-buffered DIMM 1Rx8/2Rx8 memory modules</li><li>◆ Supported non-ECC Un-buffered DIMM 1Rx8/2Rx8/1Rx16 memory modules</li><li>◆ Memory speed: Up to 3200/ 2933/ 2667/ 2400/ 2133 MHz</li></ul>
 LAN	<ul style="list-style-type: none"><li>◆ 2 x GbE LAN ports (Realtek® RTL8111EPV and RTL8118)</li></ul>
 Video	<ul style="list-style-type: none"><li>◆ 1 x DP port: supporting maximum resolution of 4096x2160 @60Hz; Support for DP 1.2 version</li><li>◆ 1 x HDMI port: supporting maximum resolution of 4096x2160 @60Hz; Support for HDMI 2.1 version, HDCP 2.3, HDR</li></ul>
 Audio	<ul style="list-style-type: none"><li>◆ Realtek® ALC897 audio codec</li><li>◆ High Definition audio; 2/4/5.1/7.1-channel</li><li>◆ 3 ports Audio Jack (Line in/Line out/Mic)</li></ul>
 Storage	<ul style="list-style-type: none"><li>◆ 2 x 3.5" fixed drive bays</li></ul>
 RAID	<ul style="list-style-type: none"><li>◆ N/A</li></ul>
 Peripheral Drives	<ul style="list-style-type: none"><li>◆ ODD drive in option</li></ul>



#### Expansion Slot

- ◆ 1 x PCIe x16 (Gen4 x16) slot; integrated in CPU
- ◆ 1 x PCIe x16 (Gen3 x4) slot; integrated in chipset
- ◆ 1 x PCIe x1 (Gen3 x1) slot; integrated in chipset
  
- ◆ 2 x M.2 slot for storage:
  - M-key
  - PCIe Gen4 x4; PCIe Gen3x2 / SATA III 6Gb/s
  - Supports NGFF-2242/2280 card
  
- ◆ 1 x M.2 slot for Wi-Fi:
  - E-key
  - Supports NGFF-2230 card



#### Internal I/O

- ◆ 1 x 24-pin ATX main power connector
- ◆ 1 x 8-pin ATX 12V power connector
- ◆ 4 x SATA III 6Gb/s ports
- ◆ 1 x CPU fan header
- ◆ 3 x System fan headers
- ◆ 1 x USB 2.0 header
- ◆ 1 x Serial header (COM)
- ◆ 1 x Front panel header
- ◆ 1 x Front Audio header
- ◆ 1 x Front USB3.2 header
- ◆ 1 x M.2 slot (SATA/PCIe gen3 x2, M-key, support NGFF-2280)
- ◆ 1 x M.2 slot (PCIe gen4 x4, M key, support NGFF-2280)
- ◆ 1 x M.2 slot (for Wi-Fi/BT module; E-key; support NGFF-2230)



#### Front I/O

- ◆ 2 x USB3.0 ports
- ◆ 1 x Line out port
- ◆ 1 x Mic in port
- ◆ 1 x Power Button
- ◆ 1 x Hard drives status LED
- ◆ 1 x Reset Button



#### Rear I/O

- ◆ 1 x Display port
- ◆ 1 x HDMI port
- ◆ 2 x Antenna ports
- ◆ 2 x USB 3.0 type A
- ◆ 2 x GbE RJ45 LAN ports
- ◆ 4 x USB 2.0 type A
- ◆ 3 x Audio Jacks (Line in / Line out / Mic in)



#### TPM

- ◆ On board with SPI interface



### Power Supply

- ◆ 1 x 500W PSU
- ◆ 80 PLUS Bronze
  
- ◆ AC Input:
  - 100-240V~; 7-3A, 50-60Hz
  
- ◆ DC Output:
  - Max. 500W
  - +12V/ 41.66A
  - +5V/ 20A
  - +3.3V/ 20A
  - +5Vsb/ 2.5A



### System Management

#### Realtek® DASH Remote Management

- ◆ Power state settings (on, off, restart, hibernate, or sleep)
- ◆ View hardware, firmware or BIOS versions
- ◆ Retrieve system health status
- ◆ USB device redirection
- ◆ Boot device selection
- ◆ View event logs
- ◆ Apply updates and security patches
- ◆ Text Console Redirection
- ◆ Software KVM



### Operating Properties

- ◆ Operating temperature: 10°C to 35°C
- ◆ Operating humidity: 8-80% (non-condensing)
- ◆ Non-operating temperature: -40°C to 60°C
- ◆ Non-operating humidity: 20%-95% (non-condensing)

# 1-3 System Block Diagram

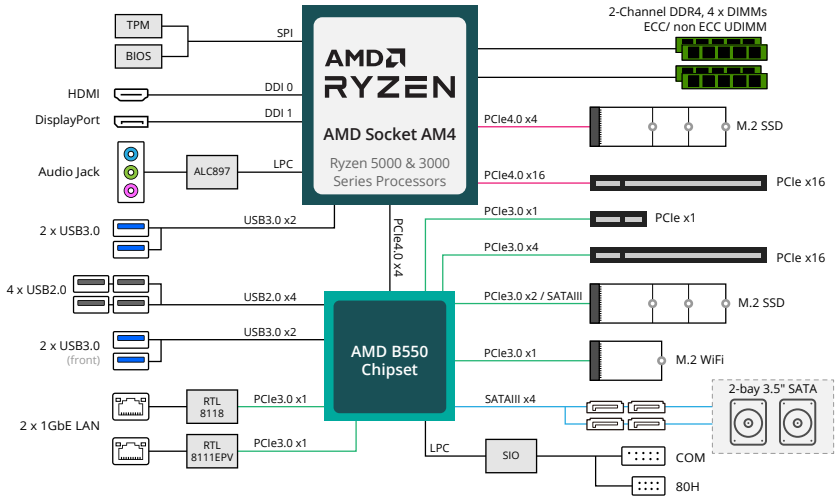

## Chapter 2 System Appearance

### 2-1 Front View

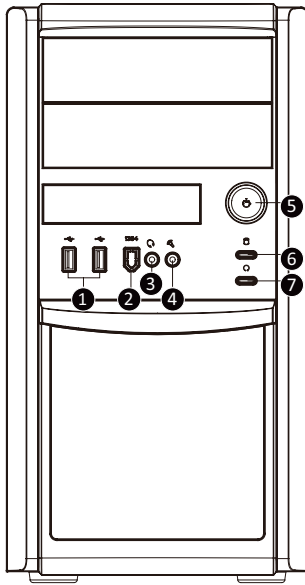

No.	Description	No.	Description
1.	USB 3.2 Ports	5.	Power Button
2.	The function of 1394 Port is disabled	6.	Hard Drives Status LED
3.	Line Out Port	7.	Reset Button
4.	Mic In Port		

## 2-2 Rear View

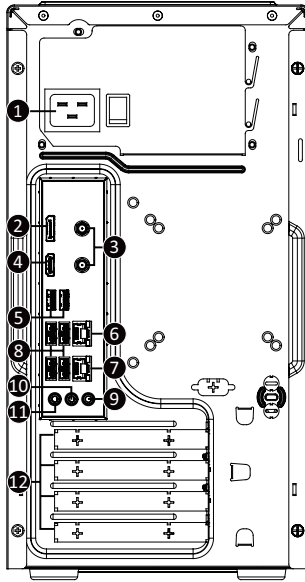

No.	Description	No.	Description
1.	Power Supply Module Cord Socket	7.	GbE LAN Port #1
2.	Display Port	8.	USB 2.0 Port x 4
3.	Antenna Ports	9.	Line In Port (Blue)
4.	HDMI 2.1 Port	10.	Line Out Port (Green)
5.	USB 3.2 Type A Port x 2	11.	Mic In Port (Pink)
6.	GbE LAN Port #2	12.	PCIe Card Bay



The HDMI port is HDCP 2.3 compliant and supports Dolby TrueHD and DTS HD Master Audio formats. It also supports up to 192KHz/24bit 7.1-channel LPCM audio output. You can use this port to connect your HDMI-supported monitor. The maximum supported resolution is 4096x2160@60Hz, but the actual resolutions supported are dependent on the monitor being used.



## 2-3 Rear Panel System LAN LEDs

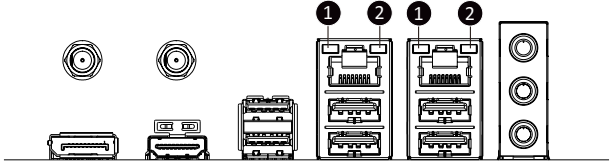

No.	Name	Color	Status	Description
1.	1GbE Speed LED	Yellow	On	1 Gbps data rate
		Green	On	100 Mbps data rate
		N/A	Off	10 Mbps data rate
2.	1GbE Link / Activity LED	Green	On	Link between system and network or no access
			Blink	Data transmission or reception is occurring.
		N/A	Off	No data transmission or reception is occurring.

## Chapter 3 System Hardware Installation



### Pre-installation Instructions

Computer components and electronic circuit boards can be damaged by electrostatic discharge. Working on computers that are still connected to a power supply can be extremely dangerous. Follow the simple guidelines below to avoid damage to your computer or injury to yourself.

- Always disconnect the computer from the power outlet whenever you are working inside the computer case.
- If possible, wear a grounded wrist strap when you are working inside the computer case. Alternatively, discharge any static electricity by touching the bare metal system of the computer case, or the bare metal body of any other grounded appliance.
- Hold electronic circuit boards by the edges only. Do not touch the components on the board unless it is necessary to do so. Do not flex or stress the circuit board.
- Leave all components inside the static-proof packaging until you are ready to use the component for the installation.

### 3-1 Removing and Installing the Chassis Cover



Before you remove or install the chassis cover

- Make sure the system is not turned on or connected to AC power.

**Follow these instructions to remove/install the chassis cover:**

1. Remove the screw securing the chassis cover.
2. Slide the cover towards the rear of the system and then remove the cover in the direction indicated by the arrow.
3. Follow steps 1-2 in reverse order to re-install the top cover

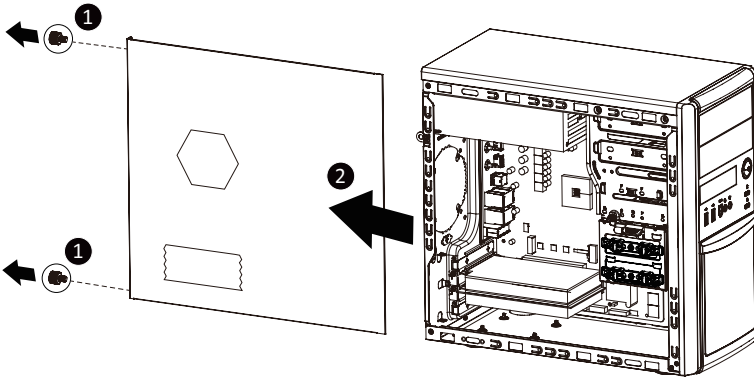

## 3-2 Installing the CPU



Read the following guidelines before you begin to install the CPU:

- Make sure that the motherboard supports the CPU.
- Always turn off the computer and unplug the power cord from the power outlet before installing the CPU to prevent hardware damage.
- Unplug all cables from the power outlets.
- Disconnect all telecommunication cables from their ports.
- Place the system unit on a flat and stable surface.
- Open the system according to the instructions.



### **WARNING!**

Failure to properly turn off the server before you start installing components may cause serious damage. Do not attempt the procedures described in the following sections unless you are a qualified service technician.

### **Follow these instructions to Install the CPU:**

1. Lift up the CPU socket locking lever.
2. Align the CPU pin one (triangle marking) with the pin one corner of the CPU socket. Install the CPU onto the socket.
3. Ensure the CPU is positioned into its socket and secure the CPU socket lever.

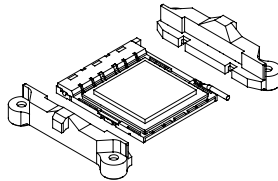
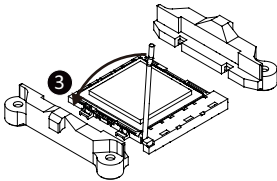
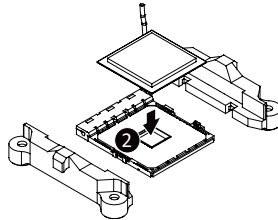
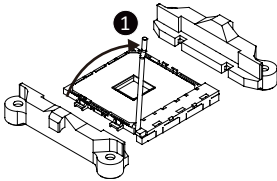

### 3-3 Installing the Memory



Read the following guidelines before you begin to install the memory:

- Make sure that the motherboard supports the memory. It is recommended that memory of the same capacity, brand, speed, and chips be used.
- Always turn off the computer and unplug the power cord from the power outlet before installing the memory to prevent hardware damage.
- Memory modules have a foolproof design. A memory module can be installed in only one direction. If you are unable to insert the memory, switch the direction.

#### 3-3-1 Dual Channel Memory Configuration

This motherboard provides 4 DDR4 memory slots and supports Dual Channel Technology. After the memory is installed, the BIOS will automatically detect the specifications and capacity of the memory.

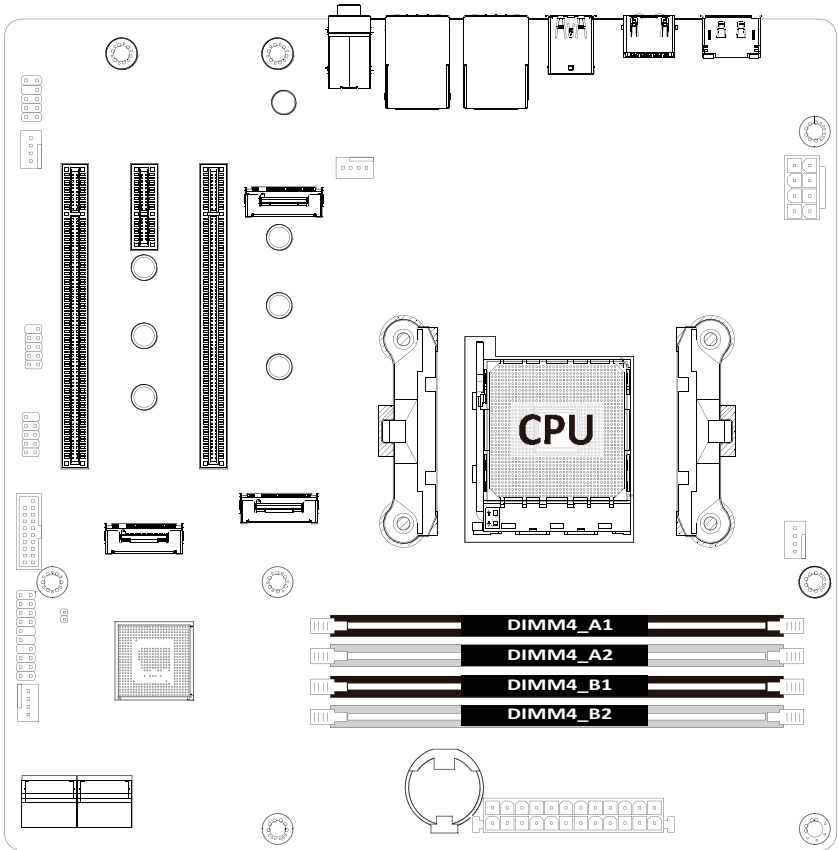

### 3-3-2 Installing the Memory



Before installing a memory module, make sure to turn off the computer and unplug the power cord from the power outlet to prevent damage to the memory module.

Be sure to install DDR4 DIMMs on this motherboard.

Follow these instructions to install the Memory:

1. Insert the DIMM memory module vertically into the DIMM slot, and push it down.
2. Close the plastic clip at both edges of the DIMM slots to lock the DIMM module.
3. Reverse the installation steps when you want to remove the DIMM module.

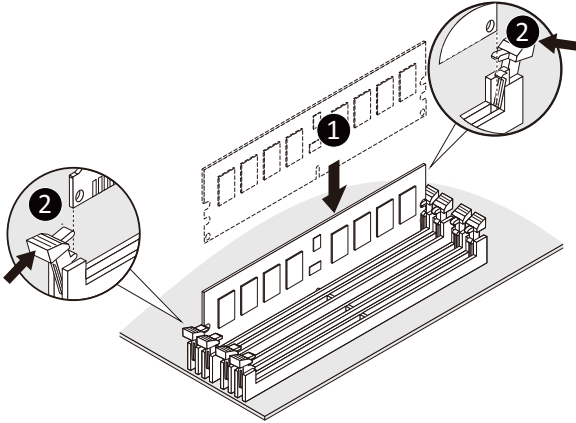

Memory Type	DDR4	
Voltage (V)	1.2V	
Connector	UDIMM	
Speed (MT/s)	2933	2666
Channels	1,2	
DIMM Per Channel	1,2	
DIMM Capacity (GB)	2,4,8,16,32	



#### Note:

- DIMM must be populated in sequential alphabetic order, starting with DIMM2 (DDR4\_A2).
- When only one DIMM is used, it must be populated in memory slot DIMM2 (DDR4\_B2).

## 3-4 Installing the PCI Expansion Card



- Voltages can be present within the server whenever an AC power source is connected. This voltage is present even when the main power switch is in the off position. Ensure that the system is powered-down and all power sources have been disconnected from the server prior to installing a PCIe card.
- Failure to observe these warnings could result in personal injury or damage to equipment.

### Follow these instructions to install the PCI Expansion card:

1. Use a screw driver to push the slot cover.
2. Remove the slot cover from the PCIe bracket.
3. Align the PCIe card onto the slot and push in the direction of the arrow until the PCIe card sits in the PCIe card connector.
4. Secure the PCIe card with the screw.
5. Reverse the previous steps to remove the PCIe card.

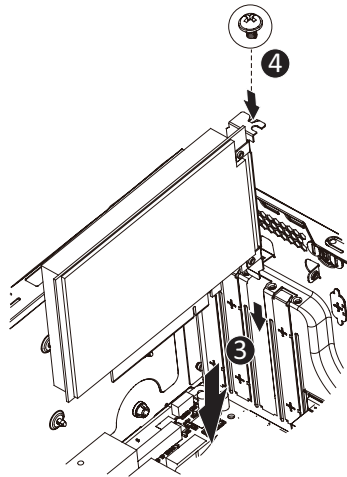
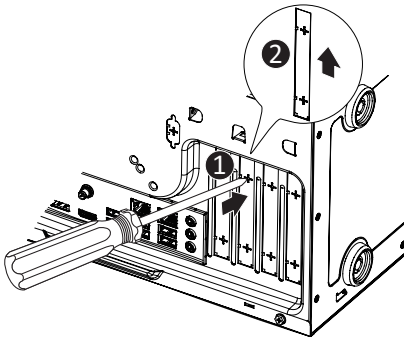

## 3-5 Installing the Hard Disk Drive



Read the following guidelines before you begin to install the hard disk drive:

- Take note of the drive tray orientation before sliding it out.
- The tray will not fit back into the bay if inserted incorrectly.
- Make sure that the hard disk drive is connected to the hard disk drive connector on the backplane.

**Follow these instructions to install a 3.5" hard disk drive:**

1. Loosen the thumbscrew securing the HDD cage.
2. Press down the latch and pull out the HDD cage at the same time.
3. Open the latches on the side of HDD cage.
4. Slide the hard disk drive into the HDD cage.
5. Push inward to make sure the HDD latches are in a locked position.
6. Reinstall the HDD cage into the chassis.
7. Tighten the thumbnail screw to secure the HDD cage in place. Finally, use a screw driver to secure the screw firmly.

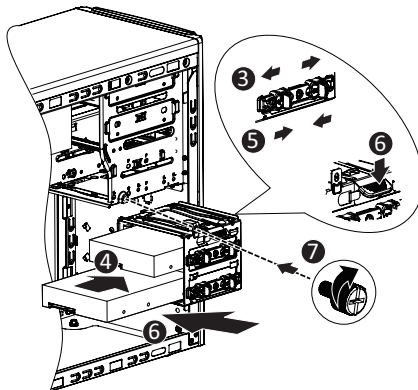
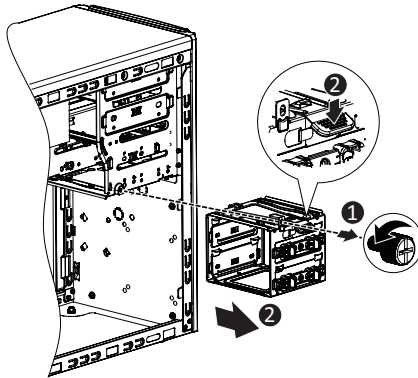



### 3-6 Installing and Removing the M.2 SSD Module

Follow the steps below to install an optional M.2 SSD module on your motherboard.

Step1. Insert the M.2 SSD module into the slot.

Step2. Secure it with the screw, tightening as necessary to fasten the M.2 SSD module in place.

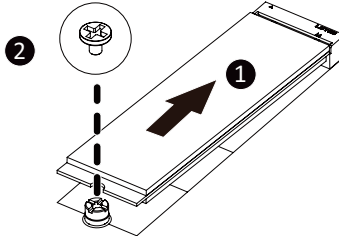

### 3-7 Installing and Removing the M.2 WiFi Module

Follow the steps below to install a M.2 WiFi module on your motherboard.

Step1. Carefully Insert the M.2 WiFi module into the slot.

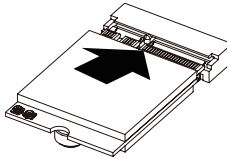

Step2. Secure it with the screw, tightening as necessary to fasten the M.2 WiFi module in place.

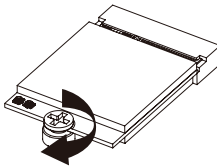

# 3-8 Peripheral Devices Connection

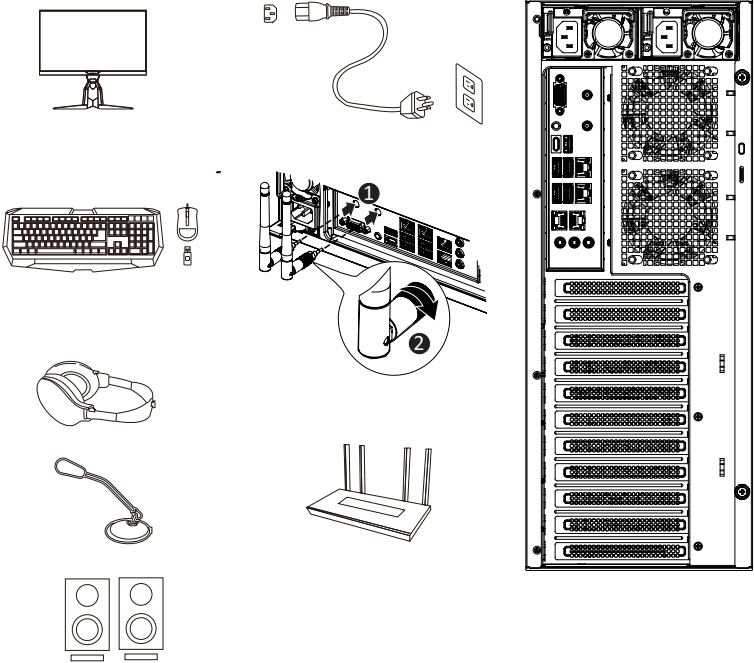

# Chapter 4 Motherboard Components

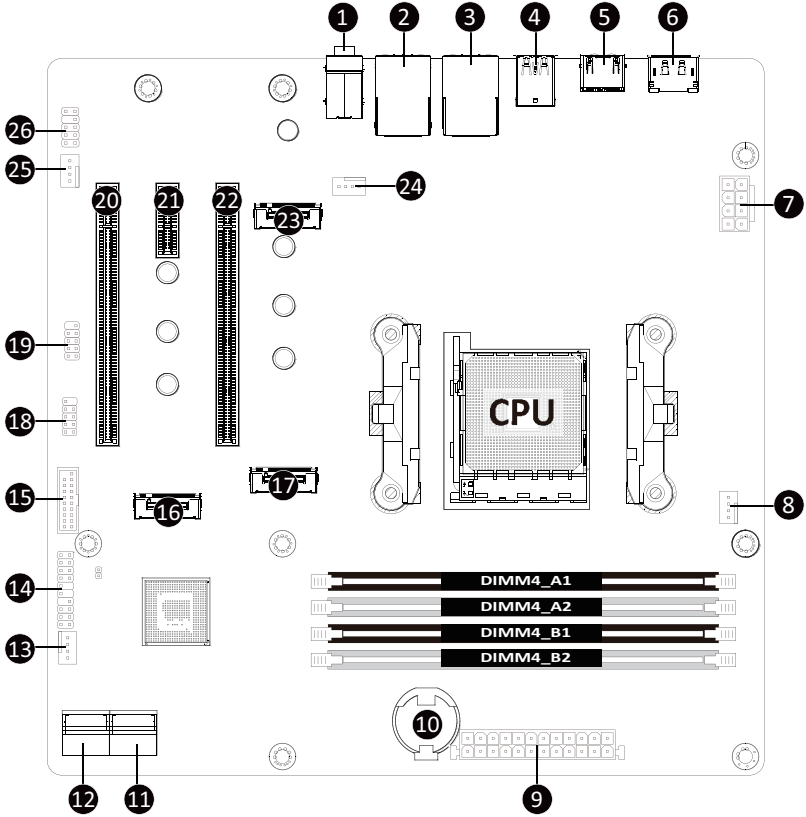

## 4-1 Motherboard Components

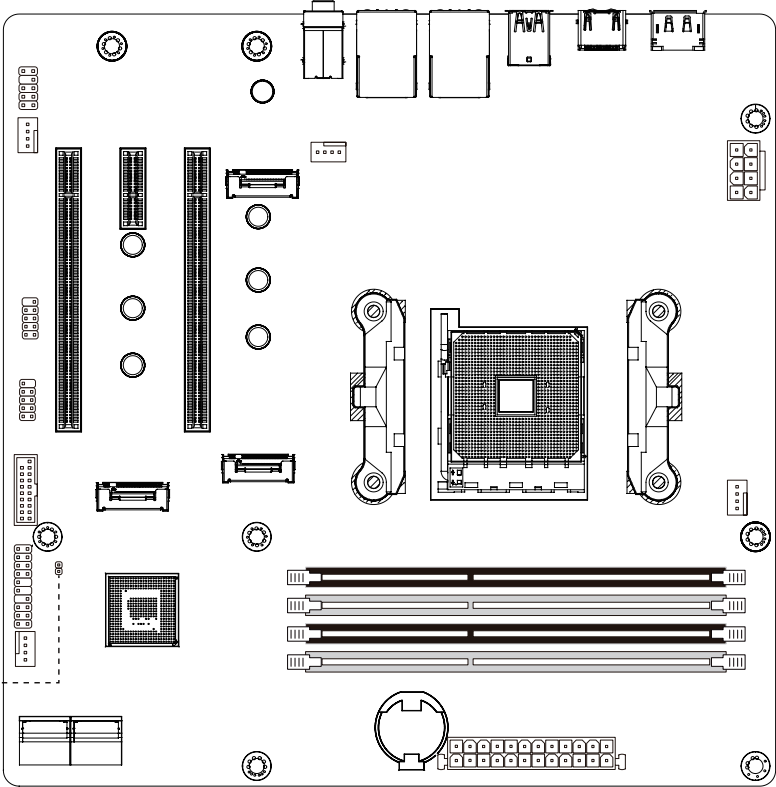

<b>Item</b>	<b>Description</b>
1	Audio Connectors
2	GbE LAN Port #1 (Top)/USB 2.0 Ports (Bottom)
3	GbE LAN Port #2 (Top)/USB 2.0 Ports (Bottom)
4	USB 3.2 Ports (Type A)
5	HDMI 2.1 Port
6	Display Port
7	2x4 Pin 12V Power Connector
8	CPU Fan Connector
9	2x12 Pin Main Power Connector
10	Battery Socket
11	SATA III 6Gb/s Connector #0/#1
12	SATA III 6Gb/s Connector #2/#3
13	System Fan Connector #2
14	Front Panel Header
15	Front Panel USB 3.2 Connector
16	M.2 Slot (SATA/PCIe Gen3 x2, Support NGFF-2280)
17	M.2 Slot (PCIe Gen4 x4, Support NGFF-2280)
18	Front Panel USB 2.0 Connector
19	Serial Port Cable Header
20	PCIe x16 Slot (Gen3 x4)
21	PCIe x1 Slot (Gen3 x1)
22	PCIe x16 Slot (Gen4 x16)
23	M.2 Slot (WiFi/BT module, Support NGFF-2230)
24	System Fan Connector #1
25	System Fan Connector #3
26	Front Audio Header

# 4-2 Jumper Setting



Clear CMOS		Normal Operation (Default)
CLR_CMOS		Clear CMOS data

## Chapter 5 BIOS Setup

BIOS (Basic Input and Output System) records hardware parameters of the system in the EFI on the motherboard. Its major functions include conducting the Power-On Self-Test (POST) during system startup, saving system parameters, loading the operating system etc. The BIOS includes a BIOS Setup program that allows the user to modify basic system configuration settings or to activate certain system features. When the power is turned off, the battery on the motherboard supplies the necessary power to the CMOS to keep the configuration values in the CMOS.

To access the BIOS Setup program, press the <DEL> key during the POST when the power is turned on.



- BIOS flashing is potentially risky, if you do not encounter any problems when using the current BIOS version, it is recommended that you don't flash the BIOS. To flash the BIOS, do it with caution. Inadequate BIOS flashing may result in system malfunction.
- It is recommended that you not alter the default settings (unless you need to) to prevent system instability or other unexpected results. Inadequately altering the settings may result in system's failure to boot. If this occurs, try to clear the CMOS values and reset the board to default values. (Refer to the **Exit** section in this chapter or introductions of the battery/clearing CMOS jumper in Chapter 4 for how to clear the CMOS values.)

### BIOS Setup Program Function Keys

<<-><->>	Move the selection bar to select the screen
<↑><↓>	Move the selection bar to select an item
<+>	Increase the numeric value or make changes
<->	Decrease the numeric value or make changes
<Enter>	Execute command or enter the submenu
<Esc>	Main Menu: Exit the BIOS Setup program Submenus: Exit current submenu
<F1>	Show descriptions of general help
<F3>	Restore the previous BIOS settings for the current submenus
<F9>	Load the Optimized BIOS default settings for the current submenus
<F10>	Save all the changes and exit the BIOS Setup program

■ **Main**

This setup page includes all the items of the standard compatible BIOS.

■ **Advanced**

This setup page includes all the items of AMI BIOS special enhanced features.

(ex: Auto detect fan and temperature status, automatically configure hard disk parameters.)

■ **Chipset**

This setup page includes all the submenu options for configuring the functions of the onboard controller.

■ **Security**

Change, set, or disable supervisor and user password. Configuration supervisor password allows you to restrict access to the system and BIOS Setup.

A supervisor password allows you to make changes in BIOS Setup.

A user password only allows you to view the BIOS settings but not to make changes.

■ **Boot**

This setup page provides items for configuration of the boot sequence.

■ **Save & Exit**

Save all the changes made in the BIOS Setup program to the CMOS and exit BIOS Setup. (Pressing <F10> can also carry out this task.)

Abandon all changes and the previous settings remain in effect. Pressing <Y> to the confirmation message will exit BIOS Setup. (Pressing <Esc> can also carry out this task.)

# 5-1 The Main Menu

Once you enter the BIOS Setup program, the Main Menu (as shown below) appears on the screen. Use arrow keys to move among the items and press <Enter> to accept or enter other sub-menu.

## Main Menu Help

The on-screen description of a highlighted setup option is displayed on the bottom line of the Main Menu.

## Submenu Help

While in a submenu, press <F1> to display a help screen (General Help) of function keys available for the menu. Press <Esc> to exit the help screen. Help for each item is in the Item Help block on the right side of the submenu.



- When the system is not stable as usual, select the **Restore Defaults** item to set your system to its defaults.
- The BIOS Setup menus described in this chapter are for reference only and may differ by BIOS version.

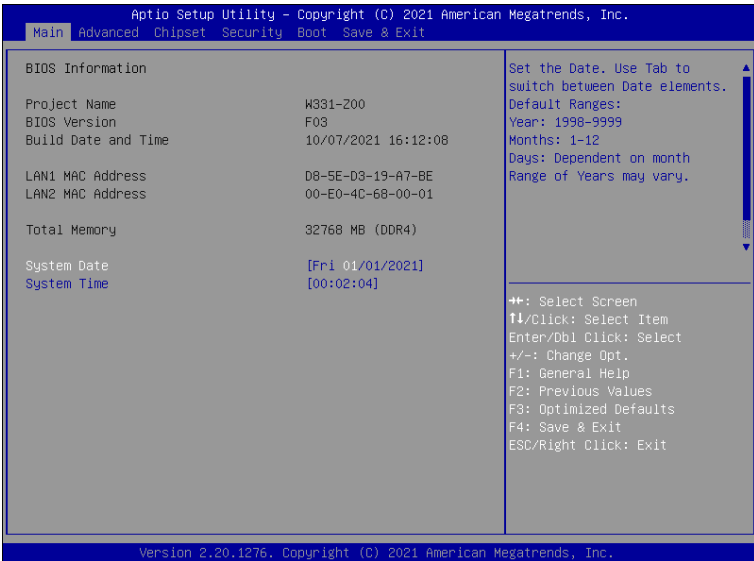



Parameter	Description
BIOS Information	
Project Name	Displays the project name information.
BIOS Version	Displays version number of the BIOS setup utility.
Build Date and Time	Displays the date and time when the BIOS setup utility was created.
LAN# MAC Address <sup>(Note1)</sup>	Displays LAN MAC address information.
Total Memory <sup>(Note2)</sup>	Displays the total memory size of the installed memory.
System Date	Sets the date following the weekday-month-day-year format.
System Time	Sets the system time following the hour-minute-second format.

(Note1) The number of LAN ports listed will depend on the motherboard / system model.

(Note2) This section will display capacity and frequency information of the memory that the customer has installed.

## 5-2 Advanced Menu

The Advanced Menu displays submenu options for configuring the function of various hardware components. Select a submenu item, then press <Enter> to access the related submenu screen.

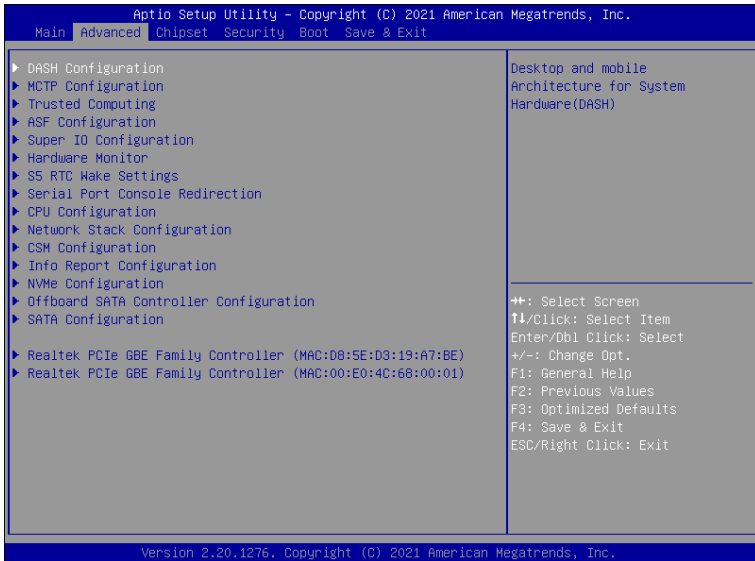

## 5-2-1 DASH Configuration



Parameter	Description
Desktop and mobile Architecture for System Hardware (DASH) Configuration	
RTL8111 ID	Displays the vendor ID information.
RealManage Implementation Guide version	Displays the utility version.
RealMange Firmware Control <sup>(Note)</sup>	Enable/Disable RealMange Firmware Control. Options available: Enabled, Disabled. Default setting is <b>Disabled</b> .
DASH Support	Enable/Disable DASH Support. Options available: Enabled, Disabled. Default setting is <b>Disabled</b> .

(Note) Advanced items prompt when this item is defined.

## 5-2-2 MCTP Configuration



Parameter	Description
Management Component Transport Protocol (MCTP) Configuration	
MCTP Support <sup>(Note)</sup>	Enable/Disable MCTP Support. Options available: Enabled, Disabled. Default setting is <b>Disabled</b> .
PLDM for SMBIOS	Enable/Disable PLDM Support for SMBios. Options available: Enabled, Disabled. Default setting is <b>Enabled</b> .
PLDM for BIOS Control and Configuration	Enable/Disable PLDM Support for BIOS Control. Options available: Enabled, Disabled. Default setting is <b>Enabled</b> .
PLDM for Platform Monitoring	Enable/Disable PLDM for Platform Monitoring. Options available: Enabled, Disabled. Default setting is <b>Enabled</b> .

(Note) Advanced items prompt when this item is defined.

### 5-2-3 Trusted Computing

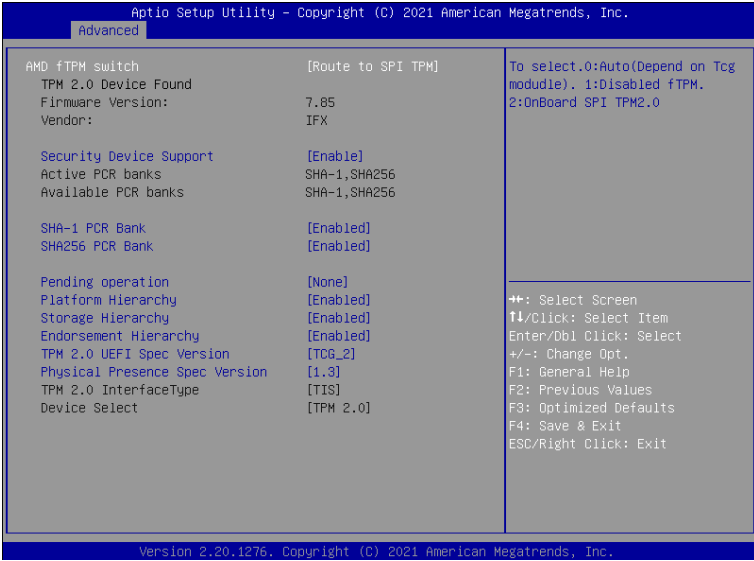

Parameter	Description
AMD fTPM switch	Options available: AMD CPU fTPM, Route to SPI TPM. Default setting is <b>Route to SPI TPM</b> .
TPM 2.0 Device Found	
Firmware Version	Displays the firmware version information.
Vendor	Displays the vendor information.
Security Device Support	Enable/Disable BIOS support for security device. OS will not show security device. TCG EFI protocol and INT1A interface will not be available. Options available: Enable, Disable. Default setting is <b>Enable</b> .
Active PCR banks	Displays active Platform Configuration Register (PCR) banks.
Available PCR banks	Displays available PCR banks.
SHA-1 PCR Bank	Enable/Disable SHA-1 PCR bank. Options available: Enabled, Disabled. Default setting is <b>Enabled</b> .
SHA256 PCR Bank	Enable/Disable SHA256 PCR bank. Options available: Enabled, Disabled. Default setting is <b>Enabled</b> .

Parameter	Description
Pending operation	Schedule an operation for the security device. NOTE: Your computer will reboot during restart in order to change the state of a security device. Options available: None, TPM Clear. Default setting is <b>None</b> .
Platform Hierarchy	Enable/Disable platform hierarchy. Options available: Enabled, Disabled. Default setting is <b>Enabled</b> .
Storage Hierarchy	Enable/Disable storage hierarchy. Options available: Enabled, Disabled. Default setting is <b>Enabled</b> .
Endorsement Hierarchy	Enable/Disable endorsement hierarchy. Options available: Enabled, Disabled. Default setting is <b>Enabled</b> .
TPM2.0 UEFI Spec Version	Selects the TCG2 spec version support. Options available: TCG_1_2, TCG_2. Default setting is <b>TCG2</b> .
Physical Presence Spec Version	Selects the physical presence spec version. Options available: 1.2, 1.3. Default setting is <b>1.3</b> .
TPM 20 InterfaceType	Displays the TPM 2.0 interface type.
Device Select	Selects the TPM device. Default setting is <b>TPM 2.0</b> .

## 5-2-4 ASF Configuration

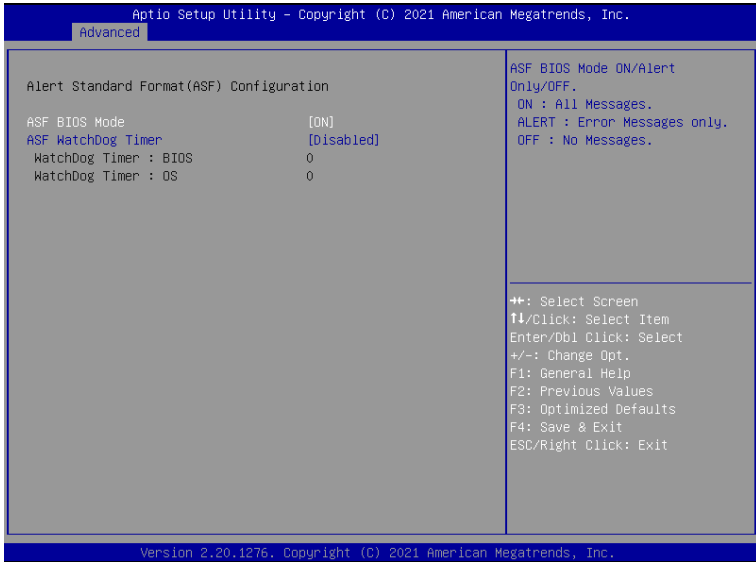

Parameter	Description
Alert Standard Format (ASF) Configuration	
ASF BIOS Mode	Options available: OFF, On, Alert Only. Default setting is <b>On</b> .
ASF WatchDog Timer	Enable/Disable WatchDog Timer. Options available: Enabled, Disabled. Default setting is <b>Disabled</b> .

### 5-2-5 Super IO Configuration



Parameter	Description
Super IO Configuration	
Super IO Chip	Displays the super IO chip information
Serial Port 1 Configuration	Press [Enter] for configuration of advanced items.



## 5-2-5-1 Serial Port 1 Configuration

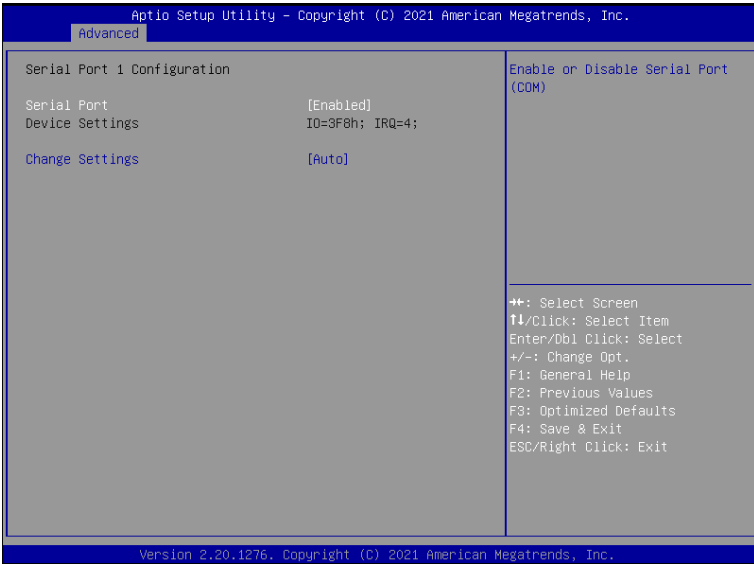

Parameter	Description
Serial Port 1 Configuration	
Serial Port <sup>(Note1)</sup>	Enable/Disable the Serial Port (COM). When set to Enabled allows you to configure the Serial port 1 settings. When set to Disabled, displays no configuration for the serial port. Options available: Enabled, Disabled. Default setting is <b>Enabled</b> .
Devices Settings <sup>(Note2)</sup>	Displays the Serial Port 1 device settings.
Change Settings <sup>(Note2)</sup>	Select an optimal settings for Super IO Device. Options available for Serial Port 1: Auto IO=3F8h; IRQ=4; IO=3F8h; IRQ=3, 4, 5, 6, 7, 9, 10, 11, 12; IO=2F8h; IRQ=3, 4, 5, 6, 7, 9, 10, 11, 12; IO=3E8h; IRQ=3, 4, 5, 6, 7, 9, 10, 11, 12; IO=2E8h; IRQ=3, 4, 5, 6, 7, 9, 10, 11, 12; Default setting is <b>Auto</b> .

(Note1) Advanced items prompt when this item is defined.

(Note2) This item appears when **Serial Port** is set to **Enabled**.

## 5-2-6 Hardware Monitor

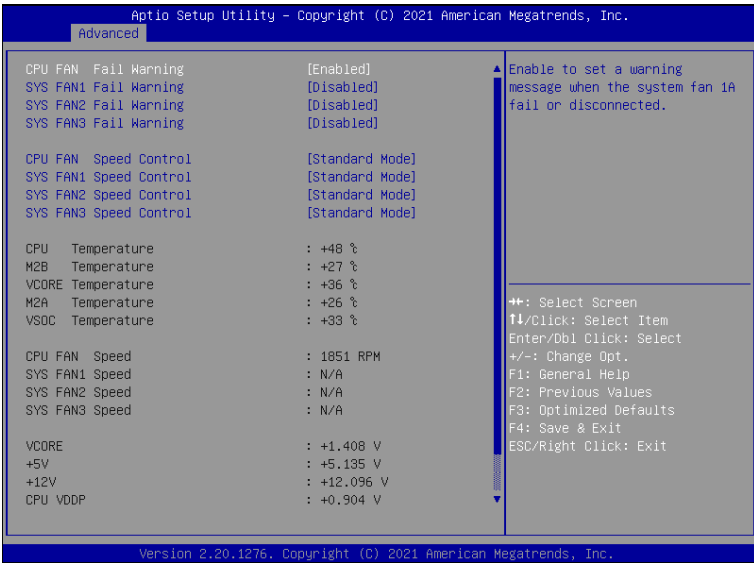

Parameter	Description
CPU FAN Fail Warning	Options available: Enabled, Disabled. Default setting is <b>Enabled</b> .
SYS FAN1/2/3 Fail Warning	Options available: Enabled, Disabled. Default setting is <b>Disabled</b> .
CPU FAN Speed Control	Options available: Full Speed, Standard Mode. Default setting is <b>Standard Mode</b> .
SYS FAN1/2/3 Speed Control	Options available: Full Speed, Standard Mode. Default setting is <b>Standard Mode</b> .

### 5-2-7 S5 RTC Wake Settings

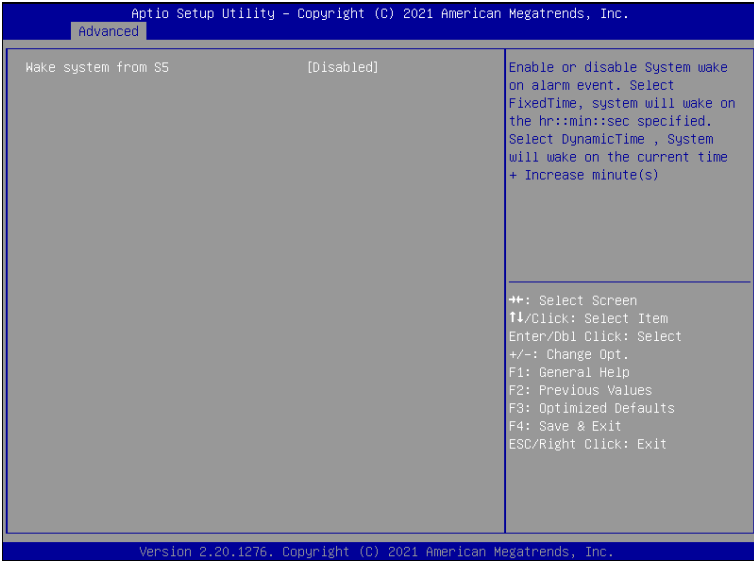

Parameter	Description
Wake System from S5	Enable/Disable system wake on alarm event. Options available: Disabled, Fixed Time. When Fixed Time is selected, system will wake on the hr::min::sec specified. Default setting is <b>Disabled</b> .

## 5-2-8 Serial Port Console Redirection

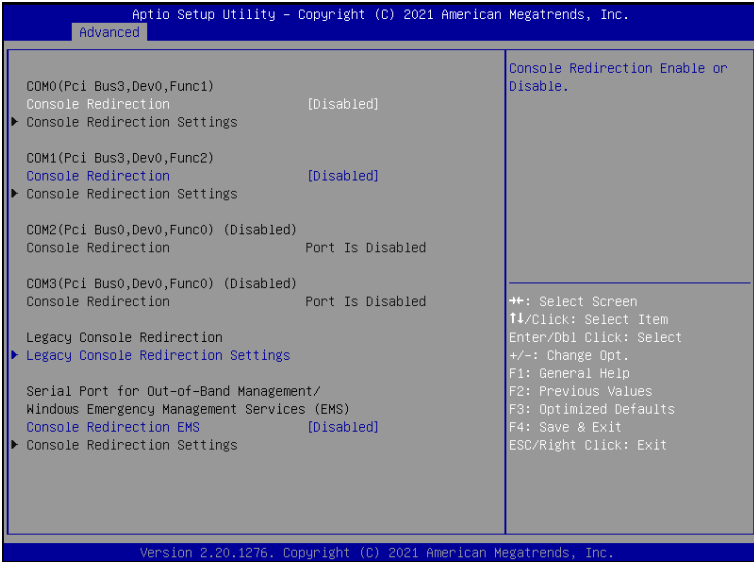

Parameter	Description
COM Console Redirection <sup>(Note)</sup>	<p>Select whether to enable console redirection for specified device. Console redirection enables the users to manage the system from a remote location.</p> <p>Options available: Enabled, Disabled. Default setting is <b>Disabled</b>.</p>
COM Console Redirection Settings	<p>Press [Enter] to configure advanced items.</p> <p><b>Please note that this item is configurable when COM Console Redirection is set to Enabled.</b></p> <ul style="list-style-type: none"> <li>◆ Terminal Type <ul style="list-style-type: none"> <li>– Selects a terminal type to be used for console redirection.</li> <li>– Options available: VT100, VT100+, ANSI, VT-UTF8. Default setting is <b>ANSI</b>.</li> </ul> </li> <li>◆ Bits per second <ul style="list-style-type: none"> <li>– Selects the transfer rate for console redirection.</li> <li>– Options available: 9600, 19200, 38400, 57600, 115200. Default setting is <b>115200</b>.</li> </ul> </li> <li>◆ Data Bits <ul style="list-style-type: none"> <li>– Selects the number of data bits used for console redirection.</li> <li>– Options available: 7, 8. Default setting is <b>8</b>.</li> </ul> </li> </ul>

(Note) Advanced items prompt when this item is defined.

Parameter	Description
COM Console Redirection Settings (continued)	<ul style="list-style-type: none"> <li>◆ Parity <ul style="list-style-type: none"> <li>– A parity bit can be sent with the data bits to detect some transmission errors.</li> <li>– Even: parity bit is 0 if the num of 1's in the data bits is even.</li> <li>– Odd: parity bit is 0 if num of 1's in the data bits is odd.</li> <li>– Mark: parity bit is always 1. Space: Parity bit is always 0.</li> <li>– Mark and Space Parity do not allow for error detection.</li> <li>– Options available: None, Even, Odd, Mark, Space. Default setting is <b>None</b>.</li> </ul> </li> <li>◆ Stop Bits <ul style="list-style-type: none"> <li>– Stop bits indicate the end of a serial data packet. (A start bit indicates the beginning). The standard setting is 1 stop bit. Communication with slow devices may require more than 1 stop bit.</li> <li>– Options available: 1, 2. Default setting is <b>1</b>.</li> </ul> </li> <li>◆ Flow Control <ul style="list-style-type: none"> <li>– Flow control can prevent data loss from buffer overflow. When sending data, if the receiving buffers are full, a 'stop' signal can be sent to stop the data flow. Once the buffers are empty, a 'start' signal can be sent to re-start the flow. Hardware flow control uses two wires to send start/stop signals.</li> <li>– Options available: None, Hardware RTS/CTS. Default setting is <b>None</b>.</li> </ul> </li> <li>◆ VT-UTF8 Combo Key Support <ul style="list-style-type: none"> <li>– Enable/Disable the VT-UTF8 Combo Key Support.</li> <li>– Options available: Enabled, Disabled. Default setting is <b>Enabled</b>.</li> </ul> </li> <li>◆ Recorder Mode <ul style="list-style-type: none"> <li>– When this mode enabled, only texts will be send. This is to capture Terminal data.</li> <li>– Options available: Enabled, Disabled. Default setting is <b>Disabled</b>.</li> </ul> </li> <li>◆ Resolution 100x31 <ul style="list-style-type: none"> <li>– Enable/Disable extended terminal resolution.</li> <li>– Options available: Enabled, Disabled. Default setting is <b>Enabled</b>.</li> </ul> </li> <li>◆ Putty Keypad <ul style="list-style-type: none"> <li>– Selects FunctionKey and Keypad on Putty.</li> <li>– Options available: VT100, LINUX, XTERMR6, SC0, ESCN, VT400. Default setting is <b>VT100</b>.</li> </ul> </li> </ul>

Parameter	Description
Legacy Console Redirection	
Legacy Console Redirection Settings	<p>Press [Enter] to configure advanced items.</p> <ul style="list-style-type: none"> <li>◆ Redirection COM Port <ul style="list-style-type: none"> <li>– Selects a COM port for Legacy serial redirection.</li> </ul> </li> <li>◆ Resolution <ul style="list-style-type: none"> <li>– Selects the number of rows and columns used in Console Redirection for legacy OS support.</li> <li>– Options available: 80x24, 80x25. Default setting is <b>80x24</b>.</li> </ul> </li> <li>◆ Redirect After POST <ul style="list-style-type: none"> <li>– When Bootloader is selected, then Legacy Console Redirection is disabled before booting to legacy OS. When Always Enable is selected, then Legacy Console Redirection is enabled for legacy OS.</li> <li>– Options available: Always Enable, BootLoader. Default setting is <b>Always Enable</b>.</li> </ul> </li> </ul>
Serial Port for Out-of-Band Management / Windows Emergency Management Services (EMS) Console Redirection <sup>(Note)</sup>	<p>EMS console redirection allows the user to configure Console Redirection Settings to support Out-of-Band Serial Port management.</p> <p>Options available: Enabled, Disabled. Default setting is <b>Disabled</b>.</p>
Serial Port for Out-of-Band EMS Console Redirection Settings	<p>Press [Enter] to configure advanced items.</p> <p><b>Please note that this item is configurable when Serial Port for Out-of-Band Management EMS Console Redirection is set to Enabled.</b></p> <ul style="list-style-type: none"> <li>◆ Out-of-Band Mgmt Port <ul style="list-style-type: none"> <li>– Microsoft Windows Emergency Management Service (EMS) allows for remote management of a Windows Server OS through a serial port.</li> </ul> </li> <li>◆ Terminal Type EMS <ul style="list-style-type: none"> <li>– Selects a terminal type to be used for console redirection.</li> <li>– Options available: VT100, VT100+, ANSI, VT-UTF8. Default setting is <b>VT-UTF8</b>.</li> </ul> </li> <li>◆ Bits per second EMS <ul style="list-style-type: none"> <li>– Selects the transfer rate for console redirection.</li> <li>– Options available: 9600, 19200, 38400, 57600, 115200. Default setting is <b>115200</b>.</li> </ul> </li> </ul>

(Note) Advanced items prompt when this item is defined.

Parameter	Description
Serial Port for Out-of-Band EMS Console Redirection Settings(continued)	<ul style="list-style-type: none"><li>◆ Flow Control EMS<ul style="list-style-type: none"><li>– Flow control can prevent data loss from buffer overflow. When sending data, if the receiving buffers are full, a 'stop' signal can be sent to stop the data flow. Once the buffers are empty, a 'start' signal can be sent to re-start the flow. Hardware flow control uses two wires to send start/stop signals.</li><li>– Options available: None, Hardware RTS/CTS, Software Xon/Xoff. Default setting is <b>None</b>.</li></ul></li></ul>

## 5-2-9 CPU Configuration

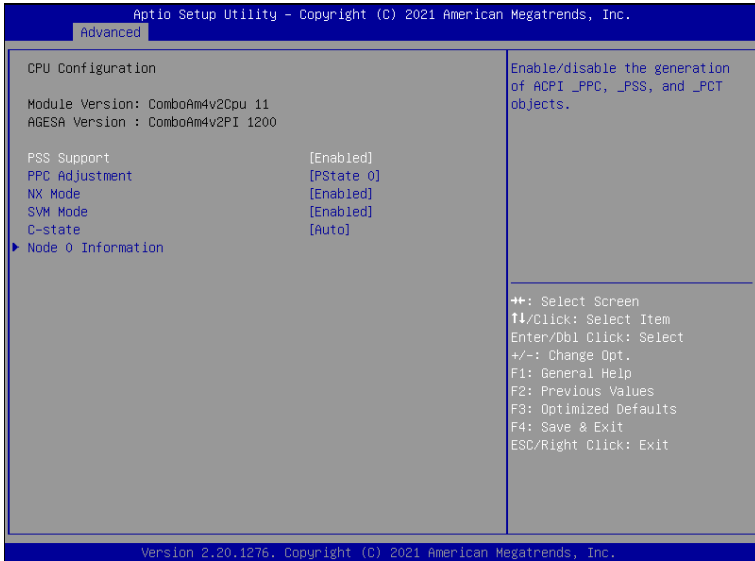

Parameter	Description
CPU Configuration	
Module Version	Displays the module version information.
AGESA Version	Displays the AGESA version information.
PSS Support	Enable/Disable the generation of ACPI_PPC, _PSS, and _PCT objects. Options available: Enabled, Disabled. Default setting is <b>Enabled</b> .
PPC Adjustment	Options available: PState 0, PState 1, PState 2. Default setting is <b>PState 0</b> .
NX Mode	Enable/Disable No-execute page protection Function. Options available: Enabled, Disabled. Default setting is <b>Enabled</b> .
SVM Mode	Enable/Disable the CPU Virtualization. Options available: Enabled, Disabled. Default setting is <b>Enabled</b> .
C-state	Controls IO based C-state generation and DF C-states. Options available: Enabled, Disabled, Auto. Default setting is <b>Auto</b> .
Node 0 Information	Press [Enter] to view the information related to Node 0.



## 5-2-10 Network Stack Configuration



Parameter	Description
Network Stack	Enable/Disable the UEFI network stack. Options available: Enabled, Disabled. Default setting is <b>Disabled</b> .
Ipv4 PXE Support <sup>(Note)</sup>	Enable/Disable the Ipv4 PXE feature. Options available: Enabled, Disabled. Default setting is <b>Enabled</b> .
Ipv4 HTTP Support <sup>(Note)</sup>	Enable/Disable the Ipv4 HTTP feature. Options available: Enabled, Disabled. Default setting is <b>Disabled</b> .
Ipv6 PXE Support <sup>(Note)</sup>	Enable/Disable the Ipv6 PXE feature. Options available: Enabled, Disabled. Default setting is <b>Enabled</b> .
Ipv6 HTTP Support <sup>(Note)</sup>	Enable/Disable the Ipv6 HTTP feature. Options available: Enabled, Disabled. Default setting is <b>Disabled</b> .
PXE boot wait time <sup>(Note)</sup>	Wait time in seconds to press ESC key to abort the PXE boot. Press the <+> / <-> keys to increase or decrease the desired values.
Media detect count <sup>(Note)</sup>	Number of times the presence of media will be checked. Press the <+> / <-> keys to increase or decrease the desired values.

(Note) This item appears when **Network Stack** is set to **Enabled**.

## 5-2-11 CSM Configuration

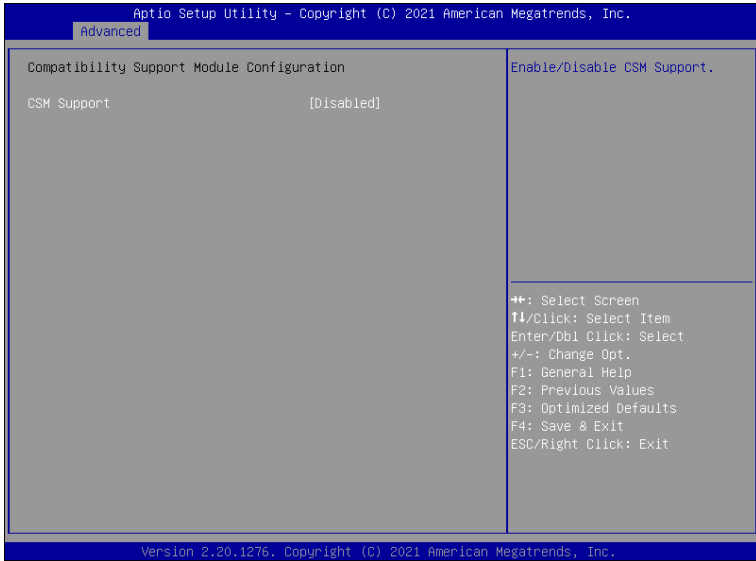

Parameter	Description
Compatibility Support Module Configuration	
CSM Support <sup>(Note)</sup>	Enable/Disable CSM support. Options available: Enabled, Disabled. Default setting is <b>Disabled</b> .
CSM16 Module Version	Displays the module version information.
GateA20 Active	Options available: Upon Request, Always. Default setting is <b>Upon Request</b> .
Option ROM Messages	Sets display mode for Option ROM. Options available: Force BIOS, Keep Current. Default setting is <b>Force BIOS</b> .
INT19 Trap Response	Options available: Immediate, Postponed. Default setting is <b>Immediate</b> .
HDD Connection Order	Options available: Adjust, Keep. Default setting is <b>Adjust</b> .
Boot option filter	Controls Legacy/UEFI ROMs priority. Options available: UEFI and Legacy, Legacy only, UEFI only. Default setting is <b>Disabled</b> .
Option ROM execution	Controls the execution of UEFI and Legacy Network OpROM. Options available: UEFI, Legacy.

(Note) Advanced items prompt when this item is defined.

## 5-2-12 Info Report Configuration

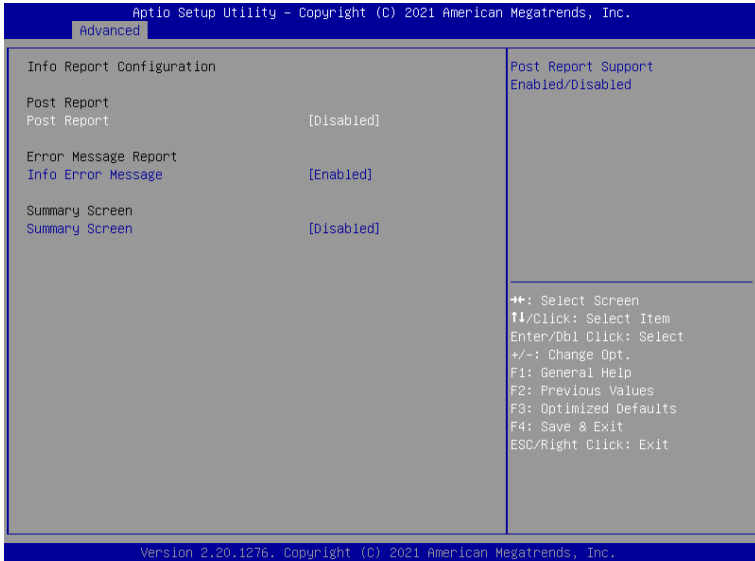

Parameter	Description
Info Report Configuration	
Post Report <sup>(Note)</sup>	Enable/Disable Post Report support. Options available: Enabled, Disabled. Default setting is <b>Disabled</b> .
Delay Time	Sets the POST Report wait time. Options available: 0, 1, 2, 3, 4, 5, 6, 7, 8, 9, 10, Until Press ESC. Default setting is <b>5</b> .
Error Message Report	
Info Error Message	Enable/Disable Info Error Message support. Options available: Enabled, Disabled. Default setting is <b>Enabled</b> .
Summary Screen <sup>(Note)</sup>	Enable/Disable Summary Screen support. Options available: Enabled, Disabled. Default setting is <b>Disabled</b> .
Delay Time	Sets the POST Report wait time. Options available: 0, 1, 2, 3, 4, 5, 6, 7, 8, 9, 10, Until Press ESC. Default setting is <b>5</b> .

(Note) Advanced items prompt when this item is defined.

## 5-2-13 NVMe Configuration

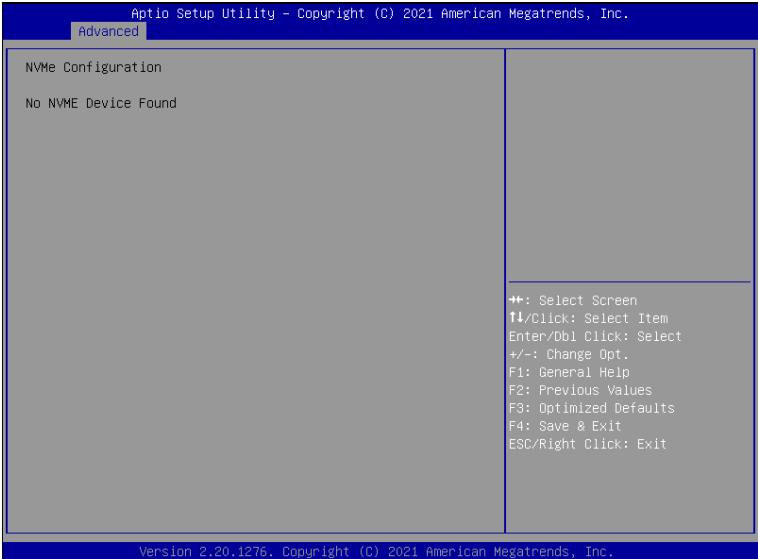

Parameter	Description
NVMe Configuration	Displays the NVMe devices connected to the system.

## 5-2-14 Offboard SATA Controller Configuration

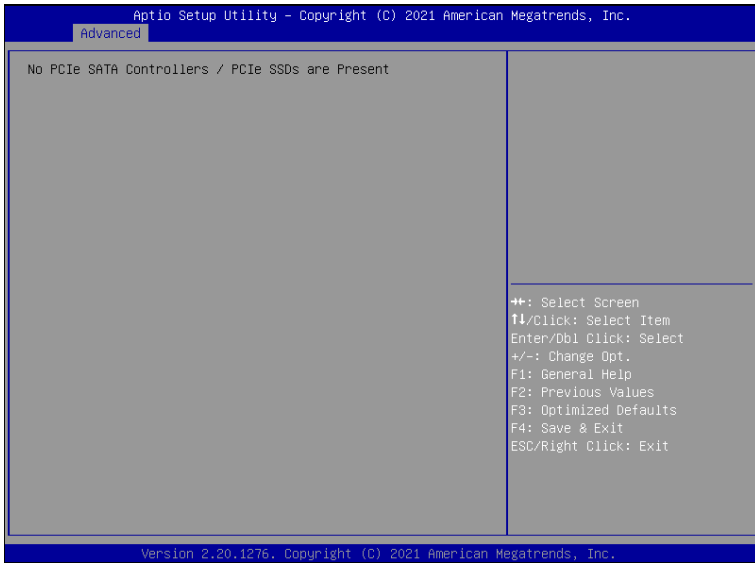

Parameter	Description
Offboard SATA Controller Configuration	Displays the information on your PCIe SATA controllers/ PCIe SSD if installed.

## 5-2-15 SATA Configuration

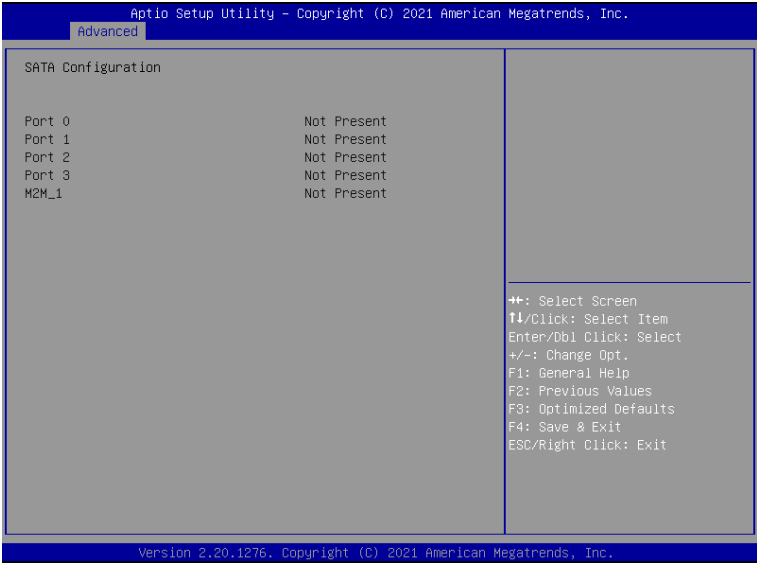

Parameter	Description
SATA Configuration	Displays the installed HDD devices information. System will automatically detect HDD type.

## 5-2-16 Realtek PCIe GBE Family Controller



Parameter	Description
Realtek PCIe GBE Family Controller	Press [Enter] to view the Network Interface Controller information.

## 5-3 Chipset Setup Menu

Chipset Setup menu displays submenu options for configuring the function of the onboard controller.

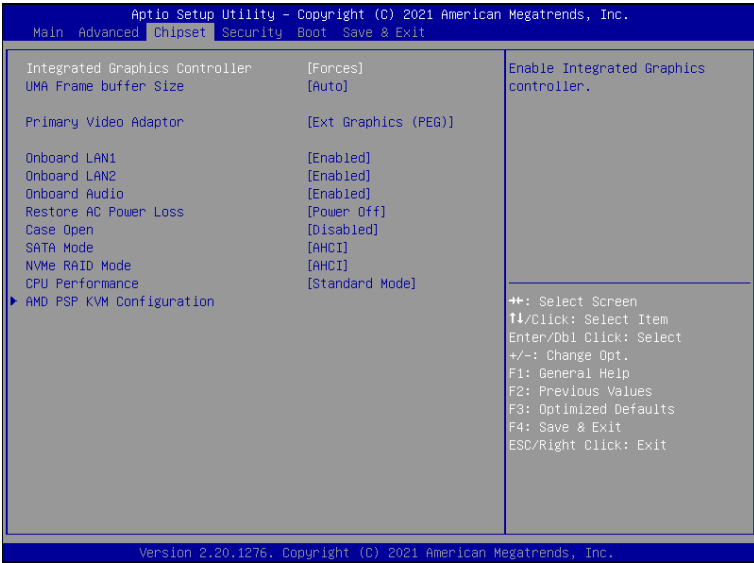

Parameter	Description
Integrated Graphics Controller	Enable/Disable Integrated Graphics controller. Options available: Disabled, Forces, Auto. Default setting is <b>Forces</b> .
UMA Frame buffer Size	Options available: Auto, 64M, 128M, 256M, 512M. Default setting is <b>Auto</b> .
Primary Video Adaptor	Options available: Int Graphics (IFD), Ext Graphics (PEG). Default setting is <b>Ext Graphics (PEG)</b> .
Onboard LAN1/2	Enable/Disable Onboard LAN. Options available: Disabled, Enabled. Default setting is <b>Enabled</b> .
Onboard Audio	Enable/Disable Onboard audio. Options available: Disabled, Enabled. Default setting is <b>Enabled</b> .
Restore AC Power Loss	Selects AC power state when power is re-applied after a power failure. Options available: Power Off, Power On, Last State. Default setting is <b>Power Off</b> .
Case Open	Enable/Disable case open function. Options available: Disabled, Enabled, Clear. Default setting is <b>Disabled</b> .
SATA Mode	Selects the SATA type. Options available: AHCI, RAID. Default setting is <b>AHCI</b> .



Parameter	Description
NVMe RAID Mode	Options available: AHCI, RAID. Default setting is <b>AHCI</b> .
CPU Performance	Changes CPU performance mode. Options available: Standard Mode, Performance Mode. Default setting is <b>Standard Mode</b> .
AMD PSP KVM Configuration	Press [Enter] to configure advanced items.

### 5-3-1 AMD PSP KVM Configuration

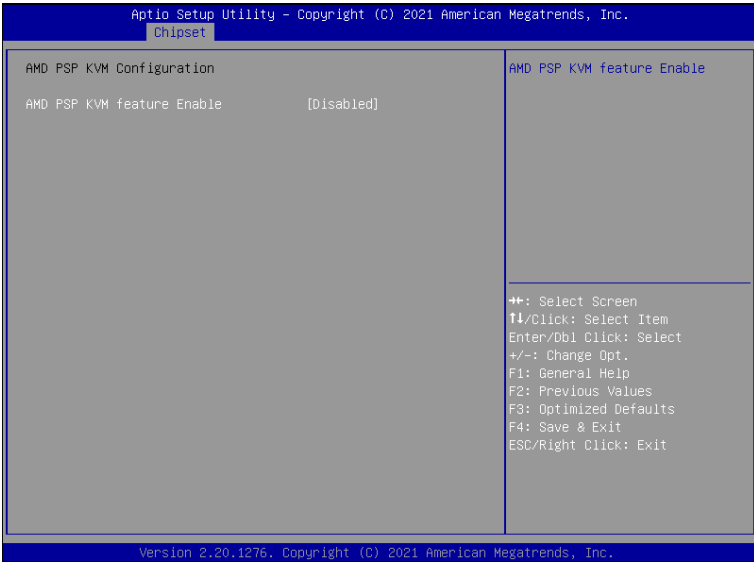

Parameter	Description
AMD PSP KVM Configuration	
AMD PSP KVM feature Enable <sup>(Note)</sup>	Enable/Disable AMD PSP KVM feature. Options available: Disabled, Enabled, Clear. Default setting is <b>Disabled</b> .
Resolution select for AMD PSP KVM feature	Options available: 1280 x 1024, 1024 x 768. Default setting is <b>1024 x 768</b> .
IPv4 IP Assignment	Options available: Dynamic, Static. Default setting is <b>Dynamic</b> .

(Note) Advanced items prompt when this item is defined.

# 5-4 Security Menu

The Security menu allows you to safeguard and protect the system from unauthorized use by setting up access passwords.

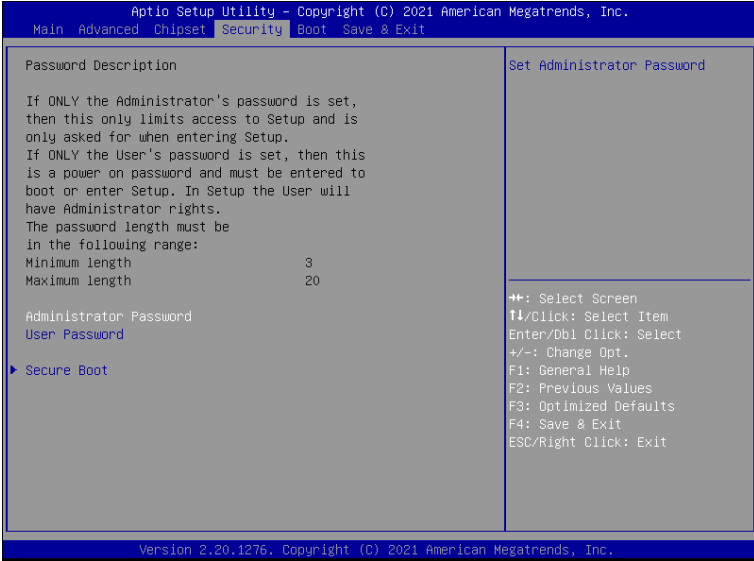

There are two types of passwords that you can set:

- Administrator Password  
Entering this password will allow the user to access and change all settings in the Setup Utility.
- User Password  
Entering this password will restrict a user's access to the Setup menus. To enable or disable this field, a Administrator Password must first be set. A user can only access and modify the System Time, System Date, and Set User Password fields.

Parameter	Description
Administrator Password	Press [Enter] to configure the administrator password.
User Password	Press [Enter] to configure the user password.
Secure Boot	Press [Enter] to configure advanced items.

## 5-4-1 Secure Boot

The Secure Boot submenu is applicable when your device is installed the Windows® 8 (or above) operating system.

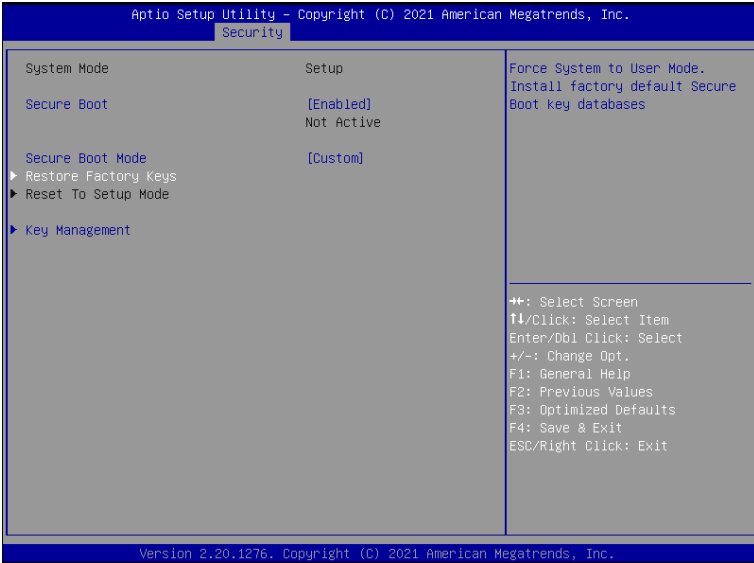

Parameter	Description
System Mode	Displays if the system is in User mode or Setup mode.
Secure Boot	Enable/ Disable the Secure Boot function. Options available: Enabled, Disabled. Default setting is <b>Enabled</b> .
Secure Boot Mode <sup>(Note)</sup>	Secure Boot requires all the applications that are running during the booting process to be pre-signed with valid digital certificates. This way, the system knows all files being loaded before Windows loads to the login screen have not been tampered with. When set to Standard, it will automatically load the Secure Boot keys form the BIOS databases. When set to Custom, you can customize the Secure Boot settings and manually load its keys from the BIOS database. Options available: Standard, Custom. Default setting is <b>Standard</b> .
Restore Factory Keys	Forces the system to user mode and installs factory default Secure Boot key database.
Reset to Setup Mode	Press [Enter] to reset the system mode to Setup mode.

(Note) Advanced items prompt when this item is set to **Custom**.

Parameter	Description
Key Management	<p data-bbox="329 156 659 180">Press [Enter] to configure advanced items.</p> <p data-bbox="329 185 936 235"><b>Please note that this item is configurable when Secure Boot Mode is set to Custom.</b></p> <ul style="list-style-type: none"> <li data-bbox="329 243 936 352">◆ Factory Key Provision <ul style="list-style-type: none"> <li data-bbox="361 266 936 321">– Allows to provision factory default Secure Boot keys when system is in Setup Mode.</li> <li data-bbox="361 326 936 352">– Options available: Enabled, Disabled. Default setting is <b>Disabled</b>.</li> </ul> </li> <li data-bbox="329 357 936 431">◆ Restore Factory Keys <ul style="list-style-type: none"> <li data-bbox="361 381 936 404">– Installs all factory default keys. It will force the system in User Mode.</li> <li data-bbox="361 409 936 431">– Options available: Yes, No.</li> </ul> </li> <li data-bbox="329 435 936 517">◆ Enroll Efi Image <ul style="list-style-type: none"> <li data-bbox="361 459 936 517">– Press [Enter] to enroll SHA256 hash of the binary into Authorized Signature Database (db).</li> </ul> </li> <li data-bbox="329 522 936 572">◆ Restore DB defaults <ul style="list-style-type: none"> <li data-bbox="361 545 936 572">– Restore DB variable to factory defaults.</li> </ul> </li> <li data-bbox="329 577 936 627">◆ Secure Boot variable <ul style="list-style-type: none"> <li data-bbox="361 600 936 627">– Displays the current status of the variables used for secure boot.</li> </ul> </li> <li data-bbox="329 631 936 744">◆ Platform Key (PK) <ul style="list-style-type: none"> <li data-bbox="361 655 936 682">– Displays the current status of the Platform Key (PK).</li> <li data-bbox="361 686 936 713">– Press [Enter] to configure a new PK.</li> <li data-bbox="361 718 936 744">– Options available: Update.</li> </ul> </li> <li data-bbox="329 749 936 885">◆ Key Exchange Keys (KEK) <ul style="list-style-type: none"> <li data-bbox="361 773 936 854">– Displays the current status of the Key Exchange Key Database (KEK).</li> <li data-bbox="361 804 936 854">– Press [Enter] to configure a new KEK or load additional KEK from storage devices.</li> <li data-bbox="361 859 936 885">– Options available: Update, Append.</li> </ul> </li> <li data-bbox="329 890 936 1027">◆ Authorized Signatures (DB) <ul style="list-style-type: none"> <li data-bbox="361 914 936 940">– Displays the current status of the Authorized Signature Database.</li> <li data-bbox="361 945 936 995">– Press [Enter] to configure a new DB or load additional DB from storage devices.</li> <li data-bbox="361 1000 936 1027">– Options available: Update, Append.</li> </ul> </li> <li data-bbox="329 1031 936 1168">◆ Forbidden Signatures (DBX) <ul style="list-style-type: none"> <li data-bbox="361 1055 936 1081">– Displays the current status of the Forbidden Signature Database.</li> <li data-bbox="361 1086 936 1136">– Press [Enter] to configure a new dbx or load additional dbx from storage devices.</li> <li data-bbox="361 1141 936 1168">– Options available: Update, Append.</li> </ul> </li> <li data-bbox="329 1172 936 1309">◆ Authorized TimeStamps (DBT) <ul style="list-style-type: none"> <li data-bbox="361 1196 936 1223">– Displays the current status of the Authorized TimeStamps Database.</li> <li data-bbox="361 1227 936 1277">– Press [Enter] to configure a new DBT or load additional DBT from storage devices.</li> <li data-bbox="361 1282 936 1309">– Options available: Update, Append.</li> </ul> </li> <li data-bbox="329 1313 936 1434">◆ OsRecovery Signatures <ul style="list-style-type: none"> <li data-bbox="361 1337 936 1364">– Displays the current status of the OsRecovery Signature Database.</li> <li data-bbox="361 1368 936 1419">– Press [Enter] to configure a new OsRecovery Signature or load additional OsRecovery Signature from storage devices.</li> <li data-bbox="361 1423 936 1434">– Options available: Update, Append.</li> </ul> </li> </ul>

## 5-5 Boot Menu

The Boot menu allows you to set the drive priority during system boot-up. BIOS setup will display an error message if the legacy drive(s) specified is not bootable.

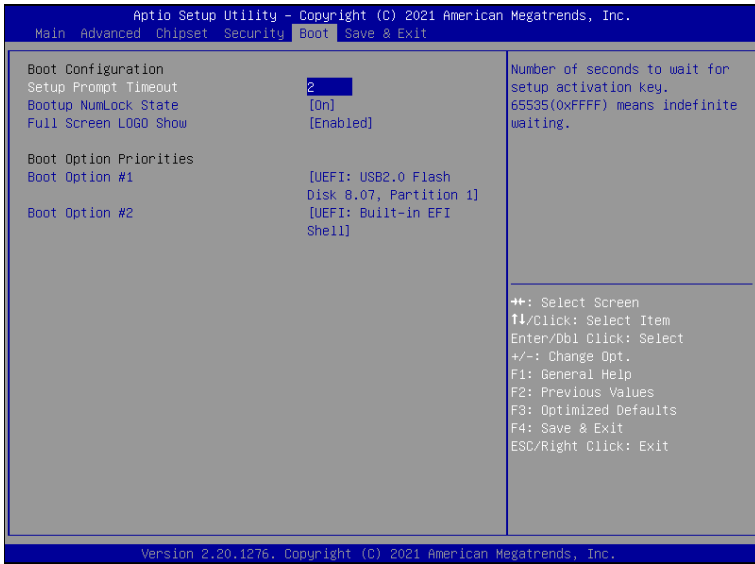

Parameter	Description
Boot Configuration	
Setup Prompt Timeout	Number of seconds to wait for setup activation key. 65535 (0xFFFF) means indefinite waiting. Press the numeric keys to input the desired values.
Bootup NumLock State	Enable/Disable the Bootup NumLock function. Options available: On, Off. Default setting is <b>On</b> .
Full Screen LOGO Show	Enable/Disable showing the logo during POST. Options available: Enabled, Disabled. Default setting is <b>Enabled</b> .
BOOT Option Priorities	
Boot Option #1 / #2	Press [Enter] to configure the boot priority.

## 5-6 Save & Exit Menu

The Save & Exit menu displays the various options to quit from the BIOS setup. Highlight any of the exit options then press <Enter>.

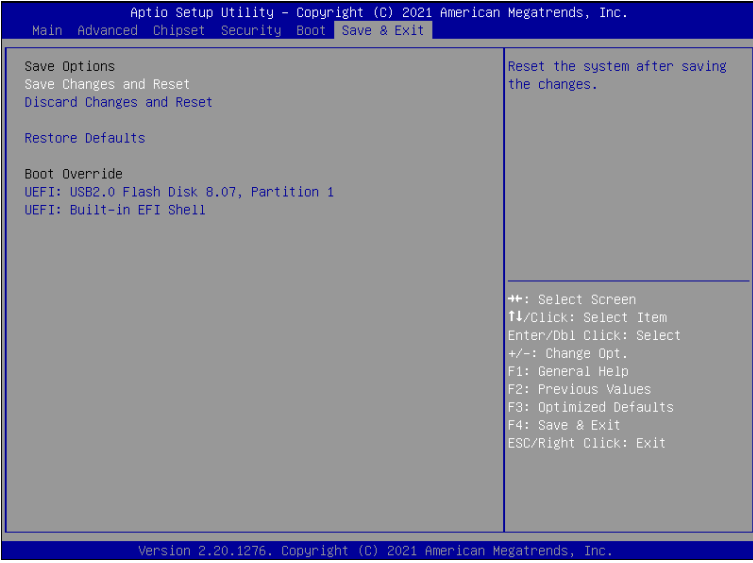

Parameter	Description
Save Options	
Save Changes and Reset	Saves changes made and closes the BIOS setup. Options available: Yes, No.
Discard Changes and Reset	Discards changes made and exits the BIOS setup. Options available: Yes, No.
Restore Defaults	Loads the default settings for all BIOS setup parameters. Setup Defaults are quite demanding in terms of resources consumption. If you are using low-speed memory chips or other kinds of low-performance components and you choose to load these settings, the system might not function properly. Options available: Yes, No.
Boot Override	Press [Enter] to configure the device as the boot-up drive.

## 5-7 BIOS POST Beep code (AMI standard)

### 5-7-1 PEI Beep Codes

# of Beeps	Description
1	Memory not Installed.
1	Memory was installed twice (InstallPeiMemory routine in PEI Core called twice)
2	Recovery started
3	DXE IPL was not found
3	DXE Core Firmware Volume was not found
4	Recovery failed
4	S3 Resume failed
7	Reset PPI is not available

### 5-7-2 DXE Beep Codes

# of Beeps	Description
1	Invalid password
4	Some of the Architectural Protocols are not available
5	No Console Output Devices are found
5	No Console Input Devices are found
6	Flash update is failed
7	Reset protocol is not available
8	Platform PCI resource requirements cannot be met