

Register your product and get support at
www.philips.com/welcome

AJ3115



EN User manual

PHILIPS

1

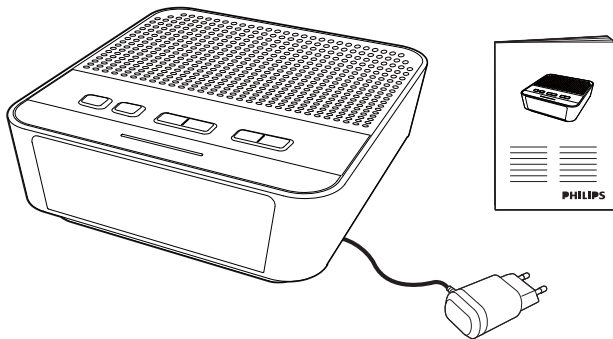

2

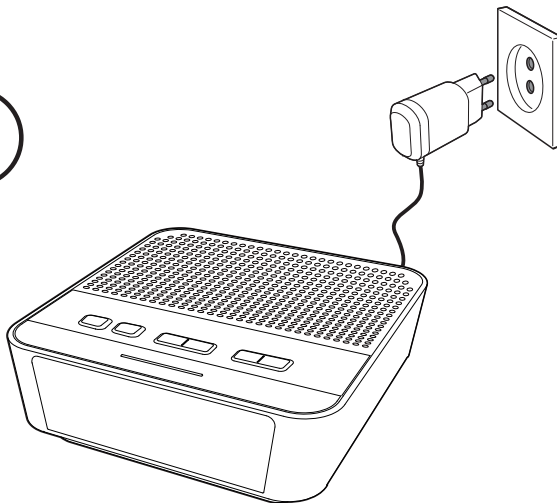

3

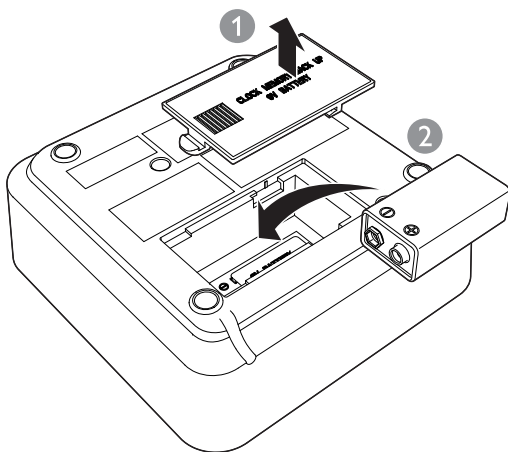

4

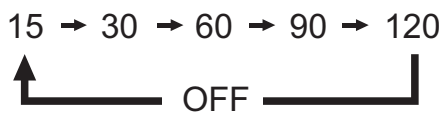
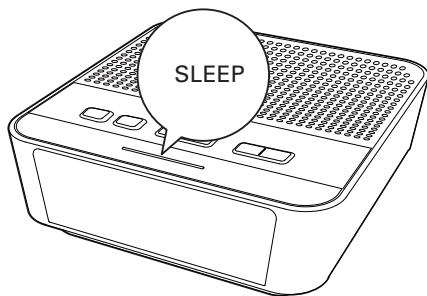

5

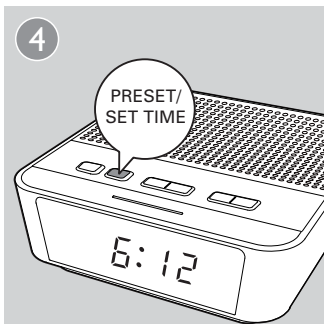
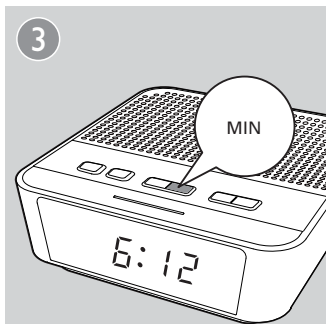
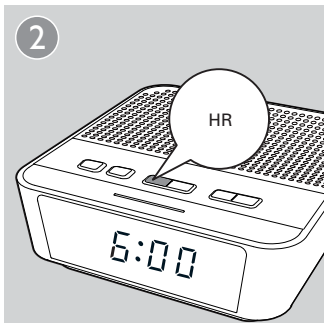
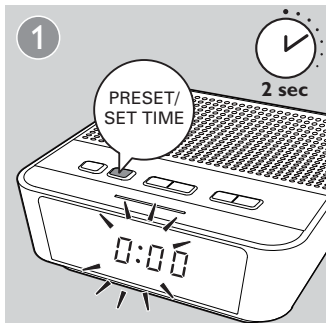

6

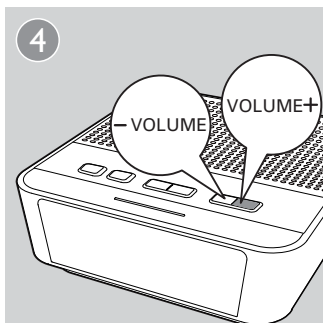
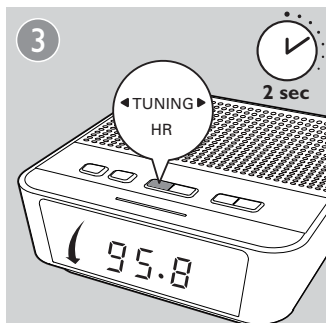
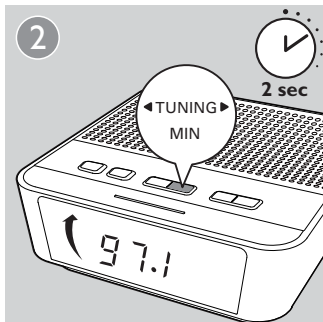
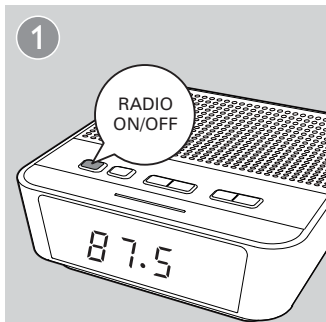

7

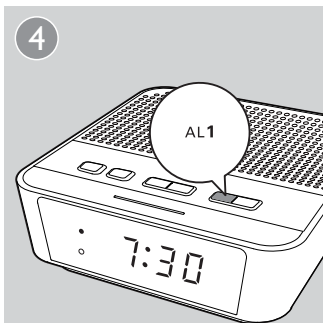
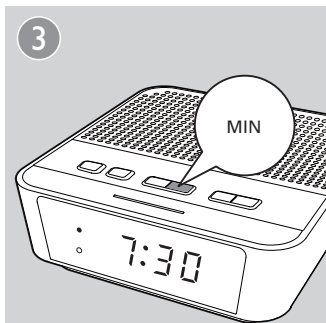
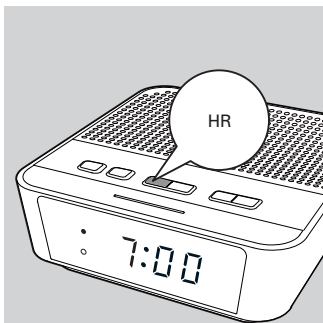
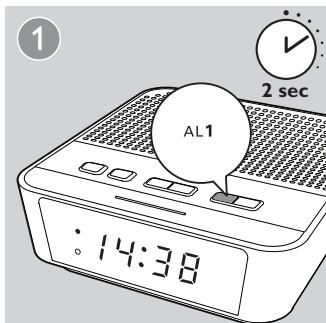

8

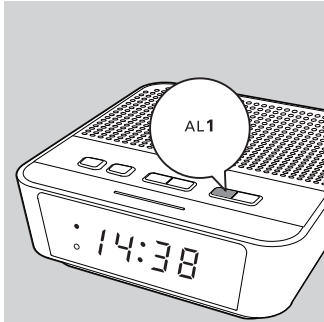

1 Important

- Read these instructions.
- Heed all warnings.
- Follow all instructions.
- Do not block any ventilation openings. Install in accordance with the manufacturer's instructions.
- Do not install near any heat sources such as radiators, heat registers, stoves, or other apparatus (including amplifiers) that produce heat.
- Protect the power cord from being walked on or pinched, particularly at plugs, convenience receptacles, and the point where they exit from the clock radio.
- Only use attachments/accessories specified by the manufacturer.
- Unplug this clock radio during lightning storms or when unused for long periods of time.
- Refer all servicing to qualified service personnel. Servicing is required when the clock radio has been damaged in any way, such as power-supply cord or plug is damaged, liquid has been spilled or objects have fallen into the clock radio, the clock radio has been exposed to rain or moisture, does not operate normally, or has been dropped.
- Battery usage **CAUTION** – To prevent battery leakage which may result in bodily injury, property damage, or damage to the clock radio:
 - Install the battery correctly, + and - as marked on the clock radio.
 - Remove the battery when the clock radio is not used for a long time.
 - The battery shall not be exposed to excessive heat such as sunshine, fire or the like.
- This clock radio shall not be exposed to dripping or splashing.
- Do not place any sources of danger on the clock radio (e.g. liquid filled objects, lighted candles).

- Where the plug of the Direct Plug-in Adapter is used as the disconnect device, the disconnect device shall remain readily operable.

2 Your clock radio

Congratulations on your purchase, and welcome to Philips! To fully benefit from the support that Philips offers, register your product at www.philips.com/welcome.

What's in the box (Fig. ①)

3 Get started

Always follow the instructions in this chapter in sequence.

Install battery

The battery can only back up clock and alarm settings.



Caution

- Risk of explosion! Keep the battery away from heat, sunshine or fire. Never discard battery in fire.
- The battery contains chemical substances, so it should be disposed of properly.

Insert one 9V **6F22** battery (not supplied) with correct polarity (+/-) as illustrated. (Fig. ③)



Tip

- The display backlight is off when AC power is disconnected.

Connect power (Fig. ②)



Caution

- Risk of product damage! Make sure that the power voltage corresponds to the voltage printed on the back or underside of the clock radio.
- Risk of electric shock! When you unplug the power adapter, always pull the plug from the socket. Never pull the cord.



Note

- The type plate is located at the bottom of the clock radio.

Set time (Fig. ⑤)



Note

- You can only set time in standby mode.

4 Listen to FM radio



Note

- Keep the clock radio away from other electronic devices to avoid radio interference.
- For better reception, fully extend and adjust the position of the FM antenna.

Tune to FM radio stations (Fig. ⑥)

Store FM radio stations manually

You can store up to 10 FM radio stations.

- 1 Tune to an FM radio station.
- 2 Press and hold **PRESET** for two seconds.
↳ The preset number begins to blink.
- 3 Press ◀ **TUNING** ▶ repeatedly to select a number.
- 4 Press **PRESET** again to confirm.
- 5 Repeat steps 1 to 4 to store other stations.



Tip

- To remove a pre-stored station, store another station in its place.

Select a preset radio station

In tuner mode, press **PRESET** repeatedly to select a preset number.

Adjust volume

While listening, press **-VOLUME +** to adjust volume.

5 Other features

Set alarm timer

Set alarm



Note

- You can only set the alarm in standby mode.
- When alarm sounds, volume rises gradually. You cannot adjust the alarm volume manually.
- Make sure that you have set the clock correctly.

Follow the illustration to set the first alarm. (Fig. ⑦)

- **AL1**: set the first alarm.
- **AL2**: set the second alarm.



Tip

- The clock radio exits alarm setting mode when being idle for 10 seconds.

Select alarm source

You can select FM radio or buzzer as the alarm source. (Fig. ⑧)

↳ The corresponding alarm icon lights up.

Activate/deactivate the alarm timer

Press **AL1** or **AL2** repeatedly to activate or deactivate the alarm timer. (Fig. ⑧)

- ↳ If the alarm timer is deactivated, the alarm indicator turns off.
- ↳ The alarm repeats ringing for the next day.

Snooze the alarm

When alarm sounds, press **SNOOZE**.

- ↳ The alarm snoozes and repeats ringing nine minutes later.

Set sleep timer

This clock radio can switch to standby mode automatically after a preset period. (Fig. ④)

To deactivate the sleep timer:

- Press **SLEEP** repeatedly until **[OFF]** (off) appears.

6 Product information



Note

- Product information is subject to change without prior notice.

Specifications

Amplifier

Total Output Power

200 mW RMS

Tuner (FM)

Tuning range	87.5-108 MHz
--------------	--------------

Tuning grid	50 KHz
-------------	--------

Sensitivity

- Mono, 26 dB S/N Ratio	<22 dBf
-------------------------	---------

- Stereo, 46 dB S/N Ratio	<51.5 dBf
---------------------------	-----------

Total Harmonic Distortion	<3%
---------------------------	-----

Signal to Noise Ratio	>50 dBA
-----------------------	---------

General information

AC power (power adapter)	Brand name: Philips; Model: AS030-060-EE050; Input: 100-240 V~, 50/60 Hz; 0.15 A; Output: 6 V $\overline{=}$ 0.5 A
--------------------------	--

Operation Power Consumption	5 W
-----------------------------	-----

Standby Power Consumption	<1 W
---------------------------	------

Dimensions:

Main Unit (W x H x D)	130 x 46 x 130 mm
-----------------------	-------------------

Weight:

-Main Unit	0.26 kg
------------	---------

-With Packing	0.4 kg
---------------	--------

7 Troubleshooting



Warning

- Never remove the casing of this apparatus.

To keep the warranty valid, never try to repair the system yourself. If you encounter problems when using this apparatus, check the following points before requesting service. If the problem remains unsolved, go to the Philips web site (www.philips.com/support). When you contact Philips, ensure that the apparatus is nearby and the model number and serial number are available.

No power

- Ensure that the AC power plug of the unit is connected properly.
- Ensure that there is power at the AC outlet.

No sound

- Adjust the volume.

No response from the unit

- Disconnect and reconnect the AC power plug, then turn on the unit again.

Poor radio reception

- Increase the distance between the unit and your TV or VCR.
- Fully extend the FM antenna.

Alarm does not work

- Set the clock/alarm correctly.

Clock/alarm setting erased

- Power has been interrupted or the power plug has been disconnected.
- Reset the clock/alarm.

8 Notice

Any changes or modifications made to this device that are not expressly approved by Philips Consumer Lifestyle may void the user's authority to operate the equipment.

This product complies with the radio interference requirements of the European Community.



Your product is designed and manufactured with high quality materials and components, which can be recycled and reused.



When this crossed-out wheeled bin symbol is attached to a product it means that the product is covered by the European Directive 2002/96/EC.



Please inform yourself about the local separate collection system for electrical and electronic products.

Please act according to your local rules and do not dispose of your old products with your normal household waste. Correct disposal of your old product helps to prevent potential negative consequences for the environment and human health.

Your product contains batteries covered by the European Directive 2006/66/EC, which cannot be disposed with normal household waste. Please inform yourself about the local rules on separate collection of batteries because correct disposal helps to prevent negative consequences for the environmental and human health.



Environmental information

All unnecessary packaging has been omitted. We have tried to make the packaging easy to separate into three materials: cardboard (box), polystyrene foam (buffer) and polyethylene (bags, protective foam sheet.) Your system consists of materials which can be recycled and reused if disassembled by a specialized company. Please observe the local regulations regarding the disposal of packaging materials, exhausted batteries and old equipment.



All registered and unregistered trademarks are property of their respective owners.

© 2012 Koninklijke Philips Electronics N.V.

All rights reserved.

AJ3115_12_UM_V1.1

