

Acer LCD Monitor

User Guide

Copyright © 2019. Acer Incorporated.
All Rights Reserved.

Acer LCD Monitor User Guide
Original Issue: 09/2019

Changes may be made periodically to the information in this publication without obligation to notify any person of such revisions or changes. Such changes will be incorporated in new editions of this manual or supplementary documents and publications. This company makes no representations or warranties, either expressed or implied, with respect to the contents hereof and specifically disclaims the implied warranties of merchantability or fitness for a particular purpose.

Record the model number, serial number, purchase date and place of purchase information in the space provided below. The serial number and model number are recorded on the label affixed to your computer. All correspondence concerning your unit should include the serial number, model number and purchase information.

No part of this publication may be reproduced, stored in a retrieval system, or transmitted, in any form or by any means, electronically, mechanically, by photocopy, recording or otherwise, without the prior written permission of Acer Incorporated.

Acer LCD Monitor User Guide

Model number: _____

Serial number: _____

Date of purchase: _____

Place of purchase: _____

Acer and the Acer logo are registered trademarks of Acer Incorporated. Other companies' product names or trademarks are used herein for identification purposes only and belong to their respective companies.

Information for your safety and comfort

Safety instructions

Read these instructions carefully. Keep this document for future reference. Follow all warnings and instructions marked on the product.

Acer monitor is purposed for video and visual display of information obtained from electronic devices.

Special notes on LCD monitors

The following are normal with the LCD monitor and do not indicate a problem.

- Due to the nature of the fluorescent light, the screen may flicker during initial use. Turn off the power switch and then turn it on again to make sure the flicker disappears.
- You may find slightly uneven brightness on the screen depending on the desktop pattern you use.
- The LCD screen has 99.99% or more effective pixels. It may include blemishes of 0.01% or less such as a missing pixel or pixel lit all the time.
- Due to the nature of the LCD screen, an afterimage of the previous screen may remain after switching the image, when the same image is displayed for hours. In this case, the screen is recovered slowly by changing the image or turning off the power switch for a few hours.

Cleaning your monitor

Please carefully follow these guidelines when cleaning the monitor:

- Always unplug the monitor before cleaning.
- Use a soft cloth to wipe the screen and cabinet front and sides.

Accessibility

Be sure that the power outlet you plug the power cord into is easily accessible and located as close to the equipment operator as possible. When you need to disconnect power from the equipment, be sure to unplug the power cord from the electrical outlet.

Safe listening

To protect your hearing, follow these instructions.

- Gradually increase the volume until you can hear it clearly and comfortably and without distortion.
- After setting the volume level, do not increase it after your ears have adjusted.
- Limit the amount of time listening to music at high volume.
- Avoid turning up the volume to block out noisy surroundings.
- Turn the volume down if you can't hear people speaking near you.

Warnings

- Do not use this product near water.
- Do not place this product on an unstable cart, stand or table. If the product falls, it could be seriously damaged.
- Slots and openings are provided for ventilation to ensure reliable operation of the product and to protect it from overheating. These openings must not be blocked or covered. The openings should never be blocked by placing the product on a bed, sofa, rug or other similar surface. This product should never be placed near or over a radiator or heat register, or in a built-in installation unless proper ventilation is provided.
- Never push objects of any kind into this product through cabinet slots as they may touch dangerous voltage points or short-out parts that could result in a fire or electric shock. Never spill liquid of any kind onto or into the product.
- To avoid damage of internal components and to prevent battery leakage, do not place the product on a vibrating surface.
- Never use it under sporting, exercising, or any vibrating environment which will probably cause unexpected short current or damage internal devices.

Using electrical power

- This product should be operated from the type of power indicated on the marking label. If you are not sure of the type of power available, consult your dealer or local power company.
- Do not allow anything to rest on the power cord. Do not locate this product where people will walk on the cord.

- If an extension cord is used with this product, make sure that the total ampere rating of the equipment plugged into the extension cord does not exceed the extension cord ampere rating. Also, make sure that the total rating of all products plugged into the wall outlet does not exceed the fuse rating.
- Do not overload a power outlet, strip or receptacle by plugging in too many devices. The overall system load must not exceed 80% of the branch circuit rating. If power strips are used, the load should not exceed 80% of the power strip's input rating.
- This product's power cord is equipped with a three-wire grounded plug. The plug only fits in a grounded power outlet. Make sure the power outlet is properly grounded before inserting the power cord plug. Do not insert the plug into a non-grounded power outlet. Contact your electrician for details.



.....

Warning! The grounding pin is a safety feature. Using a power outlet that is not properly grounded may result in electric shock and/or injury.



.....

Note: The grounding pin also provides good protection from unexpected noise produced by other nearby electrical devices that may interfere with the performance of this product.

- Use the product only with the supplied power supply cord set. If you need to replace the power cord set, make sure that the new power cord meets the following requirements: detachable type, UL listed/CSA certified, type SPT-2, rated 7 A 125 V minimum, VDE approved or its equivalent, 4.6 meters (15 feet) maximum length.

Product servicing

Do not attempt to service this product yourself, as opening or removing covers may expose you to dangerous voltage points or other risks. Refer all servicing to qualified service personnel.

Unplug this product from the wall outlet and refer servicing to qualified service personnel when:

- the power cord or plug is damaged, cut or frayed
- liquid was spilled into the product
- the product was exposed to rain or water
- the product has been dropped or the case has been damaged
- the product exhibits a distinct change in performance, indicating a need for service
- the product does not operate normally after following the operating instructions



Note: Adjust only those controls that are covered by the operating instructions, since improper adjustment of other controls may result in damage and will often require extensive work by a qualified technician to restore the product to normal condition.

Potentially explosive environments

Switch off your device in any area with a potentially explosive atmosphere and obey all signs and instructions. Potentially explosive atmospheres include areas where you would normally be advised to turn off your vehicle engine. Sparks in such areas could cause an explosion or fire resulting in bodily injury or even death. Switch off the device near depots, storage and distribution areas; chemical plants; or where blasting operations are in progress. Areas with a potentially explosive atmosphere are often, but not always, marked. They include below deck on boats, chemical transfer or storage facilities, vehicles using liquefied petroleum gas (such as propane or butane), and areas where the air contains chemicals or particles such as grain, dust or metal powders.

Additional safety information

Your device and its enhancements may contain small parts. Keep them out of the reach of small children.

IT Equipment Recycling Information

Acer is strongly committed to environmental protection and views recycling, in the form of salvaging and disposal of used equipment, as one of the company's top priorities in minimizing the burden placed on the environment.

We at Acer are very conscious of the environmental effects of our business and strive to identify and provide the best working procedures to reduce the environmental impact of our products.

For more information and help when recycling, please go to this website:

<http://www.acer-group.com/public/Sustainability/sustainability01.htm>

Visit www.acer-group.com for further information on the features and benefits of our other products.

Disposal instructions



Do not throw this electronic device into the trash when discarding. To minimize pollution and ensure utmost protection of the global environment, please recycle. For more information on the Waste from Electrical and Electronics Equipment (WEEE) regulations, visit <http://www.acer-group.com/public/Sustainability/sustainability01.htm>

LCD pixel statement

The LCD unit is produced with high-precision manufacturing techniques. Nevertheless, some pixels may occasionally misfire or appear as black or red dots. This has no effect on the recorded image and does not constitute a malfunction.

This product has been shipped enabled for power management:

- Activate display's Sleep mode within 5 minutes of user inactivity.
- Wake the monitor when it is in Active Off mode, move the mouse or press any keyboard key.

Tips and information for comfortable use

Computer users may complain of eyestrain and headaches after prolonged use. Users are also at risk of physical injury after long hours of working in front of a computer. Long work periods, bad posture, poor work habits, stress, inadequate working conditions, personal health and other factors greatly increase the risk of physical injury.

Incorrect computer usage may lead to carpal tunnel syndrome, tendonitis, tenosynovitis or other musculoskeletal disorders. The following symptoms may appear in the hands, wrists, arms, shoulders, neck or back:

- numbness, or a burning or tingling sensation
- aching, soreness or tenderness
- pain, swelling or throbbing
- stiffness or tightness
- coldness or weakness

If you have these symptoms, or any other recurring or persistent discomfort and/or pain related to computer use, consult a physician immediately and inform your company's health and safety department.

The following section provides tips for more comfortable computer use.

Finding your comfort zone

Find your comfort zone by adjusting the viewing angle of the monitor, using a footrest, or raising your sitting height to achieve maximum comfort. Observe the following tips:

- refrain from staying too long in one fixed posture
- avoid slouching forward and/or leaning backward
- stand up and walk around regularly to remove the strain on your leg muscles

Taking care of your vision

Long viewing hours, wearing incorrect glasses or contact lenses, glare, excessive room lighting, poorly focused screens, very small typefaces and low-contrast displays could stress your eyes. The following sections provide suggestions on how to reduce eyestrain.

Eyes

- Rest your eyes frequently.
- Give your eyes regular breaks by looking away from the monitor and focusing on a distant point.
- Blink frequently to keep your eyes from drying out.

Display

- Keep your display clean.
- Keep your head at a higher level than the top edge of the display so your eyes point downward when looking at the middle of the display.
- Adjust the display brightness and/or contrast to a comfortable level for enhanced text readability and graphics clarity.
- Eliminate glare and reflections by:
 - placing your display in such a way that the side faces the window or any light source
 - minimizing room light by using drapes, shades or blinds
 - using a task light
 - changing the display's viewing angle
 - using a glare-reduction filter
 - using a display visor, such as a piece of cardboard extended from the display's top front edge
- Avoid adjusting your display to an awkward viewing angle.
- Avoid looking at bright light sources, such as open windows, for extended periods of time.

Developing good work habits

Develop the following work habits to make your computer use more relaxing and productive:

- Take short breaks regularly and often.
- Perform some stretching exercises.
- Breathe fresh air as often as possible.
- Exercise regularly and maintain a healthy body.



Acer Incorporated
8F, 88, Sec. 1, Xintai 5th Rd., Xizhi
New Taipei City 221, Taiwan

Declaration of Conformity

We,
Acer Incorporated
8F, 88, Sec. 1, Xintai 5th Rd., Xizhi, New Taipei City 221, Taiwan

And,
Acer Italy s.r.l.
Viale delle Industrie 1/A, 20020 Arese (MI), Italy
Tel: +39-02-939-921 ,Fax: +39-02 9399-2913
www.acer.it

Product:	LCD Monitor
Trade Name:	Acer
Model Number:	XV270
SKU Number:	XV270 xxxxxx; ("x" = 0-9, a~z, A~Z, or blank)

We, Acer Incorporated, hereby declare under our sole responsibility that the product described above is in conformity with the relevant Union harmonization legislations as below Directive and following harmonized standards and/or other relevant standards have been applied:

EMC Directive: 2014/30/EU

<input checked="" type="checkbox"/> EN 55032:2012/AC:2013 Class B	<input checked="" type="checkbox"/> EN 55024:2010
<input checked="" type="checkbox"/> EN 55032:2015+AC 2016 Class B	<input checked="" type="checkbox"/> EN 61000-3-3:2013
<input checked="" type="checkbox"/> EN 61000-3-2:2014 Class D	

LVD Directive: 2014/35/EU

<input checked="" type="checkbox"/> EN 60950-1:2006/A11:2009/A1:2010/A12:2011/A2:2013

RoHS Directive: 2011/65/EU

<input checked="" type="checkbox"/> EN 50581:2012

ErP Directive: 2009/125/EC

<input checked="" type="checkbox"/> Regulation (EC) No. 1275/ 2008; EN 50564:2011

Year to begin affixing CE marking: 2019.

RU Jan / Sr. Manager
Acer Incorporated (Taipei, Taiwan)

Sep.30,2019

Date

acer

Acer America Corporation
333 West San Carlos St., San Jose
Suite 1500
CA 95110, U. S. A.
Tel : 254-298-4000
Fax : 254-298-4147
www.acer.com



Federal Communications Commission Supplier's Declaration of Conformity

This device complies with Part 15 of the FCC Rules. Operation is subject to the following two conditions: (1) this device may not cause harmful interference, and (2) this device must accept any interference received, including interference that may cause undesired operation.

The following local Manufacturer /Importer is responsible for this declaration:

Product:	LCD Monitor
Model Number:	XV270
SKU Number:	XV270 xxxxxx ("x" = 0~9, a ~ z, or A ~ Z)
Name of Responsible Party:	Acer America Corporation
Address of Responsible Party:	333 West San Carlos St. Suite 1500 San Jose, CA 95110 U. S. A.
Contact Person:	Acer Representative
Phone No.:	254-298-4000
Fax No.:	254-298-4147

Contents

Information for your safety and comfort	3
Safety instructions	3
Special notes on LCD monitors	3
Cleaning your monitor	3
Accessibility	4
Safe listening	4
Warnings	4
Using electrical power	4
Product servicing	5
Potentially explosive environments	6
Additional safety information	6
IT Equipment Recycling Information	6
Disposal instructions	6
LCD pixel statement	7
Tips and information for comfortable use	7
Finding your comfort zone	7
Taking care of your vision	8
Developing good work habits	8
Federal Communications Commission	10
Supplier's Declaration of Conformity	10
Unpacking	12
SCREEN POSITION ADJUSTMENT	13
Connecting the adapter and AC Power cord	14
Power saving	14
Display Data Channel (DDC)	15
19-pin color display signal cable*	15
20-pin color display signal cable*	16
Standard timing table	17
Installation	18
Troubleshooting	29
HDMI /DP Mode (Optional)	29

Unpacking

Please check that the following items are present when you unpack the box, and save the packing materials in case you need to ship or transport the monitor in the future.

LCD monitor

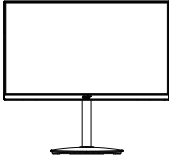

Quick start guide



AC Power cord

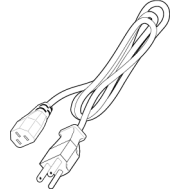

HDMI Cable
(Optional)

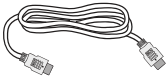

DP Cable
(Optional)

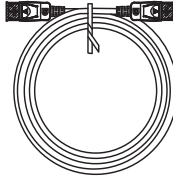

SCREEN POSITION ADJUSTMENT

In order to optimize the best viewing position, you can adjust the height/tilt of the monitor.

- **Height Adjustment**

After pressing the top of the monitor then you can adjust the height of the monitor.

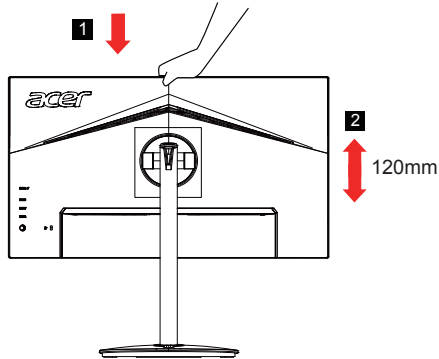

- **Tilt**

Please see the illustration below for an example of the tilt range.

Only at the highest point can 20 degrees of recline be offered for the angle of elevation.

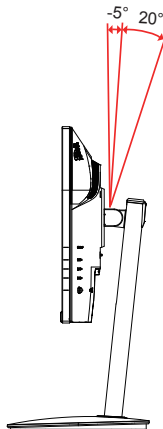

- **Swivel**

With the built-in pedestal, you can swivel the monitor for the most comfortable viewing angle.

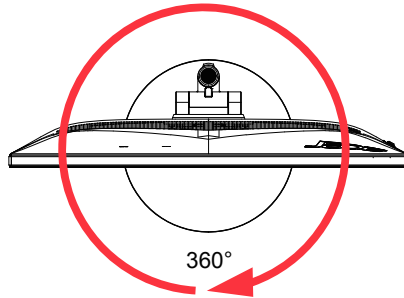

- **Monitor Pivot**

Before rotating the display, lift it to the top position and then push it back to the utmost degree. Rotate clockwise or counter-clockwise until the monitor stops at $\pm 90^\circ$.

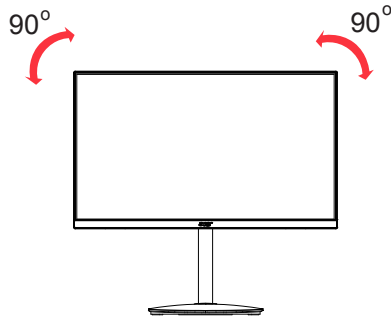

Connecting the adapter and AC Power cord

- Check first to make sure that the power cord you use is the correct type required for your area.
- The monitor has a universal power supply that allows operation in either 100/120 V AC or 220/240 V AC voltage area. No user-adjustment is required.
- Plug one end of the AC power cord to the Adapter, and plug the other end into an AC outlet.
- For units using 120 V AC:
Use a UL-listed cord set, type SVT wire and plug rated 10 A/125 V.
- For units using 220/240 V AC:
Use a cord set consisting of H05VV-F cord and plug rated 10 A/250 V. The cord set should have the appropriate safety approvals for the country in which the equipment will be installed.

Power saving

The monitor will be driven into "Power Saving" mode by the control signal from the display controller, as indicated by the amber-color power LED.

State	LED Light
ON	Blue
Power Saving Mode	Amber

The power saving states will be kept until a control signal has been detected or the keyboard or mouse is activated. The recovery time from Active OFF state back to ON state is around 3 seconds.

Display Data Channel (DDC)

To make installation easier, so long as your system supports the DDC protocol, the monitor is able to plug-and-play. The DDC is a communication protocol through which the monitor automatically informs the host system about its capabilities; for example, supported resolutions and corresponding timing. The monitor supports the DDC2B standard.

19-pin color display signal cable*

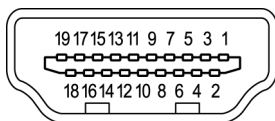

PIN No.	Description	PIN No.	Description
1	TMDS Data2+	2	TMDS Data2 Shield
3	TMDS Data2-	4	TMDS Data1+
5	TMDS Data1 Shield	6	TMDS Data1-
7	TMDS Data0+	8	TMDS Data0 Shield
9	TMDS Data0-	10	TMDS Clock+
11	TMDS Clock Shield	12	TMDS Clock-
13	CEC	14	Reserved (N.C. on device)
15	SCL	16	SDA
17	DDC/CEC Ground	18	+5V Power
19	Hot Plug Detect		

20-pin color display signal cable*

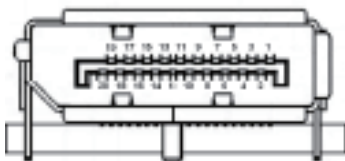

PIN No.	Description	PIN No.	Description
1	Lane0(p)	2	GND
3	Lane0(n)	4	Lane1(p)
5	GND	6	Lane1(n)
7	Lane2(p)	8	GND
9	Lane3(n)	10	Lane3(p)
11	GND	12	Lane3(n)
13	Config1	14	Config2
15	AUX_CH (n)	16	GND
17	AUX_CH (p)	18	Hot Plug Detect
19	DP Power_Return	20	DP Power

* only for certain models

Standard timing table

VESA MODE			
MODE	Resolution		
1	VGA	640x480	60Hz
2	MAC	640x480	66.662Hz
3	VESA	720x400	70Hz
4	SVGA	800x600	56Hz
5	SVGA	800x600	60Hz
6	XGA	1024x768	60Hz
7	XGA	1024x768	70Hz
8	VESA	1152x864	75Hz
9	SXGA	1280x1024	60Hz
10	VESA	1280x720	60Hz
11	WXGA	1280x800	60Hz
12	WXGA+	1440x900	60Hz
13	WSXGA+	1680x1050	60Hz
14	UXGA	1920x1080	60Hz
15	UXGA	1920x1080	75Hz
16	UXGA	1920x1080	144Hz (Recommended resolution)
17	UXGA	1920x1080	165Hz *

* XV270 can be overclocked to a higher refresh rate than advertised by the panel specification. This function can be used by the system control panel to set the maximum refresh rate.

Important: This device is designed to support refresh rate overclocking. However, overclocking may result in system instability. If you experience instability, try reducing the overclock to a lower refresh rate through the on-screen display settings.

Installation

1. Turn off your computer and unplug your computer's power cord.
2. Connect the signal cable to the HDMI (optional) and /or DP (optional) input socket of the monitor, and the HDMI (optional) and /or DP (optional) output socket of the graphics card on the computer.
3. Insert the monitor power cable into the power port at the back of the monitor.
4. Plug the power cords of your computer and your monitor into a nearby electrical outlet.

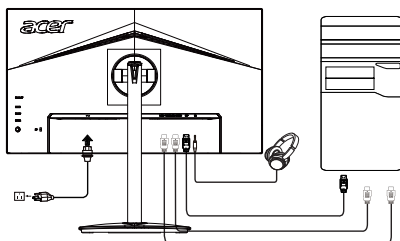

Note: Audio output is only for audio output model. Please check user manual for more instruction.

FreeSync:

It can allow a FreeSync supported graphics source to dynamically adjust display refresh rate based on typical content frame rates for power efficient, virtually stutter free and low-latency display update.

User Controls

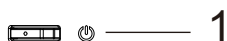

1



2



3







4



5

External controls

1	Power button	Turns the monitor on/off. Blue indicates power on. Amber indicates standby/ power saving mode.
2	Function key 	<ol style="list-style-type: none"> Press to view Main page. Press again to enter hotkey1 function. When the Function Menu is active, press this key to view the basic information for your monitor and current input or reset the custom color settings to the factory defaults.
3	Function key 	<ol style="list-style-type: none"> Press to view Main page. Press again to enter hotkey2 function. When the Function Menu is active, press this button to select select scenario mode or game mode .
4	Function key 	<ol style="list-style-type: none"> Press to view Main page. Press again to enter Input select function. When the Function Menu is active, this button will quit the OSD.
5	Function key 	<ol style="list-style-type: none"> Press to view Main page. Press again to enter next function in the Function Menu. The single toggle button on the backside of the Display bezel operates like a joystick. To move the cursor, simply toggle the button in four directions. Press the button to select desired option. Red indicates operable. Grey indicates inoperable.

Using the Shortcut Menu



Note: The following content is for general reference only. Actual product specifications may vary.

The OSD (onscreen display) can be used to adjust the settings of your LCD monitor. Press the MENU key to open the OSD. You can use the OSD to adjust the picture quality and general settings. For advanced settings, please refer to following page:

Main page

	<ol style="list-style-type: none"> 1. Menu OSD 2. Hot Key1 (Modes, Volume, Brightness, Gamma, Contrast, Blue Light, Over Drive) 3. Hot Key2 (Modes, Volume, Brightness, Gamma, Contrast, Blue Light, Over Drive) 4. Input selection
--	---

Hot key1 (default: Standard mode)

To choose game mode(G1, G2, G3) which user-defined profile to use or scenario mode (User, Standard, ECO, Graphics, HDR)

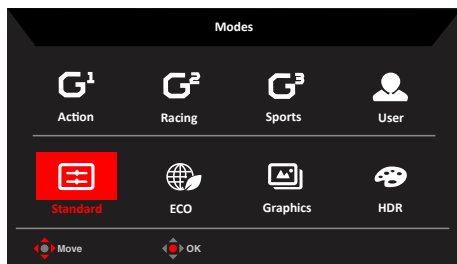

Hot key2 (default: Brightness)

Open the Brightness control and select your preferred brightness setting . When you are done, press the joystick to quit current page and store.

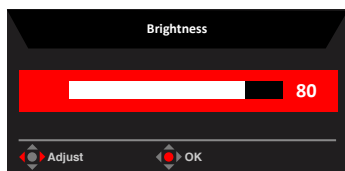

Selecting the input

Open the Input control and select HDMI 1, HDMI 2, DP or Auto Source. When you are done, press the joystick to exit current page and store.

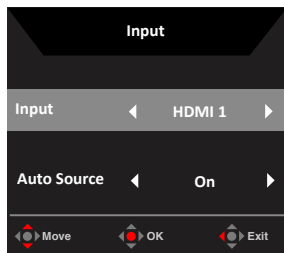

The Function page

Open the Function page to adjust the functions, settings which you want using the arrows. When you are done, toggle the joystick to the left or right to go back one level or use **X-** to exit current page and store.

Picture

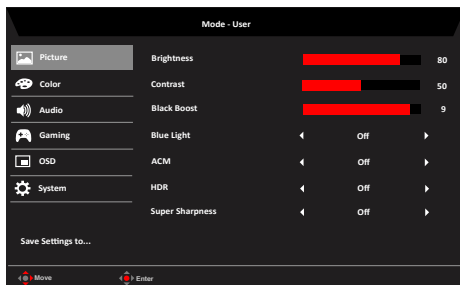

1. Press the MENU key to open the OSD.
2. Toggle the joystick to the up or down to select Picture from the OSD. Then toggle to the right to navigate to the element you wish to adjust and press the joystick to enter it.
3. Toggle to the left or right to adjust the sliding scales.
4. The Picture menu can be used to adjust the Brightness, Contrast, Black Boost, Blue Light, ACM, HDR and Super Sharpness.
5. Brightness: Adjust the brightness from 0 to 100.

 **Note:** Adjusts the balance between light and dark shades.
6. Contrast: Adjust the contrast from 0 to 100.

 **Note:** Sets the degree of difference between light and dark areas.
7. Black Boost: Adjust the black level from 0 to 10. Enhances shadows by increasing the brightness without changing lighter shades.

8. Blue Light: Filters out blue light to protect your eyes by adjusting how much blue light is shown -- 80%, 70%, 60%, or 50%.



Note: Higher values allow more blue light through. For the best protection select a lower value.

9. ACM: Turn ACM on or off. The default is off.
10. Super Sharpness: Turn the Super Sharpness On or Off. Super Sharpness technology can simulate high-resolution images by boosting the pixel density of the original source to make images sharper and clearer.
11. HDR function

- **Hot Key of Mode:**



- **Main Menu of HDR:**

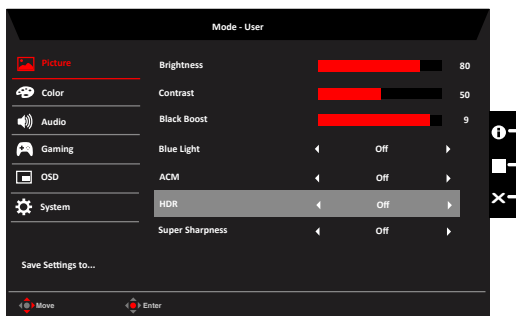

• **HDR Status:**

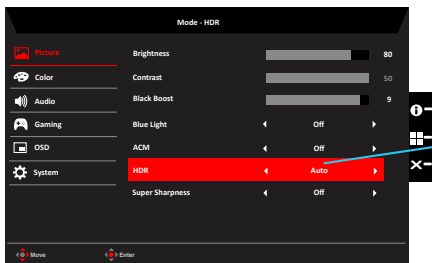

HDR = (Auto or HDR-400)

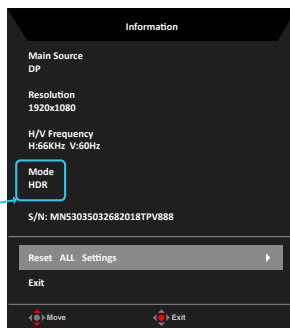

Information Page

• **HDR function and Effect:**

Optional	Behavior
Auto	Auto checked input source status
Off (Default)	No support HDR effect



Note:

1. HDR = (Auto), The source signal content is SDR, the brightness can to adjustment, but content is HDR the brightness is fixed at 100 and gray out.
2. HDR = (Auto), features: (ACM/Gamma/Contrast/Blue Light/Color Temp/Black Boost/6-axis Hue & Saturate) is gray out and unavailable, default parameter please refer to "Modes".
3. HDR = (Auto), Color Page only shows the adjustable function, other functions (Gamma and Color Temp are hidden).

Color

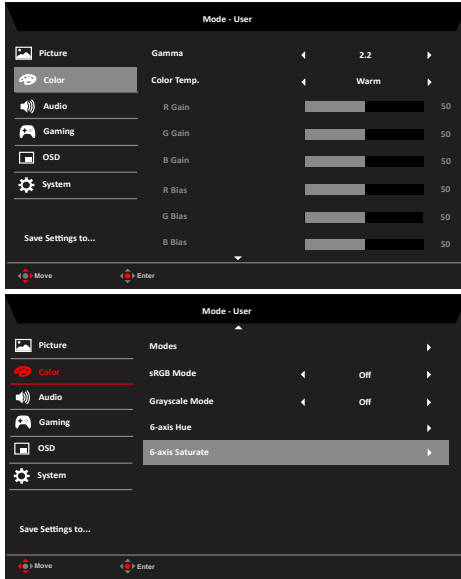

1. Press the MENU key to open the OSD.
2. Toggle the joystick to the up or down to select Color from the OSD. Then toggle to the right to navigate to the element you wish to adjust and press the joystick to enter it.
3. Toggle to the left or right to adjust the sliding scales.
4. Gamma mode allows you to adjust the luminance tone. The default value is 2.2 (standard value for Windows).
5. Color temperature: Default is warm. You can choose Cool, Normal, Warm, Bluelight or User.
6. Modes: To choose scenario mode.
7. sRGB Mode: Default is off. You can turn sRGB on or off to better color match with peripheral devices, such as printers and digital cameras.
8. Grayscale Mode: To choose Grayscale mode.
9. 6-axis Hue: Adjust the red, green, blue, yellow, magenta and cyan hue.
10. 6-axis Saturate: Adjust the red, green, blue, yellow, magenta and cyan saturation.

Audio

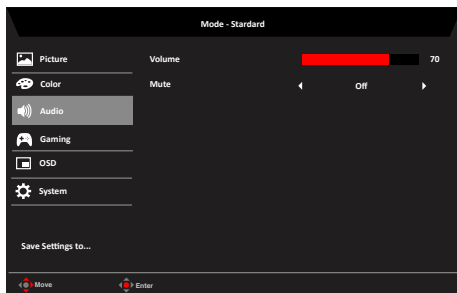

1. Press the MENU key to open the OSD.
2. Toggle the joystick to the up or down to select Audio from the OSD. Then toggle to the right to navigate to the element you wish to adjust and press the joystick to enter it.
3. Toggle to the left or right to adjust the sliding scales.
4. Volume: Adjust the volume
5. Mute: To choose mute on/off .

Gaming

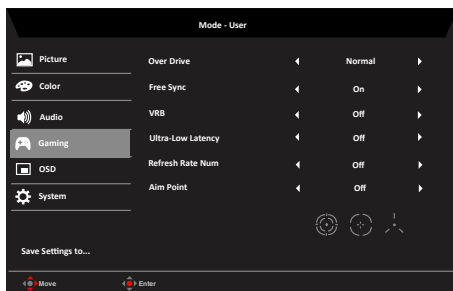

1. Press the MENU key to open the OSD.
2. Toggle the joystick to the up or down to select Gaming from the OSD. Then toggle to the right to navigate to the element you wish to adjust and press the joystick to enter it.
3. Toggle to the left or right to adjust the sliding scales.
4. Over Drive: Select Off, Normal, or Extreme.
5. FreeSync: To control support FreeSync or not, default is On.



Note:

1. If FreeSync is "ON", then the Over Drive selection is set to "Normal" automatically.
2. If FreeSync is "OFF", then the user can set Over Drive to either one of the three settings including: (a) Extreme (b) Normal (c) Off.

6. VRB: To choose whether to support dynamic picture more clean control, default is Off.



Note:

1. HDR setting: "Auto" is not support VRB.
2. VRB set "On", when to turn on FreeSync, will auto set VRB is "Off".
3. VRB set "On", when to adjustment (Brightness, Blue Light, ACM), will auto set VRB is "Off".
4. VRB function does not affect the (Logo, Aim Point, Message and Input Icon) brightness.
5. VRB setting "On", when detection of Input Timing <75Hz, will auto off the VRB and gray out to disable.
6. VRB = (Normal or Extreme), because the IC control dynamic picture is cleaner, so the overall Brightness will be dark, "Extreme" will be darker than "Normal".

7. Refresh rate num: Display the panel's current refresh rate on the screen.



Note: If FreeSync set "On" you can see the V Frequency to changes in the OSD.

8. Ultra-Low Latency: Set to On to speed up the processing time of the display switching process.



Note:

1. FreeSync is On, the Ultra-Low Latency automatic set to On and gray out unavailable.
2. Ultra-low latency is not supported at resolutions below 800x600.

9. Aim point: Show an Aim point on the screen for shooting games.

OSD

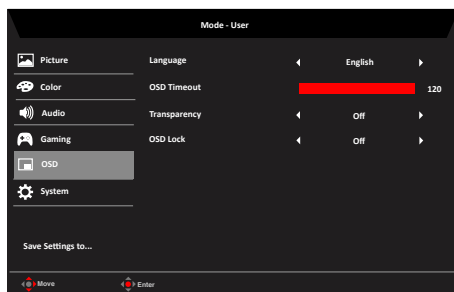

1. Press the MENU key to open the OSD.
2. Toggle the joystick to the up or down to select OSD from the OSD. Then toggle to the right to navigate to the element you wish to adjust and press the joystick to enter it.
3. Toggle to the left or right to adjust the sliding scales.

- Language: Set the OSD menu language.
- OSD timeout: Adjust the delay before turning off the OSD menu.
- Transparency: Select the transparency when using gaming mode. The transparency can be 0% (OFF), 20%, 40%, 60%, or 80%.
- OSD Lock: To choose OSD lock on/off.

Note:

OSD Locked:

- Set the OSD Lock to "On" by the OSD option and press "Enter" to execute the All Key lock function.
- The "OSD Locked" message will be displayed in the middle of the screen.
- LED lights will be changed from blue light to orange light.
- Press any Key screen to prompt "OSD Locked" message.

OSD Unlocked:

- In normal display condition to press the "Navi Key" in the middle of more than 3 seconds to trigger "OSD Unlock".
- The "OSD Unlock" message will be displayed in the middle of the screen.
- LED lights will be restored to blue light.

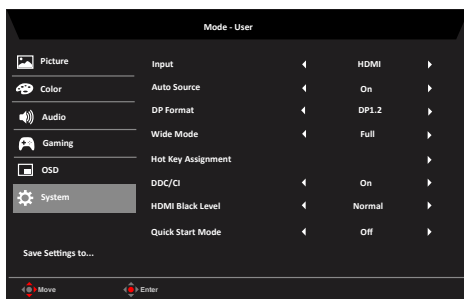
System

- Press the MENU key to open the OSD.
- Toggle the joystick to the up or down to select System from the OSD. Then toggle to the right to navigate to the element you wish to adjust and press the joystick to enter it.
- Toggle to the left or right to adjust the sliding scales.
- Input: Select the source from HDMI 1, HDMI 2 or DP.
- Auto Source: The default is "On", can support auto search for signal source in order.



Note: Surround application must set Auto Source is "Off".

- DP Format: Default is DP1.2, can selection support DP1.1, or DP1.2 format.
- Wide mode: You can select which screen aspect you are using. The options are Full, Aspect .

- Hotkey Assignment: Select the function of shortcut key 1 (Modes, Volume, Brightness, Gamma, Contrast, Blue Light, Over Drive) and shortcut keys 2 (Modes, Volume, Brightness, Gamma, Contrast, Blue Light, Over Drive)
- DDC/CI: Allows the monitor settings to be set through the software on the PC.



Note: DDC/CI, short for Display Data Channel/Command Interface, which allows monitor controls to be sent via software.

- HDMI Black level setting.
- Quick start mode: Select Off or On. Turn on to speed up boot speed.

Save Setting to...(User mode only)

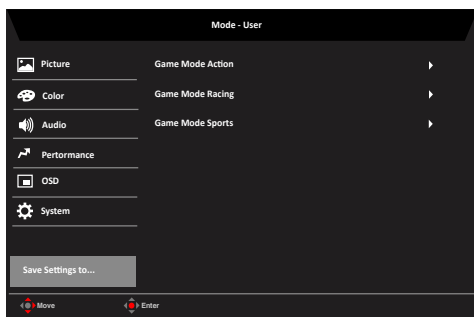

- Press the MENU key to open the OSD.
- Toggle the joystick to the up or down to select "Save Setting to..." from the OSD. Then toggle to the right to navigate to the element you wish to adjust and press the joystick to enter it.
- Save Setting to some mode: There are three user-defined profiles available. When you have decided what settings suit you, save them and system will be able to recall the settings in the future when you turn on these mode.

Troubleshooting

Before sending your LCD monitor for servicing, please check the troubleshooting list below to see if you can self-diagnose the problem.

HDMI /DP Mode (Optional)

Problem	LED status	Remedy
No picture visible	Blue	Using the OSD menu, adjust brightness and contrast to maximum or reset to their default setting.
	Off	Check the power switch. Check if the AC power cord is properly connected to the monitor.
	Amber	Check if the video signal cable is properly connected at the back of monitor. Check if the computer system is switched on and in power saving/standby mode.

Regulatory Compliance

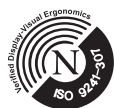

R33037
RoHS

