



## User's Manual - Setup Guide

## Benutzerhandbuch - Installationsanleitung

## Manuel d'utilisation - Guide d'installation

## Руководство пользователя - Руководство по установке

## 用户手册 - 设定指南

## 使用者操作手冊 - 設定指南

# FlexScan® EV2457

## Color LCD Monitor



### Important / Wichtig / Important / Важно! / 重要事項 / 重要事項

Please read PRECAUTIONS, this Setup Guide and the User's Manual carefully to familiarize yourself with safe and effective usage. Please retain this guide for future reference.

Lesen Sie die VORSICHTSMASSNAHMEN, diese Installationsanleitung und das Benutzerhandbuch aufmerksam durch, um sich mit der sicheren und effizienten Bedienung vertraut zu machen. Bewahren Sie diese Anleitung zum späteren Nachschlagen auf.

Veillez lire attentivement les PRECAUTIONS, ce Guide d'installation ainsi que le Manuel d'utilisation, afin de vous familiariser avec ce produit et de l'utiliser efficacement et en toute sécurité. Veuillez conserver ce guide pour référence ultérieure.

Внимательно прочитайте МЕРЫ ПРЕДОСТОРОЖНОСТИ, настоящее Руководство по установке и Руководство пользователя и ознакомьтесь с правилами безопасной и эффективной эксплуатации.

请仔细阅读用户手册、本设定指南和预防措施，掌握如何安全、有效地使用本产品。请保留本指南，以便今后参考。

請仔細閱讀PRECAUTIONS (預防措施)、本設定指南和使用者操作手冊，熟悉如何安全、有效地使用本產品。請保留本指南以供日後參考用。

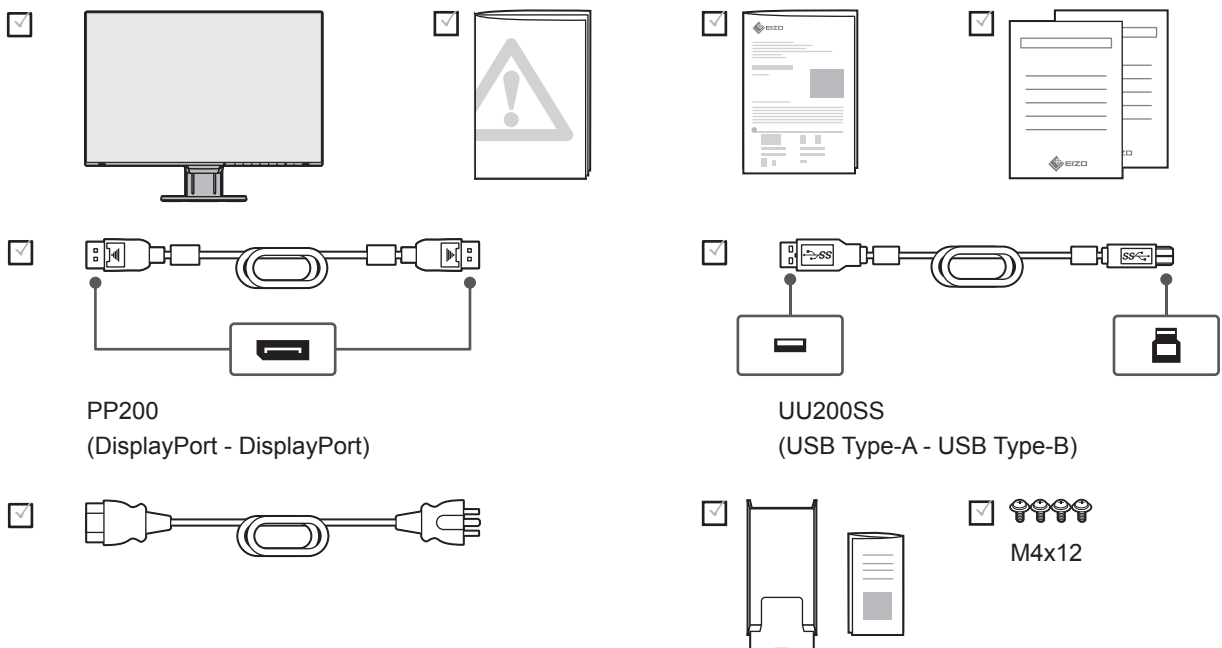

1

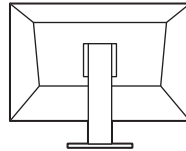

DisplayPort



USB Type-A



2

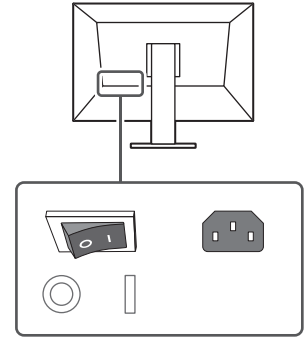

Factory Preset: On  
 Werkseinstellung: Ein  
 Réglage de fabrication: marche  
 Заводские настройки: On  
 恢复出厂设置: 开启  
 原廠預設: 開

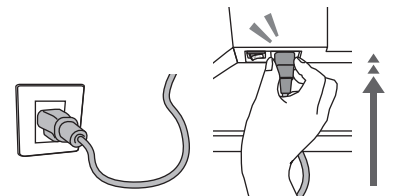

3

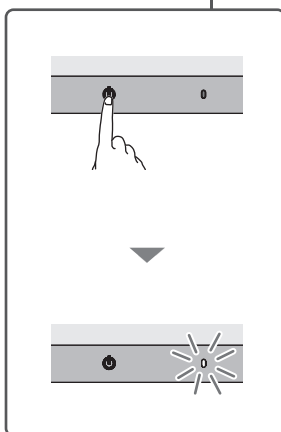
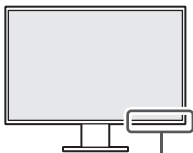

4

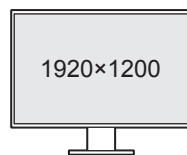

Recommended Resolution  
 Empfohlene Auflösung  
 Résolution conseillée  
 Рекомендуемое разрешение  
 推荐分辨率  
 建議的解析度

5

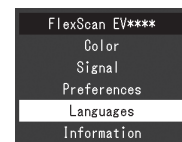
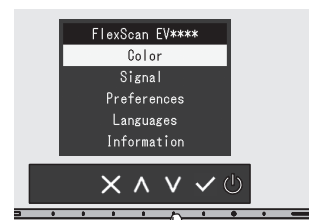

# 6

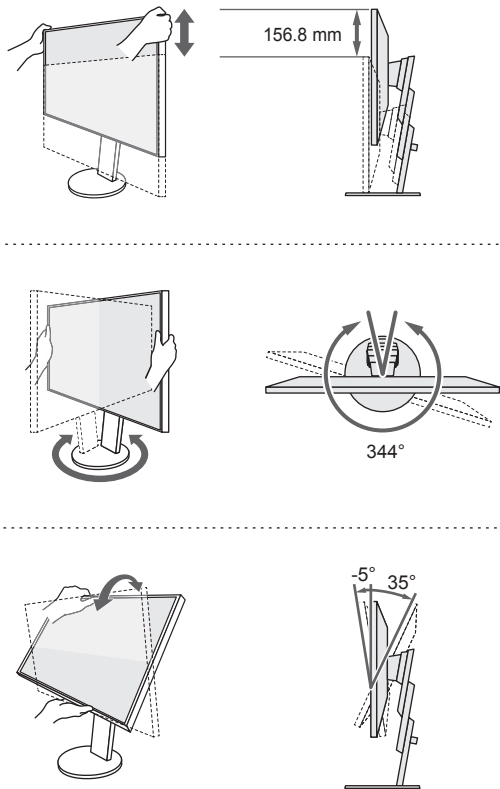

## Note / Hinweis / Remarque / Примечание / 注 / 注

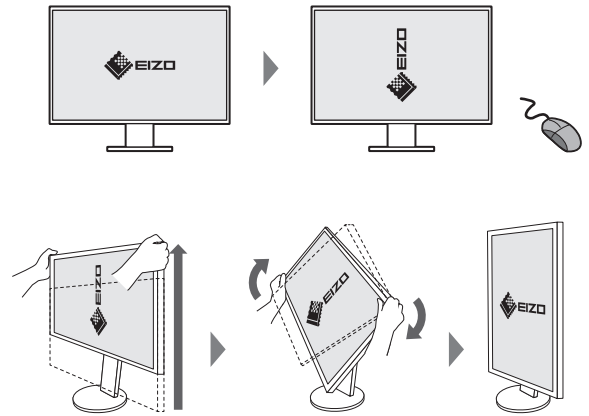

# 7

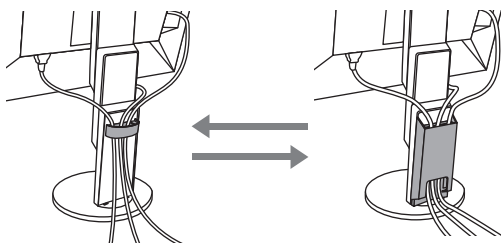
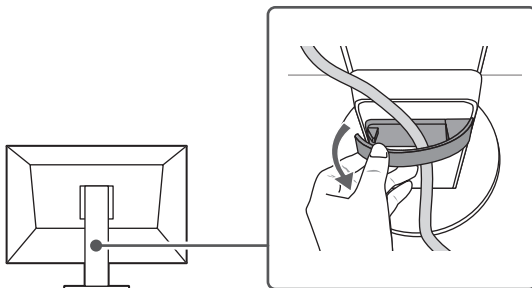

Alternative Option    Альтернативный вариант  
 Alternative Option    选购件  
 Autre option            替代选项

# 8

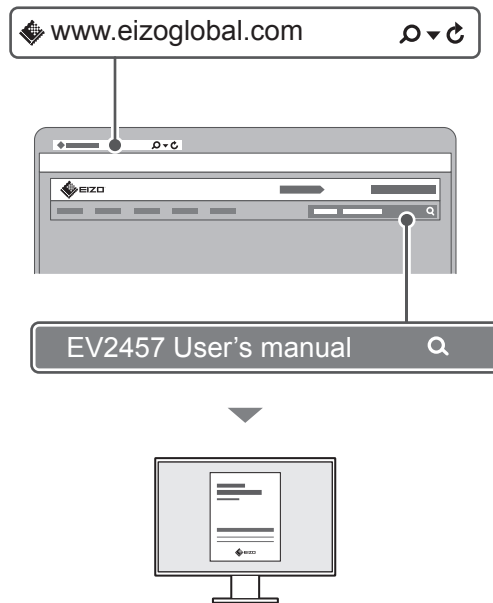



1

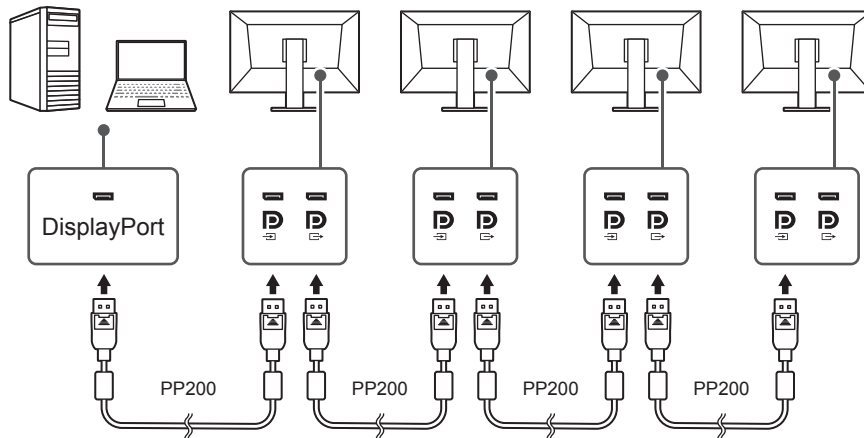

Note / Hinweis / Remarque /  
Примечание / 注 / 注

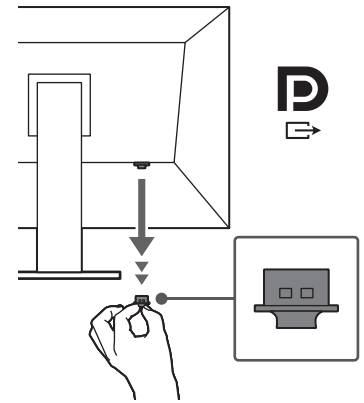

2

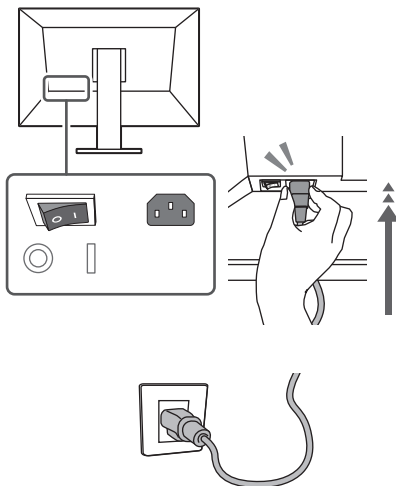

3

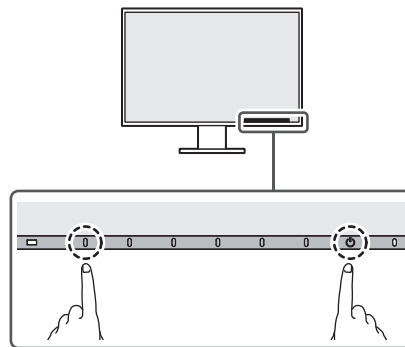

3 sec.                    3 секунды  
3 Sekunden            3秒  
3 secondes            3秒

4

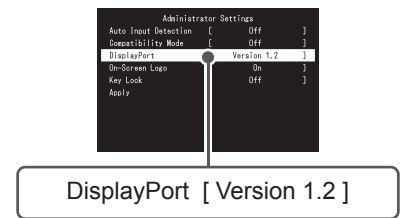

5

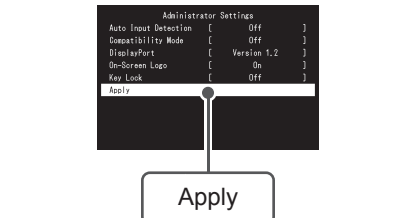

CAUTION / VORSICHT /  
ATTENTION / ВНИМАНИЕ /  
注意 / 注意事項

The lock button is only used to remove the stand from the monitor. In other cases, using the lock button may result in product damage or personal injury due to the monitor becoming detached from the stand.

Die Verriegelungstaste wird nur zum Entfernen des Standfußes vom Monitor verwendet. In anderen Fällen kann die Verwendung der Verriegelungstaste durch ein Lösen des Monitors vom Standfuß zu einer Beschädigung des Produkts oder zu Personenschäden führen.

Le bouton de verrouillage est utilisé uniquement pour retirer le pied du moniteur. Dans d'autres cas, l'utilisation du bouton de verrouillage pourrait entraîner des dommages au produit ou des blessures personnelles parce que le moniteur est détaché du pied.

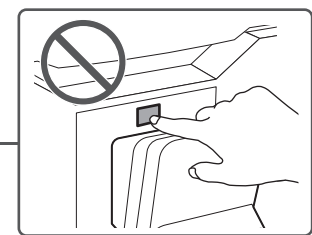
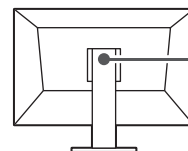

Кнопка блокировки используется только для снятия стойки с монитора. В других случаях использование кнопки блокировки может привести к повреждению изделия или травмированию вследствие отсоединения монитора от стойки.

该锁定按钮仅用于从显示器卸下底座的情况。在其它情况下，由于显示器已从底座卸下，使用该锁定按钮可能造成产品损坏或人身伤害。

本產品配備一個鎖定按鈕，使顯示器固定在支架上。在其他情況下，因顯示器已從支架拆下，使用該鎖定按鈕可能造成產品損壞或人身傷害。

