

Gigabit Ethernet Network Adapters

AT-2916SX
AT-2916LX10/LC-901
AT-2931SX
AT-2972SX
AT-2972LX10/LC-901
AT-2972SX/2
AT-2972T/2

Installation Guide

Copyright © 2011 Allied Telesis, Inc.

All rights reserved. No part of this publication may be reproduced without prior written permission from Allied Telesis, Inc.

Microsoft and Internet Explorer are registered trademarks of Microsoft Corporation. Netscape Navigator is a registered trademark of Netscape Communications Corporation. All other product names, company names, logos or other designations mentioned herein are trademarks or registered trademarks of their respective owners.

Allied Telesis, Inc. reserves the right to make changes in specifications and other information contained in this document without prior written notice. The information provided herein is subject to change without notice. In no event shall Allied Telesis, Inc. be liable for any incidental, special, indirect, or consequential damages whatsoever, including but not limited to lost profits, arising out of or related to this manual or the information contained herein, even if Allied Telesis, Inc. has been advised of, known, or should have known, the possibility of such damages.

Electrical Safety and Emissions Standards

This product meets the following standards.

Federal Communications Commission Interference Statement

Declaration of Conformity

Manufacturer Name: Allied Telesis, Inc.

Declares that the product: **Gigabit Ethernet Adapters**

Model Numbers: **AT-2916SX, AT-2916LX10/LC-901, AT-2931SX, AT-2972SX, AT-2972LX10/LC-901, AT-2972SX/2, AT-2972T/2**

This equipment has been tested and found to comply with the limits for a Class B digital device, pursuant to Part 15 of FCC Rules. These limits are designed to provide reasonable protection against harmful interference in a residential installation. This equipment generates, uses and can radiate radio frequency energy and, if not installed and used in accordance with the instructions, may cause harmful interference to radio or television reception. However, there is no guarantee that interference will not occur in a particular installation. If this equipment does cause harmful interference to radio or television reception, which can be determined by turning the equipment off and on, the user is encouraged to try to correct the interference by one of the following measures:

- Reorient or relocate the receiving antenna.
- Increase the separation between the equipment and the receiver.
- Connect the equipment into an outlet on a circuit different from that to which the receiver is connected.
- Consult the dealer or an experienced radio/TV technician for help.

This device complies with part 15 of the FCC Rules. Operation is subject to the following two conditions:

- (1) This device must not cause harmful interference, and
- (2) this device must accept any interference received, including interference that may cause undesired operation.

FCC Caution: Any changes or modifications not expressly approved by the party responsible for compliance could void the user's authority to operate this equipment.

IMPORTANT NOTE:

FCC Radiation Exposure Statement:

This equipment complies with FCC radiation exposure limits set forth for an uncontrolled environment. End users must follow the specific operating instructions for satisfying RF exposure compliance.

This transmitter must not be co-located or operating in conjunction with any other antenna or transmitter.

IEEE802.11b or 802.11g operation of this product in the U.S.A. is firmware-limited to channels 1 through 11.

Industry Canada

This Class A digital apparatus complies with Canadian ICES-003.

Cet appareil numérique de la classe A est conforme à la norme NMB-003 du Canada.

European Union Restriction of the Use of Certain Hazardous Substances (RoHS) in Electrical and Electronic Equipment

This Allied Telesis RoHS-compliant product conforms to the European Union Restriction of the Use of Certain Hazardous Substances (RoHS) in Electrical and Electronic Equipment. Allied Telesis ensures RoHS conformance by requiring supplier Declarations of Conformity, monitoring incoming materials, and maintaining manufacturing process controls.

RFI Emissions FCC Class B, EN55022 Class B, VCCI Class B, C-TICK, CE

Immunity EN55024

Electrical Safety EN60950 (TUV), UL 60950 (cUL_{US})



Laser Safety EN60825

Translated Safety Statements

Important: The  indicates that a translation of the safety statement is available in a PDF document titled “Translated Safety Statements” on the Allied Telesis website at www.alliedtelesis.com/support/software.

Contents

Safety Symbols Used in this Document	12
Where to Find Web-based Guides	13
Contacting Allied Telesis	14
Online Support	14
Email and Telephone Support	14
Warranty	14
Returning Products	14
Sales or Corporate Information	14
Management Software Updates	14
Chapter 1: Introduction to the AT-29xx Series Gigabit Ethernet Network Adapters	15
Functional Description	16
Contents of Your Shipment	17
LEDs	18
AT-29xx Series Adapter Software Drivers	19
Supported Operating Systems	19
Software Driver Features	19
Failover Teaming	20
Chapter 2: Installing the Hardware	21
Reviewing Safety Precautions	22
Pre-Installation Checklist	24
Installing a Network Adapter Card	25
Connecting the Network Cables	29
Warranty Registration	30
Chapter 3: Installing Windows Server 2003 and Windows XP Driver Software	31
Installing the Driver Software	32
Using the Driver Installer	32
Updating the Adapter Software	35
Modifying Configuration Properties	39
Uninstalling the Driver Software	41
Chapter 4: Installing the Windows 2008 R2, Windows Vista, and Windows 7 Driver Software	43
Installing the Driver Software	44
Selecting the Device Manager	44
Installing the Windows 2008 R2, Windows, Vista, and Windows 7 Driver Software	48
Uninstalling the Driver Software	51
Chapter 5: Setting Advanced Properties	53
Opening Advanced Properties	54
802.1p QOS	55
Ethernet@Wirespeed™ (AT-2972/T2 only)	57
Flow Control	57
Jumbo Mtu	58
Interrupt Moderation	59
IPSec Offload	60
Large Send Offload Property	61
Network Address	62
Priority & VLAN	63
Receive Side Scaling	64
Speed & Duplex Mode	65

Checksum Offload	66
VLAN ID	67
Wake Up Capabilities	68
WOL Speed	69
Chapter 6: Installing the Linux Driver Software	71
Installing the Linux Driver Software	72
Building a Driver from a TAR File	72
Network Installation	74
Removing the Linux Driver from a TAR Installation	75
Module Parameters	76
Chapter 7: Installing the Novell NetWare Driver Software	83
Driver Installation	84
Pre-Installation Requirements	85
Installing Novell NetWare Server 5.x or 6.0 Driver Software	86
Verifying or Modifying Adapter Parameters	88
Removing Drivers from Autoexec.ncf	93
Chapter 8: Installing the NDIS2 Driver Software for MS-DOS Platforms	95
Installing the NDIS2 Driver Software for Use on MS-DOS Platforms	96
Pre-Installation Requirements	96
Modifying the Startup Disk	96
Using Keywords for the B57.dos Drivers	101
Chapter 9: Installing the PXE Boot Agent	103
Overview	104
Setup BIOS	104
Server Setup	105
Windows Server 2003 and Windows XP	105
DOS UNDI/APITEST	105
Red Hat Linux	105
Chapter 10: Troubleshooting	107
Hardware Diagnostics	108
Checking Port LEDs on the Adapter	109
Troubleshooting Checklist	110
Verifying the Correct Drivers are Loaded	111
NetWare	111
Linux	111
Testing Network Connectivity	112
Windows Server 2003	112
NetWare	114
Linux	114
Software Problems and Solutions	115
Microsoft Remote Installation Service (RIS) Instructions	115
Windows Server 2003	115
Miscellaneous	115
Chapter 11: DOS Diagnostics	117
Introduction	118
DOS Prompt Commands	119
Diagnostic Tests	120
Test Names	120
Test Descriptions	121
Error Messages	127
Appendix A: Specifications	131
Physical Specifications	131
Environmental Specifications	131
Power Specifications	132
Performance Specifications	132
Operating Specifications	133

Appendix B: Cleaning Fiber Optic Connectors 135
Using a Cartridge-Type Cleaner136
Using a Swab138

Figures

Figure 1. Removing the PC Cover.....	25
Figure 2. Removing the Faceplate From PCI Slot.....	26
Figure 3. Inserting the Network Adapter Card.....	27
Figure 4. Securing the Adapter Card.....	28
Figure 5. Welcome to the Found New Hardware Wizard Window.....	33
Figure 6. Found New Hardware Wizard Window: Search and Installation Options.....	34
Figure 7. Windows Server 2003 Start Window.....	36
Figure 8. Run Window.....	36
Figure 9. Device Manager Window (Network adapter folder is collapsed).....	37
Figure 10. Welcome to Hardware Update Wizard Window.....	38
Figure 11. Hardware Update Wizard Window.....	38
Figure 12. System Properties Dialog Box.....	40
Figure 13. Windows 2008 R2 and Windows 7 Search Box.....	45
Figure 14. Windows Vista Start Menu.....	46
Figure 15. Windows Vista Run Window.....	46
Figure 16. Device Manager Window.....	47
Figure 17. Device Manager Window: Ethernet Controller.....	48
Figure 18. Update Driver Software - Ethernet Controller Window.....	49
Figure 19. Update Driver Software: Ethernet Controller: Browse.....	50
Figure 20. Update Driver Software - Confirmation Window.....	50
Figure 21. Advanced Tab.....	56
Figure 22. Run Command Window.....	112
Figure 23. Command Window with pconfig/all displayed.....	113
Figure 24. Command Window with ping displayed.....	113
Figure 25. Ferrule in an SC Connector Plug.....	135
Figure 26. Unclean and Clean Ferrule.....	135
Figure 27. Cartridge Cleaner.....	136
Figure 28. Rubbing the Ferrule Tip on the Cleaning Surface.....	136
Figure 29. Lint-Free and Alcohol-Free Swabs.....	138
Figure 30. Cleaning a Recessed Ferrule.....	138

Preface

This guide contains instructions on how to install the AT-29xx Series Gigabit Ethernet Network adapters. In addition, procedures are provided that describe how to install and configure the driver software.



The Preface contains the following sections:

- “Safety Symbols Used in this Document” on page 12
- “Where to Find Web-based Guides” on page 13
- “Contacting Allied Telesis” on page 14

Safety Symbols Used in this Document

This document uses the safety symbols defined in Table 1.

Table 1. Safety Symbols

Symbol	Meaning	Description
	Caution	Performing or omitting a specific action may result in equipment damage or loss of data.
	Warning	Performing or omitting a specific action may result in electrical shock.

Where to Find Web-based Guides

The installation and user guides for all Allied Telesis products are available in portable document format (PDF) on our web site at **www.alliedtelesis.com/support/software**. You can view the documents online or download them onto a local workstation or server.

Contacting Allied Telesis

This section provides Allied Telesis contact information for technical support as well as sales and corporate information.

Online Support

You can request technical support online by accessing the Allied Telesis Knowledge Base: www.alliedtelesis.com/support/kb.aspx. You can use the Knowledge Base to submit questions to our technical support staff and review answers to previously asked questions.

Email and Telephone Support

For Technical Support via email or telephone, refer to the Support & Services section of the Allied Telesis web site: www.alliedtelesis.com. Select your country from the list displayed on the website. then select the appropriate menu tab.

Warranty

For hardware warranty information, refer to the Allied Telesis web site: www.alliedtelesis.com/support/warranty.

Returning Products

Products for return or repair must first be assigned a return materials authorization (RMA) number. A product sent to Allied Telesis without an RMA number will be returned to the sender at the sender's expense.

To obtain an RMA number, contact the Allied Telesis Technical Support group at our web site: www.alliedtelesis.com/support/rma. Select your country from the list displayed on the website. Then select the appropriate menu tab.

Sales or Corporate Information

You can contact Allied Telesis for sales or corporate information through our web site: www.alliedtelesis.com. To find the contact information for your country, select Contact Us -> Worldwide Contacts.

Management Software Updates

New releases of management software for our managed products are available from either of the following Internet sites:

- Allied Telesis web site: www.alliedtelesis.com/support/software
- Allied Telesis FTP server: <ftp://ftp.alliedtelesis.com>

If you prefer to download new software from the Allied Telesis FTP server from your workstation's command prompt, you will need FTP client software and you must log in to the server. Enter "anonymous" for the user name and your email address for the password.

Chapter 1

Introduction to the AT-29xx Series Gigabit Ethernet Network Adapters

This chapter provides an introduction to the Allied Telesis AT-29xx Series Gigabit Ethernet Network adapters and contains the following sections:

- “Functional Description” on page 16
- “LEDs” on page 18
- “AT-29xx Series Adapter Software Drivers” on page 19
- “Failover Teaming” on page 20

Functional Description

The AT-29xx Series Gigabit Ethernet Network adapters target the increased congestion experienced at the backbone and server in today's networks. These adapters provide a future upgrade path for high-end workstations that require more bandwidth than Fast Ethernet can provide.

The adapter connects a PCI compliant server or workstation to a Gigabit Ethernet network. The adapter incorporates a technology that transfers data at a maximum rate of 2Gbps—20 times the rate of Fast Ethernet adapters. In addition, the adapters use fiber optic cabling and a connector that meets 62.5/125um or 50/125um multimode specifications. These adapters operate at 1000 Mbps full-duplex mode only.

The AT-29xxSX Series of Gigabit Ethernet adapters includes the following models:

- ❑ AT-2916SX
- ❑ AT-2931SX
- ❑ AT-2972SX
- ❑ AT-2972SX/2

The AT-2916 adapter is a 33/66Mhz 32-bit interface (PCI) card and is available in three versions:

- ❑ AT-2916SX/SC adapter
- ❑ AT-2916SX/LC adapter
- ❑ AT-2916LX10/LC-901 adapter (suitable for long-haul fiber optic cables)

The AT-2931SX adapter is a 33/66/133Mhz 32/64-bit interface (PCI-X) card and is available in two versions:

- ❑ AT-2931SX/SC adapter
- ❑ AT-2931SX/LC adapter

The AT-2972SX/2, and AT-2972T/2 adapters are both PCI Express 4-channel devices. The AT-2972SX is a PCI Express 1-channel device.

The AT-2972LX10/LC-901 adapter is suitable for long-haul fiber optic cables. The AT-2972SX has one port and the AT-2972SX/2 has two ports. All ports have LC connectors. The AT-2972T/2 has two gigabit copper ports.

The adapter versions differ only in their PCI connector type. The SC version adapters have an SC connector, and the LC version adapters have an LC connector. The LEDs and software drivers are identical for all adapter models and versions.

Contents of Your Shipment

Included with your adapter are the following items:

- Antistatic bag (used for protecting the adapter when stored or shipped). Keep the adapter in its packaging until ready for installation.
- Low-profile bracket

Inform your network supplier of any missing or damaged items. If you need to return the adapter, you must pack it in the original (or equivalent) packing material or the warranty will be voided. See “Returning Products” on page 14.

LEDs

All fiber adapter models have two LEDs: LINK and ACT. The LINK LED indicates an active link and the ACT (Activity) LED indicates data transfer status. After the driver is loaded and the cables are connected properly. The LINK LED is lit and the ACT LED is on if data traffic is present. See Table 1.

Table 1. Fiber Optic Port LED Status

LED	State	Description
LINK	On	Valid fiber link.
	Off	No fiber link.
ACT	Blinking	Data traffic is present between the adapter and the switch.
	Off	Data traffic is not present.

The AT-2972T/2 has one copper port with a single LED. For a description, see Table 2.

Table 2. AT-2972T/2 LED

State	Description
On	Valid link.
Off	No valid link.
Blinking	Data traffic is present between the adapter and the switch.

AT-29xx Series Adapter Software Drivers

An AT-29xx Series adapter is shipped from the factory with the default Broadcom software driver installed. To update the software driver, you have two options:

- ❑ If your system has an Internet connection, you can download the AT-29xx software driver from the Microsoft's Update Manager. This utility is accessed through the Start button. However, the Microsoft Update Manager may not have the latest Allied Telesis software drivers.
- ❑ You can download the latest version of the software driver from the Allied Telesis website at www.alliedtelesis.com/support/software.

This manual provides instructions to download the software driver from the Allied Telesis website and install it on your adapter.

Supported Operating Systems

The AT-29xx Series Adapters support software drivers on the following operating systems:

- ❑ Windows Server 2003
- ❑ Windows XP
- ❑ Windows 2008 R2
- ❑ Windows Vista
- ❑ Windows 7
- ❑ Linux
- ❑ Novell NetWare
- ❑ MS-DOS

Software Driver Features

The following is a list of the AT-29xx Series Gigabit Ethernet Network adapters features for all of the supported operating systems:

- ❑ Flow Control (IEEE 802.3X)
- ❑ Jumbo frames (9 KB)
- ❑ Layer 2 Priority Encoding (802.1P)
- ❑ Adaptive interrupt frequency
- ❑ Integrated 96 KB Frame Buffer Memory
- ❑ Support for PXE
- ❑ Load balancing

Note

Novell NetWare 5.1 does not support Jumbo Frames.

Failover Teaming

Failover Teaming provides redundant adapter operation in the event that a network connection fails. When multiple Allied Telesis Gigabit Ethernet adapters are installed in the same server, they can be paired into Teams. Each team must have at least one adapter, but can support up to eight adapters. The number of teams is limited by the number of adapters that are installed.

If the primary adapter in a team is disconnected because of failure of the adapter, cable, or switch port, the secondary team member becomes active, redirecting both inbound and outbound traffic originally assigned to the primary adapter. Sessions are maintained, causing no impact to the user.

The AT-29xx Series adapters have advanced server features for teaming and failover. For more information, see the *Broadcom Advanced Control Suite 3 User's Guide* which you can download from the Allied Telesis website at www.alliedtelesis.com/support/software.

Note

Allied Telesis recommends disabling STP when using the teaming and fault tolerance features.

Note

Failover Teaming is available with the Broadcom Advanced Control Suite 3 (BACS 3) utility.

Chapter 2

Installing the Hardware

The AT-29xx Series adapters can be installed in a server or a workstation. This chapter describes how to install the adapters.

This chapter contains the following sections:

- ❑ “Reviewing Safety Precautions” on page 22
- ❑ “Pre-Installation Checklist” on page 24
- ❑ “Installing a Network Adapter Card” on page 25
- ❑ “Connecting the Network Cables” on page 29
- ❑ “Warranty Registration” on page 30

Reviewing Safety Precautions

Please review the following safety precautions before you begin to install the network adapter card.

Note

The  indicates that a translation of the safety statement is available in a PDF document titled “Translated Safety Statements” on the Allied Telesis website at www.alliedtelesis.com/support/software.



Warning

This is a “Class 1 LED product”.  L1



Warning

Do not stare into the laser beam.  L2



Warning

Warning: Do not look directly at the fiber optic cable ends or inspect the cable ends with an optical lens.  E29



Warning

Do not work on this equipment or cables during periods of lightning activity.  E2



Warning

Operating Temperature: This product is designed for a maximum ambient temperature of 40 degrees C.  E7

Note

All Countries: Install this product in accordance with local and National Electric Codes.  E8



Warning

The adapter is being installed in a system that operates with voltages that can be lethal. Before you remove the cover of your system, you must observe the following precautions to protect yourself and to prevent damage to the system components.

- Remove any metallic objects or jewelry from your hands and wrists.
 - Use only insulated or nonconducting tools.
 - Verify that the system is powered OFF and unplugged before accessing internal components.
 - Installation or removal of adapters must be performed in a static-free environment. The use of a properly grounded wrist strap or other personal antistatic devices and an antistatic mat is strongly recommended.  E39
-

Pre-Installation Checklist

1. Check that your system has an appropriate open PCI slot.
2. Verify that your system is using the latest BIOS.
3. If your system is active, shut it down.
4. When system shut down is complete, power OFF and unplug your system.
5. Holding the adapter card by the edges, remove it from its shipping package and place it on an antistatic surface.
6. Check the adapter for visible signs of damage, particularly on the card's edge connector.

Never attempt to install any damaged adapter. If the adapter is damaged, report it to Allied Telesis. See "Contacting Allied Telesis" on page 14.

Installing a Network Adapter Card

The following instructions apply to installing an AT-29xx Series Gigabit Ethernet Network adapter in most systems. Refer to the manuals that were supplied with your system for details about performing these tasks on your particular system.

To install the network adapter card, perform the following procedure:

1. Review the “Pre-Installation Checklist” on page 24 and “Reviewing Safety Precautions” on page 22.

Before installing the adapter, ensure the system power is OFF and unplugged from the power outlet, and that proper electrical grounding procedures have been followed.



Warning

High voltage inside the system presents a safety hazard. Make sure the power is off before removing the cover.

2. Remove the system cover and select any appropriate empty PCI slot. See Figure 1.

If you do not know how to identify an appropriate PCI slot, refer to your system documentation.

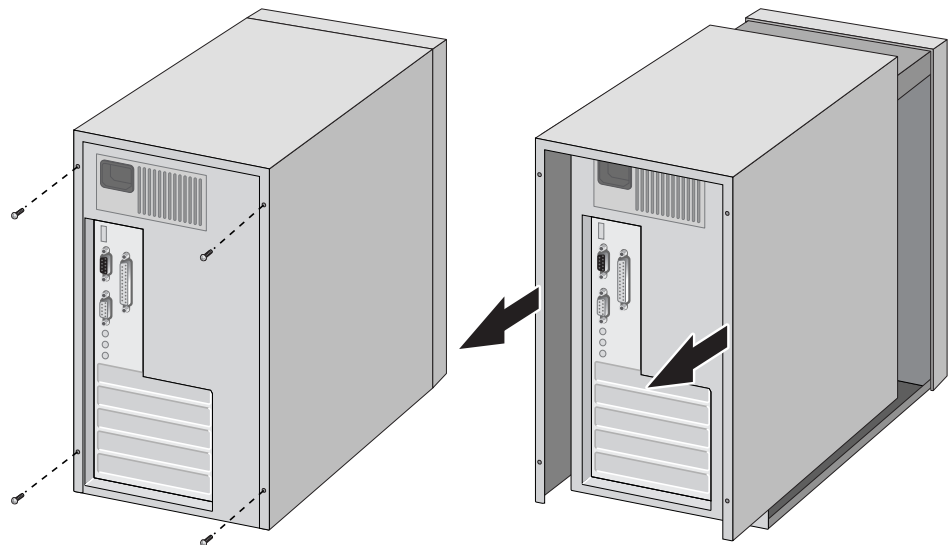

Figure 1. Removing the PC Cover

3. Select an empty, non-shared PCI slot and remove the faceplate.

Keep the faceplate in a safe place. You may need it for future use. See Figure 2.

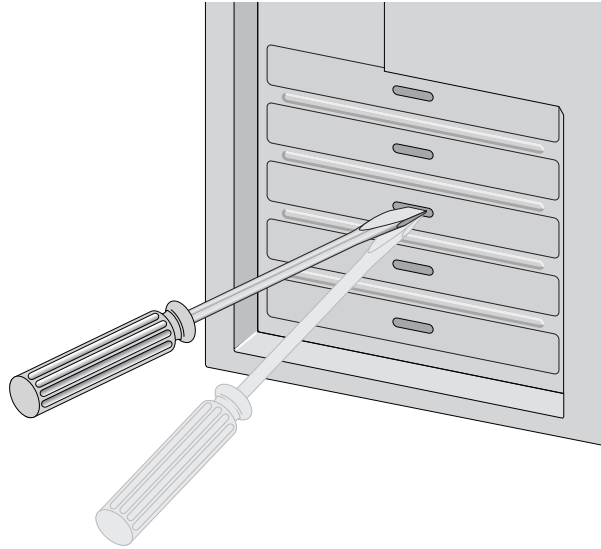

Figure 2. Removing the Faceplate From PCI Slot

Note

If you cannot locate or know how to find an appropriate PCI slot, refer to the documentation that came with your system.

4. Remove the network adapter card from the shipping package and store the packaging material in a safe location.



Caution

Wear a grounding device and observe electrostatic discharge precautions when installing the network adapter card in a system. Failure to observe this caution could result in damage to the card.

5. Applying even pressure at both corners of the card, push the adapter card until it is firmly seated in the appropriate PCI slot.

Make sure the card is securely seated. See Figure 3.

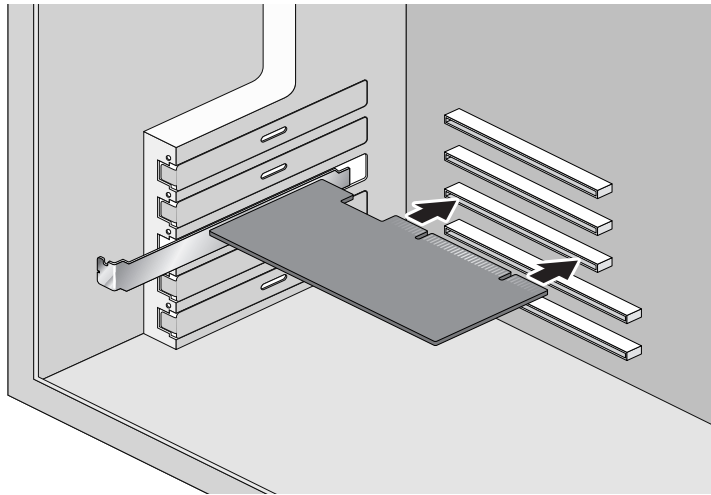

Figure 3. Inserting the Network Adapter Card

Note

The connector dock in a 32-bit PCI slot is shorter than in a 64-bit PCI slot. Although the AT-2931SX adapter is designed to fit in either slot type, when installed in a 32-bit PCI slot, part of the adapter's connector edge remains undocked. This is part of normal operation.

Note

When you install an AT-2931SX adapter in a 32-bit slot, the adapter operates in 32-bit mode only.



Caution

Do not use excessive force when seating the card, because this may damage the system or the adapter. If the card resists seating, remove it from the system, realign it, and try again.

6. Secure the network adapter card to the chassis with a Phillips-head screw (not provided) as shown in Figure 4.

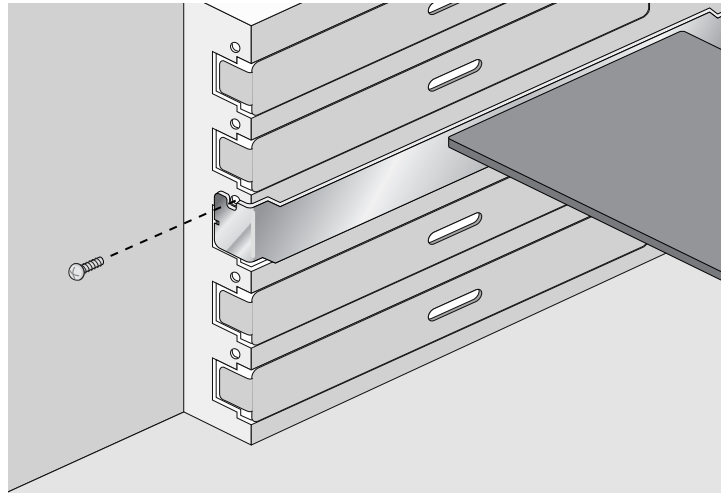

Figure 4. Securing the Adapter Card

7. Replace the system's cover and secure it with the screws removed in Step 2.
8. Disconnect any personal antistatic devices.
9. Power the system on.

Note

If you installed the adapter card in a Microsoft Windows Operating system before installing the driver software, the Found New Hardware Wizard launches automatically. For more information, refer to the chapter for your Windows Operating system.

Once the system returns to proper operation, the adapter hardware is fully installed. Next, connect the network cables. See "Connecting the Network Cables" on page 29.

Connecting the Network Cables

All the fiber Gigabit Ethernet network adapters have two fiber optic connectors for attaching the system to a compatible link partner, or an IEEE 802.3z compliant gigabit switch. After connecting the system to the network and power is supplied, the adapter performs auto-negotiation and attempts to establish the connection at 1000 Mbps full-duplex only.

To connect a network cable to the adapter, perform the following procedure:

1. Prepare a fiber optic cable according to the specifications in Table 3.

Table 3. 1000BASE-SX Fiber Optic Cable Specifications

Port Type	Connector	Media	Maximum Distance
1000BASE-SX	Fiber Optic	50 μ m multimode 850 nm	550 meters (1,804 feet)
1000BASE-SX	Fiber Optic	62.5 μ m multimode 850 nm	275 meters (853 feet)
1000BASE-LX	Fiber Optic	9.125 μ m single mode 1310 nm	10 kilometer (6.213 miles)



Warning

The fiber optic ports contain a Class 1 laser device. When the ports are disconnected, always cover them with the provided plug. Exposed ports may cause skin or eye damage.

2. Connect one end of the cable to the adapter.
3. Connect the other end of the cable to the appropriate Ethernet network port or fiber optic port.

Note

After the cable is properly connected at both ends, the adapter port LEDs should be functional. See Table 1 on page 18 for a description of adapter port LED operation. For driver installation and configuration instructions, refer to the software configuration for a specific driver.

The AT-2972T/2 has two copper connectors for attaching the system to a compatible link partner. After you connect to the network and power is supplied, the adapter performs auto-negotiation and attempts to establish the connection at the appropriate speed and duplex mode.

Warranty Registration

Allied Telesis hardware products are covered under limited warranties. Some products have a longer coverage than others.

All Allied Telesis warranties are subject to and provided only on the terms and conditions set out in the Allied Telesis Limited Warranties listed on the Allied Telesis website at <http://alliedtelesis.com/support/warranty>.

Chapter 3

Installing Windows Server 2003 and Windows XP Driver Software

This chapter describes how to install the Windows Server 2003 and Windows XP driver software. This chapter contains the following sections:

- “Installing the Driver Software” on page 32
- “Uninstalling the Driver Software” on page 41

After you install the driver software, you can modify the configuration properties as described in see Chapter 5, “Setting Advanced Properties” on page 53.

Installing the Driver Software

When a Windows Server 2003 or Windows XP system first boots up after installing a new Allied Telesis Gigabit Ethernet adapter, the system automatically detects the new hardware and prompts you to install the driver software for that device.

There are three installation procedures:

- ❑ “Using the Driver Installer” on page 32
- ❑ “Updating the Adapter Software” on page 35
- ❑ “Modifying Configuration Properties” on page 39

Note

The adapter must be physically installed in your system before installing the driver software. See Chapter 2, “Installing the Hardware” on page 21 for details.

Note

If the Windows Server 2003 or Windows XP system detects an adapter and installs a default driver, update the driver as described in “Updating the Adapter Software” on page 35.

Note

If there is an onboard Broadcom network interface, the native Broadcom driver may load. You can use this driver, or the latest driver supplied by Allied Telesis.

Using the Driver Installer

When you boot up either operating system after installing the adapter card, a series of *Found New Hardware* windows are displayed. You must have Administrator privileges to install the driver software.

Note

Before beginning this procedure, verify that the Windows Server 2003 or Windows XP system has been upgraded to the latest version with the latest service pack applied.

Note

If you have a Windows XP system, the window in Figure 5 on page 33 opens. Start with step 1. If you have a Windows Server 2003 system, the window in Figure 6 on page 34 opens. Start with step 3 on the same page.

To install the adapter software on a Windows Server 2003 or Windows XP system, do the following:

1. Click **Install from a list or specific location (Advanced)**.

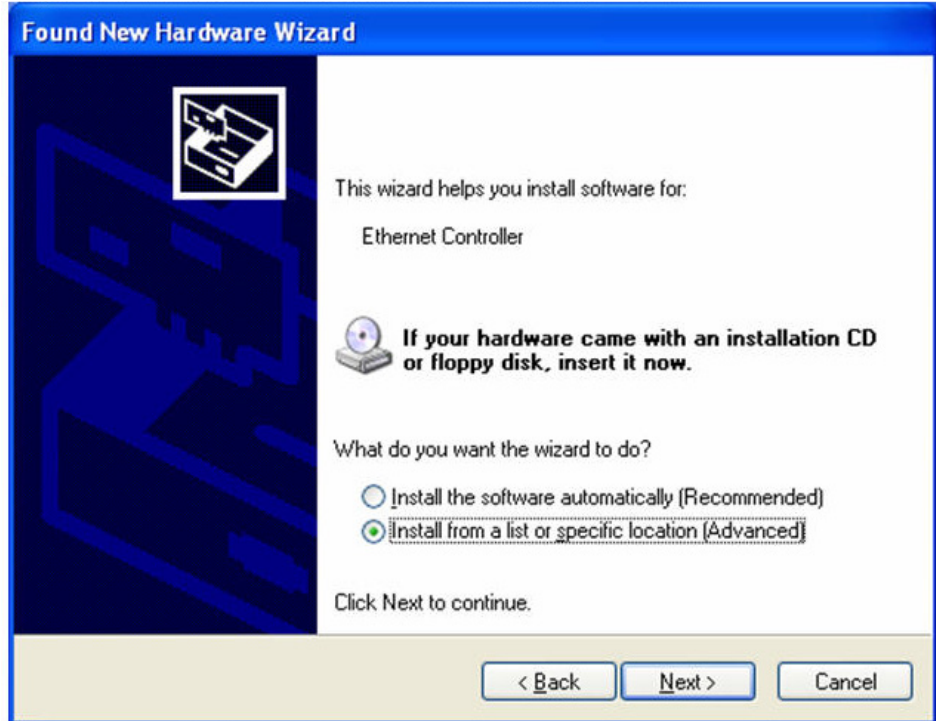

Figure 5. Welcome to the Found New Hardware Wizard Window

2. Click **Next**.

The second Welcome to the Found New Hardware Wizard Window is shown in Figure 6 on page 34.

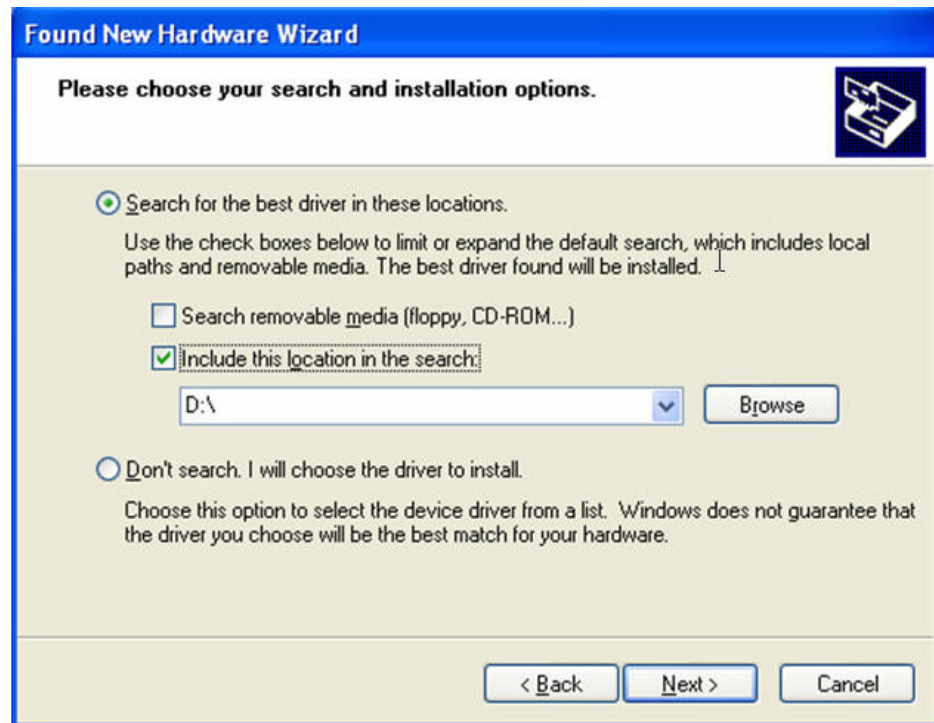

Figure 6. Found New Hardware Wizard Window: Search and Installation Options

3. Click **Include this location in the search.**
4. Click **Browse** and locate the path of the software driver.
5. Click **Next.**
6. When the software installation is complete, click **Finish** to close the wizard and complete the software installation.

Updating the Adapter Software

This section provides a procedure for updating the adapter software for the Windows Server 2003 or Windows XP systems. To obtain the latest version of an AT-29xx Series adapter software drivers, download it from the Allied Telesis website at www.alliedtelesis.com/support/software.

Note

You may need to reboot your system after completing the driver update to properly load the new drivers.

When you update the adapter software on existing devices, the Advanced Property settings may not be updated unless you remove the existing device by following the instructions in “Uninstalling the Driver Software” on page 41. Then perform a scan for hardware changes in the device manager followed by reinstalling the device with the current adapter software as described in “Installing the Driver Software” on page 32.

Note

Before uninstalling a device, capture all of the Advanced Property settings because the properties will be lost.

Updating the Windows Server 2003 or Windows XP Driver Software

To update the adapter software on a Windows Server 2003 or a Windows XP system, perform the following procedure.

Note

Update all adapters by repeating the following steps on each device.

1. Start either a Windows Server 2003 or a Windows XP system and log in.

You must have Administrator privileges to update the driver software.

2. On the desktop, open the **Start** menu.

See Figure 7 on page 36 for an example of the Start menu.

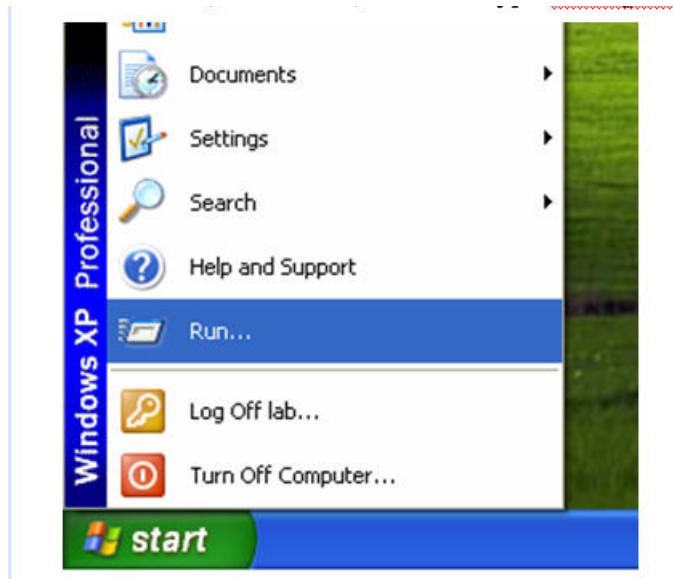

Figure 7. Windows Server 2003 Start Window

3. Select **Run** from the menu and enter the following command:

`devmgmt.msc`

See Figure 8 for an example of the Run Window.

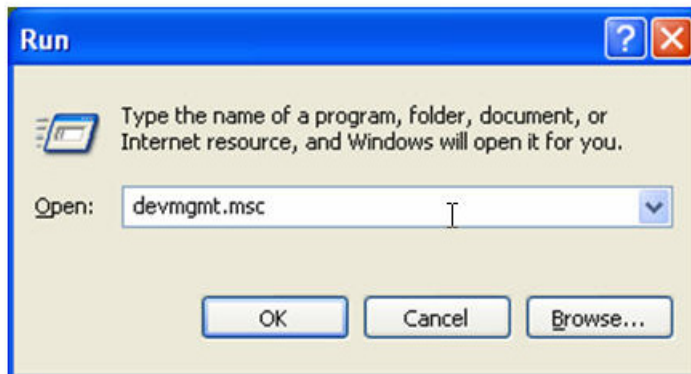

Figure 8. Run Window

The Device Manager Window is shown in Figure 9.

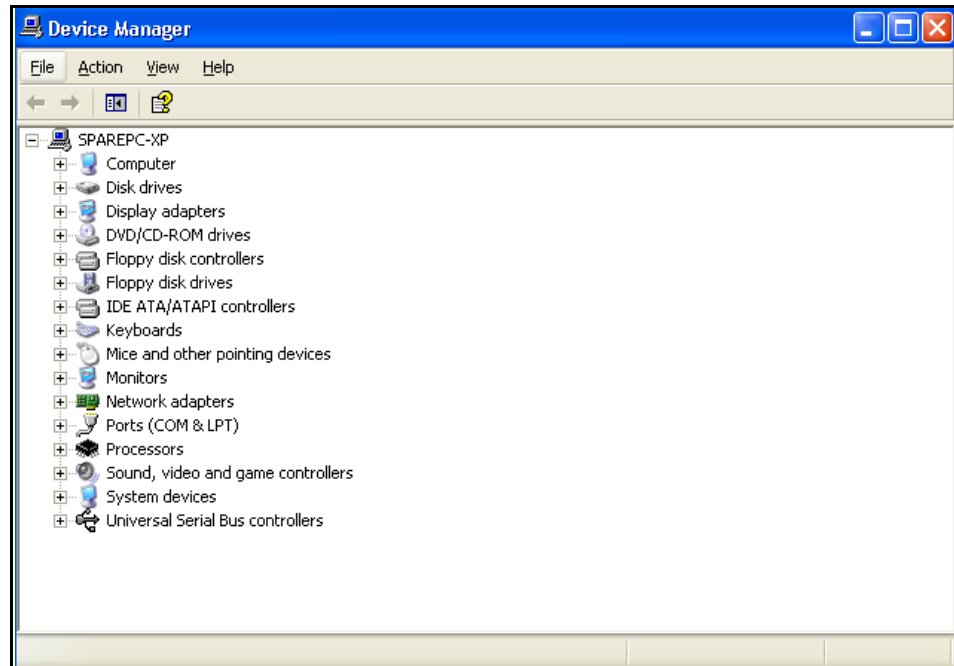

Figure 9. Device Manager Window (Network adapter folder is collapsed)

4. In the Device Manager window, click the + next to the Network adapters folder.

The selection expands to show the list of installed network adapter cards.

5. Right click on the adapter whose driver you want to update and select **Update Driver**.

The Hardware Update Wizard Window opens, as shown in Figure 10.



Figure 10. Welcome to Hardware Update Wizard Window

6. For a Windows Server 2003 system, skip to step 10. For a Windows XP system, click **No, not this time** to copy the driver software from your PC.
7. Click **Next**.

The Second New Found Hardware Wizard Window opens, as shown in Figure 11.

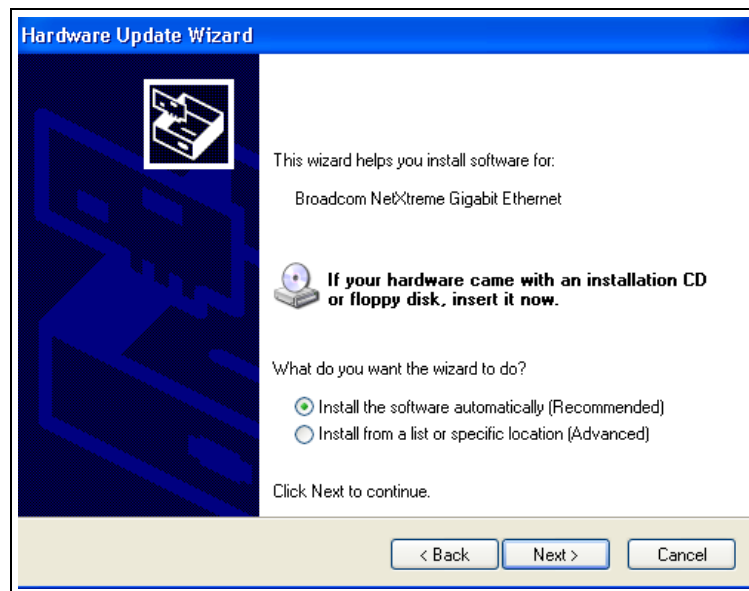

Figure 11. Hardware Update Wizard Window

8. Click **Install from a list or specified location (Advanced)**.
9. Click **Next**.
10. If you are prompted to specify the location of the software driver, click **Browse** (do not use the text field) and locate the path.

After you install the driver software, you can modify the configuration properties. See Chapter 5, "Setting Advanced Properties" on page 53.

Modifying Configuration Properties

Although the default values are appropriate in most cases, you can change any of the available options to meet the requirements of your specific system. After the adapter driver software has been installed, you can use this procedure to access the System Property Dialog box which provides access to the Advanced Properties on the Advanced Tab.

To access the System Properties Dialog box, perform the following procedure:

1. Start either a Windows Server 2003 or a Windows XP system and log in.

You must have Administrator privileges to update the driver software.

2. On the desktop, right click **My Computer**.

The My Computer window opens.

3. Select **Properties** from the menu.

The System Properties Dialog box opens, as shown in Figure 12 on page 40.

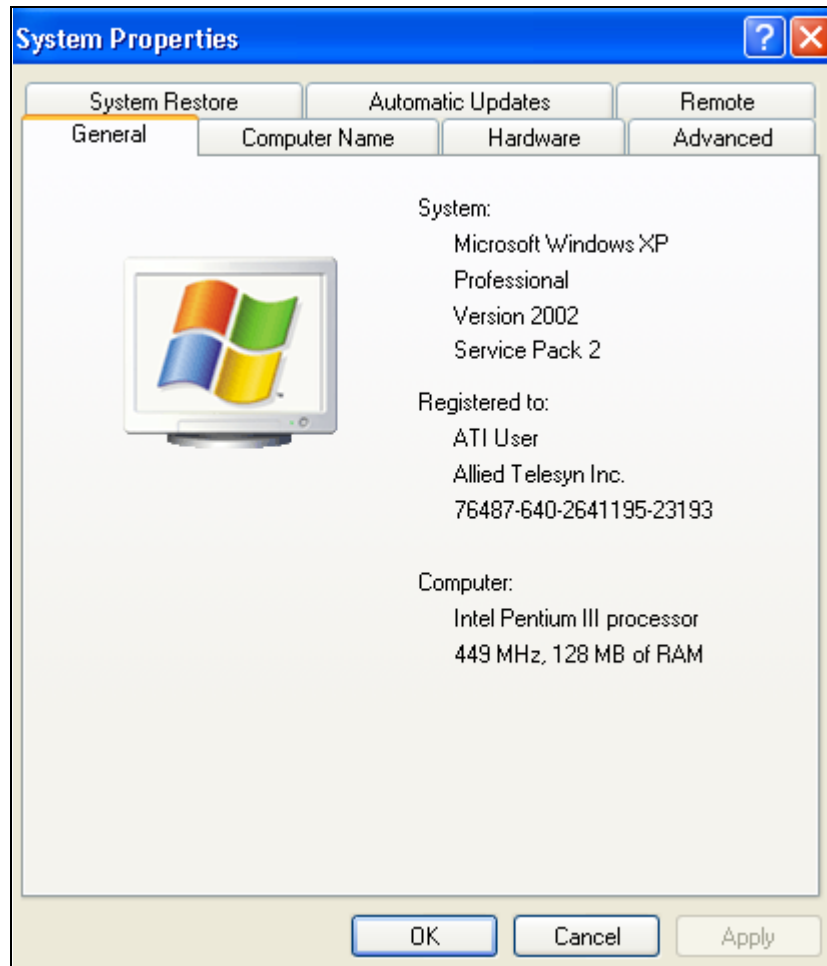

Figure 12. System Properties Dialog Box

For instructions that describe how to set the Advanced Properties, see Chapter 5, "Setting Advanced Properties" on page 53.

Uninstalling the Driver Software

Before physically removing an adapter from your system, you must uninstall the adapter driver software.



Caution

Before uninstalling the Allied Telesis device, be sure to capture all Advanced Property settings because the properties are lost during the uninstall process.

To uninstall the adapter software from your system, perform the following procedure:

1. Start Windows Server 2003 or Windows XP and log in.

Note

You must have Administrator privileges to remove the driver software.

2. Choose from the following:
 - If you have a Windows Server 2003 Server system, click **Start**. Then select the **Control Panel** from the menu. Double-click the **System** icon.
 - If you have a Windows XP system, right click on **My Computer**. Then select **Properties** from the menu.

The Device Manager Window opens. It is shown in Figure 9 on page 37.

3. In the Device Manager window, click the **+** next to the Network adapters folder.

The selection expands to show the list of installed network adapter cards.

4. Right-click on the adapter to be removed and select **Uninstall**.

A Confirm Device Removal window opens.

5. Click **OK** to complete the uninstall.

Note

Not all driver files are removed as part of this procedure.

Chapter 4

Installing the Windows 2008 R2, Windows Vista, and Windows 7 Driver Software

This chapter describes how to install the Windows 2008 R2, Windows Vista, and Windows 7 driver software on an AT-29xx Series adapter. The installation procedures are identical for both the 32-bit and 64-bit Windows Operating Systems.

This chapter contains the following sections:

- “Installing the Driver Software” on page 44
- “Uninstalling the Driver Software” on page 51

Note

To set Advanced Properties, see Chapter 5, “Setting Advanced Properties” on page 53.

Installing the Driver Software

After you install an AT-29xx Series adapter, the system detects the new hardware and creates an entry in the Device Manager when the Windows operating system first boots up. Shortly after you log in, you need to install the driver software for the AT-29xx Series adapter. To install or update the driver software, you must have administrative privileges.

This section provides the following procedures:

- ❑ “Selecting the Device Manager” on page 44
- ❑ “Installing the Windows 2008 R2, Windows, Vista, and Windows 7 Driver Software” on page 48

Selecting the Device Manager

You must access the Device Manager during the both the install and uninstall procedures. Each operating system has its own method of selecting the Device Manager. See the following procedures:

- ❑ “Selecting the Device Manager in Windows 2008 R2 and Windows 7” on page 44
- ❑ “Selecting the Device Manager in Windows Vista” on page 46

Selecting the Device Manager in Windows 2008 R2 and Windows 7

To select the Device Manager in Windows 2008 R2 or Windows 7, do the following:

1. Select the Start button. See Figure 13 on page 45.

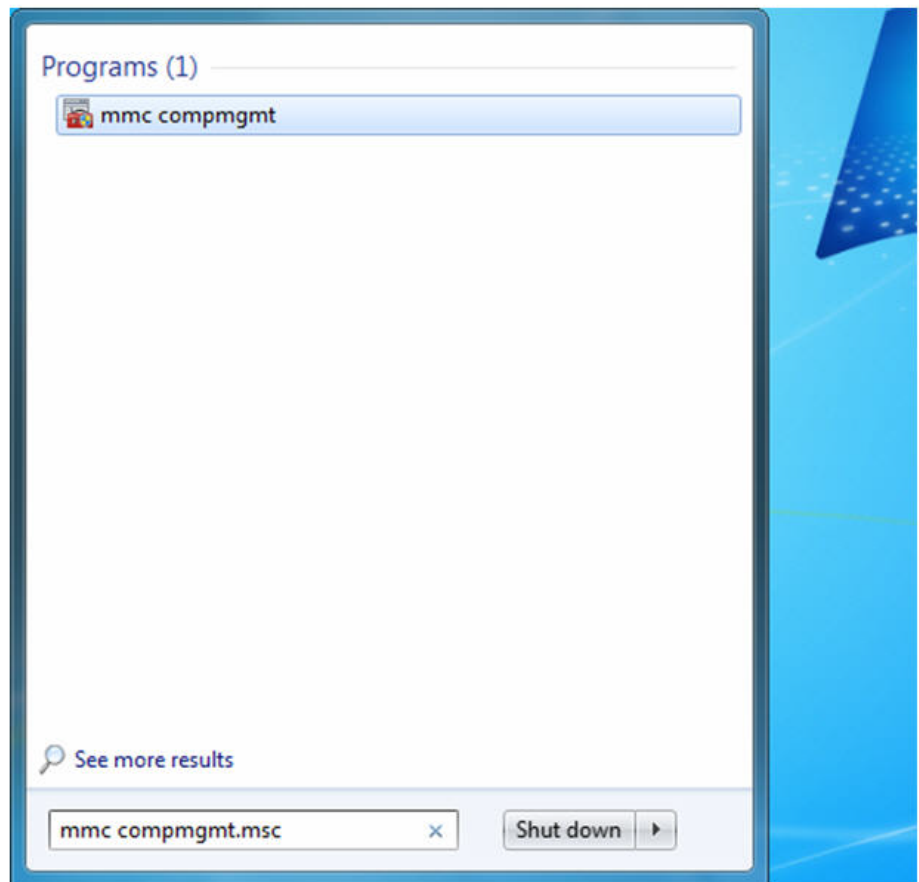

Figure 13. Windows 2008 R2 and Windows 7 Search Box

2. Enter the following command:

```
mmc compmgmt.msc
```

The Device Manager window is displayed. For an example of the Device Manager window, see Figure 9 on page 37.

Selecting the Device Manager in Windows Vista

To select the Device Manager in the Windows Vista Operating System, do the following:

1. Select the Start menu.

See Figure 14 for an example of the Windows Vista Start menu.

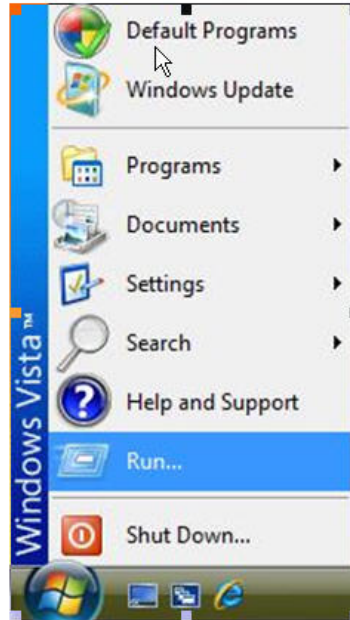

Figure 14. Windows Vista Start Menu

2. From the Start Menu, select **Run**.

The Windows Vista Run window is displayed. See Figure 15.

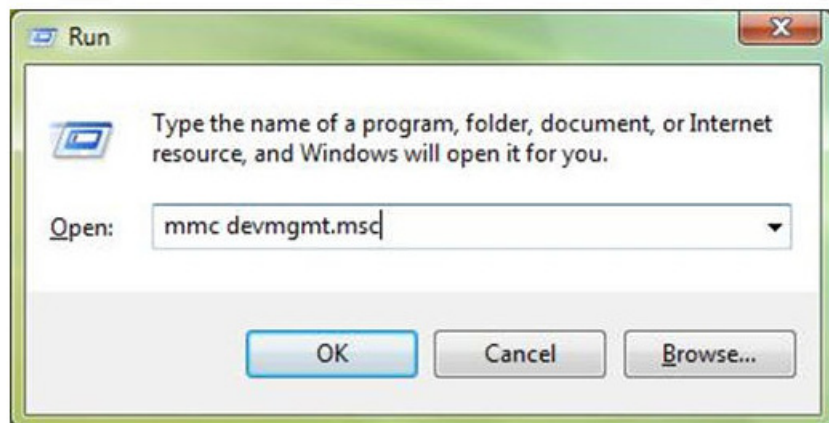

Figure 15. Windows Vista Run Window

3. Enter the following command in the Run window:

```
mmc devmgmt.msc
```

4. From the Computer Management Window, select Device Manager in the left panel. The Device Manager window is displayed. See Figure 16 on page 47.

On the Device Manager window, “Allied Telesis AT-2972SX Gbps Fiber Ethernet” is listed under “Network adapters.”

The Device Manager window for an AT-2972SX adapter is shown in Figure 16.

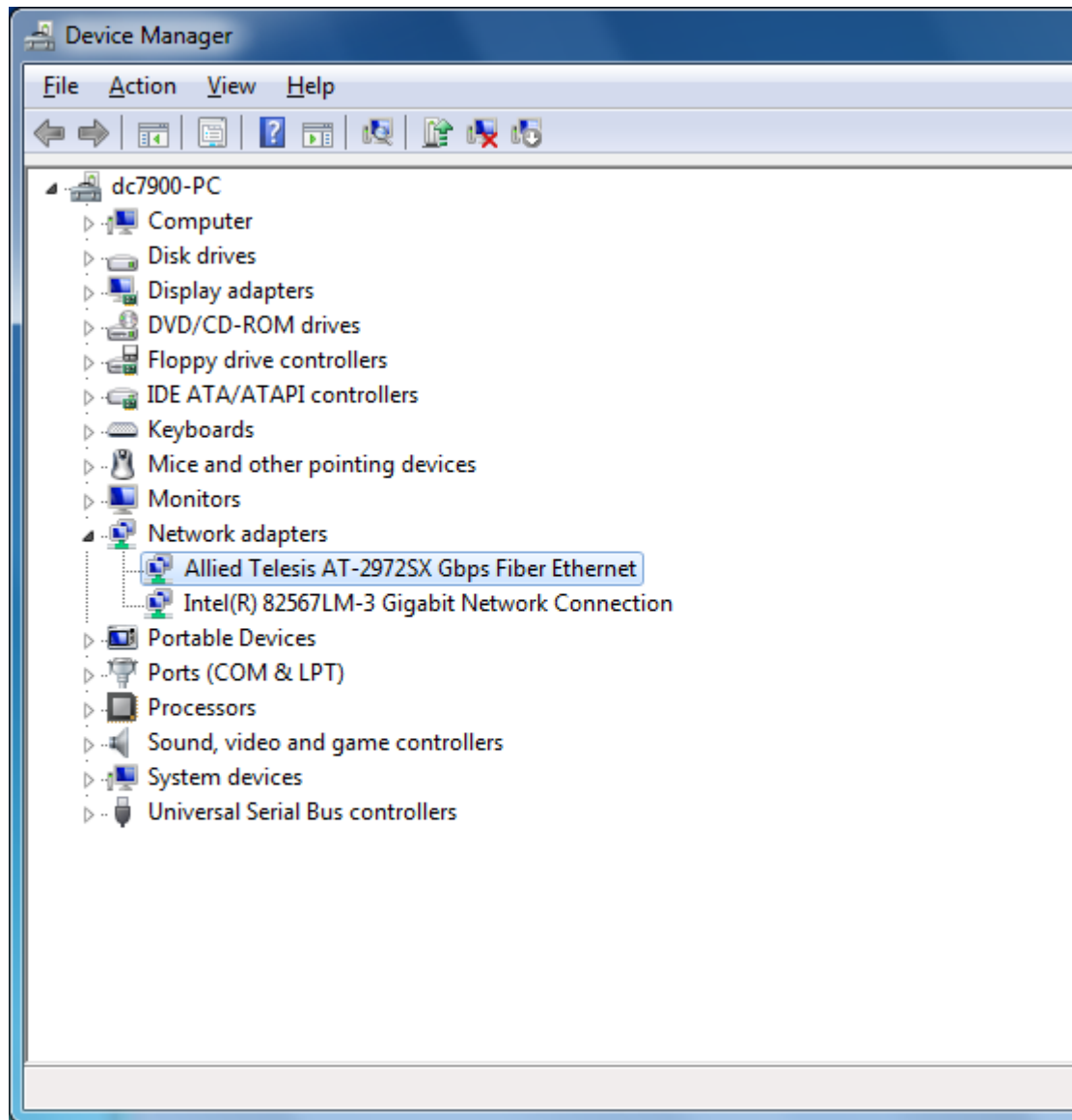

Figure 16. Device Manager Window

Installing the Windows 2008 R2, Windows, Vista, and Windows 7 Driver Software

To obtain the latest version of an AT-29xx Series adapter software drivers, download it from the Allied Telesis website at www.alliedtelesis.com/support/software.

To install the Windows 2008 R2, Windows Vista, or Windows 7 Operating System driver software, do the following:

Note

The adapter must be physically installed in your system before you install the driver software. See Chapter 2, “Installing the Hardware” on page 21 for instructions.

1. Start a Windows operating system and log in.
2. Open the Device Manager.

For instructions on how to open the Device Manager, see one of the following procedures:

- “Selecting the Device Manager in Windows 2008 R2 and Windows 7” on page 44
- “Selecting the Device Manager in Windows Vista” on page 46

3. In the Device Manager window, click the + next to the Network adapters folder.

The selection expands to show the list of installed network adapter cards installed on your PC. An AT-29xx Series adapter is listed either by its Allied Telesis name or “Broadcom NetExtreme.”

4. Right click **Ethernet Controller** and select **Update Driver Software**.

See Figure 17 for an example of the Device Manger window with Ethernet Controller selected.

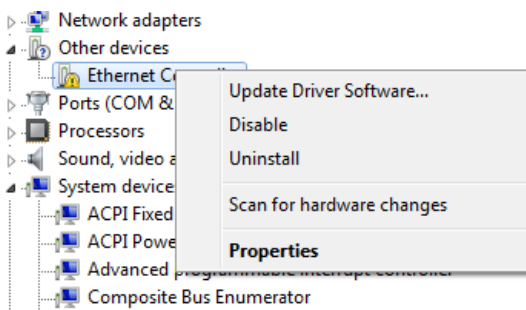

Figure 17. Device Manager Window: Ethernet Controller

The Update Driver Software - Ethernet Controller Window is displayed. See Figure 18.

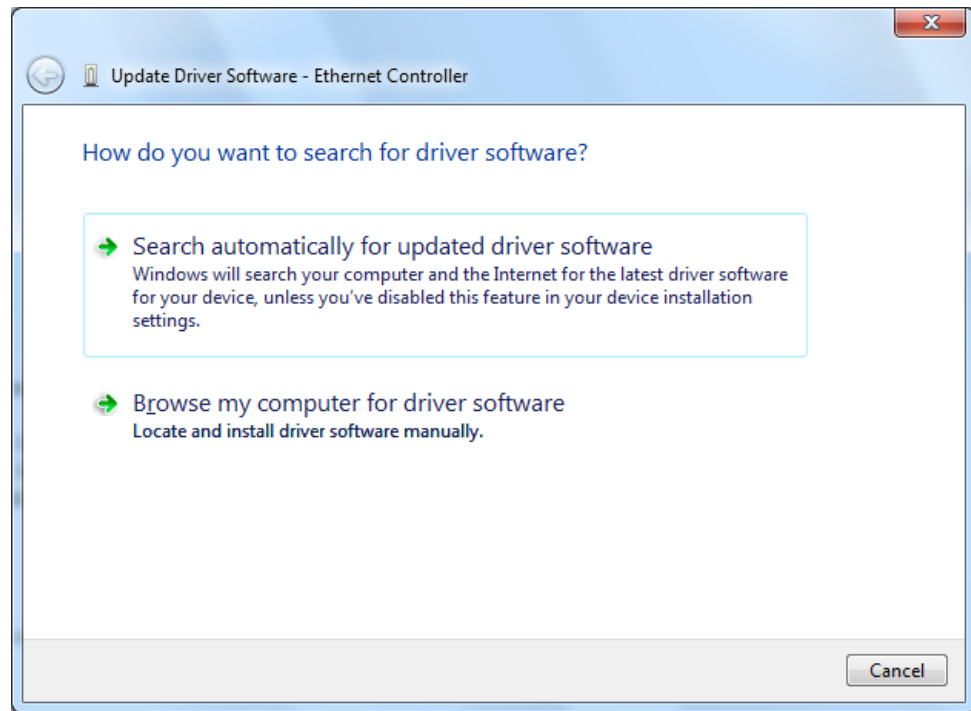

Figure 18. Update Driver Software - Ethernet Controller Window

5. Click **Browse my computer for driver software**.

The Update Driver Software - Ethernet Controller: Browse for Driver Software Window is displayed. See Figure 20 on page 50.

6. Click **Browse** to search your computer for the location of the driver software. See Figure 19.

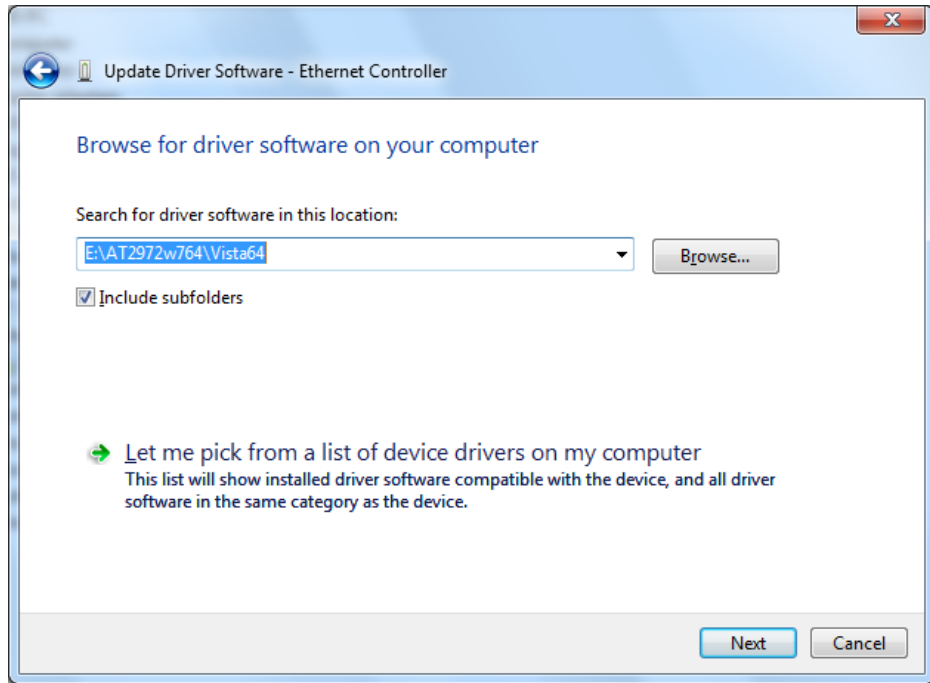

Figure 19. Update Driver Software: Ethernet Controller: Browse

7. Click **Next**. A confirmation message is displayed. See Figure 20.

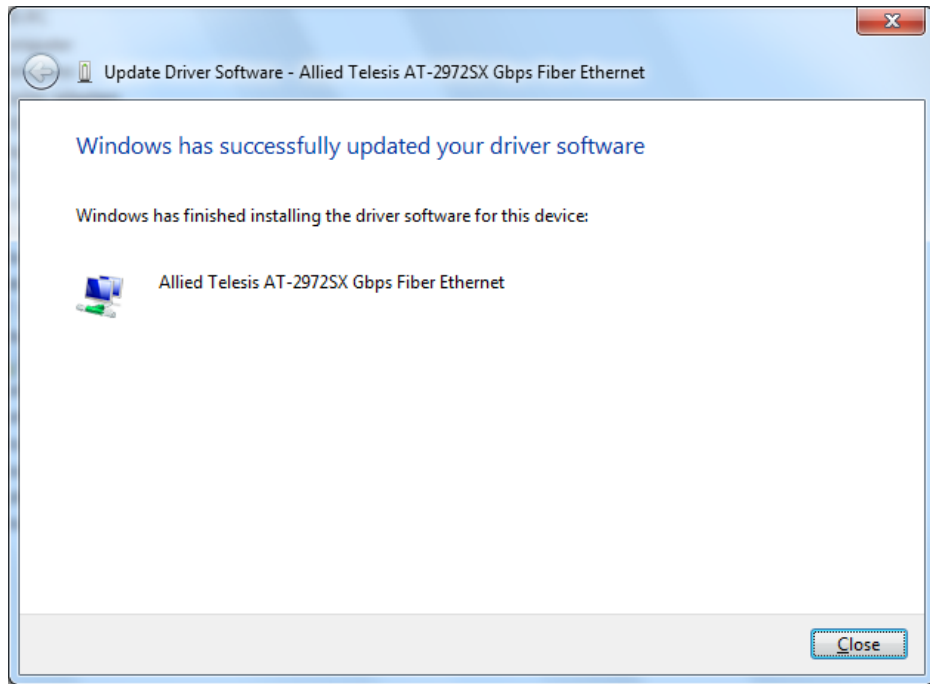

Figure 20. Update Driver Software - Confirmation Window

Uninstalling the Driver Software

Before physically removing an adapter from your system, you need to uninstall the driver software first. The procedure in this section describes how to uninstall the driver software.

Note

You must have Administrator privileges to remove the driver software.

**Caution**

Before uninstalling the Allied Telesis device, be sure to capture all of the Advanced Property settings because the properties are lost during the uninstall process.

To uninstall the driver software from your system, do the following:

1. Start a Windows 2008 R2, Windows Vista, or Windows 7 Operating System on your laptop and log in.
2. Open the **Device Manager**.

For instructions on how to open the Device Manager, see the following:

- “Selecting the Device Manager in Windows 2008 R2 and Windows 7” on page 44
- “Selecting the Device Manager in Windows Vista” on page 46

The Device Manager Window is shown in Figure 16 on page 47.

3. In the Device Manager window, click the **+** next to the Network adapters folder.

The selection expands to show the list of installed network adapter cards.

4. Right-click on the adapter you want to remove and select **Uninstall**.

A Confirm Device Removal window opens.

5. Click **OK** to complete the uninstall.

Note

Not all of the driver files are removed as a result of this procedure. You can remove additional drivers and installation files by selecting the checkbox to remove these files.

Chapter 5

Setting Advanced Properties

The Windows Advanced Properties are accessible from the Advanced Tab. For Windows Server 2003 and Windows XP systems, you access the Advanced Tab through the System Properties Dialog Box. For the Windows 2008 R2, Windows Vista, and Windows 7 Operating System software, you access the Advanced Tab through the Device Manager.

This chapter contains the following section:

- “Opening Advanced Properties” on page 54

Opening Advanced Properties

In most cases, the default property values available on the Advanced Tab are appropriate although you can change any of the available options to meet the requirements of your system. You must have Administrator privileges to modify the driver software. After the driver software has been installed, you can use the following procedures to verify or change the adapter properties:

- ❑ “802.1p QOS” on page 55
- ❑ “Ethernet@Wirespeed™ (AT-2972/T2 only)” on page 57
- ❑ “Flow Control” on page 57
- ❑ “Jumbo Mtu” on page 58
- ❑ “Interrupt Moderation” on page 59
- ❑ “IPSec Offload” on page 60
- ❑ “Large Send Offload Property” on page 61
- ❑ “Network Address” on page 62
- ❑ “Priority & VLAN” on page 63
- ❑ “Receive Side Scaling” on page 64
- ❑ “Speed & Duplex Mode” on page 65
- ❑ “Checksum Offload” on page 66
- ❑ “VLAN ID” on page 67
- ❑ “Wake Up Capabilities” on page 68
- ❑ “WOL Speed” on page 69

Note

After you upgrade the driver software, the Advanced Properties may change.

Note

The procedures in the sections listed above may differ slightly if the “Classic Start Menu” is set on your computer.

802.1p QOS

The 802.1p QOS property is a standard that enables Quality of Service (QOS). It is responsible for the QOS provisions on the local segment, and the avoidance of the “all packets are treated equally” issue, which falls onto the hub or switch servicing segment. The 802.1p QOS property provides prioritization of packets traversing a subnet. Thus, when the local segment becomes congested and the hub or switch workload results in the delay (dropping) of packets, those packets with flags that correspond to higher priorities receive preferential treatment and are serviced before packets with lower priorities.

To enable or disable the 802.1p QOS property, perform the following procedure:

1. For Windows Server 2003 and Windows XP systems, access the System Properties Dialog Box. See “Modifying Configuration Properties” on page 39.

For Windows 2008 R2, Windows 7, and Windows Vista systems, access the Device Manger for your operating system:

- ❑ To access the Device Manager window in Windows 2008 R2 or Windows 7, see “Selecting the Device Manager in Windows 2008 R2 and Windows 7” on page 44.
- ❑ To access the Windows Vista Device Manager, see “Selecting the Device Manager in Windows Vista” on page 46.

2. Click the **Advanced** tab.

The Advanced tab is shown in Figure 21 on page 56.

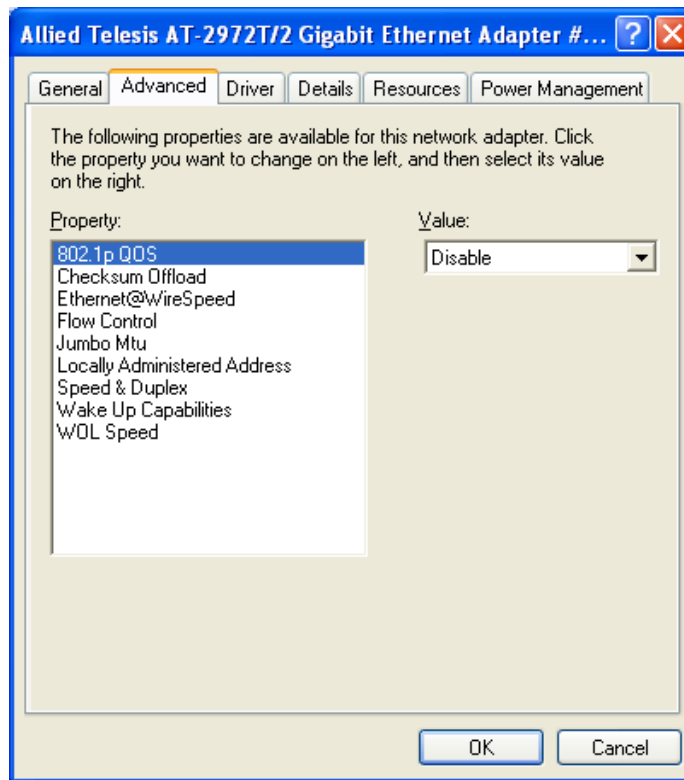

Figure 21. Advanced Tab

3. From the Properties list, select **802.1p QOS**.
4. From the Values list, select one of the following:
 - Enable** - Enables the 802.1p QOS property.
 - Disable** - Disables the 802.1p QOS property. This is the default.

Note

Enabling 802.1p QOS requires an 802.1p-aware switch.

5. Click **OK**.
6. If prompted to restart your computer, click **Yes**.

Although it is not necessary to reboot the system for new adapter properties to take effect, rebooting is recommended to reinitialize all registers.

7. Verify that the adapter port LEDs operate as described in “LEDs” on page 18.

Ethernet@Wire- speed™ (AT-2972/T2 only)

The Ethernet@Wirespeed property enables a Gigabit Ethernet adapter to establish a link at a lower speed when only two pairs of wires are available in the cabling plant. This property is available on the AT-2972/T2 adapter only. By default, the Ethernet@Wirespeed property is enabled.

To change the Ethernet@Wirespeed property, perform the following procedure:

1. For Windows Server 2003 and Windows XP systems, access the System Properties Dialog Box. See “Modifying Configuration Properties” on page 39.

For Windows 2008 R2, Windows 7, and Windows Vista systems, access the Device Manger for your operating system:

- To access the Device Manager window in Windows 2008 R2 or Windows 7, see “Selecting the Device Manager in Windows 2008 R2 and Windows 7” on page 44.
- To access the Windows Vista Device Manager, see “Selecting the Device Manager in Windows Vista” on page 46.

2. Click the **Advanced** tab.

The Advanced tab is shown in Figure 21 on page 56.

3. From the Properties list, select **Ethernet@Wirespeed**.

4. From the Values list, select one of the following:

- Enable** - Enables Ethernet@Wirespeed. This is the default.
- Disable** - Disables Ethernet@Wirespeed.

5. Click **OK**.

6. If prompted to restart your computer, click **Yes**.

Although it is not necessary to reboot the system for new adapter properties to take effect, rebooting is recommended to reinitialize all registers.

7. Verify that the adapter port LEDs operate as described in “LEDs” on page 18.

Flow Control

The Flow Control property allows you to enable or disable the receipt or transmission of PAUSE frames which allow the adapter and the switch to control the transmit rate. The port side that receives the PAUSE frame momentarily stops transmitting. The recommended selection is Disable, which configures the adapter to ignore PAUSE frames. By default, the Flow Control property is disabled.

To change the Flow Control property, do the following:

1. For Windows Server 2003 and Windows XP systems, access the System Properties Dialog Box. See “Modifying Configuration Properties” on page 39.

For Windows 2008 R2, Windows 7, and Windows Vista systems, access the Device Manger for your operating system:

- To access the Device Manager window in Windows 2008 R2 or Windows 7, see “Selecting the Device Manager in Windows 2008 R2 and Windows 7” on page 44.
- To access the Windows Vista Device Manager, see “Selecting the Device Manager in Windows Vista” on page 46.

2. Click the **Advanced** tab.

The Advanced tab is shown in Figure 21 on page 56.

3. From the Property list on the Advanced tab, select **Flow Control**.

4. From the Value list on the Advanced tab, select one of the following:

- Auto** - (default) PAUSE frame receipt and transmission is optimized.
- Disable** - PAUSE frame receipt and transmission is disabled (recommended).
- Rx PAUSE** - PAUSE frame receipt is enabled.
- Rx/Tx PAUSE** - PAUSE frame receipt and transmission is enabled.
- Tx PAUSE** - PAUSE frame transmission is enabled.

5. Click **OK**.

6. If prompted to restart your computer, click **Yes**.

Although it is not necessary to reboot the system for new adapter properties to take effect, rebooting is recommended to reinitialize all registers.

7. Verify that the port LED operates as described in “LEDs” on page 18.

Jumbo Mtu

The Jumbo Mtu property allows the adapter to transmit and receive oversized Ethernet frames that are greater than 1,514 bytes but less than 9,000 bytes in length. Note that this property requires a switch that is able to process large frames.

By default, the Jumbo Mtu property is set to 1500 bytes.

To increase the size of the received frames, do the following:

1. For Windows Server 2003 and Windows XP systems, access the System Properties Dialog Box. See “Modifying Configuration Properties” on page 39.

For Windows 2008 R2, Windows 7, and Windows Vista systems, access the Device Manger for your operating system:

- To access the Device Manager window in Windows 2008 R2 or Windows 7, see “Selecting the Device Manager in Windows 2008 R2 and Windows 7” on page 44.
- To access the Windows Vista Device Manager, see “Selecting the Device Manager in Windows Vista” on page 46.

2. Click the **Advanced** tab.

The Advanced tab is shown in Figure 21 on page 56.

3. From the Properties list, select **Flow Control**.
4. From the Values list, increment the byte quantity in 500-byte increments.
5. Click **OK**.
6. If prompted to restart your computer, click **Yes**.

Although it is not necessary to reboot the system for new adapter properties to take effect, rebooting is recommended to reinitialize all registers.

7. Verify that the adapter port LEDs operate as described in “LEDs” on page 18.

Interrupt Moderation

Interrupt moderation enables adaptive interrupt coalescing, which limits the rate of interrupt to the CPU during packet transmission and packet reception. The disabled option allows one interrupt for every packet transmission and packet reception. The default value is Enabled.

To change the Interrupt Moderation setting, do the following:

1. For Windows Server 2003 and Windows XP systems, access the System Properties Dialog Box. See “Modifying Configuration Properties” on page 39.

For Windows 2008 R2, Windows 7, and Windows Vista systems, access the Device Manger for your operating system:

- To access the Device Manager window in Windows 2008 R2 or Windows 7, see “Selecting the Device Manager in Windows 2008 R2 and Windows 7” on page 44.
- To access the Windows Vista Device Manager, see “Selecting the Device Manager in Windows Vista” on page 46.

2. From the Advanced tab under Property, select **Interrupt Moderation**.

For an example of the Advanced tab, see Figure 21 on page 56.

3. From the Value list on the Advanced tab, select one of the following:

- Enabled
- Disabled

4. Click **OK**.

5. If prompted to restart your computer, click **Yes**.

Although it is not necessary to reboot the system for new adapter properties to take effect, rebooting is recommended to reinitialize all registers.

6. Verify that the port LED operates as described in “LEDs” on page 18.

IPSec Offload

Traditionally, IPSec has been used for remote connections, but this feature has moved into the Local Area Network (LAN) to secure local network traffic against eavesdropping.

Vista’s Next Generation TCP/IP stack provides APIs for accessing brackets to allow advanced granularity to filter both inbound and outbound traffic. This was not possible with Microsoft’s XP Operating system. In addition, Vista’s security management now closely ties the firewall and IPSec features together by using a snap-in called Windows Firewall with Advanced Security. The onboard encryption engine on an AT-29xx Series adapter off-loads this task to the network controller instead of the host CPU, thereby freeing the host CPU for other important tasks. The off-loading feature is unique in the industry and enables you to set tight security efficiently within your network at a minimal cost.

Microsoft’s Technet website, www.technet.microsoft.com, offers several technical publications and online seminars that describe Vista’s advanced IPSec and Firewall features as well as their implementation. These topics are beyond the scope of this chapter. Instead, Allied Telesis recommends that you consult Technet for additional information.

By default, the IPSec Offload property is set to Disabled.

Note

The IPSec Offload feature applies only to Windows Vista and Windows 7.

To change the IPSec Offload setting, do the following:

1. For Windows Server 2003 and Windows XP systems, access the System Properties Dialog Box. See “Modifying Configuration Properties” on page 39.

For Windows 2008 R2, Windows 7, and Windows Vista systems, access the Device Manger for your operating system:

- To access the Device Manager window in Windows 2008 R2 or Windows 7, see “Selecting the Device Manager in Windows 2008 R2 and Windows 7” on page 44.
 - To access the Windows Vista Device Manager, see “Selecting the Device Manager in Windows Vista” on page 46.
2. From the Advanced tab under Property, select **IPSec Offload**.
For an example of the Advanced tab, see Figure 21 on page 56.
 3. From the Value list on the Advanced tab, select one of the following:
 - Auth Header & ESP Enabled
 - Auth Header Enabled
 - Disabled
 - ESP Enabled
 4. Click **OK**.
 5. If prompted to restart your computer, click **Yes**.

Although it is not necessary to reboot the system for new adapter properties to take effect, rebooting is recommended to reinitialize all registers.

6. Verify that the port LED operates as described in “LEDs” on page 18.

Large Send Offload Property

Normally, the protocol stack performs TCP segmentation. When you enable the Large Send Offload property, the network adapter does the TCP segmentation. There are several Large Send Offload properties to choose from, depending on the TCP/IP version you are using on your PC. You can select IPV4, IPV4 version 2, or IPV6 version 2. By default, the Large Send Offload Property is disabled.

To change the Large Send Offload property, do the following:

1. For Windows Server 2003 and Windows XP systems, access the System Properties Dialog Box. See “Modifying Configuration Properties” on page 39.

For Windows 2008 R2, Windows 7, and Windows Vista systems, access the Device Manger for your operating system:

- To access the Device Manager window in Windows 2008 R2 or Windows 7, see “Selecting the Device Manager in Windows 2008 R2 and Windows 7” on page 44.
- To access the Windows Vista Device Manager, see “Selecting the Device Manager in Windows Vista” on page 46.

2. Click the **Advanced** tab.

The Advanced tab is shown in Figure 21 on page 56.

3. From the Property list on the Advanced tab, select one of the following:

- Large Send Offload (IPv4)**
- Large Send Offload v2 (IPv4)**
- Large Send Offload v2 (IPv6)**

4. From the Value list on the Advanced tab, select one of the following:

- Enable** - Enables the Large Send Offload property.
- Disable** - Disables the Large Send Offload property. This is the default.

5. Click **OK**.

6. If prompted to restart your computer, click **Yes**.

Although it is not necessary to reboot the system for new adapter properties to take effect, rebooting is recommended to reinitialize all registers.

7. Verify that the port LED operates as described in “LEDs” on page 18.

Network Address

The Network Address is a user-defined address that is used to replace the MAC address that was originally assigned to the adapter. In some operating systems, this property is called Locally Administered Address. The network address consists of a 12-digit hexadecimal number.

To change the Network Address property, do the following:

1. For Windows Server 2003 and Windows XP systems, access the System Properties Dialog Box. See “Modifying Configuration Properties” on page 39.

For Windows 2008 R2, Windows 7, and Windows Vista systems, access the Device Manger for your operating system:

- To access the Device Manager window in Windows 2008 R2 or Windows 7, see “Selecting the Device Manager in Windows 2008 R2 and Windows 7” on page 44.
- To access the Windows Vista Device Manager, see “Selecting the Device Manager in Windows Vista” on page 46.

2. Click the **Advanced** tab.

The Advanced tab is shown in Figure 21 on page 56.

3. From the Property list on the Advanced tab, select **Network Address**.

4. In the Value list on the Advanced tab, enter the Locally Administered Address. Here are some guidelines:

- The range is 0000 0000 0001 to FFFF FFFF FFFD.
- Do not use a multicast address (least significant bit of the high byte = 1).
- Do not use all 0's or all F's.

5. Click **OK**.

6. If prompted to restart your computer, click **Yes**.

Although it is not necessary to reboot the system for new adapter properties to take effect, rebooting is recommended to reinitialize all registers.

7. Verify that the port LED operates as described in “LEDs” on page 18.

Priority & VLAN

Priority allows you to prioritize traffic or limit bandwidth instead of treating all traffic in the same manner. A Virtual Local Area Network (VLAN) is a logical area network that extends beyond a traditional LAN to a group of logical LANs.

By default, this property is set to Priority & VLAN Enabled.

To set the port priority and assign a VLAN ID, do the following:

1. For Windows Server 2003 and Windows XP systems, access the System Properties Dialog Box. See “Modifying Configuration Properties” on page 39.

For Windows 2008 R2, Windows 7, and Windows Vista systems, access the Device Manger for your operating system:

- To access the Device Manager window in Windows 2008 R2 or Windows 7, see “Selecting the Device Manager in Windows 2008 R2 and Windows 7” on page 44.
- To access the Windows Vista Device Manager, see “Selecting the Device Manager in Windows Vista” on page 46.

2. Click the **Advanced** tab.

The Advanced tab is shown in Figure 21 on page 56.

3. From the Property list on the Advanced tab, select “**Priority & VLAN.**”

4. In the Value list on the Advanced tab, select one of the following:

- Priority & VLAN Disabled
- Priority & VLAN Enabled
- Priority Enabled
- VLAN Enabled

5. Click **OK**.

6. If prompted to restart your computer, click **Yes**.

Although it is not necessary to reboot the system for new adapter properties to take effect, rebooting is recommended to reinitialize all registers.

7. Verify that the port LED operates as described in “LEDs” on page 18.

Receive Side Scaling

The Receive Side Scaling (RSS) feature configures RSS queues from 1 to 4. The available options are RSS 1 Queue, RSS 2 Queue, and RSS 4 Queue. By default, RSS is set to Enabled.

To set Receive Side Scaling, do the following:

1. For Windows Server 2003 and Windows XP systems, access the System Properties Dialog Box. See “Modifying Configuration Properties” on page 39.

For Windows 2008 R2, Windows 7, and Windows Vista systems, access the Device Manger for your operating system:

- To access the Device Manager window in Windows 2008 R2 or Windows 7, see “Selecting the Device Manager in Windows 2008 R2 and Windows 7” on page 44.
- To access the Windows Vista Device Manager, see “Selecting the Device Manager in Windows Vista” on page 46.

2. Click the **Advanced** tab.

The Advanced tab is shown in Figure 21 on page 56.

3. From the Property list on the Advanced tab, select “**Receive Side Scaling.**”
4. In the Value list on the Advanced tab, select one of the following:
 - Enabled
 - Disabled
5. Click **OK**.
6. If prompted to restart your computer, click **Yes**.

Although it is not necessary to reboot the system for new adapter properties to take effect, rebooting is recommended to reinitialize all registers.

7. Verify that the port LED operates as described in “LEDs” on page 18.

Speed & Duplex Mode

The speed and duplex mode property allows you to set the speed of the adapter as well as the change the duplex mode from full to half. By default, the duplex mode is set to a speed of 100 Mb in full duplex mode.

To change the speed and duplex mode of an adapter, do the following:

1. For Windows Server 2003 and Windows XP systems, access the System Properties Dialog Box. See “Modifying Configuration Properties” on page 39.

For Windows 2008 R2, Windows 7, and Windows Vista systems, access the Device Manger for your operating system:

- To access the Device Manager window in Windows 2008 R2 or Windows 7, see “Selecting the Device Manager in Windows 2008 R2 and Windows 7” on page 44.
- To access the Windows Vista Device Manager, see “Selecting the Device Manager in Windows Vista” on page 46.

2. Click the **Advanced** tab.

The Advanced tab is shown in Figure 21 on page 56.

3. From the Property list on the Advanced tab, select “**Speed & Duplex.**”
4. In the Value list on the Advanced tab, select one of the following:
 - 10 Mb Full
 - 10 Mb Half

- 100 Mb Full
- 100 Mb Half
- Auto

5. Click **OK**.
6. If prompted to restart your computer, click **Yes**.

Although it is not necessary to reboot the system for new adapter properties to take effect, rebooting is recommended to reinitialize all registers.

7. Verify that the port LED operates as described in “LEDs” on page 18.

Checksum Offload

Usually, the Checksum Offload function is computed by the protocol stack. By selecting one of the Checksum Offload properties, the adapter can compute the checksum.

To change the Checksum Offload setting, do the following:

1. For Windows Server 2003 and Windows XP systems, access the System Properties Dialog Box. See “Modifying Configuration Properties” on page 39.

For Windows 2008 R2, Windows 7, and Windows Vista systems, access the Device Manger for your operating system:

- To access the Device Manager window in Windows 2008 R2 or Windows 7, see “Selecting the Device Manager in Windows 2008 R2 and Windows 7” on page 44.
- To access the Windows Vista Device Manager, see “Selecting the Device Manager in Windows Vista” on page 46.

2. Click the **Advanced** tab.

The Advanced tab is shown in Figure 21 on page 56.

3. From the Property list under the Advanced tab, select **TCP/UDP Checksum Offload v4** or **TCP/UDP Checksum Offload v6**.

4. From the Value list on the Advanced tab, select one of the following:

- None** - Disables checksum offloading.
- Rx TCP/IP Checksum** - Enables receive TCP, IP, and UDP checksum offloading.
- Tx TCP/IP Checksum** - Enables transmit TCP, IP, and UDP checksum offloading.
- Tx/Rx TCP/IP Checksum** (default) - Enables transmit and receive TCP, IP, and UDP checksum offloading.

5. Click **OK**.
6. If prompted to restart your computer, click **Yes**.

Although it is not necessary to reboot the system for new adapter properties to take effect, rebooting is recommended to reinitialize all registers.

7. Verify that the port LED operates as described in “LEDs” on page 18.

VLAN ID

The VLAN ID specifies the VLAN identifier. It is the number of the VLAN where the port is an untagged member. You must assign a VLAN ID to a VLAN. The range is 1 to 4094. The default VLAN has a VLAN ID of 0.

To assign a VLAN ID, do the following:

1. For Windows Server 2003 and Windows XP systems, access the System Properties Dialog Box. See “Modifying Configuration Properties” on page 39.

For Windows 2008 R2, Windows 7, and Windows Vista systems, access the Device Manger for your operating system:

- To access the Device Manager window in Windows 2008 R2 or Windows 7, see “Selecting the Device Manager in Windows 2008 R2 and Windows 7” on page 44.
- To access the Windows Vista Device Manager, see “Selecting the Device Manager in Windows Vista” on page 46.

2. Click the **Advanced** tab.

The Advanced tab is shown in Figure 21 on page 56.

3. Under Property list on the Advanced tab, select **VLAN ID**.
4. From the Value list on the Advanced tab, choose a VLAN ID from 1 to 4094.

Note

The default VLAN has a VLAN ID of 0.

5. Click **OK**.
6. If prompted to restart your computer, click **Yes**.

Although it is not necessary to reboot the system for new adapter properties to take effect, rebooting is recommended to reinitialize all registers.

7. Verify that the port LED operates as described in “LEDs” on page 18.

Wake Up Capabilities

The Wake Up Capabilities property enables the network adapter to wake up from a low-power mode when it receives a network wake-up frame. There are two types of wake-up frames: Magic Packet and Wake Up Frame. The default setting is Both - which implements both the Magic Packet and Wake Up Frame.

Note

The Wake on LAN (WOL) feature applies to the copper port NIC cards:

AT-2912T
AT-2972T/4

WOL is not supported on fiber NIC cards due to power limitations of the PCI bus. The Gigabit fiber cards in this category are:

AT-2916SX
AT-2916LX10/LC-901
AT-2931SX,AT-2972SX
AT-2972LX10/LC-901
AT-2972SX/2

To change the Wake Up Capabilities property, do the following:

1. For Windows Server 2003 and Windows XP systems, access the System Properties Dialog Box. See “Modifying Configuration Properties” on page 39.

For Windows 2008 R2, Windows 7, and Windows Vista systems, access the Device Manger for your operating system:

- To access the Device Manager window in Windows 2008 R2 or Windows 7, see “Selecting the Device Manager in Windows 2008 R2 and Windows 7” on page 44.
- To access the Windows Vista Device Manager, see “Selecting the Device Manager in Windows Vista” on page 46.

2. Click the **Advanced** tab.

The Advanced tab is shown in Figure 21 on page 56.

3. From the Property list on the Advanced tab, select **Wake Up Capabilities**.
4. From the Value list on the Advanced tab, select one of the following:
 - Both - Implements Magic Packet and Wake Up Frame.
 - Magic Packet - Selects Magic Packet as the Wake Up frame.
 - None - Selects no wake-up frame.
 - Wake Up Frame - Selects Wake Up Frame as the wake-up frame

and allows the network adapter to wake up the system when an event, such as a ping or an ARP request, is received.

5. Click **OK**.

WOL Speed

The WOL Speed property sets the speed at which the network adapter connects to the network while the adapter is in Wake on LAN (WOL) mode. On Windows 2008 R2, Windows Vista, and Windows 7 systems, the default speed for WOL mode is 100 Mb. This is the only speed available for an AT-29xx Series adapter running the Windows 2008 R2, Windows Vista, and Windows 7 operating systems.

The WOL speed is limited to 100 Mb due to power limitations on the PCI bus. The WOL feature is supported only on copper Gigabit NICs where the speed must be reduced from 1 Gb to 100 Mb for the NIC power consumption to be below the maximum power provided by the PCI bus.

On the Windows Server 2003 or Windows XP systems, this property is available on the AT-2972/T2 adapter only. By default, the WOL Speed property is set to Auto. However, there are several additional settings available.

To specify the WOL speed on a Windows Server 2003 or Windows XP system, perform the following procedure:

1. For Windows Server 2003 and Windows XP systems, access the System Properties Dialog Box. See “Modifying Configuration Properties” on page 39.
2. Click the **Advanced** tab.

The Advanced tab is shown in Figure 21 on page 56.

3. From the Properties list, select **WOL Speed**.
4. From the Values list, select one of the following:
 - 10 Mb. Sets the speed to 10 Mbit/s. This is the network speed when the system is in a standby mode awaiting a wake-up frame.
 - 100 Mb. Sets the speed to 100 Mbit/s.
 - Auto (default). Sets the speed for optimum network connection.
5. Click **OK**.
6. If prompted to restart your computer, click **Yes**.

Although it is not necessary to reboot the system for new adapter properties to take effect, rebooting is recommended to reinitialize all registers.

7. Verify that the adapter port LEDs operate as described in “LEDs” on page 18.

Chapter 6

Installing the Linux Driver Software

This chapter describes the Linux driver for the AT-29xx Series Gigabit Ethernet Network adapters and includes the following sections:

- ❑ “Installing the Linux Driver Software” on page 72
- ❑ “Network Installation” on page 74
- ❑ “Removing the Linux Driver from a TAR Installation” on page 75
- ❑ “Module Parameters” on page 76

Installing the Linux Driver Software

The section describes the following Linux driver installations:

- “Building a Driver from a TAR File” on page 72
- “Removing the tg3 Driver” on page 72

Note

On some newer Distributions and Kernels, it may be necessary to remove the tg3 driver before loading the tg3 driver supplied on the CD. Follow the instructions in the “Removing the tg3 Driver” on page 72.

Building a Driver from a TAR File

To build a driver from a TAR file, perform the following procedure.

1. Create a directory and extract the TAR files:

```
tar xvzf tg3-<version>.tgz
```

2. Build the driver tg3.o as a loadable module for the running kernel:

```
cd tg3-<version>/src  
make
```

3. Test the driver by loading it:

```
insmod tg3.o
```

4. Install the driver and man page:

```
make install
```

5. To configure network protocol and address, refer to the manuals supplied with your operating system.

Removing the tg3 Driver

Many various Linux distributions may load the native tg3 driver by default for the Allied Telesis Gigabit Ethernet Network adapters. It may be necessary to unload the native tg3 driver first, before installing the tg3.o driver from this installation.

Note

On some Distributions and Kernels, it may be necessary to remove the native tg3 driver before loading the Allied Telesis tg3.o driver.

Although tg3 is a fully functioning driver, Allied Telesis recommends that you use the newer tg3 driver provided by Allied Telesis. Use ifconfig to bring down all eth# interfaces used by tg3 and enter the following command to unload the tg3 driver:

```
rmmod tg3
```

For more detailed Linux specific information on ifconfig, rmmod, or modules.conf, refer to the respective man pages.

Network Installation

For network installations through NFS, FTP, or HTTP (using a network boot disk or PXE), a driver diskette that contains the tg3 driver may be needed. The driver diskette images for the most recent Red Hat versions are included. Boot drivers for other Linux versions can be compiled by modifying the Makefile and the make environment. Further information is available from Red Hat's website, <http://www.redhat.com>.

To create the driver diskette, select the appropriate image file and do the following:

```
dd if=dd.img of=/dev/fd0H1440
```

Removing the Linux Driver from a TAR Installation

If the driver was installed using make install from the tar file, you must manually delete the tg3.o driver.

Module Parameters

Optional parameters for the driver can be supplied as command line arguments to the `insmod` command. Typically, these parameters are set in the file `/etc/modules.conf` (see the man page for `modules.conf`). These parameters take the following form:

```
<parameter>=value[,value,...]
```

where the multiple values for the same parameter are for multiple Allied Telesis Gigabit Ethernet Network adapters installed in the system.

Note

The default or other meaningful values are used when invalid values are selected. Some combinations of parameter values may conflict and lead to failures. The driver cannot detect all such conflicting combinations.

The module parameters are listed below:

□ **line_speed**

Selects the line speed of the link. This parameter is used together with `full_duplex` and `auto_speed` to select the speed and duplex operation of the link and the setting of Auto-Negotiation. Choose from the following selections:

- 0 - Autonegotiate for highest speed supported by link partner (default)
- 10 - 10 Mbps
- 100 - 100 Mbps
- 1000 - 1000 Mbps

If `line_speed` is set to 10, 100, or 1000 and the `auto_speed` is set to 1, the NIC autonegotiates for the selected speed (and selected duplex mode). If `auto_speed` is set to 0, the selected speed and duplex mode are set without Auto-Negotiation. Note that 1000 Mbps must be negotiated for copper twisted pair links.

□ **auto_speed**

Enables or disables Auto-Negotiation. Choose from the following selections:

- 0 - Auto-Negotiation disabled
- 1 - Auto-Negotiation enabled (default)

Note

This parameter is ignored and assumed to be 1 if the `line_speed` parameter is set to 0.

□ full_duplex

This parameter is used together with `line_speed` to select the speed and duplex mode of the link. Note that this parameter is ignored if `line_speed` is 0. Choose from the following selections:

- 0 - half duplex
- 1 - full duplex (default)

□ rx_flow_control

Enables or disables receiving flow control (pause) frames. This parameter is used together with `auto_flow_control`. Choose from the following selections:

- 0 - pause receive disabled
- 1 - pause receive enabled if `auto_flow_control` is set to 0, or pause receive advertised if `auto_flow_control` is set to 1 (default)

□ tx_flow_control

Enables or disables transmitting flow control (pause) frames. This parameter is used together with `auto_flow_control`. Choose from the following selections:

- 0 - pause transmit disabled
- 1 - pause transmit enabled if `auto_flow_control` is set to 0, or pause transmit advertised if `auto_flow_control` is set to 1 (default)

□ auto_flow_control

Enables or disables Auto-Negotiation of flow control. This parameter is used together with `rx_flow_control` and `tx_flow_control` to determine the advertised flow control capability. Choose from the following selections:

- 0 - flow control Auto-Negotiation disabled
- 1 - flow control Auto-Negotiation enabled with capability specified in `rx_flow_control` and `tx_flow_control` (only valid if `line_speed` is set to 0 or `auto_speed` is set to 1) (default)

❑ **mtu**

Enables jumbo frames up to the specified MTU size. The valid range for this parameter is 1500 to 9000. The default is 1500 which is the standard Ethernet (non-jumbo) MTU size. Note that the MTU size excludes the Ethernet header size of 14 bytes. Actual frame size is MTU size + 14 bytes.

The MTU size can also be changed using `ifconfig` after the driver is loaded. See the `ifconfig` man page for details.

❑ **tx_checksum**

Enables or disables hardware transmit TCP/UDP checksum. Choose from the following selections:

- 0 - checksum disabled
- 1 - checksum enabled (default)

❑ **rx_checksum**

Enables or disables hardware receive TCP/UDP checksum validation. Choose from the following selections:

- 0 - checksum disabled
- 1 - checksum enabled (default)

❑ **scatter_gather**

Enables or disables scatter-gather and 64-bit DMA on x86. This option is only useful when running on TUX-enabled kernels or kernels with zero-copy TCP. Choose from the following selections:

- 0 - scatter-gather and 64-bit DMA on x86 disabled
- 1 - scatter-gather and 64-bit DMA on x86 enabled (default)

❑ **tx_pkt_desc_cnt**

Configures the number of transmit descriptors. Default is 100. The valid range is from 1 to 600. Depending on kernel and system architecture, the driver may require up to 268 bytes per descriptor. Note that the driver may not be able to allocate the required amount of memory if this parameter is set too high. This parameter should not be set less than 80 if `adaptive_coalesce` (see below) is enabled.

❑ **rx_std_desc_cnt**

Configures the number of receive descriptors for frames up to 1528 bytes. Default is 200. The valid range is from 1 to 511. This parameter should not be set less than 80 on systems with high network traffic.

Setting this parameter higher allows the NIC to buffer larger bursts of network traffic without dropping frames, especially on slower systems. Note that the driver may not be able to allocate the required amount of memory if this parameter is set too high. This parameter should not be set less than 50 if `adaptive_coalesce` (see below) is enabled.

❑ **rx_jumbo_desc_cnt**

Configures the number of receive descriptors for jumbo frames larger than 1528 bytes. The default is 128 and the valid range is from 1 to 255. When jumbo frames larger than 1528 bytes are used, do not set this parameter to lower than 60 on systems with high network traffic. Setting this parameter higher allows the NIC to buffer larger bursts of jumbo traffic without dropping frames, especially on slower systems. Depending on kernel and system architecture, the driver may require up to 268 bytes per descriptor. Note that each descriptor also requires a buffer the size of a maximum jumbo frame. On systems with insufficient memory, it may be necessary to reduce this parameter. This parameter should not be set to less than 50 if `adaptive_coalesce` (see below) is enabled. When the maximum frame size is less than 1528 (MTU size less than 1514), this parameter is not used and is always 0.

❑ **adaptive_coalesce**

Enables or disables adaptive adjustments to the various interrupt coalescing parameters. Enabling it allows the driver to dynamically adjust the interrupt coalescing parameters to achieve high throughput during heavy traffic and low latency during light traffic. Do not set `rx_std_desc_cnt` (and `rx_jumbo_desc_cnt` if using jumbo frames) to less than 50. Also, do not set `tx_pkt_desc_cnt` to less than 80 when this parameter is enabled. Choose from the following selections:

- 0 - disabled
- 1 - enabled (default)

❑ **rx_coalesce_ticks**

Configures the number of 1 usec ticks before the NIC generates receive interrupt after receiving a frame. This parameter works in conjunction with the `rx_max_coalesce_frames` parameter. Interrupt is generated when either of these thresholds is exceeded. A value of 0 means this parameter is ignored and an interrupt is generated when the `rx_max_coalesce_frames` threshold is reached. The valid range is from 0 to 500 and default is 80. This parameter is not used and is adjusted automatically if `adaptive_coalesce` is set to 1.

❑ rx_max_coalesce_frames

Configures the number of received frames before the NIC generates receive interrupt. The valid range is from 0 to 100 and the default is 15. This parameter and rx_coalesce_ticks cannot both have a value of 0. If both parameters are set to 0, no receive interrupts are generated. It should also be set significantly lower than rx_std_desc_cnt (and rx_jumbo_desc_cnt if using jumbo frames). This parameter is not used and is adjusted automatically if adaptive_coalesce is set to 1.

❑ tx_coalesce_ticks

Configures the number of 1 usec ticks before the NIC generates transmit interrupt after transmitting a frame. This parameter works in conjunction with the tx_max_coalesce_frames parameter. Interrupt is generated when either of these thresholds is exceeded. A value of 0 means this parameter is ignored and an interrupt is generated when the tx_max_coalesce_frames threshold is reached. The valid range is from 0 to 500 and the default is 400. This parameter is not used and is adjusted automatically if adaptive_coalesce is set to 1.

❑ tx_max_coalesce_frames

Configures the number of transmitted frames before the NIC generates transmit interrupt. The valid range is from 0 to 100 and the default is 40. This parameter and tx_coalesce_ticks cannot both have a value of 0. If both parameters have a value of 0, no transmit completion interrupt is generated. This parameter should always be set lower than tx_pkt_desc_cnt. This parameter is not used and is adjusted automatically if adaptive_coalesce is set to 1.

❑ stats_coalesce_ticks

Configures the number of 1 usec ticks between periodic statistics block DMAs. The valid range is from 0 to 3600000000, and the default is 1000000 (1 sec.). Set this parameter to a value of 0 to disable statistics updates. This parameter is not used and is set to default if rx_adaptive_coalesce is set to 1.

❑ enable_wol

Enables or disables magic packet Wake-On-LAN when the system is shutdown. Note that not all systems support Wake-On-LAN. Choose from the following selections:

- 0 magic packet Wake-On-LAN disabled (default)
- 1 magic packet Wake-On-LAN enabled

❑ **enable_tso**

Enables or disables TCP Segmentation Option (TSO) when using kernels that support it. Choose from the following selections:

- TSO disabled (default)
- TSO enabled

Chapter 7

Installing the Novell NetWare Driver Software

This chapter provides procedures for installing the Novell NetWare driver software and contains the following sections:

- ❑ “Driver Installation” on page 84
- ❑ “Pre-Installation Requirements” on page 85
- ❑ “Installing Novell NetWare Server 5.x or 6.0 Driver Software” on page 86
- ❑ “Verifying or Modifying Adapter Parameters” on page 88
- ❑ “Removing Drivers from Autoexec.ncf” on page 93

Driver Installation

This chapter describes how to perform the following tasks:

- ❑ Verify that the required OS support files are installed on the server and the NetWare pre-installation parameters are set correctly.
- ❑ Install the driver software in the Novell NetWare environment.
- ❑ If necessary, reconfigure the driver software after installation.
- ❑ For an adapter installation with an existing NetWare server, NetWare automatically detects the new adapter and attempts to load the appropriate driver. You can download the latest version of the software driver from the Allied Telesis website at **www.alliedtelesis.com/support/software**.

A commonly used method to install a driver on a NetWare server running 5.x or 6.0 and higher is through *NWCONFIG*.

Pre-Installation Requirements

A network device driver must be installed before the AT-29xx Series Gigabit Ethernet network adapters can be used with your Novell NetWare system.

Before you can successfully install the adapter driver for Novell NetWare, the adapter card must be physically installed in the server and, typically, the NetWare OS software must already be running on the server. Make sure that your server meets the hardware and operating system software requirements described “Installing the Hardware” on page 21.

To enable the Allied Telesis AT-29xx Series Gigabit Ethernet network adapters to function correctly, you need to install the latest Novell NetWare support pack files. The NetWare support pack or patch file(s) needed for the operating system running on your server are indicated in Table 4.

Table 4. NetWare Support Files

NetWare OS	Support Pack or Patch	Files to be Installed
NetWare 5.1	Latest NetWare 5.1 Support Pack	The latest support pack can be found at http://support.novell.com/patlst.htm
NetWare 6.0	Latest NetWare 6.0 Support Pack	

Note

If you are installing NetWare 5.x or 6.0 for the first time on a system, the process to install the adapter driver occurs during the OS installation procedure. Install the NetWare 5 support pack after you have successfully installed the operating system on the server.

To obtain the latest support pack files, go to the Novell support website and click on the Minimum Patch List option in the navigation bar. Scroll down the page and, using Table 4 above as a guide, select and download the latest support pack or patch file(s) for the operating system running on your server.

Installing Novell NetWare Server 5.x or 6.0 Driver Software

Check that the server has the latest support pack available installed. The latest support packs can be found at: <http://support.novell.com/misc/patlst.htm>. In addition, you can download the latest version of the software driver from the Allied Telesis website at www.alliedtelesis.com/support/software

To install the Novell NetWare Server 5.x or 6.0 driver software, perform the following procedure:

1. From the NetWare Server console, type LOAD NWCONFIG (or just NWCONFIG) and press **Enter**.
2. From the Configuration Options screen, select **Driver options** and press **Enter**.
3. Select the **Configure network drivers** option and press **Enter**.
4. Choose the **Load an additional driver** option and press **Enter**.
5. Press **Enter** to select the highlighted driver.

A copy the driver prompt appears.

6. Select **Yes** and press **Enter**.
7. Select **Yes** and press **Enter** to copy the .LDI file. This is the installation script for the driver.
8. Follow the instructions for the installation.
9. Select **Save parameters and load driver** to continue.
10. Choose **Exit** to return to the server console prompt.

Note

If you are performing an initial installation of NetWare 5.x or 6.0 and have more than two adapters installed, the install program allows you to allocate the actual number of packet receive buffers needed by the adapter. During installation, make sure the RxBuffers value is set to 32 which is the minimum number of buffers the driver requires for each adapter. While this setting affects adapter performance, it allows installation of the operating system and up to eight adapters during the initial installation. After installation is complete, increase the number of buffers allocated to the driver as described in "Verifying or Modifying Adapter Parameters" on page 88.

11. 5.x or 6.05.x or 6.0 NetWare 5.x or 6.0 has been successfully installed, set the minimum packet receive buffers parameter in the startup.ncf file to 1500 for each adapter in the system.

Set the maximum packet receive buffers to three times the minimum packet receive buffers. Typically 4 MB of RAM is required per 1000 receive buffers. For more information, see “Verifying or Modifying Adapter Parameters” on page 88.

12. In the autoexec.ncf file, delete the packet receive buffers parameter (RxBuffers=32) in the load statement for this adapter. Deleting the receive buffers phrase from the load statement resets the receive buffers parameter to the default value of 200 for this adapter.

Note

The server needs to be restarted for the new configuration.

Example: The default maximum number of receive buffers for the system is 500; the default minimum is 128. Edit the startup.ncf file to have the following entries. The actual numbers will be a function of the number of ports in the system. The following is an example for a system with 8 ports installed:

```
set maximum packet receive buffers = 36000  
set minimum packet receive buffers = 12000
```

Verifying or Modifying Adapter Parameters

When an adapter configuration is saved, the NetWare install program adds load and bind statements to the autoexec.ncf file. By accessing this file, you can verify the parameters configured for each adapter, modify them, or enter additional parameters.

Note

The Novell monitor program and the config command are also useful for verifying driver configuration. For information on how to use these programs, see the Utilities Reference in your Novell NetWare online documentation.

The parameters that can be defined in the load statements are described below:

Configuration Parameters for B57.LAN driver:

TxDescriptors=

This is to initialize Descriptor resources on the adapter for transmits.

Min = 100

Max = 512

Default = 120

RxBuffers=

This is to pre-allocate receive ECBS & Receive adapter resources. This setting may be affected by the NetWare server maximum/minimum packet receive buffer settings.

Min = 32

Max = 1000

Default = 200

RxTicks=

This is to enable the use of batching receives within a specific time period.

Min = 0, disabled

Max = 5000000, 5 seconds

Units are in micro seconds

Default value is 300

TxTicks=

This is to enable the use of a transmit "tick" threshold interrupt within a specific time period.

Min = 0, disabled

Max = 5000000, 5 seconds

Units are in micro seconds

Default is 200

TxPacketsPer=

This is to enable the use of allowing an interrupt to occur after a specific amount of packets are transmitted.
Min = 0, disabled
Max = 100
Default is 20

RxPacketsPer=

This is to enable the use of allowing an interrupt to occur after a specific amount of packets are received.
Min = 0, disabled
Max = 100
Default is 75

Checksum=

This is to enable or disable the transmit & receive checksum off loading feature. The checksum off loading support is only for TCP/IP packets, for that reason it is defaulted to OFF.
Choices are:
OFF, ON, TX, RX
Default value is OFF

TxFLOW=

This keyword allows enabling/disabling of TxFlow control.
Choices are:
ON, OFF
Default value is OFF.

RxFLOW=

This keyword allows enabling/disabling of RxFlow control.
Choices are:
ON, OFF
Default value is OFF.

PDriver=

Allows for the driver to operate in persistent driver mode. Only use if adapter is placed in a Hot Plug PCI slot and only if required to swap with an exact same board.
Choices are:
OFF, ON
Default value is OFF.

NODE=

This is a Novell NetWare keyword.
This keyword will allow an input Ethernet node address to replace the adapter factory programmed Ethernet node address until a subsequent reboot.
Choices are:
NODE=nnnnnnnnnnnn

FRAME=

This is a Novell Netware keyword.
String specifying the frame type.
Choices are:
ETHERNET_II
ETHERNET_802.3
ETHERNET_802.2
ETHERNET_SNAP
Default value is ETHERNET_802.2

SLOT=

This is a Novell Netware keyword.
System-wide unique Hardware Instance Number (HIN) that
may be the physical slot number on a slot based bus such
as PCI.
SLOT=n

Jumbo=

Keyword to enable Jumbo frame support. When enabled,
jumbo packets of up to 9000 bytes are supported.
Choices are:
Jumbo=1536-9100
Default is no jumbo packets

Note

Jumbo frames are only supported on NetWare 6.0 and above. Plus
the first frame loaded must be ETHERNET_II

Note

Jumbo frame support must have the following text in the Startup.ncf
file: "Set maximum physical receive packet size = 18000".

P3=

This keyword is used when running perform3.exe tests and
may increase performance on networks running with many
ipx clients.
Set P3=1, when running the perform3 test back to back to
a single client.
Set P3=2, when running the perform3 test with many
clients.
Default: P3=0.

spuriousfix=

When this keyword is set to 1 (spurious fix is on), the
spurious interrupts count that is sometimes displayed on
the Netware console monitor, may be reduced. By setting
this keyword to 0 (spurious fix is OFF), performance of
the driver may be enhanced.

The Default is spurious fix = 1 (spurious fix is on).

Choices are:

Spuriousfix=0

Spuriousfix=1 (default).

Poll=

To disable interrupt driven mode in the driver set Poll=1 and the driver will not use interrupts, but will be polled by the Netware OS. This is a common feature supported in NW. The poll mode may increase driver performance in some environments.

Choices are:

Poll=1 (ON)

Poll=0 (OFF) (default).

wireSpeed=

This feature provides adapter link & data integrity even when attached to a questionable cable and/or switch.

For example; an adapter trying to run 1000 speed on a cat3 cable ordinarily would not link. with the wireSpeed=1, the link will occur at 100Mbs.

Choices are:

wireSpeed=1 (ON) (Default)

wireSpeed=0 (OFF).

Model=

This keyword is to allow the addition of a sub-system ID of a specific NIC so that the driver loads only on the first NIC found with a matching sub-system ID.

e.g., MODEL= 0x14e4

Default = 0

MagicP=

When the MagicP=1 the driver will enable the adapter to wake up the system when a magic packet is received after the system is shutdown. MagicP=0 is the default setting with the adapter having no wake up ability.

Choices are:

MagicP=0 (default)

MagicP=1

Fiber=

The driver has support for the 1000FD fiber adapter. The fiber autonegotiates link with a fiber switch even though it only supports 1000FD. In some cases the user may want to force the adapter to 1000FD.

Choices are:

Fiber=AUTO (default)

Fiber=FORCE

Note

If you modify any adapter parameters, you must reboot the system before the changes take effect. If you make changes and do not reboot, you may experience configuration problems.

A valid autoexec.ncf file is shown below. One set of load and bind commands (in **bold**) is added for each frame type the adapter is configured to support.

```

Set Time Zone = PST8PDT
set Daylight Savings Time Offset = 1
set Start Of Daylight Savings Time = (APRIL SUNDAY FIRST
2:00:00 AM)
set End Of Daylight Savings Time = (OCTOBER SUNDAY LAST
2:00:00 AM)
set Default Time Server Type = SINGLE
set Bindery Context = O=LAN

# WARNING!!
file server name NOVELLSERVER51
# WARNING!!
# If you change the name of this server, you must update
# all the licenses that are assigned to this server.
# Using NWAdmin, double-click on a license object and
# click on the Certificate Assignments button. If the
# old name of this server appears, you must delete it and
# then add the new server name. Do this for all license
# objects.

ServerID 1C8EE2C
LOAD ODINEB.NLM
LOAD TCPIP
LOAD B57 SLOT=2 FRAME=Ethernet_802.2 NAME=B57_1_E82
BIND IPX B57_1_E82 NET=FAFD3D25
LOAD B57 SLOT=2 FRAME=Ethernet_802.3 NAME=B57_1_E83
BIND IPX B57_1_E83 NET=5A2D8D6D
LOAD B57 SLOT=2 FRAME=Ethernet_SNAP NAME=B57_1_ESP
BIND IPX B57_1_ESP NET=477A35BD
LOAD B57 SLOT=2 FRAME=Ethernet_II NAME=B57_1_EII
BIND IPX B57_1_EII NET=C3C8F2E4
BIND IP B57_1_EII ADDR=172.16.1.1 MASK=ff.ff.ff.0

mount all

SEARCH ADD SYS:\JAVA\BIN
SEARCH ADD SYS:\JAVA\NWGFX

```

Removing Drivers from Autoexec.ncf

To remove the drivers from the Autoexec.ncf, locate the Load and Bind command lines associated with the Broadcom driver and remark them out by inserting the # symbol at the beginning of each command line, or by deleting the statement.

Example:

```
# LOAD B57 SLOT=2 FRAME=Ethernet_802.2
NAME=B57_1_E82
# BIND IPX B57_1_E82 NET=FAFD3D25
# LOAD B57 SLOT=2 FRAME=Ethernet_802.3
NAME=B57_1_E83
# BIND IPX B57_1_E83 NET=5A2D8D6D
# LOAD B57 SLOT=2 FRAME=Ethernet_SNAP NAME=B57_1_ESP
# BIND IPX B57_1_ESP NET=477A35BD
# LOAD B57 SLOT=2 FRAME=Ethernet_II NAME=B57_1_EII
# BIND IPX B57_1_EII NET=C3C8F2E4
# BIND IP B57_1_EII ADDR=172.16.1.1 MASK=ff.ff.ff.0
```

Note

If you modify the Autoexec.ncf, you must reboot the system before the changes take effect.

Chapter 8

Installing the NDIS2 Driver Software for MS-DOS Platforms

This chapter provides procedures for installing the NDIS2 driver software, and contains the following sections:

- “Installing the NDIS2 Driver Software for Use on MS-DOS Platforms” on page 96
- “Using Keywords for the B57.dos Drivers” on page 101

Installing the NDIS2 Driver Software for Use on MS-DOS Platforms

You can run the NDIS2 driver software from an MS-DOS startup disk using Microsoft Network Client 3.0.

Pre-Installation Requirements

Before you can successfully install the NDIS2 driver software, the Allied Telesis AT-29xx Series Gigabit Ethernet Network adapter must be physically installed in the computer.

Modifying the Startup Disk

To modify the startup disk, perform the following procedure:

1. Edit A:\Net\Protocol.ini with Notepad or a similar text editor.
 - a. Change **DriverName=\$** to **DriverName=B57\$**.
 - b. Remove all other parameter entries under the [MS\$NE2CLONE] or equivalent section such as IOBASE=0x300 or INTERRUPT=3, and so on.

Example Protocol.ini for IP

```
[network.setup]
version=0x3110
netcard=ms$ne2clone,1,MS$NE2CLONE,1
transport=tcpip,TCPIP
\ana0=ms$ne2clone,1,tcpip
[MS$NE2CLONE]
DriverName=B57$
[protman]
DriverName=PROTMAN$
PRIORITY=MS$NDISHLP
[tcpip]
NBSessions=6
DefaultGateway=0 ; SubNetMask=255 0 0 0
; IPAddress=192 168 0 1
DisabledDHCP=0
DriverName=TCPIP$
```



```
BINDINGS=MS$NE2CLONE
```

```
LANABASE=0
```

Example Protocol.ini for IPX

```
[network.setup]
```

```
version=0x3110
```

```
netcard=ms$ne2clone,1,MS$NE2CLONE,1
```

```
transport=ms$ndishlp,MS$NDISHLP
```

```
transport=ms$nwlink,MS$NWLINK
```

```
lana0=ms$ne2clone,1,ms$nwlink
```

```
lana1=ms$ne2clone,1,ms$ndishlp
```

```
[MS$NE2CLONE]
```

```
DriverName=B57$
```

```
[protman]
```

```
DriverName=PROTMAN$
```

```
PRIORITY=MS$NDISHLP
```

```
[MS$NDISHLP]
```

```
DriverName=ndishlp$
```

```
BINDINGS=ms$ne2clone
```

```
[ms$nwlink]
```

```
DriverName=nwlink$
```

```
FRAME=Ethernet_802.2
```

```
BINDINGS=MS$NE2CLONE
```

```
LANABASE=0
```

Example Protocol.ini for NetBEUI

```
[network.setup]
```

```
version=0x3110
```

```
netcard=ms$ne2clone,1,MS$NE2CLONE,1
```

```
transport=ms$ndishlp,MS$NDISHLP
```

```
transport=ms$netbeui,MS$NETBEUI
```

```
lanana0=ms$ne2clone,1,ms$ndishlp
lanana1=ms$ne2clone,1,ms$netbeui
[MS$NE2CLONE]
DriverName=B57$
[protman]
DriverName=PROTMAN$
PRIORITY=MS$NDISHLP
[MS$NDISHLP]
DriverName=ndishlp$
BINDINGS=MS$NE2CLONE
[MS$NETBEUI]
DriverName=netbeui$
SESSIONS=10
NCBS=12
BINDINGS=MS$NE2CLONE
LANABASE=0
```

2. Edit A:\Net\System.ini.
 - a. Change **netcard=** to **netcard=b57.dos**.
 - b. Check for references to C:\NET and change **C:\NET** to **A:\NET** if necessary.

Example SYSTEM.INI

```
[network]
sizworkbuf=1498
filesharing=no
printsharing=no
autologon=yes
computername=MYPE
lanroot=A:\NET
username=USER1
workgroup=WORKGROUP
```

```

reconnect=yes
dospophotkey=N
lmlogon=0
logondomain=
preferredredir=basic
autostart=basic
maxconnections=8
[network drivers]
netcard=B57.dos
transport=ndishlp.sys,*netbeui
devdir=A:\NET
LoadRMDrivers=yes

```

3. Copy **B57.dos** to **A:\Net**.
4. Create the appropriate Autoexec.bat file in drive A for the chosen protocol as shown below.

For TCP/IP

```

path=a:\net
a:\net\net initialize
a:\net\netbind.com
a:\net\umb.com
a:\net\tcptsr.exe
a:\net\tinyrfc.exe
a:\net\nmtsr.exe
a:\net\lemsbfr.exe
a:\net\net start basic
net use z: \\SERVERNAME\SHARENAME

```

For IPX

```

SET PATH=A:\NET
A:\NET\net initialize
A:\NET\nwlink

```

```
A:\NET\NET START BASIC
```

```
net use z: \\SERVERNAME\SHARENAME
```

For NetBEUI

```
SET PATH=A:\NET
```

```
A:\NET\NET START BASIC
```

```
net use z: \\SERVERNAME\SHARENAME
```

5. Create a Config.sys file on the startup disk in drive A as shown below.

```
files=30
```

```
device=a:\net\ifshlp.sys lastdrive=z
```

Using Keywords for the B57.dos Drivers

The Protocol.ini file contains certain keywords that are used by the B57.dos drivers. These keywords are listed below:

BusNum. Specifies the PCI bus number on which the network controller is located. Requires a decimal number having a value ranging from 0 to 255.

DevNum. Specifies the device number assigned to the network controller when it is configured by the PCI BIOS. Requires a decimal number having a value ranging from 0 to 255.

FuncNum or PortNum. Specifies the PCI function or port number assigned to the network controller. Requires a decimal number having a value ranging from 0 to 7.

Note

The BusNum, DevNum, and FuncNum (or PortNum) keywords are needed when multiple controllers are installed in the computer and when a specific controller must be loaded in a certain order. These keywords are used concurrently and are included for manufacturing purposes. Do not use them unless you are familiar with how to configure PCI devices. A PCI device scan utility is needed to find this information.

NodeAddress. Specifies the network address used by the network controller. If a multicast address or a broadcast address is specified, the controller uses the default MAC address.

Example

```
[B57]
DriverName = "B57$"
BusNum = 3
DevNum = 14
PortNum = 2
LineSpeed = 1000
Fuplex = Full
NodeAddress = 001020304050
```

Chapter 9

Installing the PXE Boot Agent

This chapter describes the PXE Boot Agent and provides procedures for installing it on a server running Windows Server 2003, Windows XP, DOS UNDI/APITEST, or Red Hat Linux system.

This chapter contains the following sections:

- ❑ “Overview” on page 104
- ❑ “Server Setup” on page 105

Overview

The Allied Telesis AT-29xx Series Gigabit Ethernet network adapters provide PXE (Preboot Execution Environment) support.

PXE is enabled by default. To enable or disable PXE, refer to the b57udiag.pdf document located in the diagnostics directory.

Setup BIOS

To boot from the network with PXE, make PXE the first bootable device under BIOS. This procedure depends on server BIOS implementation. Please refer to the server's user manual.

Server Setup

This section discusses how to set up a server on a Windows Server 2003, Windows XP, DOS UNDI/APITEST, and Red Hat Linux systems.

Note

If pack 3 is installed, no modification to the inf file is necessary.

Windows Server 2003 and Windows XP

The current version of Windows Server 2003 does not include network drivers for the Allied Telesis Gigabit Ethernet adapters. To do remote installation with PXE, include a network driver for the adapter as a part of the client's installation image on the server. Please refer to Microsoft Article ID Q246184 - "[How to Add Third-Party OEM Network Adapters to RIS Installations](#)." An example of this RIS installation to modify your inf file, refer to the troubleshooting section under [Software Problems and Solutions](#).

DOS UNDI/ APITEST

To boot in DOS and connect to a network for the DOS environment, download the Intel® PXE PDK from the Intel Web site. This PXE PDK comes with a TFTP/ProxyDHCP/Boot server. The PXE PDK can be downloaded from Intel at <http://developer.intel.com/ial/WfM/tools/pxe/index.htm>.

Red Hat Linux

Red Hat Linux 7.3 (or higher) distribution has PXE server support. It allows you to do a complete Linux installation over the network. Distribution also comes with boot images - boot kernel (vmlinuz) and initial ram disk (initrd). The following images can be found on the Red Hat distribution CD-ROM disk#1:

```
/images/pxeboot/vmlinuz
```

```
/images/pxeboot/initrd.img
```

Refer to Red Hat documentation for how to install PXE server on Linux. In this version, it prompts you to insert a driver disk for drivers that are not part of the standard distribution. You can create a driver disk for the adapter from the image distributed on the Allied Telesis web site.

A remote boot does not require a standard Linux network driver for the adapter. After the PXE client downloads the Linux kernel and initial ram disk, the Linux universal driver that came with the Linux distribution binds with the UNDI code of the PXE to form a Linux network driver.

Chapter 10

Troubleshooting

This chapter describes troubleshooting procedures and contains the following sections:

- ❑ “Hardware Diagnostics” on page 108
- ❑ “Checking Port LEDs on the Adapter” on page 109
- ❑ “Troubleshooting Checklist” on page 110
- ❑ “Verifying the Correct Drivers are Loaded” on page 111
- ❑ “Testing Network Connectivity” on page 112
- ❑ “Software Problems and Solutions” on page 115

Hardware Diagnostics

Loopback diagnostic tests are available for testing the adapter hardware under Windows. These tests provide access to the adapter's internal or external diagnostics, where packet information is transmitted across the physical link.

Checking Port LEDs on the Adapter

The adapter has two LEDs: LINK and ACT. The LINK LED indicates an active link and the ACT (Activity) LED indicates data transfer status. Once the driver is loaded and the cables are connected properly, the LINK LED is lit and the ACT LED is on if data traffic is present.

Before the port LEDs can provide troubleshooting information, the adapter must be connected to the network (see Chapter 2, “Installing the Hardware” on page 21) and the network drivers for your particular operating system must be installed.

1. Verify that the adapter driver software has been installed and that the adapter is connected to a network.
2. Check to see that the LEDs operate as described in Table 5.

Table 5. Fiber Optic Port LED Status

LED	State	Description
LINK	On	Valid fiber link.
	Off	No fiber link.
ACT	Blinking	Data traffic is present between the card and the switch.
	Off	Data traffic is not present.

Troubleshooting Checklist

The following checklist provides recommended actions to take to resolve problems installing the Allied Telesis AT-29xx Series Gigabit Ethernet Network adapter or running it in your system.



Warning

Before opening the cabinet of your system for removing or inserting the adapter, please review all precautions outlined under “Reviewing Safety Precautions” on page 22.

- Inspect all cables and connections. Verify that the cable connections between the adapter and the switch are attached properly. Make sure that the cable length and rating are compliant with the requirements listed in “Connecting the Network Cables” on page 29.”
- Check the adapter installation by reviewing Chapter 2, “Installing the Hardware” on page 21.
- Make sure that the adapter board is properly seated in a PCI slot. Check for specific hardware problems, such as obvious damage to board components or the PCI edge connector.
- Check the configuration settings and change them if they are in conflict with another device.
- Make sure that your system is using the latest BIOS.
- Try inserting the adapter in another slot. If the new position works, the original slot in your system may be defective.
- Replace the failed adapter with one that is known to work properly. If the second adapter works in the slot where the first one failed, the original adapter is probably defective.
- Install the adapter in another functioning system and run the tests again. If the adapter passed the tests in the new system, the original system may be defective.
- Remove all other adapters from the system and run the tests again. If the adapter passes the tests, the other adapters may be causing contention.

Verifying the Correct Drivers are Loaded

The following section describes how to check if the correct drivers are loaded for NetWare and Linux.

NetWare To verify that the NetWare driver software is loaded correctly, perform the following procedure.

1. To verify that the driver is loaded properly, type:

```
LOAD B57.LAN FRAME_ETHERNET_II NAME=B57_1_EII
```

This command automatically verifies if the link is active. If the link is active, it displays "Link is up".

2. From the command line, type **config** then press **Enter**.

The following status information is displayed:

```
Broadcom NetXtreme Gigabit Adapter
```

```
Version:
```

```
Hardware Setting:
```

```
Node Address:
```

```
Frame Type:
```

```
Board Name:
```

```
Lan Protocol: ARP (see note)
```

```
LAN Protocol: IP Addr: (see note)
```

Note

The LAN protocol status appears after assigning an IP address to the adapter (that is, bind).

Linux To verify that the Linux driver software is loaded correctly, perform the following procedure.

1. To verify that the tg3.o driver is loaded properly, run:

```
lsmod
```

If the driver is loaded, a line similar to the one below appears, where *<size>* is the size of the driver in bytes, and *<n>* is the number of adapters configured. See Table 6.

Table 6. Linux Driver Software Information

Module	Size	Used by
tg3	<i><size></i>	<i><n></i>

Testing Network Connectivity

The following section describes how to test network connectivity for Windows Server 2003, NetWare, and Linux networks.

Note

When using forced link speeds, make sure that both the adapter and the switch are forced to the same speed. Or, make sure at least one link partner is configured for Auto-Negotiation.

Windows Server 2003

To test the network connectivity for the Windows Server 2003 driver software, perform the following procedure.

Use the ping command to determine if network connectivity is working.

1. Select **Run** from the Windows Control Panel

The Run command window opens, as shown in Figure 22.

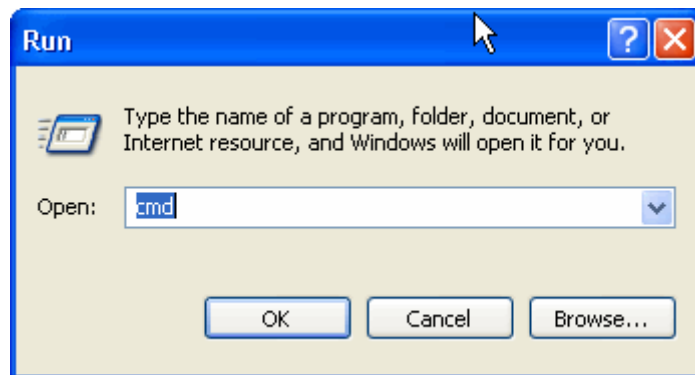

Figure 22. Run Command Window

2. Type **cmd** and click **OK**.
3. Type **ipconfig /all**

The command window opens, as shown in Figure 23 on page 113.

```

C:\WINDOWS\system32\cmd.exe
C:\Documents and Settings\Administrator>ipconfig /all

Windows IP Configuration

    Host Name . . . . . : whqlxp2
    Primary Dns Suffix . . . . . :
    Node Type . . . . . : Unknown
    IP Routing Enabled. . . . . : No
    WINS Proxy Enabled. . . . . : No

Ethernet adapter Local Area Connection 25:

    Connection-specific DNS Suffix . . :
    Description . . . . . : Allied Telesyn AT-2931SX Gigabit Ethernet Adapter
    Physical Address. . . . . : 00-0C-46-6F-53-11
    Dhcp Enabled. . . . . : Yes
    Autoconfiguration Enabled . . . . . : Yes
    IP Address. . . . . : 10.220.50.11
    Subnet Mask . . . . . : 255.255.255.0
    Default Gateway . . . . . : 10.220.50.1
    DHCP Server . . . . . : 10.220.50.1
    DNS Servers . . . . . : 10.220.50.1
    Lease Obtained. . . . . : Tuesday, March 01, 2005 11:52:53 AM
    Lease Expires . . . . . : Friday, March 04, 2005 1:32:53 AM

C:\Documents and Settings\Administrator>

```

Figure 23. Command Window with pconfig/all displayed

4. Type **ping <IP address>** from the command line, then press **Enter**.

The network connectivity information is displayed, as shown in Figure 24.

```

C:\WINNT\System32\cmd.exe
C:\>ping 172.16.10.6

Pinging 172.16.10.6 with 32 bytes of data:
Reply from 172.16.10.6: bytes=32 time<10ms TTL=128
Reply from 172.16.10.6: bytes=32 time<10ms TTL=128
Reply from 172.16.10.6: bytes=32 time<10ms TTL=128
Reply from 172.16.10.6: bytes=32 time<10ms TTL=128

C:\>

```

Figure 24. Command Window with ping displayed

NetWare To ping an IP host on the network to verify a connection has been established, perform the following procedure.

1. From the command line, type **ping <IP address>**, then press Enter.

This command displays the packet send/receive status.

Linux To verify that the Ethernet interface is up and running, run `ifconfig` to check the status of the Ethernet interface. In addition, you can also use the `netstat -i` command to check the statistics on the Ethernet interface. Consult the manual pages for more information about the `ifconfig` and `netstat` commands.

To ping an IP host on the network to verify connection has been established, perform the following procedure.

1. From the command line, type **ping <IP address>**. Then press Enter.

This command displays the packet send/receive status.

Software Problems and Solutions

Microsoft Remote Installation Service (RIS) Instructions

Problem: Microsoft Remote Installation Service (RIS) installation fails for Windows XP.

Solution: Refer to Microsoft Article Q246184, "How to Add Third-Party OEM Network Adapters to RIS Installations."

Windows XP Image

To deploy a Windows XP Image, follow the steps in the Microsoft Article Q246184 at <http://support.microsoft.com/default.aspx?scid=kb%3ben-us%3b246184>.

Windows Server 2003

This section lists known problems and solutions when Windows Server 2003.

Problem: IP address is configurable on a member of the team.

Solution: When a team is created, the TCP/IP properties for the adapters are unselected. Then you can select and configure TCP/IP properties of the adapters and configure an IP address manually.

Problem: When creating 64 VLANs, all virtual adapters show disconnected or one of the 64 VLANs show disabled.

Solution: The maximum VLAN configurations are 63 tagged and one untagged VLAN ID 0. If 64 tagged VLANs are created, they are disconnected. A reboot is required and only 63 tagged VLANs show links, while a 64th is disabled.

Miscellaneous

The following table lists known miscellaneous problems and solutions:

Problem: When the bus on the system is operating at PCI mode, the adapter performs at PCI mode if it is added by the Hot Plug application.

Solution: When the system is booted up without an adapter, the bus operates at the lowest mode which is PCI. This problem can be corrected by rebooting the system.

Problem: The adapter may not perform at optimal level when it is added by the Hot Plug application on some systems.

Solution: The system BIOS, in some systems, does not set the cache line size and the latency timer, after the adapter is added by the Hot Plug application. This problem can be corrected by rebooting the system.

Problem: The adapter cannot be seen on the PCI BUS.

Solution: This is because some of the older servers are advertising themselves as PCI-X capable systems. This causes the adapter to operate in PCI-X mode; therefore, it is not seen by the PCI bus. This problem can be corrected by configuring the firmware to operate in forced pci mode. Refer to b57diag for configuration instructions.

Chapter 11

DOS Diagnostics

This chapter describes the DOS diagnostics and contains the following sections:

- ❑ “Introduction” on page 118
- ❑ “DOS Prompt Commands” on page 119
- ❑ “Diagnostic Tests” on page 120
- ❑ “Error Messages” on page 127

Introduction

This chapter describes how to use the DOS diagnostic utilities program on an Allied Telesis AT-29xx Series Gigabit Ethernet Network adapter. As a prerequisite, the AT-29xx DOS Diagnostics requires a bootable DOS partition.

You can enter a command from the DOS prompt or the command line interface (CLI) prompt. Otherwise, the parameter is used as an executable command and then exits the program.

For the latest DOS diagnostics and User Guide, visit the www.alliedtelesis.com/support/software website.

DOS Prompt Commands

Table 7 lists the DOS prompt commands.

Table 7. DOS Prompt Commands

Command	Description
-c <num>	Specify adapter to be tested and/or modified
-cmd	Enter command mode
-w <value>	Enable/Disable (value = 1/0) WOL in manufacture mode
-mba <value>	Option to select MBA protocol 0 = Disable 1 = Enable
-mbap <value>	Option to select MBA protocol 0 = PXE 1 = RPL 2 = BOOTP
-mbas <value>	Option to select MBA speed 0 = auto 1 = 10HD 2 = 10FD 3 = 100HD 4 = 100FD 6 = 1000FD (fiber)
-firm <file name>	Update devices eeprom based on <file name> image match to HW
-ver	Version of the current software/ eeprom.bin
-pxe <file name>	Programming PXE firmware from file
-elog <file name>	Output error to log file

Diagnostic Tests

The tests are divided into four groups: Register Tests, Memory Tests, Miscellaneous Tests, and Data Tests. They are named group 'A', 'B', 'C', and 'D'.

Test Names This section lists the groups and the names of the diagnostics tests.

Group A.

- A1. Indirect Register Test
- A2. Control Register Test
- A3. Interrupt Test
- A4. BIST
- A5. PCI Cfg Register Test

Group B.

- B1. Scratch Pad Test
- B2. BD SRAM Test
- B3. DMA SRAM Test
- B4. MBUF SRAM Test
- B5. MBUF SRAM via DMA Test
- B6. External SRAM Test

Group C.

- C1. EEPROM Test
- C2. CPU Test
- C3. DMA Test
- C4. MII Test
- C5. VPD Test
- C6. ASF Test
- C7. ROM Expansion Test

Group D.

- D1. Mac Loopback Test
- D2. Phy Loopback Test
- D3. RJ45 Loopback Test
- D4. MII Miscellaneous Test
- D5. MSI Test

Test Descriptions This section provides descriptions of the diagnostic tests.

A1. Indirect Register Test

Function: Using indirect addressing method, writing increment data into MAC hash Register table and read back for verification. The memory read/write is done 100 times while increment test data.

Default: Test Enabled

A2. Control Register Test

Function: Each Register specified in the configuration contents read only bit and read/write bit defines. The test writing zero and one into the test bits to insure the read only bits are not changed, and read/write bits are changed accordingly.

Default: Test Enabled.

A3. Interrupt Test

Function: This test verifies the interrupt functionality. It enables interrupt and waits for interrupt to occur. It waits for 500ms and reports error if could not generate interrupts.

Default: Enabled

A4. BIST

Function: Hardware Built-In-Self-Test (BIST). This test initiates BIST and waits for the test result returned by hardware.

Default: Due to the intermittent failure, this test is currently disabled by default.

A5. PCI Cfg Register Test

Function: This test verifies the access integrity of the PCI config registers.

B1. Scratch Pad Test

Function: This test tests the scratch pad SRAM on board. The following tests are performed:

Data Pattern Test: Writes test data into the SRAM and reads it back to ensure data is correct. The test data used is 0x00000000, 0xFFFFFFFF, 0xAA55AA55, and 0x55AA55AA.

Alternate Data Pattern Test: Writes test data into the SRAM. Writes complement test data into the next address. Reads back both to insure the

data is correct. After the test, the program reads back data one more time to insure the data stays correct. The test data used is 0x00000000, 0xFFFFFFFF, 0xAA55AA55, and 0x55AA55AA.

Address Test: Writes each address with unique increment data. Read back data to insure data is correct. After fill the entire data with the unique data, the program reads back data again to insure data stays the same.

WalkingOne bit Test: For each address, data one is written and read back for testing. Then shift the data left one bit, so the data becomes two and perform the same test again. It repeats for 32 times until the test bit is shifted out of test data. The same is test is repeated for entire test range.

Pseudo Random Data Test: A pre-calculated pseudo random data is used to write a unique data into each test RAM. After the first pass the test, the program reads back one more time to insure data stays correct.

Default: Enabled

B2. BD SRAM Test

Function: This test tests the BD SRAM. This performs exact the same way of testing as described in B1. Scratch Pad Test.

Default: Enabled

B3. DMA SRAM Test

Function: It tests DMA SRAM by performing the tests described in test B1. The Scratch Pad Test.

Default: Enabled

B4. MBUF SRAM Test

Function: It tests DMA SRAM by performing the tests described in test B1. The Scratch Pad Test.

Default: Enabled

B5. MBUF SRAM via DMA Test

Function: Eight test pattern data are used in the test. They are described below. A 0x1000 sized data buffer is used for this test. Before each pattern test, the buffer is initialized and filled with the test pattern. It then performs size 0x1000 transmit DMA from host buffer to NIC MBUF memory. Verify the data integrity in MBUF against host memory and repeat the DMA for the entire MBUF buffer. Then it performs receive DMA from NIC to host. The 0x1000-byte test buffer is cleared to zero before each receive-DMA. Verify the data integrity and test is repeated for the entire MBUF SRAM range. See Table 8 on page 123.

Table 8. DMA Test Patterns

Test Pattern	Description
"16 00's 16 FF's"	Full the entire host DMA buffer with 16 bytes of 00's and then 16 bytes of FF's.
"16 FF's 16 0's"	Full the entire host DMA buffer with 16 bytes of FF's and then 16 bytes of 00's.
"32 00's 32 FF's"	Full the entire host DMA buffer with 32 bytes of 00's and then 32 bytes of FF's.
"32 FF's 32 00's"	Full the entire host DMA buffer with 32 bytes of FF's and then 32 bytes of 00's.
"00000000's"	Full the entire host DMA buffer with all zeros.
"FFFFFFFF's"	Full the entire host DMA buffer with all FF's.
"AA55AA55's"	Full the entire host DMA buffer with data 0xAA55AA55.
"55AA55AA's"	Full the entire host DMA buffer with data 0xAA55AA55.

Default: Enabled

B6. External SRAM Test

Function: It tests DMA SRAM by performing the tests described in test B1. The Scratch Pad Test.

Default: Disabled

C1. EEPROM Test

Function: An increment test data is used in EEPROM test. It fills the test data into the test range and read back to verify the content. After the test, it fills data with zero to clear the memory.

Default: Enabled

C2. CPU Test

Function: This test opens the file cpu.bin. If file exists and content is good, it loads code to rx and tx CPU and verifies CPU execution.

Default: Enabled

C3. DMA Test

Function: Both high and low priorities DMA are tested. It moves data from the host memory to NIC SRAM, verifies data, and then moves data back to the host memory again to verify data.

Default: Enabled

C4. MII Test

Function: The function is identical to A2. Control Register Test. The test writing zero and one into the test bits to insure the read only bits value are not changed, and read/write bits are changed accordingly.

Default: Test Enabled.

The test attempts to read the register configuration file 'miireg.txt' for the register defines. If the file does not exist, the following table is used. See Table 9.

Table 9. Default Register

Offset	R/O Mask	R/W Mask
0x00	0x0000	0x7180
0x02	0xffff	0x0000
0x03	0xffff	0x0000
0x04	0x0000	0xffff
0x05	0xefff	0x0000
0x06	0x0001	0x0000
0x07	0x0800	0xb7ff
0x08	0xffff	0x0000
0x09	0x0000	0xff00
0x0a	0x7c00	0x0000
0x10	0x0000	0xffbf
0x11	0x3300	0x0000
0x19	0x001f	0x0000
0x1e	0x0000	0xffff
0x1f	0x0000	0xffff

C5. VPD Test

Function: It saves the content of VPD first before perform the test. Once it is done, it writes one of the five pattern test data, 0xFF, 0xAA, 0x55, increment data, or decrement data, into VPD memory. By default, increment data pattern is used. It writes and reads back the data for the entire test range, and then restores the original content.

Default: Disabled

C6. ASF Test

Function: m

1. Reset test.

Setting reset bit, poll for self-clearing. Verify reset value of registers.

2. Event Mapping Test

Setting SMB_ATTEN bit. By changing ASF_ATTEN LOC bits, verify the mapping bits in TX_CPU or RX_CPU event bits.

3. Counter Test

Clear WG_TO, HB_TO, PA_TO, PL_TO, RT_TO bits by setting those bits. Make sure the bits clear.

Clear Timestamp Counter. Writing a value 1 into each PL, PA, HB, WG, RT counters. Set TSC_EN bit.

Poll each PA_TO bit and count up to 50 times. Check if PL_TO gets set at the end of 50 times. Continue to count up to 200 times. Check if all other TO bits are set and verify Timestamp Counter is incremented.

C7. ROM Expansion Test

Function: This function tests the ability to enable/disable/access the expansion ROM on the device.

D1. Mac Loopback Test

Function: This is internal loopback data transmit/receive test. It initializes the MAC into internal loopback mode and transmits 100 packets. The data should be routed back to the receive channel and received by the receive routine which verifies the integrity of data. One Gigabit rate is used for this test.

Default: Enabled

D2. Phy Loopback Test

Function: This test is same as D1. Mac Loopback Test except, the data is routed back via physical layer device. One Giga bit rate is used for this test.

Default: Enabled

D3. RJ45 Loopback Test

Function: This is external loopback test. From the UUT point of view, no loopback mode is configured. The data expected to be routed back by RJ45 loopback connector. 100M/s and 1000M/s are used for this test.

Default: Disabled

D4. MII Miscellaneous Test

Function: This function tests the auto-polling and phy-interrupt capabilities.

Default: Enabled

D5. MSI Test

Function:

Default: Disabled

Error Messages

```
/* 0 */ "PASS",
/* 1 */ "Got 0x%08X @ 0x%08X. Expected 0x%08X",
/* 2 */ "Cannot perform task while chip is running",
/* 3 */ "Invalid NIC device",
/* 4 */ "Read only bit %s got changed after writing zero at
offset 0x%X",
/* 5 */ "Read only bit %s got changed after writing one at
offset 0x%X",
/* 6 */ "Read/write bit %s did not get cleared after writing
zero at offset 0x%X",
/* 7 */ "Read/write bit %s did not get set after writing one
at offset 0x%X",
/* 8 */ "BIST failed",
/* 9 */ "Could not generate interrupt",
/* 10 */ "Aborted by user",
/* 11 */ "Tx DMA:Got 0x%08X @ 0x%08X. Expected 0x%08X",
/* 12 */ "Rx DMA:Got 0x%08X @ 0x%08X. Expected 0x%08X",
/* 13 */ "Tx DMA failed",
/* 14 */ "Rx DMA failed",
/* 15 */ "Data error, got 0x%08X at 0x%08X, expected
0x%08X",
/* 16 */ "Second read error, got 0x%08X at 0x%08X, expected
0x%08X",
/* 17 */ "Failed writing EEPROM at 0x%04X",
/* 18 */ "Failed reading EEPROM at 0x%04X",
/* 19 */ "EEPROM data error, got 0x08X at 0x04X, expected
0x%08X",
/* 20 */ "Cannot open file %s",
/* 21 */ "Invalid CPU image file %s",
/* 22 */ "Invalid CPU image size %d",
/* 23 */ "Cannot allocate memory",
```

```

/* 24 */ "Cannot reset CPU",
/* 25 */ "Cannot release CPU",
/* 26 */ "CPU test failed",
/* 27 */ "Invalid Test Address Range\nInvalid NIC address is
        0x%08X-0x%08X and exclude 0x%08X-0x%08X",
/* 28 */      "DMA:Got 0x%08X @ 0x%08X. Expected 0x%08X",
/* 29 */ "Unsupported PhyId %04X:%04X",
/* 30 */ "Too many registers specified in the file, max is
        %d",
/* 31 */ "Cannot write to VPD memory",
/* 32 */ "VPD data error, got %08X @ 0x04X, expected %08X",
/* 33 */ "No good link! Check Loopback plug",
/* 34 */ "Cannot TX Packet!",
/* 35 */ "Requested to Tx %d. Only %d is transmitted",
/* 36 */ "Expected %d packets. Only %d good packet(s) have
        been received\n%d unknown packets have been
        received.\n%d bad packets have been
        received.",
/* 37 */ "%c%d is an invalid Test",
/* 38 */ "EEPROM checksum error",
/* 39 */ "Error in reading WOL/PXE",
/* 40 */ "Error in writing WOL/PXE",
/* 41 */ "No external memory detected",
/* 42 */ "DMA buffer %04X is large, size must be less than
        %04X",
/* 43 */ "File size %d is too big, max is %d",
/* 44 */ "Invalid %s",
/* 45 */ "Failed writing 0x%x to 0x%x",
/* 46 */ "",
/* 47 */ "Ambiguous command",
/* 48 */ "Unknown command",
/* 49 */ "Invalid option",

```



```
/* 50 */ "Cannot perform task while chip is not running.  
        (need driver)",  
/* 51 */ "Cannot open register define file or content is  
        bad",  
/* 52 */ "ASF Reset bit did not self-cleared",  
/* 53 */ "ATTN_LOC %d cannot be mapped to %cX CPU event bit  
        %d",  
/* 54 */ "%s Register is not cleared to zero after reset",  
/* 55 */ "Cannot start poll_ASF Timer",  
/* 56 */ "poll_ASF bit did not get reset after  
        acknowledged",  
/* 57 */ "Timestamp Counter is not counting",  
/* 58 */ "%s Timer is not working",  
/* 59 */ "Cannot clear bit %s in %cX CPU event register",  
/* 60 */ "Invalid "EEPROM_FILENAME" file size, expected %d  
        but only can read %d bytes",  
/* 61 */ "Invalid magic value in %s, expected %08x but found  
        %08x",  
/* 62 */ "Invalid manufacture revision, expected %c but  
        found %c",  
/* 63 */ "Invalid Boot Code revision, expected %d.%d but  
        found %d.%d",  
/* 64 */ "Cannot write to EEPROM",  
/* 65 */ "Cannot read from EEPROM",  
/* 66 */ "Invalid Checksum",  
/* 67 */ "Invalid Magic value",  
/* 68 */ "Invalid MAC address, expected %02X-%02X-%02X-%02X-  
        %02X-%02X",  
/* 69 */ "Slot error, expected an UUT to be found at  
        location %02X:%02X:00",  
/* 70 */ "Adjacent memory has been corrupted while testing  
        block 0x%08x-0x%08x\nGot 0x%08x @ address  
        0x%08x. Expected 0x%08x",  
/* 71 */ "The function is not Supported in this chip",  
/* 72 */ "Packets received with CRC error",
```

```
/* 73 */ "MII error bits set: %04x",  
/* 74 */ "CPU does not initialize MAC address register  
correctly",  
/* 75 */ "Invalid firmware file format",  
/* 76 */ "Resetting TX CPU Failed",  
/* 77 */ "Resetting RX CPU Failed",  
/* 78 */ "Invalid MAC address",  
/* 79 */ "Mac address registers are not initialized  
correctly",  
/* 80 */ "EEPROM Bootstrap checksum error",
```

Appendix A

Specifications

Physical Specifications

This section lists the dimensions and weights of all of the AT-29xx Series adapters.

Dimensions: AT-2916SX: 11.98 cm x 6.4 cm (4.72 in x 2.53 in)
AT-2916LX10/LC-901: 11.98 cm x 6.4 cm (4.72 in x 2.53 in)
AT-2931SX: 16.75 cm x 6.4 cm (6.6 in x 2.53 in)
AT-2972SX: 16.75 cm x 6.8 cm (6.6 in x 2.67 in)
AT-2972SX/2: 16.8 cm x 6.8 cm (6.7 in x 2.7 in)
AT-2972T/2: 16.75 cm x 6.8 cm (6.6 in x 2.67 in)
AT-2972LX10/LC-901: 16.75 cm x 6.8 cm (6.6 in x 2.67 in)

Weight: AT-2916SX: 70 g (.15 lb)
AT-2916LX10/LC-901: 70 g (.15 lb)
AT-2931SX: 60 g (.12 lb)
AT-2972SX: 64 g (.14 lb)
AT-2972SX/2: 70 g (.15 lb)
AT-2972T/2: 64 g (.14 lb)
AT-2972LX10/LC-901: 64 g (.14 lb)

Environmental Specifications

The following environmental specifications apply to all of the AT-29xx Series adapters.

Operating Temperature: 0°C to 40°C (+32°F to +104°F)
Storage Temperature: -40°C to +70°C (-40°F to +158°F)
Operating Humidity: 5% to 85% (noncondensing) 40°C, 16 hour dwells at extremes
Storage Humidity: 5% to 95% (noncondensing) 10°C/hour
Operating Altitude Range: 10,000
Storage Altitude Range: 35,000 ft.

Operating Shock:	10g, 1/2 sine wave, 11 msec
Storage Shock:	60g, 1/2 sine wave, 11 msec
Operating vibration, peak to peak displacement	0.005 in. max (5 to 32 Hz)
Storage vibration, peak to peak displacement	0.1 in. max (5 to 17 Hz)
Operating vibration, peak acceleration:	0.25g (5 to 500 Hz) (Sweep Rate = 1 octave/ min.)
Storage vibration, peak acceleration	0.25g (5 to 500 Hz) (Sweep Rate = 1 octave/ min.)

Power Specifications

The operating voltage specification in this section applies to all of the AT-29xx Series adapters. The power consumption specifications apply to the individual adapter listed.

Operating Voltage: 3.3V +/-10%

Power Consumption: AT-2916SX: 3.86 Watts, 1.17A@ +3.3V
 AT-2916LX10/LC-901: 4.19 Watts, 1.27A @ +3.3V
 AT-2931SX: 3.86 Watts, 1.17A@ +3.3V
 AT-2972SX: 6.6 Watts, 2A@ +3.3V
 AT-2972SX/2: 7.26 Watts, 2A@ +3.3V
 AT-2972T/2: 7.26 Watts, 2A@ +3.3V
 AT-2972LX10/LC-901: 6.93 Watts, 2.1A@ +3.3V

Performance Specifications

The performance specifications in this section for PCI and PCI-X apply to all of the AT-29xx Series adapters. The PCI, PCI-X, and PCI-E specifications apply to the individual adapter listed.

PCI clock: 33/66 MHz max

PCI-X clock: 133 MHz

PCI or PCI-X Data/Address:	AT-2916SX	32-bit only
	AT-2916LX10/LC-901	32-bit only
	AT-2931SX	32-bit and 64-bit

PCI-E	AT-2972SX	4 channel
	AT-2972SX/2	4 channel
	AT-2972T/2	4 channel
	AT-2972LX10/LC-901	4 channel

Operating Specifications

The following operating specifications apply to all of the AT-29xx Series adapters.

Output Optical Power: -9.5 dBm minimum to -4 dBm maximum

Input Optical Power: -17 dBm to 0 dBm maximum

Receive Sensitivity: -12.5 dBm with 62.5 um fiber or
-13.5 dBm with 50 um fiber

Appendix B

Cleaning Fiber Optic Connectors

The fiber optic connector consists of a fiber optic plug and its adapter. The end of the fiber optic cable is held in the core of the ferrule in the plug. Light signals are transmitted through the core of the fiber. Even minor smudges or dirt on the end face of the fiber, completely invisible to the naked eye, can disrupt light transmission and lead to failure of the component or of the entire system. Therefore, it is of utmost importance to clean all fiber optic connectors before use.

Figure 25 shows the ferrule in an SC connector.

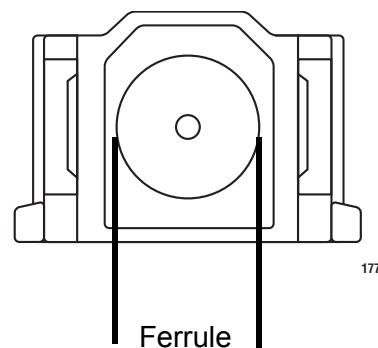

Figure 25. Ferrule in an SC Connector Plug

Figure 26 shows part of the end face of an unclean and clean ferrule.

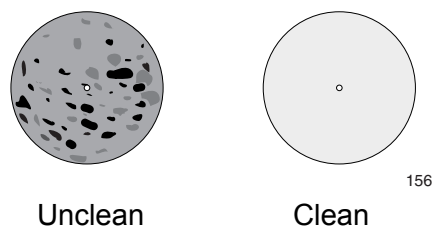

Figure 26. Unclean and Clean Ferrule

This appendix provides the following procedures

- ❑ “Using a Cartridge-Type Cleaner” on page 136
- ❑ “Using a Swab” on page 138

Using a Cartridge-Type Cleaner

Fiber optic cartridge cleaners are available from many vendors and are typically called “cartridge cleaners,” as shown in Figure 27.



Figure 27. Cartridge Cleaner

Note

Do not use compressed air or aerosol air to clean a fiber optic connector.

To clean a fiber optic connector using a cartridge cleaner, perform the following procedure.

1. With one hand, hold the cartridge cleaner and push the lever on the cleaning cartridge in the direction of the arrow to expose the cleaning surface, as shown in Figure 28.
2. Place the ferrule tip on the exposed cleaning surface and rub the ferrule in a downward direction, as shown in Figure 28.

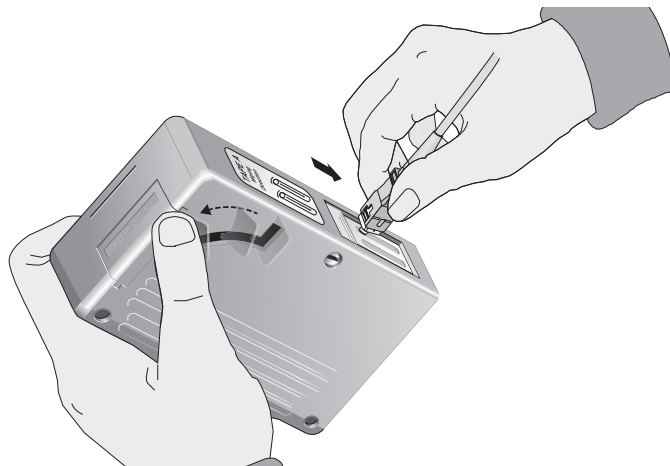

Figure 28. Rubbing the Ferrule Tip on the Cleaning Surface

Note

Rub the ferrule tip on the cleaning surface in one direction only.

3. When you reach the end of the cleaning surface, pick up the ferrule tip, rotate and place it at the top and rub downwards at least 2 times.



Caution

Failing to pick up the ferrule tip when you reach the bottom of the cleaning surface can result in static electricity that can damage the fiber optic cable.

4. If desired, repeat steps 3 and 4.
5. If a fiber inspection scope is available, use the scope to inspect the ferrule end face to make sure that it is clean.
6. Reconnect the cable to the port or protect the ferrule tip with a dust cap.

Note

Always keep a dust cap on a fiber optic cable when it is not in use.

Note

Do not touch the end face of the ferrule in the connector.



Warning

Do not stare into the laser beam. ⚠ L2



Warning

Do not look directly at the cable ends or inspect the cable ends with an optical lens. ⚠ E29

Using a Swab

Specially treated swabs (stick cleaners) are available for cleaning inside connector adapters or hard-to-reach ferrule tips. These swabs, often referred to as “lint free” or “alcohol free” swabs, are available from many vendors, as shown in Figure 29. Stick cleaners are available in both 2.5 mm and 1.25 mm sizes for use on SC and MU connectors respectively.

Note

NEVER use a household cotton swab and/or alcohol to clean a fiber optic connector. This may leave a residue on the ferrule tip.

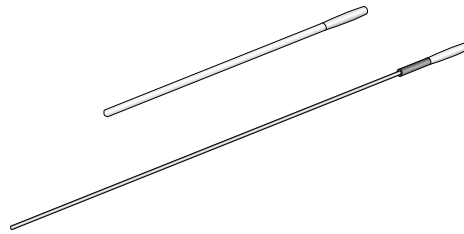

Figure 29. Lint-Free and Alcohol-Free Swabs

Note

Do not use compressed air or aerosol air to clean a fiber optic connector.

To clean a recessed ferrule using a swab, perform the following procedure.

1. Insert the swab into the adapter as shown in Figure 30 and rub the ferrule tip with the swab.

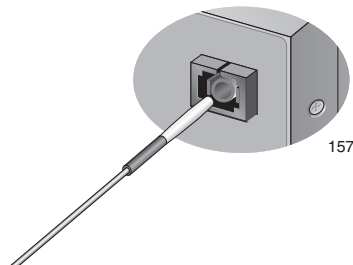

Figure 30. Cleaning a Recessed Ferrule

2. If desired, repeat step 1.

3. If a fiber inspection scope is available, use the scope to inspect the connector to make sure that it is clean and to check for scratches, pits, or other problems that may affect performance.

Note

Always keep a dust cap on a fiber optic cable when it is not in use.



Warning

Do not stare into the laser beam. ⚠ L2



Warning

Do not look directly at the cable ends or inspect the cable ends with an optical lens. ⚠ E29
