

Dolphin[™] 99EX

Mobile Computers for Use in Hazardous Locations

Dolphin 99EXLGX-XXXXXXXXXI

Dolphin 99EXLWX-XXXXXXXXXI

Dolphin 99EXL0X-XXXXXXXXXI

with Windows[®] Embedded Handheld 6.5

User's Guide

Disclaimer

Honeywell International Inc. (“HII”) reserves the right to make changes in specifications and other information contained in this document without prior notice, and the reader should in all cases consult HII to determine whether any such changes have been made. The information in this publication does not represent a commitment on the part of HII.

HII shall not be liable for technical or editorial errors or omissions contained herein; nor for incidental or consequential damages resulting from the furnishing, performance, or use of this material.

This document contains proprietary information that is protected by copyright. All rights are reserved. No part of this document may be photocopied, reproduced, or translated into another language without the prior written consent of HII.

Web Address: www.honeywellaidc.com

Trademarks

Dolphin is a trademark or registered trademark of Hand Held Products, Inc. in the United States and/or other countries.

Microsoft, Windows, Windows Mobile, Windows Phone, Windows Embedded Handheld, Windows CE, Windows 98 Second Edition, Windows NT, Windows 2000, Windows ME, Windows XP, Windows 7, Windows Vista, ActiveSync, Outlook, and the Windows logo are trademarks or registered trademarks of Microsoft Corporation.

The Bluetooth trademarks are owned by Bluetooth SIG, Inc., U.S.A. and licensed to Honeywell.

TORX is a trademark or registered trademark of Textron Inc.

MicroSD and microSDHC are trademarks or registered trademarks of SD-3C, LLC in the United States and/or other countries.

Other product names mentioned in this manual may be trademarks or registered trademarks of their respective companies and are the property of their respective owners.

Patents

For patent information, please refer to www.hsmpats.com.

©2012-2014 Honeywell International Inc. All rights reserved.



Table of Contents

Chapter 1 - Dolphin 99EX Terminal Agency Information

Laser Safety	1-1
Label Locations	1-1
Model Number, Serial Number and IMEI Labels.....	1-1
Laser Safety Label	1-1
Laser Safety Statement.....	1-2
LED Safety	1-2
LED Safety Statement.....	1-2
Infrared LED Safety Statement	1-2
UL and C-UL Statement.....	1-2
Equipment Intended for Use in Potentially Explosive Atmospheres	1-2
USA/Canada	1-2
International IEC	1-3
Europe.....	1-3
Approvals by Country.....	1-4
R&TTE Compliance Statement—802.11a/b/g/n, Bluetooth, and/or GSM.....	1-4
FCC Requirements	1-4
Dolphin RF Terminal—802.11a/b/g/n, Bluetooth, and/or GSM	1-4
Canadian Compliance.....	1-5
Conformité à la réglementation canadienne	1-5
RF Exposure Information (SAR)	1-5
Honeywell Scanning & Mobility Product Environmental Information.....	1-6
Hearing Aid Compatibility (HAC).....	1-6
Pacemakers, Hearing Aids and Other Electrically Powered Devices	1-7
Microwaves	1-7
China RoHs.....	1-7

Chapter 2 - Getting Started

Out of the Box	2-1
Equipment Intended for Use in Potentially Explosive Atmospheres	2-1
I/O Cover.....	2-2
Initial Setup	2-3
Before Initial Use.....	2-4
Using the Charging/Communication Cables	2-5
Replacing the Main Battery Pack.....	2-6
Home Screen	2-7
Title Bar.....	2-7
Icons in the Title Bar	2-7
Horizontal Scroll.....	2-10
Tile Bar.....	2-10
Pop-Up Menus	2-10
Selecting Programs.....	2-10
File Explorer	2-11
File Provisioning on the 99EX.....	2-12
Search.....	2-12

Resetting the Terminal	2-13
Soft Reset (Warm Boot).....	2-13
Hard Reset (Cold Boot)	2-13
Factory Reset	2-13
Suspend Mode	2-13

Chapter 3 - Hardware Overview

Standard Configurations for the 99EX Models Intended for Use in Potentially Explosive Atmospheres	3-1
Peripherals for the 99EX	3-3
Accessories for the 99EX	3-4
Front Panel: 99EX	3-5
Front Panel Features for the 99EX	3-5
Back Panel: 99EX.....	3-7
Back Panel Features for the 99EX	3-7
Side Panels: 99EX.....	3-9
Left Side	3-9
Right Side	3-9
Bottom Panel: 99EX	3-10
I/O Connector	3-10
Using the Touch Panel	3-11
Installing a Screen Protector.....	3-11
Batteries	3-11
Main Battery Pack.....	3-11
Internal Backup Battery	3-14
Managing Battery Power	3-15
Checking Battery Power	3-16
System Resets	3-16
Installing a Memory Card.....	3-17
Installing a SIM Card	3-17

Chapter 4 - Using the Scan Image Engine

Overview.....	4-1
Laser Safety	4-1
N5603 Beam Divergence Angle	4-1
LED Safety	4-1
Image Engine Specifications	4-1
Depth of Field	4-2
Supported Bar Code Symbologies	4-3
Decoding	4-4
To Decode a Bar Code.....	4-4
Aiming Options	4-4
Capturing Images	4-6
Taking an Image.....	4-6
Uploading Images.....	4-7

Chapter 5 - Using the Color Camera

Overview.....	5-1
Taking a picture using the Camera Demo tool	5-1
Taking a picture using the Windows Embedded Handheld 6.5 Camera tool	5-2
Recording Video	5-3

Chapter 6 - Using the Keyboards

Available Keyboards.....	6-1
Keyboard Combinations	6-1
Common Buttons.....	6-1
Using the Function Keys.....	6-2
Using the Modifier Keys	6-3
Using the Navigation Keys	6-3
34-Key Alpha/Numeric Keyboard	6-5
ALPHA Key.....	6-5
34-Key Alpha/Numeric Keyboard Combinations	6-6
34-Key Numeric (Calculator) Keyboard.....	6-8
ALPHA Key.....	6-8
34-Key Numeric (Calculator) Keyboard Combinations	6-9
43-Key Alpha/Numeric Keyboard	6-11
Number Lock (NUM) Key.....	6-11
43-Key Keyboard Combinations	6-12
55-Key Full Alpha/Numeric Keyboard	6-14
55-Key Keyboard Combinations	6-14

Chapter 7 - System Settings

Overview.....	7-1
Clock & Alarms	7-2
Personal Menu	7-3
Buttons.....	7-3
System Menu.....	7-7
About	7-8
Backlight	7-9
Battery	7-10
Certificates.....	7-10
Customer Feedback	7-10
Encryption.....	7-11
Error Reporting	7-11
External GPS	7-11
Five Volt Control	7-12
Smart Sensor.....	7-12
Managed Programs	7-14
Memory.....	7-15
RIL	7-16
Power.....	7-16
Regional Settings.....	7-16
Remove Programs.....	7-17

Screen	7-18
Task Manager.....	7-19

Chapter 8 - Communication

Connections Menu.....	8-1
Using the IrDA Port.....	8-2
IrDA Port Location	8-2
Sending Data	8-2
Receiving Data	8-3
Connections Manager	8-4
To Access the Connections Manager.....	8-4
Tasks	8-4
Advanced.....	8-5
Dolphin Wireless Manager	8-6
Dolphin Wireless Manager Window.....	8-6
Enabling the Radios.....	8-6
Accessing Radio Configuration Utilities.....	8-7
Network Cards.....	8-8
Connecting and Synchronizing the Terminal and Workstation.....	8-8
Installing Additional Software	8-10
Adding Programs Using ActiveSync or Windows Mobile Device Center.....	8-11
Connecting the Terminal to a Wireless Network.....	8-12
Adding Programs Using the Internet.....	8-12
Software Upgrades.....	8-12
99EX COM Port Assignment Table	8-13

Chapter 9 - Working with Wireless Wide Area Networking (WWAN)

Overview.....	9-1
Penta Band Antenna.....	9-1
SIM Card Installation	9-3
Installing a SIM Card	9-4
Enabling the WWAN Radio	9-5
GSM/HSPA+ Global Radio Dolphin Models.....	9-5
Voice Communication.....	9-5
Audio Modes.....	9-5
Volume Control.....	9-6
Accessing the Dialer Window	9-6
Dialing.....	9-6
Sending Calls.....	9-7
Ending Calls.....	9-7
Accessing Voice Mail.....	9-7
View Options.....	9-7
Setup Options.....	9-7
Data Communication (GSM/HSPA+ Global Radio Dolphin Models).....	9-9
System Requirements	9-9
Information Requirements	9-9
Establishing Data Communication.....	9-9
Manual Network Selection.....	9-11

Data Communication GSM/CDMA Dolphin Models	9-13
Gobi Manager	9-13
Establishing Data Communication.....	9-14

Chapter 10 - Working with the Bluetooth Radio

Enabling the Bluetooth Radio	10-1
Pairing and Trusted Devices	10-2
Connecting to Other Bluetooth Devices	10-2
Transferring Files.....	10-5
Making the Terminal Discoverable	10-6
Selecting COM Ports	10-6

Chapter 11 - Working with GPS

Overview.....	11-1
Assisted GPS Support.....	11-1
Powering the GPS Module	11-1
Communication Ports	11-1
Selecting the Port	11-1
COM7	11-1
GPS Intermediate Driver.....	11-2
GPS Demo	11-2

Chapter 12 - Dolphin 99EX HomeBase Device (Model 99EX-HB)

Overview.....	12-1
Unpacking the HomeBase	12-1
Parts and Functions.....	12-2
Bottom Panel	12-5
Power	12-5
Connecting Power to the HomeBase.....	12-5
Charging the Main Battery.....	12-6
To Power a Terminal and Charge its Main Battery.....	12-6
Charging a Spare Battery in the Auxiliary Battery Well	12-6
Communication.....	12-7
Connecting the Communication Cables	12-7
Establishing Communication	12-7
Communicating with the Dolphin Terminal	12-7
Verifying Data Transfer.....	12-8
RS232 Communications Cables.....	12-8
RS232 Pin Configuration	12-8
Serial Connector.....	12-9
Mounting the HomeBase	12-9
Desk Mounting.....	12-9

Chapter 13 - Dolphin 99EX eBase Device (Model 99EX-EHB)

Overview.....	13-1
Unpacking the eBase.....	13-1

Parts and Functions.....	13-2
Front Panel	13-2
Back Panel	13-4
Bottom Panel	13-5
Power	13-5
Connecting Power to the eBase	13-5
Charging the Main Battery.....	13-6
To Power a Terminal and Charge its Main Battery.....	13-6
Charging a Spare Battery in the Auxiliary Battery Well	13-6
Communication.....	13-7
Software Requirements	13-7
Establishing Ethernet Communication.....	13-7
Establishing USB Communication	13-8
Mounting the eBase.....	13-8
Desk Mounting.....	13-8

Chapter 14 - Dolphin 99EX Mobile Base Device (Model 99EX-MB)

Overview.....	14-1
Front Panel	14-2
Bottom Panel	14-3
Back Panel and Mounting Brackets.....	14-4
Mounting.....	14-5
Safety Precautions.....	14-5
Installation.....	14-5
Powering the Dolphin Terminal	14-6
Charging the Dolphin Terminal.....	14-6
Establishing Communication	14-6
Connecting the Communication Cables	14-6
Establishing ActiveSync or Windows Mobile Device Center Communication	14-7
RS232 Communication Cables	14-7
Serial Connector.....	14-8

Chapter 15 - Dolphin 99EX ChargeBase Device (Model 99EX-CB)

Overview.....	15-1
Unpacking the ChargeBase.....	15-1
Parts and Functions.....	15-2
Front Panel	15-2
Back Panel.....	15-3
Power	15-3
Connecting Power to the ChargeBase	15-3
Charging the Main Battery.....	15-4
To Power a Terminal and Charge its Main Battery.....	15-4
Mounting the ChargeBase.....	15-4
Channel Bracket Installation (Pre-existing Hardware Installations).....	15-8
Removing Power to the ChargeBase	15-11

Chapter 16 - Dolphin 99EX Net Base Device (Model 99EX-NB)

Overview.....	16-1
Parts and Functions.....	16-2
Front Panel	16-2
Back Panel	16-3
Bottom Panel	16-4
Power	16-4
Connecting Power to the Net Base.....	16-5
Charging the Main Battery.....	16-5
To Power a Terminal and Charge its Main Battery.....	16-5
Communication.....	16-6
Software Requirements	16-6
Connecting the Dolphin Terminal to the Net Base	16-6
Mounting the Net Base	16-7
Channel Bracket Installation (Pre-existing Hardware Installations).....	16-11
Removing Power to the Net Base	16-13

Chapter 17 - Dolphin 99EX QuadCharger Device (Model 99EX-QC)

Overview.....	17-1
Unpacking the QuadCharger.....	17-1
Parts and Functions.....	17-2
Supplying Power.....	17-3
Inserting and Charging Batteries	17-3
Mounting the QuadCharger	17-4
Troubleshooting.....	17-5

Chapter 18 - Customer Support

Product Service and Repair.....	18-1
Technical Assistance.....	18-1
Limited Warranty	18-1
How to Extend Your Warranty	18-2



Dolphin 99EX Terminal Agency Information

Dolphin 99EX mobile computers intended for use in potentially explosive atmospheres meet or exceed the requirements of all applicable standards organizations for safe operation. However, as with any electrical equipment, the best way to ensure safe operation is to operate them according to the agency guidelines that follow. Read these guidelines carefully before using your Dolphin terminal.

This documentation is only relevant for Dolphin models intended for use in potentially explosive atmospheres (**99EXXXX-XXXXXXXI** Models).



CAUTION - Read the Guidelines for Battery Pack Use and Disposal on page 3-14 and all cautionary markings on the battery, charging peripheral, or device using the battery before attempting to install, use, or charge the battery. Risk of fire and burns if improperly handled. Do not open, crush, heat above 60°C (140°F), or incinerate.

Laser Safety

Label Locations

Dolphin 99EX with WLAN

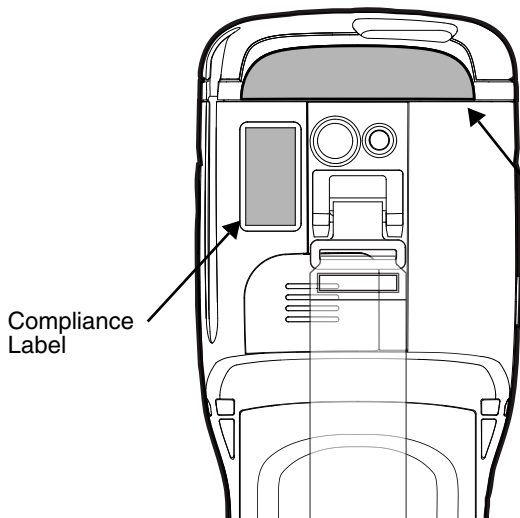

Dolphin 99EX with WWAN

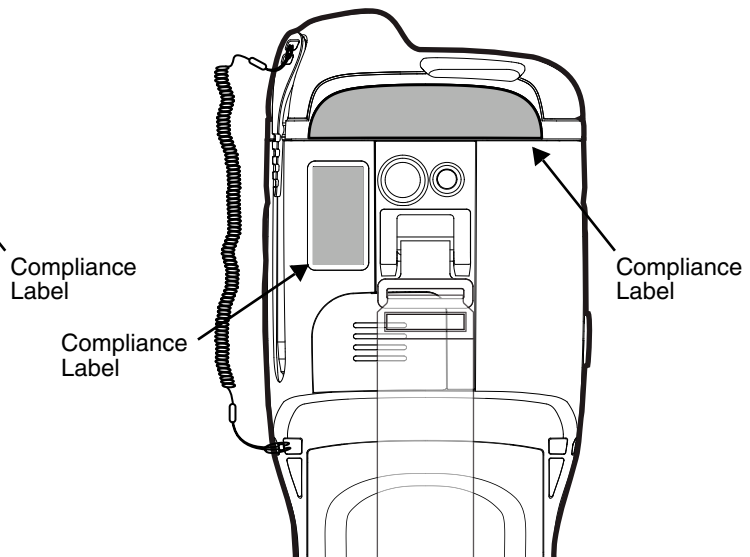

Model Number, Serial Number and IMEI Labels

The model (item) number, serial number, and international mobile equipment identity (IMEI) number for the terminal are located on labels affixed to the bottom of the battery well.

Laser Safety Label

If the following label is attached to your product, it indicates the product contains an engine with a laser aimer:

Image Engines with Integrated Laser Aimers



Laser Safety Statement

This device has been tested in accordance with and complies with IEC60825-1(Ed. 2.0), EN60825-1:2007. Complies with 21 CFR 1040.10 and 1040.11, except for deviations pursuant to Laser Notice No. 50, dated June 24, 2007. LASER LIGHT, DO NOT STARE INTO BEAM. CLASS 2 LASER PRODUCT, 1.0 mW MAX OUTPUT: 650nm, pulse duration of 15.5msec.



WARNING - Use of controls or adjustments or performance of procedures other than those specified herein may result in hazardous radiation exposure.

LED Safety

LED Safety Statement

LEDs have been tested and classified as “EXEMPT RISK GROUP” to the Standard: IEC 62471:2006.

Infrared LED Safety Statement

Caution! Do not view directly with optical instruments.

UL and C-UL Statement

UL and C-UL listed: UL60950-1 2nd Edition and CSA C22.2 No. 60950-1-07 2nd Edition.

Underwriters Laboratories Inc. (UL) has not tested the performance or reliability of the global positioning system (GPS) hardware, GPS operating software or other GPS-related aspects of this product. UL has only tested for the explosion, fire, shock, and casualty hazards required by the applicable hazardous locations standards. UL certification does not cover the performance or reliability of the GPS hardware, GPS operating software, or other GPS-related aspects of this product. UL makes no representations, warranties, or certifications whatsoever regarding the performance or reliability of any GPS-related functions of this product.

Equipment Intended for Use in Potentially Explosive Atmospheres

The following information is relevant for Dolphin 99EX Mobile Computers intended for use in potentially explosive atmospheres (Models **99EXXXX-XXXXXXXXI**). The model (item) number for the terminal is located on a label affixed to the bottom of the battery well.

Note: Equipment intended for use in potentially explosive atmospheres is identifiable by specific labeling located on the back panel of the device. See [Label Locations](#) on page 1-1.

USA/Canada

This equipment is suitable for use in the following hazardous locations, or unclassified locations, or non-hazardous locations only.

Class I, Division 2, Groups A, B, C, D, (Class I Div 2 US and Canada)

Class II, Division 2, Groups F, G (Class II Div 2 US and Canada)

Temperature Code T6

Ambient Temperature Range: -20° to 50°C

USA: ANSI/ISA 12.12.01: 2011

Canada: CSA C22.2 No 213-M1987 (R2008), CSA C22.2 No 25-1966 (R2004)

IP67

International IEC



IEC 60079-0:2011, IEC 60079-11:2011

Europe

EN 60079-0:2012, EN 60079-11:2012

ATEX Directive

This product conforms with the requirement of ATEX directive. The ATEX Directive 94/9/EC is a European CE Mark directive concerning products that are designed for use in potentially explosive environments.

  II 3 G D
Ex ic IIC T6 Gc
Ex ic IIIB T88°C Dc
Tamb -20° to 50°C

Where . . .	indicates . . .
Tamb	Ambient Temperature
II	Equipment Group II
3 G	ATEX Category Gas Zone: Equipment Suitable for Zone 2
3 D	ATEX Category Dust Zone: Equipment Suitable for Zone 22
Ex	Explosion Protection
ic	Intrinsic Safety Type of Gas Protection
IIC	Hydrogen/Acetylene Gas Group
T6	85°C Maximum Surface Temperature in Gas Locations
Gc	Equipment Suitable for Gas Zone 2
ic	Intrinsic Safety Type of Dust Protection
IIIB	Non-Conductive Dust Group
T88°C	88°C Maximum Surface Temperature in Dust Locations
Dc	Equipment Suitable for Dust Zone 22

Approvals by Country

For a complete listing of all compliance approvals and certifications, please visit www.honeywellaidc.com/compliance.

R&TTE Compliance Statement—802.11a/b/g/n, Bluetooth, and/or GSM

CE The CE marking indicates compliance with the following directives:

- 1995/5/EC R&TTE
- 2011/65/EU RoHS (Recast)

In addition, this product complies to 2006/95/EC Low Voltage Directive when supplied with the recommended power supply. Honeywell shall not be liable for use of our product with equipment (i.e., power supplies, personal computers, etc.) that is not CE marked and does not comply with the Low Voltage Directive.

The equipment is intended for use throughout the European Community; PAN European Frequency Range: 2.402–2.480 GHz. Restrictions for use in France are as follows:

- Indoor use: Maximum power (EIRP*) of 100 mW for the entire 2.400–2.4835 GHz
- Outdoor use: Maximum power (EIRP*) of 100 mW for the 2.400–2.454 GHz band & maximum power (EIRP*) of 10 mW for the 2.454–2.483 MHz band.
- 5GHz band: UNII (Unlicensed National Information Infrastructure) or band1 (5.150 to 5.250 GHz) is restricted to indoor use only. Any other use will make the operation of the device illegal.

European Contact:

Hand Held Products Europe B.V.
Nijverheidsweg 9-13
5627 BT Eindhoven
The Netherlands

FCC Requirements

Dolphin RF Terminal—802.11a/b/g/n, Bluetooth, and/or GSM

This device complies with Part 15 of the FCC Rules. Operation is subject to the following two conditions: (1) this device may not cause harmful interference, and (2) this device must accept any interference received, including interference that may cause undesired operation.

This equipment has been tested and found to comply with the limits for a Class B digital device pursuant to Part 15 of the FCC Rules. These limits are designed to provide reasonable protection against harmful interference in a residential installation. This equipment generates, uses, and can radiate radio frequency energy and, if not installed and used in accordance with the instructions, may cause harmful interference to radio communications. However, there is no guarantee that interference will not occur in a particular installation. If this equipment does cause harmful interference to radio or television reception, which can be determined by turning the equipment off and on, the user is encouraged to try to correct the interference by one or more of the following measures:

- Reorient or relocate the receiving antenna.
- Increase the separation between the equipment and receiver.
- Connect the equipment into an outlet on a circuit different from that to which the receiver is connected.
- Consult the dealer or an experienced radio/TV technician for help.

In accordance with FCC 15.21, changes or modifications not expressly approved by the party responsible for compliance could void the user's authority to operate the equipment.

The antenna(s) used for this transmitter must not be co-located or operating in conjunction with any other antenna or transmitter.

If necessary, the user should consult the dealer or an experienced radio/television technician for additional suggestions. The user may find the following booklet helpful: "Something About Interference." This is available at FCC local regional offices. Our company is not responsible for any radio or television interference caused by unauthorized modifications of this equipment or the substitution or attachment of connecting cables and equipment other than those specified by our company. The correction is the responsibility of the user. Use only shielded data cables with this system.

Canadian Compliance

This Class B digital apparatus complies with Canadian ICES-003 and RSS210. Operation is subject to the following two conditions:

1. This device may not cause harmful interference.
2. This device must accept any interference received, including interference that may cause undesired operation.

Conformité à la réglementation canadienne

Cet appareil numérique de la Classe B est conforme à la norme NMB-003 et RSS210 du Canada. Son fonctionnement est assujéti aux conditions suivantes:

1. Cet appareil ne doit pas causer de brouillage préjudiciable.
2. Cet appareil doit pouvoir accepter tout brouillage reçu, y compris le brouillage pouvant causer un fonctionnement indésirable.

RF Exposure Information (SAR)

This mobile phone meets the government's requirements for exposure to radio waves. This phone is designed and manufactured not to exceed the emission limits for exposure to radio frequency (RF) energy set by the Federal Communications Commission of the U.S. Government.

The exposure standard for wireless mobile phones employs a unit of measurement known as the Specific Absorption Rate, or SAR. The SAR limit set by the FCC is 1.6W/kg. Tests for SAR are conducted using standard operating positions accepted by the FCC with the phone transmitting at its highest certified power level in all tested frequency bands. Although the SAR is determined at the highest certified power level, the actual SAR level of the phone while operating can be well below the maximum value. This is because the phone is designed to operate at multiple power levels so as to use only the power required to reach the network. In general, the closer you are to a wireless base station antenna, the lower the power output.

The highest SAR value for the model phone as reported to the FCC when tested for use at the ear is 0.919 W/kg Max. and when worn on the body, as described in this user guide, is 1.34 W/kg Max. (Body-worn measurements differ among phone models, depending upon available accessories and FCC requirements.)

While there may be differences between the SAR levels of various phones and at various positions, they all meet the government requirement.

The FCC has granted an Equipment Authorization for this model phone with all reported SAR levels evaluated as in compliance with the FCC RF exposure guidelines. SAR information on this model phone is on file with the FCC and can be found under the Display Grant section of www.fcc.gov/oet/ea/fccid after searching on FCC ID: HD599EXLG and HD599EXLW.

For body worn operation, this phone has been tested and meets the FCC RF exposure guidelines for use with an accessory that contains no metal and the positions the handset a minimum of 1.5 cm from the body. Use of other accessories may not ensure compliance with FCC RF exposure guidelines. If you do not use a body-worn accessory and are not holding the phone at the ear, position the handset a minimum of 1.5 cm from your body when the phone is switched on.

Honeywell Scanning & Mobility Product Environmental Information

Refer to www.honeywellaidc.com/environmental for the RoHS / REACH / WEEE information.

Hearing Aid Compatibility (HAC)

The Dolphin 99EXLW has been tested for hearing aid compatibility. This device has an M3 and T3 rating. For additional HAC information, including the HAC rating for this product, please refer to www.honeywellaidc.com.

When some wireless devices are used near some hearing devices such as hearing aids and implants, users may detect a buzzing or humming noise. Some hearing devices are more immune than others to this interference noise. Wireless devices may also vary in the amount of interference they generate.

The ratings for compatibility of digital wireless devices with hearing aids are described in the American National Standards Institute (ANSI) C63.19 standard:

M-Rating: Phones rated M3 or M4 meet FCC requirements and are likely to generate less interference with hearing devices than phones that are not labeled. M4 is the superior/higher of the two ratings.

T-Rating: Phones rated T3 or T4 meet FCC requirements and are likely to be more usable with hearing devices' telecoil than unrated phones. T4 is the superior/higher of the two ratings.

The more immune the hearing aid device is, the less likely one is to experience interference noise from the wireless phone. Hearing aid devices may also be rated. Adding the ratings of the hearing aid and the phone would determine probable usability:

- Any combined rating equal to or greater than six offers the best use.
- Any combined rating equal to five is considered normal use.

The ratings are not guarantees. Results will vary depending on the user's hearing device and hearing loss. If your hearing device happens to be vulnerable to interference, you may not be able to use this device successfully. Trying out this device with your hearing device is the best way to evaluate it for your personal needs.

This device has been tested and rated for use with hearing aids for some of the wireless technologies that it utilizes. However, there may be some newer wireless technologies used in this phone that have not been tested yet for use with hearing aids. It is important to try the different features of this phone thoroughly and in different locations, using your hearing aid or cochlear implant, to determine if you hear any interfering noise. Consult your service provider or the manufacturer of this phone for information on hearing aid compatibility.

Pacemakers, Hearing Aids and Other Electrically Powered Devices

Most manufacturers of medical devices adhere to the IEC 601-1-2 standard. This standard requires devices to operate properly in an EM Field with a strength of 3V/m over a frequency range of 26 to 1000MHz. The maximum allowable field strength emitted by the Dolphin terminal is 0.3V/m according to Subpart B of Part 1 of the FCC rules. Therefore, the RF from the Dolphin terminal has no effect on medical devices that meet the IEC specification.

Microwaves

The radio in the Dolphin RF terminal operates on the same frequency band as a microwave oven. Therefore, if you use a microwave within range of the Dolphin RF terminal you may notice performance degradation in your wireless network. However, both your microwave and your wireless network will continue to function.

China RoHs

 有毒有害物质或元素的名称及含量 (Names and Content of Hazardous Substances or Elements)						
部件名称 (Parts Name)	有毒有害物质或元素 (Toxic and Hazardous Substances or Elements)					
	铅 (Pb)	汞 (Hg)	镉 (Cd)	六价铬 (Cr ⁶⁺)	多溴联苯 (PBB)	多溴二苯醚 (PBDE)
成像式条码阅读器 (Imager)	x	o	o	o	o	o
印刷电路板 (PCB)	x	o	o	o	o	o
外壳 (Housing)	o	o	o	o	o	o
连线 (Cables)	x	o	o	o	o	o
液晶显示器 (LCD)	x	o	o	o	o	o
电池 (Battery)	o	o	o	o	o	o
机座 (Mainframe)	o	o	o	o	o	o
键盘 (Keypad)	o	o	o	o	o	o

o: 表示该有毒有害物质在该部件所有均质材料中的含量均在SJ/T11363-2006标准规定的限量要求以下 (Indicates that this toxic or hazardous substance contained in all of the homogeneous materials for this part is below the limit requirement in China's SJ/T11363-2006.)
 x: 表示该有毒有害物质至少在该部件的某一均质材料中的含量超出 SJ/T11363-2006 标准规定的限量要求 (Indicates that this toxic or hazardous substance contained in at least one of the homogeneous materials for this part is above the limit requirement in China's SJ/T11363-2006.)



Getting Started

Out of the Box

Verify that the carton contains the following items:

- Dolphin mobile computer (the terminal)
- Main battery pack
- Quick Start Guide
- I/O Cover

If you ordered accessories for your terminals, verify that they are also included with the order. Be sure to keep the original packaging in the event that the Dolphin terminal should need to be returned for service. For details, see [Product Service and Repair](#) on page 18-1.

Equipment Intended for Use in Potentially Explosive Atmospheres

Dolphin 99EX models are designed for use only with standard battery pack, part number 99EX-BTSC-2 (Li-poly 3.7V, 11.3 watt hour) or extended battery pack, part number 99EX-BTEC-2 (Li-ion 3.7V, 18.5 watt hour) manufactured for Honeywell International Inc.

Dolphin 99EX models for use in hazardous location are identifiable by specific labeling located on the back panel of the device, see [Label Locations](#) on page 1-1. **Routine operator inspections should occur to check for possible terminal damage and to ensure the presence of the I/O cover before using the terminal in areas known to be hazardous.**

Note: Before you attempt to use, charge, or replace the battery in the terminal, carefully read all the warnings below and the [Guidelines for Battery Pack Use and Disposal](#) on page 3-13.

The following warnings apply to **99EXXXX-XXXXXXXI** models. See [Approvals by Country](#) on page 1-4.)

Note: Replace only with battery pack model 99EX-BTSC (PN 99EX-BTSC-2) or 99EX-BTEC (PN 99EX-BTEC-2) manufactured for Honeywell International Inc.



CAUTION - DANGER OF EXPLOSION IF BATTERY IS INCORRECTLY REPLACED. REPLACE ONLY WITH THE SAME OR EQUIVALENT TYPE.

ATTENTION - RISQUE D'EXPLOSION SI LA PILE N'EST PAS REMPLACÉ CORRECTEMENT. REMPLACIER UNIQUEMENT PAR UNE PILE DE TYPE IDENTIQUE OU ÉQUIVALENT.



WARNING - EXPLOSION HAZARD - BATTERIES MUST ONLY BE CHANGED IN AN AREA KNOWN TO BE NON-HAZARDOUS.

AVERTISSEMENT - RISQUE D'EXPLOSION-AFIN D'ÉVITER TOUT RISQUE D'EXPLOSION, S'ASSURER QUE L'EMPLACEMENT EST DESIGNÉ NON DANGEREUX AVANT DE CHANGER LA BATTERIE.



Warning: Explosion hazard. Do not disconnect battery unless the area is known to be free of ignitable concentrations.



Warning: Explosion Hazard. Charge or replace the battery only in an area known to be non-hazardous.

The following warnings apply to **99EXXXX-XXXXXXXI** models. See [Approvals by Country](#) on page 1-4.)



Warning: Explosion Hazard. Do not replace components unless power has been switched off or the area is known to be non-hazardous.



Warning: Substitution of any components may impair suitability.



Warning: Explosion Hazard. Do not use external connectors in areas known to be hazardous.



Warning: Explosion Hazard. Do not use the terminal in areas known to be hazardous if the I/O cover is damaged, missing or not properly installed (e.g., missing M2 screws).



Warning: Explosion Hazard. Do not use the terminal in areas known to be hazardous if the terminal is damaged, for example: a crack in the display or enclosure, missing keypad buttons or side buttons, or the terminal battery well seal is missing or cracked.

I/O Cover

All Dolphin 99EX models intended for use in potentially explosive atmospheres are shipped with an I/O Cover installed over the I/O connector.



*The I/O Cover must be included on all **99EXXXX-XXXXXXXI** models used in hazardous environments to meet compliance requirements.*

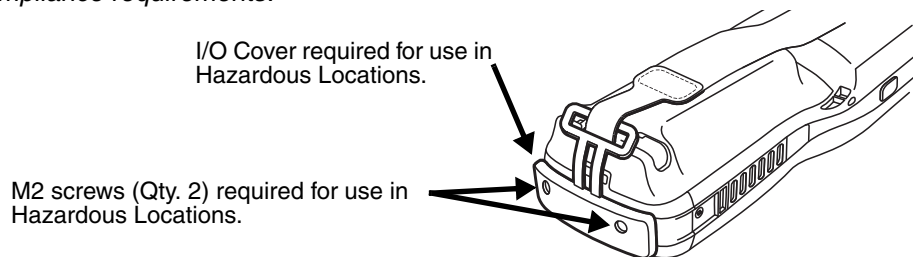

For agency rating and approval information, see [Approvals by Country](#) on page 1-4.

Removing the I/O

You should carefully read all warnings starting on page 2-1 before attempting to remove the I/O cover. **The I/O Cover and the M2 screws securing the cover must be installed for use in Hazardous Locations.**

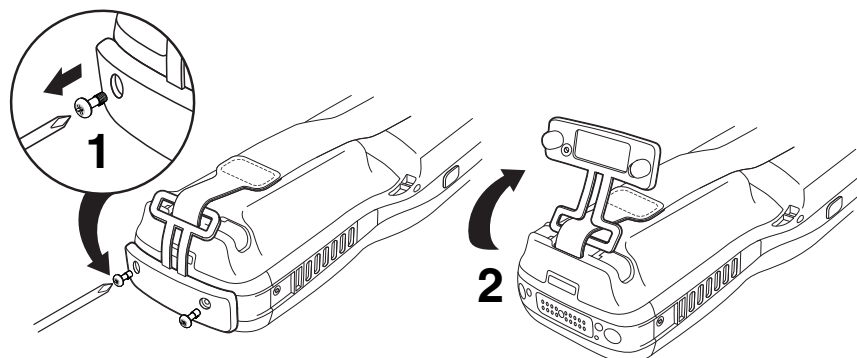

Initial Setup

Step 1. Install the Main Battery Pack

The terminal is shipped with the battery packaged separate from the unit. Follow the steps below to install the main battery. For information on how to remove the battery, see [Replacing the Main Battery Pack](#) on page 2-6.

 Before you attempt to use, charge, or change the battery in the terminal carefully read all the information under [Equipment Intended for Use in Potentially Explosive Atmospheres](#), starting on page 2-1 and the [Guidelines for Battery Pack Use and Disposal](#) on page 3-13.

 Ensure all components are dry prior to placing the battery in the terminal. Mating wet components may cause damage not covered by the warranty.

1. Release the hook securing the hand strap to the back panel of the terminal near the speaker.
2. Remove the battery door by lifting up the latches near the base of the battery door.
3. Insert the battery into the battery well.

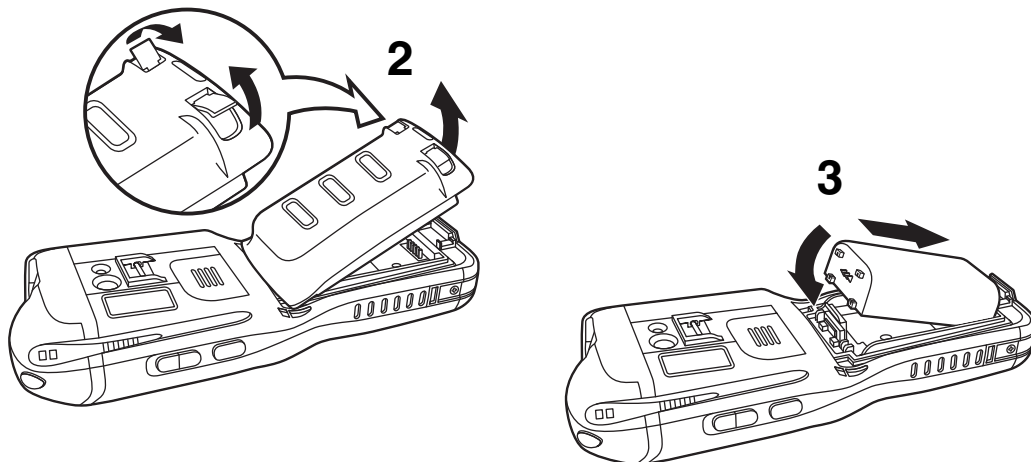

4. Replace the battery door. Apply pressure to engage the door latch.

Note: The battery door must be installed prior to powering the unit.

5. Reattach the hand strap.

Battery Error Notification

If your terminal displays the following indicators, replace the main battery pack with a Honeywell new Honeywell battery pack. For information on how to remove the main battery pack from the terminal, see [Replacing the Main Battery Pack](#) on page 2-6.

-  appears in the Title bar at the top of the touch screen
- The General Notification LED flashes red
- A Notification appears on the Tile bar at the bottom of the touch screen

Note: Replace only with battery pack model 99EX-BTSC (PN 99EX-BTSC-2) or 99EX-BTEC (PN 99EX-BTEC-2) manufactured for Honeywell International Inc.

Step 2. Charge the Main and Backup Batteries

The power supply for Dolphin terminals consists of two types of battery power: the main battery pack that is accessible from the back panel, and the backup battery that resides inside the terminal.

The main battery powers the terminal. The internal backup battery charges off the main battery and maintains the application data stored in RAM memory for up to 30 minutes when the terminal's main battery pack is completely discharged or removed.

Before Initial Use

Terminals are shipped with both batteries discharged of all power. The initial charging time for the main battery pack is 6 hours for the extended 3.7V battery. Connect the terminal to one of the 99EX series charging peripherals to charge; see [Peripherals for the 99EX](#) on page 3-3. Honeywell recommends charging the Dolphin terminal for at least 24 hours prior to initial use to ensure the internal backup battery is fully charged.

All Dolphin 99EX model terminals are designed for use with the following 99EX charging devices and cables: 99EX-HB, 99EX-EHB, 99EX-NB, 99EX-CB, 99EX-DEX, 99EX-RS232, 99EX-USB, and 99EX-USBH. See Chapters 12-17 for additional information on the individual device requirements.



Warning! Dolphin 99EX charging peripherals are not designed for use in hazardous locations. Before you attempt to use, charge, or change the battery in the terminal carefully read all the information under [Equipment Intended for Use in Potentially Explosive Atmospheres](#), starting on page 2-1 and the [Guidelines for Battery Pack Use and Disposal](#) on page 3-13.

Note: The communications/charging circuits connected to the equipment provide the transient protection set at a level not exceeding 140% of the peak rated voltage value of the IO terminal.



We recommend use of Honeywell peripherals, power cables, and power adapters. Use of any non-Honeywell peripherals, cables, or power adapters may cause damage not covered by the warranty.

Using the Charging/Communication Cables

Use only a UL Listed power supply, which has been qualified by Honeywell with output rated at 5VDC and 3 amps with the device.

Warning! The Charging/Communication cables (i.e., 99EX-DEX, 99EX-RS232, 99EX-USB, and 99EX-USBH) are not designed for use in hazardous locations.

Ensure all components are dry prior to mating terminals/batteries with peripheral devices. Mating wet components may cause damage not covered by the warranty.

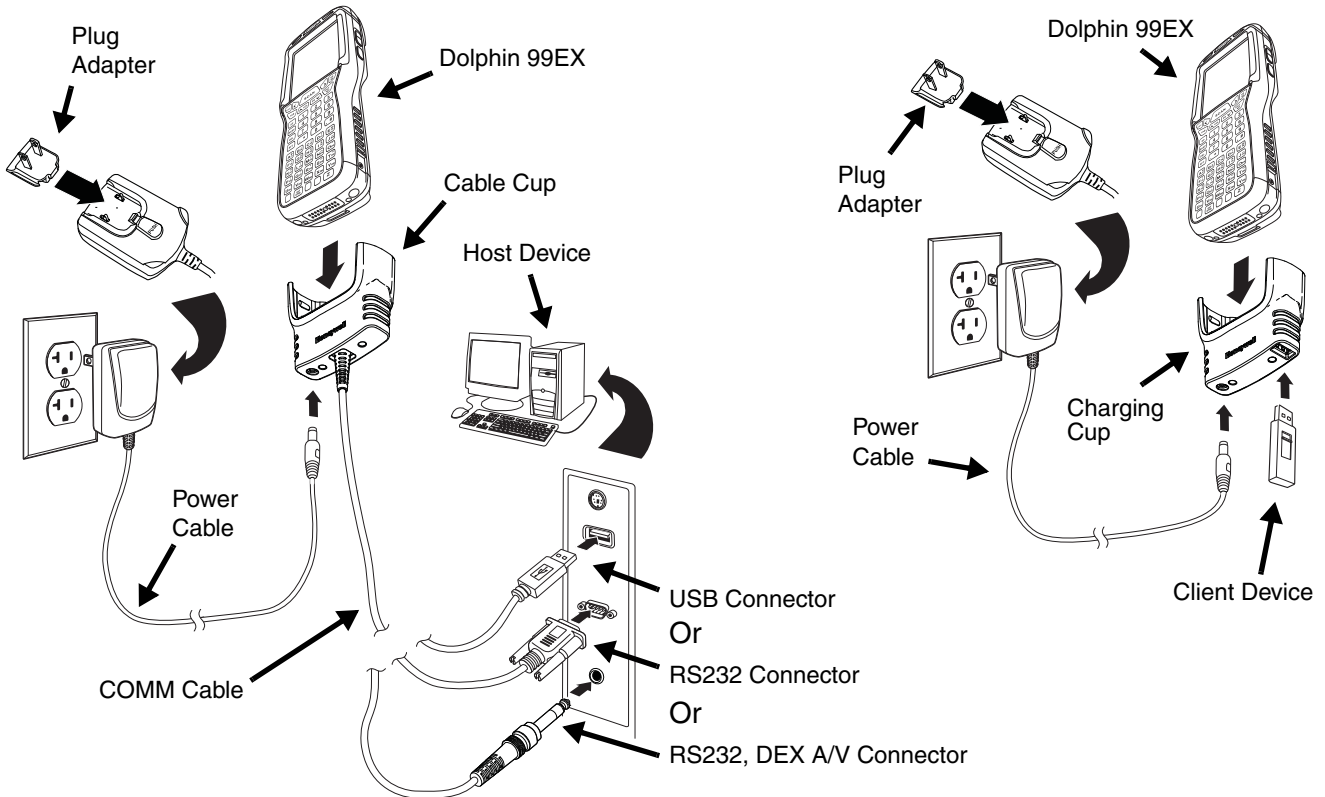

Battery Error Notification

See [Battery Error Notification](#) on page 2-3.

Step 3. Boot the Terminal

The terminal begins booting as soon as power is applied. Do NOT press any keys or interrupt the boot process. When the boot process is complete, the Home screen appears, and the terminal is ready for use.

Step 4. Set the Time Zone, Time, and Date

On the Home screen, tap the line that displays the time and date. When the Clock & Alarms screen appears, tap the arrow to the right of the time zone to open the drop down menu. Select the appropriate time zone from the menu. Set the correct time and date in the remaining fields and tap **OK** to save.

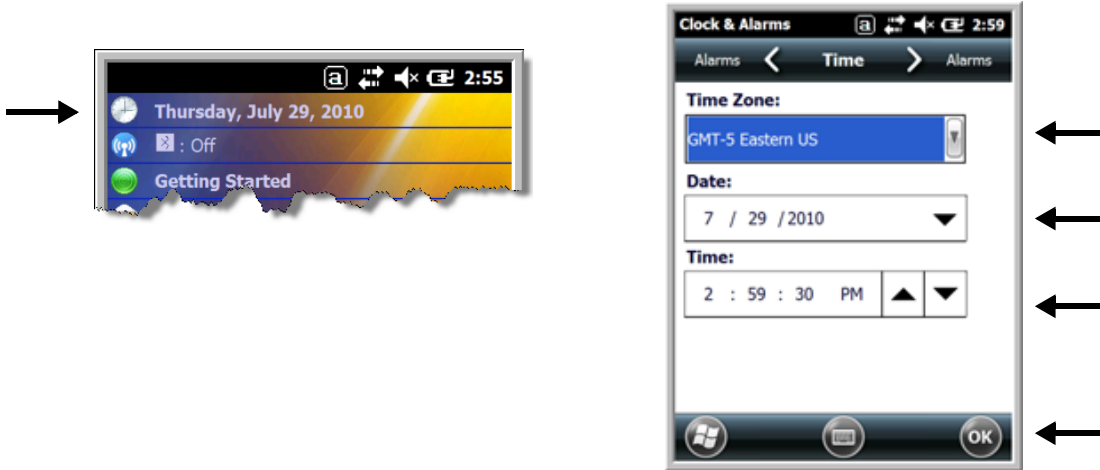

Replacing the Main Battery Pack



Before you attempt to use, charge, or change the battery in the terminal carefully read all the information under [Equipment Intended for Use in Potentially Explosive Atmospheres](#), starting on page 2-1 and the [Guidelines for Battery Pack Use and Disposal](#) on page 3-13.



Ensure all components are dry prior to placing the battery in the terminal. Mating wet components may cause damage not covered by the warranty.

Note: Replace only with battery pack model 99EX-BTSC (PN 99EX-BTSC-2) or 99EX-BTEC (PN 99EX-BTEC-2) manufactured for Honeywell International Inc.

To replace the main battery pack:

1. Press the Power key  to put the terminal in [Suspend Mode](#) (see page 2-13).
2. Release the hook securing the hand strap to the back panel of the terminal near the speaker.
3. Remove the battery door by lifting up the latches near the base of the battery door.
4. **Wait at least 3 seconds**, and then remove the battery. This process allows the device to shut down properly and maintains memory during the battery swap.
5. Insert the new battery into the battery well.
6. Replace the battery door. Apply pressure to engage the door latch. The battery door must be installed prior to powering the unit.
7. Reattach the hand strap.



We recommend use of Honeywell Li-poly or Li-Ion battery packs. Use of any non-Honeywell battery may result in damage not covered by the warranty.

Battery Error Notification

See [Battery Error Notification](#) on page 2-3.

Home Screen

After the Dolphin terminal initializes the first time, you see the Home screen.

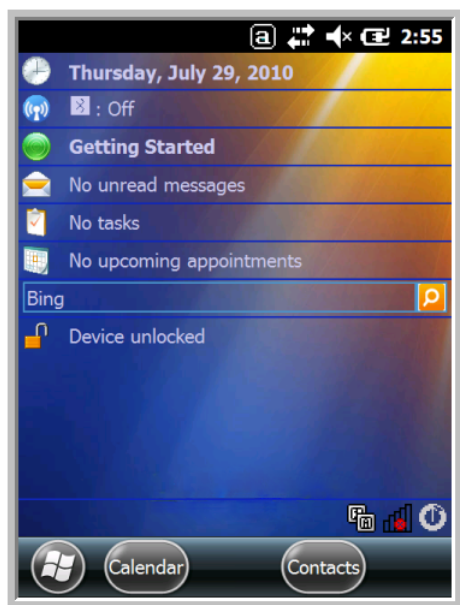

Tap  to reach the Start screen from the home screen.

Tap  to access the [Dolphin Wireless Manager](#) (see page 8-6) from the home screen.

Title Bar



The Title bar, located at the top of the screen, displays the active program, the status of various system functions, and the current time. Tapping on the title bar provides access to the Horizontal Scroll. The scroll provides access to additional programs and application screens. For additional information, see [Horizontal Scroll](#) on page 2-10.

Text here indicates the active program.























Icons here indicate the status of various system functions.























Icons in the Title Bar

Indicator	Meaning
	Synchronizing data
	The terminal could not synchronize data with the workstation via ActiveSync.
	New e-mail

Icons in the Title Bar

Indicator	Meaning
	New text message
	New voicemail
	New instant message
	Vibrate on
	Ringer off
	Speakerphone on
	Voice call in progress
	Calls are forwarded
	Call on hold
	Missed call
	Data call in progress
	A battery error has occurred. Replace the main battery pack with a Honeywell battery pack.
	Battery is has a full charge
	Battery has a high charge
	Battery has a medium charge
	Battery has a low charge
	Battery has a very low charge and requires charging
	Terminal is running on external power. If a battery pack is installed, the battery is charging in the background.
	The terminal is not connected to external power. A battery is installed, but is defective; specifically, its charge level cannot be measured.
	No SIM card is installed
	Active network connection

Icons in the Title Bar

Indicator	Meaning
	No active network connection
	GPRS available
	GPRS connecting
	GPRS in use
	HSDPA available
	HSDPA connecting
	HSDPA in use
	EDGE available
	EDGE connecting
	EDGE in use
	UMTS available
	UMTS connecting
	UMTS in use
	Radio is off
	The radio is not connected to a network.
	The radio is connected. The bars indicate the signal strength.
	No radio signal
	The terminal is searching for a signal.
	Wi-Fi is on, but device is not connected
	Wi-Fi data call
	Pending alarm
	Bluetooth

Horizontal Scroll

The Horizontal Scroll, located at the top of most application windows, provides access to additional application screens. You can flick left or right on the scroll or tap each label on the scroll, until you get to the desired screen. Tapping a label to the left or right of the center item brings new labels into view.

Note: Tap the Title bar to access the horizontal scroll if it is not visible on the screen.

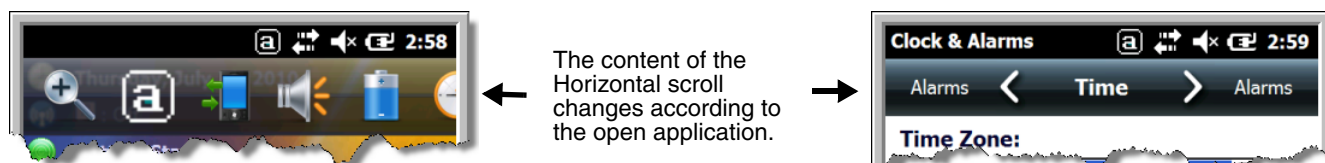

Tile Bar

The Tile bar is located at the bottom of application windows.

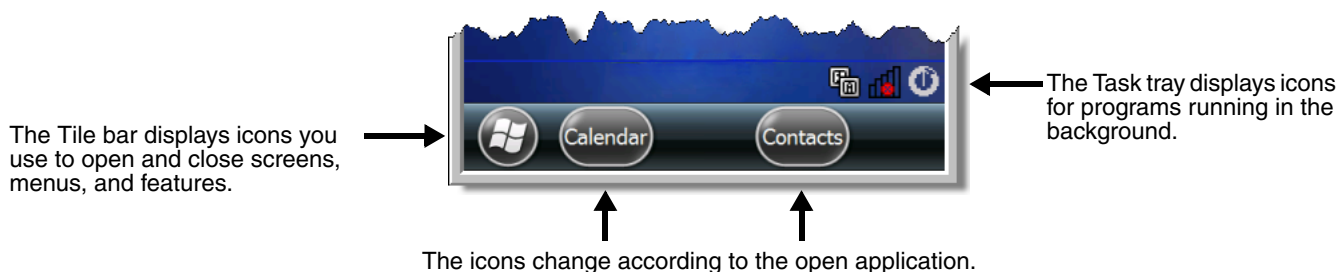

Pop-Up Menus

With pop-up menus, you can quickly choose an action for a selected item. To access a pop-up menu, tap and hold the stylus on the item name of the action you want to perform. When the menu appears, lift the stylus, and tap the action you want to perform.

Tap anywhere outside the menu to close the menu without performing an action.

Selecting Programs

To see the programs loaded on your terminal, tap  to access the Start Menu. To open a program, tap once on the program icon. To reposition an icon on the Start Menu, tap and hold the stylus on the icon, then drag the icon to the desired position.

File Explorer

You can also use the File Explorer to find files and organize these files into folders.

1. Tap  > File Explorer .

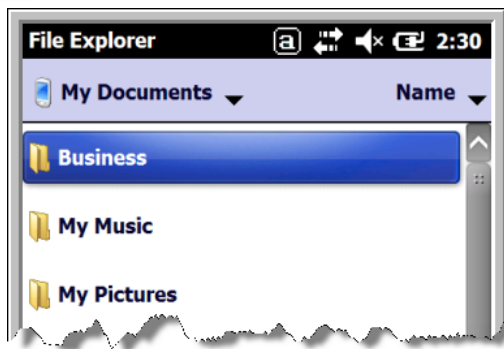

2. Tap the **Up** button at the bottom of the screen to move up one level in the directory.



3. You can move files in File Explorer by tapping and holding on the item you want to move, then tapping **Cut** or **Copy** on popup menu.
4. Navigate to the folder you want to move the file to, then tap and hold a blank area of the window.
5. Tap **Paste** on the pop-up menu.

*Note: If there is no blank space available in the window, tap **Menu** on the command bar, navigate to the end of the menu using the down arrow, then tap **Edit** > **Paste**.*

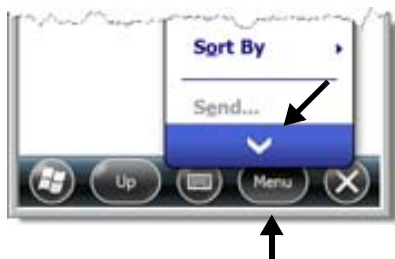

File Provisioning on the 99EX

\IPSM\Honeywell

The IPSM folder is the only partition on the 99EX that persists across a kernel upgrade (*.UPG file extension). During a kernel upgrade, files are automatically copied from the \IPSM\Honeywell\Autoinstall folder and then installed in the \Honeywell (root file system) folder as part of the upgrade process.

\IPSM\Honeywell\AutoInstall

The files in the \IPSM\Honeywell\AutoInstall folder are only installed when a factory reset or kernel upgrade occurs. Once the files are installed, they persist through hard and soft resets. If a file is added to the folder and a hard or soft reset is performed, it will have no effect. If a program is manually removed using the Remove Programs application (see page 7-17), then the program is not automatically re-installed on a hard or soft reset.

\Honeywell

The Honeywell partition or root file system partition is persistent over a Hard Reset, Soft Reset, and the removal of the battery pack or the removal of AC power. However, during a kernel upgrade the root file system is reformatted so all data in the folder is deleted and replaced by any files in the \IPSM\Honeywell\AutoInstall folder as part of the upgrade process.

 To prevent data loss, back up all user data to an SD card or external memory device before performing an upgrade.

\Honeywell\AutoInstall

If you run a CAB file from within the \Honeywell\AutoInstall (user store) folder, after the program has been installed, the CAB file will be deleted from the User Store. The program remains installed through all successive Hard and Soft resets.



If you want the program to be part of the Autoinstall that occurs after a factory reset or software upgrade, paste the program file(s) in both the \IPSM\Honeywell\Autoinstall folder and the \Honeywell\Autoinstall.

Contact a Honeywell technical support representative for information on how to perform a factory reset. For contact information, see [Customer Support](#) on page 18-1. or go to www.honeywellaidc.com.

 To prevent data loss, back up all user data to an SD card or external memory device before performing an upgrade.

Contact a Honeywell technical support representative for information on available software upgrades for your Dolphin terminal, see [Customer Support](#) on page 18-1. or go to www.honeywellaidc.com.

Search

The Search feature helps you quickly locate information. Tap  > **Search Phone** .

Enter the text you want to find, select a data type, and then tap **Go** to start the search. Select **Larger than 64 KB** in the **Type** drop-down field to quickly find information that is taking up storage space.



Resetting the Terminal

There are three types of system resets: a soft reset, a hard reset, or a factory reset. The soft and hard resets preserve all data stored in the file system. Contact a Honeywell technical support representative for more information on how to perform a factory reset.

Soft Reset (Warm Boot)



A soft reset re-boots the device and preserves any objects created in RAM. You would perform a soft reset when:

- the terminal fails to respond.
- after installing some software applications.
- after making changes to certain system settings, such as network cards.

1. Press and hold the CTRL  + ENTER  keys for approximately 5 seconds.
2. The decode and scan LEDs flash for approximately three seconds as the terminal resets.
3. When the reset is complete, the Home screen displays.

Hard Reset (Cold Boot)

A hard reset re-boots the device and closes any open applications running in RAM at the time of the reset.

1. Press and hold the CTRL  + ESC  keys for approximately 5 seconds.
2. The decode and scan LEDs light for approximately 3 seconds.
3. The terminal re-initializes.

Factory Reset

Contact a Honeywell technical support representative for information on how to perform a factory reset. For contact information, see [Technical Assistance](#) on page 18-1.

Suspend Mode

The terminal goes into Suspend Mode automatically when the terminal is inactive for a programmed period of time. You can program this time on the Advance tab of the Power System Setting; see [Power](#) on page 7-16.

To put the terminal into Suspend Mode manually, press the Power key  and the screen turns off.

To wake the terminal from Suspend Mode, press the Power key  or SCAN key .

Note: You should always put the terminal in suspend mode before removing the battery door. For information on removing the battery, see [Replacing the Main Battery Pack](#) on page 2-6.



Hardware Overview

Standard Configurations for the 99EX Models Intended for Use in Potentially Explosive Atmospheres

WLAN & WPAN

- Microsoft Windows Embedded Handheld 6.5 Classic
- OMAP3715 (1Ghz)
- 512MB RAM X 1GB Flash
- Four keyboard options
- Extended 3.7V Li-ion rechargeable battery pack
- Adaptus Imaging Technology: N5603ER/SR/HD or N5600ER/SR/HD image engines
- 802.11a/b/g/n and Bluetooth

WLAN, WPAN, with GPS

- Microsoft Windows Embedded Handheld 6.5 Classic
- OMAP3715 (1Ghz)
- 512MB RAM X 1GB Flash
- Four keyboard options
- Extended 3.7V Li-ion rechargeable battery pack
- Adaptus Imaging Technology: N5603ER/SR/HD or N5600ER/SR/HD image engines
- 802.11a/b/g/n and Bluetooth
- GPS

WLAN, WPAN, & WWAN

- Microsoft Windows Embedded Handheld 6.5 Professional
- OMAP3715 (1Ghz)
- 512MB RAM X 1GB Flash
- Four keyboard options
- Extended 3.7V Li-ion rechargeable battery pack
- Adaptus Imaging Technology: N5603ER/SR/HD or N5600ER/SR/HD image engines
- 802.11a/b/g/n, Bluetooth, and GSM/HSPA+

WLAN, WPAN & Camera

- Microsoft Windows Embedded Handheld 6.5 Classic
- OMAP3715 (1Ghz)
- 512MB RAM X 1GB Flash
- Four keyboard options
- Extended 3.7V Li-ion rechargeable battery pack
- Adaptus Imaging Technology: N5603ER/SR/HD or N5600ER/SR/HD image engines
- 802.11a/b/g/n and Bluetooth
- 3.1 megapixel auto control color camera

WLAN, WPAN, with GPS & Camera

- Microsoft Windows Embedded Handheld 6.5 Classic
- OMAP3715 (1Ghz)
- 512MB RAM X 1GB Flash
- Four keyboard options
- Extended 3.7V Li-ion rechargeable battery pack
- Adaptus Imaging Technology: N5603ER/SR/HD or N5600ER/SR/HD image engines
- 802.11a/b/g/n and Bluetooth
- GPS
- 3.1 megapixel auto control color camera

WLAN, WPAN, & WWAN with GPS

- Microsoft Windows Embedded Handheld 6.5 Professional
- OMAP3715 (1Ghz)
- 512MB RAM X 1GB Flash
- Four keyboard options
- Extended 3.7V Li-ion rechargeable battery pack
- Adaptus Imaging Technology: N5603ER/SR/HD or N5600ER/SR/HD image engines
- 802.11a/b/g/n, Bluetooth, and GSM/HSPA+
- GPS

WLAN, WPAN, WWAN with GPS & Camera

- Microsoft Windows Embedded Handheld 6.5 Classic
- OMAP3715 (1Ghz)
- 512MB RAM X 1GB Flash
- Four keyboard options
- Extended 3.7V Li-ion rechargeable battery pack
- Adaptus Imaging Technology: N5603ER/SR/HD or N5600ER/SR/HD image engines
- 802.11a/b/g/n, Bluetooth, and GSM/HSPA+
- GPS
- 3.1 megapixel auto control color camera

WLAN, WPAN, & WWAN

- Microsoft Windows Embedded Handheld 6.5 Classic
- OMAP3715 (1Ghz)
- 512MB RAM X 1GB Flash
- Four keyboard options
- Extended 3.7V Li-ion rechargeable battery pack
- Adaptus Imaging Technology: N5603ER/SR/HD or N5600ER/SR/HD image engines
- 802.11a/b/g/n, Bluetooth, and GSM/CDMA

WLAN, WPAN, & WWAN with GPS

- Microsoft Windows Embedded Handheld 6.5 Classic
- OMAP3715 (1Ghz)
- 512MB RAM X 1GB Flash
- Four keyboard options
- Extended 3.7V Li-ion rechargeable battery pack
- Adaptus Imaging Technology: N5603ER/SR/HD or N5600ER/SR/HD image engines
- 802.11a/b/g/n, Bluetooth, and GSM/CDMA
- GPS

WLAN, WPAN, WWAN with GPS & Camera

- Microsoft Windows Embedded Handheld 6.5 Classic
- OMAP3715 (1Ghz)
- 512MB RAM X 1GB Flash
- Four keyboard options
- Extended 3.7V Li-ion rechargeable battery pack
- Adaptus Imaging Technology: N5603ER/SR/HD or N5600ER/SR/HD image engines
- 802.11a/b/g/n, Bluetooth, and GSM/HSPA+ or GSM/CDMA
- GPS
- 3.1 megapixel auto control color camera

Peripherals for the 99EX

Each of the following items is sold separately to enhance the capabilities of your Dolphin terminal.



Dolphin 99EX peripherals are not designed for use in hazardous locations.

Dolphin HomeBase Device

The Dolphin HomeBase device is a charging and communication cradle supporting both RS232 and USB communications, which enables the terminal to interface with the majority of PC-based enterprise systems. The USB host port is Hi-Speed 2.0v compliant. This device also contains an auxiliary battery well that charges a spare Honeywell extended Li-ion battery.

For more information, see [Dolphin 99EX HomeBase Device \(Model 99EX-HB\)](#) on page 12-1.

Dolphin Mobile Base Device

The Dolphin Mobile Base device is a charging and communication cradle designed specifically for in-premise and in-transit data collection applications. It features a flexible mounting bracket and a cigarette lighter adapter to adapt it to your environment.

The serial connector supports RS232 communication and power out to peripheral devices, such as handheld scanners. The USB port is client Hi-Speed 2.0v compliant. You can connect the base to a peripheral device, such as a memory stick or to a printer using a standard USB cable.

For more information, see [Dolphin 99EX Mobile Base Device \(Model 99EX-MB\)](#) on page 14-1.

Dolphin eBase Device

The Dolphin Ethernet (eBase) device enables a single 99EX mobile computer to communicate with a host device over an Ethernet network. In addition, the ebase is equipped with a USB host port that is Hi-Speed 2.0v compliant, which enables the terminal to interface with the majority of PC-based enterprise systems. This device also contains an auxiliary battery well that charges a spare Honeywell extended Li-ion battery.

For more information, see [Dolphin 99EX eBase Device \(Model 99EX-EHB\)](#) on page 13-1.

Dolphin Net Base Device

The Dolphin Net Base device enables up to four 99EX mobile computers to communicate with a host device over an Ethernet network. In addition, the Net Base provides a second RJ45 Ethernet port for connection to an additional device such as a printer, workstation, eBase, or another Net Base.

For more information, see [Dolphin 99EX Net Base Device \(Model 99EX-NB\)](#) on page 16-1.

Dolphin ChargeBase

The Dolphin ChargeBase is a 4-slot charging cradle that holds, powers, and charges terminals.

For more information, see [Dolphin 99EX ChargeBase Device \(Model 99EX-CB\)](#) on page 15-1.

Dolphin QuadCharger Device

The Dolphin QuadCharger device is a 4-slot charging station for standard extended battery packs. For more information, see [Dolphin 99EX QuadCharger Device \(Model 99EX-QC\)](#) on page 17-1.

Accessories for the 99EX

Each of the following items is sold separately to enhance your terminal's capabilities.

Note: When using accessories where the terminal is worn on the body, the terminal's touch panel must face away from the body.

Dolphin Mobile Charger

The Dolphin Mobile Charger is a charging cable that connects the terminal directly to a 12 Volt DC power source, such as a cigarette lighter port inside a vehicle, eliminating the need for a cradle. Intelligent battery technology on-board the terminal ensures proper charging. The Dolphin 99EX Mobile Charger is an ideal low-cost charging solution for in-transit mobile applications.



The Dolphin Mobile Charger is not designed for use in hazardous locations.

Communication/Charging Cables

Dolphin communication/charging cable kits are an all-in-one solution for mobile applications. Each cable kit powers the terminal, charges its main battery, and communicates with host or peripheral devices without the need for a cradle. Cable kits can support RS232, USB client, and USB host communications. U.K. or European power cords are available.



Dolphin communication and charging cables are not designed for use in hazardous locations.

Storage Holster

Holsters provide convenient storage for terminals in mobile environments. The holsters feature a front pocket that holds an extra battery, a side loop to hold an extra stylus, and a belt loop to secure the holster to a belt. The standard 99EX holster includes two additional stylus loops on the front of the holster.

Protective Enclosure

Protective enclosures help seal and protect terminals from damage while providing full access to all terminal parts and features. These enclosures feature a swivel clip on the back that enables you to secure the enclosure to a belt. Enclosures also come with an adjustable shoulder strap for added convenience.

Stylus Kits

Each Dolphin is shipped with a stylus and a stylus tether used to secure the stylus to the terminal to prevent loss. Kits containing three styli and three tethers are available for purchase. When ordering specify your Dolphin model number to ensure the correct stylus selection.

Battery Pack

The rechargeable battery pack provides the main power for the terminal. For more information, see [Batteries](#) on page 3-11.

Front Panel: 99EX

Note: Your Dolphin model may differ from the model illustrated; however, the features noted are standard for all 99EX models unless otherwise indicated.

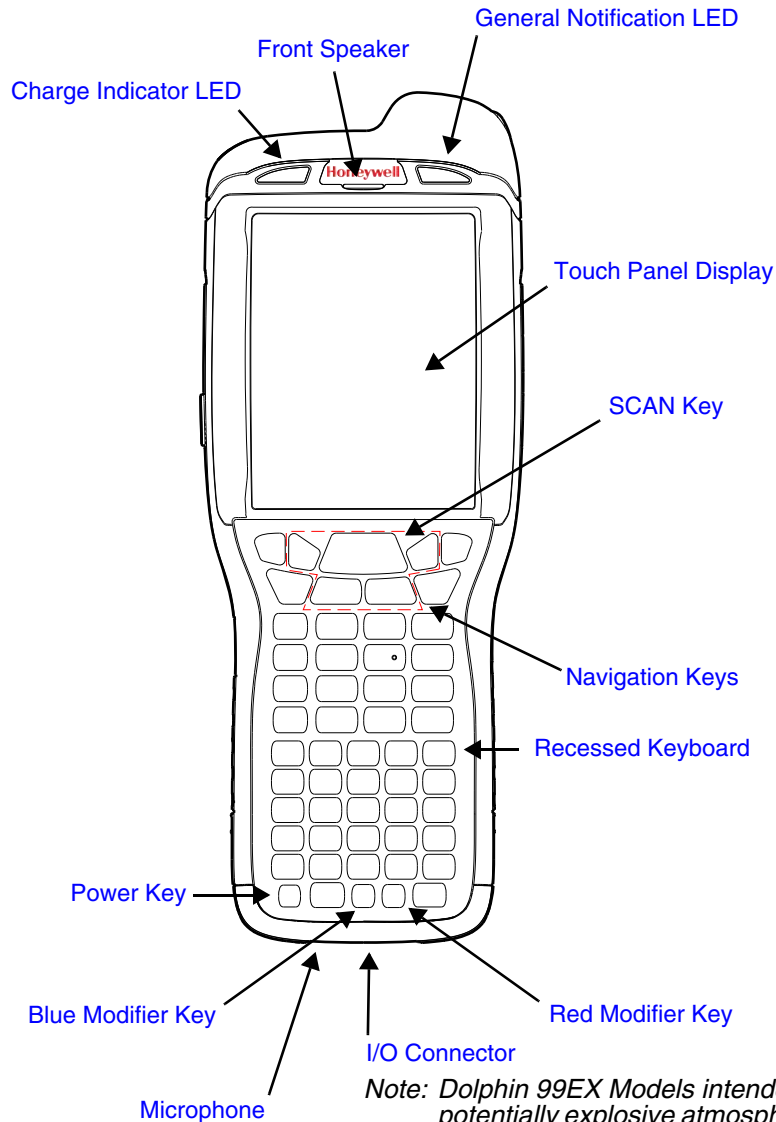

Note: Dolphin 99EX Models intended for use in potentially explosive atmospheres include an I/O Cover (not shown). See [page 2-2](#) for additional information.

Note: The illustrations above show the 55-Key Full Alpha/Numeric Keyboard option. For a complete overview of the optional keyboards available for the 99EX, see [Using the Keyboards](#) on page 6-1.

For a description of each callout, see [Front Panel Features for the 99EX](#) on page 3-5.

Front Panel Features for the 99EX

Blue Modifier Key

See [Using the Modifier Keys](#) on page 6-3.

Front Speaker

The front speaker is the receiver for handset voice calls. See [GSM/HSPA+ Global Radio Dolphin Models](#) on page 9-5.

General Notification LED

The light emitting diode (LED) located above the top right corner of the LCD display flashes and illuminates during resets, scanning/imaging, and taking a picture. This LED can be programmed by various software applications.

Charge Indicator LED

The light emitting diode (LED) located above the top left corner of the LCD display illuminates when the Power Tools **BattMon** application is enabled and the device is on AC charge. For more information, consult the Dolphin Power Tools User's Guide for Windows Embedded Handheld 6.5.

Microphone

The integrated microphone that provides audio input for handset and speakerphone voice calls. See [Voice Communication](#) on page 9-5.

Navigation Keys

The centrally located navigation keys enable you to move and position the cursor through software programs. The up and down arrows are programmed to perform specific functions when pressed in combination with the Blue and Red modifier keys. For more details, see [Using the Navigation Keys](#) on page 6-3.

Power Key

The power key  located at the lower left corner of the keypad puts the terminal in Suspend Mode or wakes the terminal from Suspend Mode. See [Suspend Mode](#) on page 2-13.

Recessed Keyboard

There are three keyboard options: a 34-key alpha/numeric keyboard, a 43-key alpha/numeric keyboard or a 55-key full alpha/numeric keyboard. For a complete overview of each keyboard, see [Using the Keyboards](#) on page 6-1.

Red Modifier Key

See [Using the Modifier Keys](#) on page 6-3.

SCAN Key

The SCAN key is centrally located for easy access with the right or left hand. When pressed, the SCAN key activates the scanner/imager. The SCAN key also functions as a system wake-up control for the terminal.

Touch Panel Display

The color 3.7 inch liquid crystal display (LCD) touch panel is covered with an industrial, protective lens for greater durability. The video graphic array (VGA) display resolution is 480 X 640.

The color LCD (16 bit RGB) uses thin film transistor (TFT) technology. The touch panel backlight illuminates when the screen is touched, but not when the Backlight key is pressed. For more information, see [Backlight](#) on page 7-9.

The touch panel can be activated by the stylus (included with the terminal) or a finger. For more information, see [Using the Touch Panel](#) on page 3-11.

Back Panel: 99EX

Note: Your Dolphin model may differ from the model illustrated; however, the features noted are standard for all 99EX models unless otherwise indicated.

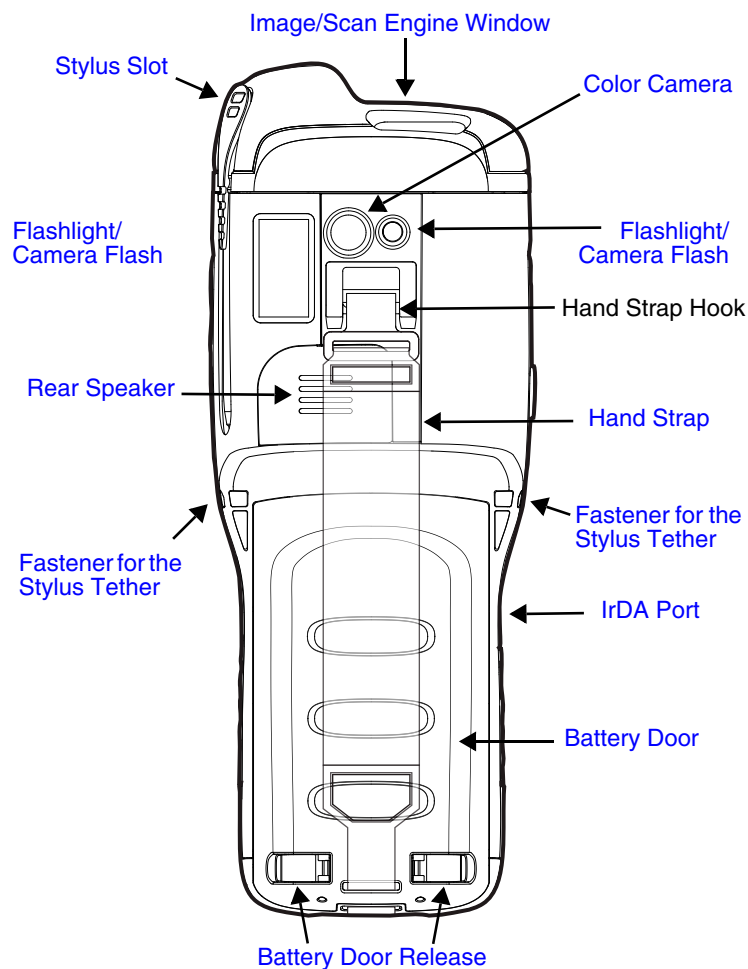

For a description of each callout, see [Back Panel Features for the 99EX](#) on page 3-7.

Back Panel Features for the 99EX

Battery Door

The battery door secures the main battery pack in the terminal's battery well. For information on how to remove the battery, see [Replacing the Main Battery Pack](#) on page 2-6.

Color Camera

The 3.1-Megapixels Resolution color camera provides easy picture capture with Automated Camera Control (ACC). Additional features include automated picture profiles and an Application Programming Interface (API).

Fastener for the Stylus Tether

The Stylus Tether helps prevent accidental loss when the stylus is not stored in the stylus slot. A stylus tether is a coiled, elastic cord that tethers the stylus to the terminal. Secure one end of the cord to the back panel of the terminal and the other end to the stylus.

Flashlight/Camera Flash

The flashlight/camera flash is located on the back panel of the terminal. When used as a Flashlight, press the Blue key +  key to turn the flashlight on or off. When used as a Camera Flash with the terminal's color camera, the flash is controlled by the camera application.

Hand Strap

The terminal comes with a removable, elastic hand strap.

Image/Scan Engine Window

The available image engines read and decode linear, stacked linear (e.g., PDF417), and 2D matrix bar code symbologies. The available image engines contain a laser aimer for greater accuracy. The laser apertures for the imaging engines' laser aimers are contained behind this window. For more details, see [Using the Scan Image Engine](#) on page 4-1.

Memory Card Socket and SIM Card Socket

The memory card socket provides the user with the option to expand the terminal's memory capacity using microSD or microSDHC memory interfaces. The expansion socket is located under the main battery in the battery well.

Note: Honeywell recommends the use of Single Level Cell (SLC) industrial grade microSD or microSDHC memory cards with Dolphin terminals for maximum performance and durability. Contact a Honeywell sales representative for additional information on qualified memory card options.

The card socket for the Subscriber Identity Module (SIM) is also located under the main battery in the battery well. See [SIM Card Installation](#) and [SIM Card Requirements](#), on page 9-3 for additional information.

When the protective SIM/memory card door, battery pack, and the battery door are properly installed, the memory card is sealed against moisture and particle intrusion, read/write data is stored securely, and the terminal's environmental rating is preserved; see [Installing a Memory Card](#) on page 3-17.

Rear Speaker

The integrated rear speaker sounds audio signals as you scan bar code labels and enter data. The integrated speaker also supports playback of wave and MP3 files, software mixer, and Speakerphone for WWAN/GSM audio. The operating frequency range is 600-3000Hz at >90dB.

Stylus Slot

The stylus is used to operate the touch panel. The back panel of the terminal features a storage slot to hold the stylus when not in use. The stylus features a special tip for added accuracy and ease of use.

Stylus for Dolphin 99EX with WLAN

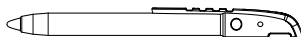

Stylus for Dolphin 99EX with WWAN



Side Panels: 99EX

The left and the right side panels of the Dolphin contain different features.

Note: Your Dolphin model may differ from the model illustrated; however, the features noted are standard for all 99EX models unless otherwise indicated.

Left Side

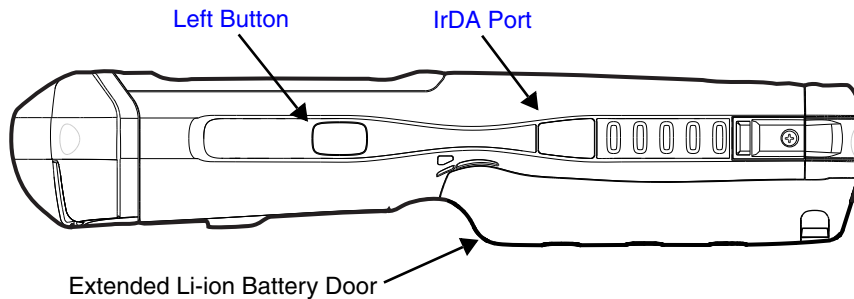

Left Button

By default, the Left Button triggers the scanner/imager. You can reassign the button to launch applications or execute commands. For additional information, see [Changing Button Assignments](#) on page 7-4.

IrDA Port

The IrDA port enables infrared communication. The maximum data transfer speed is 115 kbps. For more information about using this port, see [Using the IrDA Port](#) on page 8-2.

Note: The infrared LED aperture is located behind the IrDA Port window.

Right Side

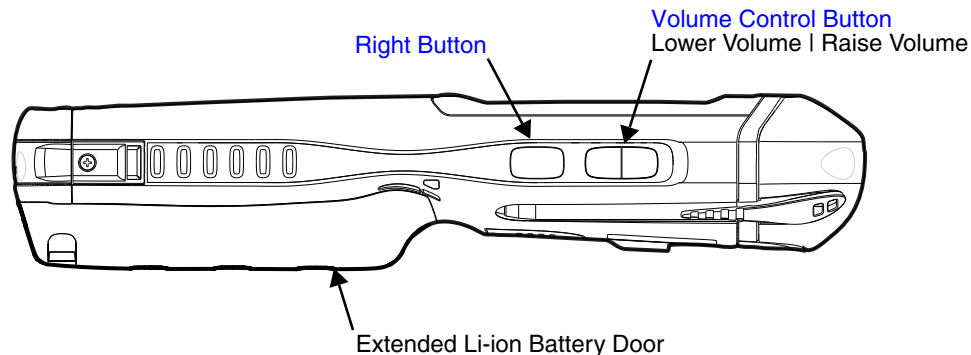

Right Button

By default, the Right Button triggers the scanner/imager. You can reassign the button to launch applications or execute commands. For additional information, see [Changing Button Assignments](#) on page 7-4.

Volume Control Button

Press the top or bottom of the volume button to raise or lower the volume of the active speaker.

Bottom Panel: 99EX

Pin	Description
1	GND
2	GND
3	USBC_DET
4	USBC_D-
5	RTS
6	USBC_D+
7	DTR
8	SPK
9	Audio_GND
10	MIC
11	CTS
12	USBH_D-
13	5V_OUT
14	USBH_D+
15	TXD
16	RXD
17	VCC
18	VCC

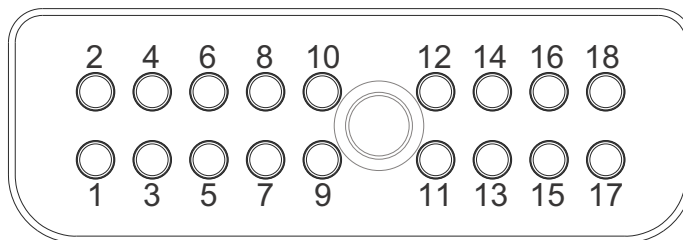

Note: Signals referenced are for a DTE device.

I/O Connector

The I/O connector powers the terminal, charges the main battery, and facilitates communication. All Dolphin peripherals are designed to work exclusively with this connector.

The I/O connector supports RS232 and high speed USB v2.0 communication. For RS232, the maximum communication speed is 115.2 Kbps with seven baud rate settings. For USB, the communication speed is up to 480 Mbps.

I/O Power Out

The I/O connector also provides power out (to peripheral devices) +5V at 500mA. This means that, with the proper cable, the terminal can power another device. By default, power out is disabled, but the 5V output may be enabled, see [Five Volt Control](#) on page 7-12.

Using the Touch Panel

Honeywell defines proper use of the terminal touch panel as using a screen protector and proper stylus. Screen protectors maintain the ongoing integrity (i.e., prevent scratching) of the touch panel, which is why their use is recommended for applications that require a high to medium level of interface with the touch panel, such as signature capture for proof of delivery.

Honeywell advocates the use of screen protectors on all Dolphin devices. We recommend implementing a screen protector replacement program to ensure that screen protectors are replaced periodically when signs of damage/wear are noticeable. Replacement screen protectors can be purchased directly from Honeywell. Please contact a Honeywell sales associate for details.

Honeywell also mandates use of a proper stylus, which is one that has a stylus tip radius of no less than 0.8 mm. Use of the Honeywell stylus included with the terminal is recommended at all times.

Honeywell warranty policy covers wear on the touch panel for the first twelve (12) months if a screen protector is applied and an approved stylus is used for the 12 month duration covered by the warranty.

Installing a Screen Protector

Dolphin terminals ship with a screen protector already installed. You will need to replace the screen protector at regular intervals.

1. After the current screen protector has been removed from the touch panel, clean the touch panel thoroughly with a clean, non-abrasive, lint-free cloth. Make sure there is no debris on the touch panel.
2. Align the exposed section of the protector with the bottom edge of the touch panel. Make sure that the screen protector is flush with each side of the touch panel. To reposition, lift up gently and reapply.
3. Press the screen protector firmly and carefully across the surface of the touch panel as you peel away the backing.
4. If necessary, smooth out any air pockets or bumps.

Batteries

There are three types of battery power: the main battery pack installed in the back panel, the backup battery located inside the terminal and the Real Time Clock (RTC) battery located inside the terminal. They are designed to work together to prevent data loss when the terminal is in use over long periods. All batteries must be completely charged before using a Dolphin terminal for the first time!

Note: The RTC battery will preserve the Real Time Clock 60 days after the main battery and internal backup battery are fully depleted.

Main Battery Pack



We recommend use of Honeywell Li-poly or Li-ion battery packs. Use of any non-Honeywell battery may result in damage not covered by the warranty.

Dolphin 99EX model terminals intended for use in potentially explosive atmospheres are designed for use only with standard battery pack model 99EX-BTSC (Li-poly 3.7V, 11.3 watt hour) or extended battery pack model 99EX-BTEC (Li-ion 3.7V, 18.5 watt hour) manufactured for Honeywell International Inc.

Note: Replace only with battery pack model 99EX-BTSC (PN 99EX-BTSC-2) or 99EX-BTEC (PN 99EX-BTEC-2) manufactured for Honeywell International Inc.

The standard or extended battery pack is the primary power source for the terminal. The Li-poly and Li-ion battery packs are designed to operate in a temperature range of -10° to 50°C (14° to 122°F).



CAUTION - Read the Guidelines for Battery Pack Use and Disposal on page 3-14 and all cautionary markings on the battery, charging peripheral, or device using the battery before attempting to install, use, or charge the battery. **Risk of fire and burns if improperly handled. Do not open, crush, heat above 60°C (140°F), or incinerate.**

Charging Options

When the main battery pack is installed in the terminal, use one of the following peripherals:

- [Dolphin 99EX HomeBase Device \(Model 99EX-HB\)](#) (see page 12-1)
- [Dolphin 99EX eBase Device \(Model 99EX-EHB\)](#) (see page 13-1)
- [Dolphin 99EX Mobile Base Device \(Model 99EX-MB\)](#) (see page 14-1)
- [Dolphin 99EX ChargeBase Device \(Model 99EX-CB\)](#) (see page 15-1)
- [Dolphin 99EX Net Base Device \(Model 99EX-NB\)](#) (see page 16-1)

When the main battery pack is not installed in the terminal:

- Place the battery pack in the [Dolphin 99EX QuadCharger Device \(Model 99EX-QC\)](#) (see page 17-1)
- Place the battery pack in the [Auxiliary Battery Well](#) of the [Dolphin 99EX HomeBase Device \(Model 99EX-HB\)](#) (see page 12-3) or [Dolphin 99EX eBase Device \(Model 99EX-EHB\)](#) (see page 13-1).

For information on how to remove the main battery pack from the terminal, see [Replacing the Main Battery Pack](#) on page 2-6.

Note: The communications/charging circuits connected to the equipment provide the transient protection set at a level not exceeding 140% of the peak rated voltage value of the IO terminal.

Charging Time

The standard 3.7V Li-poly battery pack requires 4 hours to charge completely before initial use. The extended 3.7V Li-ion battery pack requires 6 hours to charge completely before initial use. Honeywell recommends charging the Dolphin terminal for at least 24 hours prior to initial use to ensure the internal backup battery is fully charged.

Battery Error Notification

If your terminal displays the following indicators, replace the main battery pack with a new Honeywell battery pack. For information on how to remove the main battery pack from the terminal, see [Replacing the Main Battery Pack](#) on page 2-6.

-  appears in the Title bar at the top of the touch screen.
- The General Notification LED flashes red.
- A Notification appears on the Tile bar at the bottom of the touch screen.

Storing Batteries

To maintain top performance from batteries, avoid storing batteries outside of the following temperature ranges:

- 14°F to 113°F (-10°C to +45°C) for short term storage of less than one month
- 32°F to 86°F (-0°C to +30°C) for long term storage

Do not store batteries in extremely high humidity. For prolonged storage, do not keep batteries stored in a charger that is connected to a power source.

Guidelines for Battery Pack Use and Disposal

The following are general guidelines for the safe use and disposal of batteries:

- Do not disassemble or open crush, bend or deform, puncture or shred.
- Do not modify or remanufacture, attempt to insert foreign objects into the battery, immerse or expose to water or other liquids, expose to fire, explosion or other hazard.
- Improper battery use may result in a fire, explosion or other hazard.
- We recommend use of Honeywell Li-ion or Li-poly battery packs. Use of any non-Honeywell battery may pose a personal hazard to the user.
- Only use the battery for the system for which it is specified. Do not use a battery in any other manner outside its intended use in Dolphin terminals and peripherals.
- Only use the battery with a charging system that has been qualified with the system per standard IEEE-Std-1725-2006. Use of an unqualified battery or charger may present a risk of fire, explosion, leakage, or other hazard.
- Replace the battery only with another battery that has been qualified with the system per this standard, IEEE-Std-1725-2006. Use of an unqualified battery may present a risk of fire, explosion, leakage or other hazard.
- Replace defective batteries immediately; using a defective battery could damage the Dolphin terminal.
- Never throw a used battery in the trash. Promptly dispose of used batteries in accordance with local regulations.
- Do not short-circuit a battery or throw it into a fire; it can explode and cause severe personal injury. Do not allow metallic conductive objects to contact battery terminals.
- If you observe that the Honeywell battery supplied is physically damaged, please send it to Honeywell International Inc. or an authorized service center for inspection, see [Product Service and Repair](#) on page 18-1..
- Avoid dropping the terminal or battery. If the terminal or battery is dropped, especially on a hard surface, and the user suspects damage, send it to a Honeywell International Inc. or an authorized service center for inspection, see [Product Service and Repair](#) on page 18-1.
- If you are not sure the battery or charger is working properly, send it to Honeywell International Inc. or an authorized service center for inspection.
- Excessive discharge can degrade battery performance. Recharge the battery when your terminal indicates low battery power.
- Although your battery can be recharged many times, the battery life is limited. Replace it after the battery is unable to hold an adequate charge.

The following warnings apply to **99EXXXX-XXXXXXXI** models (See [Approvals by Country](#) on page 1-4.)

Note: Replace only with battery pack model 99EX-BTEC (PN 99EX-BTEC-2) or 99EX-BTSC (PN 99EX-BTSC-2) manufactured for Honeywell International Inc.



CAUTION - DANGER OF EXPLOSION IF BATTERY IS INCORRECTLY REPLACED. REPLACE ONLY WITH THE SAME OR EQUIVALENT TYPE.

ATTENTION - RISQUE D'EXPLOSION SI LA PILE N'EST PAS REMPLACÉ CORRECTEMENT. REMPLACIER UNIQUEMENT PAR UNE PILE DE TYPE IDENTIQUE OU ÉQUIVALENT.

The following warnings apply to **99EXXXX-XXXXXXXI** models (See [Approvals by Country](#) on page 1-4.)



WARNING - EXPLOSION HAZARD - BATTERIES MUST ONLY BE CHANGED IN AN AREA KNOWN TO BE NON-HAZARDOUS.

AVERTISSEMENT - RISQUE D'EXPLOSION-AFIN D'EVITER TOUT RISQUE D'EXPLOSION, S'ASSURER QUE L'EMPLACEMENT EST DESIGNÉ NON DANGEREUX AVANT DE CHANGER LA BATTERIE.



Warning: Explosion hazard. Do not disconnect battery unless the area is known to be free of ignitable concentrations.



Warning: Explosion Hazard. Charge or replace the battery only in an area known to be non-hazardous.



Warning: Explosion Hazard. Do not replace components unless power has been switched off or the area is known to be non-hazardous.



Warning: Substitution of any components may impair suitability.



Warning: Explosion Hazard. Do not use external connectors in areas known to be hazardous.



Warning: Explosion Hazard. Do not use the terminal in areas known to be hazardous if the I/O cover is damaged, missing or not properly installed (e.g., missing M2 screws).



Warning: Explosion Hazard. Do not use the terminal in areas known to be hazardous if the terminal is damaged, for example: a crack in the display or enclosure, missing keypad buttons or side buttons, or the terminal battery well seal is missing or cracked.

Internal Backup Battery

Located inside the terminal is a 3.6 Volt nickel metal hydride (NiMH) backup battery. The backup battery prevents the terminal from being reset if you need to replace the main battery pack. It retains RAM data during the battery pack exchange. A fully charged backup battery provides 30 minutes of backup time.

*Note: When removing a battery from the terminal, put the device in [Suspend Mode](#) (see page 2-13) before removing the battery door. Once the battery door is removed, **wait at least 3 seconds** before removing the main battery. This process allows the device to shut down properly and maintain memory during the battery swap.*

If at any time the backup battery becomes fully discharged of power (e.g., the terminal is left without the main battery pack for more than 30 minutes), the terminal resets when power is supplied. All files are retained, but you may need to restart any running applications. In addition, a fully discharged backup battery requires a minimum of 24 hours of charging time to reach a full charge.

Note: Data and programs stored in Flash memory are not lost even if the internal backup battery fails.

Charging

The internal backup battery and the RTC battery are powered by the main battery pack. Therefore, charging the internal batteries requires a charged main battery pack be installed in the terminal and the terminal be connected to a charging device.

The internal backup battery must be fully charged before using the terminal for the first time. Honeywell recommends charging the Dolphin terminal for at least 24 hours prior to initial use to ensure the internal backup battery is fully charged. After that, if the internal backup battery becomes fully discharged of power, it requires a minimum of 24 hours of charging time to function normally.

Guidelines for Use

Follow these guidelines to maximize the life of the internal backup battery:

- Keep a charged battery pack in the terminal; the backup battery prematurely discharges if there is not at least a partially charged battery in the terminal.
- Keep the terminal connected to power when the terminal is not in use.

Managing Battery Power

Letting the backup battery become fully discharged causes the terminal to lose all data in RAM. Honeywell recommends, you keep a charged battery pack in the terminal at all times to help prevent data loss. The internal battery discharges prematurely if there is not at least a partially charged battery in the terminal. When you remove a battery pack, insert another charged battery pack in the terminal immediately.

Default Critical and Low Battery Points

When the terminal is running on battery power (as opposed to external power), warnings are displayed when the battery reaches critical and low battery points. The warning points are determined by the following registry entry:

[HKEY_LOCAL_MACHINE\ControlPanel\Power]

There are two DWORD values in this registry entry: **MedState** and **LowState**.

The default values for these entries are as follows:

MedState=25%

This sets the Low Battery point to 25%. When the battery hits the percentage charge specified here, the user is notified.

LowState=10%

This sets the Critical Battery point to 10%. When the battery hits the percentage charge specified here, the user is notified.

Note: Warnings do not appear when the terminal is on external power.

Setting Critical and Low Battery Points

Developers can reset the battery parameters in the registry from 0 (no warning) to 99 (would nearly always warn). You can review and set these battery points in the RegEdit Power Tool.

1. Tap  > **Power Tools** > **RegEdit**.
2. Drill down to **HKEY_LOCAL_MACHINE** > **ControlPanel** > **Power**.

-
3. Tap the **Value Name** to change the Value Data.
You can reset the Value Data from 0 (no warning) to 99 (would nearly always warn).
 4. Tap **OK** to save changes.

For more information about the RegEdit Power Tool, refer to the Dolphin Power Tools User's Guide available for download at www.honeywellaidc.com.

Checking Battery Power

1. Tap  > **Settings** > **System**
2. Tap **Power** to view the power status of the main battery and backup battery or tap **Battery** to view detailed information on the installed battery pack.

Note: The Backup Battery gauge registers either 0% or 100%. The percentage is not an indication of the level of charge remaining on the backup battery. An installed and functional battery registers 100%. A total discharge or a battery error registers 0%.

For additional information on Advanced Power Settings, [see page 7-16](#).

For additional information on the Battery Log Configuration, [see page 7-10](#).

System Resets

See [Resetting the Terminal](#) on page 2-13.

Hardware Maintenance

When needed, clean the image engine window and the LCD display with a clean, non-abrasive, lint-free cloth. The terminal can be cleaned with a damp cloth.



Installing a Memory Card

 Carefully read all the information under [Equipment Intended for Use in Potentially Explosive Atmospheres](#) on page 2-1 before you attempt to install a card.

Honeywell recommends the use of Single Level Cell (SLC) industrial grade microSD or microSDHC memory cards with Dolphin terminals for maximum performance and durability. Contact a Honeywell sales representative for additional information on qualified memory card options.

Note: Format all microSD/SDHC cards before initial use.

To install a memory card:

1. Press the Power key  to put the terminal in Suspend Mode.
2. Release the hand strap hook near the speaker on the back panel of the terminal.
3. Remove the battery door.
4. **Wait at least 3 seconds**, and then remove the battery.
5. Remove the T6 TORX[®] screw securing the protective door closed.
6. Lift up the lower left corner of the door to access the memory socket.
7. Unlock  the access door to the memory socket by sliding the door toward the IrDA port side of the terminal.
8. Lift the door up to expose the socket.
9. Slide the microSD or microSDHC card into the door of the socket.

Note: Make sure the interface on the memory card is connected to the interface in the socket; align the notch on the card with the notch of the socket.

10. Close and lock  the access door.
11. Close the protective door over the memory socket. Install and tighten the T6 screw to secure the door closed.
12. Install the battery and the battery door. Reattach the hand strap to the terminal.
13. Press the Power key or SCAN key to wake the terminal.

Installing a SIM Card

See [Installing a SIM Card](#) on page 9-4.

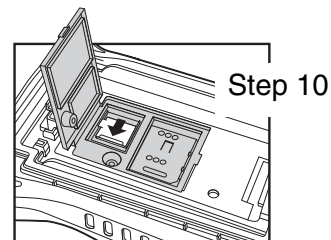
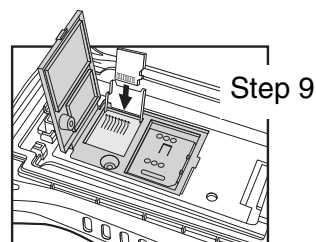
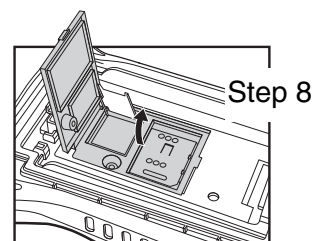
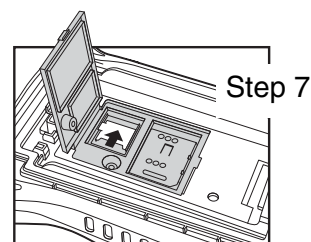
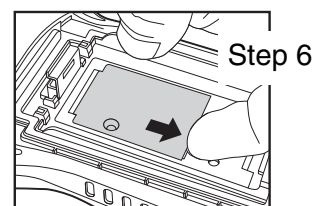
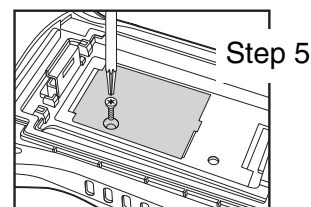



Using the Scan Image Engine

Overview

The Dolphin terminal houses a compact image engine that instantly reads popular 1D and 2D bar codes and supports omni-directional aiming and decoding for greater flexibility in real-world settings. The image engine can also capture black and white digital images, such as signatures and pictures of damaged inventory.

With the latest CMOS-based technology, the engine works like a digital camera and enables black and white digital image capture, signature capture, and reading of OCR characters.

Angled Imaging

All imagers are installed at a 25 degree downward-facing angle for enhanced comfort and maneuverability while scanning.

Laser Safety

See [Laser Safety](#) on page 1-1.

N5603 Beam Divergence Angle

Engines	Horizontal Beam Divergence Angle (degrees)	Vertical Beam Divergence Angle (degrees)
N5603SR/HD	18.1	14.3
N5603ER	13.1	9.9

LED Safety

See [LED Safety](#) on page 1-2.

Image Engine Specifications

Engines	1D	2D	Image Capture	Aiming Pattern	Omni-Directional Aiming
N5603SR/ER/HD	Y	Y	Y	N5603 Red High-Vis Aiming Pattern (page 4-5) See Laser Safety on page 1-1.	Y
N5600SR/ER/HD	Y	Y	Y	N5600 Green Aiming Beam (page 4-5)	Y

Depth of Field

The depth of field measurements used the following parameters:

- Distances are measured from the front of the engine.
- +23°C (+73°F), 0 lux
- Photographic quality codes

Focus	N5603/N5600 High Density (HD)			N5603/N5600 Standard Range (SR)			N5603/N5600 Extended Range (ER)		
	Distance (in/cm)		Delta (in/cm)	Distance (in/cm)		Delta (in/cm)	Distance (in/cm)		Delta (in/cm)
	Near	Far		Near	Far		Near	Far	
3 mil C39/128	2.0 (5.1)	3.4 (8.6)	1.4 (3.6)	-	-	-	-	-	-
5 mil C39/128	1.4 (3.6)	4.8 (12.2)	3.4 (8.6)	2.7 (6.9)	6.3 (16.0)	3.6 (9.1)	5.4 (13.7)	9.0 (22.9)	3.6 (9.1)
7.5 mil C39/128	1.4 (3.6)	5.6 (14.2)	4.2 (10.7)	2.5 (6.4)	9.2 (23.4)	6.7 (17)	4.2 (10.7)	12.6 (32.0)	8.4 (21.3)
10 mil C39/128	1.4 (3.6)	5.5 (14.0)	4.1 (10.4)	1.6 (4.1)	13.2 (33.5)	11.6 (29.5)	3.1 (7.9)	17.2 (43.7)	14.1 (35.8)
15 mil C39/128	1.3 (3.3)	7.8 (19.8)	6.5 (16.5)	1.8 (4.6)	19.0 (48.3)	17.2 (43.7)	2.4 (6.1)	20.9 (53.1)	18.5 (47.0)
20 mil C39/128	2.3 (5.8)	9.2 (23.4)	6.9 (17.5)	2.2 (5.6)	20.1 (51.1)	17.9 (45.5)	2.9 (7.4)	24.0 (61.0)	21.1 (53.6)
100% UPC	1.9 (4.8)	7.1 (18)	5.2 (13.2)	1.8 (4.6)	16.5 (41.9)	14.7 (37.3)	2.7 (6.9)	19 (43.3)	16.3 (41.4)
5 mil PDF417	1.4 (3.6)	4.8 (12.2)	3.4 (8.6)	2.6 (6.6)	5.2 (13.2)	2.6 (6.6)	6.1 (15.5)	7.4 (18.8)	1.3 (3.3)
6.7 mil PDF417	1.4 (3.6)	4.8 (12.2)	3.4 (8.6)	2.0 (5.1)	6.5 (16.5)	4.5 (11.4)	4.7 (11.9)	9.8 (24.9)	5.1 (13.0)
10 mil PDF417	1.7 (4.3)	6.2 (15.7)	4.5 (11.4)	1.5 (3.8)	11.0 (27.9)	9.5 (24.1)	2.4 (6.1)	15.0 (38.1)	12.6 (32.0)
5 mil MicroPDF	1.8 (4.6)	3.4 (8.6)	1.6 (4.1)	-	-	-	-	-	-
5 mil Data Matrix	1.9 (4.8)	3.1 (7.9)	1.2 (3.0)	-	-	-	-	-	-
10 mil Data Matrix/Aztec	1.7 (4.3)	5.3 (13.5)	3.6 (9.1)	2.2 (5.6)	7.9 (20.1)	5.7 (14.5)	5.1 (13.0)	10.5 (26.7)	5.4 (13.7)
20 mil Data Matrix	2.1 (5.3)	7.8 (19.8)	5.7 (14.5)	2.0 (5.1)	15.3 (38.9)	13.3 (33.8)	3.6 (9.1)	18 (45.7)	14.4 (36.6)

10 mil QR	3.3 (8.4)	5.0 (12.7)	1.7 (4.3)	2.2 (5.6)	7.1 (18.0)	4.9 (12.4)	4.3 (10.9)	10.6 (26.9)	6.5 (16.5)
20 mil QR	2.2 (5.6)	7.9 (20.1)	5.7 (14.5)	2.2 (5.6)	15.5 (39.4)	13.3 (33.8)	2.4 (6.1)	19.6 (49.8)	17.6 (44.7)
32 mil Maxicode	2.4 (6.1)	8.6 (21.8)	6.2 (15.7)	2.5 (6.4)	17.0 (43.2)	14.5 (36.8)	3.9 (9.9)	23.2 (58.9)	19.5 (49.5)

Supported Bar Code Symbolologies

Symbology Type	Symbology Name
1D Symbolologies	Codabar Codablock F Code 3 of 9 Code 11 Code 32 Pharmaceutical (PARAF) Code 93 Code 128 EAN with Add-On EAN with Extended Coupon Code EAN-8 EAN-13 GS1-128 GS1 Databar Interleaved 2 or 5 ISBT 128 Matrix 2 of 5 MSI Plessey Straight 2 of 5 IATA Straight 2 of 5 Industrial Telepen Trioptic Code UPC with Add On UPC-A UPC-E
2D Symbolologies	Aztec Codablock A Codablock F GS1 Databar MaxiCode Micro PDF Data Matrix PDF417 QR Code
Composite Codes	UPC/EAN UCC/EAN GS1 Databar
OCR	MICR (E 13 B) and SEMI Font OCR-A OCR-B
Postal Codes	Postnet and most international 4-state codes Australian Post British Post Canadian Post China Post Japanese Post KIX (Netherlands) Post Korea Post Planet Code

Decoding

The terminal supports two types of image decoding for use in various bar code reading and imaging applications: full-area imaging and Advanced Linear Decoding (ALD).

Full-Area Imaging

Full-area imaging provides omni-directional reading of linear and non-linear 1D and 2D bar codes, OCR, signature capture, and picture taking. When reading all bar code types using full-area imaging, a positive read can be obtained from many positions; see [Aiming Options](#) on page 4-4. To achieve the best read, the aiming beam should be centered horizontally across the bar code.

ALD

ALD provides fast reading of linear and stacked linear bar codes. To achieve a positive read when reading linear 1D and PDF417 bar codes, the green aiming beam should be centered horizontally across the bar code. When ALD is enabled, the reader does not read matrix or postal codes.

To Decode a Bar Code

The aiming beam should be oriented in line with the bar code to achieve optimal decoding. A range of 4-10 inches (10-25 cm) from the bar code is recommended.

1. Tap  > **Demos**  > **Scan Demo** .
2. Point the Dolphin terminal at the bar code.

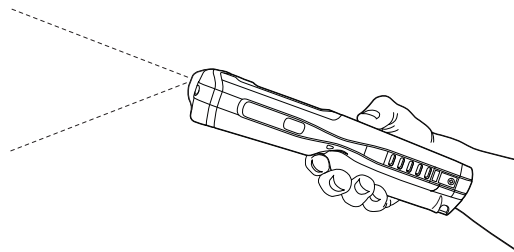

3. Project the aiming beam or pattern by pressing and holding one of the following:
 - the SCAN key (all models) or
 - one of the terminal's side buttons (all models).
4. The scan LED lights red.
5. Center the aiming beam over the bar code; see [Aiming Options](#) on page 4-4.
6. When the bar code is successfully decoded, the decode LED lights green and the terminal beeps.
7. The bar code information is entered into the application in use.

Aiming Options

The aiming beams are smaller when the terminal is held closer to the code and larger when it is farther from the code. Symbologies with smaller bars or elements (mil size) should be read closer to the unit whereas symbologies with larger bars or elements (mil size) should be read farther from the unit.

N5603 Red High-Vis Aiming Pattern

If your Dolphin terminal is configured with a 5603 imager, high-vis aimers frame the bar code for more intuitive aiming. See [Laser Safety](#) on page 1-1.

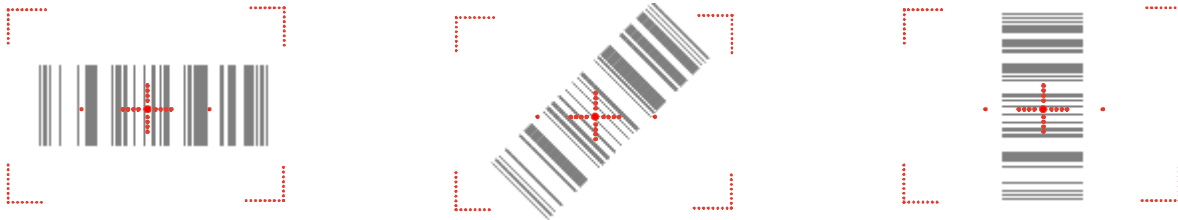

N5600 Green Aiming Beam

Linear Bar Code



2D Matrix Symbol



Capturing Images

The image-capture process is an intuitive, split-second operation for experienced users. By following the basic guidelines, new users can easily develop their own technique and, with practice, quickly learn to adapt it to different application environments.

Image Preview

When the imaging process is initiated, the touch screen displays a preview of the object. This is a live video image of what the imager is currently viewing. The live video image has a slightly degraded appearance compared to the captured image. This is normal.

Scan Key

On all 99EX terminals, the SCAN key captures images.

File Formats

File formats supported for image storage include Bitmap (BMP), JPEG (JPG) and Portable Network Graphics (PNG). The default file format for images is a grayscale JPG.



Compression

Digital images have a maximum image size of 640 x 480 pixels and may have up to a 256 grayscale image definition.

The image quality and related file size are determined by the data compression method used by the software application used to take images. The average size of the image file is approximately 4–8K. However, the size of the image depends on the content of the image - the more complex the content, the larger the file size.

Taking an Image

The following steps are basic guidelines for taking images:

1. Tap  > **Demos** > **Imaging Demo** .
2. Point the Dolphin terminal at the object.

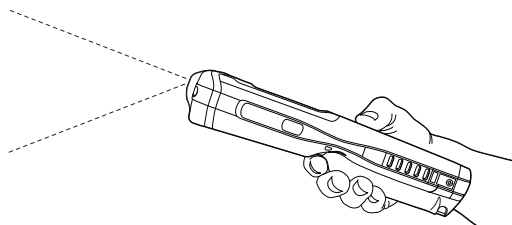

3. To preview the image, press and hold one of the following:
 - the SCAN key (all models) or
 - one of the terminal's side buttons (all models).
4. The touch screen displays a preview of the object, and the decode and scan LEDs light red.
5. Adjust the terminal's position until the object appears on the screen the way you want it to appear in the image.

-
6. Hold the terminal still and release the SCAN key. The scan and decode LEDs flash red, the screen flashes, and the captured image appears on the screen.
 7. Unless otherwise specified by the application in use, the image is saved to the **My Device\My Documents** folder.

Enabling the Aimer

You can enable the aiming pattern for imaging in the Imaging Demo. For details about the aimer, see [Aiming Options](#) on page 4-4.

1. Tap  > **Demos** > **Imaging Demo** > **Setup** menu > **Aimer**.

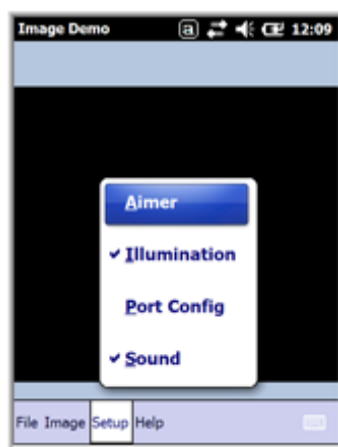

2. The aiming pattern is now enabled for imaging.

Uploading Images

Image files can be uploaded to a host workstation via Microsoft ActiveSync and a Dolphin communication peripheral or your wireless radio connection.

Note: You can download the most current version of ActiveSync from www.microsoft.com.

Note: Visit the [Microsoft Windows 7 web site](#) for information on how to sync your music, pictures, contacts and calendars using Device Stage.

Note: Visit the [Microsoft Windows Vista web site](#) for information on how to sync your music, pictures, contacts and calendars using Windows Mobile Device Center.



We recommend use of Honeywell peripherals, power cables, and power adapters. Use of any non-Honeywell peripherals, cables, or power adapters may cause damage not covered by the warranty.





Using the Color Camera



Overview

Dolphin terminals equipped with a 3.1-Megapixels Resolution color camera with Automated Camera Control (ACC), and an Application Programming Interface (API) provide easy integration of color picture and video capture into business applications. The camera lens and camera flash are located on the back panel of the terminal.

Taking a picture using the Camera Demo tool

1. Tap  > **Demos**  > **Camera Demo** .
2. Adjust the camera settings using the icon menu at the top of the display screen.



3. Point the terminal's camera lens at the object you want to capture. The camera lens is located on the back panel of the terminal.
4. Center the object in the touch screen display.
5. Press the ENT key  or tap **Snap** . The terminal's red LED illuminates during picture capture.

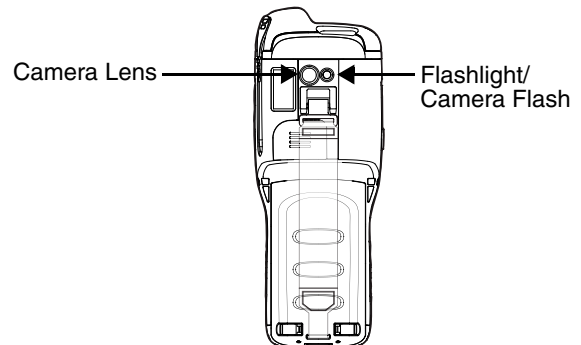

Note: Tap the green arrow  to review or edit your pictures.

Tap the green box  to exit the picture review/edit screen.

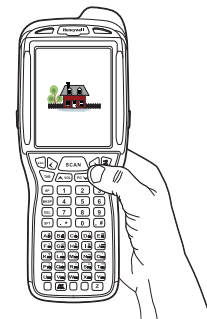

Options

Tap **Options** > **Camera**.

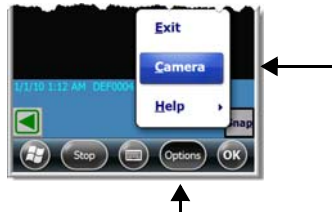

The Camera Options menu appears. There are five tabs of configurable options accessible from the Camera Options menu.

Profile Tab

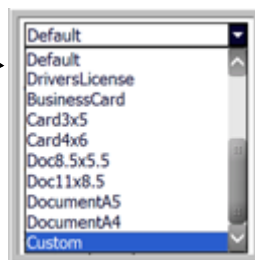
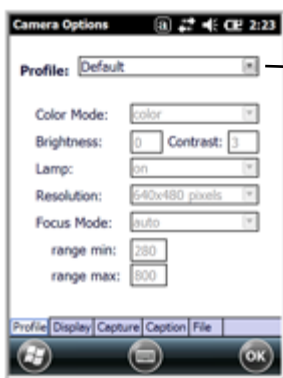

The profile tab allows you to customize your camera settings, or chose from several predefined profiles designed to provide the best picture quality for common tasks.

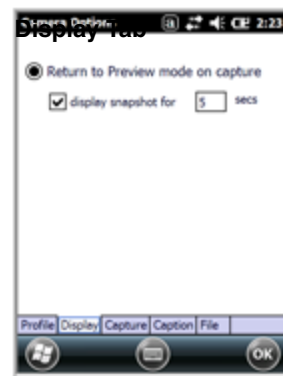

Capture Tab

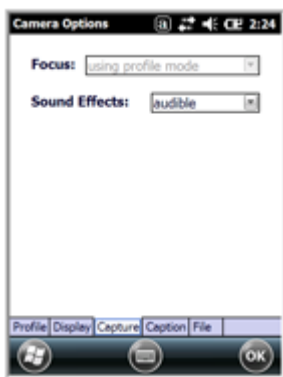



Caption Tab

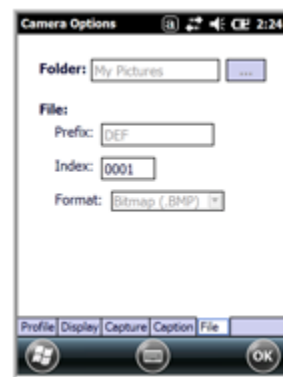

File Tab



Taking a picture using the Windows Embedded Handheld 6.5 Camera tool

1. Tap  > **Pictures & Videos** > **Camera**
2. Point the terminal's camera lens at the object you want to capture. The camera lens is located on the back panel of the terminal.
3. Center the object in the touch screen display.
4. Press the ENT key .
5. The touch screen displays the captured photo.

Menu

Tap **Menu** on the Command Bar to adjust the camera settings, switch to video mode, and access additional camera options.

Item	Descriptions
Video	Activate Video Mode
Mode	Set Mode (i.e., Normal, Burst, or Timer)
Resolution	Set Picture Resolution (i.e., QVGA, VGA, SVGA, XGA, UXGA, or QXGA)
Zoom	Set Zoom (i.e., x1, x2, or x3)
Flash	Set Camera Flash On or Camera Flash Off
Focus	Set Focus Off, Focus On, Focus on Trigger, or Fixed-Focus
Brightness	Set the brightness setting from +2.0 EV to -2.0 EV in .5 EV increments
Full Screen	Switch to full screen mode
Options	Set Camera Options, Video Options, Slide Show Options or General Options

Options

Tap **Menu > Options**. The Options menu contains four screens:

General Tab



Slide Show Tab



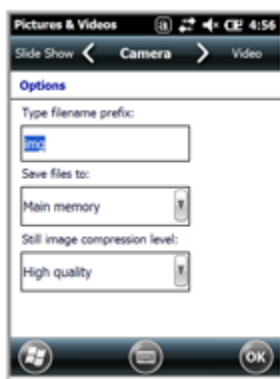

Camera Tab



Video Tab



Recording Video

1. Tap  > **Pictures & Videos > Camera > Menu > Video**
2. Point the terminal's camera lens at the object you want to capture.
3. Press the ENT key  to start recording.
4. Tap Stop or press ENT to stop recording.



Using the Keyboards

Available Keyboards

There are four keyboard options in the 99EX series:

34-Key Alpha/Numeric
Keyboard



34-Key Numeric
(Calculator) Keyboard



43-Key Alpha/Numeric
Keyboard



55-Key Full Alpha/
Numeric Keyboard



All Keyboards Contain the Following:

- Backlit for easy viewing in various lighting conditions.
- Centrally located Scan key for both right- and left-hand operation.
- Color-coding so you can clearly see the most common keyboard combinations.
- Function, navigation, and modifier keys.

Keyboard Combinations

See [34-Key Alpha/Numeric Keyboard Combinations](#) on page 6-6.

See [34-Key Numeric \(Calculator\) Keyboard Combinations](#) on page 6-9.

See [43-Key Keyboard Combinations](#) on page 6-12.

See [55-Key Keyboard Combinations](#) on page 6-14.















Common Buttons

See [Using the Function Keys](#) on page 6-2.







See [Using the Modifier Keys](#) on page 6-3.

See [Using the Navigation Keys](#) on page 6-3.

Using the Function Keys





Name	Key	Function
Backlight		Turns the keyboard backlight on and off.
Flashlight		Turns the flashlight on and off. The flashlight is located on the back panel of the terminal.
Backspace (BKSP)	 34-Key  43-Key  55-Key	Moves the cursor back one space each time the key is pressed. If you are typing text, it deletes the previous character each time it is pressed.
Delete (DEL)	 34-Key  55-Key	Deletes the next character each time the key is pressed. This key only appears on the 34-key and 55-key keypad options.
Enter (ENT)		Confirms data entry.
Escape (ESC)		Cancels the current action.
Power Key		Puts the terminal in and wakes the terminal from Suspend Mode; see Suspend Mode on page 2-13.
SCAN Key		Activates the scan and “wakes” the terminal from Sleep Mode. Its position allows convenient one-handed image-taking and/or bar code decoding.
Space (SP)	 34-Key  43-Key  55-Key	Moves the cursor one space.
Tab		Moves the cursor to the next tab stop or the next control (on a form).



Using the Modifier Keys

Name	Key	Function
ALPHA	 34-Key	The ALPHA key enables you to toggle between the alpha and numeric modes. See ALPHA Key on page 6-5.
Blue and Red	 Blue  Red	The blue and red keys are used in combination with other keys to type special characters and perform system functions. Each key modifies only the next key pressed. Each keyboard is color-coded to indicate the character typed or function performed when specific keys are pressed immediately after the blue or red modifier key.
Number Lock (NUM)	 43-Key	The Number Lock key enables you to toggle between the alpha and numeric modes. See Number Lock (NUM) Key on page 6-11.
Shift (SFT)	 34-Key  43-Key  55-Key	The shift key modifies only the next key pressed; it must be pressed before each key you wish to modify. Shift toggles the keyboard between uppercase alphabet mode and lowercase alphabet mode. Press the shift key twice to toggle Caps Lock on and off. When Caps Lock is toggled on, characters are uppercase; when toggled off, characters are lowercase.

Using the Navigation Keys

Located in the center of each keyboard for easy access with either hand, the navigation keys navigate the cursor through application screens.

Key	Function
	Moves the cursor up one row or line.
	Moves the cursor down one row or line.
 Blue	Raises the volume.
 Blue	Lowers the volume.
 Red	Moves the cursor up one page.

Key	Function
 Red	Moves the cursor down one page.
	Moves the cursor one character to the right.
	Moves the cursor one character to the left.

Note: Additional functionality varies according to the application in use.

34-Key Alpha/Numeric Keyboard

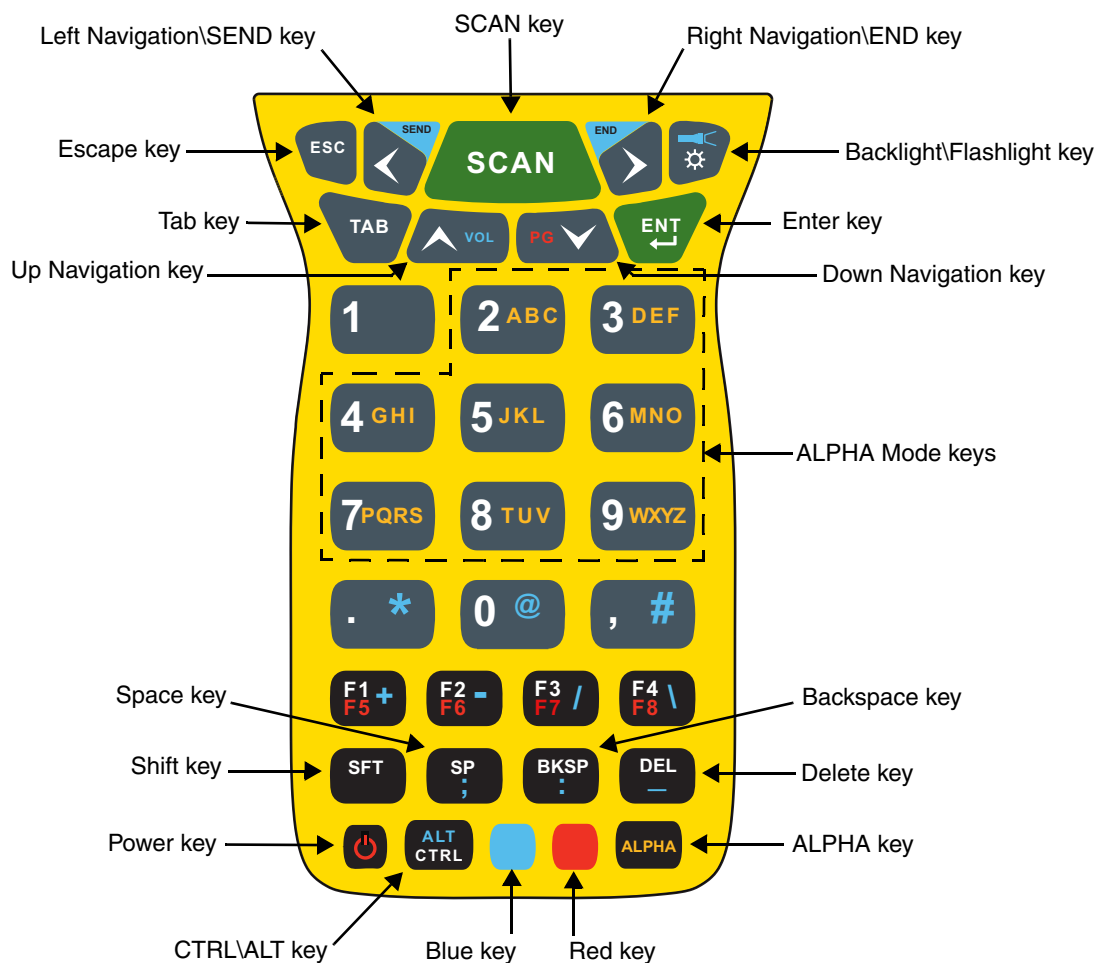

ALPHA Key

The ALPHA lock key enables you to toggle between the alpha and numeric keyboard modes. On the 34-Key Keyboard, numeric mode is the default. Press the ALPHA key once to switch to ALPHA lock mode. Press the ALPHA key again to exit the ALPHA lock mode.

34-Key Alpha/Numeric Keyboard Combinations

Key	NUM (Default)	Shift-NUM	ALPHA	Shift- ALPHA	Blue	Red
ESC	Escape					
Left	Left	Left	Left	Left	Send (Phone)	Left
Scan	Scan					
Right	Right	Right	Right	Right	End (Phone)	Right
Backlight	Toggles Keyboard Backlight On/Off				Toggles Flashlight On/Off	Toggles Keyboard Backlight On/ Off
TAB	Tab	Tab	Tab	Tab	Tab	Tab
Up	Up	Up	Up	Up	Volume Up	Prior
Down	Down	Down	Down	Down	Volume Down	Next
Enter	Return					
1	1	!				
2	2	@	a,b,c	A,B,C		
3	3	#	d,e,f	D,E,F		
4	4	\$	g,h,i	G,H,I		
5	5	%	j,k,l	J,K,L		
6	6	^	m,n,o	M,N,O		
7	7	& (ampersand)	p,q,r,s	P,Q,R,S		
8	8	* (multiply)	t,u,v	T,U,V		
9	9	(w,x,y,z	W,X,Y,Z		
Period	. (period)	>	. (period)	>	* (multiply)	
0	0)			@	
Comma	, (comma)	<	, (comma)	<	#	

Key	NUM (Default)	Shift-NUM	ALPHA	Shift- ALPHA	Blue	Red
F1	F1	F1	F1	F1	+	F5
F2	F2	F2	F2	F2	-	F6
F3	F3	F3	F3	F3	/	F7
F4	F4	F4	F4	F4	\	F8
SFT	Shift	Shift	Shift	Shift		
SP	Space	Space	Space	Space	;	Space
BKSP	Backspace	Backspace	Backspace	Backspace	:	Backspace
DEL	Delete	Delete	Delete	Delete	Underscore	Delete
Power	Off/On					
CTRL	Control		Control		Menu	
Blue	Blue		Blue		Blue	
Red	Red		Red			Red
ALPHA	Toggles between ALPHA mode and NUM Lock mode					

34-Key Numeric (Calculator) Keyboard

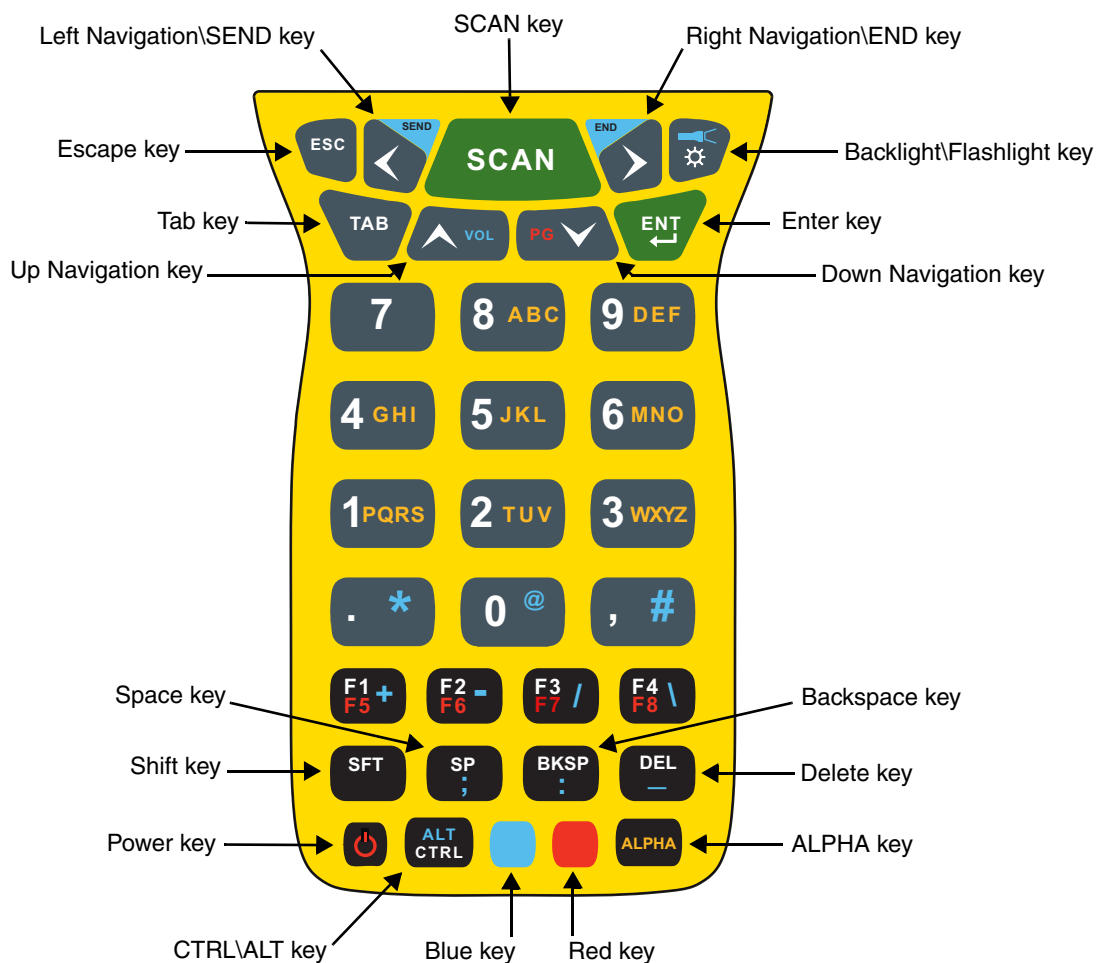

ALPHA Key

The ALPHA lock key enables you to toggle between the alpha and numeric keyboard modes. On the 34-Key Keyboard, numeric mode is the default. Press the ALPHA key once to switch to ALPHA lock mode. Press the ALPHA key again to exit the ALPHA lock mode.

34-Key Numeric (Calculator) Keyboard Combinations

Key	NUM (Default)	Shift-NUM	ALPHA	Shift- ALPHA	Blue	Red
ESC	Escape					
Left	Left	Left	Left	Left	Send (Phone)	Left
Scan	Scan					
Right	Right	Right	Right	Right	End (Phone)	Right
Backlight	Toggles Keyboard Backlight On/Off				Toggles Flashlight On/Off	Toggles Keyboard Backlight On/ Off
TAB	Tab	Tab	Tab	Tab	Tab	Tab
Up	Up	Up	Up	Up	Volume Up	Prior
Down	Down	Down	Down	Down	Volume Down	Next
Enter	Return					
7	7	!				
8	8	@	a,b,c	A,B,C		
9	9	#	d,e,f	D,E,F		
4	4	\$	g,h,i	G,H,I		
5	5	%	j,k,l	J,K,L		
6	6	^	m,n,o	M,N,O		
1	1	& (ampersand)	p,q,r,s	P,Q,R,S		
2	2	* (multiply)	t,u,v	T,U,V		
3	3	(w,x,y,z	W,X,Y,Z		
Period	. (period)	>	. (period)	>	* (multiply)	
0	0)			@	
Comma	, (comma)	<	, (comma)	<	#	

Key	NUM (Default)	Shift-NUM	ALPHA	Shift- ALPHA	Blue	Red
F1	F1	F1	F1	F1	+	F5
F2	F2	F2	F2	F2	-	F6
F3	F3	F3	F3	F3	/	F7
F4	F4	F4	F4	F4	\	F8
SFT	Shift	Shift	Shift	Shift		
SP	Space	Space	Space	Space	;	Space
BKSP	Backspace	Backspace	Backspace	Backspace	:	Backspace
DEL	Delete	Delete	Delete	Delete	Underscore	Delete
Power	Off/On					
CTRL	Control		Control		Menu	
Blue	Blue		Blue		Blue	
Red	Red		Red			Red
ALPHA	Toggles between ALPHA mode and NUM Lock mode					

43-Key Alpha/Numeric Keyboard

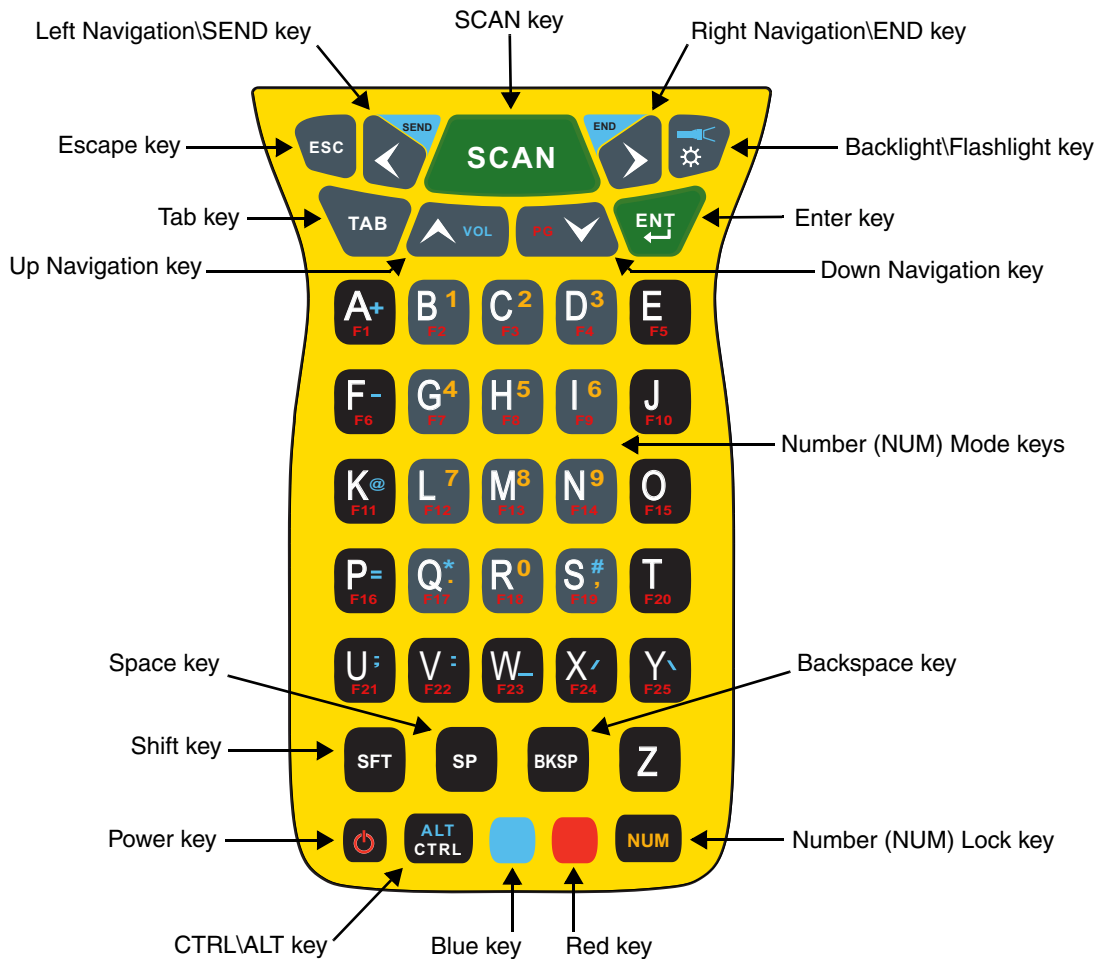

Number Lock (NUM) Key

The Number Lock key enables you to toggle between the alpha and numeric keyboard modes. On the 43-key keyboard, alpha mode is the default. Press the NUM key once to switch to NUM lock mode. Press the NUM key again to exit the NUM lock mode.

43-Key Keyboard Combinations

Key	ALPHA (Default)	Shift-ALPHA	NUM	Shift-NUM	Blue	Red
ESC	Escape					
Left	Left	Left	Left	Left	Send (Phone)	Left
Scan	Scan					
Right	Right	Right	Right	Right	End (Phone)	Right
Backlight	Toggles Keyboard Backlight On/Off				Toggles Flashlight On/Off	Toggles Keyboard Backlight On/ Off
TAB	Tab					
Up	Up	Up	Up	Up	Volume Up (Phone)	Prior
Down	Down	Down	Down	Down	Volume Down (Phone)	Next
Enter	Return					
A	a	A			+ (add)	F1
B	b	B	1	!		F2
C	c	C	2	@		F3
D	d	D	3	#		F4
E	e	E				F5
F	f	F			- (subtract)	F6
G	g	G	4	\$		F7
H	h	H	5	%		F8
I	i	I	6	^		F9
J	j	J				F10
K	k	K		@	@	F11

Key	ALPHA (Default)	Shift-ALPHA	NUM	Shift-NUM	Blue	Red
L	l	L	7	&		F12
M	m	M	8	* (multiply)		F13
N	n	N	9	(F14
O	o	O				F15
P	p	P			=	F16
Q	q	Q	. (period)	>	* (multiply)	F17
R	r	R	0)		F18
S	s	S	, (comma)	<	#	F19
T	t	T				F20
U	u	U			;	F21
V	v	V			:	F22
W	w	W			<u>(underscore)</u>	F23
X	x	X			/	F24
Y	y	Y			\	F25
SFT	Shift		Shift			
SP	Space					
BKSP	Backspace					
Z	z	Z				
Power	Off/On					
CTRL	Control		Control		Menu	
Blue	Blue		Blue		Blue	
Red	Red		Red			Red
NUM	Toggles between NUM lock mode and ALPHA mode					

55-Key Full Alpha/Numeric Keyboard

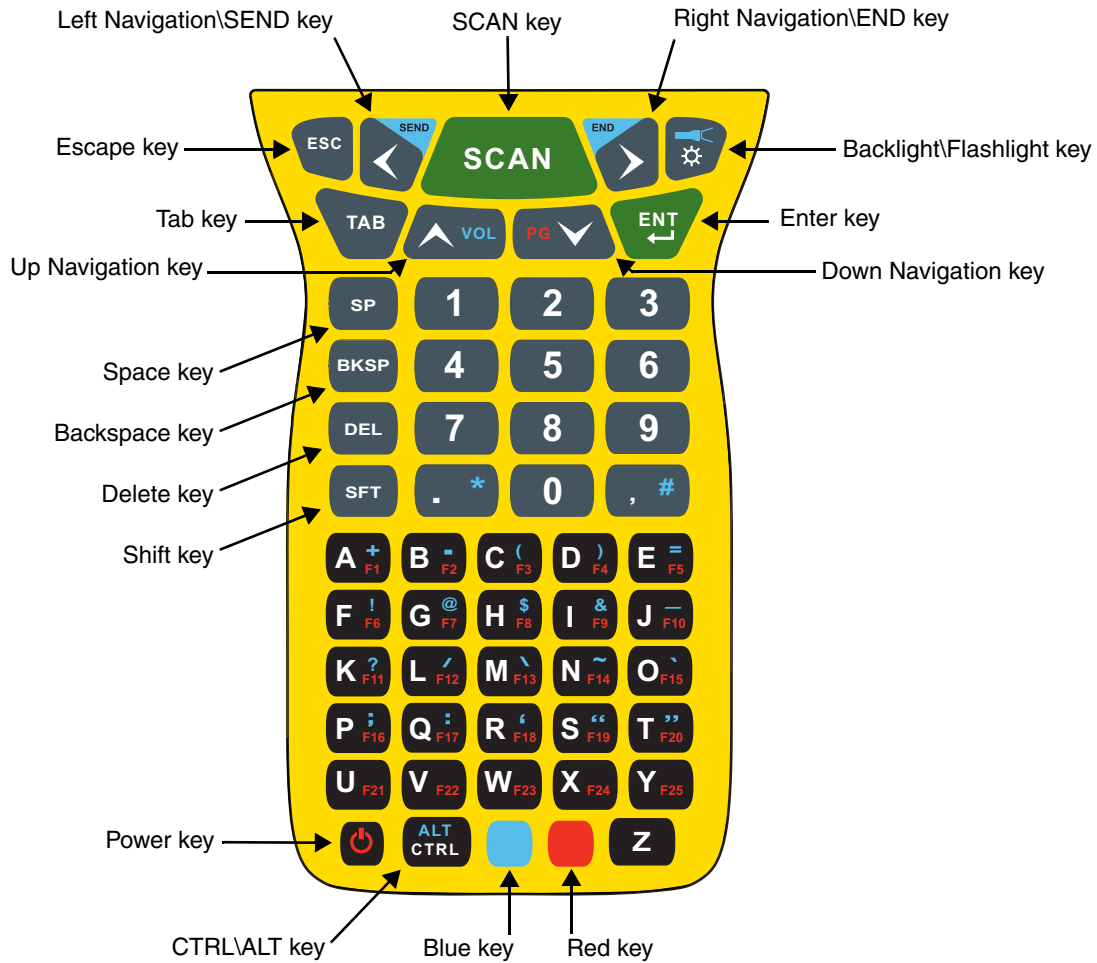

55-Key Keyboard Combinations

Key	Normal	Shift	Blue	Red
ESC	Escape			
Left	Left	Left	Send (Phone)	Left
Scan	Scan			
Right	Right	Right	End (Phone)	Right

Key	Normal	Shift	Blue	Red
Backlight	Toggle Keyboard Backlight On/Off		Toggle Flashlight On/Off	Toggle Keyboard Backlight On/Off
TAB	Tab			
Up	Up	Up	Volume Up	Prior
Down	Down	Down	Volume Down	Next
Enter	Return			
SP	Space			
1	1	!	1	1
2	2	@	2	2
3		#	3	3
BKSP	Backspace			
4	4	\$	4	4
5	5	%	5	5
6	6	^	6	6
DEL	Delete			
7	7	&	7	7
8	8	*	8	8
9	9	(9	9
SHIFT	Shift			
Period	. (period)	>	* (multiply)	. (period)
0	0)	0	0
Comma	, (comma)	<	_ (underscore)	, (comma)
A	a	A	+ (add)	F1
B	b	B	- (subtract)	F2
C	c	C	(F3

Key	Normal	Shift	Blue	Red
D	d	D)	F4
E	e	E	=	F5
F	f	F	!	F6
G	g	G	@	F7
H	h	H	\$	F8
I	i	I	&	F9
J	j	J	_ (underscore)	F10
K	k	K	?	F11
L	l	L	\	F12
M	m	M	/	F13
N	n	N	~	F14
O	o	O	'	F15
P	p	P	;	F16
Q	q	Q	:	F17
R	r	R	' (back quote)	F18
S	s	S	" (quotes)	F19
T	t	T	" (back quotes)	F20
U	u	U	u or U	F21
V	v	V	v or V	F22
W	w	W	w or W	F23
X	x	X	x or X	F24
Y	y	Y	y or Y	F25
Power	Off/On			
CTRL	Control		Menu	
Blue	Blue			

Key	Normal	Shift	Blue	Red
Red	Red			
Z	z	Z	z or Z	z or Z











System Settings

Overview

Customized settings are available on the System Settings menu. Tap  > **Settings** and the settings screen opens.



Icon	Description
Bluetooth 	Configures the Bluetooth radio. See Working with the Bluetooth Radio on page 10-1.
Clock & Alarms 	Set the system clock, date, time and schedule alarms. See Clock & Alarms on page 7-2.
Lock 	Password protect the terminal to limit access to the terminal.
Sounds & Notifications 	Set the sound volume, enable or disable sounds for specific actions, set sound parameters for system notifications and enable or disable vibrator notification.
Home 	Customize the look and the information displayed on the Home screen.
Connections 	Establishes network connections settings. See Connections Menu on page 8-1.
Personal 	Customizes buttons, and set SIP options. See Personal Menu on page 7-3.

Icon		Description
System		Adjusts system settings. See System Menu on page 7-7.
Microsoft My Phone		Synchronizes your phone's contacts, calendar, tasks, text messages, music, photos, videos, and other documents with your My Phone account at http://myphone.microsoft.com .

Clock & Alarms

The Clock & Alarms settings can be accessed from the Home screen or the Settings Menu.

1. On the Home screen, tap the line that displays the time and date

OR

Tap  > **Settings** > **Clock & Alarms**,

2. The Clock Settings screen appears. This setting sets the system clock. All scheduled items run according to this setting.





Tap the arrow to the right of the time zone to open the drop down menu. Select the appropriate time zone from the menu. Set the correct time and date in the remaining fields and tap **OK** to save.

Personal Menu

To access the Personal Menu, tap  > **Settings** > **Personal**. The screen opens displaying the Personal Menu.





Icon	Description
Buttons 	Program the side buttons to perform specific tasks. See Buttons on page 7-3.
Owner Information 	Enter your contact information (e.g., name, company, address, telephone number and E-mail address).
Phone 	This Phone icon is present on Dolphin models equipped with WWAN radio (GSM/UMTS/GPRS/EDGE) capabilities. Tap this icon to set up user parameters. See Setup Options on page 9-7.

Buttons

The Buttons setting programs certain keyboard buttons to launch applications or execute commands.

Enable HotKeys

Default Buttons setting assignments are inactive until you enable the HotKeys Power Tool.

Tap  > **Power Tools** and tap the HotKeys icon  **once**. HotKeys is enabled, and the button assignments in the Buttons setting are active.

For more information about the HotKeys Power Tool, refer to the Dolphin Power Tools User's Guide, which is available for download from the web at www.honeywellaidc.com.

Changing Button Assignments

1. After HotKeys is enabled, tap  > **Settings** > **Personal**  > **Buttons** .

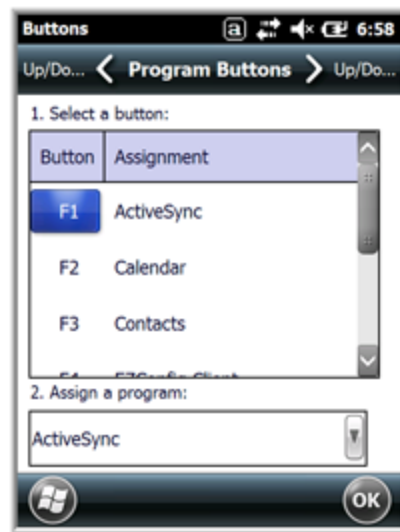

Note: The buttons that appear on this window are the only buttons that can be programmed via the Buttons setting. You cannot add buttons to this window.

2. To change button assignment, tap on the name of the button in the **Button** column, and then select a program or command in the **Assign a program** drop down list.
3. Tap **OK** to save.
4. Press the button to verify that the program is launched or action performed.

Available Applications

The **Assign a program** list contains the applications installed on the terminal. If there is a program installed that you would like to see in this list, paste a Shortcut to the program in the `\\Windows\Start Menu\Programs` folder. For instructions about creating shortcuts, see [Using File Explorer](#) on page 7-5.

Additional Functions

The **Assign a program** list also contains the following commands:

Command	Description
<Context Menu>	Performs the same function as tap-and-hold to open the context menu for the control.
<Input Panel>	Opens the soft input panel.
<Left Softkey>	Opens the menu or performs the action displayed on the left side of the Command bar.
<Scan1>	Activates the scanner/imager.
<None>	Nothing happens when the button is pressed.
<OK/Close>	Performs the same function as tapping OK on the screen.

Command	Description
<Right Softkey>	Opens the menu or performs the action displayed on the right side of the Command bar.
<Scan2>	Activates the scanner/imager.
<Rotate Screen>	Changes the screen orientation from portrait to landscape.
<Scroll Down>	Scrolls down in the open application.
<Scroll Left>	Scrolls left in the open application.
<Scroll Right>	Scrolls right in the open application.
<Scroll Up>	Scrolls up in the open application.
<Start Menu>	Opens the Start menu.

Using File Explorer

If you do not see the program listed, you can either use File Explorer to move the program or ActiveSync on the workstation to create a shortcut to the program and place the shortcut in the Start Menu folder.

Note: We recommend that you Copy and Paste Shortcut so that you do not alter your program configurations by accident. Using Copy and Paste Shortcut (as opposed to Cut and Paste) ensures that the program files remain where they need to be for the system to find them to perform system functions.

1. Tap  > **File Explorer**  , and navigate to the program (**My Device > Program Files**).

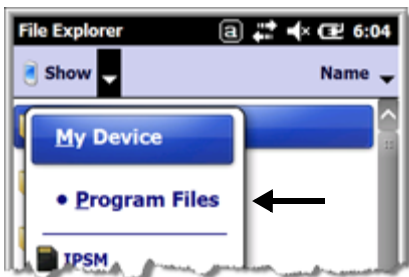

2. Tap and hold on the program, then tap **Copy** on the pop-up menu.

-
3. Navigate to the Windows folder and open the Start Menu (**My Device > Windows > Start Menu > Programs**), tap and hold a blank area of the window, and tap **Paste Shortcut** on the pop-up menu.



*Note: If there is no blank space available in the window, tap on **Menu > Edit > Paste Shortcut**.*



4. Tap  to verify that the program now appears on the Start menu.

Using ActiveSync on the Workstation



Here, you are performing the same basic process as on the terminal, except that you are using the Explore utility (Windows Explorer) to copy and paste the shortcut.











1. Open **ActiveSync > Explore** and navigate to the program.
2. Right-click on the program and select **Create Shortcut**.
3. Select the shortcut, right-click, and select **Cut**.
4. Navigate to the **Start Menu** folder (**Windows > Start Menu > Programs**).
5. Right-click on an empty area and select **Paste Shortcut**.
6. On the terminal, tap the **Start** menu.
7. Verify that program appears.

System Menu

The System menu enables you to verify and sometimes alter system parameters. To access the System menu, go to **Start > Settings > System**. Tap the appropriate icon to open that system setting.



Icon		See Page
About		See About on page 7-8.
Backlight		See Backlight on page 7-9.
Battery		See Battery on page 7-10.
Certificates		See Certificates on page 7-10.
Customer Feedback		See Customer Feedback on page 7-10.
Encryption		See Encryption on page 7-11.
Error Reporting		See Error Reporting on page 7-11.

Icon		See Page
External GPS		See External GPS on page 7-11.
Five Volt Control		See Five Volt Control on page 7-12.
Smart Sensors		See Smart Sensor on page 7-12.
Managed Programs		See Managed Programs on page 7-14.
Memory		See Memory on page 7-15.
Power		See Power on page 7-16.
RIL		See RIL on page 7-16.
Regional Settings		See Regional Settings on page 7-16.
Remove Programs		See Remove Programs on page 7-17.
Screen		See Screen on page 7-18.
Task Manager		See Task Manager on page 7-19.

About

The About system setting displays specific information about the terminal. It contains three screens:

Version Screen Displays the information about the software, operating system, and processor.

Device ID Screen Displays the information the terminal uses to identify itself to other devices. It can be important to know this information if the Dolphin terminal is going to be part of a networked system of devices.

Device name: Displays the system's default name. (This is the name used by ActiveSync.)

Description: Displays the description of the device ID.

Copyrights Screen Displays important copyright information.

Backlight

The Backlight system setting enables you to customize backlight functionality for the display. The backlight for the color display is user-defined. The Backlight system setting screen contains three tabs: Battery Power, External Power, and Brightness.

Tap  > **Settings** > **System** > **Backlight**.

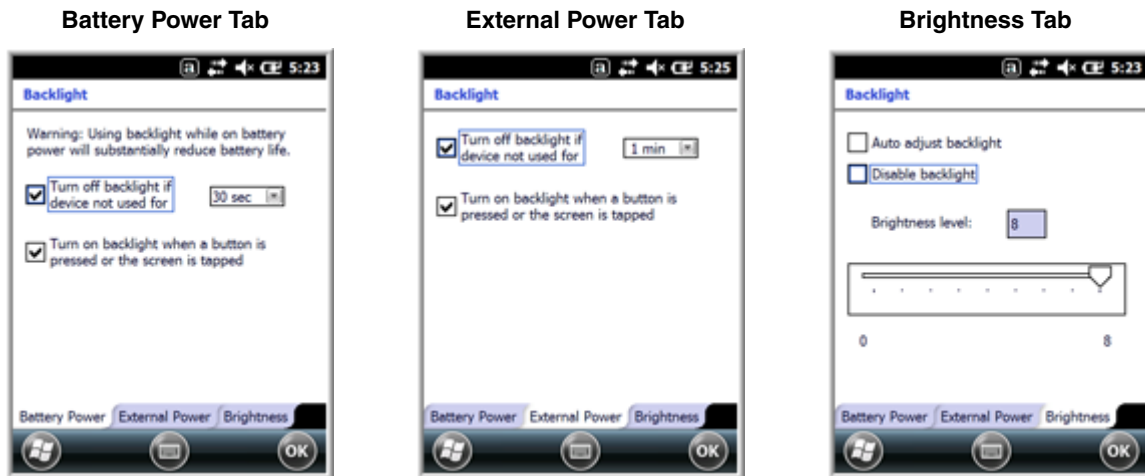

The **Battery Power** tab determines the backlight timeout when the terminal is running on battery power.

The **External Power** tab determines the backlight timeout when the terminal is running on external power.

The options on the power tabs are the same.

Turn off backlight: Select how many minutes you want to elapse before the backlight automatically turns off.

Turn on backlight: Select this option if you want the backlight to turn on when the button is pressed or the touch screen is tapped.

The **Brightness** tab determines the backlight intensity. Move the slider to set the intensity of the backlight. The default is 8. The **Auto adjust backlight** option allows the light sensor to automatically adjust the display brightness based on the ambient light. The Auto adjust backlight option is also accessible from the Smart Sensors applet, see [Smart Sensor](#) on page 7-12.

Battery

The Battery system settings menu contains two tabs: Battery Status and Log Config. The **Battery Status** tab provides the status of the main battery pack (e.g., Battery Time to Full or Battery Time to Empty, Voltage, Current, Temperature, Chemistry, and Serial Number). The **Log Config** Tab allows you to configure the BatteryLogFile.

Tap  > **Settings** > **System** > **Battery**

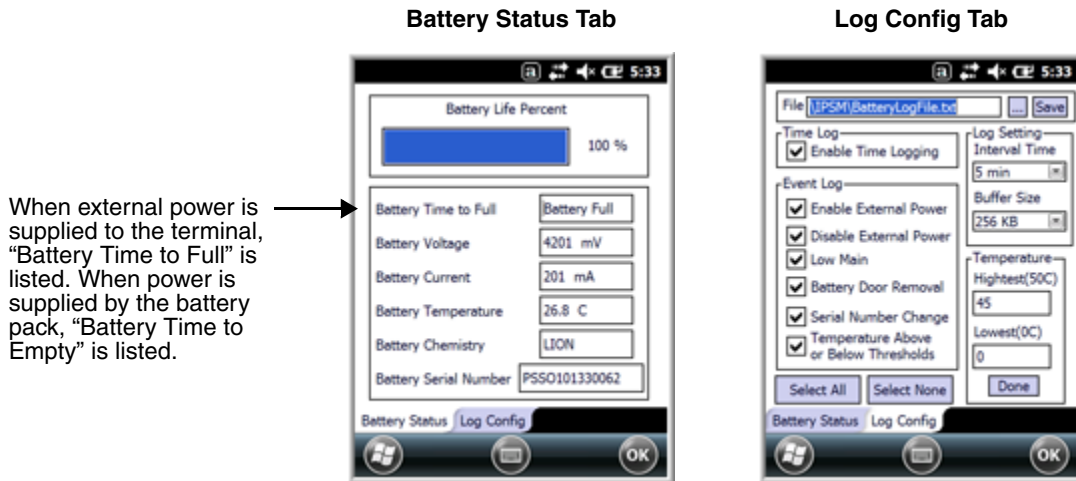

Certificates

Certificates shows you the certificates that are recognized by the operating system. It contains three screens.

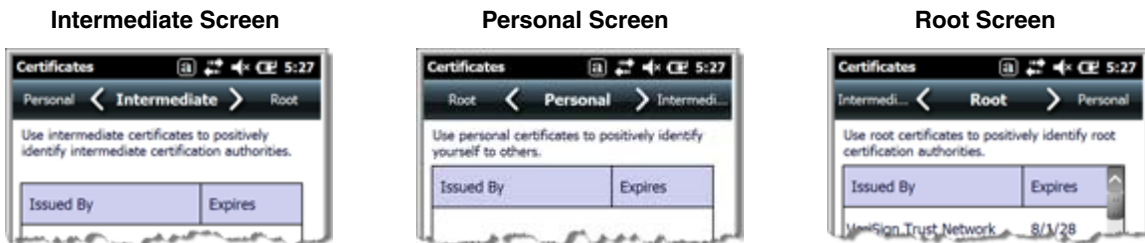

Customer Feedback

Customer Feedback gives you the option to participate in the Microsoft Customer Experience Improvement Program.

Encryption

Encryption gives you the option of encrypting files placed on storage cards so that those files cannot be read by any other device.



Error Reporting

Error Reporting gives you the option of enabling or disabling the error reporting function of Windows Embedded Handheld 6.5.

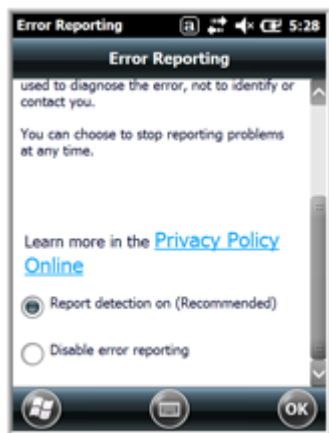

External GPS

External GPS determines which port a third-party GPS software application can use to access the GPS receiver.

Access Screen



Hardware Screen

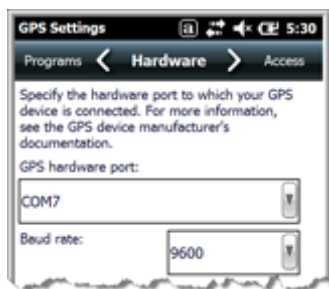

Programs Screen



Note: You need the installation parameters from the GPS manufacturer to configure the connection.

Five Volt Control

Five Volt Control gives you the option to manually enable 5V output to supply power to an external device. By default, 5-Volt Output automatically turns on when AC power is applied to the terminal. If you want to use a USB memory stick without AC power, then you must manually turn on the 5-Volt Output. Do not leave 5-Volt output enabled when you are not using it to supply power to an external device.

Smart Sensor

The Smart Sensor configuration utility enables you to configure the Dolphin's integrated accelerometer, light, and proximity sensors.

Tap  > **Settings** > **System** > **Smart Sensor**.

Motion Settings

Motion Settings enable you to customize how the terminal responds to motion and object orientation for advanced power management.

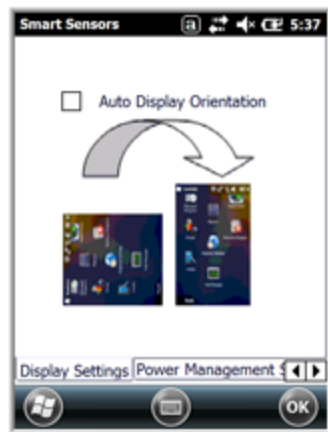

Display Settings enables or disables **Auto Display Orientation**. When enabled, the Dolphin's display automatically switches between portrait and landscape depending on how you hold the terminal.

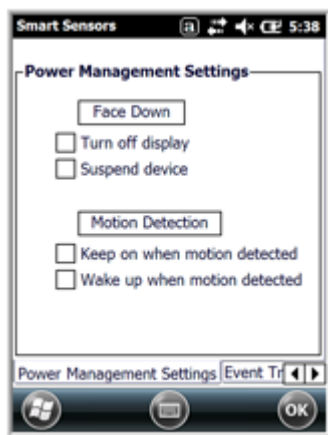

Power Management Settings customize how the terminal responds to object orientation and motion.

- Save power by turning off the display or suspending the terminal when it is placed face down.
- Modify the Motion Detection settings to wake the terminal from suspend mode or prevent the terminal from entering suspend mode when motion is detected.

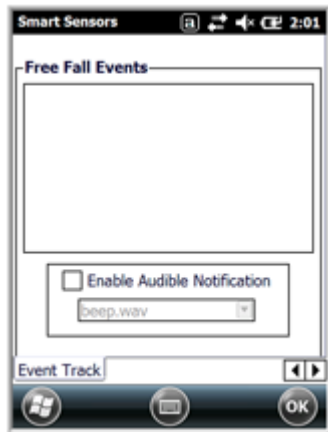

Event Track displays an event log summary of detected free fall events exceeding 2 ft. over 250 ms. The summary includes the time, date, and duration of the most recent 50 events. Several options are provided for audible notification of free fall events.

Light Settings

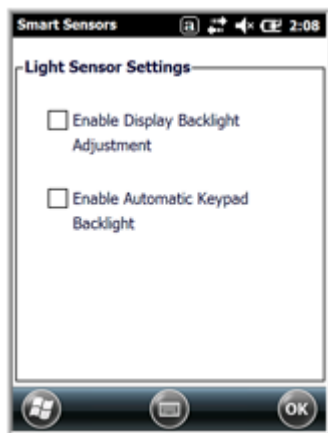

Light Sensor Settings customize how the terminal responds to the environmental lighting conditions in which the terminal is being used.

- **Enable Display Backlight Adjustment** automatically adjusts the brightness of the display screen depending on the environmental lighting conditions.
- **Enable Automatic Keypad Backlight** automatically turns the keypad backlight on or off depending on the environmental lighting conditions.

Proximity Settings

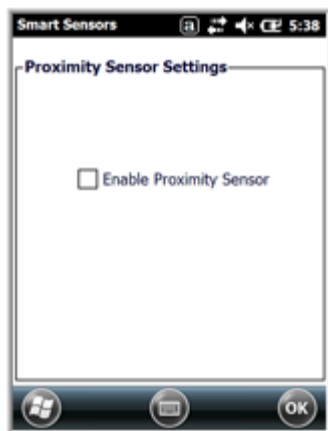

Proximity Sensor Settings customize how the terminal responds to objects detected close to the touch screen display (e.g., a person's face, carrying holster, or tabletop). When enabled, the terminal automatically turns the display off when it detects an object in close proximity to the entire touch panel display. The display turns back on when the sensor detects the removal of the object.

Accelerometer Calibration



Tap **Start** to calibrate the integrated accelerometer sensor used for motion detection. When calibration is complete, the "Accelerometer Calibration Finished!" message window appears.

Managed Programs

Managed Programs are a list of programs that are managed if enrolled to enterprise domain. Managed Programs is the client-side that works with the server product System Center Mobile Device Manager (MDM). MDM consists of MDM Gateway Server and one or more computers that run MDM Device Management Server; MDM Enrollment Server; and Microsoft SQL Server® 2005 databases.

It lets system administrators:

- provide an authenticated connection to LOB applications, managed Group Policy, and application packages.
- use Group Policy and software packages to manage the enrolled Windows phones (enforce policy, wipe devices, etc.).
- manage the requests for and retrieving of certificates for devices and for creating the Active Directory® Domain Service objects that represent these devices. By using these objects, you can manage the devices as if they were members of a domain.

Memory

The Memory applet shows the capacity and usage of the Storage and Program portions of the Flash file system. The Storage portion includes the IPSM folder, which can be detailed under the Storage Card tab. When the Program portion becomes too full, you can use the Task Manager to remove any unnecessary tasks.

Main Screen



This screen displays the usage statistics of the flash memory.

Storage Card Screen



This screen displays the current capacity and usage statistics of the selected memory type: IPSM or Storage Card.

Select the memory type from the drop-down list. IPSM is selected by default.

Total storage card memory = The total MB of memory capacity of IPSM or Storage Card.

In use = The MB currently being used.

Free = The MB that is still available for use.

IPSM—Short for Internal Persistent Storage Manager. Data or programs stored in the IPSM are not affected when the operating system is upgraded. Autoinstall programs, for example, are stored in \\IPSM\Honeywell\Autoinstall so that they are always installed after an operating system upgrade or factory reset. Contact a Honeywell technical support representative for more information on how to perform a factory reset. For contact information, see [Technical Assistance](#) on page 18-1.

Storage Card—You can install one memory card in Dolphin terminals (see [Installing a Memory Card](#) on page 3-17). If a storage card is installed in the terminal, you can select it in the drop-down list and see capacity and usage statistics for the card.

RIL

The RIL Information screen displays useful statistics for the GSM WAN Voice module (PH8).

To verify whether or not the GSM radio is enabled, check the [Dolphin Wireless Manager](#) (see page 8-6).

Power

Power system settings contains two tabs: Battery and Advanced

Tap  > **Settings** > **System** > **Power**

Battery Tab

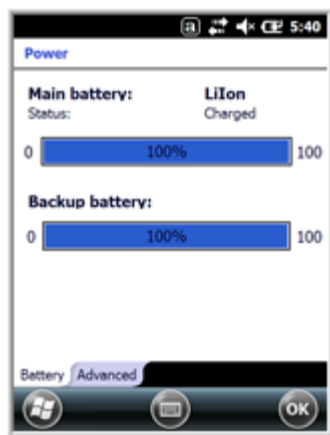

The battery tab displays the power level status of the main battery and the status of the backup battery.

Note: The Backup Battery gauge registers either 0% or 100%. The percentage is not an indication of the level of charge remaining on the backup battery. An installed and functional battery registers 100%. A total discharge or a battery error registers 0%.

For detailed information on the main battery pack, see [Battery](#) on page 7-10.

Advanced Tab

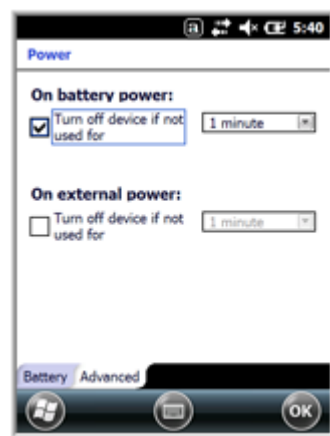

Determines power time-outs.

For **On battery power**, select from the drop-down list, the number of minutes of inactivity you want to pass before the terminal powers off when running on battery power.

For **On external power**, select from the drop-down list, the number of minutes of inactivity you want to pass before the terminal powers off when running on external power.

Note: When the terminal “powers off”, it enters [Suspend Mode](#), see page 2-13 for additional information.

Regional Settings

Regional Settings enables you to customize the appearance and formatting to your geographic region. Specifically, you can customize numbers (i.e., number of decimal places allowed), currency (i.e., using the \$ or € symbol), time, and date. These specifications apply to all screens, including the Home screen. The Region tab displays an overview of the region selected in the drop-down list at the top.

The terminal is loaded with a number of pre-programmed regional settings. Select one from the list and the results appear on the screen. To see specific settings or to change a specific setting, tap on one of the tabs, make the change, and tap **OK** to save it.

Remove Programs

Remove Programs enables you to remove programs installed on the terminal. Any program (usually CAB or DLL files) stored in the \\IPSM\Honeywell\Autoinstall folder re-installs after a software upgrade or a factory reset. If a program is manually removed using the **Remove Programs** application, the program does not re-install on a hard or soft reset.

Note: A program (file) does not automatically install if it is added to the \\IPSM\Honeywell\Autoinstall folder and a hard or soft reset is performed. For information on program installation, see [Installing Additional Software](#) on page 8-10.

For information about the system resets, see [Resetting the Terminal](#) on page 2-13. See Honeywell support for more information on how to perform a factory reset.

1. Tap **Remove Programs**. In the list, select the program you want to remove.

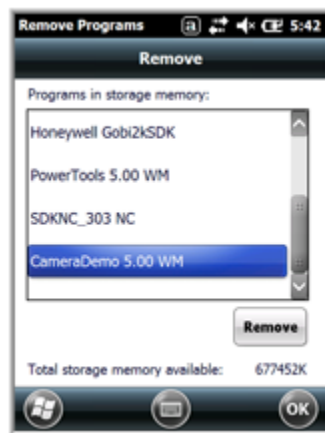

2. Tap **Remove**. The following message appears:



3. Tap **Yes**. Wait while the program is removed.
4. Verify that the program no longer appears in the list.

Screen

The Screen system setting contains three screens: General, Clear Type, and Text Size.

General Screen



Orientation

The General screen enables you to set the dynamic screen rotation. Three choices of screen orientation are supported: Portrait, Landscape (right-handed), and Landscape (left-handed).

Align Screen

The General Tab also allows you to re-align the screen. You need to re-align the screen if tapping buttons or icons with the stylus no longer seems to work appropriately.

Tapping **Align Screen** brings up the align screen window where you are guided to tap a target several times. This recalibrates how the touch screen receives input.

- Alignment should always be performed with a stylus designed for touch panel applications. The small point is required for accurate calibration.
- Press the stylus firmly into the center of the cross-hair target once and release. Do not “double-tap” the target.

ClearType Screen



The display supports ClearType font rendering, which is a Microsoft technology that dramatically increases the readability of text on LCD displays.

To enable Clear Type font rendering, select **Enable ClearType** and tap **OK**.

For more information about ClearType font rendering, visit: www.microsoft.com/typography/WhatIsClearType.msp.

Text Size Screen

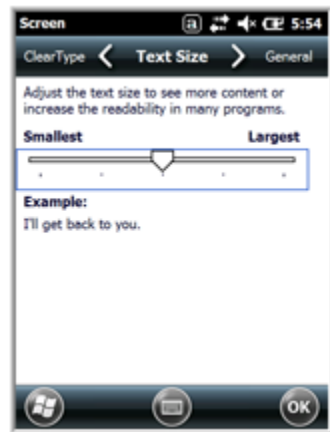

The Text Size screen enables you to perform font scaling within certain views of the:

- Home screen,
- Contacts,
- Calendar,
- Messaging, and
- Tasks.

Font scaling means that you can increase or decrease the point size of the font on application windows.

To change the font size, move the slider toward **Smallest** or **Largest**. The Example text changes to reflect the font change. Tap **OK** to save the new font size setting.

Task Manager

The Task Manager provides information about applications and processes running on your mobile computer. You can use the Task Manager to monitor the memory and CPU usage of specific applications and processes. Check the Task Manager when you are receiving out of memory errors or when the mobile computer is running slowly.

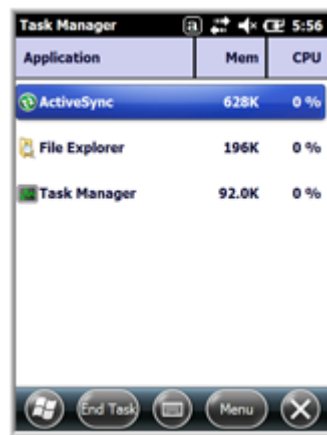

Application	Mem	CPU
ActiveSync	628K	0 %
File Explorer	196K	0 %
Task Manager	92.0K	0 %

Using the Task Manager

Applications

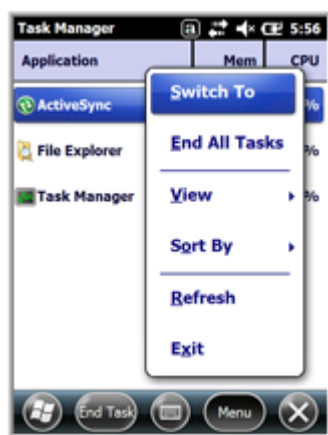

To view the status of the programs running on your mobile computer, tap the **Menu** button at the bottom of the screen, then tap **View > Applications**.

From the application list, you can:

- Tap and hold on an application, then tap **Switch To** on the pop-up menu.
- Tap and hold on an application, then tap **End Task** or **End All Tasks** on the pop-up menu.

Note: Anytime you stop a running program, it frees up memory. To free up memory, return to the running program, save your data, and close the application.

Processes

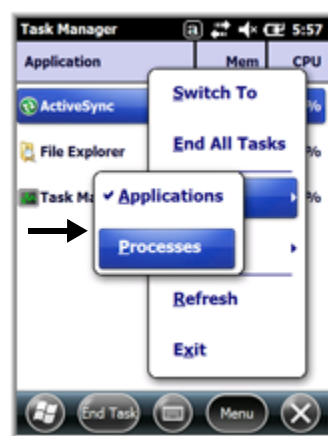







To view information about the processes running on the mobile computer, tap the **Menu** button at the bottom of the screen, then tap **View > Processes**.

Connections Menu

The Connections system setting provides access to the terminal's various wireless communication options.



Icon		Tapping this icon...
Beam		Enables infrared communication. See Receiving Data on page 8-3.
Connections		Opens Microsoft's connections manager. See Connections Manager on page 8-4.
Dolphin Wireless Manager		Manages the wireless radios installed in the terminal. See Dolphin Wireless Manager on page 8-6. <i>Note: The Dolphin Wireless Manager icon may not appear on the Connections menu on terminals running Microsoft Windows Embedded Handheld 6.5 Classic. For information on how to access the Dolphin Wireless Manager, see page 8-6.</i>
Domain Enroll		Opens the Enrollment screen for connecting your phone with company resources. <i>Note: System administrator password is required for domain enrollment.</i>
USB to PC		Enables advanced wired USB to PC communication via sync software. See Connecting and Synchronizing the Terminal and Workstation on page 8-8.
Network Cards		Manage Network card settings.

Note: All server-assigned IP addresses use Dynamic Host Configuration Protocol (DHCP).

Using the IrDA Port

Using the IrDA port, you can send and receive data between the terminal and other devices equipped with infrared. This can include, but is not limited to, Windows Embedded Handheld information such as Contacts and Tasks, as well as software upgrades.

IrDA Port Location

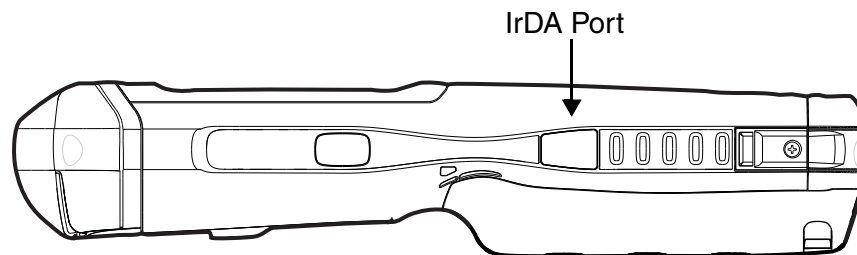

Note: Your Dolphin model may differ from the model illustrated; however, the features noted are standard for all 99EX models unless otherwise indicated.

To send or receive, the IrDA ports of both devices - whether it is two terminals, or a terminal and a host device - must be aligned with each other and within a close range. The maximum data transfer speed is 115 Kbps.

Sending Data

1. Align the IrDA ports.
2. Open the program where you created the item you want to send and locate the item in the list. You can also beam files, but not folders, from File Explorer.
3. Tap and hold the item and select **Beam File**.



-
- The IrDA port searches for a receiving IrDA port in the vicinity. The selected device reads “Pending.”

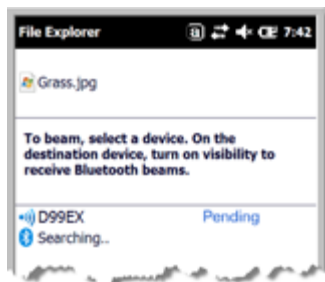

- When the IrDA port finds the aligned IrDA port, it immediately starts sending the selected file. The selected device reads “Sending.”



- When the file transfer is complete, the selected device reads “Done.”

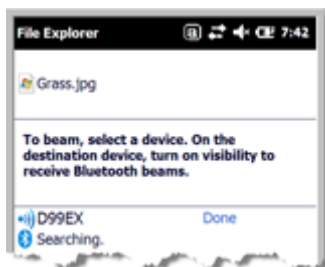

Receiving Data

The Beam Setting must be set to receive all incoming beams from other infrared devices.

- Verify that beam settings are set to receive. Tap  > **Settings** > **Connections** > **Beam**. The Beam Settings window should appear as follows:

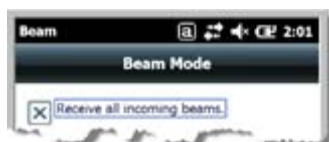

- Align the IrDA ports.
- Have the owner of the other device send the data to you.
- Your terminal automatically begins receiving the data.
- A popup message appears asking if you want to save the incoming file.
- Tap **Yes** to receive the file.

Connections Manager

Microsoft's Connections Manager sets up multiple network connections to Internet Service Providers (ISPs) via external modem.

Do NOT enter connection parameters in the Connections Manager if:

- you are using one of the on-board wireless radios to connect to a network. The Dolphin terminal uses the settings from each radio's configuration utility to connect. The connections manager is used primarily to setup WAN modem dial up connections.
- you are using Wireless Zero Config. By default, WZC is disabled on Dolphin terminals.

To Access the Connections Manager

Tap  > **Settings** > **Connections**  > **Connections** .



Tasks

The Tasks screen enables you to initially configure, and then manage network settings when using a modem. Select an item in this list and then complete the setup screens that follow with the appropriate information for your network.

My ISP

The links under this heading enables you to add and manage modem connections to an ISP. To complete the setup screens, obtain the following information from your ISP:

- ISP dial-up access telephone number
- Username
- Password
- TCP/IP settings

My Work Network

These links enable you to establish the following connections types:

- Modem
- Virtual Private Network (VPN)

-
- Proxy server connection

Note: If you are connected to your ISP or private network during synchronization, the terminal should download the proper proxy settings during synchronization with the workstation. If these settings are not on your workstation or need to be changed, ask your ISP or network administrator for the proxy sever name, server type, port, type of Socks protocol used, and your user name and password.

To complete the setup screens, obtain the network parameters from your system administrator.

Modify an Existing Connection

Manage Existing Connections appears on the Connections tab after at least one network connection has been established.

Tap **Manage Existing Connections** on the Horizontal scroll and follow the setup screens.



Advanced

The Advanced screen enables you to select the default network, dialing rules, and IP address exceptions for modem connections.

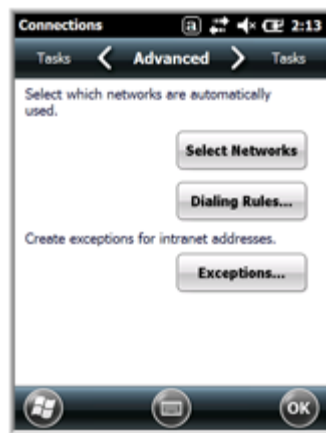

Note: You should not need to change Advanced settings because most ISPs now use DHCP addresses.

Dolphin Wireless Manager

The Dolphin Wireless Manager provides a centralized interface that enables and disables all the on-board radios. Each radio has its own configuration program. The Dolphin Wireless Manager also provides shortcuts to the configuration utilities for each radio.

Tap  on the Home screen to access the **Dolphin Wireless Manager**.

OR

1. Tap once on the Title bar to access the Horizontal Scroll bar.

2. Tap .

3. Select, "Dolphin Wireless Manager".



Dolphin Wireless Manager Window



These buttons show you the state of the radio.

If applicable, information about the radio appears when the radio is activated.

Note: Not all Dolphin models are equipped with the same radio types. Your Dolphin Wireless Manager Window may differ slightly from what is illustrated depending on your Dolphin model.

Enabling the Radios

1. Tap  on the Home screen to access the **Dolphin Wireless Manager**.



2. Tap anywhere inside the rectangle of the radio you want to enable.

3. The radio begins activating.
4. When the radio is activated (i.e., transmitting a signal), the **OFF** button changes to **ON**.



Note: If applicable, information about the radio appears in the rectangle.

Accessing Radio Configuration Utilities

Each radio has its own configuration utility that you can access by tapping **Menu** on the tile bar.



Radio Type	Menu Option
802.11a/b/g/n	Tap WLAN Settings and the Honeywell WLAN Security Supplicant opens. The <i>Honeywell WLAN Security Supplicant User's Guide</i> is available for download from the Dolphin 99EX product page at www.honeywellaidc.com .
Bluetooth	Tap Bluetooth Settings and the Bluetooth Settings open. For details, see Working with the Bluetooth Radio on page 10-1.
GSM/HSDPA/UMTS/GPRS/EDGE	Tap Phone Settings and the Phone opens. For details, see Working with Wireless Wide Area Networking (WWAN) on page 9-1.
GSM/CDMA	Tap Gobi Settings and the Gobi Manager opens. For details, see Gobi Manager on page 9-13.

Network Cards

The Network Cards screen allows you to set and configure the type of Network Adapter the Network card in the terminal uses. You can modify the adapter settings (e.g., Name Servers or IP address) by tapping on the adapter type or highlighting the adapter and tapping **Edit** at the bottom of the screen.



Connecting and Synchronizing the Terminal and Workstation

To synchronize data between the terminal and the workstation, ActiveSync (version 4.5 or higher) or Windows Mobile Device Center must be installed and configured for the appropriate communication type on the host workstation (Windows-based PC) and the Dolphin terminal. Dolphin terminals ship with ActiveSync already installed. Therefore, if ActiveSync is already installed on the host workstation, you just need to connect the Dolphin terminal to the host workstation (via Dolphin peripheral) to initiate communication.

If ActiveSync (4.5 or higher) or Windows Mobile Device Center is not installed on the host workstation, you can download and install the most current version of the software from the [Microsoft Web site](http://go.microsoft.com/fwlink/?LinkId=147001) (<http://go.microsoft.com/fwlink/?LinkId=147001>).

Note: ActiveSync on your Dolphin terminal works with Windows Mobile Device Center on host workstations running Windows Vista or Windows 7 and with ActiveSync on host workstations running Windows XP. For detailed information on ActiveSync and WMDC visit the [Microsoft Windows Phone Web site](#).



When communicating via ActiveSync or Windows Mobile Device Center, your terminal is designed to be connected to the host workstation with a communication peripheral sold/manufactured by Honeywell, such as the charge/communication cable. Use of any peripheral not sold/manufactured by Honeywell may cause damage not covered by the warranty.

Capabilities

- Back up and restore your device data.
- Copy (rather than synchronize) files between your device and workstation.
- Control when synchronization occurs by selecting a synchronization mode. For example, you can synchronize continually while connected to your workstation or only when you choose the synchronize command.

-
- Select which information types are synchronized, controlling how much data is synchronized. For example, you can choose how many weeks of past appointments you want synchronized.

Communication Types

The Dolphin terminal supports the following types of communication via ActiveSync through its [I/O Connector](#) (see page 3-10) on the bottom panel:

- USB** The USB cable and hardware peripherals allow the terminal to communicate with a workstation or to networked through a USB hub. The Dolphin terminal supports Hi-Speed USB communication (USB 2.0); maximum data transfer rate is 480 Mbps. The Dolphin terminal defaults to USB communication out of the box.
- RS232** The RS232 cable allows the terminal to communicate with a workstation, modem, or any RS232 device. Maximum data transfer rate is 115 Kbps.

Hardware Requirements for Setup

- Dolphin communication peripheral (e.g., HomeBase, eBase, USB or RS232 Communication/Charge Cable) and power supply.
- A USB cable (for USB communication) or Serial cable (for RS232 communication) if one is not supplied with your Dolphin communication peripheral

Software Requirements for Communication

- ActiveSync (v4.5 or higher) or Windows Mobile Device Center installed and configured on the host workstation (PC), see [Setting Up the Host Workstation](#) on page 8-9.
Note: ActiveSync or Windows Mobile Device Center must be setup on your workstation before you initiate synchronization from the terminal for the first time.
- Windows 98 Second Edition, Windows Me, Windows 2000, Windows NT (4.0 SP6 or higher), Windows XP, Windows Vista, and Windows 7 operating systems.

Setting Up the Host Workstation

To synchronize data between the terminal and the workstation, ActiveSync (v4.5 or higher) or Windows Mobile Device Center must be configured for same communication type on both the host workstation and the Dolphin terminal.

ActiveSync

Verify that ActiveSync is configured to use the appropriate communication type.

1. In the ActiveSync window on your workstation, select **File > Connection Settings**.
2. Do one of the following:
 - a. For USB communications, check the box next to “Allow USB connections”.
 - b. For RS232 communications, check the box next to “Allow connection to one of the following”, and select **COM1** from the drop down menu.

Note: You can have both USB and RS232 selected in the software without affecting processing. However, your hardware setup should use only RS232 or USB, not both.

Connecting the Dolphin Terminal to the Host Workstation

After setting up both the workstation and the terminal:

1. Connect the Dolphin terminal to the workstation using a Dolphin communication peripheral.
2. ActiveSync or Windows Mobile Device Center should open and connect automatically to the Dolphin terminal.

Synchronizing with the Host Workstation

After setup, synchronization begins automatically whenever the terminal's mechanical connector connects to a Dolphin peripheral that is connected to a host workstation with ActiveSync or Windows Mobile Device Center installed. For additional information visit the [Microsoft Phone Web site](http://go.microsoft.com/fwlink/?LinkId=147001) (http://go.microsoft.com/fwlink/?LinkId=147001).

Exploring the Terminal from the Workstation

ActiveSync

1. Open the main ActiveSync window (on the desktop).
2. Click **Explore**. This opens the Mobile Device folder for the terminal in Windows Explorer.
3. The Dolphin terminal is now treated as a mass storage device, and transferring files is as simple as dragging and dropping or copying and pasting.

Windows Mobile Device Center

1. Open Windows Mobile Device Center (on the desktop).
2. Click **File Management**. This opens the Mobile Device folder for the terminal.
3. The Dolphin terminal is now treated as a mass storage device, and transferring files is as simple as dragging and dropping or copying and pasting.

Installing Additional Software

Dolphin terminals ship with the operating system, radio drivers, and custom Honeywell software already installed. These are the default programs that install when your terminal first boots up. You can install additional software programs to the terminal provided that the following parameters are met:

- The software program was created for a Windows Embedded Handheld 6.5 device.
- The terminal has enough memory to store and run the program.
- The program has an EXE, CAB, or DLL extension.

When selecting programs, verify that the program and version of the program are designed for the Windows Embedded Handheld 6.5 and the terminal's processor. You can verify your processor by tapping



> **Settings** > **System** > **About** > **Version**. Make a note of the information in the **Processor** field.

To install additional software, you can use the communication options described in this chapter.

- [Adding Programs Using ActiveSync or Windows Mobile Device Center](#), see page 8-11.
- [Adding Programs Using the Internet](#), see page 8-12.

Adding Programs Using ActiveSync or Windows Mobile Device Center

Generally, software for Windows Embedded Handheld devices must be installed to the host workstation first, then transferred to the Dolphin terminal.

Note: An active Microsoft ActiveSync or Windows Mobile Device Center connection between a host workstation and the Dolphin terminal is required to add programs. For additional information, see [Connecting and Synchronizing the Terminal and Workstation](#) on page 8-8.

1. Download the program to the workstation from either the Internet or the install CD. You may see a single *.exe or setup.exe file, a *.cab file, or a *.dll file.

Note: There may be several versions of files for different device types and processors. Select the file that matches the terminal's processor.

2. Read any installation instructions, Read Me files, or documentation that comes with the program. Many programs provide special installation instructions.
3. Connect the terminal to the workstation via a Dolphin communication peripheral.

If the File is an Installer (*.exe or *.setup.exe)

An installer program is one that installs on the workstation and the terminal simultaneously; one process installs to both devices.

1. On the workstation, double-click the *.exe or setup.exe file. The installation wizard begins.
2. Follow the directions on the workstation screen. The installation process includes transferring the software to the Dolphin terminal.

If the File is Not an Installer

Some programs cannot be installed on PCs because they are designed exclusively for Windows Embedded Handheld devices. In these cases, the appropriate files must be stored on the host workstation and transferred to the terminal via ActiveSync Explore or Windows Device Mobile File Management.

Note: You know that the program is not an installer because an error message stating that the program is valid but designed for a different type of computer appears when you try to install the program on the workstation.

1. If you cannot find any installation instructions for the program in the Read Me file or documentation, do one of the following:
 - a. Open **ActiveSync** and click **Explore**, or
 - b. Open **Windows Mobile Device Center** and click **File Management**
2. On the workstation, navigate to the workstation folder containing the program file(s). Copy and paste the file(s) into the **Program Files** folder on the terminal.

- If you want the program to be part of the Autoinstall that occurs after a factory reset or software upgrade, paste the program file(s) in both the \IPSM\Honeywell\Autoinstall folder and the \Honeywell\Autoinstall.

Note: Contact a Honeywell technical support representative for information on how to perform a factory reset. See [Technical Assistance](#) on page 18-1 or go to www.honeywellaidc.com.

3. On the terminal from the Start screen, tap **File Explorer**, navigate to the folder where the program is located.
4. Tap on the program file to start the installation.
 - If you copied the file to the \Honeywell\Autoinstall folder, you can perform a Soft Reset (CTRL + ENTER) to install the program. For more information, see [Hardware Maintenance](#) on

Connecting the Terminal to a Wireless Network

You connect the terminal to a wireless network through the on-board radio (802.11a/b/g/n, Bluetooth, and/or GSM/CDMA). Each radio has its own configuration utility and requires specific information about the wireless network to connect. Successful connection depends on your network infrastructure about which you will need specific information from your network administrator.

WLAN (802.11a/b/g/n)

The 99EX has a 2.4 GHz 802.11b/g/n - 5.0 GHz 802.11a/n WLAN (Wireless Local Area Network) radio. The radio is interoperable with other 802.11a/b/g/n, Wi-Fi compliant products including access points (APs), workstations via PC card adapters, and other wireless portable devices. By default, the 802.11a/b/g/n radio is disabled after each factory reset. The next step is to configure the connection parameters of the radio to connect to a wireless network.

WLAN Radio

The WLAN radio is configured in the Honeywell WLAN Security Supplicant, which you access by tapping the program icon in the task tray near the bottom of the touch screen. For complete configuration instructions, download the *Honeywell Secure Wireless (SWC) Client User's Guide* from www.honeywellaidc.com. A link to this guide appears on the Dolphin 99EX product page.

Adding Programs Using the Internet

When you have established a network connection, you can access the Internet and download additional software programs.

Note: When selecting programs, verify that the program and version of the program are designed for Windows Embedded Handheld and the terminal's processor. You can verify your processor by tapping

 > **Settings > System > About > Version**. Make a note of the information in the Processor field.

1. Open Internet Explorer and navigate to the program's location. You may see a single *.exe or setup.exe file, or several versions of files for different device types and processors.
2. Select the program version that matches your Dolphin terminal and processor.
3. Read any installation instructions, Read Me files, or documentation that comes with the program. Many programs provide special installation instructions.
4. Download the program to the terminal directly from the Internet. You would normally store the program in the \Program Files folder unless another location is required by the program.
5. On the terminal, tap the installer file: e.g., *.exe or setup.exe file.
6. The installation wizard for the program begins.
7. Follow the directions on the screen to complete the installation.

Software Upgrades

Contact a Honeywell technical support representative for information on available software upgrades for your Dolphin terminal, see [Customer Support](#) on page 18-1 or go to www.honeywellaidc.com.

 To prevent data loss, back up all user data to an SD card or external memory device before performing an upgrade.

Note: An active Microsoft ActiveSync or Windows Mobile Device Center connection between a host workstation and the Dolphin terminal may be required for some types of software upgrades. For additional information, see [Connecting and Synchronizing the Terminal and Workstation](#) on page 8-8.

For information on [File Provisioning on the 99EX](#), see page 2-12.

99EX COM Port Assignment Table

COM Port	Description
COM0	Unused
COM1	Serial Port: RS232 Connector on the bottom panel
COM2	Bluetooth
COM3	IrDA: Serial Infrared (SIR) up to 115 Kbps
COM4	Available
COM5	Bluetooth DUN
COM6	IrCOMM
COM7	GPS: COM Port for the GPS receiver
COM8	USB Serial: Virtual USB Serial port for ActiveSync
COM9	Bluetooth BTHATCI server



Working with Wireless Wide Area Networking (WWAN)

Overview

The 99EX has two options for WWAN connectivity, a data+voice GSM/HSPA+/UMTS/GPRS/EDGE radio or a data only Gobi radio, which supports GSM/HSPA+/UMTS/GPRS/EDGE and CDMA/1xRTT/EVDO.

GSM	Short for Global System for Mobile communications, GSM is an open, non-proprietary wireless WAN system that is constantly evolving and growing.
HSPA+	Short for High-Speed Download Packet Access, HSPA+ is a non-voice value added service that allows packet-switched data to be instantly sent and received across mobile telephone networks.
UMTS	Short for Universal Mobile Telecommunications System, UMTS is a non-voice value added service that allows packet-switched data to be instantly sent and received across mobile telephone networks.
GPRS	Short for General Packet Radio Service, GPRS is a non-voice value added service that allows packet-switched data to be instantly sent and received across mobile telephone networks.
EDGE	E-GPRS is a non-voice value added service that allows packet-switched data to be instantly sent and received across mobile telephone networks at a higher data rate than standard GPRS.
CDMA	Short for Code Division Multiple Access.
1xRTT	Short for Single-Carrier Radio Transmission Technology.
EVDO	Short for Evolution-Data Optimized.

Requirements

Using GSM/HSPA+/UMTS/GPRS/EDGE requires:

- a network subscription to a GSM/HSPA+/UMTS/GPRS/EDGE network (you need to know what service providers are in your geographic area), and
- an installed SIM card that has been activated by the network service provider (see [SIM Card Installation](#) on page 9-3).

Using a CDMA requires:

- an active account with a CDMA carrier. The account is linked to the Mobile Equipment Identifier (MEID) of the integrated WWAN radio.

Penta Band Antenna



The WWAN radio features an internal antenna that is optimized for power output and receiver sensitivity. This is an omni-directional antenna.

For the WWAN radio, there is a unified penta band antenna that supports 850/900/1800/1900 (GSM/GPRS/EDGE), 850/1900/2100 (HSPA+/UMTS), and 850/1900 (CDMA).

Signal Strength

The signal strength of the WWAN connection is indicated by the number of bars that appear in the signal strength icon in the Title bar at the top of the window.



Icon	Indicates...
	The signal strength of the radio connection.
	The signal strength of the phone (voice) connection; see GSM/HSPA+ Global Radio Dolphin Models on page 9-5.
	The signal strength of the data connection; see Data Communication (GSM/HSPA+ Global Radio Dolphin Models) on page 9-9.

Voice and Data Communication

Dolphin terminals with integrated GSM/HSPA+/UMTS/GPRS/EDGE radios are optimized for the following two-way voice and data communications:

Voice: GSM voice data (dial-up)

Data: Available speed depends on the wireless network carrier and their supported packet-data technology in addition to network conditions.

GPRS Class 10: data transmission max. 85.6 kbps (DL), max. 42.8 kbps (UL)

HSPA+: data transmission max. 14.4 Mbps (DL), max. 5.76Mbps (UL)

UMTS: data transmission max. 384 Kbps (DL), max 384 Kbps (UL)

EDGE (E-GPRS) Class 10: data transmission max. 237 Kbps (DL), max. 118 kbps (UL)

You can use the GSM radio for voice communication and data communication, but not at the same time. If you want to communicate over the phone (voice), you cannot send data. If you want to send data, you cannot use the phone.

SIM Card Installation

Short for Subscriber Information Module, a SIM card stores the subscriber's personal information, GSM/GPRS radio settings, security keys, contacts, etc. SIM cards can be installed in compatible mobile devices, enabling you to switch devices without losing personal and setup information.

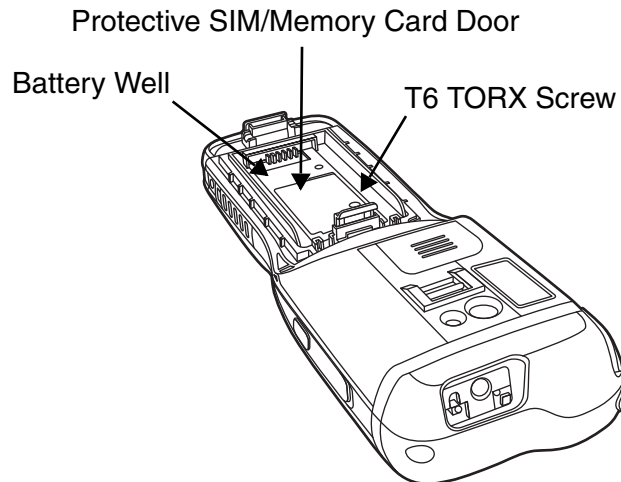

SIM Card Requirements

Before installing the SIM card:

- The service provider **must** activate the SIM card.
- The terminal **must** be powered down.

Note: If no SIM card is installed, you can still make emergency phone calls (e.g., 9-1-1).

Installing a SIM Card

 Carefully read all the information under [Equipment Intended for Use in Potentially Explosive Atmospheres](#) on page 2-1 before you attempt to install a card.

1. Press the Power key  to put the terminal in Suspend Mode.
2. Release the hand strap near the speaker on the back panel of the terminal.
3. Remove the battery door.
4. **Wait at least 3 seconds**, then remove the battery.
5. Remove the T6 TORX screw securing the protective door closed.
6. Lift up the lower left corner of the door to access the SIM card socket.
7. Unlock the access door to the memory socket by sliding the door toward the IrDA port side of the terminal.
8. Lift the door up to expose the socket.
9. Insert the SIM card into the socket.

Note: Make sure the interface on the card is connected to the SIM Card interface in the socket; align the beveled corner of the card with the beveled corner of the socket.

10. Close and lock the access door.
11. Close the protective door over the memory socket. Install and tighten the T6 TORX screw to secure the door closed.
12. Install the battery and the battery door, then reattach the hand strap.
13. Press the Power key  or SCAN key to wake the terminal.

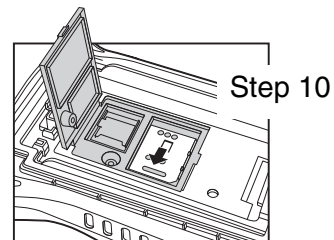
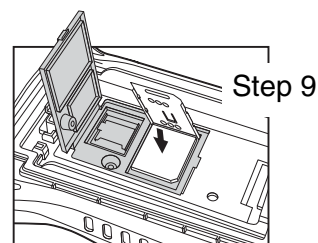
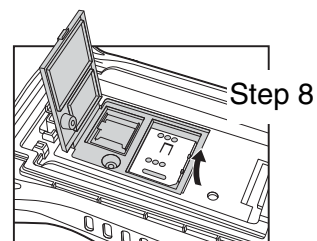
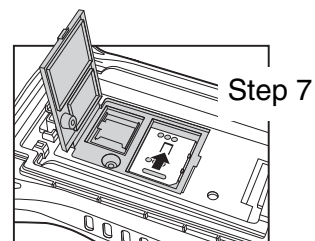
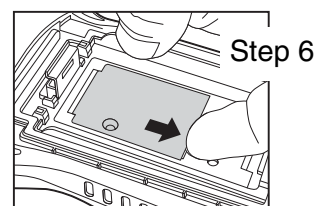
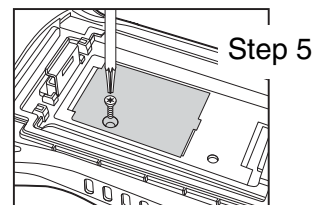

Enabling the WWAN Radio

By default, the WWAN radio is not enabled after a factory reset. Verify the status of the radio in the Dolphin Wireless Manager.

Tap  on the Home screen to access the **Dolphin Wireless Manager**.



If the WWAN radio is OFF, tap the rectangle to enable or turn ON the radio.

GSM/HSPA+ Global Radio Dolphin Models

Voice Communication

You can use the Dolphin terminal as a phone over the GSM radio.

Audio Modes

The front panel of the 99EX contains both a speaker and a microphone that you can use to send and receive audio signals over the GSM network, see [Front Panel: 99EX](#) on page 3-5.

There are two audio modes:

- **Handset Mode** - The front speaker is used for receiving handset voice calls and the front panel microphone provides audio input to the terminal.
- **Hands-Free Mode** - Hands-free mode is when you use the rear speaker as a speakerphone. To switch to speakerphone, tap on the speaker button in the Dialer window, see [Accessing the Dialer Window](#) on page 9-6.

Volume Control



Use the Dolphin keyboard to adjust the volume.

To raise the volume, press the Blue modifier key + up arrow.

To lower the volume, press the Blue modifier key + down arrow.

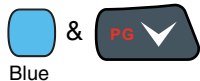

Or

Press the up or down arrow on the Volume Control button on the right side of the device to adjust the volume of the active speaker, see [Volume Control Button](#) on page 3-9.

Accessing the Dialer Window

Note: The WWAN radio must be active for voice communication, see [Enabling the WWAN Radio](#) on page 9-5.

Tap on the Home screen or tap > **Phone** to open the Phone dialer.

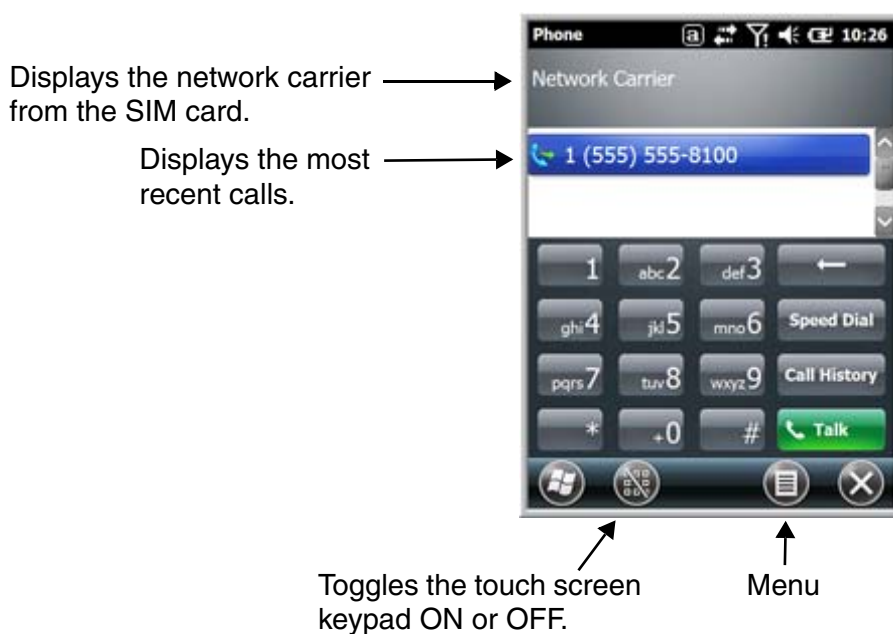

Dialing

Once the dialer window is open, you can dial out two ways:

- Tap the buttons on the dialer window.
- Use the physical keyboard (when the keyboard is in numeric mode).

Sending Calls

After the number is dialed, tap **Talk**  or press the **Blue**  + **Send** key .

Note: The  icon indicates that the phone is in use.

Ending Calls

While the phone call is live, tap **End**  or press the **Blue**  + **End Key** .

Accessing Voice Mail

Tap  > **Phone**  > **Speed Dial**  > **Voice Mail** > **Call**.

Note: Update the voice mail retrieval number by turning the phone OFF and then ON via the Dolphin Wireless Manager, see [Enabling the WWAN Radio](#) on page 9-5.

View Options

From the view menu, you can modify the display screen to show Calls and Contacts, All Calls or Speed Dial numbers.

Tap **Menu**  > **View**.

Setup Options

The Options menu contains four setting widows: Sounds, Security, Services, and Network.

Tap **Menu**  > **Options**.

Sounds



The **Sounds** screen enables you to customize the:

- Ring type (e.g., Ring, Increasing ring, Ring once, Vibrate, Vibrate and ring, Vibrate then ring or None)
- Ring tone
- Keypad tone (e.g., Long, Short, or Off)

Security



The **Security** screen provides access to establish or change your security PIN. Check the box next to, “Require a PIN when the phone is used” to enable the PIN security feature.

Services



For each service, the phone reads settings from the network stored on the SIM card and then displays the available options from the carrier on the screen. To customize the settings, select it from the list and tap “Get Settings”.

Network



You can find, select, and set your preferred network order from the **Network** screen.

Data Communication (GSM/HSPA+ Global Radio Dolphin Models)

You set up data communication via the Connections Manager. The carrier on the SIM card is the ISP.

System Requirements



- The GSM radio must be enabled; see [Enabling the WWAN Radio](#) on page 9-5.
- You must have an active SIM card with a DATA plan installed; see [SIM Card Installation](#) on page 9-3.

Information Requirements

You must have from the SIM card carrier:

- The APN (access point name).
- The user name and password of the account.

Establishing Data Communication

1. Tap  > **Settings** > **Connection** > **Connections** .
2. Under My ISP, tap **Add a new modem connection**.

-
3. Enter a name for the connection. Select **Cellular Line (GPRS)** as the modem. Tap **Next**.

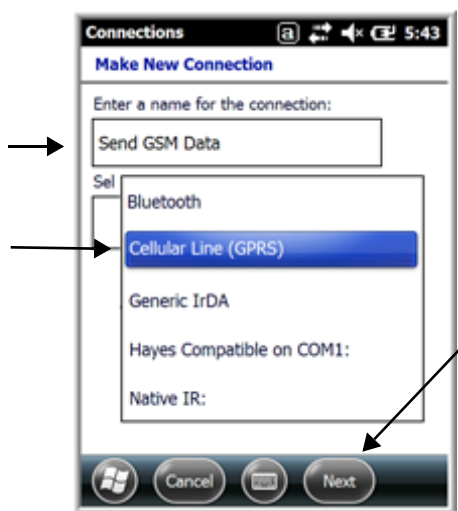

4. Enter the Access point name. Tap **Next**.

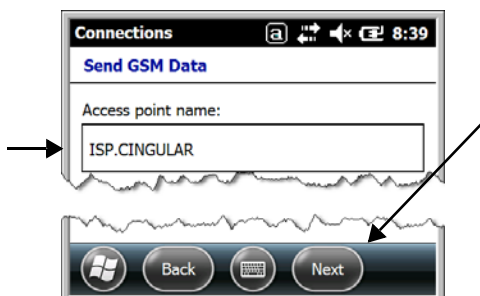

5. Enter the user name and password from the account. Tap **Finish**.

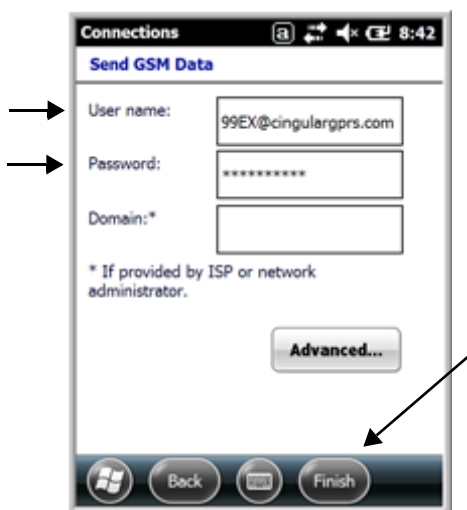

- The connection you just created should appear in the list on the modem tab.

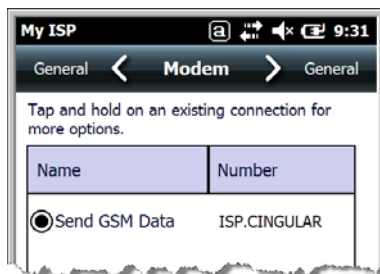

- Tap and hold on the connection. Select **Connect** on the popup menu.

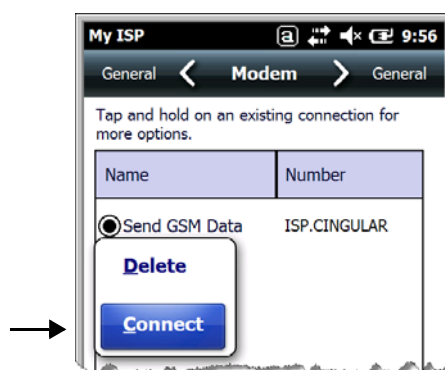

- The network icon in the Title bar indicates the GSM radio is attempting to connect .

Note: When the device is on a 2G (EDGE/GPRS) network, a data connection failure occurs if the phone is in use for a voice call while attempting a data connection. Simultaneous voice and data use is only supported if the device is on a 3G network. In 2G mode, a voice call takes precedence over data connections. Active data connections are placed in "park" mode automatically and the data is "retrieved" when the voice call ends.

- When the connection is complete, the network icon changes to: .
- You can now send data over GSM.



Ending the Data Connection

By default, the data connection will disconnect after a certain amount of time passes without use. This period of time is determined by ISP.

To end the data connection manually, tap the network icon  in the Title bar and select **Disconnect** on the popup bubble.

Manual Network Selection

You can select Automatic or Manual network selection. The Phone defaults to Automatic network selection.

-
1. When an active SIM card is inserted in the terminal, tap  > **Settings** > **Personal** > **Phone**  > **Menu** > **Options**.
 2. Select the **Network** tab.

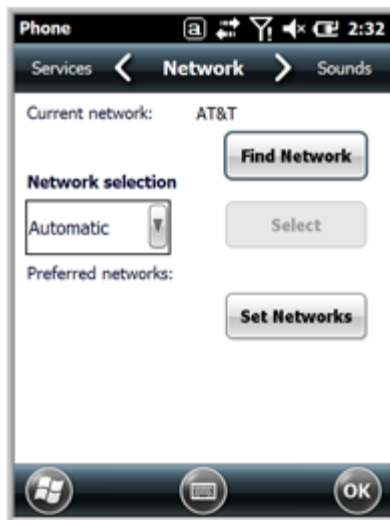

3. Under **Network selection**, select **Automatic** (the default selection) or **Manual**.
 - a. If you select **Manual**, the Phone searches for available networks.



- b. The found networks appear.

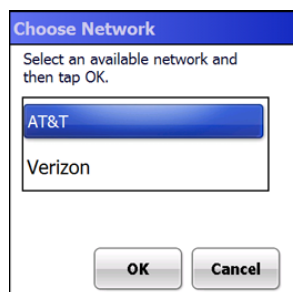

- c. Select a new network and tap **OK**. The Phone registers on the new network and the Network tab appears.
 - d. To switch to another network, tap the now active **Select** button and the process repeats.
4. To switch back to automatic roaming, select **Automatic** under **Select networks** and tap **OK**.

Data Communication GSM/CDMA Dolphin Models

Gobi Manager

The Gobi Manager enables you to see real time status of the radio, setup your Network selection, view you're profile and scan for networks. The Gobi Manager contains four tabs: Status, Setup, Profile, and About.

1. Tap  on the Home screen to access the **Dolphin Wireless Manager**.
2. Tap **Menu**.
3. Select **Gobi Settings**.

Status Tab

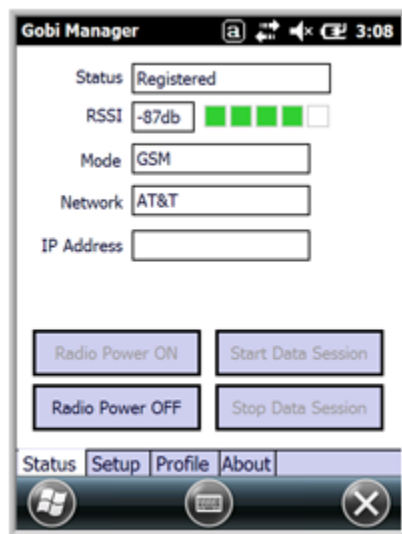

The **Status** tab contains the real time radio status information including:

- The power status of the radio (e.g., ON or OFF)
- The received signal strength intensity (RSSI)
- The radio mode used (e.g., GSM, UMTS, EVDO or 1xRTT)
- The network firmware used
- The IP Address assigned

You can also turn the radio ON or OFF and Start or Stop a data session from the Status tab.

Setup Tab

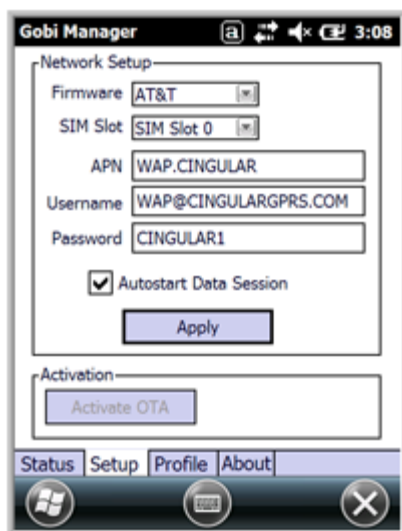

The **Setup** tab allows you to view and customize the Network Setup including:

- The Network Firmware (e.g., AT&T, Verizon, Sprint, or T-Mobile)
- The SIM Slot accessed
- The Access Point Name (APN)
- The Username of the account
- The Password of the account
- Enable or Disable Automatic Data Sessions
- Activate Over the Air (OTA)

Profile Tab

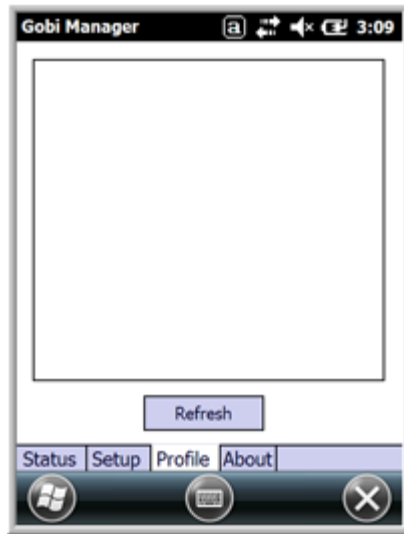

The **Profile** tab allows you to see Radio capability information and network statistics including:

- Radio Hardware and Software versions
- Radio and SIM identification numbers
- Serving network connection type and state
- Available radio interfaces for the current serving network

About Tab Displays copyright and version information for the Gobi Connection Manager.

Establishing Data Communication

1. Tap  on the Home screen to access the **Dolphin Wireless Manager**.
2. Tap **Menu** and then select **Gobi Settings**.
3. From the **Setup** tab, select the carrier and enter user information (GSM only).

Note: An installed SIM card is required and the SIM slot option must be set to 0.

4. Check the **Auto Start Data Session** check box to automatically start the data session.
5. Tap the **Apply** button. The Connection Manager automatically switches to the **Status** Tab.
6. Tap the **Radio Power ON** button.
7. When the radio connects to the network, the status changes to "Registered" and a signal strength is displayed.
8. If **Auto Start Data Session** was checked on the **Setup** tab, the state automatically changes from "Registered" to "Data Session Open" and an IP address appears. If **Auto Start Data Session** was not selected, then the Data session can be started manually by tapping **Start Data Session** button from the **Status** tab.

Working with the Bluetooth Radio

Enabling the Bluetooth Radio

You enable the Bluetooth radio in the [Dolphin Wireless Manager](#) (see page 8-6).

1. Tap  on the Home screen to access the **Dolphin Wireless Manager**.

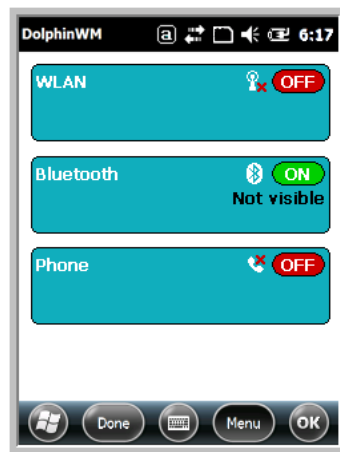

2. Tap anywhere inside the Bluetooth rectangle and Bluetooth begins activating.

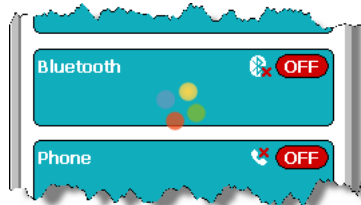

3. When the radio is activated (i.e., transmitting a signal), the **OFF** button changes to **ON**.



Now, the Bluetooth radio is transmitting a signal. Additional text in the Bluetooth section tells information about the Bluetooth radio. “Visible” and “Not visible” indicates whether the Bluetooth radio is discoverable or not discoverable by other Bluetooth devices.

Now, you can connect to other transmitting and discoverable Bluetooth devices (see page 10-2).

To make the terminal discoverable, [see page 10-6](#).

Pairing and Trusted Devices

The terminal does support pairing. Pairing happens during general connection setup. Paired devices are "trusted" devices. This means that there is unrestricted access to all services (including services that require authorization and authentication).

A connection can exclude pairing. A device that is connected to the terminal but not paired with it is considered an untrusted device. Content can still be passed to untrusted devices by requiring authorization with each attempt (for example, with the initialization of a file exchange). The Beam File method of file transfer can be used to pass a file as an untrusted device; see [Transferring Files](#) on page 10-5.

Connecting to Other Bluetooth Devices

To connect to other bluetooth devices, you need to perform a device discovery, select a discovered device, and then connect to the selected device. Pairing happens as part of the connection process.

1. Make sure the bluetooth device is in range and set to be discoverable by other bluetooth devices.
2. In the Dolphin Wireless Manager, tap **Menu > Bluetooth Settings**.

OR

Tap  > **Settings > Bluetooth** .

3. Tap **Add new device**. The terminal begins searching for discoverable Bluetooth devices.



-
4. Select a device from the list and tap **Next**.

The types of devices in the vicinity of the radio appear in the list of discovered devices.



5. You are prompted to enter a passcode.

- If the device has a specific passcode, enter it in the **Passcode** field and tap **Next**.

When attempting to connect to a printer or headset with Bluetooth capabilities, the passcode may default to either 1111 or 0000. If there is no default, consult the device literature for the number.

- If the device does not have a specific passcode, enter one in the **Passcode** field and tap **Next**.

6. The Bluetooth radio tries to connect with the device.

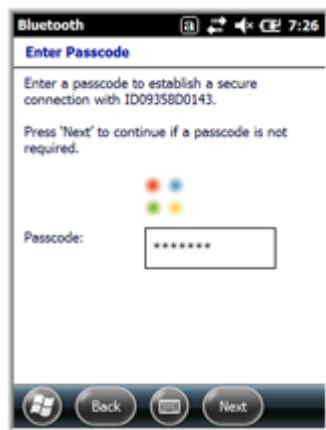

7. If you created a passcode, you will be prompted by the other device to enter the same passcode. Enter the created passcode to establish a paired connection.

If you entered a device specific passcode, you should not have to do anything on the other device.

-
8. When the connection is complete, a list of matching and supported services on the device appears. Only the services that are mutually supported on both devices appear in the Partnership Settings window.



9. Select the services you want to use and tap **Save**.

The services on the new devices have to be selected or the pairing won't include those services, even though the devices are paired. If services are not selected, you will be continually re-prompted for the passcode from the device.

10. The device appears in the list on the main window.

If you are connecting to a printer or headset, complete any additional steps required by device.



11. After the passcodes have been accepted on both sides, you have a trusted (paired) connection.

Transferring Files

1. Tap  > **File Explorer**.
2. Navigate to the file you want to transfer.
3. Tap and hold on the file and select **Beam File** on the popup menu.



4. The Bluetooth radio begins searching for devices.

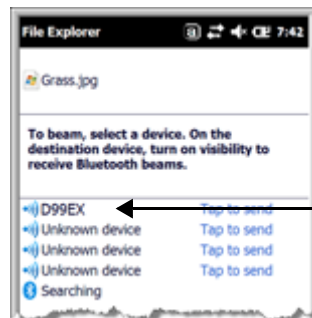

When a Bluetooth device is first found, it appears as an Unknown device; the  icon indicates that the device is a Bluetooth device.

As data is retrieved, the device IDs appear in the list.

5. Tap the device to begin sending the selected file.
6. While trying to connect, the selected device reads "Pending".

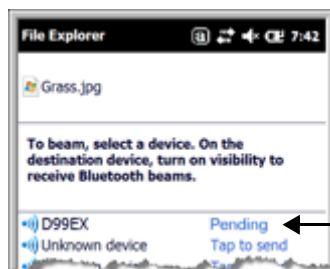

7. When the file is being transferred, the selected device reads "Sending".



Making the Terminal Discoverable

By default, the Dolphin terminal is not discoverable, which means that the terminal will not be found by other Bluetooth devices.

To make the terminal discoverable, tap **Mode** on the Horizontal scroll. Select **Make this device visible to other devices** and tap **OK**.



Selecting COM Ports

You can select COM ports 0-9. For more information, see [99EX COM Port Assignment Table](#) on page 8-13.

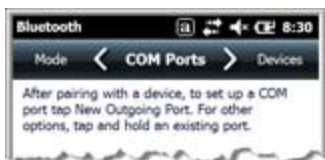

Overview

The Dolphin 99EX terminal contains an integrated GPS module that allows location tracking of workers and vehicles, providing better utilization of field assets. Optional mapping and navigation software provides turn-by-turn driving directions and location information.

Assisted GPS Support

The operating system software does not inhibit nor explicitly support assisted GPS modes, which usually requires installing a vendor-specific client on the terminal that communicates with the GPS module. This client would then provide the almanac and/or ephemeris data for warm or hot start modes of operation, allowing a lower time to first fix (TTFF). The Client must be configured on the terminal, active, and provide the data to the GPS module through the standard COM port.

Powering the GPS Module

The GPS module powers on automatically when accessed by a software application and powers off automatically when that software application closes. You cannot manually power on and off the GPS module.

Communication Ports

There are two ways to access the GPS module: through the actual COM port (COM7) or the GPS Intermediate Driver. The method you use depends on the software application you are using. If the software application requires the actual COM Port, set the operating system to use COM7. If the software application requires the GPS Intermediate Driver, set the operating system to use the GPS Intermediate Driver.

Selecting the Port

1. Tap  > **Settings** > **System** > **External GPS**.
2. In the **GPS program port:** drop-down list, select **COM7** or **GPD1** (the GPS Intermediate Driver) as required by the application.

Note: The GPS program port and hardware port cannot be the same value.

3. Tap **OK** to save.

COM7

COM Port 7 can be set to the following baud rates:

- 4800
- 9600 (Default baud rate. Recommended for optimal performance.)
- 19200
- 38400

Other baud rates are not possible. The baud rate selected on COM7 is the actual baud rate with which the GPS communicates.



GPS Intermediate Driver

When the first user of GPD1 opens the port, the GPS Intermediate Driver opens the COM7 port. The GPS Intermediate Driver allows multiple applications to open GPD1, and the GPS data is broadcast to all open ports.

When the GPSID driver is in use, the COM7 port is allocated to GPSID as READIWRITE (COM7 is still available for access mode of 0).

For more information about Microsoft's GPS Intermediate Driver, follow this link:

<http://msdn.microsoft.com/en-us/library/ms850332.aspx>

GPS Demo

The GPS Demo demonstrates the main functionality of the integrated GPS module. The GPS Demo uses COM7.

To see the GPS Demo, tap  > **Demos** > **GPS Demo**.

Dolphin 99EX HomeBase Device (Model 99EX-HB)

Overview

As the hub of your Dolphin system, the Dolphin 99EX HomeBase (99EX-HB) charging and communication cradle supports both RS232 and USB communications, which make it able to interface with the majority of PC-based enterprise systems.

The 99EX-HB charger is designed for use with battery pack models 99EX-BTSC (standard Li-poly 3.7 V, 11.3 watt hour) and 99EX-BTEC (extended Li-ion 3.7 V, 18.5 watt hour) manufactured for Honeywell International Inc. and with all Dolphin 99EX model terminals.

Note: Dolphin 99EX models intended for use in potentially explosive atmospheres are only approved to use battery pack model 99EX-BTEC (PN 99EX-BTEC-2) or 99EX-BTSC (PN 99EX-BTSC-2). See [Equipment Intended for Use in Potentially Explosive Atmospheres](#), starting on page 2-1 for additional information.



Warning! The HomeBase is not designed for use in hazardous locations.



We recommend use of Honeywell peripherals, power cables, and power adapters. Use of any non-Honeywell peripherals, cables, or power adapters may cause damage not covered by the warranty.

Unpacking the HomeBase

Open the shipping box and inspect the package to see that the following standard items are included:

- One Dolphin HomeBase, model 99EX-HB
- One UL Listed power supply rated a 12VDC, 3A (see [Power](#) on page 12-5)
- One power cord

These items are needed to operate the HomeBase. If any items are missing or anything appears to be damaged, contact your Customer Account Representative. Keep the original packaging in case you need to return the HomeBase for service or to store the HomeBase while not in use.

Optional Equipment

A standard RS232 or a standard USB cable is required when using the HomeBase for communication between the terminal and a host device.

Charge Time

The base completes a full charge of the main battery pack installed in the terminal seated in the terminal well in 4 hours for the standard battery or 6 hours for the extended battery. The base completes a full charge of the battery pack in the [Auxiliary Battery Well](#) (see page 12-3) in 4 hours for the standard battery or 6 hours for the extended battery.

Charging Process

The base also provides power to the intelligent battery charging system in all Dolphin terminals that senses when a full charge has been achieved and switches to a trickle charge to maintain the full charge.



Before you attempt to use, charge, or change the battery in the terminal carefully read all the information under [Equipment Intended for Use in Potentially Explosive Atmospheres](#), starting on page 2-1 and the [Guidelines for Battery Pack Use and Disposal](#) on page 3-13.

Communications

Reliable data communications at speeds of up to 115K baud can be transmitted by the base through the RS232 serial port. Using the Hi-Speed USB port, the data transmission rate goes up to 480 Mbps.

These bases cannot be physically connected to each other - sometimes referred to as “daisy-chained”.

Convenient Storage

The intelligent battery charging system makes this base a safe and convenient storage receptacle for your Dolphin terminal.

Capacity

The base holds one terminal and features an auxiliary battery well behind the terminal well that can charge a battery pack independently of the terminal well. This means that one base can charge two battery packs: the one installed in the terminal and a spare.

 *We recommend use of Honeywell Li-ion or Li-poly battery packs. Use of any non-Honeywell battery may result in damage not covered by the warranty.*

 *We recommend use of Honeywell peripherals, power cables, and power adapters. Use of any non-Honeywell peripherals, cables, or power adapters may cause damage not covered by the warranty.*

Parts and Functions

Front Panel

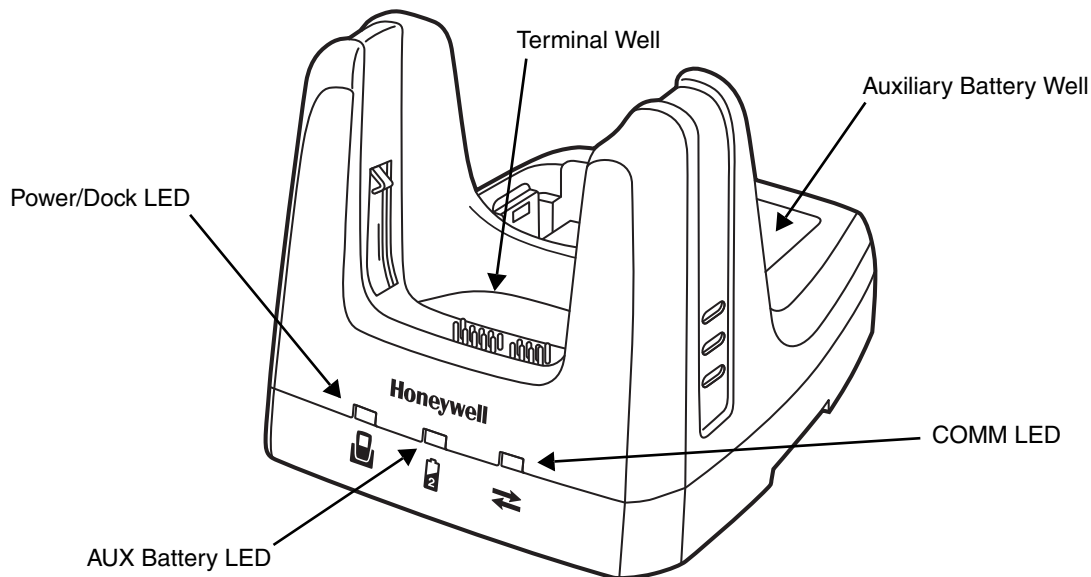

Terminal Well

Place the terminal in this well to communicate with a host device, power the terminal, and charge the installed battery pack. The base completely charges the main battery in a Dolphin terminal in 4 hours for the standard battery or 6 hours for the extended battery. If the host device is a workstation that uses ActiveSync, synchronization begins immediately.

Auxiliary Battery Well

See [Auxiliary Battery Well](#) on page 12-4.

Power/Dock LED

Indicates if power is supplied to the HomeBase and if a terminal is docked properly in the base.

This color	means...
-------------------	-----------------

Red	The HomeBase has power but no terminal is docked.
------------	---

Green	The HomeBase has power and the terminal is properly seated in the base.
--------------	---

AUX Battery LED

Indicates status of the battery charging in the auxiliary battery well; see [Back Panel](#) on page 12-4.

This color	means...
-------------------	-----------------

Orange	The auxiliary battery is charging.
---------------	------------------------------------

Green	The auxiliary battery has completed charging and is ready for use.
--------------	--

Red, Flashing	The internal temperature of the auxiliary battery is too hot or there is a battery error. Charge the auxiliary battery in a cooler environment or replace the battery with a new Honeywell battery.
----------------------	---

For information about charging a battery in the auxiliary battery well, see page 12-6.

COMM LED

This is the communication LED. It indicates the status of data transfer between the Dolphin terminal and the host device. The color of this LED differs if the base is using the serial or USB port connection.

If using the serial port

This color	means...
-------------------	-----------------

Red	Serial data is being sent from the host device to the base.
------------	---

Green	Serial data is being sent from the base to the host device.
--------------	---

Orange	Serial data is being sent in both directions at the same time.
---------------	--

If using the USB port

This color	means...
-------------------	-----------------

Green	A USB Connection is established with the host workstation.
--------------	--

Back Panel

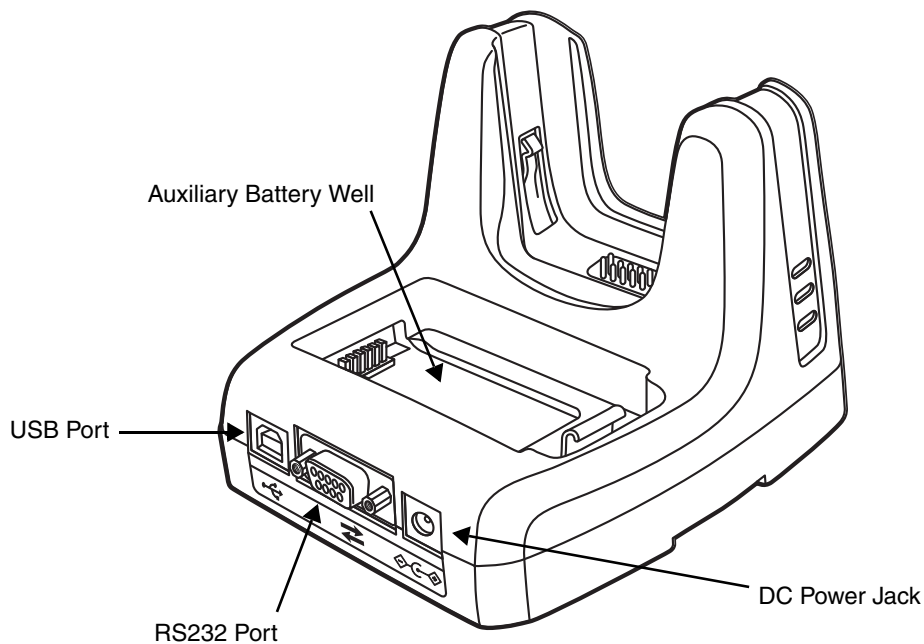

Auxiliary Battery Well

The base enables you to charge an additional battery pack independently of the terminal well in 4 hours for the standard 3.7V battery and 6 hours for the extended 3.7V battery. This feature ensures that you can always have a fully-charged battery for your terminal. See [Charging a Spare Battery in the Auxiliary Battery Well](#) on page 12-6.

USB Port

This USB port is USB v2.0 Hi-Speed compliant. Using a USB cable, you can connect the base to a host device, such as a workstation. USB communication occurs through Microsoft ActiveSync (v4.5 or higher) or Microsoft Windows Mobile Device Center (WMDC) depending on the host workstation's operating system. When the terminal is seated in the terminal well, it is connected to the host device via the base.

Note: ActiveSync on your Dolphin terminal works with Windows Mobile Device Center on host workstations running Windows Vista or Windows 7 and with ActiveSync on host workstations running Windows XP. For detailed information on ActiveSync and WMDC visit Microsoft's Windows Mobile Web site.

RS232 Port

Use the 9-pin, RS232 cable from Honeywell to connect this port to a peripheral device for RS232 data communication. For more information, see [Serial Connector](#) on page 12-9.

DC Power Jack

Use the power cable from Honeywell that comes with the base to supply power to this power jack. For more information, see [Power](#) on page 12-5.

Bottom Panel

For details on how to mount the HomeBase, see [Mounting the HomeBase](#) on page 12-9.

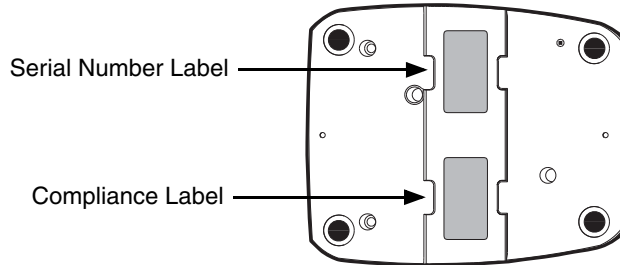

Power

The base requires 12 Volts DC input for communications, battery charging, and power output to the terminal; the power adapter included with the base converts the voltage from the AC power source to 12 Volts DC. Use only a UL listed power supply, which has been qualified by Honeywell, with output rated at 12VDC and 3 amps with the device. The operating temperature range is -10° to 50°C (14° to 122°F).

Honeywell recommends that you leave the base connected to its power source at all times, so that it is always ready to use.



We recommend use of Honeywell peripherals, power cables, and power adapters. Use of any non-Honeywell peripherals, cables, or power adapters may cause damage not covered by the warranty.

Connecting Power to the HomeBase

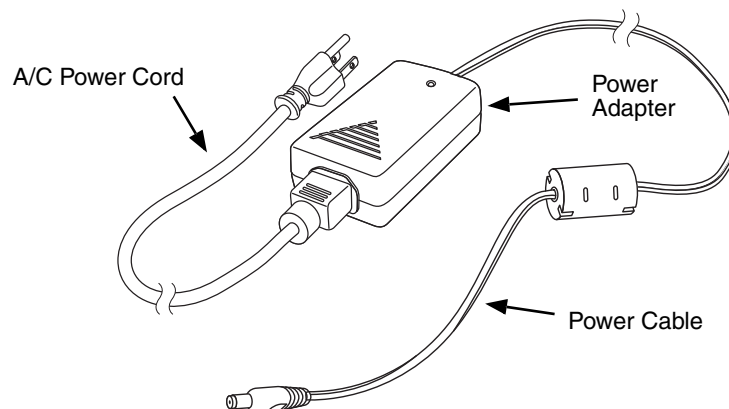

1. Plug the A/C power cord into the power adapter.
2. Plug the power cable into the power connector on the back of the HomeBase.
3. Plug the A/C power cord into a grounded power source. The base is now powered. The Power/Dock LED on the HomeBase illuminates solid red to indicate the HomeBase has power and no terminal is docked.

Charging the Main Battery

 Before you attempt to use, charge, or change the battery in the terminal carefully read all the information under [Equipment Intended for Use in Potentially Explosive Atmospheres](#), starting on page 2-1 and the [Guidelines for Battery Pack Use and Disposal](#) on page 3-13.

The base powers the terminal and fully charges its main battery pack in 4 hours for the standard 3.7V battery or 6 hours for the extended 3.7V battery. The terminal contains an intelligent battery charging system that protects the battery from being damaged by overcharging. The unit senses when a battery pack is fully charged and automatically switches to a trickle charge that maintains the battery at full capacity. Therefore, terminals may be stored in the base without damage to the terminals, battery packs, or peripherals.

To check battery power, use the Power system setting; see [Power](#) on page 7-16.

For more information about Honeywell batteries, see [Batteries](#) on page 3-11.

To Power a Terminal and Charge its Main Battery

1. Install the battery pack in the terminal; see [Install the Main Battery Pack](#) on page 2-3.
2. Verify the base has power. If the Power/Dock LED is not illuminated, see [Connecting Power to the HomeBase](#) on page 12-5.
3. Slide the terminal into the terminal well. The Power/Dock LED changes to green. The charging begins immediately if required by the Dolphin terminal.

 Ensure all components are dry prior to mating terminals/batteries with peripheral devices. Mating wet components may cause damage not covered by the warranty.

 We recommend use of Honeywell Li-Ion or Li-poly battery packs. Use of any non-Honeywell battery may result in damage not covered by the warranty.

Charging a Spare Battery in the Auxiliary Battery Well

The auxiliary battery well located on the back of the base charges a spare battery independently of the terminal well. The Aux Battery LED on the front panel indicates the status of the battery in this well.

Charge time is 4 hours for the standard 3.7V battery or 6 hours for the extended battery pack; see [Auxiliary Battery Well](#) on page 12-4.

1. Insert the battery at an angle so the battery pack contacts and the auxiliary well contacts align.
2. Snap the battery into place with a hinging motion. The Aux Battery LED lights orange.
3. Use the AUX Battery LED to monitor the charging progress. The LED lights green when the auxiliary battery has completed charging and is ready for use.

Note: If the AUX Battery LED flashes red, the internal temperature of the battery is too hot or there is a battery error. Charge the auxiliary battery in a cooler environment or replace the battery with a new Honeywell battery pack.

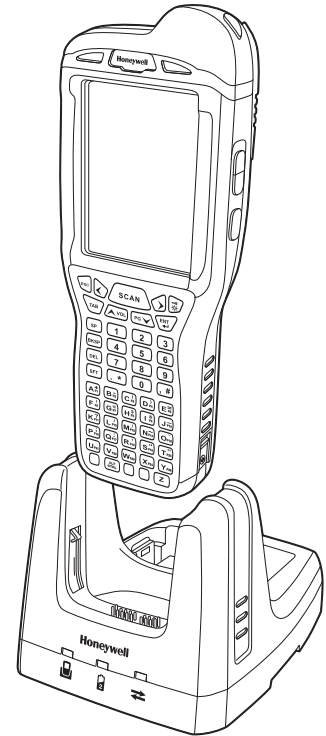

Communication

USB

Dolphin terminals support USB communications out of the box. The base also supports USB communications via the USB port located on the back. The base acts as a USB device by interfacing the USB signals of the Dolphin terminal to the USB of the host workstation. Using a standard USB cable, the base's USB interface allows the Dolphin terminal to communicate with a workstation.

RS232

The base supports RS232 communications via the RS232 Communications Port located on the back of the device. This port enables the Dolphin terminal to communicate to a workstation, modem, or any RS232 device using a standard serial cable and communications software.

Requirements

- A base powered by a power cable and power adapter cable
- For RS232 communications, a serial cable
- For USB communications, a USB cable
- A work station running Windows 98 Second Edition, Windows Me, Windows 2000, Windows NT (4.0 SP6 or higher), Windows XP, Windows Vista, or Windows 7.
- ActiveSync (v4.5 or above) or Windows Mobile Device Center on the workstation

Connecting the Communication Cables

1. Plug in the power supply and connect it to the back of the base.
2. Plug the USB or the RS232 communication cable into the back of the base.
3. Connect the communication cable into the back of the workstation.
4. At this point, the hardware is installed and operating. You may need to reboot your workstation to complete the installation process.

Establishing Communication

USB or RS232 communication with the terminal is usually auto-detected and configured by ActiveSync or Windows Mobile Device Center based on the communication cable connected. If you are using a USB cable to connect to the workstation, the sync software sets up a USB connection. If you are using an RS232 cable, the sync software sets up an RS232 connection.

For more information, see [Serial Connector](#) on page 12-9.

Communicating with the Dolphin Terminal

To initiate communications between the Dolphin terminal and peripheral, complete these steps:

1. Insert the Dolphin terminal into the terminal well of the base.
 - The DOCK LED illuminates green. If the DOCK LED does not illuminate, make sure that the terminal is properly seated. You may need to remove and re-insert the terminal.
 - The Dolphin terminal activates; if the power is off, the terminal automatically powers on. If the terminal does not power on, verify that the Honeywell power supply is properly connected to the cradle and plugged into a functioning outlet.

- If the base is connected to the workstation, the Dolphin terminal automatically opens ActiveSync or the Windows Mobile Device Center to establish a connection.
2. The base can now transfer data between the terminal and the host device. If communication does not occur, check the port connections to ensure that the cradle is correctly configured.

Verifying Communication

You can verify that the USB driver is functioning by watching the COMM LED on the USB base. When the COMM LED illuminates solid green, the base is communicating with the host device.

Verifying Data Transfer

The COMM LED flashes when data is being transferred via the base. For an RS232 connection, the COMM LED flashes red and green. For a USB connection, the COMM LED does not flash during data transfer.

RS232 Communications Cables

Connect the base to the host workstation or other device by plugging an RS232 serial cable into the RS232 Communications Port on the rear of the base. The wiring of your cable depends on whether the other device is set up as a Data Communications Equipment (DCE) or Data Terminal Equipment (DTE) device.

The Communication Port is configured as a DCE device. To communicate with a DCE device, use either a null modem adapter in line with a standard RS232 cable, or a null-modem serial cable. To communicate with a DTE device such as a workstation, use a standard (or straight-through) RS232 cable.

You can make your own cables by following the pin configuration in the chart that follows. To do so, you must determine if your host RS232 device is 9-pin or 25-pin, and whether it is configured as a DCE or DTE device.

RS232 Pin Configuration

Base /Host Port (DCE)	IBM AT DB9 (DTE)	IBM XT DB25 (DTE)	Modem DB25 (DCE)
Pin / Input Signal			
2 / (RD)	2	3	2
3 / (TD)	3	2	3
5 / (SG)	5	7	7
4 / (DTR)	4	20	6
6 / (DSR)	6	6	20
7 / (RTS)	7	4	5
8 / (CTS)	8	5	4

Note: This base cannot be daisy-chained.

Note: The input signal names are referenced to the DTE target device (ie. workstation or host computer) in accordance with the RS232 standard.

Serial Connector

The following diagram displays the pin diagram of the serial connector of the base.

Pin	Description
1	Internal Jumper to Pin 6
2	TXD
3	RXD
4	No Connect
5	GND
6	DTR
7	CTS
8	RTS
9	RI

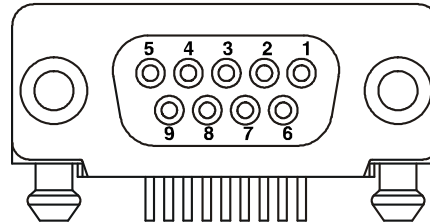

Note: The signal names are referenced to the terminal. The terminal is a DCE RS232 device. Refer to section, RS232 Communications Cables and RS232 Pin Configuration for more details. The base is at a right-angle to the printed circuit board (PCB). The ninth pin has a ring indicator (RI).

Mounting the HomeBase

Set the base on a dry, stable surface, such as a desktop or workbench near an electrical outlet. Be sure to provide enough workspace with good lighting for the user to view and operate the Dolphin terminal while it is in the base.

When choosing a mounting location, bear in mind that the location must allow users' easy access to the Auxiliary Battery Well and the back panel of the HomeBase where the serial port, USB port, and the power jack are located.

Desk Mounting

The DIN rail slot (7.5 X 35 mm) may be mounted on the bottom to allow for secure desk attachment of the unit if desired.

Hardware Required

- 3/16 in. dia x 5/8 in. long pan head screw
- 1/2 in. OD x 7/32 in. ID x 3/64 in. thick flat washer
- 3/16 in. dia nut

Installing the DIN Rail

1. Slide the DIN rail into the slot along the bottom panel of the base.
2. Then, using the appropriate hardware, secure the DIN rail to the desk or flat surface.

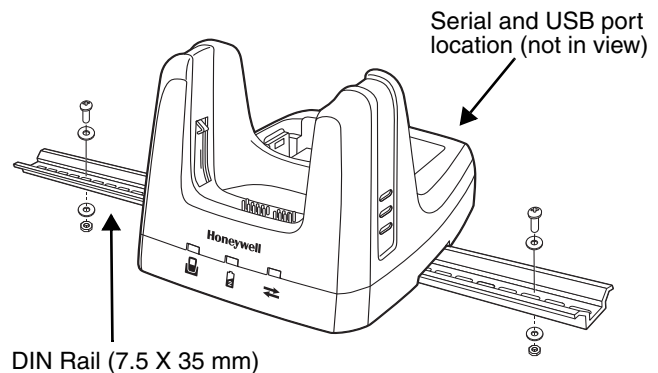



Dolphin 99EX eBase Device (Model 99EX-EHB)

Overview

The Ethernet Base (eBase) enables a single Dolphin 99EX computer to communicate with a host device over an Ethernet network.

The 99EX-EHB charger is designed for use with battery pack models 99EX-BTSC (standard Li-poly 3.7 V, 11.3 watt hour) and 99EX-BTEC (extended Li-ion 3.7 V, 18.5 watt hour) manufactured for Honeywell International Inc. and with all Dolphin 99EX model terminals.

Note: Dolphin 99EX models intended for use in potentially explosive atmospheres are only approved to use battery pack model 99EX-BTEC (PN 99EX-BTEC-2) or 99EX-BTSC (PN 99EX-BTSC-2). See [Equipment Intended for Use in Potentially Explosive Atmospheres](#), starting on page 2-1 for additional information.



Warning! The eBase is not designed for use in hazardous locations.



We recommend use of Honeywell peripherals, power cables, and power adapters. Use of any non-Honeywell peripherals, cables, or power adapters may cause damage not covered by the warranty.

Unpacking the eBase

Open the shipping box and inspect the package to see that the following standard items are included:

- One Dolphin eBase Ethernet cradle, model 99EX-EHB
- One power supply (see [Power](#) on page 13-5)
- One power cord

You will also need to provide a standard CAT-5 Ethernet network cable. These items are needed to set up and operate the eBase. If any items are missing or anything appears to be damaged, contact your Customer Account Representative.

Keep the original packaging in case you need to return the eBase for service or to store the eBase while not in use.

Charge Time

The base completes a full charge of the main battery pack installed in the terminal seated in the terminal well in 4 hours for the standard 3.7V battery or 6 hours for the extended 3.7V battery. The base completes a full charge of the battery pack in the [Auxiliary Battery Well](#) (see page 13-2) in 4 hours for the standard 3.7V battery or 6 hours for the extended 3.7V battery.



Before you attempt to use, charge, or change the battery in the terminal carefully read all the information under [Equipment Intended for Use in Potentially Explosive Atmospheres](#), starting on page 2-1 and the [Guidelines for Battery Pack Use and Disposal](#) on page 3-13.

Convenient Storage

The intelligent battery charging system makes this base a safe and convenient storage receptacle for your Dolphin terminal.

Capacity

The base holds one terminal and features an auxiliary battery well behind the terminal well that can charge a battery pack independently of the terminal well. This means that one base can charge two battery packs: the one installed in the terminal and a spare.

 We recommend use of Honeywell Li-poly or Li-ion battery packs. Use of any non-Honeywell battery may result in damage not covered by the warranty.

Parts and Functions

Front Panel

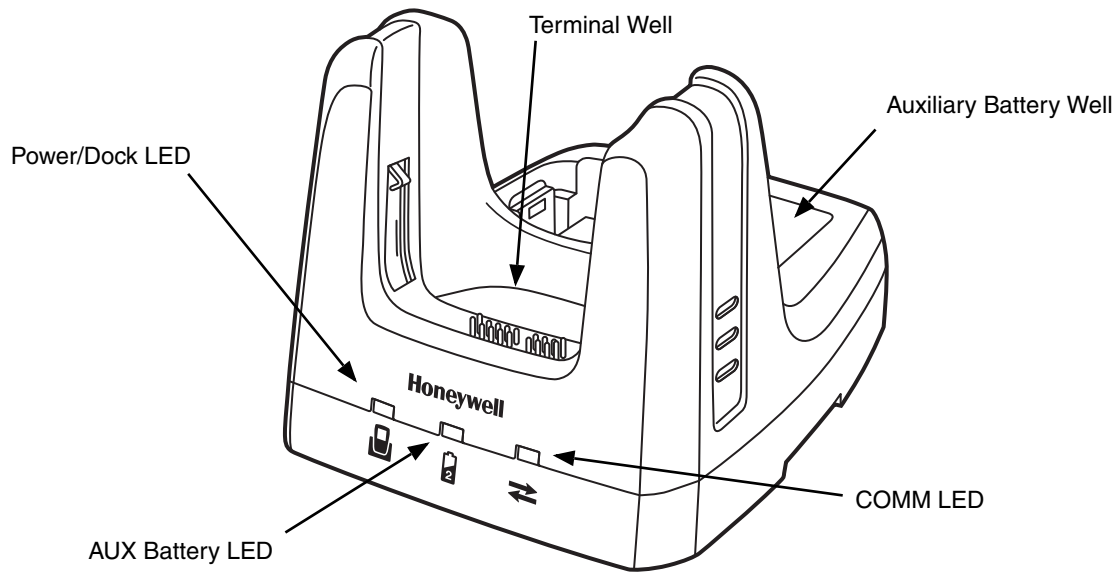

Terminal Well

Place the terminal in this well to communicate with a host device, power the terminal, and charge the installed battery pack. The eBase completely charges the main battery in a Dolphin terminal in 4 hours for the standard 3.7V battery or 6 hours for the extended 3.7 battery.

Auxiliary Battery Well

See [Auxiliary Battery Well](#) on page 13-4.

Power/DOCK LED

Indicates if power is supplied to the eBase and if a terminal is docked properly in the base.

This color	means...
------------	----------

Red	The eBase has power but no terminal is docked.
-----	--

Green	The eBase has power and the terminal is properly seated in the base.
-------	--

AUX Battery LED

The AUX Battery LED indicates the status of the battery charging in the auxiliary battery well; see [Back Panel](#) on page 13-4.

This color	means...
------------	----------

Orange	The auxiliary battery is charging.
--------	------------------------------------

Green The auxiliary battery has completed charging and is ready for use.

This color means...

Red Flashing The internal temperature of the auxiliary battery is too hot or there is a battery error. Charge the auxiliary battery in a cooler environment or replace the battery with a Honeywell battery.

COMM LED ⇄

The COMM LED indicates the status of data transfer between the Dolphin terminal and the eBase.

Ethernet Communication

When the Dolphin terminal is docked:

This color and status means...

Green Solid A connection has been established between the Dolphin terminal and the Ethernet.

Green Flashing Data transfer in progress.

USB Communication

When the Dolphin terminal is docked:

This color and status means...

Red Solid A USB connection has been established between the Dolphin terminal and the host workstation.

Back Panel

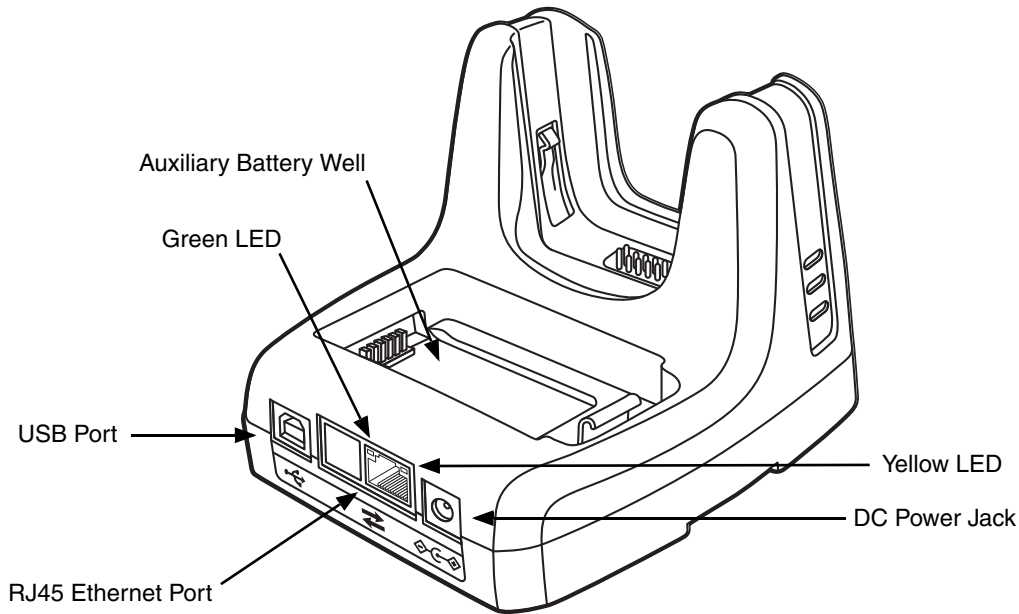

Auxiliary Battery Well

The eBase enables you to charge an additional battery pack independently of the terminal well in 4 hours for the standard 3.7V battery or 6 hours for the extended 3.7V battery. This feature ensures that you can always have a fully charged battery for your terminal.

USB Port

This USB port is USB v2.0 Hi-Speed compliant. Using a USB cable, you can connect the eBase to a USB compliant device to facilitate USB communication to and from the terminal. USB communication occurs through Microsoft ActiveSync (v4.5 or higher) or Microsoft Windows Mobile Device Center depending on the host workstation's operating system. When the terminal is seated in the terminal well, it is connected to the peripheral device via the eBase.

Note: ActiveSync on your Dolphin terminal works with Windows Mobile Device Center on host workstations running Windows Vista or Windows 7 and with ActiveSync on host workstations running Windows XP. For detailed information on ActiveSync and Windows Mobile Device Center visit [Microsoft's Windows Mobile Web site](#).

RJ45 Ethernet Port

Use a standard CAT-5 Ethernet cable; you can connect the ebase to an Ethernet-compliant device to facilitate Ethernet communication to and from the terminal.

This color	and status	means...
Green	Flashing	Data transfer in progress.
	Solid	A connection has been established between the Dolphin terminal and the Ethernet.
Yellow	Solid	Ethernet is connected at 100T.
	Off	Ethernet is connected at 10T.

DC Power Jack

Use the power cable from Honeywell that comes with the eBase to supply power to this power jack. For more information, see [Power](#) on page 13-5.

Bottom Panel

For details on how to mount the eBase, see [Mounting the eBase](#) on page 13-8.

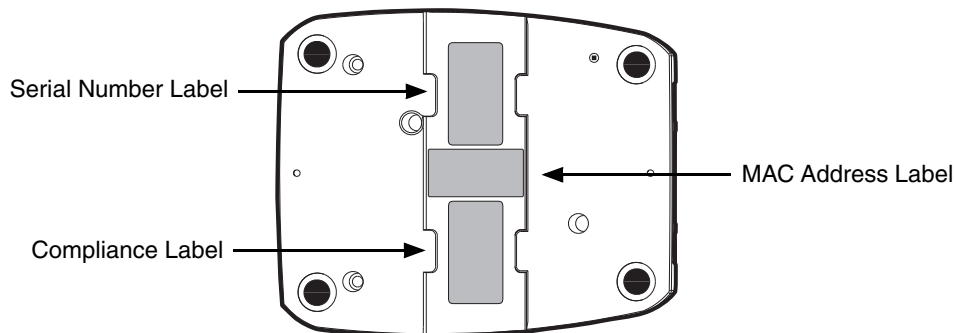

Power

The terminal requires 12 Volts DC input for communications and battery charging; the power adapter on the power cable converts the voltage from the power source to 12 Volts DC. Use only a UL Listed power supply, which has been qualified by Honeywell with output rated 12VDC and 3 amps with the device. The operating temperature range is -10° to 50°C (14° to 122°F).

Honeywell recommends that you leave the eBase connected to its power source at all times, so that it is always ready to use.



We recommend use of Honeywell peripherals, power cables, and power adapters. Use of any non-Honeywell peripherals, cables, or power adapters may cause damage not covered by the warranty.

Connecting Power to the eBase

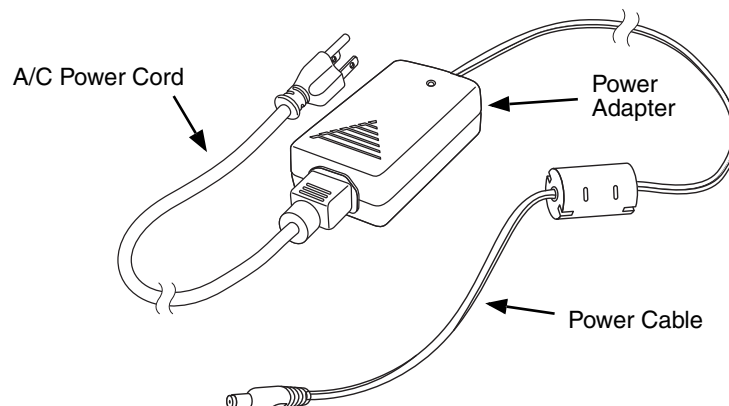

1. Plug the A/C power cord into the power adapter.
2. Plug the power cable into the power connector on the back of the eBase.
3. Plug the A/C power cord into a grounded power source. The Power/Dock LED on the eBase illuminates solid red to indicate the eBase has power and no terminal is docked.

Charging the Main Battery

 Before you attempt to use, charge, or change the battery in the terminal carefully read all the information under [Equipment Intended for Use in Potentially Explosive Atmospheres](#), starting on page 2-1 and the [Guidelines for Battery Pack Use and Disposal](#) on page 3-13.

The eBase provides power to the Dolphin terminal and allows the charging of the terminal's main battery. The intelligent battery charging system incorporated into all Dolphin terminals prevents overcharging, which means that Dolphin terminals may be stored in the eBase indefinitely without damage to the terminals, battery packs, or the eBase.

To check battery power, use the Power system setting; see [Power](#) on page 7-16.

For more information about Honeywell Li-poly or Li-ion batteries, see [Batteries](#) on page 3-11.

To Power a Terminal and Charge its Main Battery

1. Install the battery pack in the terminal; see [Install the Main Battery Pack](#) on page 2-3.
2. Verify the base has power. If the Power/Dock LED is not illuminated, see [Connecting Power to the eBase](#) on page 13-5.
3. Slide the terminal into the terminal well. The Power/Dock LED changes to green. Battery charging begins immediately if required by the Dolphin terminal.

 Ensure all components are dry prior to mating terminals/batteries with peripheral devices. Mating wet components may cause damage not covered by the warranty.

 We recommend use of Honeywell Li-poly or Li-ion battery packs. Use of any non-Honeywell battery may result in damage not covered by the warranty.

Charging a Spare Battery in the Auxiliary Battery Well

The auxiliary battery well located on the back of the base charges a spare battery independently of the terminal well. The Aux Battery LED on the front panel indicates the status of the battery in this well.

Charge time is 4 hours for the standard 3.7V battery or 6 hours for the extended battery pack; see [Auxiliary Battery Well](#) on page 13-4.

1. Insert the battery at an angle so the battery pack contacts and the auxiliary well contacts align.
2. Snap the battery into place with a hinging motion. The Aux Battery LED lights orange.
3. Use the AUX Battery LED to monitor the charging progress. The LED lights green when the auxiliary battery has completed charging and is ready for use.

Note: If the AUX Battery LED flashes red, the internal temperature of the battery is too hot or there is a battery error. Charge the auxiliary battery in a cooler environment or replace the battery with a new Honeywell battery pack.

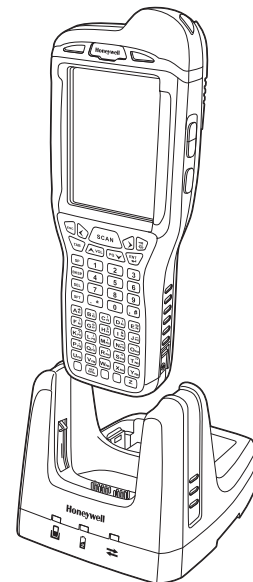

Communication

Software Requirements

Before you connect the Dolphin terminal to the eBase, make sure you have the most current software installed. To check the terminal's system information, tap  > **Power Tools** > **SysInfo**.

- The Kernel version must be 26.01 or later in terminals running Windows Embedded Handheld 6.5 Classic.
- In terminals running Windows Embedded Handheld 6.5 Professional, the kernel version must be 25.01 or later.



Applications on the Dolphin Terminal

Applications running on the Dolphin terminal when it is connected to the eBase should be designed specifically for a partially connected network. For more details, please refer to the *Best Practices for Partially Connected Networks* document available at www.honeywellaidc.com.

Establishing Ethernet Communication

Connecting the Dolphin Terminal to the eBase

By default, the Dolphin terminal is configured to obtain IP addresses automatically via DHCP server. This means that in most cases you would simply plug-and-play the unit.

1. Verify the base has power. If the Power/Dock LED is not illuminated, see [Connecting Power to the eBase](#) on page 13-5.
2. Plug the CAT-5 Ethernet cable into the RJ45 connector on the back of the eBase.
3. Plug the Ethernet cable into the network.
4. Insert the Dolphin into the terminal well. The DOCK LED for the well changes from red to green and the connection icon on the Dolphin's title bar changes from  to .

Note: Instead of using the default for DHCP assigned IP addresses, the Dolphin terminal can use a statically assigned IP address. See standard Microsoft Windows Mobile documentation for how to assign a static IP address to a network adapter. In this case, set a static IP address for the adapter named "SMC95001 USB2.0 FAST Ethernet Drive".

Displaying the eBase and Terminal IP Address



Once the Dolphin terminal has been successfully connected to the eBase, the terminal uses the eBase IP address. This IP address can be used by any application on the Dolphin terminal.

1. Tap  > **Power Tools** > **Network Utilities** > **IPConfig**.
2. Change the **Adapter** to SMC95001.
3. On the Input tab, tap the **Display full configuration** button.
4. The Dolphin terminal retrieves and displays the IP configuration for the entire terminal and eBase. Locate the **IpAddress** field in the IP configuration list.

Establishing USB Communication

Dolphin terminal's support USB communication out of the box. The eBase also supports USB communications using the USB port located on the back panel of the eBase. The eBase acts as a USB device by interfacing the USB signals of the Dolphin terminal to the USB of the host workstation. Using a standard USB cable, the ebase's USB interface allows the Dolphin terminal to communicate with a host workstation.

Setting Up and Connecting the Dolphin Terminal to the eBase

1. Verify the base has power. If the Power/Dock LED is not illuminated, see [Connecting Power to the eBase](#) on page 13-5.
2. Plug the USB communication cable into the USB port on the back of the eBase.
Note: The Dolphin terminal should always be removed from the eBase when connecting or disconnecting the USB cable.
3. Connect the other end of the USB cable to the host workstation.
4. Insert the Dolphin terminal in the eBase terminal well. The Power/Dock LED changes to green and the COMM LED illuminates red.
5. The Dolphin terminal activates and automatically opens ActiveSync to establish a connection.
6. The connection icon in the Dolphin's navigation bar changes from  to  it indicates a successful connection. The eBase can now transfer data between the terminal and the host device.

Mounting the eBase

Set the eBase on a dry, stable surface, such as a desktop or workbench near an electrical outlet. Be sure to provide enough workspace with good lighting for the user to view and operate the Dolphin terminal while it is in the eBase.

When choosing a location, bear in mind that:

- the mounting location must allow users easy access to the Auxiliary Battery Well, and
- the Ethernet and USB ports as well as the power jack face straight out of the rear panel, and you will most likely want easy access to them in the future.

Desk Mounting

The DIN rail slot (7.5 X 35 mm) may be mounted on the bottom to allow for secure desk attachment of the unit if desired.

Hardware Required

- 3/16 in. dia x 5/8 in. long pan head screw
- 1/2 in. OD x 7/32 in. ID x 3/64 in. thick flat washer
- 3/16 in. dia nut

Installing the DIN Rail

1. Slide the DIN rail slot along the bottom panel.
2. Then, using the appropriate hardware, secure the DIN rail to the desk or flat surface.

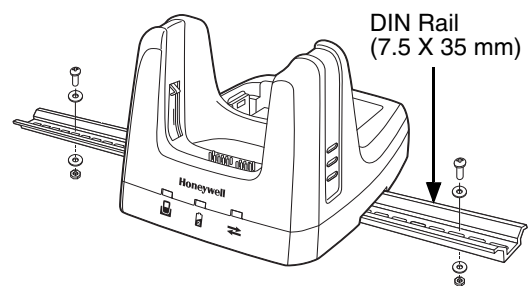

Dolphin 99EX Mobile Base Device (Model 99EX-MB)

Overview

The 99EX-MB charging and communication cradle is designed specifically for in-premise and in-transit data collection applications. It features a flexible mounting bracket and a cigarette lighter adapter to adapt it to your environment. The 99EX-MB is designed for use with all Dolphin 99EX model terminals using battery pack model 99EX-BTSC (standard Li-poly 3.7 V, 11.3 watt hour) or 99EX-BTEC (extended Li-ion 3.7 V, 18.5 watt hour) manufactured for Honeywell International Inc.

Note: Dolphin 99EX models intended for use in potentially explosive atmospheres are only approved to use battery pack model 99EX-BTEC (PN 99EX-BTEC-2) or 99EX-BTSC (PN 99EX-BTSC-2). See [Equipment Intended for Use in Potentially Explosive Atmospheres](#), starting on page 2-1 for additional information.

The serial connector supports RS232 communication and power out to peripheral devices, such as hand held scanners. The USB connector supports USB communication and power to peripheral devices such as a memory stick or printer.

As the hub of your Dolphin mobile data collection system, the base performs three important functions: charging, communications, and storage.



Warning! The Mobile Base is not designed for use in hazardous locations.

Charging

The base completes a full charge of the main battery pack in 4 hours for the standard 3.7V battery or 6 hours for the extended 3.7V battery pack. The base also provides power to the intelligent battery charging system in all terminals that senses when a full charge has been achieved and switches to a trickle charge to maintain the full charge.



Before you attempt to use, charge, or change the battery in the terminal carefully read all the information under [Equipment Intended for Use in Potentially Explosive Atmospheres](#), starting on page 2-1 and the [Guidelines for Battery Pack Use and Disposal](#) on page 3-13.

Communications

The base supports both RS232 and USB communications. Through the RS232 serial port, you can transmit reliable data communications at speeds of up to 115K baud. By using the Hi-Speed USB (v2.0) port, the data transmission rate goes up to 480 Mbps.

Convenient Storage

Intelligent battery charging makes the base a safe and convenient storage receptacle for your Dolphin terminal.



We recommend use of Honeywell Li-Ion or Li-poly battery packs. Use of any non-Honeywell battery may result in damage not covered by the warranty.



We recommend use of Honeywell peripherals, power cables, and power adapters. Use of any non-Honeywell peripherals, cables, or power adapters may cause damage not covered by the warranty.

Front Panel

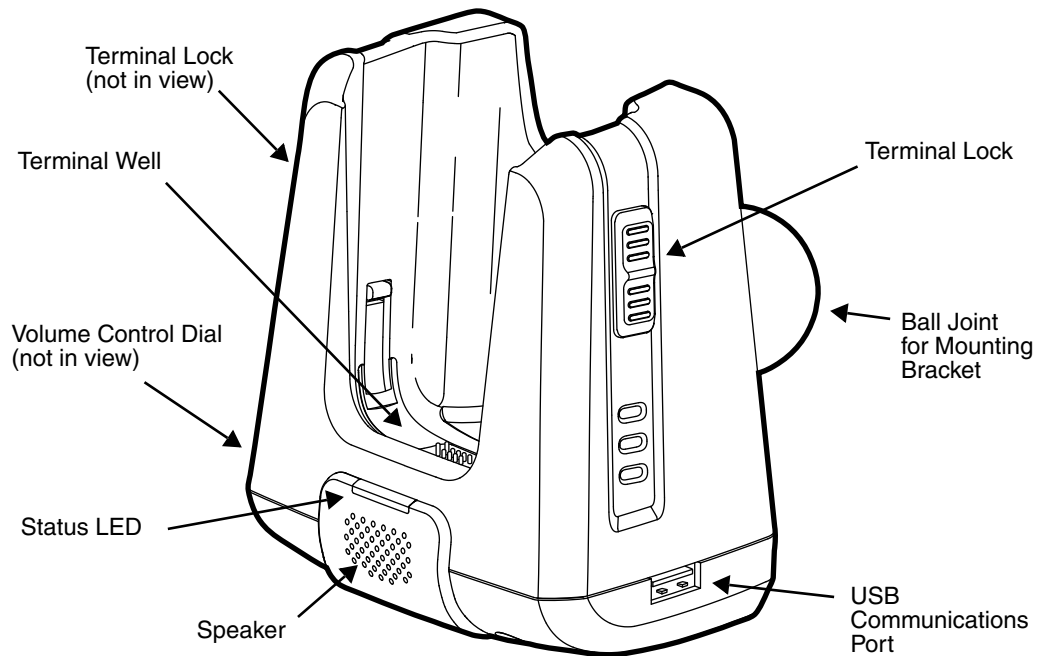

Mounting Bracket

Used to mount the base to a fixed location.

Speaker

Amplifies the Dolphin's audio signals.

Status LED

Illuminates solid green when the Dolphin terminal is properly seated in the terminal well.

Terminal Locks

The mobile base has a locking switch on the left and right side. Pushing one of the switches up locks the terminal in the base. To unlock the terminal push either switch down.

Terminal Well

Place the terminal in this well. Once seated, the terminal can communicate with a host device and its main battery pack begins charging.

USB Communications Port

This USB Port is host Hi-Speed 2.0v compliant. You can connect the base to a peripheral device, such as a memory stick or to a printer using a USB cable. When the terminal is seated in the terminal well, it is connected to the peripheral device via the base.

Volume Control Dial

The speaker volume is adjusted via the dial located on the side of the base.

Bottom Panel

The power supply and RS232 connectors are located on the bottom of the unit.

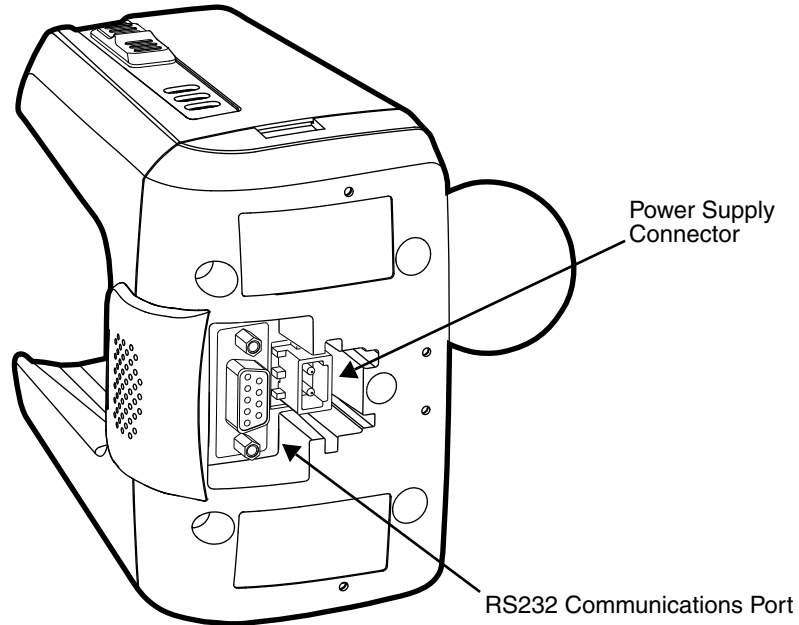

Power Supply Connector

To run on vehicle power, you can use the 12 VDC cable. The appropriate cable comes with the kit you ordered. The 12 VDC cable can be used with a cigarette lighter outlet.



Verify that the power source is always within the specified range and observe correct input voltage polarity. An improper input voltage range or reverse polarity could damage the power conversion circuitry.

RS232 Communications Port

Use a standard serial cable to connect the unit to a host device via RS232; see [Serial Connector](#) on page 14-8.

Back Panel and Mounting Brackets

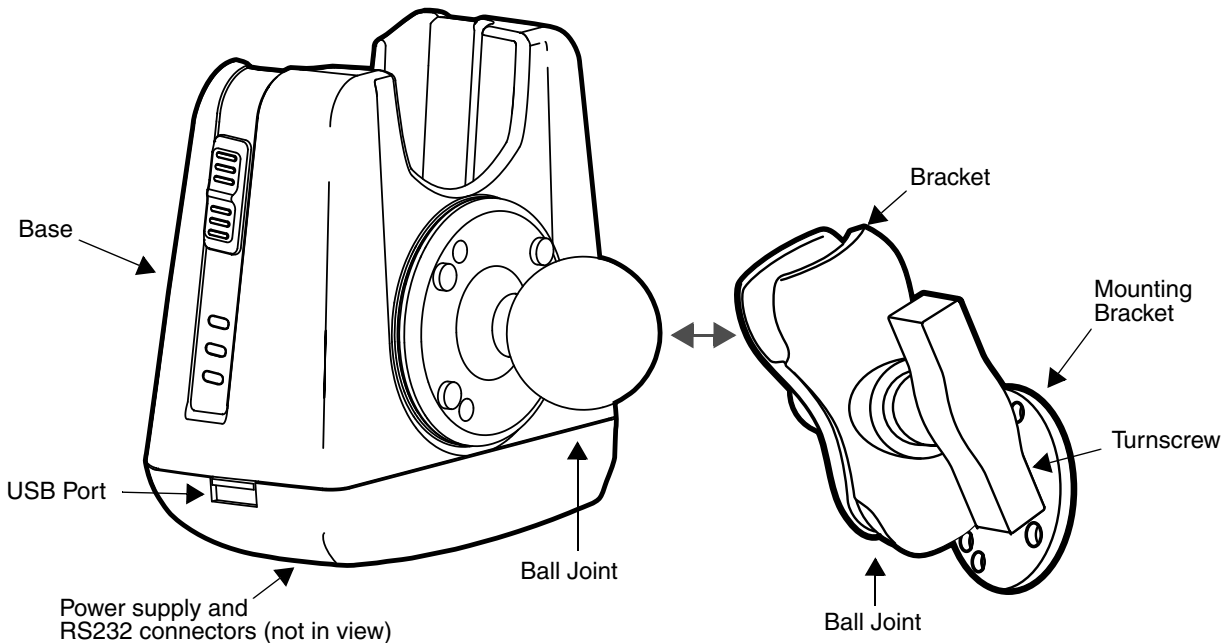

Ball Joints

There are two ball joints: one on the back of the base and one on the mounting bracket. Both ball joints are inserted into the bracket and secured to mount the base.

Connectors

The power and RS232 connectors are located on the bottom panel. For more information, see [Bottom Panel](#) on page 14-3.

Bracket

The bracket contains the turnscrew and two slots. Ball joints are inserted into each slot and secured with the turnscrew.

Turnscrew

The turnscrew is located on the top of the bracket. Rotate the turnscrew to secure or loosen the ball joint slots.

Mounting Bracket

The mounting bracket is what you attach to the mounting surface. It is comprised of a ball joint and flat disk. The disk contains drill holes you use to secure the base to the mounting surface.







Mounting

The adjustable mounting bracket holds the terminal securely in place and gives the user a variety of options for mounting the base.

Safety Precautions

Honeywell is not responsible for any damages caused to you, your vehicle, or other individuals due to the installation of the Dolphin Mobile mount.

Follow these safety precautions when mounting the mobile base:

-  Never drill into a surface in your vehicle without first consulting a mobile installation professional experienced with your vehicle type to avoid damaging the vehicle's safety features, gas tank, electrical system or other sensitive vehicle components.
-  Do not install the Mobile base in an air bag deployment zone. Honeywell assumes no responsibility of liability for injury or death because of car crashes and/or air bag deployment.
-  Do not mount the base in a location where it prevents safe operation of the vehicle and/or impedes the vehicle operator's field of view.
-  Do not mount the base in a location where the connectors on the bottom panel of the base are not easily accessible. Be sure to leave enough room for unrestricted cable connections.
-  The Mobile base is intended for use in an enclosed space protected from the elements. Do not mount the Mobile base on external vehicle surfaces.
-  Select a mounting surface that is flat and smooth like the console area in the vehicle located between the seats.

Installation

Mounting hardware is not included. You must provide the appropriate hardware for your particular application and vehicle type. **To ensure a safe installation, consult a mobile installation professional experienced with your vehicle type.**

1. Using the bracket as a template, mark the locations for the mounting screws.
2. Drill the appropriate size pilot holes in the mounting surface.
3. Secure the mounting bracket to the mounting surface using the appropriate screw type for your application and vehicle type.
4. Loosen the turnscrew.
5. Insert the ball joint of the mounting bracket to the back of the bracket.
6. Insert the ball joint on the back of the base into the other side of the bracket.
7. Tighten the turnscrew to secure both ball joints.

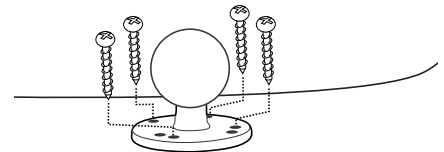

Powering the Dolphin Terminal

When seated in a base that is connected to the appropriate power source, the Dolphin terminal receives the power to charge its main battery and run its internal circuitry. Keep the base plugged into the power source so that the Dolphin terminal battery pack stays fully charged.

Note: Honeywell recommends that you leave the base connected to its power source at all times.

The base is powered via the power connector on the bottom panel; see [Bottom Panel](#) on page 14-3. Both the power and serial connectors are straight out, not at an angle. The base requires a 12 VDC power input.

Charging the Dolphin Terminal



Before you attempt to use, charge, or change the battery in the terminal carefully read all the information under [Equipment Intended for Use in Potentially Explosive Atmospheres](#), starting on page 2-1 and the [Guidelines for Battery Pack Use and Disposal](#) on page 3-13.

The base supplies charging power to the Dolphin terminal so that the terminal can monitor the charging of its battery pack. This charging method protects the battery from being damaged by overcharging. Therefore, the Dolphin terminal may be stored indefinitely in the base without damage to the terminal, the battery pack, or the base.

1. Insert a battery pack into the terminal.
2. Slide the terminal, imager window up and the LCD visible, into the terminal well until it stops.
3. When the terminal is properly seated, the DOCK LED on the base illuminates solid green. The terminal begins charging automatically.

Establishing Communication

The RS232 interface allows the terminal to communicate to a workstation, modem, any standard RS232 device using a standard RS232 and communications software.

Requirements

You need the following equipment:

- A Mobile Base device powered by a power adapter cable
- For RS232 communications, a serial cable
- ActiveSync v4.5 or above or Windows Mobile Device Center on the host workstation
- Windows 98 Second Edition, Windows Me, Windows 2000, Windows NT (4.0 SP6 or higher), Windows XP, Windows Vista or Windows 7 on the host workstation.

Connecting the Communication Cables

Note: You must be using ActiveSync (4.5 or higher) or Windows Mobile Device Center.

1. Plug in the power supply and connect it to the bottom of the base.
2. Plug the RS232 communication cable into the appropriate connector on base.
3. Connect the other end of the communication cable into the back of the workstation.

-
4. At this point, the hardware is installed and operating.
You may need to reboot your workstation to complete the installation process.

Establishing ActiveSync or Windows Mobile Device Center Communication

The Dolphin terminal is usually auto-detected and configured by ActiveSync or Windows Mobile Device Center based on the communication cable. The synchronization software automatically sets up an RS232 connection when you are using an RS232 cable.

For more details, see [Connecting and Synchronizing the Terminal and Workstation](#) on page 8-8.

RS232 Communication Cables

Connect the base to the host workstation or other device by plugging an RS232 serial cable into the RS232 Communications Port on the bottom of the base. Plug the other end of the RS232 serial cable into the correct port on the host RS232 device. The wiring of your cable depends on whether the other device is set up as a Data Communications Equipment (DCE) or Data Terminal Equipment (DTE) device.

The Communication Port is configured as a DCE device. To communicate with a DTE device such as a workstation, use a standard (or straight-through) RS232 cable. To communicate with a DCE device, use either a null modem adapter in line with a standard RS232 cable, or a null-modem serial cable.

You can make your own cables by following the pin configuration in the chart that follows. To do so, you must determine if your host RS232 device is 9-pin or 25-pin, and whether it is configured as a DCE or DTE device.

RS232 Pin Configuration

Base/Host Port (DCE)	IBM AT DB9 (DTE)	IBM XT DB25 (DTE)	Modem DB25 (DCE)
Pin / Input Signal			
2 / (RD)	2	3	2
3 / (TD)	3	2	3
5 / (SG)	5	7	7
4 / (DTR)	4	20	6
6 / (DSR)	6	6	20
7 / (RTS)	7	4	5
8 / (CTS)	8	5	4

Note: The input signal names are reference to the DTE target device (i.e., workstation or host computer) in accordance with the RS232 standard.

Serial Connector

The following diagram displays the pin diagram of the serial connector of the base.

Pin	Description
1	Internal Jumper to Pin 6
2	TXD
3	RXD
4	No Connect
5	GND
6	DTR
7	CTS
8	RTS
9	RI

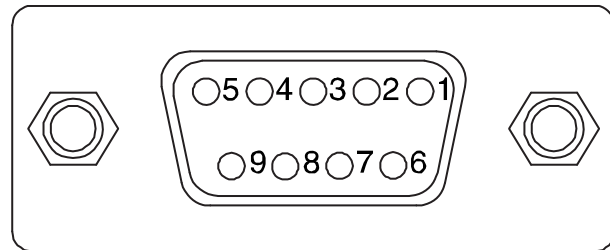

Note: The signal names are referenced to the terminal. The terminal is a DCE RS232 device. Refer to section, RS232 Communications Cables and RS232 Pin Configuration for more details. The ninth pin has a ring indicator (RI).

Dolphin 99EX ChargeBase Device (Model 99EX-CB)

Overview

The ChargeBase is a 4-slot charging cradle that can power 4 Dolphin 99EX terminals, and charge their main batteries in 4 hours for the standard 3.7V battery or 6 hours for the extended battery.

The 99EX-CB charger is designed for use with all 99EX model terminals using battery pack model 99EX-BTSC (standard Li-poly 3.7 V, 11.3 watt hour) or 99EX-BTEC (extended Li-ion 3.7 V, 18.5 watt hour) manufactured for Honeywell International Inc.

Note: Dolphin 99EX models intended for use in potentially explosive atmospheres are only approved to use battery pack model 99EX-BTEC (PN 99EX-BTEC-2) or 99EX-BTSC (PN 99EX-BTSC-2). See [Equipment Intended for Use in Potentially Explosive Atmospheres](#), starting on page 2-1 for additional information.



Warning! The ChargeBase is not designed for use in hazardous locations.



We recommend use of Honeywell peripherals, power cables, and power adapters. Use of any non-Honeywell peripherals, cables, or power adapters may cause damage not covered by the warranty.

Unpacking the ChargeBase

Open the shipping box and inspect the package to see that the following standard items are included:

- One Dolphin ChargeBase, model 99EX-CB
- One power supply (see [Power](#) on page 15-3)
- One power cord

These items are needed to operate the ChargeBase. If any items are missing or anything appears to be damaged, contact your Customer Account Representative. Keep the original packaging in case you need to return the ChargeBase for service or to store the ChargeBase while not in use.

Charging

The base supplies power to the intelligent battery charging system in all Dolphin terminals, which senses when a full charge has been achieved and switches to a trickle charge to maintain the full charge.

As battery packs charge, the charging circuitry follows the two-step charging process (CC-CV) that is recommended for Li-ion batteries. The process monitors changes in temperature, current, and voltage. The main battery of each terminal charges in 4 hours for the standard 3.7V battery or 6 hours for the extended 3.7V battery.



Before you attempt to use, charge, or change the battery in the terminal carefully read all the information under [Equipment Intended for Use in Potentially Explosive Atmospheres](#), starting on page 2-1 and the [Guidelines for Battery Pack Use and Disposal](#) on page 3-13.

Convenient Storage

Intelligent battery charging makes this base a safe and convenient storage receptacle for your Dolphin terminal.

Capacity

The base can hold up to 4 Dolphin terminals. Each charging well charges each terminal independently of the other wells.



We recommend use of Honeywell Li-Ion battery packs. Use of any non-Honeywell battery may result in damage not covered by the warranty.

Parts and Functions

Front Panel

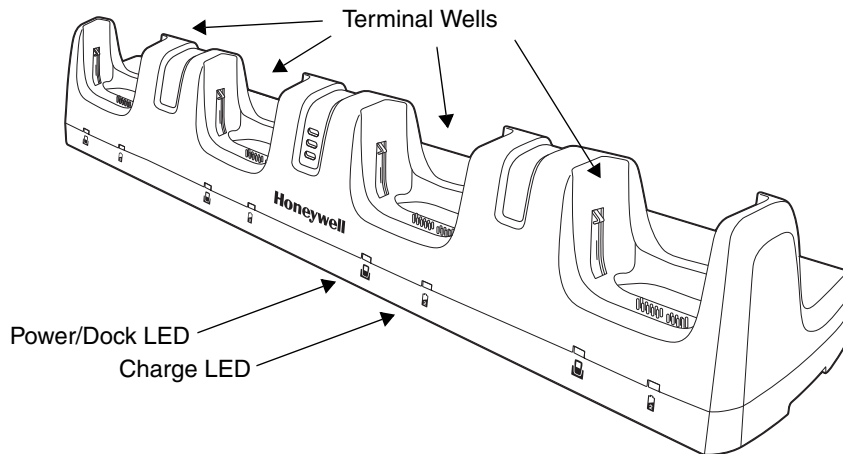

Terminal Wells

The base contains four terminal wells. Each well has its own dedicated Power/Docking LED and Charging LED indicator.

Power/Dock LEDs

The Power/Dock LED indicates if the ChargeBase has power and if the terminal is properly seated in the terminal well. Each terminal well has its own dedicated Power/Dock LED.

This color **means...**

Red The ChargeBase has power but no terminal is docked.

Green The ChargeBase has power and the terminal is properly seated in the well facilitating communication between the base and terminal

Charge LEDs

Each terminal well has a dedicated Charge LED located on the front of the base. When a Dolphin is docked in a terminal well, the Charge LED illuminates green to indicate power is being applied to the Dolphin. The Battery Icon in the Dolphin window  indicates the terminal is running on external power. If a battery pack is installed, the battery is charging in the background.

When the Dolphin is removed from the base, the battery icon indicates the charge level of the main battery pack, see [Icons in the Title Bar](#) on page 2-7. For additional information on how to check the power levels of the main battery pack and the backup battery, while the terminal is docked, see [Checking Battery Power](#) on page 3-16.

For details on how to charge the terminal using the ChargeBase, see [Charging the Main Battery](#) on page 15-4.

Back Panel

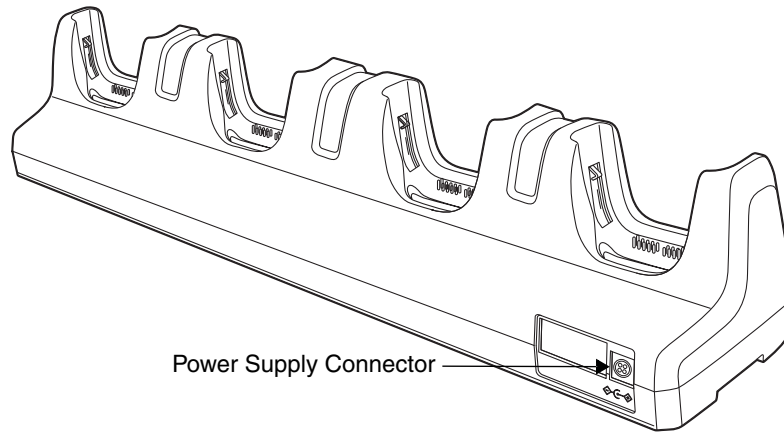

Power Supply Connector

This connector receives input from the power adapter. Plug the power connector cable from the power adapter into this connector.

Power

The terminal requires 12 Volts DC input for battery charging; the power adapter on the power cable converts the voltage from the power source to 12 volts DC. Use only a UL Listed power supply, which has been qualified by Honeywell with output rated 12VDC and 8.5 amps with the device. The operating temperature range is -10° to 50°C (14° to 122°F).

Honeywell recommends that you leave the ChargeBase connected to its power source at all times, so that it is always ready to use. For more information on how to remove the power cable, see [Removing Power to the ChargeBase](#) on page 15-11.

 We recommend use of Honeywell peripherals, power cables, and power adapters. Use of any non-Honeywell peripherals, cables, or power adapters may cause damage not covered by the warranty.

Connecting Power to the ChargeBase

1. Plug the A/C power cord into the power adapter.
2. Plug the power connector cable into the power connector on the back panel of the ChargeBase.
3. Plug the A/C power cord into a standard wall outlet. The LED on the Power Adapter illuminates to indicate power.
4. All of the Power/Dock LEDs illuminate red to indicate the base has power. Terminal wells with properly docked Dolphins indicate power with a green LED.
5. The base is ready to begin charging terminals.

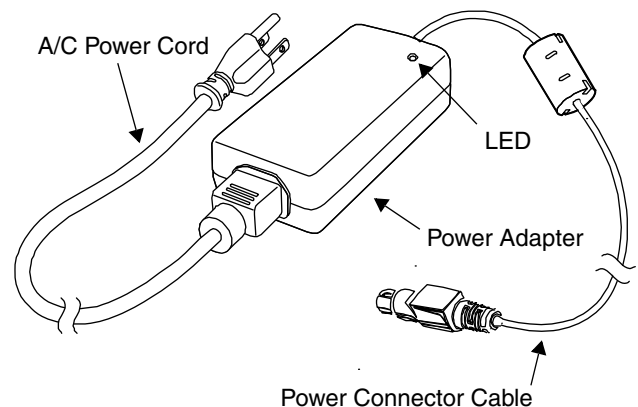

Charging the Main Battery

 Before you attempt to use, charge, or change the battery in the terminal carefully read all the information under [Equipment Intended for Use in Potentially Explosive Atmospheres](#), starting on page 2-1 and the [Guidelines for Battery Pack Use and Disposal](#) on page 3-13.

The base provides power to the Dolphin terminals and allows charging of the main batteries in the terminals. The main battery of each terminal charges in 4 hours for the standard 3.7V battery or 6 hours for the extended 3.7V battery. The intelligent battery charging system incorporated into all Dolphin terminals prevents overcharging, which means that Dolphin terminals may be seated in the base indefinitely without damage to the terminals, battery packs, or the base.

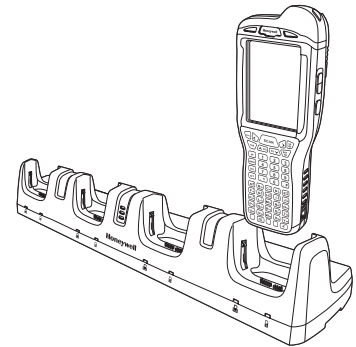

To Power a Terminal and Charge its Main Battery

1. Install the main battery pack in the terminal; see [Install the Main Battery Pack](#) on page 2-3.
2. Verify the base has power. If the Power/Dock LEDs are not illuminated, see [Connecting Power to the ChargeBase](#) on page 15-3.
3. Slide the Dolphin terminal into one of the four terminal wells. The the Power/Dock LED for the well changes to green. Charging begins immediately if required by the Dolphin terminal.

 Ensure all components are dry prior to mating terminals/batteries with peripheral devices. Mating wet components may cause damage not covered by the warranty.

 We recommend use of Honeywell Li-poly or Li-ion battery packs. Use of any non-Honeywell battery may result in damage not covered by the warranty.

Mounting the ChargeBase

This base should be mounted to a dry, stable surface. When choosing a location, always bear in mind that:

- The mounting location must allow users easy access to the power connector.
- The base should be oriented so that users can easily see the LEDs.

Bottom Panel

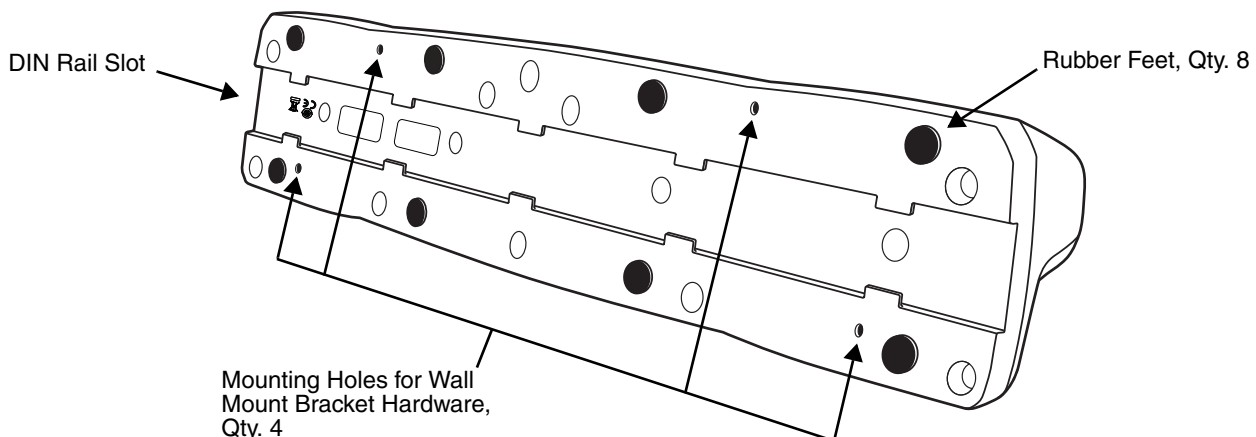

Desk Mounting

The DIN Rail (7.5 X 35 mm) slot on the bottom panel enables secure mounting on a horizontal surface.

Hardware Required

- 3/16 in. dia x 5/8 in. long pan head screw
- 1/2 in. OD x 7/32 in. ID x 3/64 in. thick flat washer
- 3/16 in. dia nut

Installing the DIN Rail

1. Slide the DIN Rail into the DIN Rail slot on the bottom panel of the base.

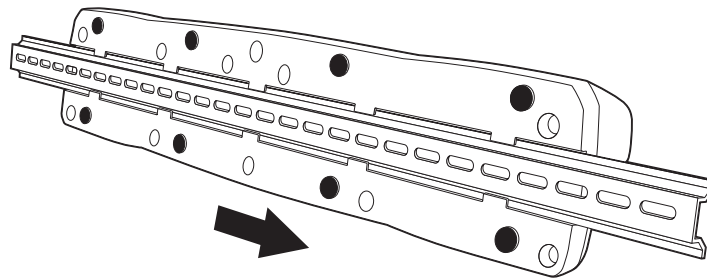

2. Turn the base and DIN Rail right side up.
3. Then, using the appropriate hardware, secure the DIN Rail to a stable, flat horizontal surface.

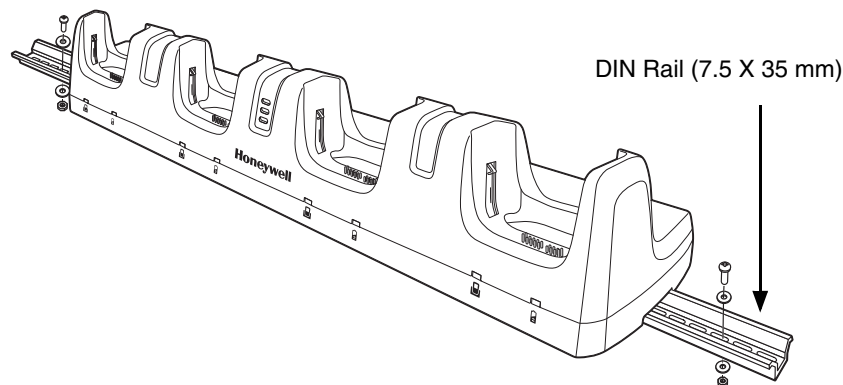

Wall Mounting

The optional wall mount bracket enables secure mounting of the base on a vertical surface. The wall mount bracket can be used in conjunction with the DIN rail but does not require the DIN Rail for use.

Hardware (Provided)

- M3 x 9 mm self-tapping screws, #2 Phillips, Qty. 4
- 3/8 in. x 4 in. round head toggle bolt, 2-5/8 in. usable length, Qty. 4
- 3/8 in. x 2 1/2 in. length Hex Head Lag Screw, Qty. 4

Tools Required

- Drill
- 7/8 in. Drill Bit (for hollow wall installations) or 1/4 in. Drill Bit (for wood stud installation)
- Phillips Screw Driver

Hollow Wall Installation

1. Drill four pilot holes in the wall using a 7/8 in. drill bit.

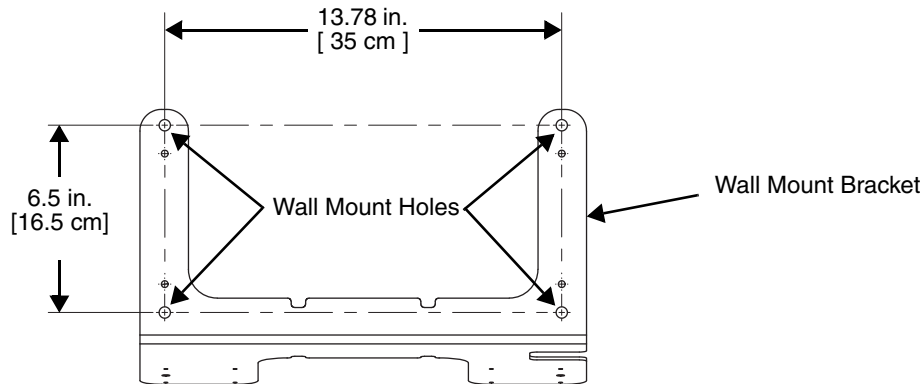

2. Slide the bolt through the wall bracket, and thread the toggle nut onto the bolt.
3. Press the ends of the toggle nut together, and insert the bolt/nut into the pilot hole until the nut clears inside wall surface. The toggle nut should spring open preventing the screw from being removed.
4. Repeat steps 2 and 3 for each of the remaining mounting holes.
5. Tighten all four bolts to secure the bracket to the wall.
6. Once the bracket is installed, secure the base to the wall bracket, see [Securing the Base to the Wall Bracket](#) for detailed instructions.

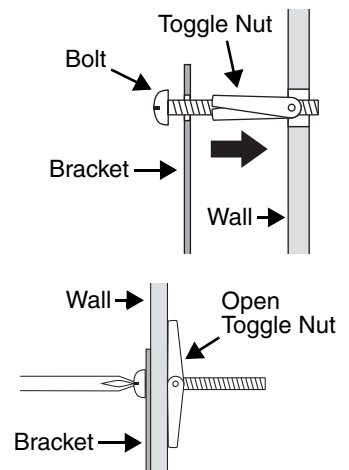

Wood Stud Installation

1. Drill four pilot holes in the wall/wood stud using the 1/4 in. drill bit.
2. Secure the bracket to the wall using the four Hex Head Lag Screws provided.
3. Once the bracket is installed, secure the base to the wall bracket, see [Securing the Base to the Wall Bracket](#) for detailed instructions.

Securing the Base to the Wall Bracket

You can secure the base to the wall bracket by using the self tapping screws provided or you can use the optional DIN Rail.

To secure the base using the self tapping screws:

1. Position the base on the wall bracket, as shown.
2. Secure the base to the bracket using the four M3 x 9 mm self-tapping screws.

To secure the base using the optional DIN Rail:

Hardware Required

- DIN Rail, Qty. 1
- 3/16 in. dia x 5/8 in. long pan head screw, Qty. 2
- 1/2 in. OD x 7/32 in. ID x 3/64 in. thick washer, Qty. 2
- 3/16 in. dia nut, Qty. 2

1. Position the DIN Rail on the wall bracket, as shown below.
2. Slide the screw through the slot on the DIN Rail and the mounting hole in the bracket.
3. Slide the washer onto the screw and tighten the nut to secure the assembly.

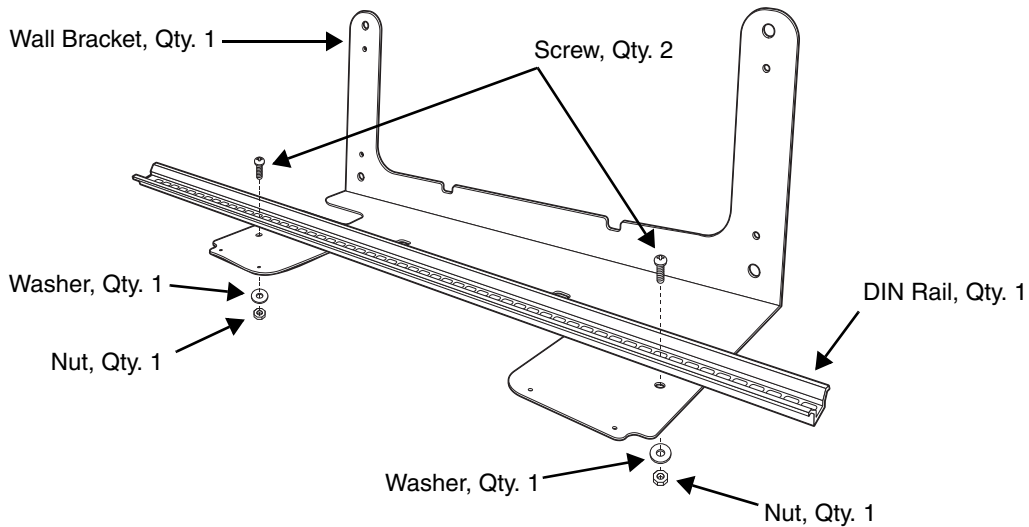

4. Remove the rubber feet on the bottom of the ChargeBase.

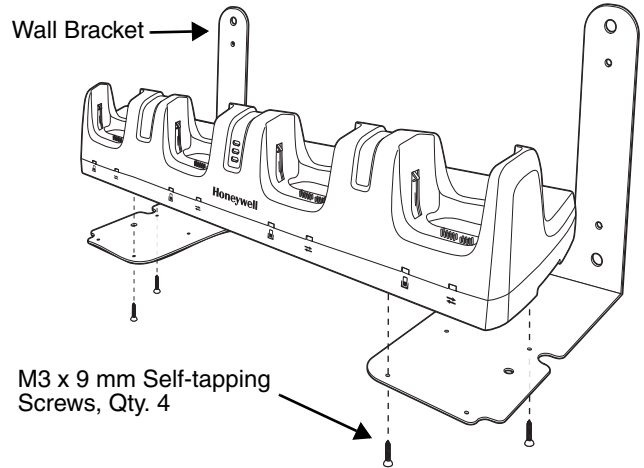

-
5. Slide the base onto the DIN Rail using the slot on the bottom of the base.

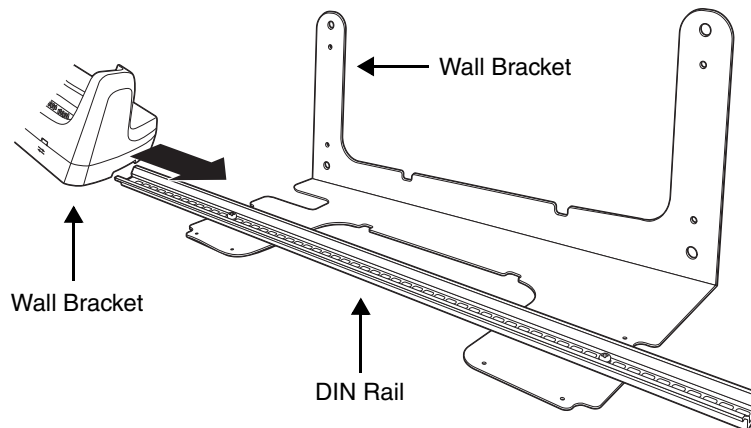

Channel Bracket Installation (Pre-existing Hardware Installations)

When choosing a location and installing the optional channel bracket:

- Do not exceed 150 lbs. maximum load on the channel bracket.
- Leave a minimum of 16 in. (40.64 cm) of horizontal space between the hardware used to attach the channel bracket to the wall.
- An electrical outlet must be easily accessible.
- The mounting location should be dry, stable, easily accessible, and well lighted.

Tools Required

- Drill
- 7/8 in. Drill Bit (for hollow wall installations) or 1/4 in. Drill Bit (for wood stud installations)
- #2 Phillips Screw Driver
- Medium Flat Head Screw Driver
- 9/16 in. Socket Wrench

Hardware Required

- 3/8 in.-16 spring nut, for 13/16 in. deep strut, Qty. 4 per wall bracket
- 3/8 in. flat washer, Qty. 4 per wall bracket
- 3/8 in.-16 x 1.00 in., cap screw, grade 5, Qty. 4 per wall bracket
- *Hollow Wall Installations:*
 - 3/8 in. x 4 in. round head toggle bolt, 2-5/8 in. usable length, Qty. 4
 - 3/8 in. flat washer, Qty. 4
- *Wood Stud Installations:*
 - 3/8 in. x 2 1/2 in. length hex head lag screw, Qty. 4
 - 3/8 in. fat washer, Qty. 4

Installation

1. Slide the spring nuts into the channel of the bracket and position them to line up with the mounting holes on the wall bracket.

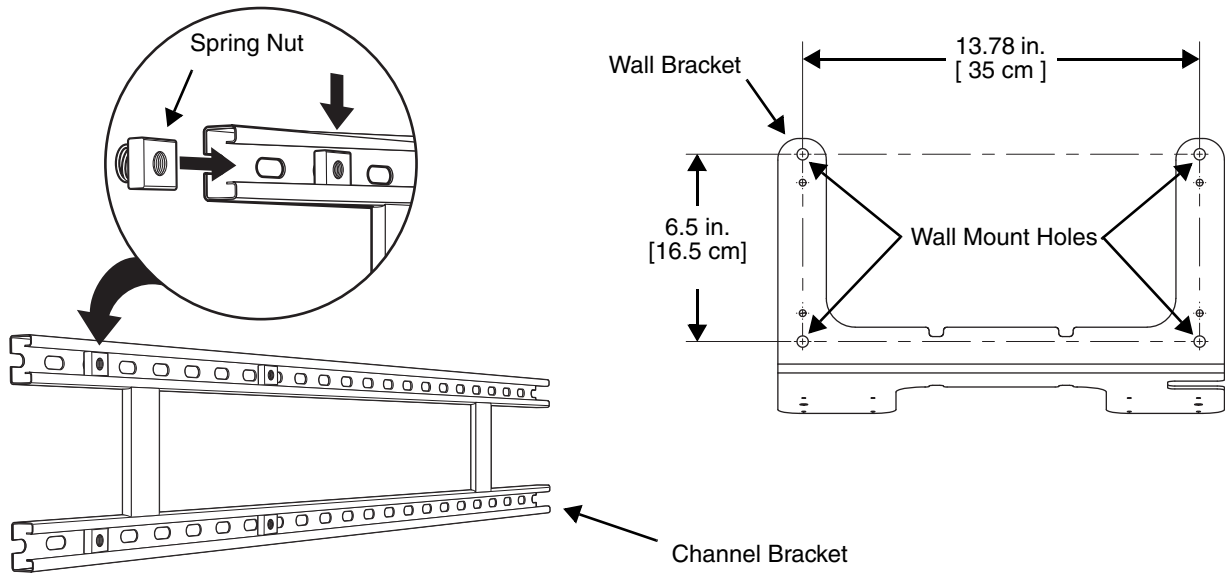

2. Attach the channel bracket to a dry, stable surface using the hardware listed on page 15-8 for the appropriate mounting surface.

Mounting into Wood Stud

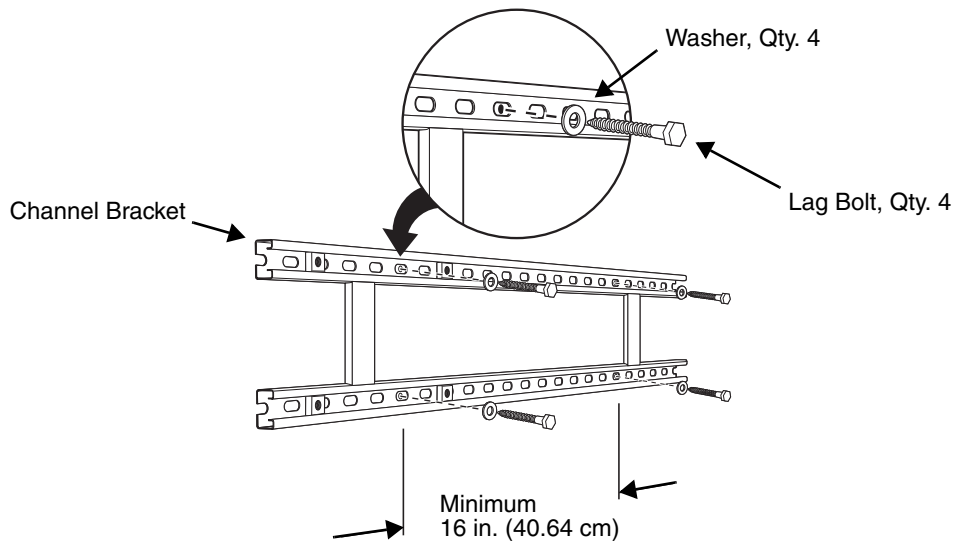

Mounting into Hollow Surface

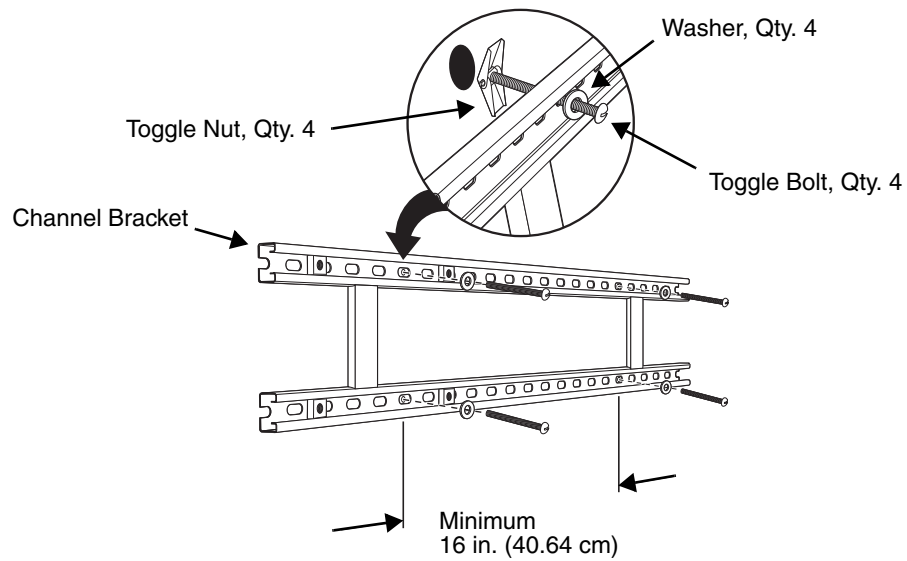

3. Align the mounting holes on the wall bracket with the spring nuts installed in the channel bracket. Secure the wall bracket in place using the cap screws listed on page [15-8](#).
4. See [Securing the Base to the Wall Bracket](#) (page 15-7) for detailed instructions on securing the ChargeBase to the wall bracket.

Removing Power to the ChargeBase

 Attempting to remove the cable without disengaging the lock may result in damage to the base and power cable not covered by the warranty.

1. Gently slide back the outer shell of the connector to disengage cable lock.

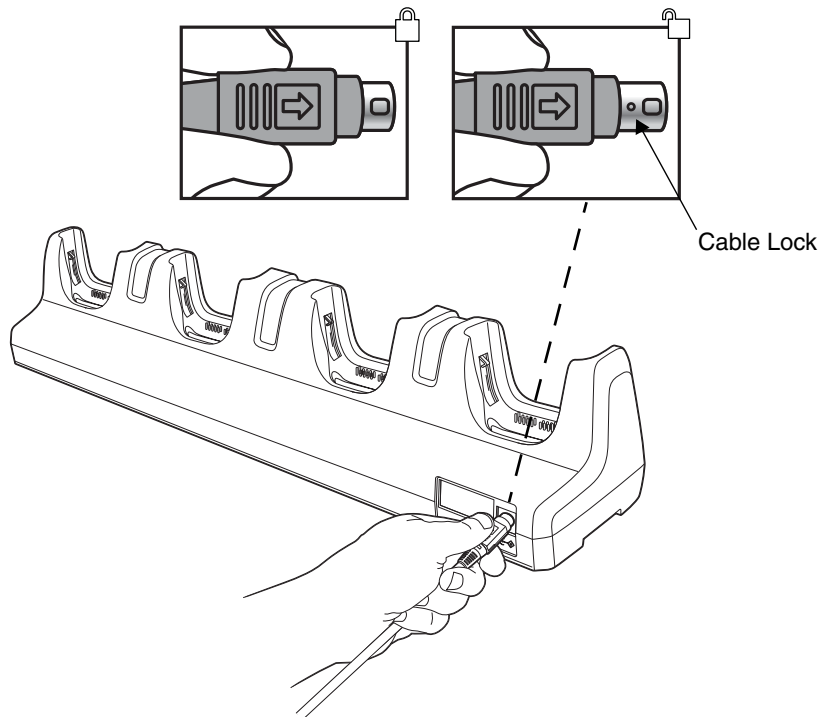

Do not pull on the power connector cable or strain relief.

2. Remove the cable from the power jack.

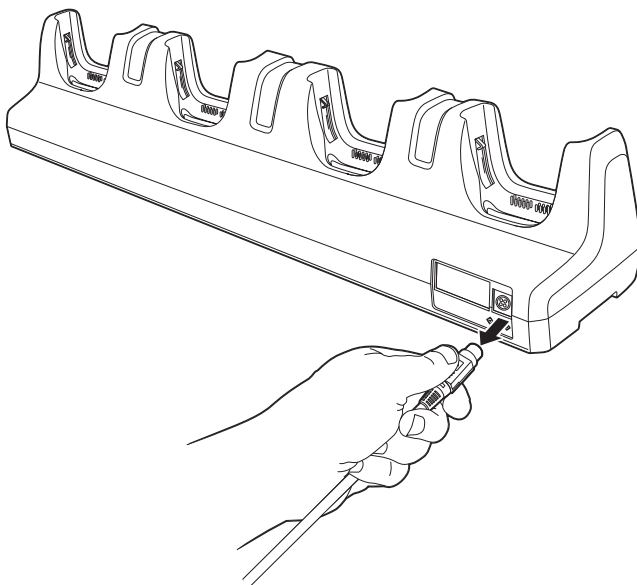



Dolphin 99EX Net Base Device (Model 99EX-NB)

Overview

The Net Base enables up to four Dolphin 99EX mobile computers to communicate with a host device over an Ethernet network. In addition, the Net Base provides a second RJ45 Ethernet port for connection to an additional device such as a printer, workstation, eBase, or another Net Base.

The 99EX-NB charger is designed for use with all 99EX model terminals using battery pack model 99EX-BTSC (standard Li-poly 3.7 V, 11.3 watt hour) or 99EX-BTEC (extended Li-ion 3.7 V, 18.5 watt hour) manufactured for Honeywell International Inc.

Note: Dolphin 99EX models intended for use in potentially explosive atmospheres are only approved to use battery pack model 99EX-BTEC (PN 99EX-BTEC-2) or 99EX-BTSC (PN 99EX-BTSC-2). See [Equipment Intended for Use in Potentially Explosive Atmospheres](#), starting on page 2-1 for additional information.



Warning! The Net Base is not designed for use in hazardous locations.



We recommend use of Honeywell peripherals, power cables, and power adapters. Use of any non-Honeywell peripherals, cables, or power adapters may cause damage not covered by the warranty.

Unpacking the Net Base

Open the shipping box and inspect the package to see that the following standard items are included:

- One Dolphin Net Base Ethernet cradle, model 99EX-NB
- One power supply (see [Power](#) on page 16-4)
- One power cord

You will also need to provide a standard CAT-5 Ethernet network cable. These items are needed to set up and operate the Net Base. If any items are missing or anything appears to be damaged, contact your Customer Account Representative.

Keep the original packaging in case you need to return the Net Base for service or to store the Net Base while not in use.

Charge Time

The base supplies power to the intelligent battery charging system in all Dolphin terminals, which senses when a full charge has been achieved and switches to a trickle charge to maintain the full charge.

As battery packs charge, the charging circuitry follows the two-step charging process (CC-CV) that is recommended for Li-ion batteries. The process monitors changes in temperature, current, and voltage. The main battery of each terminal charges in 4 hours for the standard 3.7V battery or 6 hours for the extended 3.7V battery.



Before you attempt to use, charge, or change the battery in the terminal carefully read all the information under [Equipment Intended for Use in Potentially Explosive Atmospheres](#), starting on page 2-1 and the [Guidelines for Battery Pack Use and Disposal](#) on page 3-13.

Convenient Storage

Intelligent battery charging makes this base a safe and convenient storage receptacle for your Dolphin terminal.

Capacity

The base can hold up to 4 Dolphin terminals. Each charging well charges each terminal independently of the other wells.

Parts and Functions

Front Panel

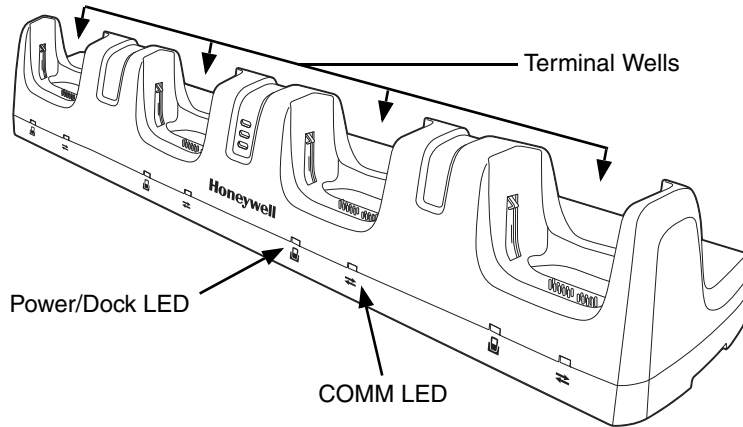

Terminal Wells

The Net Base contains four terminal wells. Each well has its own dedicated Power/Dock LED and COMM LED indicator.

Place the Dolphin terminal in any one of the four wells to communicate with a host device, power the terminal, and charge the installed battery pack. The Net Base completely charges the main battery in a Dolphin terminal in 4 hours for the standard 3.7V battery or 6 hours for the extended 3.7V battery.

Power/DOCK LED

Indicates if power is supplied to the Net Base and if a terminal is docked properly in the terminal well. Each terminal well has its own dedicated Dock LED.

This color	means...
-------------------	-----------------

Red	The Net Base has power but no terminal is docked.
-----	---

Green	The Net Base has power and the terminal is properly seated in the base.
-------	---

COMM LED ⇄

The COMM LED indicates the status of connection and data transfer between the Dolphin terminal and the Net Base. Each terminal well has its own dedicated COMM LED.

When the Dolphin terminal is docked:

This color	and status	means...
Green	Solid	A connection has been established between the Dolphin terminal and the Net Base.
Green	Flashing	Data transfer in progress.

Note: The COMM LED does not necessarily indicate the Net Base and terminal are connected to a valid Ethernet link. For more information, see [RJ45 Ethernet Ports](#) on page 16-3.

Back Panel

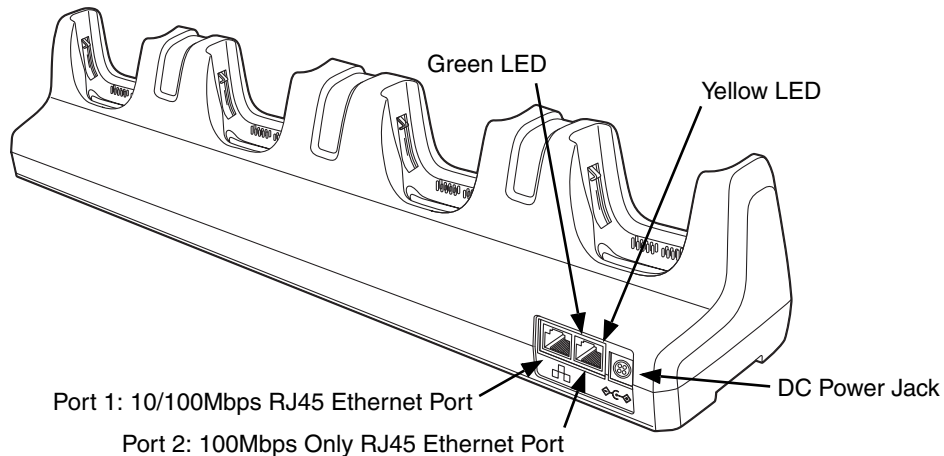

DC Power Jack

Use the power cable from Honeywell that comes with the Net Base to supply power to this power jack. For more information, see [Power](#) on page 16-4.

RJ45 Ethernet Ports

The Net Base contains two RJ45 Ethernet ports. You can connect the Net Base to an Ethernet-compliant device to facilitate Ethernet communication to and from the terminal by plugging a standard CAT-5 Ethernet cable into one of the two Ethernet ports provided. The second RJ45 Ethernet port can be used for connection to an additional device such as a printer, workstation, eBase, or another Net Base.

Note: The Net Base does not use a Spanning Tree Protocol (STP). When both RJ45 Ethernet ports are used, do not connect both Net Base interfaces to the same layer 2 LAN.

Note: Ethernet Port 2 only supports 100Mbps Ethernet connections. Plugging in a 10Mbps connection into Port 2 may cause other ports to stop working. For 10Mbps connections use Ethernet Port 1.

Each Ethernet port has a dedicated green and yellow status LED.

This color	and status	means...
Green	Flashing	Data transfer is in progress.
	Solid	A connection has been established between the Net Base and the Ethernet.
Yellow	Solid	Ethernet is connected at 100T.
	Off	Ethernet is connected at 10T.

Note: The terminal and Ethernet link must be set up properly to allow the terminal to communicate to other devices and/or the Internet. For more information, see [Connecting the Dolphin Terminal to the Net Base](#) on page 16-6.

Bottom Panel

For details on how to mount the Net Base, see [Mounting the Net Base](#) on page 16-7.

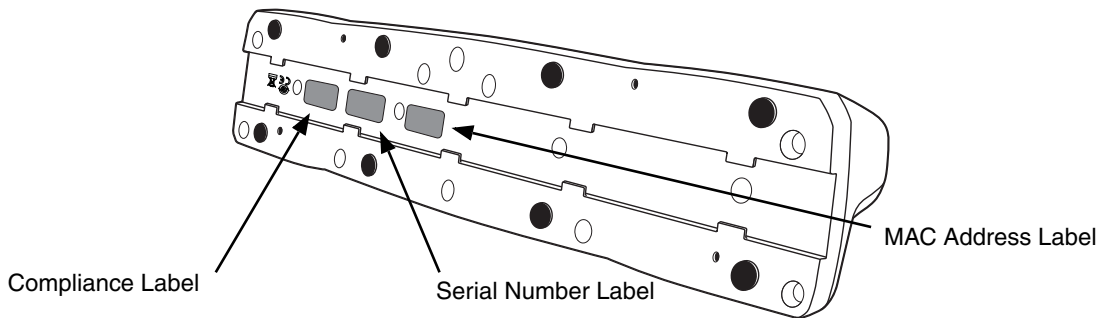

Power

The terminal requires 12 Volts DC input for communications and battery charging; the power adapter on the power cable converts the voltage from the power source to 12 volts DC. Use only a UL Listed power supply, which has been qualified by Honeywell with output rated at 12VDC and 8.5 amps with the device. The operating temperature range is -10° to 50°C (14° to 122°F).

Honeywell recommends that you leave the Net Base connected to its power source at all times, so that it is always ready to use. For more information on how to remove the power cable, see [Removing Power to the Net Base](#) on page 16-13.



We recommend use of Honeywell peripherals, power cables, and power adapters. Use of any non-Honeywell peripherals, cables, or power adapters may cause damage not covered by the warranty.

Connecting Power to the Net Base

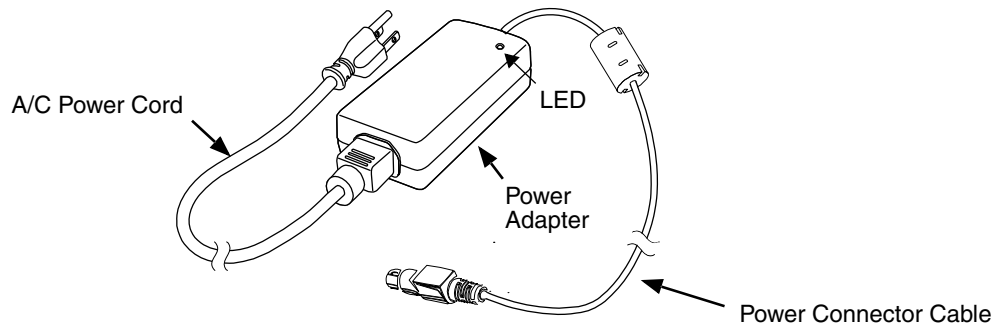

1. Plug the A/C power cord into the power adapter.
2. Plug the power connector cable into the power connector on the back of the Net Base.
3. Plug the A/C power cord into a standard wall outlet. The LED on the Power Adapter illuminates to indicate power.
4. All four Power/Dock LEDs illuminate solid red to indicate the base has power. Terminal wells with properly docked Dolphins indicate power with a green LED.
5. The base is ready to begin charging terminals.

Charging the Main Battery

 Before you attempt to use, charge, or change the battery in the terminal carefully read all the information under [Equipment Intended for Use in Potentially Explosive Atmospheres](#), starting on page 2-1 and the [Guidelines for Battery Pack Use and Disposal](#) on page 3-13.

The base provides power to the Dolphin terminals and allows the charging of the main batteries in the terminals. The main battery of each terminal charges in 4 hours for the standard 3.7V battery or 6 hours for the extended 3.7V battery. The intelligent battery charging system incorporated into all Dolphin terminals prevents overcharging, which means that Dolphin terminals may be stored in the base indefinitely without damage to the terminals, battery packs, or the base.

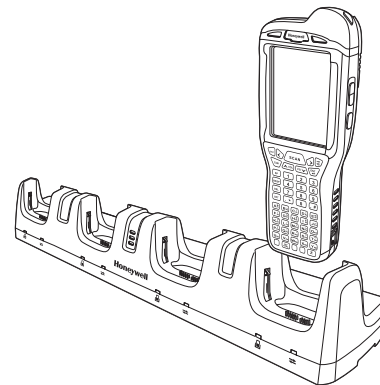

To Power a Terminal and Charge its Main Battery

1. Install the main battery pack in the terminal; see [Install the Main Battery Pack](#) on page 2-3.
2. Verify the base has power. If the Power/Dock LEDs are not illuminated, see [Connecting Power to the Net Base](#) on page 16-5.
3. Slide the Dolphin terminal into one of the four terminal wells. The the Power/Dock LED for the well changes to green. Charging begins immediately if required by the Dolphin terminal.

 Ensure all components are dry prior to mating terminals/batteries with peripheral devices. Mating wet components may cause damage not covered by the warranty.

 We recommend use of Honeywell Li-poly or Li-ion battery packs. Use of any non-Honeywell battery may result in damage not covered by the warranty.

Communication

Software Requirements

Before you connect the Dolphin terminal to the Net Base, make sure you have the most current software installed. To check the terminal's system information, tap  > **Power Tools** > **SysInfo**.



- The Kernel version must be 26.01 or later in terminals running Windows Embedded Handheld 6.5 Classic.
- In terminals running Windows Embedded Handheld 6.5 Professional, the kernel version must be 25.01 or later.

Applications on the Dolphin Terminal

Applications running on the Dolphin terminal when it is connected to the Net Base should be designed specifically for a partially connected network. For more details, please refer to the *Best Practices for Partially Connected Networks* document available at www.honeywellaidc.com.

Connecting the Dolphin Terminal to the Net Base

By default, the Dolphin terminal is configured to obtain IP addresses automatically using a DHCP server. This means that in most cases, you would simply plug-and-play the unit.

1. Verify the base has power. If the Power/Dock LEDs are not illuminated, see [Connecting Power to the Net Base](#) on page 16-5.
2. Plug the CAT-5 Ethernet cable into one of the RJ45 connectors on the back of the Net Base.
3. Plug the Ethernet cable into the network.
4. Insert the Dolphin into one of the terminal wells. The DOCK LED for the well changes from red to green and the connection icon on the Dolphin's title bar changes from  to .
5. By default, the DHCP server assigns a unique IP address to each of the Dolphin terminals docked in the Net Base. This IP address can be used by any application on the Dolphin terminal.

Note: Instead of using the default for DHCP assigned IP addresses, the Dolphin terminal can use a statically assigned IP address. See standard Microsoft Windows Mobile documentation for how to assign a static IP address to a network adapter. In this case, set a static IP address for the adapter named "SMC95001 USB2.0 FAST Ethernet Drive".

Displaying the Net Base Terminal Well and Dolphin IP Address

Once the Dolphin terminal establishes communication, it uses the unique IP address assigned to the terminal well it is docked in on the Net Base. If four Dolphin terminals are successfully connected, then four different IP addresses are assigned to the adapter associated with the Dolphin terminal.

1. Tap  > **Power Tools** > **Network Utilities** > **IPConfig**.
2. Change the **Adapter** to SMC95001.
3. On the Input tab, tap the **Display full configuration** button.
4. The Dolphin terminal retrieves and displays the IP configuration for the entire Dolphin terminal and the Net Base terminal well where the Dolphin is docked.

-
5. Locate the **IpAddress** field in the IP configuration list.

Mounting the Net Base

Set the Net Base on a dry, stable surface, such as a desktop or workbench near an electrical outlet. Be sure to provide enough workspace with good lighting for the user to view and operate the Dolphin terminal while it is in the Net Base. When choosing a location, bear in mind that the mounting location must allow users easy access to the terminal wells, the Ethernet ports, and the power jack.

Bottom Panel

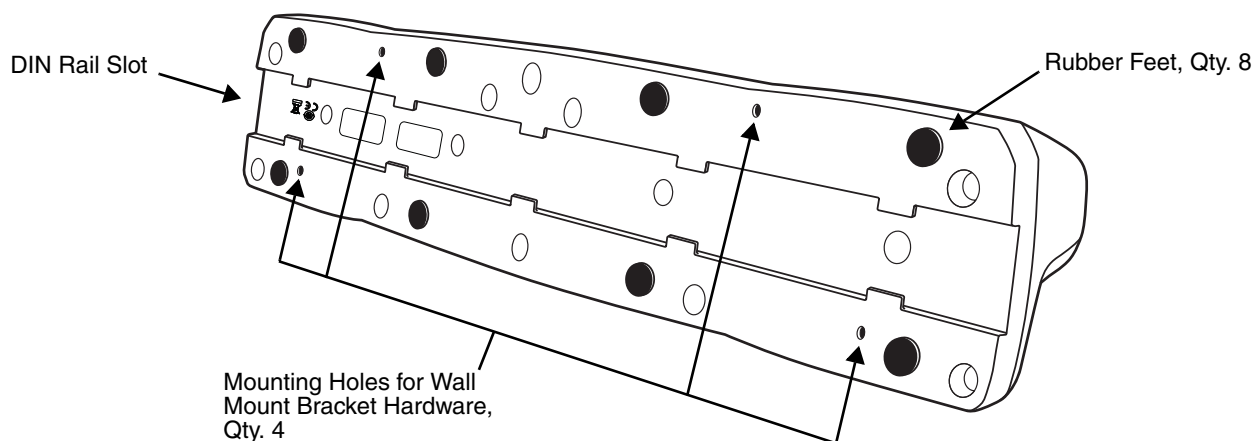

Desk Mounting

The DIN Rail (7.5 X 35 mm) slot on the bottom panel enables secure mounting on a horizontal surface.

Hardware Required

- 3/16 in. dia x 5/8 in. long pan head screw
- 1/2 in. OD x 7/32 in. ID x 3/64 in. thick flat washer
- 3/16 in. dia nut

Installing the DIN Rail

1. Slide the DIN Rail into the DIN Rail slot on the bottom panel of the base.

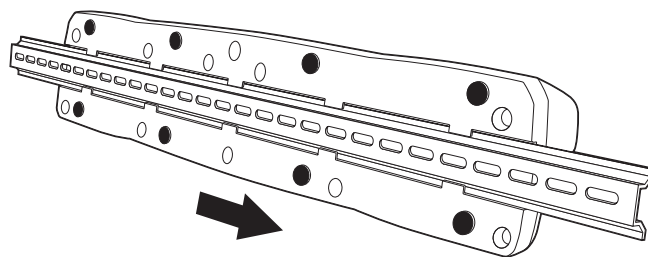

2. Turn the base and DIN Rail right side up.

- Then, using the appropriate hardware, secure the DIN Rail to a stable, flat horizontal surface.

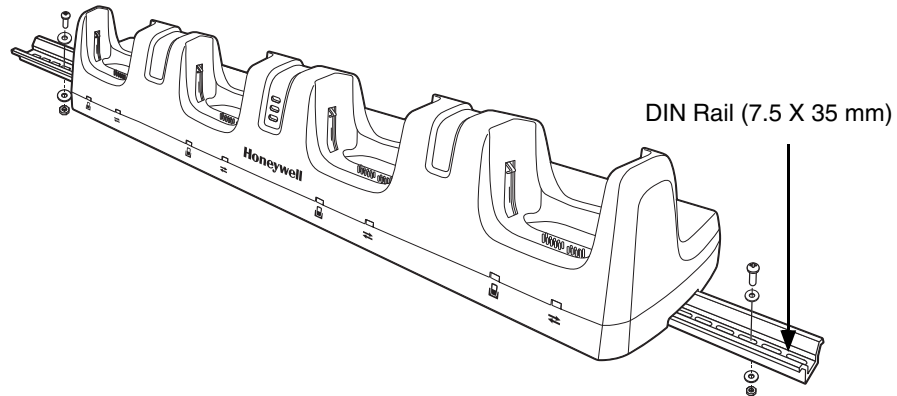

Wall Mounting

The optional wall mount bracket enables secure mounting of the base on a vertical surface. The wall mount bracket can be used in conjunction with the DIN rail but does not require the DIN Rail for use.

Hardware (Provided)

- M3 x 9 mm self-tapping screws, #2 Phillips, Qty. 4
- 3/8 in. x 4 in. round head toggle bolt, 2-5/8 in. usable length, Qty. 4
- 3/8 in. x 2 1/2 in. length Hex Head Lag Screw, Qty. 4

Tools Required

- Drill
- 7/8 in. Drill Bit (for hollow wall installations) or 1/4 in. Drill Bit (for wood stud installation)
- Phillips Screw Driver

Hollow Wall Installation

- Drill four pilot holes in the wall using a 7/8 in. drill bit.

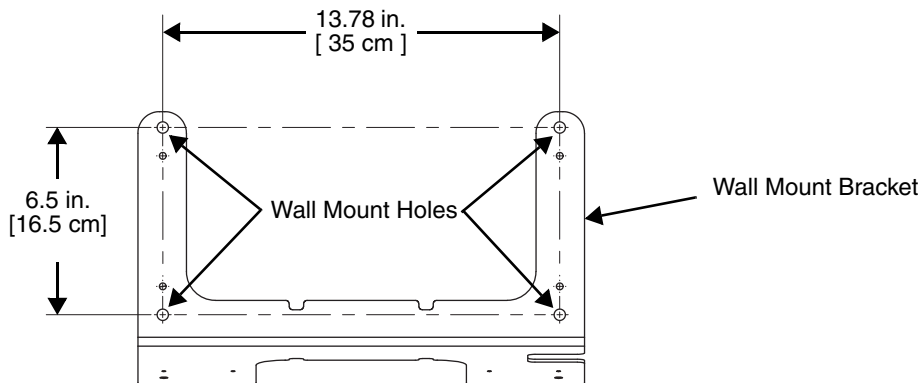

2. Slide the bolt through the wall bracket, and thread the toggle nut onto the bolt.
3. Press the ends of the toggle nut together, and insert the bolt/nut into the pilot hole until the nut clears inside wall surface. The toggle nut should spring open preventing the screw from being removed.
4. Repeat steps 2 and 3 for each of the remaining mounting holes.
5. Tighten all four bolts to secure the bracket to the wall.
6. Once the bracket is installed, secure the base to the wall bracket, see [Securing the Base to the Wall Bracket](#) for detailed instructions.

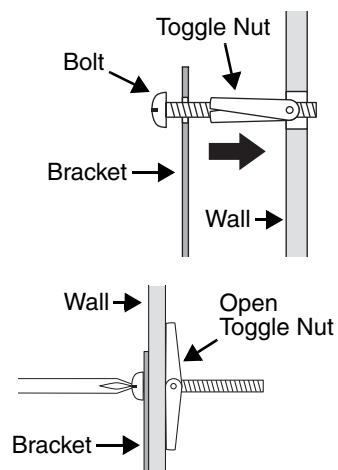

Wood Stud Installation

1. Drill four pilot holes in the wall/wood stud using the 1/4 in. drill bit.
2. Secure the bracket to the wall using the four Hex Head Lag Screws provided.
3. Once the bracket is installed, secure the base to the wall bracket, [Securing the Base to the Wall Bracket](#) for detailed instructions.

Securing the Base to the Wall Bracket

You can secure the base to the wall bracket by using the self tapping screws provided or you can use the optional DIN Rail.

To secure the base using the self tapping screws:

1. Position the base on the wall bracket, as shown.
2. Secure the base to the bracket using the four M3 x 9 mm self-tapping screws provided.

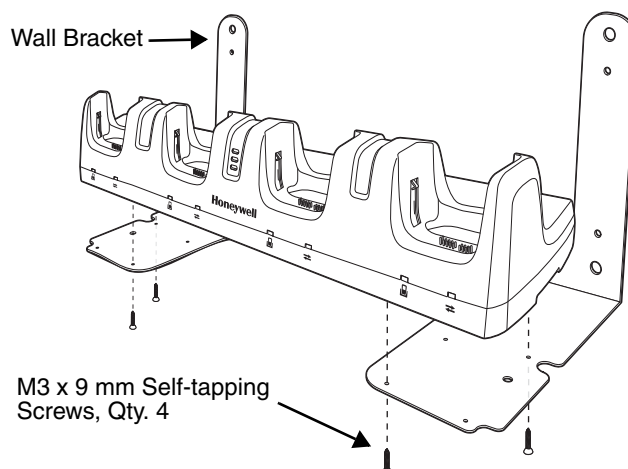

To secure the base using the optional DIN Rail:

Hardware Required

- DIN Rail, Qty. 1
- 3/16 in. dia x 5/8 in. long pan head screw, Qty. 2
- 1/2 in. OD x 7/32 in. ID x 3/64 in. thick washer, Qty. 2
- 3/16 in. dia nut, Qty. 2

1. Position the DIN Rail on the wall bracket, as shown below.
2. Slide the screw through the slot on the DIN Rail and the mounting hole in the bracket.
3. Slide the washer onto the screw and tighten the nut to secure the assembly.

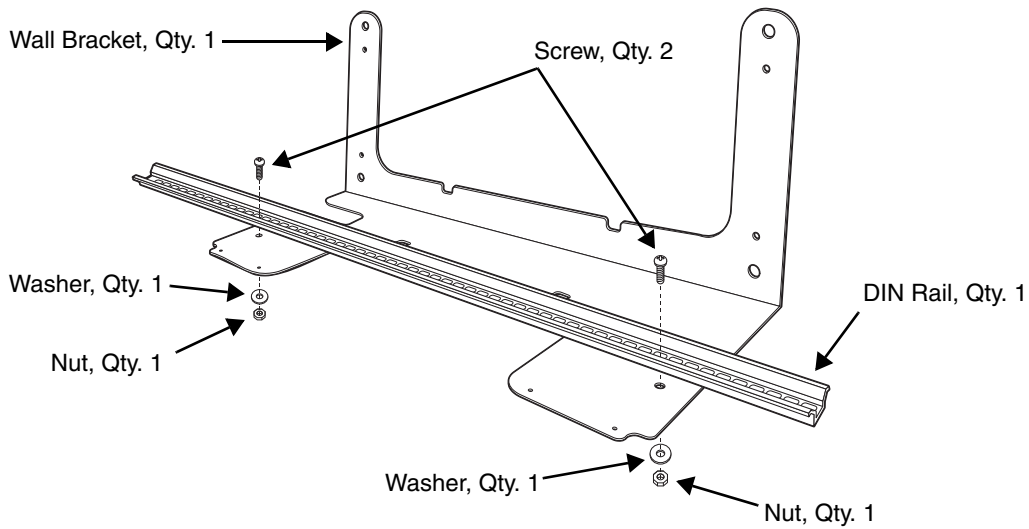

4. Remove the rubber feet on the bottom of the Net Base.
5. Slide the base onto the DIN Rail using the slot on the bottom of the base.

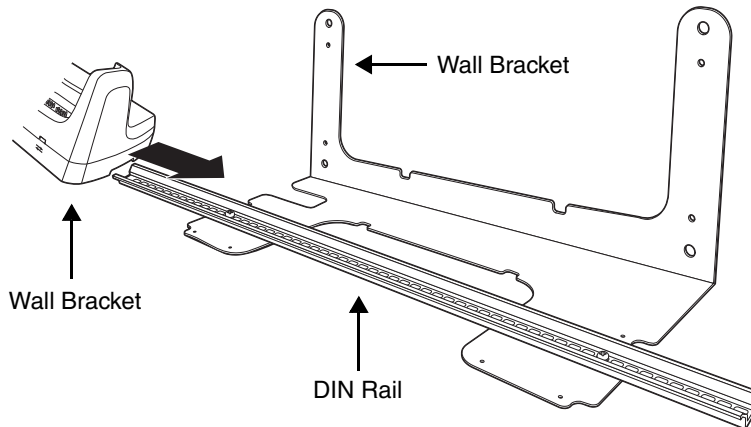

Channel Bracket Installation (Pre-existing Hardware Installations)

When choosing a location and installing the optional channel bracket:

- Do not exceed 150 lbs. maximum load on the channel bracket.
- Leave a minimum of 16 in. (40.64 cm) of horizontal space between the hardware used to attach the channel bracket to the wall.
- An electrical outlet must be easily accessible.
- The mounting location should be dry, stable, easily accessible, and well lighted.

Tools Required

- Drill
- 7/8 in. Drill Bit (for hollow wall installations) or 1/4 in. Drill Bit (for wood stud installations)
- #2 Phillips Screw Driver
- Medium Flat Head Screw Driver
- 9/16 in. Socket Wrench

Hardware Required

- 3/8 in.-16 spring nut, for 13/16 in. deep strut, Qty. 4 per wall bracket
- 3/8 in. flat washer, Qty. 4 per wall bracket
- 3/8 in.-16 x 1.00 in., cap screw, grade 5, Qty. 4 per wall bracket
- *Hollow Wall Installations:*
 - 3/8 in. x 4 in. round head toggle bolt, 2-5/8 in. usable length, Qty. 4
 - 3/8 in. flat washer, Qty. 4
- *Wood Stud Installations:*
 - 3/8 in. x 2 1/2 in. length hex head lag screw, Qty. 4
 - 3/8 in. fat washer, Qty. 4

Installation

1. Slide the spring nuts into the channel of the bracket and position them to line up with the mounting holes on the wall bracket.

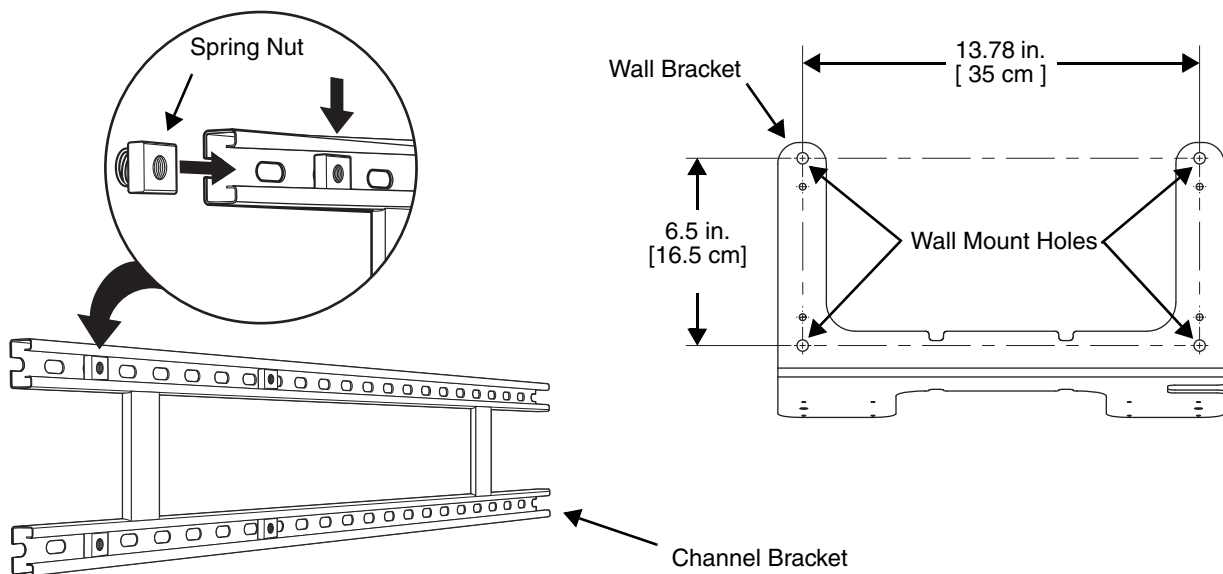

-
2. Attach the channel bracket to a dry, stable surface using the hardware listed on page [16-11](#) for the appropriate mounting surface.

Mounting into Wood Stud

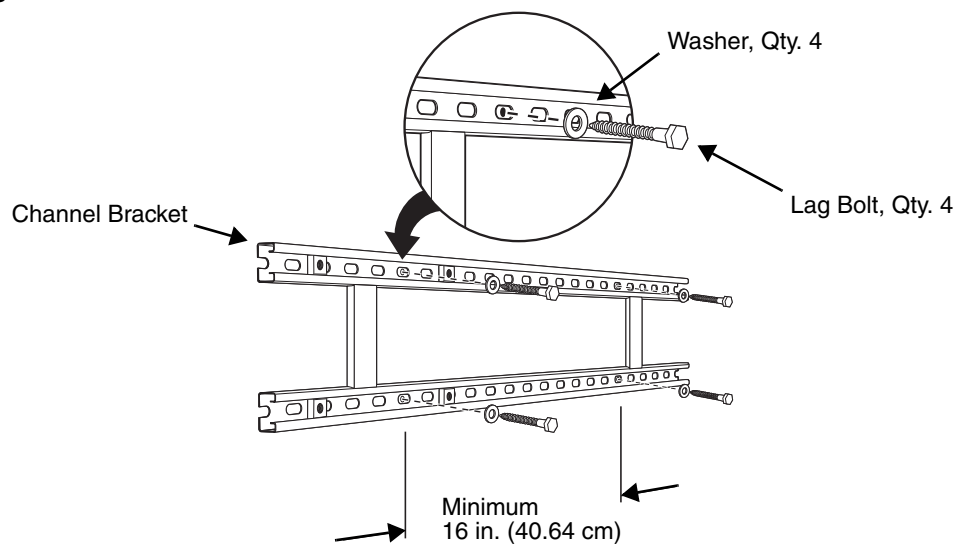

Mounting into Hollow Surface

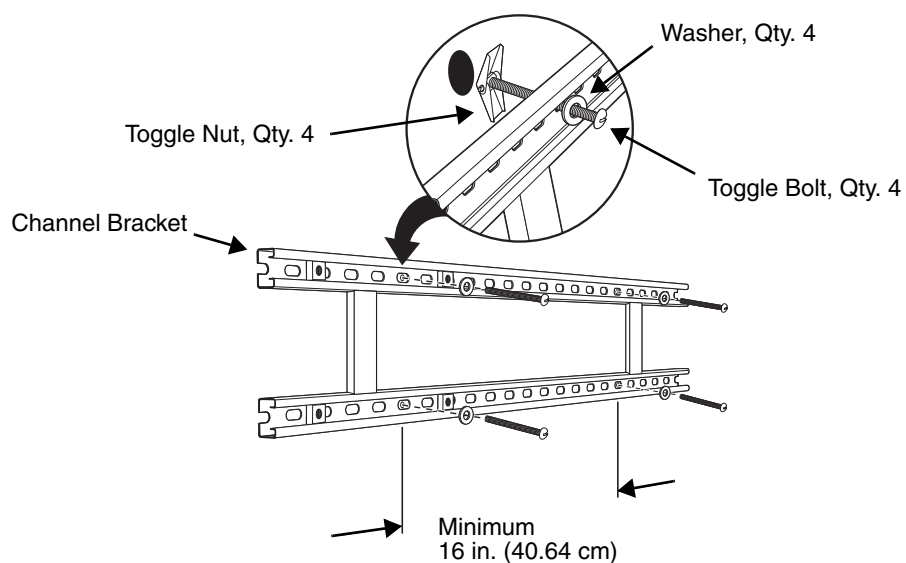

3. Align the mounting holes on the wall bracket with the spring nuts installed in the channel bracket. Secure the wall bracket in place using the cap screws listed on page [16-11](#).
4. See [Securing the Base to the Wall Bracket](#) (page 16-9) for detailed instructions on securing the Net Base to the wall bracket.

Removing Power to the Net Base

 Attempting to remove the cable without disengaging the lock may result in damage to the base and power cable not covered by the warranty.

1. Gently slide back the outer shell of the connector to disengage cable lock.

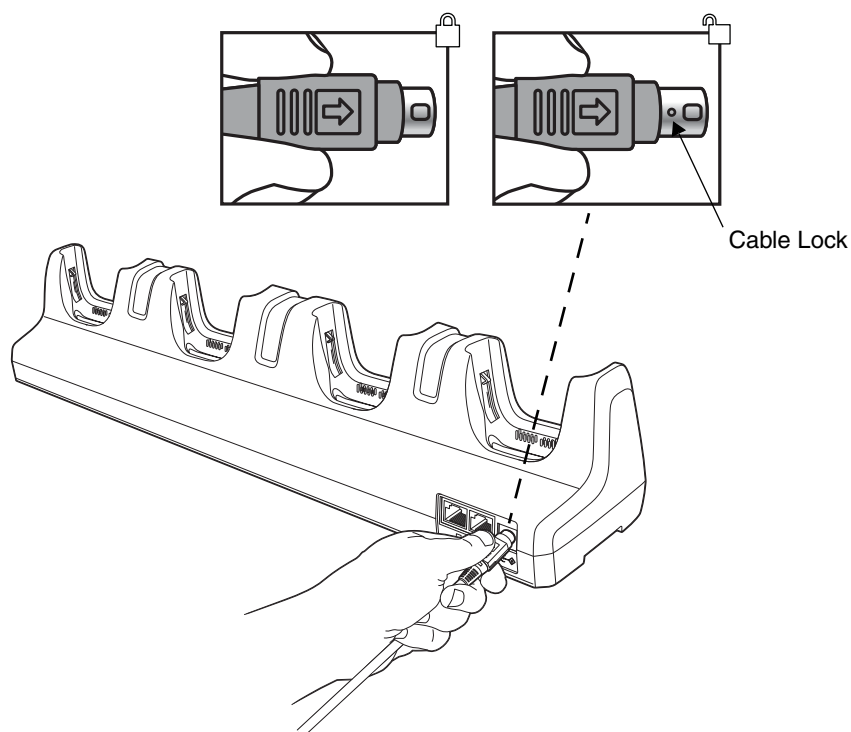

Do not pull on the power connector cable or strain relief.

2. Remove the cable from the power jack.

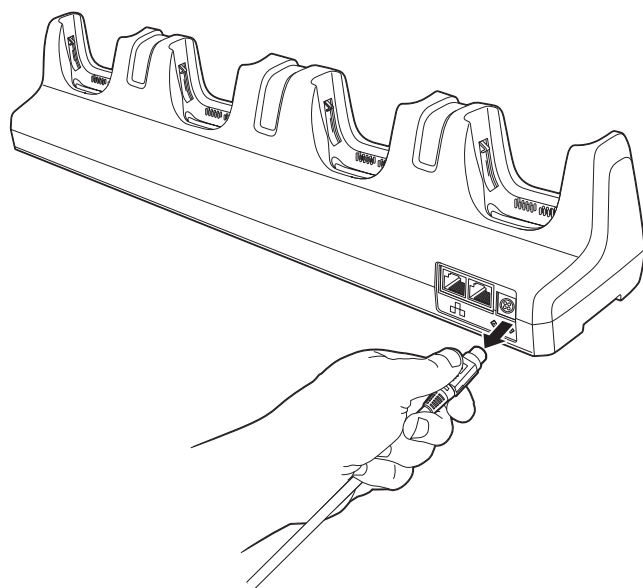



Dolphin 99EX QuadCharger Device (Model 99EX-QC)

Overview

This 4-slot charging station provides intelligent battery management for the rechargeable battery packs used in Dolphin terminals.

The 99EX-QC charger is designed for use with battery pack models 99EX-BTSC (standard Li-poly 3.7 V, 11.3 watt hour) and 99EX-BTEC (extended Li-ion 3.7 V, 18.5 watt hour) manufactured for Honeywell International Inc.

Note: Dolphin 99EX models intended for use in potentially explosive atmospheres are only approved to use battery pack model 99EX-BTEC (PN 99EX-BTEC-2) or 99EX-BTSC (PN 99EX-BTSC-2). See [Equipment Intended for Use in Potentially Explosive Atmospheres](#), starting on page 2-1 for additional information.



Warning! The QuadCharger is not designed for use in hazardous locations.

Unpacking the QuadCharger

Open the shipping box and inspect the package to see that the following standard items are included:

- One Dolphin QuadCharger, model 99EX-QC
- One power supply (see Supplying Power on page 17-3)
- One power cord

If any items are missing or anything appears to be damaged, contact your Customer Account Representative. Keep the original packaging in case you need to return the QuadCharger for service or to store the QuadCharger while not in use.

Capacity

The charger holds 4 Honeywell 3.7V Li-ion batteries.

Charging Time

Charge time is 4 hours for the standard 3.7V battery or 6 hours for the extended 3.7V battery.

Charging Process

Each charging slot works independently of the other three. As battery packs charge, the charging circuitry follows the two-step charging process (CC-CV) that is recommended for Li-ion batteries. The process monitors changes in temperature, current, and voltage and resets the battery pack.



We recommend use of Honeywell Li-poly or Li-ion battery packs. Use of any non-Honeywell battery may result in damage not covered by the warranty.



We recommend use of Honeywell peripherals, power cables, and power adapters. Use of any non-Honeywell peripherals, cables, or power adapters may cause damage not covered by the warranty.

Parts and Functions

Top Panel

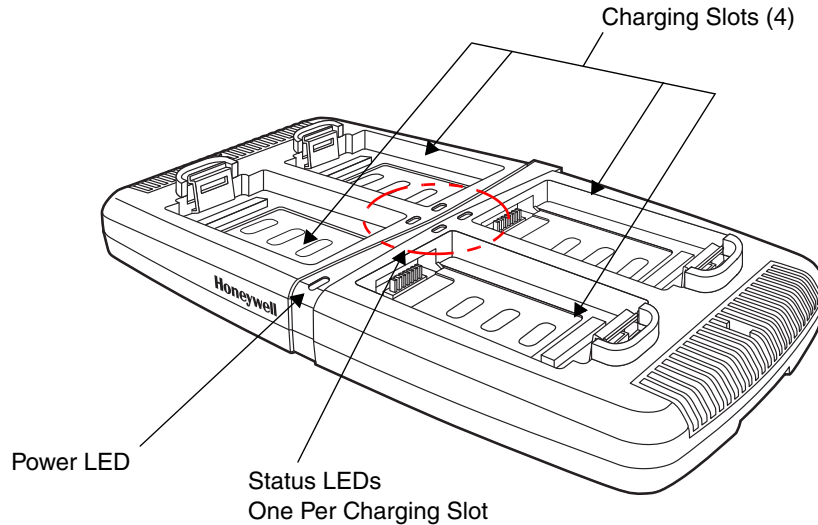

Charging Slots

There are 4 charging slots. Each slot holds one Li-ion battery and charges it independently of the other slots. When a battery is placed in each slot, it immediately begins charging.

Power LED

The power LED indicates if the QuadCharger is powered and operational. When the QuadCharger is receiving power, the LED illuminates green.

Power Supply Connector

You attach the power supply to this connector. See [Supplying Power](#) on page 17-3.

Status LEDs

A status LED is located at one corner of each of the 4 battery slots. The color of the LED indicates the charge status of the batteries in its slot.

Color	This color indicates that the battery in the slot...
Green (Solid)	Has completed its charge cycle and is ready for use.
Orange (Solid)	Is being charged at a maximum charge rate.
Red (Flashing)	The internal temperature of the auxiliary battery is too hot or there is a battery error. Charge the auxiliary battery in a cooler environment or replace the battery with a new Honeywell battery.

For more information, see [Troubleshooting](#) on page 17-5.

Supplying Power

The charger must be connected to a power source via the Honeywell power adapter cable so that voltage is adjusted appropriately. Use only a UL Listed power supply, which has been qualified by Honeywell with output rated at 12VDC and 3 amps with the device.

1. Locate the AC power adapter cable and plug it into the power source.
2. Connect the power cable to the power adapter.
3. Connect the power cable to the supply connector on the back of the charger.

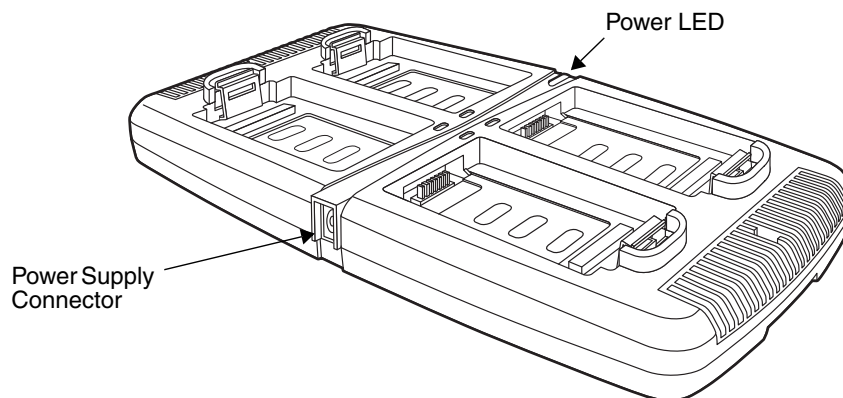

4. The power LED illuminates green, and the charger performs a self-diagnostic test that lasts approximately five seconds.

Recommendations for Storing Batteries

To maintain top performance from batteries, avoid storing batteries outside of the following temperature ranges:

- 14°F to 113°F (-10°C to +45°C) for short term storage of less than one month
- 32°F to 86°F (-0°C to +30°C) for long term storage

Do not store batteries in extremely high humidity. For prolonged storage, do not keep batteries stored in a charger that is connected to a power source.

Inserting and Charging Batteries

For best results, battery packs should be at room temperature before recharging them; temperature has a marked effect on charging. The recommended temperature range is 50°F to 95° F (10°C to 35° C).

1. Set up the charger, see [Supplying Power](#) above.
2. Power the charger. The Power LED illuminates green.
3. Insert the battery at an angle so the battery pack contacts and the QuadCharger contacts align.
4. Snap the battery into place with a hinging motion.
5. The Status LED for that particular slot illuminates orange to indicate the battery is seated properly and the charging cycle has begun.
6. When the Status LED turns green, the battery in the slot has completed charging.

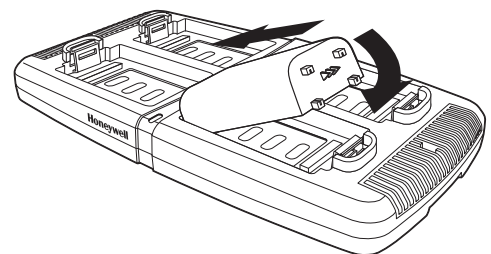

Mounting the QuadCharger

The charger should be on a dry, stable surface and can be mounted on a flat, horizontal surface such as a desktop or workbench. When choosing a location, always bear in mind that:

- the mounting location must allow users easy access to the power connector.
- the charger should be oriented so that users can easily insert and remove battery packs and see the LEDs.

Bottom Panel

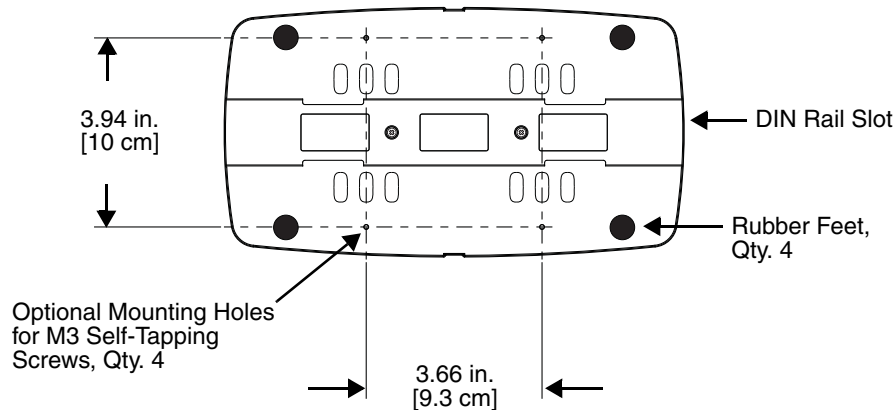

Desk Mounting

The DIN rail slot on the bottom panel enables secure mounting to a horizontal surface.

Hardware Required

- 3/16 in. dia x 5/8 in. long pan head screw
- 1/2 in. OD x 7/32 in. ID x 3/64 in. thick flat washer
- 3/16 in. dia nut

Installing the DIN Rail

1. Slide the DIN rail into the DIN rail slot (7.5 X 35 mm) on the bottom of the QuadCharger.
2. Then, using the appropriate hardware listed above, secure the DIN rail to the desktop.

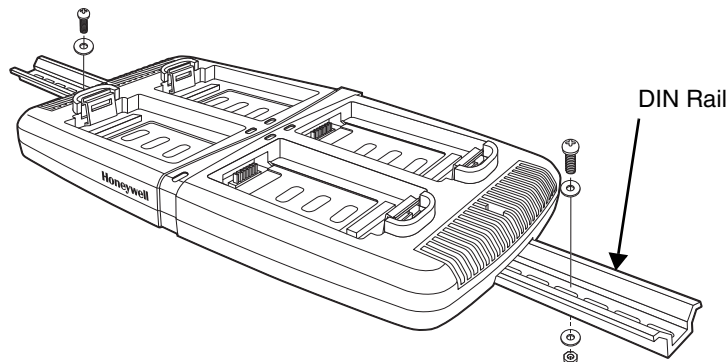

Troubleshooting

If you encounter problems with your QuadCharger device, refer to chart below for possible solutions. If problems persist, please contact Honeywell Technical Support.

Problem	Issue
The Status LED does not come on when I insert a battery pack.	Check the power connections; make sure the Power cable is inserted into the Power supply connector and the battery pack is properly seated.
The Status LED lights red during charging.	Try to charge the battery in one of the other charging slots. If the red Status LED comes on again, then the problem is associated with the battery pack. If the red status stays with the charging slot, the problem is associated with the charging circuitry.
The Status LED flashes red without a battery in the charging slot.	If a battery is in failure mode (flashing red LED), and that battery is removed from the charging slot, the slot does not reset and will continue to flash red. To reset the slot and stop the flashing red LED, insert a known good battery into the slot or recycle the power to the QuadCharger.



Product Service and Repair

Honeywell International Inc. provides service for all of its products through service centers throughout the world. To obtain warranty or non-warranty service, please visit www.honeywellaidc.com, and select **Support > Contact Service and Repair** to see your region's instructions on how to obtain a Return Material Authorization number (RMA #). You should do this prior to returning the product.

For ongoing and future product quality improvement initiatives, the 99EX comes equipped with an embedded device lifetime counter function. Honeywell may use lifetime counter data for future statistical reliability analysis as well as ongoing quality, repair and service purposes.

Technical Assistance

If you need assistance installing or troubleshooting your device, please contact us by using one of the methods below:

Knowledge Base: www.hsmknowledgebase.com

Our Knowledge Base provides thousands of immediate solutions. If the Knowledge Base cannot help, our Technical Support Portal (see below) provides an easy way to report your problem or ask your question.

Technical Support Portal: www.hsmsupportportal.com

The Technical Support Portal not only allows you to report your problem, but it also provides immediate solutions to your technical issues by searching our Knowledge Base. With the Portal, you can submit and track your questions online and send and receive attachments.

Web form: www.hsmcontactsupport.com

You can contact our technical support team directly by filling out our online support form. Enter your contact details and the description of the question/problem.

Telephone: www.honeywellaidc.com/locations

For our latest contact information, please check our website at the link above.

Limited Warranty

Honeywell International Inc. ("HII") warrants its products and optional accessories to be free from defects in materials and workmanship and to conform to HII's published specifications applicable to the products purchased at the time of shipment. This warranty does not cover any HII product which is (i) improperly installed or used; (ii) damaged by accident or negligence, including failure to follow the proper maintenance, service, and cleaning schedule; or (iii) damaged as a result of (A) modification or alteration by the purchaser or other party, (B) excessive voltage or current supplied to or drawn from the interface connections, (C) static electricity or electro-static discharge, (D) operation under conditions beyond the specified operating parameters, or (E) repair or service of the product by anyone other than HII or its authorized representatives.

This warranty shall extend from the time of shipment for the duration published by HII for the product at the time of purchase ("Warranty Period"). Any defective product must be returned (at purchaser's expense) during the Warranty Period to HII factory or authorized service center for inspection. No product will be accepted by HII without a Return Materials Authorization, which may be obtained by contacting

HII. In the event that the product is returned to HII or its authorized service center within the Warranty Period and HII determines to its satisfaction that the product is defective due to defects in materials or workmanship, HII, at its sole option, will either repair or replace the product without charge, except for return shipping to HII.

EXCEPT AS MAY BE OTHERWISE PROVIDED BY APPLICABLE LAW, THE FOREGOING WARRANTY IS IN LIEU OF ALL OTHER COVENANTS OR WARRANTIES, EITHER EXPRESSED OR IMPLIED, ORAL OR WRITTEN, INCLUDING, WITHOUT LIMITATION, ANY IMPLIED WARRANTIES OF MERCHANTABILITY OR FITNESS FOR A PARTICULAR PURPOSE, OR NON-INFRINGEMENT.

HII'S RESPONSIBILITY AND PURCHASER'S EXCLUSIVE REMEDY UNDER THIS WARRANTY IS LIMITED TO THE REPAIR OR REPLACEMENT OF THE DEFECTIVE PRODUCT WITH NEW OR REFURBISHED PARTS. IN NO EVENT SHALL HII BE LIABLE FOR INDIRECT, INCIDENTAL, OR CONSEQUENTIAL DAMAGES, AND, IN NO EVENT, SHALL ANY LIABILITY OF HII ARISING IN CONNECTION WITH ANY PRODUCT SOLD HEREUNDER (WHETHER SUCH LIABILITY ARISES FROM A CLAIM BASED ON CONTRACT, WARRANTY, TORT, OR OTHERWISE) EXCEED THE ACTUAL AMOUNT PAID TO HII FOR THE PRODUCT. THESE LIMITATIONS ON LIABILITY SHALL REMAIN IN FULL FORCE AND EFFECT EVEN WHEN HII MAY HAVE BEEN ADVISED OF THE POSSIBILITY OF SUCH INJURIES, LOSSES, OR DAMAGES. SOME STATES, PROVINCES, OR COUNTRIES DO NOT ALLOW THE EXCLUSION OR LIMITATIONS OF INCIDENTAL OR CONSEQUENTIAL DAMAGES, SO THE ABOVE LIMITATION OR EXCLUSION MAY NOT APPLY TO YOU.

All provisions of this Limited Warranty are separate and severable, which means that if any provision is held invalid and unenforceable, such determination shall not affect the validity of enforceability of the other provisions hereof. Use of any peripherals not provided by the manufacturer may result in damage not covered by this warranty. This includes but is not limited to: cables, power supplies, cradles, and docking stations. HII extends these warranties only to the first end-users of the products. These warranties are non-transferable.

The limited duration of the warranty for the Dolphin 99EX is as follows:

- The duration of the limited warranty for terminals with an integrated imager is one year.
- The duration of the limited warranty for touch screens is one year.
- The duration of the limited warranty for the Dolphin 99EX HomeBase device, Dolphin 99EX eBase device, Dolphin 99EX Net Base device, Dolphin 99EX QuadCharger device, Dolphin 99EX Mobile Base, and Dolphin 99EX ChargeBase device, is one year.
- The duration of the limited warranty for batteries is one year. Use of any battery from a source other than Honeywell may result in damage not covered by the warranty. Batteries returned to Honeywell International Inc. in a reduced state may or not be replaced under this warranty. Battery life will be greatly increased when following the battery instructions in this user's guide.

How to Extend Your Warranty

Honeywell International Inc. offers a variety of service plans on our hardware products. These agreements offer continued coverage for your equipment after the initial warranty expires. For more information, contact your Sales Representative, Customer Account Representative, or Product Service Marketing Manager from Honeywell International Inc., or your Authorized Reseller.



Honeywell Scanning & Mobility

9680 Old Bailes Road

Fort Mill, SC 29707

www.honeywellaidc.com