

Panasonic®

Operating Instructions High Definition Video Camera

Model No.

HC-V785

HC-V787

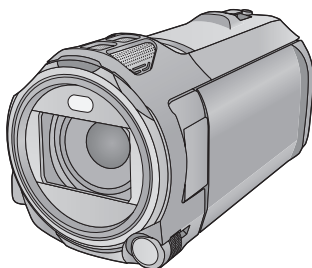

Please read these instructions carefully before using this product, and save this manual for future use.

AVCHD™
Progressive



Dolby Audio

HDMI™
HIGH-DEFINITION MULTIMEDIA INTERFACE

WiFi®
CERTIFIED



Web Site: <http://www.panasonic.com>

Read this first

■ About the recording format for recording motion pictures

You can select from AVCHD^{*1}, MP4 or iFrame recording formats to record motion pictures using this unit. (→ 71)

*1 It is compatible with the AVCHD Progressive (1080/50p).

AVCHD:

It is suitable for viewing on a high-definition TV or for saving to disc^{*2}.

*2 The following methods are available for saving an image recorded in 1080/50p:

- Copy the image to a disc using the HD Writer AE 5.2.
- Copy the image to a Panasonic Blu-ray disc recorder that supports AVCHD Progressive.

MP4:

This is a recording format suitable for playing back or editing on a PC.

- It is not compatible with motion pictures recorded in AVCHD format.

iFrame:

This is a recording format suitable for playing back or editing on a Mac (iMovie etc.).

- It is not compatible with motion pictures recorded in AVCHD format.

■ Indemnity about recorded content

Panasonic does not accept any responsibility for damages directly or indirectly due to any type of problems that result in loss of recording or edited content, and does not guarantee any content if recording or editing does not work properly. Likewise, the above also applies in a case where any type of repair is made to the unit.

■ About Condensation (When the lens or the LCD monitor is fogged up)

Condensation occurs when there is a change in temperature or humidity, such as when the unit is taken from outside or a cold room to a warm room. Please be careful, as it may cause the lens or LCD monitor to become soiled, moldy, or damaged.

When taking the unit to a place which has a different temperature, if the unit is accustomed to the room temperature of the destination for about one hour, condensation can be prevented. (When the difference in temperature is severe, place the unit in a plastic bag or the like, remove air from the bag, and seal the bag.)

When condensation has occurred, remove the battery and/or the AC adapter and leave the unit like that for about one hour. When the unit becomes accustomed to the surrounding temperature, fogging will disappear naturally.

■ Cards that you can use with this unit

SD Memory Card, SDHC Memory Card and SDXC Memory Card

- 4 GB or more Memory Cards that do not have the SDHC logo or 48 GB or more Memory Cards that do not have the SDXC logo are not based on SD Memory Card Specifications.
- Refer to page 15 for more details on SD cards.

■ Caution regarding the lens

Do not aim the lens at the sun or strong light. Doing so may cause the unit to malfunction.

■ For the purposes of these operating instructions

- SD Memory Card, SDHC Memory Card and SDXC Memory Card are referred to as the “SD card”.
- The smartphone and tablet are indicated as “smartphone”.
- Function that can be used for Motion Picture Recording Mode: 



Function that can be used for Still Picture Recording Mode: 



- Function that can be used for the Playback Mode: 

Function that can be used for the Playback Mode (motion pictures only): 

Function that can be used for the Playback Mode (still pictures only): 

- Scene(s) recorded in the recording format [AVCHD]: “AVCHD scene(s)”
- Scene(s) recorded in the recording format [MP4/iFrame], scene(s) saved in MP4 (1920×1080/25p), MP4 (1280×720/25p) or MP4 (640×360/25p): “MP4/iFrame scene(s)”
- Scene(s) recorded in the recording mode [iFrame]: “iFrame scene(s)”
- Scene(s) containing only the Main Camera’s image that was recorded separately from a simultaneously recorded normal scene when [Backup for Twin Camera] was set to [ON]: “Scene(s) recorded as Backup for Twin Camera”
- Pages for reference are indicated by an arrow, for example: → 00
- Model numbers are abbreviated as follows in these operating instructions:

Model number	Abbreviation used in these operating instructions
HC-V785	 [V785]
HC-V787	 [V787]

These operating instructions are designed for use with models  and .
Pictures may be slightly different from the original.

- Features may vary, so please read carefully.
- Not all models may be available depending on the region of purchase.

Contents

Read this first	2
-----------------------	---

Preparation

Names and Functions of Main Parts	8
Power supply	11
Inserting/removing the battery	11
Charging the battery	12
Charging and recording time	13
Recording to a card	15
Cards that you can use with this unit	15
Inserting/removing an SD card	16
Turning the unit on/off	17
Selecting a mode	18
Switching this unit between Recording Mode and Playback Mode	18
Switching this unit between Motion Picture Recording Mode and Still Picture Recording Mode	18
How to use the touch screen	19
About the Touch Menu	20
Setting date and time	21

Basic

Before recording	22
Recording motion pictures	23
Recording still pictures	25
Recording still pictures in Motion Picture Recording Mode	26
Motion picture/Still picture playback	27
Using the menu screen	30
Using the Setup Menu	31

Advanced (Recording)

Using the zoom	41
Zoom ratio during the Still Picture Recording Mode	41
Level Shot Function	42
Recording with the Backup for Twin Camera Function	43
Changing the Recording Mode	45
Intelligent Auto	46
Intelligent Auto Plus	48
Creative Control	48
HDR Movie Mode	51
Scene Mode	52
FULL HD Slow Motion Video	53
Stop Motion Animation Assist	55

Manual recording	56
White Balance	57
Manual shutter speed/iris adjustment	58
Manual Focus adjustment	59
Recording with the Touch Function	60
Touch function icons	60
Recording functions of operation icons	65
Operation icons	65
Recording functions of menus	70

Advanced (Playback)

Playback Operations	83
Motion picture playback using operation icon	83
Creating still picture from motion picture	85
Highlight & Time Frame Index	85
Repeat Playback	86
Resuming the previous playback	86
Setting the playback speed of FULL HD Slow Motion Video	87
Zooming in on a still picture during playback (Playback zoom)	87
Various playback functions	88
Playing back motion pictures/still pictures by date	88
Highlight Playback	90
Manual Edit	96
Baby Calendar	100
Changing the playback settings and playing back the slide show	102
Playing back still pictures recorded in Stop Motion Animation Assist Mode as a slide show	104
Deleting scenes/still pictures	105
Deleting part of a scene (AVCHD/Backup for Twin Camera)	107
Dividing a scene (AVCHD/Backup for Twin Camera)	108
Dividing a scene to partially delete (MP4/iFrame)	109
Protecting scenes/still pictures	110
Convert to MP4	111
Slow speed conversion	112
Watching Video/Pictures on your TV	113
Connecting with a HDMI micro cable	115
Listening in 5.1 channel sound (AVCHD)	115
Playback using VIERA Link	116

Copy/Dubbing

Copying/playing back with a USB HDD	118
Preparing for copying/playing back	118
Simple copy	121
Copy selected files	121
Playing back the USB HDD	122
Dubbing with a Blu-ray disc recorder, video device, etc.	123

Wi-Fi

Wi-Fi® function	127
What you can do with the Wi-Fi function	129
[Remote Ctrl]	130
Preparations before using [Remote Ctrl]	131
Using [Remote Ctrl] with a direct connection.....	132
Using [Remote Ctrl] with a wireless access point connection	132
About [Remote Ctrl]	133
[DLNA Play]	135
Preparations before using [DLNA Play].....	135
Playing back on a TV.....	136
[Copy]	137
Preparations before using [Copy].....	137
Copying to a PC	139
Install the “Image App”	141
Setting Up a Wi-Fi Connection	142
Using the [Wi-Fi Setup Wizard] to set up a connection	143
Connecting to a wireless access point	144
Setting up a direct connection to a smartphone	147
Connecting from the history.....	149
If the Wi-Fi connection cannot be established	150
How to Use the [Wi-Fi Setup] Menu	152

Wireless Twin Camera

Wireless Twin Camera function	156
Notes on the Wireless Twin Camera function.....	157
Using a Smartphone as a Wireless Sub Camera	158
When connecting a smartphone to this unit as a Wireless Sub Camera for the first time	158
When connecting for the second time or later	161
Terminating the connection.....	161
Recording with a Wireless Sub Camera (Wireless Twin Camera)	162
Screen display when using a Wireless Sub Camera.....	162
If the Wi-Fi connection cannot be established (Wireless Twin Camera)	166

With a PC

What you can do with a PC	167
Before Installing HD Writer AE 5.2	169
Operating environment	171
Installation	173
Connecting to a PC	174
About the PC display	176
Starting HD Writer AE 5.2	177
Reading the operating instructions of the software applications	177
If using Mac (mass storage)	178

Others

Indications	179
Messages	182
About recovery	183
Troubleshooting	184
Cautions for use	189
About copyright	194
Recording modes/approximate recordable time	195
Approximate number of recordable pictures	196
Optional accessories	197

Names and Functions of Main Parts

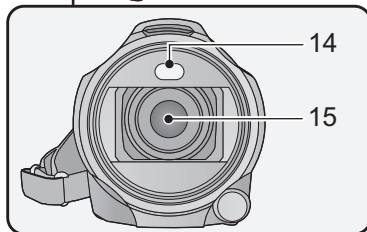
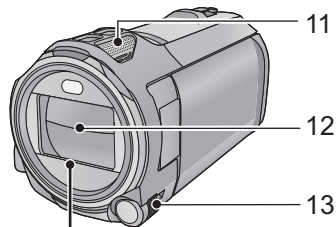
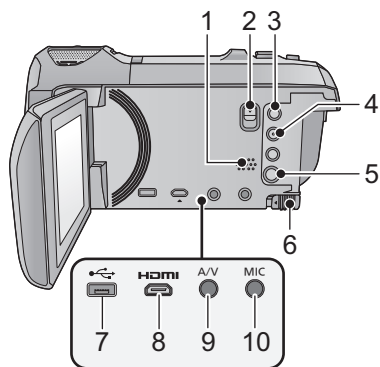

- 1 **Speaker**
- 2 **Shoe adaptor release lever**
[SHOE ADAPTOR RELEASE] (→ 197)
- 3 **Recording/playback button** [/]
(→ 18)
- 4 **Level Shot Function button** []
(→ 42)
- 5 **Power button** [/ I] (→ 17)
- 6 **Battery release lever** [BATT] (→ 11)
- 7 **USB terminal** [] (→ 118, 124, 174)
- 8 **Micro HDMI connector** [HDMI] (→ 113)
- 9 **A/V connector** [A/V] (→ 113, 126)
- 10 **Microphone terminal** [MIC]
 - A compatible plug-in powered microphone can be used as an external microphone.
 - If you connect an external microphone when a setting other than [AUTO] is selected for [MIC LEVEL] (→ 79), (Microphone input level meter) will be displayed.
 - When the unit is connected with the AC adaptor, sometimes noise may be heard depending on the microphone type. In this case, please switch to the battery for the power supply and the noise will stop.
- 11 **Internal microphones**
- 12 **Lens cover**
 - The lens cover opens in Motion Picture Recording Mode or Still Picture Recording Mode. (→ 18)
- 13 **Multi Manual Dial** [CAMERA FUNCTION]
(→ 56, 80)
- 14 **Video light** (→ 68, 82)
- 15 **Lens**

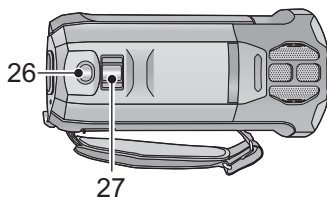
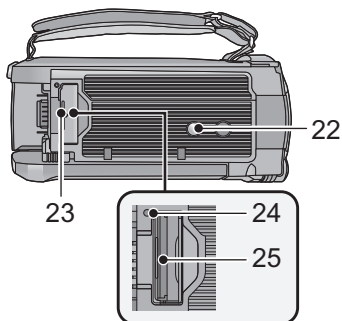
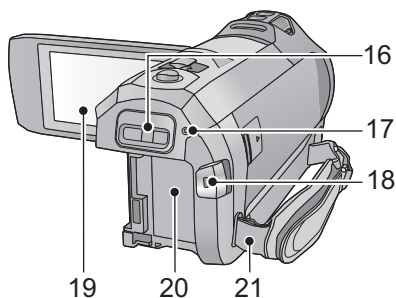

- 16 Shoe adaptor mounting part [SHOE ADAPTOR] (→ 197)
- 17 Status indicator (→ 17, 142)
- 18 Recording start/stop button (→ 23)
- 19 LCD monitor (Touch screen) (→ 19)

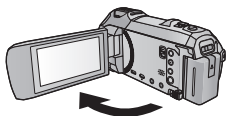

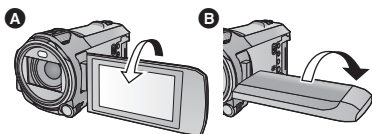

- It can open up to 90°.



- It can rotate up to 180° **A** towards the lens or 90° **B** towards the opposite direction.

- 20 Battery holder (→ 11)
- 21 Shoulder strap fixture

- 22 Tripod receptacle
 - Attaching a tripod with a screw length of 5.5 mm or more may damage the unit.
- 23 SD card cover (→ 16)
- 24 Access lamp [ACCESS] (→ 16)
- 25 Card slot (→ 16)
- 26 Photoshot button [] (→ 25)
- 27 Zoom lever [W/T] (In Motion Picture Recording Mode or Still Picture Recording Mode) (→ 41)/
Thumbnail display switch [ / ]/
Volume lever [-VOL+] (In Playback Mode) (→ 29)

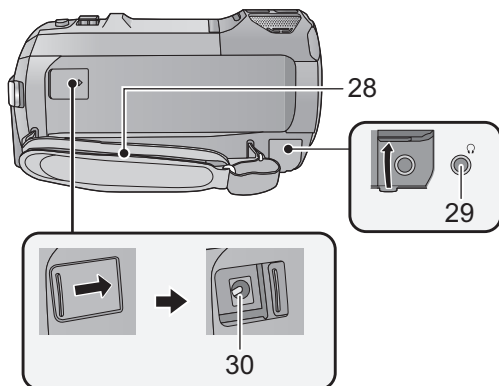

28 Grip belt

Adjust the length of the grip belt so that it fits your hand.

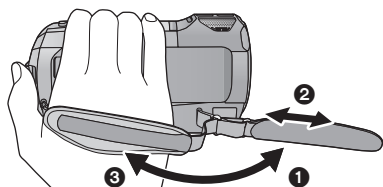

- 1 Flip the belt.
- 2 Adjust the length.
- 3 Replace the belt.

29 Headphone terminal [🎧] (→ 69)

- Excessive sound pressure from earphones and headphones can cause hearing loss.
- Listening at full volume for long periods may damage the user's ears.

30 DC input terminal [DC IN] (→ 12)

- Do not use any other AC adaptors except the supplied one.

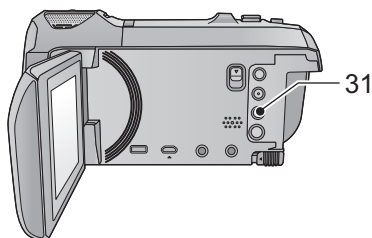

31 Wi-Fi button [Wi-Fi]
(→ 130, 135, 137, 149, 152)

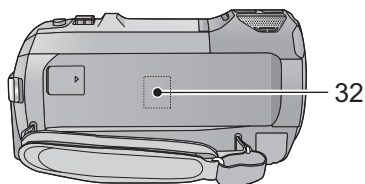

32 Wi-Fi Transmitter (→ 128)

Power supply

■ About batteries that you can use with this unit

The battery that can be used with this unit is VW-VBT190/VW-VBT380.

- The unit has a function for distinguishing batteries which can be used safely. The dedicated battery (VW-VBT190/VW-VBT380) supports this function. The only batteries suitable for use with this unit are genuine Panasonic products and batteries manufactured by other companies and certified by Panasonic. Panasonic cannot in any way guarantee the quality, performance or safety of batteries which have been manufactured by other companies and are not genuine Panasonic products.

It has been found that counterfeit battery packs which look very similar to the genuine product are made available to purchase in some markets. Some of these battery packs are not adequately protected with internal protection to meet the requirements of appropriate safety standards. There is a possibility that these battery packs may lead to fire or explosion. Please be advised that we are not liable for any accident or failure occurring as a result of use of a counterfeit battery pack. To ensure that safe products are used we would recommend that a genuine Panasonic battery pack is used.

Inserting/removing the battery

- Press the power button to turn off the unit. (→ 17)

Install the battery by inserting it in the direction shown in the figure.

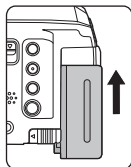
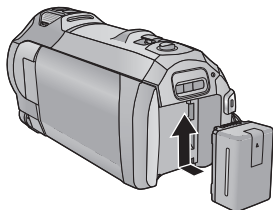

While holding the battery against the battery holder, push the battery upwards until you hear it click into place.

Removing the battery

Be sure to hold down the power button until the status indicator goes off. Then remove the battery while supporting the unit to prevent it from dropping.

Move the battery release lever in the direction indicated by the arrow and remove the battery when unlocked.

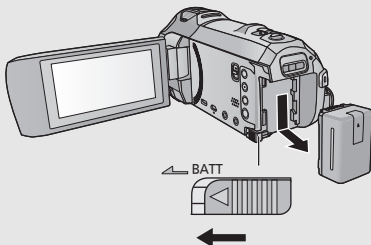

Charging the battery

When this unit is purchased, the battery is not charged. Charge the battery fully before using this unit for the first time.

The AC adaptor is in the standby condition when the mains plug is connected. The primary circuit is always "live" as long as the mains plug is connected to an electrical outlet.

Important:

- Do not use the AC adaptor/DC cable with any other equipment as it is designed only for this unit. Also, do not use the AC adaptor/DC cable from other equipment with this unit.
- The battery will not be charged if the unit is turned on.
- It is recommended to charge the battery in a temperature between 10 °C and 30 °C. (The battery temperature should also be the same.)

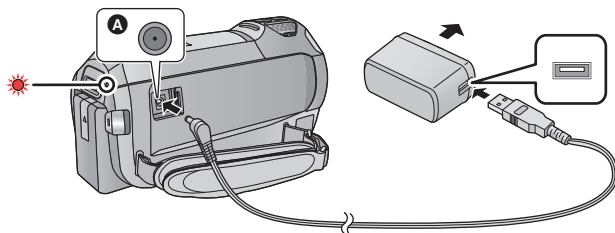

A DC input terminal

1 Connect the DC cable to the AC adaptor and to the DC input terminal of this unit.

- Insert the plugs as far as they will go.

2 Insert the AC adaptor into an AC outlet.

- The status indicator will flash red at an interval of approximately 2 seconds (approximately 1 second on, approximately 1 second off), indicating that charging has begun. It will turn off when the charging is completed.

■ Connecting to the AC outlet

It is possible to use this unit with power supplied from the AC outlet by turning on the unit with the AC adaptor connected.

Even when you use the AC adaptor for recording images, keep the battery connected.

This allows you to continue the recording even if a power failure occurs or the AC adaptor is unplugged from the AC outlet by accident.

■ To charge by connecting to other device

It is possible to charge by connecting to other device with the USB cable (supplied).
Please refer to page 175.

- If the status indicator flashes at a particularly fast or slow rate, refer to page 191.
- We recommend using Panasonic batteries (→ 13).
- If you use other batteries, we cannot guarantee the quality of this product.
- Do not heat or expose to flame.
- Do not leave the battery(ies) in a car exposed to direct sunlight for a long period of time with doors and windows closed.
- Do not expose to low air pressure at high altitudes.
- Do not expose to extremely low air pressure, as this may result in explosions or leakage of flammable liquids and gases.

Charging and recording time

■ Charging/Recording time

- The indicated charging time is for when the battery has been discharged completely.
Charging time and recordable time vary depending on the usage conditions such as high/low temperature.
- Temperature: 25 °C/humidity: 60%RH
- Charging times in parentheses are when charging from the USB terminal.



Battery model number [Voltage/Capacity (minimum)]	Charging time	Recording format	Recording mode	Maximum continuous recordable time	Actual recordable time
Supplied battery/ VW-VBT190 (optional) [3.6 V/1940 mAh]	2 h 20 min (5 h 20 min)	[AVCHD]	[1080/50p], [PH], [HA], [HG], [HE]	1 h 45 min	55 min
		[MP4/ iFrame]	[1080/50M]	1 h 40 min	50 min
			[1080/28M]	1 h 45 min	55 min
			[720], [iFrame]	2 h	1 h

Battery model number [Voltage/Capacity (minimum)]	Charging time	Recording format	Recording mode	Maximum continuous recordable time	Actual recordable time
VW-VBT380 (optional) [3.6 V/3880 mAh]	3 h 45 min (9 h 45 min)	[AVCHD]	[1080/50p]	3 h 40 min	1 h 55 min
			[PH], [HA], [HG], [HE]	3 h 45 min	
		[MP4/ iFrame]	[1080/50M]	3 h 35 min	1 h 50 min
			[1080/28M]	3 h 40 min	1 h 55 min
			[720]	4 h 10 min	2 h 10 min
			[iFrame]	4 h 15 min	

- "h" is an abbreviation for hour, "min" for minute and "s" for second.
- These times are approximations.

-
- The actual recordable time refers to the recordable time when repeatedly starting/stopping recording, turning the unit on/off, moving the zoom lever etc.
 - The batteries heat up after use or charging. This is not a malfunction.

Battery capacity indication

- The display changes as the battery capacity reduces.  If there is less than 3 minutes remaining, then  will become red. If the battery discharges, then  will flash.
- Screen display will disappear when no touch operation is performed for a specific period of time. However, it will be constantly displayed when the remaining battery time becomes less than 30 minutes.
- The remaining battery capacity is displayed when using the Panasonic battery that you can use for this unit. The actual time can vary depending on your actual use.
- When using the AC adaptor or batteries made by other companies, the remaining battery capacity will not be shown.

Recording to a card

The unit can record still pictures or motion pictures to an SD card. To record to an SD card, read the following.

Cards that you can use with this unit

Card type	Capacity
SD Memory Card	512 MB to 2 GB
SDHC Memory Card	4 GB to 32 GB
SDXC Memory Card	48 GB to 128 GB

- Please check the latest information on the support website below.

https://panasonic.jp/support/global/cs/e_cam

(This website is in English only.)

- **When using an SDHC Memory Card/SDXC Memory Card with other equipment, check the equipment is compatible with these Memory Cards.**
- We do not guarantee the operation of SD cards other than the ones above. Further, SD cards with a capacity of less than 32 MB cannot be used for motion picture recording.
- Operation is not guaranteed for all SD cards.
- 4 GB or more Memory Cards that do not have the SDHC logo or 48 GB or more Memory Cards that do not have the SDXC logo are not based on SD Memory Card Specifications.
- When the write-protect switch **A** on SD card is locked, no recording, deletion or editing will be possible on the card.
- Keep the Memory Card out of reach of children to prevent swallowing.

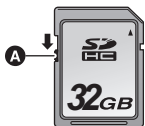

■ About the Speed Class ratings for recording motion pictures

- Depending on [REC MODE] and [REC FORMAT], the required card differs. (→ 72)
Use a card that meets the following ratings of the SD Speed Class. Use of a non-compatible card may cause recording to stop suddenly.
- SD Speed Class is the speed standards regarding continuous writing. To check the class, see the labelled side, etc. of the card.

Recording formats	Recording modes	Speed Class ratings	Label examples
MP4/iFrame	1080/50M	Class 10	CLASS 10
	1080/28M, 720, iFrame	Class 4 or more	CLASS 4
AVCHD	All		

- In the following situations, you need an SD card conforming to Class 10 of the SD Speed Class Rating to record motion pictures.

Use of a non-compatible card may cause recording to stop suddenly.

- FULL HD Slow Motion Video Mode (→ 53)
- When [Backup for Twin Camera] is set to [ON] (→ 43)

Inserting/removing an SD card

When using an SD card not from Panasonic, or one previously used on other equipment, for the first time on this unit, format the SD card. (→ 38) When the SD card is formatted, all of the recorded data is deleted. Once the data is deleted, it cannot be restored.

Caution:

Check that the access lamp has gone off.

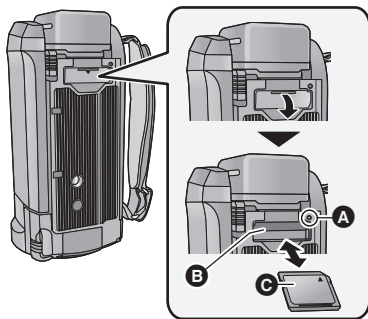

Access lamp [ACCESS] **A**

- When this unit is accessing the SD card, the access lamp lights up.

1 Open the SD card cover and insert (remove) the SD card into (from) the card slot **B**.

- Face the label side **C** in the direction shown in the illustration and press it straight in as far as it will go.
- Press the centre of the SD card and then pull it straight out.

2 Securely close the SD card cover.

- Securely close it until it clicks.

- Do not touch the terminals on the back of the SD card.
- Do not apply strong shocks, bend, or drop the SD card.
- Electrical noise, static electricity or the failure of this unit or the SD card may damage or erase the data stored on the SD card.
- When the card access lamp is lit, do not:
 - Remove the SD card
 - Turn the unit off
 - Insert and remove the USB cable
 - Expose the unit to vibrations or shockPerforming the above while the lamp is on may result in damage to data/SD card or this unit.
- Do not expose the terminals of the SD card to water, dirt or dust.
- Do not place SD cards in the following areas:
 - In direct sunlight
 - In very dusty or humid areas
 - Near a heater
 - Locations susceptible to significant difference in temperature (condensation can occur.)
 - Where static electricity or electromagnetic waves occur
- To protect SD cards, return them to their cases when you are not using them.
- About disposing of or giving away the SD card. (→ 192)

Turning the unit on/off

You can turn the unit on and off using the power button or by opening and closing the LCD monitor.

Turning the unit on and off with the power button

Open the LCD monitor and press the power button to turn on the unit.

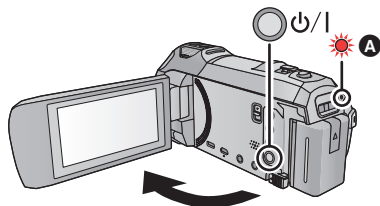

To turn off the unit

Hold down the power button until the status indicator goes off.

A The status indicator lights on.

Turning the unit on and off with the LCD monitor

The unit is turned on when the LCD monitor is opened, and unit is turned off when it is closed.

During normal use, opening and closing of the LCD monitor can be conveniently used to turn the unit on/off.

- The unit will not turn off while recording motion pictures or connecting to Wi-Fi even if the LCD monitor is closed.
- In the following cases, opening the LCD monitor does not turn on the unit. Press the power button to turn on the unit.
 - When the unit is originally purchased
 - When you have turned off the unit using the power button

■ Overheat detection

When the internal temperature of the unit rises during use, a message will be displayed. When this happens, the unit will turn off automatically a few minutes later.

- Wait until the temperature has dropped before resuming use.

If you try to use the Wi-Fi function while the internal temperature of this unit is high, a message will be displayed. When this happens, the Wi-Fi function is disabled.

- Wait until the temperature has dropped before resuming use.

Selecting a mode

You can switch this unit between Recording Mode (Motion Picture Recording Mode/Still Picture Recording Mode) and Playback Mode by pressing the recording/playback button.

If you touch the recording mode switching icon in Recording Mode, this unit can be switched between Motion Picture Recording Mode and Still Picture Recording Mode.

Motion Picture Recording Mode (→ 23)	Recording motion pictures.
Still Picture Recording Mode (→ 25)	Recording still pictures.
Playback Mode (→ 27, 83)	Motion picture/Still picture playback.

Switching this unit between Recording Mode and Playback Mode

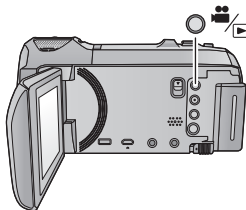

Recording/playback button

Press the button to switch this unit between Recording Mode and Playback Mode.

- When you turn on this unit, it starts up in Recording Mode.

Switching this unit between Motion Picture Recording Mode and Still Picture Recording Mode

Touch the recording mode switching icon displayed on the LCD monitor (touch screen) to switch this unit between Motion Picture Recording Mode and Still Picture Recording Mode.

1 Press the recording/playback button to switch this unit to Recording Mode.

- The recording mode switching icon **A** is displayed on the screen.

	Motion Picture Recording Mode
	Still Picture Recording Mode

2 Touch the recording mode switching icon.

- Refer to page 19 for touch screen operation.



(Motion Picture Recording Mode)

To display the recording mode switching icon

Display of the recording mode switching icon will disappear when no touch operation is performed for a specific period of time. To display it again, touch the screen.

- If the recording start/stop button is pressed in Still Picture Recording Mode or Playback Mode, this unit will be switched to Motion Picture Recording Mode. During motion picture/still picture playback or in other conditions, even if the recording start/stop button is pressed, the recording mode may not be switched.

Preparation

How to use the touch screen

You can operate by directly touching the LCD monitor (touch screen) with your finger.

■ Touch

Touch and release the touch screen to select icon or picture.

- Touch the centre of the icon.
- Touching the touch screen will not operate while you are touching another part of the touch screen.

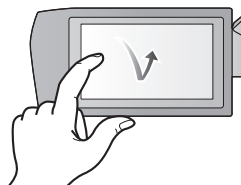

■ Slide while touching

Move your finger while pressing on the touch screen.

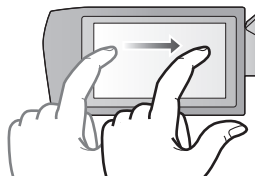

■ About the operation icons

▲ / ▼ / ◀ / ▶ :

Touch when changing a page or performing settings.

↶ :

Touch to return to the previous screen.

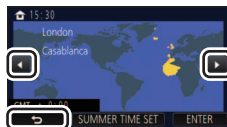

About the Touch Menu

Touch ◀ (left side)/▶ (right side) of  on the Touch Menu to switch the operation icons.

- It is also possible to switch the operation icons by sliding the Touch Menu right or left while touching it.

A Touch Menu

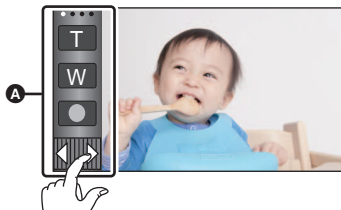

Recording Mode

Playback Mode

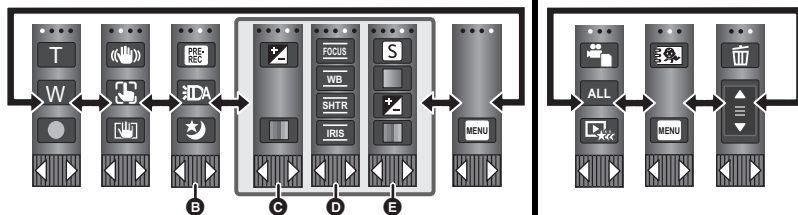

- B** You can change the operation icons to display. (→ 35)
- C** Displayed only in Intelligent Auto Plus Mode (→ 48) and [Miniature Effect]/[8mm movie]/[Silent movie] of the Creative Control Mode (→ 48).
- D** Displayed only in [Time Lapse Rec] of the Creative Control Mode (→ 48), Scene Mode (→ 52), HDR Movie Mode (→ 51), FULL HD Slow Motion Video Mode (→ 53), Stop Motion Animation Assist Mode (→ 55) and Manual Mode (→ 56).
- E** Displayed only when you adjust the picture quality with the Multi Manual Dial (→ 80)

■ To display the Touch Menu



Display of the Touch Menu will disappear when no touch operation is performed for a specific period of time during recording of motion picture/still picture. To display it again, touch .

- Do not touch on the LCD monitor with hard pointed tips, such as ball point pens.

Setting date and time

The clock is not set at the time of purchase. Make sure to set the clock.

- When you turn on this unit, the message “Set home region and date/time.” may be displayed. Select [YES], and follow the steps below to make these settings:

- Step 3 in [SET WORLD TIME] (→ 31)
- Steps 2–3 of “Setting date and time”

1 Select the menu. (→ 30)

MENU : [SETUP] → [CLOCK SET]

2 Touch the date or time to be set, then set the desired value using ▲ / ▼ .

- Ⓐ Displaying the World Time setting (→ 31):

🏠 [HOME] / ✈️ [DESTINATION]

- The year can be set between 2000 and 2039.

3 Touch [ENTER].

- Touch [EXIT] to complete the setting.

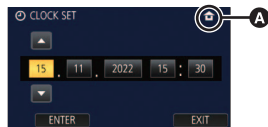

- The date and time function is driven by a built-in lithium battery.
- If the time display becomes [- -], the built-in lithium battery needs to be charged. To recharge the built-in lithium battery, connect the AC adaptor or attach the battery to this unit. The battery is still being recharged even if the unit is off. Leave the unit as it is for approx. 24 hours and the battery will maintain the date and time for approx. 4 months.

Before recording

■ Basic camera positioning

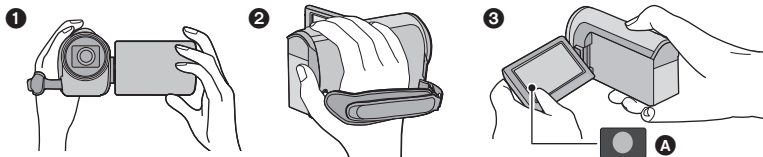

- ① Hold the unit with both hands.
- ② Put your hand through the grip belt.
- ③ It is convenient to use the Recording button icon **A** when holding the unit at waist level.
 - When recording, make sure your footing is stable and there is no danger of colliding with another person or object.
 - When you are outdoors, record pictures with the sunlight behind you. If the subject is backlit, it will become dark in the recording.
 - Keep your arms near your body and separate your legs for better balance.
 - Do not cover the microphones with your hand etc.

■ Basic motion picture recording

- The unit should normally be held steady when recording.
- If you move the unit when recording, do so slowly, maintaining a constant speed.
- The zoom operation is useful for recording subjects you cannot get close to, but overuse of zoom in and zoom out can make the resulting motion picture less enjoyable to watch.

■ Recording Yourself

Rotate the LCD monitor towards the lens side.

- The image is horizontally flipped as if you see a mirror image. (However the image recorded is the same as a normal recording.)
- Only some indications will appear on the screen. When  appears, return the direction of the LCD monitor to normal position and check the warning/alarm indication. (→ 182)

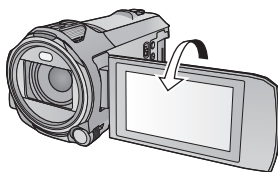



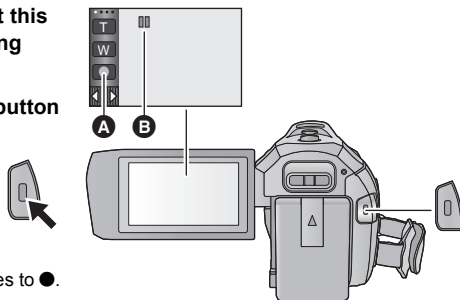

Recording motion pictures

- 1 Open the LCD monitor, and set this unit to Motion Picture Recording Mode. (→ 18)
- 2 Press the recording start/stop button to start recording.



- A Recording button icon
- B When you begin recording,  changes to .

- 3 Press the recording start/stop button again to pause recording.

- Recording can also be started/stopped by touching the recording button icon.

■ Screen indications in the Motion Picture Recording Mode

	Recording mode
R 1h20m	Approximate remaining recordable time <ul style="list-style-type: none"> • When the remaining time is less than 1 minute, R 0h00m flashes red.
0h00m00s	Recording time elapsed <ul style="list-style-type: none"> • "h" is an abbreviation for hour, "m" for minute and "s" for second. • Each time the unit is put into recording pause, the counter display will be reset to 0h00m00s.



- Screen display will disappear when no touch operation is performed for a specific period of time. To display it again, touch the screen. (→ 31)
- It will be constantly displayed when the remaining recordable time becomes less than 30 minutes.

- If the recording/playback button is pressed during motion picture recording, the recording will stop and this unit will be switched to Playback Mode.
- To change the recording format, change the [REC FORMAT] or [REC MODE]. (→ 71)
- Still pictures can be recorded while recording the motion picture. (→ 26)
- The images recorded between pressing the recording start/stop button to start recording and pressing it again to pause recording become one scene. Scenes exceeding 4 GB (approx.) or 30 minutes (approx.) will be automatically divided in the following cases. (Recording will continue.)
 - When [REC FORMAT] is set to [MP4/iFrame]
- (Maximum recordable scenes of a single SD card)

Recording format	[AVCHD]	[MP4/iFrame]
Recordable scenes	Approx. 3900	Approx. 89100
Different dates (→ 88)	Approx. 900	Approx. 900

- Maximum number of recordable scenes and maximum number of different dates will be less than above table when there are both MP4/iFrame scenes and still pictures recorded on an SD card.
- While recording is in progress, the recording will not stop even if the LCD monitor is closed.
- Put the unit in Pause mode when connecting or disconnecting an external microphone with the MIC terminal.
- Please refer to page 195 about approximate recordable time.



Recording still pictures

1 Open the LCD monitor, and set this unit to Still Picture Recording Mode. (→ 18)

2 Press the  button halfway. (For Auto Focus only)

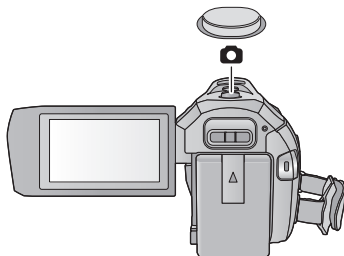

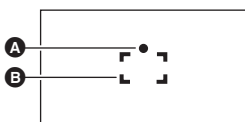

Focus indication:







- A** Focus indication:
 - (The white lamp flashes.): Focusing
 - (The green lamp lights up.): When in focus
 - No mark: When focusing is unsuccessful.
- B** Focus area (area inside brackets)

3 Press the  button fully.



- If you set the Optical Image Stabilizer function (→ 61) to  (1) ([MODE1]), then the Image Stabilizer function will be more effective. (MEGA) (MEGA Optical Image Stabilizer) will be displayed when the  button is pressed halfway.)
- Using a tripod is recommended when recording still pictures in dark places because the shutter speed becomes slow.
- You can also take a picture just by touching the subject to focus. (Touch Shutter: → 64)
- The still picture recording time may be long depending on the picture size.
- The focus indication and the focus area may not be displayed depending on the recording conditions or the menu settings.

■ About the screen indications in Still Picture Recording Mode

	Still picture operation indicator (→ 179)
R3000	Remaining number of still pictures ● Flashes in red when [0] appears.
	Size of still pictures (→ 81)
	MEGA Optical Image Stabilizer (→ 25)
	Optical Image Stabilizer (→ 61)
AF*	AF assist lamp (→ 82)



- Screen display will disappear when no touch operation is performed for a specific period of time. To display it again, touch the screen.
- It will be constantly displayed when the remaining number of still pictures that can be recorded becomes 200 or less.

■ About the focusing area

When there is a contrasting object ahead or behind the subject in the focus area, the subject may not be focused. If so, move the contrasting object out of the focus area.

Recording still pictures in Motion Picture Recording Mode

◇ Set this unit to Motion Picture Recording Mode. (→ 18)

Press the  button fully (press to the bottom) to take the picture.

- It is possible to record still pictures while recording motion pictures.
(Simultaneous recording)
- While still pictures are being recorded,  turns red and the remaining number of recordable pictures is displayed.
- No shutter sound is emitted when recording still pictures.



- Self-timer (→ 67) do not work.
- While recording motion pictures or during the PRE-REC operation, image quality is different from ordinary still pictures so that motion picture recording takes preference over still picture recording.
- If simultaneous recording is performed during motion picture recording, the remaining recordable time will be shortened. If this unit is turned off or the recording/playback button is pressed, the remaining recordable time may be lengthened.
- The still picture recording time may be long depending on the picture size.
- Maximum number of recordable pictures that can be displayed is 9999. If the number of recordable pictures exceeds 9999, R 9999+ is displayed. The number will not change when the picture is taken until the number of recordable pictures is 9999 or less.
- The recording time may be long depending on the recording condition.

Motion picture/Still picture playback





1 Set this unit to Playback Mode (→ 18).

2 Touch the play mode select icon **A** (→ 20).

- You can also set by touching **MENU**, selecting [VIDEO SETUP] or [PHOTO SETUP] → [MEDIA, VIDEO/PICTURE]. (→ 30)

3 Select the still picture **C** or the recording format of the motion picture **D** you wish to play back.

- Touch [Enter].
- If you touch , scenes recorded as Backup for Twin Camera will be displayed. The recording mode icon () will be displayed on the thumbnail screen, and each thumbnail will be displayed with one of the following icons:
 - AVCHD [PH] scenes recorded as Backup for Twin Camera: **PH**
 - AVCHD [HA] scenes recorded as Backup for Twin Camera: **HA**
 - AVCHD [HG] scenes recorded as Backup for Twin Camera: **HG**
 - AVCHD [HE] scenes recorded as Backup for Twin Camera: **HE**

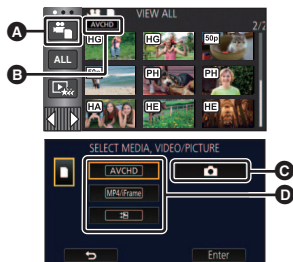

4 (When [AVCHD] or [MP4/iFrame] is touched)
Touch the desired recording format for playback.







- When [AVCHD] is selected

[ALL AVCHD]/[1080/50p]/[1080/50i]

- When [MP4/iFrame] is selected

[ALL MP4/iFrame]/[1080/50p]/[1080/25p]/[720/25p]/[360/25p]/[iFrame]

- The recording mode icon **B** is displayed in the thumbnail display when the item is touched. (**AVCHD**, **1080/50p**, **1080/50i**, **MP4/iFrame**, **1080/50p** (Red), **1080/25p** (Red), **720/25p** (Red), **360/25p** (Red) and **iFrame**)
- The following icons are displayed on thumbnails when [ALL AVCHD] or [1080/50i] is touched:
 - AVCHD [1080/50p] scene: **50p**
 - AVCHD [PH] scene: **PH**
 - AVCHD [HA] scene: **HA**
 - AVCHD [HG] scene: **HG**
 - AVCHD [HE] scene: **HE**

- The following icons are displayed on thumbnails when [ALL MP4/iFrame] is touched:
 - MP4 [1080/50p] scene:  (Blue) (Recording mode [1080/50M])
 - MP4 [1080/25p] scene:  (Recording mode [1080/28M])
 - MP4 [720/25p] scene: 
 - MP4 [360/25p] scene: 
 - iFrame scene: 
-  is displayed on the thumbnails of MP4 [1080/50M] scenes when [1080/50p] in [MP4/iFrame] is touched.

5 Touch the scene or the still picture to be played back.

- To display the next (previous) page:
 - Slide the thumbnail display upward (downward) while touching it.
 - Switch the touch menu, and then touch ▲ (up) / ▼ (down) on the thumbnail scroll lever. 

6 Select the playback operation by touching the operation icon.

- Operation icons and screen display will disappear when no touch operation is performed for a specific period of time. To display them again, touch the screen.





Operation icon

Motion picture playback	Still picture playback
<p>▶/ : Playback/Pause</p> <p>◀◀: Fast rewind playback*</p> <p>▶▶: Fast forward playback*</p> <p>■: Stops the playback and shows the thumbnails.</p>	<p>▶/ : Slide show (playback of the still pictures in numerical order) start/pause.</p> <p>◀ : Plays back the previous picture.</p> <p> ▶: Plays back the next picture.</p> <p>■: Stops the playback and shows the thumbnails.</p>

* When touched two times, the fast rewind/fast forward speed increases. (The screen display changes to ◀◀ / ▶▶ .)

Change the thumbnail display

While the thumbnail is displayed, the thumbnail display changes in the following order if the zoom lever is operated to  side or  side.
20 scenes \longleftrightarrow 9 scenes \longleftrightarrow 1 scene \longleftrightarrow Highlight & Time Frame Index*
([→ 85](#))

* Highlight & Time Frame Index can only set in Motion Picture Playback Mode.

- If you set this unit to Recording Mode or Playback Mode by pressing the recording/playback button, you will return to the 9 scenes display.
- By displaying in 1 scene or touching and holding the thumbnail in the 20 scenes or 9 scenes display, recording date and time are displayed when playing back motion pictures, and recording date and file number when playing back still pictures.

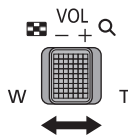

Speaker/Headphone volume adjustment

Operate the volume lever to adjust the speaker/headphone volume during Motion Picture Playback Mode.

Towards “+”: Increases the volume

Towards “-”: Decreases the volume

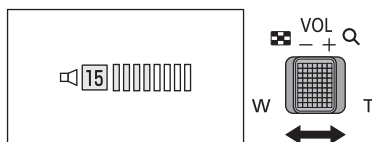

- Sound will be heard only during normal playback.
- If pause play is continued for approx. 5 minutes, the screen returns to the thumbnails.
- The elapsed time for playback indication will be reset to 0h00m00s each scene.
- When played back with [ALL AVCHD] or [ALL MP4/iFrame] selected, the screen may become black momentarily at the time the scene switches.

Motion picture compatibility

- This unit is based on AVCHD Progressive/AVCHD format/MPEG-4 AVC file format.
- Even if the devices used have compatible standards, when playback of motion pictures recorded using another device is performed using this unit, or when motion pictures recorded using this unit is played back in another device, playback may not proceed normally, or may not be possible. (Please check compatibility in the operating instruction of your device.)
- Motion pictures recorded with other devices are not supported by this unit.

Still picture compatibility

- This unit is compliant with the unified standard DCF (Design rule for Camera File system) established by JEITA (Japan Electronics and Information Technology Industries Association).
- This unit may degrade or not play back still pictures recorded or created on other products and other products may degrade or not play back still pictures recorded on this unit.
- Depending on the playback device, still pictures may be played back with picture sizes different from the ones with which they were recorded.

Using the menu screen

- Touch ◀ (left side)/ ▶ (right side) of  on the Touch Menu to display . (→ 20)

1 Touch .



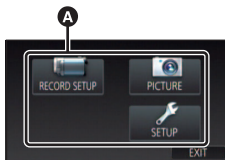

2 Touch the top menu .



3 Touch the submenu .



- Next (previous) page is displayed by touching  / .

4 Touch the desired item to enter the setting.

5 Touch [EXIT] to exit the menu setting.

■ About guide display

After touching , touching the submenus and items will cause function descriptions and settings confirmation messages to appear.

- After the messages have been displayed, the guide display is cancelled.

Using the Setup Menu

[DISPLAY]



Set the display method for the screen information display.

[MENU] : [SETUP] → [DISPLAY] → **desired setting**

[5 SEC.]: Information is displayed on the screen for 5 seconds after starting the Motion Picture Recording Mode or Still Picture Recording Mode, starting to playback, or touching the screen.

[ON]: Constantly displayed.

[CLOCK SET]



Please refer to page 21.

[SET WORLD TIME]



It is possible to display and record the time at the travel destination by selecting your home region and the travel destination.

1 Select the menu.

[MENU] : [SETUP] → [SET WORLD TIME]

- When the [HOME] (your home region) is not set, the message appears. Touch [ENTER] and proceed to Step 3.

2 (Only when setting your home region)

Touch [HOME].

- Touch [ENTER].

3 (Only when setting your home region)

Touch ◀/▶ to select your home region and touch [ENTER].

- Touch [SUMMER TIME SET] to set daylight saving time. ⚙️ is displayed and the summer time setting is turned on, the time difference between the current time and GMT will be set forward by 1 hour. Touch [SUMMER TIME SET] again to return to the normal time setting.

If you set [Link Clock to Summertime] to [ON], the current time will also be set forward by 1 hour. (→ 32)



- A** The current time
- B** The time difference from GMT (Greenwich Mean Time)



- 4 (Only when setting the region of your travel destination)

Touch [DESTINATION].

- Touch [ENTER].
- When the home region is set for the first time, the screen for selecting home/travel destination appears after setting the home region successively. If the home region has already been set once, execute the menu operation for Step 1.

- 5 (Only when setting the region of your travel destination)

Touch ◀/▶ to select your travel destination and touch [ENTER].

- Touch [SUMMER TIME SET] to set daylight saving time.  is displayed and the summer time setting is turned on, the time difference between the travel destination and the home region will be set forward by 1 hour. Touch [SUMMER TIME SET] again to return to the normal time setting. If you set [Link Clock to Summertime] to [ON], the time at the travel destination will also be set forward by 1 hour.
- Close the setting by touching [EXIT].  appears and the time of the travel destination is indicated.



- C The local time at the selected travel destination
- D The time difference between the travel destination and the home region

To return the display to the home setting

Set the home region using Steps 1 to 3, and close the setting by touching [EXIT].

- If you cannot find your travel destination in the area shown on the screen, set it by using the time difference from your home region.

[Link Clock to Summertime]



If you set this function to [ON] and turn on the summer time setting in [SET WORLD TIME], the following times will be set forward by 1 hour:

- When setting your home region: The current time
- When setting the region of your travel destination: The time at the travel destination

 : [SETUP] → [Link Clock to Summertime] → desired display

[ON]: The times are adjusted when the summer time setting is turned on.

[OFF]: The times are not adjusted when the summer time setting is turned on.

[DATE/TIME]



It is possible to change the date and time display mode.

: [SETUP] → [DATE/TIME] → desired display

[DATE]/[D/T]/[OFF]

- The date and time are not displayed while the recording mode switching icon is displayed. (→ 18)
- When the Touch Shutter is enabled, the recording mode switching icon is constantly displayed. This causes the date and time to disappear from the screen.

[DATE FORMAT]



It is possible to change the date format.

: [SETUP] → [DATE FORMAT] → desired setting

[Y/M/D]/[M/D/Y]/[D/M/Y]

[ZOOM/REC DISPLAY]



You can set the display method of the zoom button icons (/) and recording button icon ().

: [SETUP] → [ZOOM/REC DISPLAY] → desired setting

[ON]: Constantly displayed.

[OFF]: Icons will disappear after approx. 5 seconds without any touch operation.

[O.I.S. LOCK DISPLAY]



Please refer to page 63.

[EXT. DISPLAY]



Please refer to page 114.

[ECONOMY (BATT)]



When about 5 minutes have passed without any operation, this unit automatically turns off to save battery life.

MENU : [SETUP] → [ECONOMY (BATT)] → [ON]

- This unit will not automatically turn off even if [ECONOMY (BATT)] is set to [ON] in following cases:
 - Using the AC adaptor*
 - Using the USB cable for PC etc.
 - PRE-REC is used
 - During slide show playback
 - Using the Wi-Fi function

* When [ECONOMY (AC)] is activated, this unit automatically turns off.

[ECONOMY (AC)]



When about 15 minutes have passed without any operation while connecting AC adaptor with this unit, this unit automatically turns off.

MENU : [SETUP] → [ECONOMY (AC)] → [ON]

- This unit will not automatically turn off even if [ECONOMY (AC)] is set to [ON] in following cases:
 - Using the USB cable for PC etc.
 - PRE-REC is used
 - During slide show playback
 - Using the Wi-Fi function

[QUICK POWER ON]



The unit is put into recording pause approx. 1 second when the unit is turned on.

MENU : [SETUP] → [QUICK POWER ON] → [ON]

- Depending on the recording conditions, start time may be longer than 1 second.
- In the Quick Power On Mode, the zoom magnification becomes approx. 1×.

[ALERT SOUND]



Touch screen operation, starting and stopping of recording and unit on/off can be confirmed with this sound.

When [OFF] is selected, the sound is not output at the start/end of recording, etc.

: [SETUP] → [ALERT SOUND] → **desired setting**

(Volume low)/ (Volume high)/[OFF]

2 Beeps for 4 times

When an error occurs, follow the instructions displayed on the screen. (→ 182)

- Refer to page 82 when changing the shutter sound setting.

[SELECT OPERATION ICONS]



You can change the operation icons (→ 65) to display in the Touch Menu.

Register 3 favourite operation icons.

- The default settings are as follows:

Motion Picture Recording Mode	Still Picture Recording Mode
(Fade)	(Self-timer)
(PRE-REC)	(Video light)
(Video light)	(Backlight Compensation)

1 Select the menu.

: [SETUP] → [SELECT OPERATION ICONS]

2 Touch the operation icon you would like to change to cancel the setting.

3 Touch the operation icon to be set.

- Name of the function is displayed by touching and holding on the operation icon.
- To cancel, touch the operation icon again.

4 Touch [ENTER].

[POWER LCD]



This makes it easier to view the LCD monitor in bright places including outdoors.

MENU : [SETUP] → [POWER LCD] → **desired setting**

[+1]* (Makes brighter) / **[0]*** (Normal) / **[-1]*** (Makes less bright)

- These settings will not affect the images actually recorded.
- When the AC adaptor is in use, the LCD monitor is set to **[+1]*** automatically.
- Recordable time with the battery is shortened when the LCD is made brighter.
- When the video light is set to **⌘ID** ([ON]) or **⌘IDA** ([AUTO]) and it is lit, it cannot be set.

[LCD SET]



It adjusts brightness and colour density on the LCD monitor.

- These settings will not affect the images actually recorded.

1 Select the menu.

MENU : [SETUP] → [LCD SET] → **desired setting**

[BRIGHTNESS]: Brightness of the LCD monitor

[COLOUR]: Colour level of the LCD monitor

2 Touch **◀** / **▶** to adjust settings.

3 Touch [ENTER].

- Touch [EXIT] to exit the menu screen.

[HDMI RESOLUTION]



Please refer to page [115](#).

[VIERA Link]



Please refer to page [116](#).

[TV ASPECT]



Please refer to page [114](#).

[INITIAL SET]



Set to [YES] for changing the menu settings back to the default condition.

: [SETUP] → [INITIAL SET]

- Settings for [CLOCK SET] and [LANGUAGE] will not be changed.
- If you restore the default settings, this unit will switch to the Motion Picture Recording Mode.

[Reset Wi-Fi Settings]



Set to [YES] for changing the Wi-Fi settings back to the default condition.

: [SETUP] → [Reset Wi-Fi Settings]

- The password for the Wi-Fi is deleted.
- Information on wireless access points, smartphones, and Wireless Sub Cameras registered to this unit is also deleted.

[DELETE USER BGM]



You can delete the music (→ 91, 98, 103) stored on this unit as [USER BGM].

: [SETUP] → [DELETE USER BGM]

[Auto Cursor Position]



The entered character is confirmed in approx. 1 second after character input, and the cursor is moved to the right.

It makes the input easy without moving the cursor when characters on the same key are to be entered again.

: [SETUP] → [Auto Cursor Position] → [ON]

- Character input screen is displayed in following conditions:
 - When setting [TITLE SETUP] for the Highlight Playback (→ 94)
 - When entering a name in the Baby Calendar (→ 100)
 - When you configure the Wi-Fi function (→ 139, 145, 154, 155)

[NUMBER RESET]



Set the file number of the MP4/iFrame and still picture recorded next to 0001.

: [SETUP] → [NUMBER RESET]

- Folder number is updated and file number will start from 0001. (→ 176)
- To reset the folder number, format the SD card, and then perform [NUMBER RESET].

- The file numbers of still pictures you record in Stop Motion Animation Assist Mode are not reset.

[FORMAT MEDIA]



Please be aware that if a medium is formatted, then all the data recorded on the medium will be erased and cannot be restored. Back up important data on a PC, DVD disc etc. (→ 167)

: [SETUP] → [FORMAT MEDIA] → desired media

[SD CARD]/[HDD]*

- * Displayed when connecting a USB HDD. (→ 118)
- Media selection screen is not displayed when the USB HDD is not connected. Touch [YES].
- When formatting is complete, touch [EXIT] to exit the message screen.
- Perform a physical formatting of the SD card when the SD card is to be disposed/ transferred. (→ 192)

- Do not turn this unit off or remove the SD card, while formatting. Do not expose the unit to vibrations or shock.

Use this unit to format media.

Do not format an SD card using any other equipment such as a PC. The card may not be used on this unit.

[MEDIA STATUS]



The used space and remaining recordable time of the SD card can be checked.

: [SETUP] → [MEDIA STATUS]

- The remaining recordable time in the currently set Recording Mode is displayed only in the Motion Picture Recording Mode.
 - Touch [EXIT] to close the indication.
-
- The SD card requires some space to store information and manage system files, so the actual usable space is slightly less than the indicated value. The usable SD card space is generally calculated as 1 GB=1,000,000,000 bytes. The capacities of this unit, PCs and software are expressed as 1 GB=1,024×1,024×1,024=1,073,741,824 bytes. Therefore, the indicated value of the capacity appears to be smaller.

[Version Disp.]



The firmware version of this unit is displayed.

: [SETUP] → [Version Disp.]

[Version Up]



You can update the firmware version of this unit.

: [SETUP] → [Version Up]

For the latest update information, check the support website below. (As of January 2022)

https://panasonic.jp/support/global/cs/e_cam
(This Site is English only)

[DEMO MODE]



This item is used to start the unit demonstration.

: [SETUP] → [DEMO MODE] → [ON]

- If [DEMO MODE] is switched to [ON] and you touch [EXIT] when there is no SD card inserted and while this unit is connected to the AC adaptor, the demonstration automatically starts. If any operation takes place, the demonstration is cancelled. However if no operations take place for approx. 10 minutes, the demonstration automatically starts again. To stop the demonstration, set [DEMO MODE] to [OFF] or insert an SD card.
- When Demo Mode is in operation, the lens cover remains open.

[O.I.S. DEMO]



This item is used to start the Optical Image Stabilizer demo.

[MENU] : [SETUP] → [O.I.S. DEMO]

- Touch [O.I.S. DEMO], the demonstration automatically starts.
When you touch [EXIT], the demonstration will be cancelled.

[SOFTWARE INFO]



You can connect this unit and a PC with the USB cable and check software information (License) on the PC.

1 Select the menu.

[MENU] : [SETUP] → [SOFTWARE INFO]

2 Connect this unit to a PC.

- A message will be displayed when the connection is complete. On the PC, confirm [LICENSE.TXT].
 - When using the battery, the LCD monitor turns off after about 5 seconds. Touch the screen to turn the LCD monitor on.
-
- Do not use any other USB cables except the supplied one. (Operation is not guaranteed with any other USB cables.)

[ONLINE MANUAL]



You can check how to access the website where you can download the Operating Instructions (PDF format).

[MENU] : [SETUP] → [ONLINE MANUAL] → desired access method

[URL display]:	Displays the URL of the website on the LCD monitor of this unit.
[USB connect]:	Displays the website on a PC connected to this unit with the USB cable.
[QR code]:	Displays the QR code of the website on the LCD monitor of this unit.

[LANGUAGE]



You can select the language on the screen display and the menu screen.

[MENU] : [SETUP] → [LANGUAGE] → desired language

Using the zoom

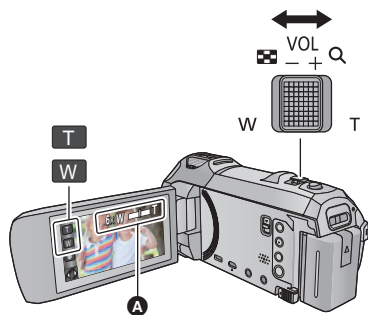

Zoom lever/Zoom button icons

T side:

Close-up recording (zoom in)

W side:

Wide-angle recording (zoom out)

A Zoom bar

- Maximum zoom ratio for recording motion pictures can be set with [ZOOM MODE]. (→ 71)

About the zoom bar

The zoom bar is displayed during the zoom operation.

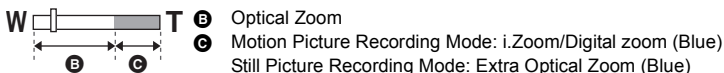

B Optical Zoom

C Motion Picture Recording Mode: i.Zoom/Digital zoom (Blue)
Still Picture Recording Mode: Extra Optical Zoom (Blue)

About the zoom speed

- The zoom speed varies depending on the range over which the zoom lever is moved.
- The zoom operation using the zoom button icons will be performed at a constant speed respectively.

Zoom ratio during the Still Picture Recording Mode

The zoom ratio can be expanded up to 50× without degrading the picture quality for the Still Picture Recording Mode. (Extra Optical Zoom)

- Maximum zoom ratio in Still Picture Recording Mode varies depending on the setting of [PICTURE SIZE] and [ASPECT RATIO]. (→ 81, 82)
-
- If you take your finger off the zoom lever during zoom operation, the operation sound may be recorded. When returning the zoom lever to the original position, move it quietly.
 - When the zoom magnification is at its maximum, the subjects are focused at about 1.5 m or more.
 - When the zoom magnification is 1×, this unit can focus on a subject approx. 3 cm away from the lens.



Level Shot Function

This function detects the horizontal tilt of the unit, and automatically corrects it to the level position.

(When setting (Normal)) (When setting s (Strong))

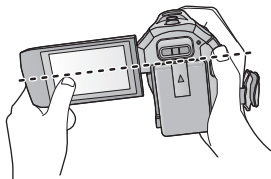

————— : With Level Shot Function

..... : Without Level Shot Function

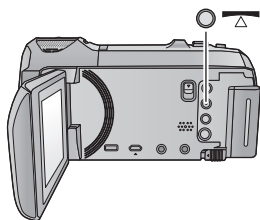

Level Shot Function button

Each press of this button switches Level Shot Function.

(Normal) → s (Strong) → Off

(Normal): Corrects the tilt.

s (Strong): Strengthen tilt correction.

Off: Cancel the setting.

- The icon changes when the tilt exceeds the correction range.

/ s	When the tilt is corrected
/ s / s / s	When the tilt is above the correction range

- When the tilt exceeds the correction range, move the unit to the position where / s is displayed.
-
- This function's default setting is (Normal).
 - The range that this icon can be displayed correctly the slope is about 45° to the horizontal direction.
 - Level Shot Function is cancelled when [LEVEL GAUGE] is set to [ON]. (→ 74)
 - When recording horizontal images using a tripod, attach the unit on the tripod using [LEVEL GAUGE] (→ 74), and then set Level Shot Function to (Normal) or s (Strong) before use.
 - When you switch the setting of the Level Shot Function, the screen may become black momentarily.
 - If you set the option to s (Strong), the angle of view will change.



Recording with the Backup for Twin Camera Function

When simultaneously recording two images with the Main Camera, you can also record the Main Camera's image as a separate scene. (Backup for Twin Camera)

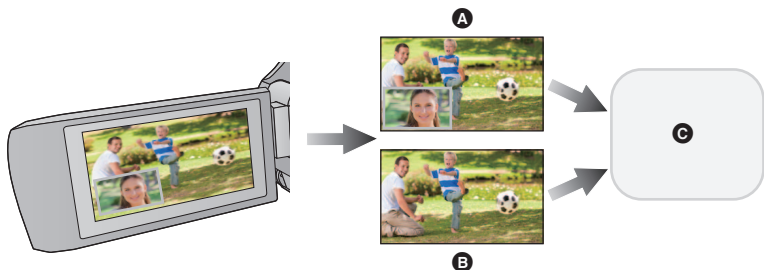

- A** Twin Camera
- B** Backup for Twin Camera
- C** SD card

- Even when using the Wireless Twin Camera function, you can save the image being recorded with the Main Camera as a separate scene. (→ 156)
- Set [REC FORMAT] to [AVCHD] and [REC MODE] to [PH]/[HA]/[HG]/[HE]. (→ 71)

MENU : [RECORD SETUP] → [Backup for Twin Camera] → [ON]

-  will be displayed on the screen.
- When Twin Camera recording starts, this unit also starts recording the Main Camera's image without the Sub Window image as a separate scene.

-
- **When recording with [Backup for Twin Camera], use an SD card conforming to Class 10 of the SD Speed Class Rating.**
 - Scenes recorded as Backup for Twin Camera and scenes that show the Sub Window's image will be saved on the same media. This causes the remaining recordable time to be halved.
 - When [ON] is selected, two separate dates are used to record scenes simultaneously. As a result, compared to when [OFF] is selected, recording can be performed on fewer days.
 - Backup for Twin Camera operates when it is set to [ON], even if you hide the Sub Window.
 - You cannot record still pictures while recording with the Backup for Twin Camera function.
 - Backup for Twin Camera is not available when any of the following functions is being used:
 - Creative Control
 - FULL HD Slow Motion Video Mode
 - HDR Movie Mode





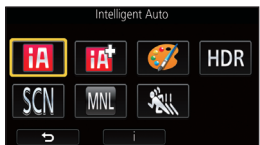

Changing the Recording Mode

1 Touch the Recording Mode button icon.



2 Touch the desired Recording Mode button icon.











Mode		Effect
 *1  *2	Intelligent Auto	You can switch the mode to the Intelligent Auto Mode, which optimises settings to the recording environment you are in. (→ 46)
 *1  *2	Intelligent Auto Plus	You can add manually-adjusted brightness and colour balance settings to the Intelligent Auto Mode, and record. (→ 48)
 *1	Creative Control	You can record motion pictures with added effects. (→ 48)
HDR *1	HDR Movie	You can minimise the loss of gradations in bright areas and dark areas when, for example, the contrast between the background and the subject is large. (→ 51)
SCN	Scene Mode	This option allows this unit to automatically adjust the shutter speed and aperture, etc. according to the scene you want to record. (→ 52)
MNL	Manual	You can set the shutter speed, focus, White Balance, and brightness (iris/gain). (→ 56)
 *1	FULL HD Slow Motion Video	You can record slow motion pictures. (→ 53)
 *2	Stop Motion Animation Assist	You can set a recorded still picture as the background, and record the next picture while looking at that recorded picture as the background. (→ 55)

*1 In Motion Picture Recording Mode only

*2 In Still Picture Recording Mode only



The following modes (appropriate for the condition) are set just by pointing the unit to what you want to record.

Mode	Effect
 Portrait	Faces are detected and focused automatically, and the brightness is adjusted so it is recorded clearly.
 Scenery	The whole landscape will be recorded vividly without whiting out the background sky, which may be very bright.
 ^{*1} Spotlight	Very bright object is recorded clearly.
 ^{*1} Low Light	It can record very clearly even in a dark room or twilight.
 ^{*2} Night Scenery	You can record night scenery vividly by slowing the shutter speed.
 ^{*2} Macro	This allows recording at very close proximity to the object of recording.
 ^{*1} Normal	In modes other than those described above, the contrast is adjusted to give a clear picture.
 ^{*2} Normal	

*1 In Motion Picture Recording Mode only

*2 In Still Picture Recording Mode only

- Depending on the recording conditions, the unit may not enter the desired mode.
- In the Portrait, Spotlight, or Low Light Mode, the face will be surrounded by a white frame when detected. In the Portrait Mode, a subject that is bigger and close to centre of the screen will be surrounded by an orange frame. (→ 73)
- Using a tripod is recommended in Night Scenery Mode.
- Faces cannot be detected depending on the recording conditions, such as when faces are of certain sizes or at certain tilts or when digital zoom is used.

■ Intelligent Auto Mode

When switching to Intelligent Auto Mode, the Automatic White Balance and Auto Focus operate and automatically adjust the colour balance and focusing.

Depending on the brightness of the subject etc., the aperture and shutter speed are automatically adjusted for an optimum brightness.

- Colour balance and focus may not be adjusted automatically depending on light sources or scenes. If so, manually adjust these settings. (→ 57, 59)

Automatic White Balance

The illustration shows the range over which Automatic White Balance functions.

- 1) The effective range of Automatic White Balance adjustment on this unit
- 2) Blue sky
- 3) Cloudy sky (rain)
- 4) Sunlight
- 5) White fluorescent lamp
- 6) Halogen light bulb
- 7) Incandescent light bulb
- 8) Sunrise or sunset
- 9) Candlelight

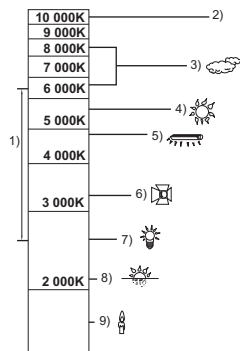

If the Automatic White Balance is not functioning normally, adjust the White Balance manually. (→ 57)

Auto Focus

The unit focuses automatically.

- Auto Focus does not work correctly in the following situations.
Record pictures in the Manual Focus Mode. (→ 59)
 - Recording distant and close-up objects at the same time
 - Recording a subject behind dirty or dusty window
 - Recording a subject that is surrounded by objects with glossy surfaces or by highly reflective objects



Please refer to page 46 for details about the effect of each mode.

(Portrait) / (Scenery) / (Spotlight)*1 / (Low Light)*1 / (Night Scenery)*2 / (Macro)*2 / (Normal)*1 / (Normal)*2

*1 In Motion Picture Recording Mode only

*2 In Still Picture Recording Mode only

● Change the Recording Mode to / . (→ 45)

1 (When adjusting the brightness)

Touch .

(When adjusting the colour balance)

Touch .

● R side: Sets the balance to a reddish tone.

B side: Sets the balance to a bluish tone.

● Except for when adjusting the brightness or colour balance, if you do not touch the screen for a while, the Touch Menu will disappear. To display it again, touch .

2 Touch / to adjust settings.

● Touch while adjusting the brightness, or touch while adjusting the colour balance to make the display of the adjustment bar disappear.

3 Start recording.

Creative Control



● Set [REC FORMAT] to [AVCHD]. (→ 71)

● Change the Recording Mode to . (→ 45)

Select the desired Creative Control Mode, then touch [Enter].

Mode	Effect
[Miniature Effect]	You can record motion pictures with a diorama effect like recording a miniature by intentionally creating focused area and out of focused area in the peripheral of the image and recording motion picture with an interval. (→ 49) ● Motion pictures recorded with this function will look as if the frame rate is low.
[8mm movie]	You can record motion pictures with a faded retro effect. (→ 50)
[Silent movie]	You can record motion pictures that are similar to black-and-white silent films by lowering the amount of incoming light. (→ 50)
[Time Lapse Rec]	You can record a scene that moves slowly over a long period of time as a short time motion picture by recording one frame at each set time lapse. (→ 50)

● Still pictures cannot be taken.

1 Touch to adjust the horizontal position of the in-focus portion.

- If you touch the screen, you can adjust the horizontal position of the in-focus portion.
- When no touch operations are performed for approximately 1 second, [Reset], [SIZE], and [ENTER] are displayed. If you touch the screen, you can readjust the horizontal position of the in-focus portion.
- Position of the in-focus portion will return to original position when you touch [Reset].



2 Touch [SIZE].



- The size of the in-focus portion is switched every time you touch [SIZE].
Medium size → Large size → Small size
- If you touch the screen, you can adjust the horizontal position of the in-focus portion.
- If you touch [Reset], the in-focus portion is reset to the original position and [SIZE] is reset to the medium size.

3 Touch [ENTER].

- 4 (When adjusting the brightness)

Touch .

- The level of brightness is switched every time you touch the icon.

₀(Standard) → ₊₁(Bright) → ₋₁(Dark)

- 5 (When adjusting the vividness)

Touch .

- The level of vividness is switched every time you touch the icon.

₀(Standard) → ₊₁(Vivid) → ₊₂(Most vivid)

6 Start recording.

- It will record with an interval. 1 second will be recorded for approximately every 6 seconds of recording.



- To make the Miniature Effect easier to gain, record objects incorporating a distant view or those that can provide depth or a skewed perspective. Also, use a tripod and avoid zooming.
- You may see a lot of noise in the in-focus portion when recording dark subjects such as night scenes.
- Audio cannot be recorded.
- [REC MODE] is set to [HA].
- The maximum recordable time is 12 hours.
- Motion pictures recorded with this function will look as if the frame rate is low.

8mm [8mm movie]

1 (When adjusting the brightness)

Touch .

- The level of brightness is switched every time you touch the icon.

0 (Standard) → +1 (Bright) → -1 (Dark)

2 (When adjusting the colour balance)

Touch .

- The level of colour balance is switched every time you touch the icon.

B (Blue) → R (Red) → Y (Yellow)

3 Start recording.



- The sound is monaural.

SILN [Silent movie]

1 (When adjusting the brightness)

Touch .

- The level of brightness is switched every time you touch the icon.

0 (Standard) → +1 (Bright) → -1 (Dark)

2 Start recording.

- Audio cannot be recorded.

INTV [Time Lapse Rec]

Touch the desired setup time.

[1 SEC.]/[10 SEC.]/[30 SEC.]/[1 MINUTE]/[2 MINUTES]

- Touch [ENTER].
- A frame is recorded with a set recording interval. 25 frames will make up a motion picture of 1 second.

Setup example	Setup time (recording interval)	Recording time	Recorded time
Sunset	1 s	1 h	2 min 20 s
Blooming	30 s	3 h	14 s

- "h" is an abbreviation for hour, "min" for minute and "s" for second.
- These times are approximations.
- Maximum recordable time is 12 hours.

-
- Audio cannot be recorded.
 - [REC MODE] is set to [HA].
 - The shortest motion picture recording time is 1 second.
 - The colour balance and focus may not be adjusted automatically depending on the light source or scene. If so, manually adjust those settings. (→ 57, 59)
 - When recording for a long time, we recommend recording with the AC adaptor connected.

HDR HDR Movie Mode



● Change the Recording Mode to HDR . (→ 45) Recording

- [REC MODE] is set to [1080/28M] in the following cases:
 - When [REC FORMAT] is set to [MP4/iFrame] and [REC MODE] is set to [720] or [iFrame]
- The following settings are cancelled:
 - [FACE FRAMING]
 - Auto Slow Shutter
 - Backlight Compensation
 - Intelligent Contrast Control
 - Night Mode
 - Digital cinema colour
 - [PICTURE ADJUST]
 - [HYBRID O.I.S.]
- The video light is disabled.
- You cannot record still pictures.
- Depending on recording conditions, the screen may flicker or you may see horizontal bars in the image.
- If you record a moving subject or move this unit quickly while recording, the image may be distorted.

■ To change the level of image contrast correction

[HDR EFFECT] allows you to change the contrast correction level in HDR Movie Mode.

- Change the Recording Mode to HDR . (→ 45)

1 Select the menu.

 : [RECORD SETUP] → [HDR EFFECT] → desired setting

HDR \square : Sets the correction level to high.

HDR \square : Sets the correction level to low.

2 Touch [ENTER].

- Touch [EXIT] to complete the settings.











- You can also change this setting by touching its operation icon. (→ 65)
- You may not see the full effect depending on the recording conditions.

SCN Scene Mode



- Change the Recording Mode to SCN . (→ 45)

Touch the desired Scene Mode.

Mode	Effect
 Sports:	To make fast moving scenes less shaky with slow playback and pause of playback
 Portrait:	To make people stand out against the background
 Soft Skin:	To makes skin colours appear softer for a more attractive appearance
 Spotlight:	Improved quality when subject is brightly illuminated
 Snow:	Improved image quality when shooting in snowy locations
 Beach:	To make blue in the sea or sky vibrant
 Sunset:	To make red in the sunrise or sunset vibrant
 Scenery:	For spatial scenery
 Fireworks:	To capture the fireworks in the night sky beautifully
 Night Scenery:	To capture the evening or night scenery beautifully
 Low Light:	For dark scenes, such as at dusk (In Motion Picture Recording Mode only)

- Touch [ENTER].

- **(Sports/Portrait/Soft Skin/Spotlight/Snow/Beach/Sunset/Scenery)**
 - The shutter speed is 1/6 or more in Still Picture Recording Mode.
- **(Sunset/Low Light)**
 - The shutter speed is 1/25 or more in Motion Picture Recording Mode.
- **(Sunset/Scenery/Fireworks/Night Scenery)**
 - Image may get blurry when close object is recorded.

- **(Sports)**
 - During normal playback, the image movement may not look smooth.
 - Colour and screen brightness may change under indoor lighting.
 - If the brightness is insufficient, the Sports Mode does not function. The  display flashes.
- **(Portrait)**
 - Colour and screen brightness may change under indoor lighting.
- **(Soft Skin)**
 - If the background or anything else in the scene has colours similar to the skin colour, they will also be smoothed.
 - If the brightness is insufficient, the effect may not be clear.
 - If you record a person in the distance, the face may not be recorded clearly. In this case, cancel Soft Skin Mode or zoom in on the face (close-up) to record.
- **(Fireworks)**
 - The shutter speed is 1/25.
 - Image may get washed out when recorded in bright surrounding.
- **(Night Scenery)**
 - The shutter speed is 1/2 or more in Still Picture Recording Mode.
 - Using a tripod is recommended.



FULL HD Slow Motion Video



- Change the Recording Mode to . (→ 45)

1 Select the menu.

MENU : [RECORD SETUP] → [SLOW MOTION SETUP] → desired setting

[Interval]: Allows you to switch between normal recording and FULL HD Slow Motion Video recording while recording.

[Always]: Records the entire scene as FULL HD Slow Motion Video.



2 Start recording.

3 (When [Interval] is selected)

Touch and hold  when you want to use FULL HD Slow Motion Video recording.

- As long as you touch and hold the icon, FULL HD Slow Motion Video recording will continue.
- Once you release your finger, normal recording will start.
- For each recording you make, FULL HD Slow Motion Video recording is possible up to 3 times.
- To check how many more times you can use FULL HD Slow Motion Video recording, see the number of the yellow lights **A**.



-
- **To record the scene into an SD card, use an SD card conforming to Class 10 of the SD Speed Class Rating.**
 - Recordable time with the battery will be shortened with the use of FULL HD Slow Motion Video recording.
 - FULL HD Slow Motion Video recording uses the following settings:
 - Level Shot Function: Off
 - [ZOOM MODE]: [Opt.Zoom 20×]
 - [HYBRID O.I.S.]: [OFF]
 - [AUTO SLOW SHTR]: [OFF]
 - The shutter speed is 1/100 or more.
 - The following restrictions apply to FULL HD Slow Motion Video Mode:
 - The number of pixels/frame rate are fixed to 1920×1080/50p.
 - The sound of the parts will not be recorded ( will be displayed during the recording).
 - Still pictures cannot be recorded.
 - The size of the image displayed on the screen will change.
 - Images and sound are not output from this unit to another device.
 - When you switch to FULL HD Slow Motion Video Mode, the screen may become black momentarily.
 - When FULL HD Slow Motion Video recording starts, the following settings are cancelled:
 - AF/AE tracking
 - PRE-REC
 - Fade
 - On the thumbnail screen in Playback Mode, scenes recorded as FULL HD Slow Motion Video are displayed with the  indication.
 - You can set the playback speed on this unit in [SLOW PLAY SPEED] (→ 87). In addition, you can set the playback speed on another device to 1/4 normal speed in [Slow Speed Conversion] (→ 112).



Before recording in Stop Motion Animation Assist Mode

You can create a slideshow that appears to be moving by recording the subject while moved a little at a time.

- Each recording group can store up to 999 still pictures recorded in Stop Motion Animation Assist Mode.

• Change the Recording Mode to . (→ 45)

1 Press the button to record the still pictures. (→ 25)

2 Touch [Enter].

- A still picture will be recorded, and it will be displayed in a semi-transparent state on the recording screen. Look at the picture to estimate how far you should move the subject for the next recording.
- If you have already recorded still pictures in the recording group, the last still picture will be displayed in a semi-transparent state on the recording screen.
- To record again, touch and record again.

3 Move the subject and determine the composition of the picture.

- Repeat Steps 1-3 to continue recording.
- You can save still pictures in the same recording group until you use [Create Stop Motion].

Creating a new recording group

: [PICTURE] → [Create Stop Motion]

- If you touch [YES], a new recording group will be created and the recording screen will be displayed.
- Once you create a recording group, you cannot save still pictures in any of the older recording groups.

- [PICTURE SIZE] is set to (1920×1080).
- When you want to record still pictures in a separate recording group, use a different SD card.
- For details on playback of the Stop Motion Animation Assist Mode, refer to page 104.

Manual recording



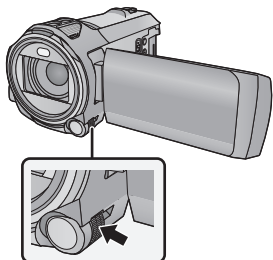

- The Manual Focus, White Balance, Shutter Speed, Brightness (Iris and Gain) settings are retained when you change between Motion Picture Recording Mode and Still Picture Recording Mode.

Push the Multi Manual Dial to switch to Manual Mode.

- When an item on the manual icon or the picture quality adjustment icon (→ 80) is not selected, each time you push the Multi Manual Dial, the manual icon and the picture quality adjustment icon are displayed alternately. Display the manual icon.
- It is also possible to switch to Manual Mode by touching the Recording Mode button icon. (→ 45)





A Manual icon

-  Focus (→ 59)
-  White Balance (→ 57)
-  Manual Shutter Speed (→ 58)
-  Iris Adjustment (→ 58)

- To cancel the manual settings, change the Recording Mode to the Intelligent Auto Mode. (→ 45)

■ When using the LCD monitor

- 1 Touch the desired item to be set.
- 2 Touch  /  to enter the selection.



■ Using the Multi Manual Dial

- 1 Rotate the Multi Manual Dial to select an item.

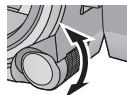

- 2 Push the Multi Manual Dial to set.

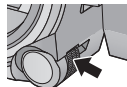

- 3 Rotate the Multi Manual Dial to select a setting.



- 4 Push the Multi Manual Dial to set.

White Balance



Automatic White Balance function may not reproduce natural colours depending on the scenes or lighting conditions. If so, you can adjust the White Balance manually.

- **Switch to Manual Mode.** (→ 56)
- **For information on how to set items with the Multi Manual Dial, refer to page 56.**

1 Touch [WB].

2 Touch / to select White Balance Mode.

- Touch [WB] to select the mode.



Icon	Mode/Recording conditions
	Automatic White Balance adjustment
	Sunny mode: Outdoors, under a clear sky
	Cloudy mode: Outdoors, under cloudy sky
	Indoor mode 1: Incandescent light, video lights like in the studio, etc.
	Indoor mode 2: Colour fluorescent lamps, sodium lamps in gymnasiums etc.
	Manual adjustment mode: <ul style="list-style-type: none">● Mercury-vapor lamps, sodium lamps, some fluorescent lights● Lights used for wedding receptions at hotels, stage spotlights in theaters● Sunrise, sunset, etc.

- To return to auto setting, set to or change the Recording Mode to the Intelligent Auto Mode. (→ 45)

■ To set the White Balance manually

1 Select , fill the screen with a white subject.

2 Touch and set the blinking .

- When using the Multi Manual Dial, push and hold it.
- When the screen turns black instantly and the display stops flashing and then lights constantly, the setting is complete.
- If the display continues flashing, the White Balance cannot be set. In this case, use other White Balance Modes.



- When the display flashes, the Manual White Balance previously adjusted is stored. Whenever recording conditions change, re-set the White Balance.
- When setting both the White Balance and the iris/gain, set the White Balance first.
- is not displayed on the screen when is being set.

Manual shutter speed/iris adjustment



Shutter Speed:

Adjust it when recording fast-moving subjects.

Iris:

Adjust it when the screen is too bright or too dark.

- **Switch to Manual Mode.** (→ 56)
- **For information on how to set items with the Multi Manual Dial, refer to page 56.**

1 Touch [SHTR] or [IRIS].

2 Touch / to adjust settings.

- Touch [SHTR]/[IRIS] to end the adjustment.

: Shutter speed:

1/50 to 1/8000

- If [AUTO SLOW SHTR] is set to [ON], the shutter speed will be set between 1/25 and 1/8000.
- The shutter speed closer to 1/8000 is faster.
- The shutter speed will be set between 1/2 and 1/2000 in Still Picture Recording Mode.

: Iris/Gain value:

CLOSE ↔ (F16 to F2.0) ↔ OPEN ↔ (0dB to 18dB)

- Value closer to CLOSE darken the image.
- Value closer to 18dB brighten the image.
- When the iris value is adjusted to brighter than OPEN, it changes to the gain value.
- To return to auto setting, change the Recording Mode to the Intelligent Auto Mode. (→ 45)

-
- When setting both the shutter speed and the iris/gain value, set the shutter speed and then set the iris/gain value.

Manual shutter speed adjustment

- When the shutter speed is set lower than 1/12 in the Still Picture Recording Mode, using a tripod is recommended. The shutter speed will be set to 1/25 when the unit is turned on again.
- You may see a band of light around an object that is shining very bright, or highly reflective.
- During normal playback, image movement may not look smooth.
- If you record an extremely bright object or record under indoor lighting, colour and screen brightness may change or a horizontal line may appear on the screen. In this case, record in the Intelligent Auto Mode or set the shutter speed to 1/100 in areas where the power supply frequency is 50 Hz, or 1/125 in areas of 60 Hz.
- Brightness of the image displayed on the LCD monitor may be different from brightness of the image actually recorded during the Still Picture Recording Mode. Confirm the image on the playback screen after recording.

Manual iris/gain adjustment

- If the gain value is increased, the noise on the screen increases.
- Depending on the zoom magnification, there are iris values that are not displayed.

Manual Focus adjustment



If auto focusing is difficult due to the conditions, then use Manual Focus.

- Switch to Manual Mode. (→ 56)
- For information on how to set items with the Multi Manual Dial, refer to page 56.

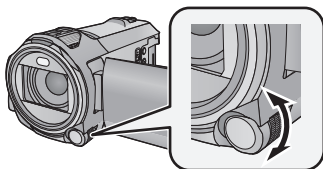

Rotate the Multi Manual Dial to set focus.

- 1 (When MF assist function is used)
Select the menu.

MENU : [RECORD SETUP] → [MF ASSIST] → [ON]

- Touch  to display the Manual icon.

- 2 Touch [FOCUS].

- 3 Touch [MF] to change to Manual Focus.

- MF appears on the screen.

- 4 Adjust the focus by rotating the Multi Manual Dial.

The in-focus area is displayed in blue. The normal screen returns approximately 2 seconds after you finish bringing the subject into focus.

- When [MF ASSIST] is [OFF], the blue area is not displayed.
- To restore Auto Focus, touch [AF] in Step 3 or change the Recording Mode to the Intelligent Auto Mode. (→ 45)



A Part displayed in blue

- The blue display does not appear on the images actually recorded.

Recording with the Touch Function

You can record using convenient functions just by the easy operation of touching the screen.

1 Touch ◀ (left side)/▶ (right side) of  on the Touch Menu to display Touch Function icons. (→ 20)





2 Touch the Touch Function icon.

(e.g. AF/AE tracking)

- To cancel, touch the Touch Function icon again. (Optical Image Stabilizer Lock is cancelled by releasing the finger touching .)



Touch function icons

	Image Stabilizer Function
	AF/AE tracking
	Optical Image Stabilizer Lock ^{*1}
	Touch Shutter ^{*2}

*1 In Motion Picture Recording Mode only

*2 In Still Picture Recording Mode only

Use the Image Stabilizer to reduce the effects of shake during recording.

This unit is equipped with Hybrid Optical Image Stabilizer.

Hybrid Optical Image Stabilizer is a hybrid of Optical and Electrical Image Stabilizer.

Touch to switch the Image Stabilizer on/off.

- The icon at position **A** is switched.



(Motion Picture Recording Mode)

/ → (setting cancelled)

- When [HYBRID O.I.S.] is [ON], is displayed. When [OFF], is displayed.
- When recording with a tripod in Motion Picture Recording Mode, we recommend that you set the Image Stabilizer (off).

(Still Picture Recording Mode)

1 / 2 → (setting cancelled)

- When [O.I.S.] is [MODE1], 1 is displayed. When [O.I.S.] is [MODE2], 2 is displayed.

■ Changing Image Stabilizer Mode

(Motion Picture Recording Mode)

MENU : [RECORD SETUP] → [HYBRID O.I.S.] → [ON] or [OFF]

When set to [ON], you can further improve image stabilization for recording while walking, or holding the unit and recording a distant subject with zoom.

- This function's default setting is [ON].

(Still Picture Recording Mode)

MENU : [RECORD SETUP] → [O.I.S.] → [MODE1] or [MODE2]

[MODE1]: The function works all the time.

[MODE2]: The function works when the button is pressed. We recommend using this mode when you are recording yourself or recording with a tripod in Still Picture Recording Mode.



It is possible to set the focus and exposure to the subject specified on the touch screen. The focus and exposure will keep following the subject automatically even if it moves.

1 Touch

- An icon is displayed

2 Touch the object and lock the target.

- When you touch the head of the object, the target frame on the head gets locked and tracking starts.
- Touch the object to be changed again when you want to change the target.
- When the Intelligent Auto Mode or Intelligent Auto Plus Mode is selected, the setting becomes (Normal) and touched object is tracked. Selection becomes / (Portrait) when target frame is locked on a face. (It may turn to (Normal) even if the target is locked on the face when a spotlight is shining or with a dark scene.)

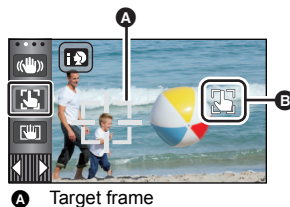

A Target frame

3 Start recording.

■ About target frame

- When target lock fails, the target frame blinks in red and then disappears. Touch a characteristic part (colour etc.) on the object to lock onto it again.
 - When the button is pressed halfway in Still Picture Recording Mode, the focus is set to the object that is locked. The target frame turns green when it focuses, and the target cannot be changed.
-
- This function cannot be used in Manual Mode. In Still Picture Recording Mode, it can only be used with some settings in Scene Mode.
 - It may track different objects or may not lock the target depending on the recording conditions such as the following:
 - When the object is too large or too small
 - When colour of the object is similar to the background
 - When the scene is dark
 - When the target is locked in Still Picture Recording Mode, the screen may become dark or the AF assist lamp may be performed. (→ 82)
 - If you use the Fade function while the target is locked, the target lock will be cancelled. (→ 66)
 - AF/AE tracking will be cancelled in the following cases.
 - When the unit is turned off
 - Press the recording/playback button
 - Touch the recording mode switching icon
 - Touch the Recording Mode button icon
 - Switch to recording of yourself



Optical Image Stabilizer Lock



This function enhances optical image stabilization. You can further reduce the effects of the shake that tends to occur when using zoom.

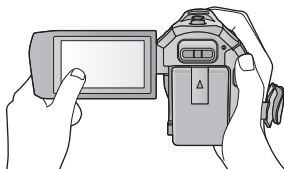
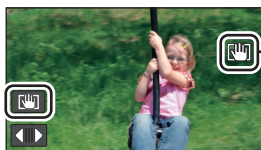

- 1 Touch to turn the Image Stabilizer on. (→ 61)
- 2 Select the menu.

MENU : [RECORD SETUP] → [O.I.S. LOCK SETTING] → desired setting

[AUTO]: Operates Activates Optical Image Stabilizer Lock automatically. The LOCK icon is displayed in the position **A** of the LCD monitor.

[MANUAL]: Operates Optical Image Stabilizer Lock while is touched and held.

- The default setting is [AUTO]. When [AUTO] is set, is not displayed in the Touch Menu.

- 3 (When [MANUAL] is selected)
Touch and hold .

- Icon is displayed in **A** while you are touching and holding .
- Optical Image Stabilizer Lock is released when you remove your finger from the icon.

■ To make the display of disappear

When [MANUAL] is set, stays displayed even if it is left unused. To hide the display, change the [O.I.S. LOCK DISPLAY] setting.

MENU : [SETUP] → [O.I.S. LOCK DISPLAY] → desired setting

[ON]: Constantly display.

[OFF]: The icon will disappear after approx. 5 seconds without any touch operation.

- Stabilization may not be possible under strong shaking conditions.
- To record while moving the unit quickly, release Optical Image Stabilizer Lock.

It is possible to focus and record a still picture of a subject that is touched.

1 Touch .

- An icon is displayed **A**.

2 Touch the subject.

- Focus area is displayed at the touched position, and a still picture is recorded.



-
- Depending on the recording conditions or recognition of the touched position, it may not be possible to record the intended picture.
 - This will not operate for recording yourself.

Recording functions of operation icons

Select the operation icons to add different effects to the images to be recorded.

1 Touch ◀ (left side)/▶ (right side) of  on the Touch Menu to display the operation icons. (→ 20)

2 Touch an operation icon.

(e.g. PRE-REC)

• The operation icons that are displayed in the Touch Menu can be changed. ([SELECT OPERATION ICONS]: → 35)

• Select the operation icon again to cancel the function.

Refer to the respective pages for cancelling the following functions.

– Self-timer (→ 67)

– Guidelines (→ 67)







– Video light (→ 68)





– Night Mode (→ 68)

• The icon is displayed when the operation icon is set.



Operation icons

	Fade ^{*1}
	Intelligent Contrast Control ^{*1}
	PRE-REC ^{*1}
	Self-timer ^{*2}
	Intelligent Exposure ^{*2}
	Backlight Compensation

	Guidelines
	Video light
	Night Mode ^{*1}
HDR	HDR Effect ^{*1, 3}
	Headphone volume adjustment/ Microphone level adjustment ^{*4}

*1 Not displayed in Still Picture Recording Mode.

*2 Not displayed in Motion Picture Recording Mode.

*3 It is displayed only when you set the Recording Mode to HDR Movie Mode. (→ 51)

*4 It is displayed only when a headphone is connected to the headphone output terminal. [MIC LEVEL] (→ 79) is set to anything other than [AUTO],  is displayed as the operation icon, and adjustment of input level of the microphone is possible.

• If you turn off the unit or press the Recording/Playback button, PRE-REC, Self-timer, Backlight Compensation and Night Mode functions are cancelled.

• If you turn off the unit, the Fade function is cancelled.

• It is possible to set from the menu. (Except for the Headphone volume adjustment)

Fade



When you start recording, the image/audio gradually appears. (Fade in)

When you pause recording, the image/audio gradually disappears. (Fade out)

- The Fade setting is cancelled when the recording stops.

■ To select the colour for fade in/out

 : [RECORD SETUP] → [FADE COLOUR] → [WHITE] or [BLACK]

(Fade in)



(Fade out)



- The thumbnails of scenes recorded using fade in become black (or white).

Intelligent Contrast Control



This brightens parts that are in shadow and difficult to see and suppresses white saturation in bright parts at the same time. Both bright and dark parts can be recorded clearly.



- If there are extremely dark or bright parts or the brightness is insufficient, the effect may not be clear.

PRE-REC

This prevents you from missing a shot.



This allows recording of the pictures and sound to start approximately 3 seconds before the recording start/stop button is pressed.

-  appears on the screen.
- **Aim the unit at the subject beforehand.**
- There is no beep sound.
- PRE-REC is cancelled in the following cases.
 - Press the recording/playback button
 - Touch the recording mode switching icon
 - If you remove the SD card
 - If you touch 
 - If you press the Wi-Fi button
 - If you turn the unit off
 - If you start recording
 - After 3 hours have passed
- After setting PRE-REC, if recording starts in less than 3 seconds, motion pictures taken 3 seconds before pressing the recording start/stop button cannot be recorded.
- Images displayed on the thumbnail in Playback Mode will differ from the motion pictures displayed at the start of playback.





Self-timer



This is for recording still pictures using the timer.

Each time the icon is selected, the indication changes by one setting in the following order:

☺10 (Records after 10 seconds) → ☺2 (Records after 2 seconds) → setting cancelled

- When you press the  button, ☺10 or ☺2 flashes for the set period before a still picture is recorded. After recording, the Self-timer is cancelled.
- In Auto Focus Mode, if the  button is pressed halfway once and then fully, the lens focuses on the subject when the button is pressed halfway. If the  button is pressed fully all at once, the lens focuses on the subject just before recording.

To stop the timer midway through

Touch [CANCEL].

-
- Setting the Self-timer to ☺2 is a good way to prevent image shake when the  button is pressed while using a tripod etc.



Intelligent Exposure



This brightens dark areas so the image can be recorded clearly.

-
- If there are extremely dark parts or the brightness is insufficient, the effect may not be clear.



Backlight Compensation



This makes the image brighter to prevent darkening of a backlit subject.





Guidelines



You can check if the image is level while recording motion pictures and still pictures. The function can also be used to estimate the balance of the composition.

It will switch every time the icon is touched.

 →  →  → Setting cancelled

- The guidelines do not appear on the images actually recorded.



Video light





It is possible to record with illumination even in dark places.

Each time the icon is selected, the indication changes by one setting in the following order.

In motion picture recording mode:

 ([ON]) →  (AUTO) →  ([OFF])



In still picture recording mode:

 ([ON]) →  ([OFF])

: Always on.

: Turns on/off automatically according to brightness of the surroundings.

: Cancel the setting.

- When the battery is low and the light cannot be lit, the  will be displayed on the screen.
- When set to , the video light turns on in Low Light Mode in Intelligent Auto Mode.
- When the video light is in use, the recordable time when using the battery is shortened.
- When the battery level is low, the video light may turn off or may not turn on.
- Do not use with Filter Kit (optional) or Conversion Lens (optional) attached.
- The (approximate) available range of the video light is approximately up to 1.2 m.
- Using the Night Mode function at the same time will make conditions even brighter.

Night Mode



You can record images even in very low light situations (minimum required illumination: approx. 1 lx) or in the dark.

- **Recorded scene is seen as if frames were missed.**
- If set in a bright place, the screen may become washed out for a while.
- Bright dots that are usually invisible may be seen, but this is not a malfunction.
- Using a tripod is recommended.
- In darker areas, Auto Focus may focus a bit slower. This is normal.

HDR HDR Effect



You can change the level of image contrast correction in HDR Movie Mode. (→ 51)

The icon changes each time you touch it.

HDR (Low) → HDR (High)

HDR (Low): Sets the correction level to low.

HDR (High): Sets the correction level to high.

- You cannot change the level of this effect when recording a motion picture or during PRE-REC.
- You may not see the full effect depending on the recording conditions.



Headphone volume adjustment



Adjust the volume of the headphone while recording.

- : Increase the volume
- : Decrease the volume

- Actual volume to be recorded does not change.



Recording functions of menu

[SCENE MODE]













This function is identical to Scene Mode in Recording Mode. (→ 45)

The shutter speed and aperture, etc. are automatically adjusted to match the scene you want to record.

- This item is displayed in the menu only when [Time Lapse Rec] in Creative Control Mode is set. (→ 50)

 : [RECORD SETUP] → [SCENE MODE] → desired setting

[OFF]:	Cancel the setting
 Sports:	To make fast moving scenes less shaky with slow playback and pause of playback
 Portrait:	To make people stand out against the background
 Soft Skin:	To makes skin colours appear softer for a more attractive appearance
 Spotlight:	Improved quality when subject is brightly illuminated
 Snow:	Improved image quality when shooting in snowy locations
 Beach:	To make blue in the sea or sky vibrant
 Sunset:	To make red in the sunrise or sunset vibrant
 Scenery:	For spatial scenery
 Fireworks:	To capture the fireworks in the night sky beautifully
 Night Scenery:	To capture the evening or night scenery beautifully
 Low Light:	For dark scenes, such as at dusk

- Please refer to page 52 for details about the effect of each mode.

[ZOOM MODE]



Set the maximum zoom ratio for the Motion Picture Recording Mode.

[MENU] : **[RECORD SETUP]** → **[ZOOM MODE]** → **desired setting**

(For the **V785**)

[Opt.Zoom 20×]:	Optical zoom only (Up to 20×)
[i.Zoom 50×]:	This zoom function allows you to maintain high-definition picture quality. (Up to 50×)
[D.Zoom 60×]:	Digital zoom (Up to 60×)
[D.Zoom 1500×]:	Digital zoom (Up to 1500×)

(For the **V787**)

[Opt.Zoom 20×]:	Optical zoom only (Up to 20×)
[i.Zoom 50×]:	This zoom function allows you to maintain high-definition picture quality. (Up to 50×)
[D.Zoom 60×]:	Digital zoom (Up to 60×)
[D.Zoom 250×]:	Digital zoom (Up to 250×)

- The larger the digital zoom magnification, the more the image quality is degraded.
- This function cannot be used in Still Picture Recording Mode.

[REC FORMAT]



Switch the recording format of motion picture.

[MENU] : **[RECORD SETUP]** → **[REC FORMAT]** → **desired setting**

[AVCHD]:	Set the recording format to AVCHD. (→ 2)
[MP4/iFrame]:	Set the recording format to MP4/iFrame. (→ 2)

- This function's default setting is [AVCHD] mode.



Switch the picture quality and recording format of the motion pictures to record. The recording formats that can be set change according to [REC FORMAT] setting.

: [RECORD SETUP] → [REC MODE] → desired setting

● When [REC FORMAT] is set to [AVCHD]

[PH]/[HA]/[HG]/[HE]: Set the recording format to 1080/50i.

(A ←→ B)

[1080/50p]^{*1}: Set the recording format to 1080/50p.

A Favours image quality

B Favours Recording time

● When [REC FORMAT] is set to [MP4/iFrame]

[1080/50M]^{*2}: Set the recording format to 1080/50p (50 Mbps).

[1080/28M]^{*2}: Set the recording format to 1080/50p (28 Mbps).

[720]^{*2}: Set the recording format to 720/25p.

[iFrame]^{*3}: Set the recording format to iFrame.

*1 You can record motion pictures in 1080/50p (1920×1080/50 progressive), the best AVCHD picture quality for this unit.

*2 [1080/50M]/[1080/28M] and [720] are recording modes suitable for playing back or editing on a PC.

*3 [iFrame] is a format suitable for Mac (iMovie etc.). It is recommended for when using a Mac.

- Please refer to page 13 for details about recordable time using the battery.
- Use an SD card conforming to Class 10 of the SD Speed Class Rating when you want to record motion pictures to the SD card using the setting [1080/50M].
- This function's default setting is [HG] mode.
- Please refer to page 195 for details about approximate recordable time.
- When the unit is moved a lot or moved quickly, or when a fast-moving subject is recorded, mosaic-type noise may appear at playback.

Detected faces appear with frames.

 : [RECORD SETUP] → [FACE FRAMING] → desired setting

[PRIMARY]:

Only the prioritised face framing is displayed.

[ALL]:

All face detection framings are displayed.

[OFF]:

Cancel the setting.

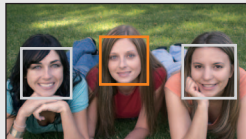

- Up to 5 frames are indicated. Larger faces and faces nearer to the centre of the screen take preference over others.

■ Prioritised face framing

Prioritised face framing is displayed as orange frames. Focus and adjustment of brightness will be performed against the prioritised face framing.

- The prioritised face frame is displayed only with Portrait Mode in Intelligent Auto Mode or Intelligent Auto Plus Mode.
- The white frame is for face detection only.
- Focus will be set to prioritised face framing when the  button is pressed halfway when recording still pictures. Prioritised face framing will turn to green when the focus is set.

-
- Faces are not detected in HDR Movie Mode. ([→ 51](#))

[LEVEL GAUGE]



This function displays the horizontal/vertical tilt of the unit with the electronic level.

MENU : [RECORD SETUP] → [LEVEL GAUGE] → [ON]

■ To correct the tilt

(Horizontal direction)

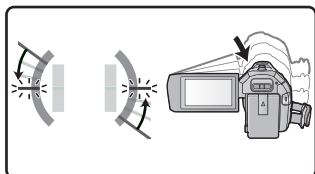

When correcting the leftward tilt

(Vertical direction)

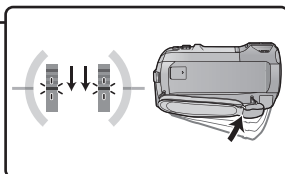

When correcting the downward tilt

- The horizontal tilt display **A** and vertical tilt display **B** appear yellow when there is a tilt, and appear green when there is almost no tilt.
- The maximum tilt display angles are approximately 45° in horizontal direction and 10° in vertical direction.
- The electronic level does not affect the actual recorded images.

- The electronic level is not displayed when recording yourself or the LCD monitor is closed with the screen facing outward.
- Even when the tilt is in the corrected state, an error of approximately 1° may occur.
- In the following cases, the electronic level may not be displayed correctly:
 - When moving this unit
 - When pointing this unit up or down at an angle closer to perpendicular

[AGS]



If the unit continues to be tilted upside down from the normal horizontal position while recording motion pictures, it is automatically put into recording pause.

MENU : [RECORD SETUP] → [AGS] → [ON]

- The AGS function may activate and cause the unit to pause the recording if you are recording a subject right above or right below you.

[AUTO SLOW SHTR]



You can record bright pictures even in dark places by slowing the shutter speed.

- **Switch to Manual Mode.** (→ 56)

: [RECORD SETUP] → [AUTO SLOW SHTR] → [ON]

- The shutter speed is set to 1/25 or more depending on the surrounding brightness.
- This function cannot be used in Still Picture Recording Mode.
- When the shutter speed becomes 1/25, the screen may be seen as if frames are missed and afterimages may appear.

[Digital Cinema Colour]



Recording motion pictures with more vivid colours, using x.v.Colour™ technology.

- **Switch to Manual Mode.** (→ 56)
- **Set [REC FORMAT] to [AVCHD].** (→ 71)

: [RECORD SETUP] → [Digital Cinema Colour] → [ON]

- For more realistic colours, use an HDMI micro cable (supplied) with a TV that supports the x.v.Colour™.
- **When motion pictures recorded while this function is turned [ON] are played back with a TV not compatible with x.v.Colour™, colours may not be reproduced properly.**
- When these images are played back with devices other than ones compatible with x.v.Colour™, it is recommended to record the images after this function is turned [OFF].
- x.v.Colour™ is a name for devices that are compatible with the xvYCC format, an international standard for expanded colour in motion pictures, and that follow the rules for signal transmission.

[SHOOTING GUIDE]



Message is displayed when this unit is moved rapidly.

: [RECORD SETUP] → [SHOOTING GUIDE] → [ON]

When "CAMERA PANNING IS TOO FAST." appears, move the unit slowly while recording.

- Message will not appear while pausing the recording. (Message will appear even if it is pausing the recording if [DEMO MODE] is set to [ON].)

[WIDE CONV. LENS SET]



This will change the setting of the Image Stabilizer function and Maximum zoom ratio to the one appropriate for the recording when a Wide Conversion Lens (optional) is attached to this unit.

: [RECORD SETUP] → [WIDE CONV. LENS SET] → [ON]

- The following functions will not work:
 - Video light
 - AF ASSIST LAMP
- In Motion Picture Recording Mode, [ZOOM MODE] (→ 71) is fixed to [Opt.Zoom 10×] (up to 10×). In Still Picture Recording Mode, a zoom magnification of up to 10× is possible.

[Wind Noise Canceller]



This will reduce the wind noise coming into the built-in microphones while maintaining the realism.

- **Switch to Manual Mode.** (→ 56)

: [RECORD SETUP] → [Wind Noise Canceller] → desired setting

[Strong]:	When a strong wind is detected, this option effectively reduces the wind noise by minimising the low-pitched sound.
[Normal]:	This option extracts and reduces only the wind noise without deteriorating the sound quality.
[OFF]:	Cancel the setting.

- When [Strong] is set, you can check how effectively the wind noise is reduced with the icon displayed on the screen. In descending order of the strength of the reduction effect, / / is displayed.
 - When [Normal] is set, will be displayed on the screen.
-
- This function's default setting is [Normal].
 - When switching to Intelligent Auto Mode or Intelligent Auto Plus Mode, [Wind Noise Canceller] is set to [Strong], and the setting cannot be changed.
 - You may not see the full effect depending on the recording conditions.
 - This function cannot be set when using an external microphone.

[LOWCUT]



This function reduces the low-pitched sound when using an external microphone.

- **Switch to Manual Mode.** (→ 56)

: [RECORD SETUP] → [LOWCUT] → [ON]

- This function can be set only when using an external microphone.

[Sound Scene Select]



You can set the built-in microphone's sound quality as appropriate for the scene you want to record.

- Set [MIC SETUP] to [SURROUND] or [STEREO MIC]. (→ 78)

1 Select the menu.

[MENU] : [RECORD SETUP] → [Sound Scene Select] → desired setting

[Auto]:	Records sounds with standard settings.
[Music]:	For recording scenes in which you need to cover a wide sound range and a wide volume range, such as music concerts.
[Speech]:	For recording speeches, talk sessions, and other events in which sounds will be coming mostly from the front of this unit.
[Nature]:	For recording in serene environments, such as forests and rivers.
[Festival]:	For recording festivals, fireworks displays, and other very loud scenes.
[Customize]:	Allows you to adjust [Microphone Gain], [Frequency Response] and [Directional].

2 (When [Customize] is selected)

Select the desired item.

[Microphone Gain]:	Select this item when the sound recorded in a loud scene is distorted.
[Frequency Response]:	Adjusts the high frequency range and low frequency range levels.
[Directional]:	Select [SURROUND]/[STEREO] or [MONO].

3 (When [Microphone Gain] is selected in Step 2)

Select an item.

[Normal]:	Adjusts the sound quality automatically.
[Attenuate]:	Records sounds of very loud scenes at appropriate volume.

(When [Frequency Response] is selected in Step 2)

Touch / to adjust.

- Before recording, check the effect you have selected with a headphone set, etc.
- The high frequency range (dB) and low frequency range (dB) can be adjusted.
- If noises such as the sound caused by the wind bother you, set the low frequency range to [LowCut].
- To end the adjustment, touch [EXIT].

(When [Directional] is selected in Step 2)

Select an item.

- [SURROUND]/[STEREO]:** Records sounds with the setting of [MIC SETUP] ([SURROUND] or [STEREO MIC]).
- [MONO]:** Records sounds from all directions without setting specific directivity.

4 Touch [EXIT].

-  appears on the screen.

- Depending on the recording condition or sound quality, the desired effect may not be achieved.
- The option is set to [Auto] when an external microphone is connected.
- **(When [Music] or [Festival] is set)**
The volume of the recorded sounds may be lower than that of the sounds recorded with [Auto].
- **(When [Speech] or [Nature] is set)**
Sounds recorded with these effects are less realistic than those recorded with [SURROUND] or [STEREO MIC] in [MIC SETUP].

[5.1ch/2ch]



You can switch the channel number setting of the built-in microphone.

 : [RECORD SETUP] → [5.1ch/2ch] → desired setting

- [5.1ch]:** Records with the 5.1ch.
- [2ch]:** Records with the 2ch.

- The option is set to [2ch] when an external microphone is connected.

[MIC SETUP]



Recording setting of the built-in microphone can be adjusted.

 : [RECORD SETUP] → [MIC SETUP] → desired setting

- [SURROUND]*1:** Records the surrounding sound with added realism.
- [ZOOM MIC]:** Sound is recorded with changing the directionality in conjunction with the zoom operation. Sounds near the front of the unit are recorded more clearly if you zoom in (close-up) and surrounding sounds are recorded more realistically if you zoom out (wide angle).
- [FOCUS MIC]*1:** The forward sound is recorded more clearly by enhancing the directionality toward the centre.
- [STEREO MIC]*2:** Records sound from two forward directions.

*1 The option is displayed only when [5.1ch/2ch] is set to [5.1ch].

*2 The option is displayed only when [5.1ch/2ch] is set to [2ch].

- If you wish to record higher quality sound and maintain realism even when zooming in, for instance, when recording a music recital, we recommend setting [MIC SETUP] to [SURROUND].
- [STEREO MIC] will be selected in the following cases:
 - When [REC FORMAT] is set to [MP4/iFrame]
- When [Directional] in [Customize] in [Sound Scene Select] is set to [MONO], [SURROUND] and [STEREO MIC] cannot be set. (If you set [MONO], [SURROUND] and [STEREO MIC] will be switched to [ZOOM MIC])

[MIC LEVEL]



When recording, the input level from the built-in microphones and the external microphone terminal can be adjusted.

1 Select the menu.

[MENU] : [RECORD SETUP] → [MIC LEVEL] → desired setting

[AUTO]:	AGC is activated, and the recording level is adjusted automatically.
[SET]:	The desired recording level can be set. AGC is activated, and sound distortions are reduced.
[SET]:	The desired recording level can be set. Sounds are recorded in natural quality.

2 (When [SET]/[SET] is selected)

Touch / to adjust.

- The adjustment screen to be displayed depends on the setting of [5.1ch/2ch].
- Adjust the microphone input level so that the last 2 bars of the gain value are not red. (Otherwise, the sound is distorted.) Select a lower setting for microphone input level.

3 Touch [ENTER].

- Touch [EXIT] to complete the setting.

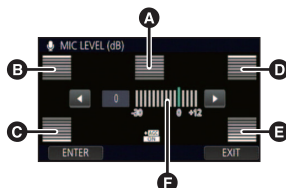

(When set to [5.1ch])

- A** Centre
- B** Front left
- C** Back left
- D** Front right
- E** Back right
- F** Microphone input level

- When [MIC SETUP] is [ZOOM MIC], the volume will be different depending on the zoom rate.
- The sound will be recorded in stereo (2ch) when [5.1ch/2ch] is set to [2ch] or an external microphone is input.
- (microphone input level meter) is displayed on the screen when [5.1ch/2ch] is set to [5.1ch], and (microphone input level meter) is displayed when [5.1ch/2ch] is set to [2ch] and [MIC LEVEL] is set to a setting other than [AUTO].
- You cannot record with the audio completely muted.

Adjust the quality of the image while recording.

Adjust by outputting to a TV while adjusting the quality of the image.

- This setting is retained when you change between Motion Picture Recording Mode and Still Picture Recording Mode.
- Switch to Manual Mode. (→ 56)

1 Select the menu.

MENU : [RECORD SETUP] → [PICTURE ADJUST]

2 Touch the desired setting items.

[SHARPNESS]:	Sharpness of the edge
[COLOUR]:	Depth of the colour of the image
[EXPOSURE]:	Brightness of the image
[WB ADJUST]:	Picture colour balance

3 Touch ◀/▶ to adjust settings.

4 Touch [ENTER].

- Touch [EXIT] to complete the settings.
- appears on the screen.

■ Adjusting the picture quality with the Multi Manual Dial

1 Push the Multi Manual Dial.

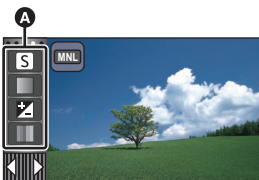
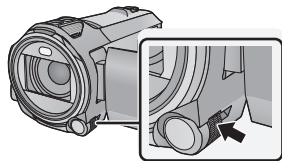

- A Picture quality adjustment icon
- S [SHARPNESS]
 - [COLOUR]
 - + [EXPOSURE]
 - [WB ADJUST]

- When an item on the picture quality adjustment icon or the manual icon (→ 56) is not selected, each time you push the Multi Manual Dial, the picture quality adjustment icon and the manual icon are displayed alternately. Display the picture quality adjustment icon.

2 Rotate the Multi Manual Dial to select an item.

3 Push the Multi Manual Dial to set.



4 Rotate the Multi Manual Dial to adjust the setting.

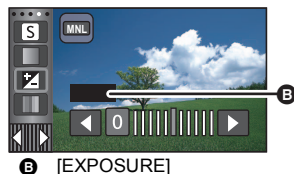

5 Push the Multi Manual Dial to set.

-  appears on the screen.

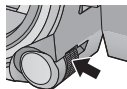

[PICTURE SIZE]



The higher the number of pixels, the higher the clarity of the picture when printing.

MENU : [PICTURE] → [PICTURE SIZE] → desired setting

- The number of recording pixels that can be set changes depending on selected screen aspect ratio. (→ 82)

Picture size and Maximum zoom ratio in Still Picture Recording Mode

Picture size		Aspect ratio	Extra Optical Zoom (→ 41)
18M	4896×3672	4:3	—*
8M	3264×2448		—*
0.3M	640×480		50×
20M	5472×3648	3:2	—*
10.6M	3984×2656		—*
2M	1728×1152		31.2×
24M	6528×3672	16:9	—*
12.6M	4736×2664		—*
2.1M	1920×1080		30×

* Extra Optical Zoom cannot be used. The maximum zoom magnification is 20×.

Picture size in Motion Picture Recording Mode

- Set this unit to Motion Picture Recording Mode (→ 18)

MENU : [PICTURE] → [PICTURE SIZE] → desired setting

Picture size		Aspect ratio
12.6M	4736×2664	16:9
2.1M	1920×1080	

- The default setting is **24M** in Still Picture Recording Mode and **12.6M** in Motion Picture Recording Mode.
- The recording will become longer depending on the recording pixels.
- Please refer to page 196 for details about the number of recordable pictures.

[ASPECT RATIO]



This allows you to select the aspect ratio of the pictures to suit printing or the playback method.

: [PICTURE] → [ASPECT RATIO] → desired setting

[4:3]: Aspect ratio of 4:3 television

[3:2]: Aspect ratio of conventional film camera or prints (such as L-size print)

[16:9]: Aspect ratio of high-definition television, etc.

- This function's default setting is [16:9].
- When the aspect ratio is set to [4:3] or [3:2], black bands may appear on the left and right of the screen.
- The edges of still pictures recorded on this unit with a [16:9] aspect ratio may be cut at printing. Check the printer or photo studio before printing.

[AF ASSIST LAMP]



The video light is turned on to make it easier to focus when you are recording in dark places where it is hard to focus.

- **Switch to Manual Mode.** (→ 56)

: [PICTURE] → [AF ASSIST LAMP] → [AUTO]

- When switching to Intelligent Auto Mode or Intelligent Auto Plus Mode, the setting is fixed to [AUTO] and cannot be changed.
- This setting is not available when video light is set to (ON).

[SHTR SOUND]



You can add a shutter sound when recording still pictures.

: [PICTURE] → [SHTR SOUND] → desired setting

: Volume low

: Volume high

[OFF]: Cancel the setting.











- No shutter sound is emitted in Motion Picture Recording Mode.





Playback Operations

Motion picture playback using operation icon



For details on the basic playback operations, refer to page 27.

Playback operation	Playback display	Operating steps
Skip playback (to the start of a scene)	During Playback    	Touch the LCD monitor and slide from right to left (from left to right) during playback.
Slow-motion Playback	During Pause    	<p>With the playback paused, continue touching . ( is for slow rewind playback) Playback is slow while touching.</p> <ul style="list-style-type: none"> • Normal playback is restored when you touch . • When Slow-motion pictures are played back in reverse, they will be shown continuously at approximately 2/3rd the speed of normal playback (intervals of 0.5 seconds). • When scenes recorded with MP4 [1080/50M], [1080/28M], [720] or scenes saved in MP4 (1920×1080/25p) are played back in reverse slow-motion, they will be shown in intervals of 0.5 seconds. • When iFrame scenes and scenes saved in MP4 (640×360/25p) are played back in reverse slow-motion, they will be shown in intervals of 1 second. • Slow-motion Playback of parts recorded as FULL HD Slow Motion Video will be shown at the intervals of 0.25 second.

Playback operation	Playback display	Operating steps
<p>Frame-by-frame Playback</p>	<p>During Pause</p> 	<p>With the playback paused, touch . (Touch  to advance the frames one at a time in the reverse direction.)</p> <ul style="list-style-type: none"> • Normal playback is restored when you touch . • When the frames are advanced one at a time in the reverse direction, they will be shown in intervals of 0.5 seconds. • When the frames of scenes recorded with MP4 [1080/50M], [1080/28M], [720] or scenes saved in MP4 (1920×1080/25p) are advanced one at a time in the reverse direction, they will be shown in intervals of 0.5 seconds. • When the frames of iFrame scenes and scenes saved in MP4 (640×360/25p) are advanced one at a time in the reverse direction, they will be shown in intervals of 1 second. • When the frames of parts recorded as FULL HD Slow Motion Video are advanced one at a time in the reverse direction, they will be shown in intervals of 0.25 seconds.
<p>Direct playback</p>		<p>Touch the direct playback bar or slide it while touching.</p> <ul style="list-style-type: none"> • The playback pauses temporarily and skips to the position touched or slid to while touching. • (When you touch the bar or slide it while touching during playback) Playback will start by releasing your touching or sliding finger.

Creating still picture from motion picture



A single frame from the recorded motion picture can be saved as a still picture.

Scene type	Picture size
AVCHD scenes Scenes recorded as Backup for Twin Camera Scenes recorded in the recording format [MP4/iFrame] Scenes saved in MP4 (1920×1080/25p) Scenes saved in MP4 (1280×720/25p)	2.1M (1920×1080)
Scenes saved in MP4 (640×360/25p)	0.2M (640×360)

Press the  button fully at the location to be saved as a still picture during playback.

- It is convenient to use Pause, Slow-motion Playback and Frame-by-frame Playback.
- Date the motion picture was recorded will be registered as date of the still picture.
- Quality will be different from the normal still picture.



Highlight & Time Frame Index



An image of one scene is displayed as a thumbnail at set search condition. Scene can be played back from any midway point of the scene you wish to see.

- Operate the zoom lever to  side and change over the thumbnail display to Highlight & Time Frame Index. (→ 29)

1 Touch .

- To display the next (previous) page:
 - Slide the thumbnail display upward (downward) while touching it.
 - Touch  (up) /  (down) on the thumbnail scroll lever. (→ 28)

2 Touch the desired search condition.

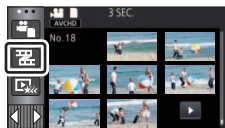

[3 SEC.]/[6 SEC.]/[12 SEC.]/[MINUTES]/[FACE]*/[HIGHLIGHT]*

- * Cannot be set while playing back MP4/iFrame scenes or scenes recorded as Backup for Twin Camera.
- When select [FACE], it will select the portion for which Face Recognition was performed from the scenes judged to be clearly recorded. This will then be displayed as a thumbnail.
- A portion judged to be clearly recorded will be detected and displayed in thumbnail if you select [HIGHLIGHT].

3 (When [MINUTES] is selected)

Touch ▲ / ▼ to set the time.

- It can be set up to a maximum of 60 minutes.
- Touch [ENTER].

4 Touch the thumbnail to be played back.

- Next (Previous) thumbnail can be displayed by touching ◀ / ▶.

Repeat Playback



Playback of the first scene starts after playback of the last scene finishes.

MENU : [VIDEO SETUP] → [REPEAT PLAY] → [ON]

The  indication appears on the full screen views.

- All the scenes are played back repeatedly. (When playing back motion pictures by date, all the scenes on the selected date are played back repeatedly.)

Resuming the previous playback



If playback of a scene was stopped halfway, the playback can be resumed from where it was stopped.

MENU : [VIDEO SETUP] → [RESUME PLAY] → [ON]

If playback of a motion picture is stopped,  appears on the thumbnail view of the stopped scene.

- The memorised resume position is cleared if you turn off the unit or press the recording/playback button.
(The setting of [RESUME PLAY] does not change.)

Setting the playback speed of FULL HD Slow Motion Video



You can set the speed at which this unit will play back parts recorded as FULL HD Slow Motion Video.

- Touch the play mode select icon, and select [ALL MP4/iFrame] or [1080/50p] in [MP4/iFrame].

MENU : [VIDEO SETUP] → [SLOW PLAY SPEED] → desired setting

[Super Slow]: Plays back at 1/4 normal speed.

[Slow]: Plays back at 1/2 normal speed.

- If you play back the parts on another device, they will be played back at 1/2 normal speed. To play them back at 1/4 normal speed, perform [Slow Speed Conversion] (→ 112).
- Once you perform [Slow Speed Conversion] on the scenes, the parts will be played back at 1/4 normal speed.

Zooming in on a still picture during playback (Playback zoom)



You can zoom in by touching a still picture during playback.

1 Touch and hold the part you wish to zoom in on during still picture playback.

- It will display enlarged in order of normal display (×1) → ×2 → ×4. Touch and hold the screen to zoom in from the normal display (×1) to ×2. Touch the screen to zoom in from ×2 to ×4.
- The still picture is zoomed in on, centring on the part you touched.

2 Move to the zoomed in position by touching / / / or slide while touching the screen.

- The location of the zoom displays for about 1 second when zooming in (zooming out) or moving the displayed location.

Zooming out from the zoomed still picture

Touch  to zoom out. (×4 → ×2 → ×1)

- Touch  to return to normal playback (×1).

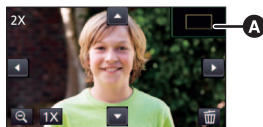

- **A** Displayed location of the zoom

- You can also perform zoom operations using the zoom lever.
- The more picture is enlarged, the more its quality deteriorates.

Various playback functions

Playing back motion pictures/still pictures by date



The scenes or the still pictures recorded on the same day can be played back in succession.

1 Touch the date select icon. (→ 20)



A Date select icon









2 Touch the playback date.

The scenes or the still pictures recorded on the date selected are displayed as thumbnails.

3 Touch the scene or the still picture to be played back.

- If you press the recording/playback button to switch between Recording Mode and Playback Mode, the [VIEW ALL] screen will be displayed again.
- In cases such as those described below, scenes and still pictures are grouped separately on the date list, and -1, -2... may be added after the date:
 - When the number of scenes exceeds 99
 - When the number of still pictures exceeds 999
 - When [REC MODE] in [AVCHD] is changed
 - When the microphone input sound (5.1ch/2ch) is changed
 - When recorded in Creative Control Mode.
 - When the [ON]/[OFF] setting of Backup for Twin Camera is switched (→ 43)
 - When saved in Manual Edit (→ 99)
 - When [NUMBER RESET] is performed

- The following scenes and still pictures are grouped separately on the date list, and icons are displayed according to the category:

Scene or still picture	Icon to be displayed
Scenes recorded with [1080/50p] in [AVCHD]	
Scenes recorded with [1080/50M]/[1080/28M] in [MP4/iFrame]	
Scenes recorded with [720] in [MP4/iFrame] Scenes saved in MP4 (1280×720/25p) (→ 111)	
Scenes recorded with [iFrame] in [MP4/iFrame]	
Still pictures recorded in Stop Motion Animation Assist Mode (→ 55)	
Still pictures created from motion pictures	
Scenes saved in Highlight Playback (→ 95)	
Scenes saved in MP4 (640×360/25p) (→ 111)	

Highlight Playback



Part that was recognised as clearly recorded is extracted from multiple scenes, and it can be played back or stored in a short time with effects and music added.

It is also possible to create an original Highlight Playback by checking your favourite scenes and setting up to extract those scenes.

1 Touch . (→ 20)

2 (When [ALL MP4/iFrame] is selected)
Touch the recording format of the scene to be played back.



[1080/50p]/[720/25p]

3 Touch the desired effect.

[POP]:	Recommended for party scene.
[NATURAL]:	Recommended for scenery.
[CLASSICAL]:	Recommended for slow moving scene.
[DYNAMIC]:	Recommended for fast moving scene such as sports scene.
[CUSTOM]:	Set the combination of the effect and the music. (→ 91)

- The scenes matching the effect will be extracted and displayed in the thumbnail view.
- Effects such as fade, slow-motion, still (pause), or digest playback are inserted.
- The date at playback is the date that was last recorded in an extracted scene.
- To change the settings, refer to page 92.

4 Touch  in the thumbnail view.

5 Select the playback operation. (→ 28)

- When the playback is finished or stopped, the screen to select [REPLAY], [SAVE] (→ 95), [SELECT AGAIN] or [EXIT] is displayed. Touch the desired item.

- Skip Playback, Slow-motion Playback, Frame-by-frame Playback and Direct Playback are not possible.
- **Highlight Playback is not available for the following scenes :**
 - iFrame scenes
 - Scenes recorded with Creative Control (→ 48), HDR Movie Mode (→ 51) and FULL HD Slow Motion Video Mode (→ 53)
 - Scenes recorded as Backup for Twin Camera
 - Highlight Playback scenes saved in MP4 format
 - Scenes that were converted to MP4 scenes and copied (with the MP4 conversion function) (→ 111)

■ Setting up the custom effect

It is possible to enjoy the Highlight Playback with your favourite effect by setting up the combination of an image effect and music.

- 1 Touch **[CUSTOM]**.
- 2 Touch **[EFFECT SETUP]** or **[MUSIC SELECT]**.

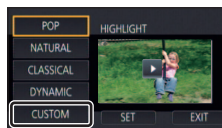

- 3 (When [EFFECT SETUP] is selected)

Touch the desired effect.

- When [EFFECT SETUP] is changed, [MUSIC SELECT] will be set the same as [EFFECT SETUP]. (To set [EFFECT SETUP] and [MUSIC SELECT] to different settings, change [MUSIC SELECT] after setting [EFFECT SETUP].)

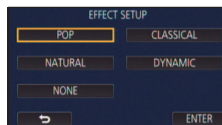

(When [MUSIC SELECT] is selected)

Touch the desired sound.

- When [EFFECT SETUP] is set to [NONE], you will be able to select [NO MUSIC]. When [NO MUSIC] is selected, the audio recorded at the time of shooting is played back.
- [USER BGM] lets you use the music stored on your smartphone. To set [USER BGM], use the Wi-Fi function [Remote Ctrl] and create Highlight Playback from the smartphone app "Image App". The music data will be saved in this unit as [USER BGM].
- Only one track can be saved in this unit as music data for [USER BGM]. Each time you create Highlight Playback using the "Image App", music data will be replaced.
- For information on the file format and playback time of music data that can be used as [USER BGM], refer to the "Image App".
- To delete the music data saved as [USER BGM] in this unit, perform [DELETE USER BGM].
(→ 37)

(To test the music audio)

Touch [START].

- Touch the other music option to change the music to be tested.
- When you touch [STOP], the music playback stops.

- 4 Touch **[ENTER]**.

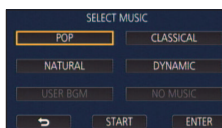

Playing back with the settings changed

Touch [SET] to select the item to change.

[SCENE SETUP]*1:

Select the scene or date to be played back.

[FAVOURITE SCENE SETUP]*2:

Set up the favourite scenes. (→ 93)

[FAVOURITE SCENE PLAY]*2:

Set up if the favourite scenes are to be included in the Highlight Playback or not. (→ 93)

[PRIORITY SETUP]:

Select the target to give priority to play back. (→ 93)

[PLAYBACK TIME]:

Select the time to play back. (→ 94)

[TITLE SETUP]:

Select the title sheet to be displayed at the beginning, and enter the title. (→ 94)

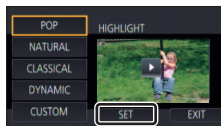

- *1 If you touch [SET] of Highlight Playback when the Baby Calendar is displayed, [SELECT DATE] and [SELECT SCENES] will not be available. (→ 100)
- *2 If you touch [SET] of Highlight Playback when the Baby Calendar is displayed, these items will not be displayed. (→ 100)
- When you have finished changing the settings, touch [EXIT].

■ Scene setting

- 1 (Only when Highlight Playback is started from [ALL AVCHD])

Touch the recording format of the scene to be played back.

[1080/50p]/[1080/50i]

- 2 Touch [SELECT DATE] or [SELECT SCENES].

- 3 (When [SELECT DATE] is selected)

Touch the date to be played back.

- A maximum of 7 days can be selected.
- When touched, the date is selected and surrounded by red. Touch the date again to cancel the operation.

(When [SELECT SCENES] is selected)

Touch the scenes to be played back.



- Up to 99 scenes can be selected in succession.
- When touched, the scene is selected and ✓ is displayed. Touch the scene again to cancel the operation.

- 4 Touch [Enter]/[ENTER].

■ Checking the favourite scenes

1 Touch the scenes to be played back.

2 Touch [Add] and add the favourite part.

- Approximately 4 seconds before and after touching [Add] will be added as favourite.
- Number of favourite scenes that can be added are 1 to 14.
(Number of scenes that can be added differs depending on the scenes selected.)
- Favourite check display  (A) is displayed in orange, and favourite check display  (B) is displayed on the slide bar.
- To cancel the favourite, play back to the position checked as favourite, and touch [Cancel].
- It is convenient to use Slow-motion Playback and Frame-by-frame Playback. (→ 83, 84)

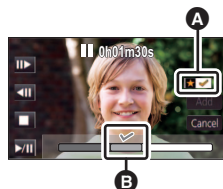

3 Touch and stop the playback.

- It will return to the thumbnail display screen and  is displayed on the scenes added as favourite scenes.

4 Touch [Return].

- All the scenes checked as favourite may not be played back depending on the playback time setting. (→ 94)

To clear the favourite scenes from the thumbnail display

1 Touch [Reset].

2 Touch [RESET ALL] or [RESET SELECTED].

- The check on all the favourite scenes will be cleared when [RESET ALL] is selected.

3 (When [RESET SELECTED] is selected in Step 2) Touch the scene to be cleared.

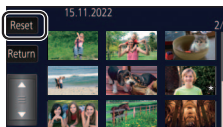

■ Playing back the favourite scenes

Touch [ON] or [OFF].

[ON]:	Include the scenes added in the [FAVOURITE SCENE SETUP] into the Highlight Playback.
[OFF]:	Do not include the scenes added in the [FAVOURITE SCENE SETUP] into the Highlight Playback.

■ Priority settings

Touch [NONE] or [FACE].

- If you touch [FACE], priority is given to the part detected as a face.

■ Playback time setting

Touch the playback time.

[APPROX 90 SEC.]/[APPROX 3 MIN.]/[AUTO]

- The playback time of [AUTO] is a maximum of approx. 5 minutes.
- Playback time may become shorter than the setting, or it may not even be played back if the part recognised as clearly recorded is short.

■ Setting up the title

1 Touch  /  to select your favourite title sheet.

[NONE]/[PICTURE 1]/[PICTURE 2]/[PICTURE 3]/[PICTURE 4]

- Title and date will not be displayed when [NONE] is selected.

2 Touch [TITLE].

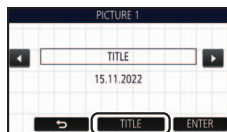

3 Enter the title.

- Touch the text entry icon in the centre of the screen and enter the title.
- After entering the title, touch [Enter].





A

A Text entry icon

Entering text

- The characters can be conveniently input without moving the cursor when the [Auto Cursor Position] is set to [ON]. (→ 37)

Icon	Description of operation
[A] etc.	Enters a character.
 / 	Moves the cursor to left or right.
[A/a/1]	Switches between [A]/[a] (alphabet) and [&/1] (symbols/numbers).
	Enters a space.
[Delete]	Deletes a character. Deletes the previous character if the cursor is in an empty space.
[Enter]	Ends text entry.

- A maximum of 18 characters can be entered.

4 Touch [ENTER] to end registration.

- The date of the first scene of the Highlight Playback will be displayed as the date.

- The entered title will be cleared when the unit is turned off or the Highlight Playback is finished.

Saving the Highlight Playback

The scenes put together as a Highlight Playback can be saved as a single scene.
The recorded scenes can be saved in the SD card.

- 1 Stop the playback of the Highlight Playback or wait until the Highlight Playback is finished.**
- 2 Touch [SAVE].**
- 3 Select the format to save.**

[AVCHD 1920×1080/50i]*1:	It will be saved in high-definition image quality.
[MP4 1920×1080/25p]*2, 3:	It will be saved in high-definition image quality. The format supports playback on a PC.
[MP4 1280×720/25p]:	It will be saved with an image quality, allowing you to upload it on the Internet in higher image quality. The format supports playback on a PC.
[MP4 640×360/25p]:	It will be saved with an image quality, allowing you to upload it on the Internet faster. The format supports playback on a PC.

*1 This format is displayed only when an AVCHD scene is selected.

*2 This format is not displayed when an AVCHD scene is selected.

*3 [MP4 1920×1080/25p] cannot be selected when an MP4 [720/25p] scene is selected.

(When [AVCHD 1920×1080/50i] is selected)

- Scenes recorded in 1080/50p are converted to 1080/50i (picture quality [HA] of [REC MODE]) and saved.
- Scenes recorded in 1080/50i are recorded in [HA] regardless of [REC MODE] ([PH]/[HA]/[HG]/[HE]) of a scene.

- 4 Touch [YES].**
- 5 Touch [EXIT].**

-
-  is displayed on the thumbnail of the scenes saved by the Highlight Playback.

Manual Edit



You can join desired AVCHD scenes, scenes recorded as Backup for Twin Camera or parts of these scenes in the order they were recorded to play back or save as a single scene with music added.

- **Manual Edit cannot be used for MP4/iFrame scenes.**

1 Select the menu.

 : [EDIT SCENE] → [MANUAL EDIT]

2 Touch [1080/50p] or [1080/50i].

- Touch [Enter].
- Thumbnails are displayed by each scene.

3 Select the scene or part of the scene to play back, and set the music.

- To select a scene (→ 97)
- To select part of a scene (→ 97)
- To set the music (→ 98)
- Touching [Return] after selecting a scene may cancel the selected scene.

4 Touch [Enter].

5 Touch [YES], and select the playback operation for the edited scene. (→ 28)

- In the following cases, the screen for selecting [PREVIEW], [SAVE] (→ 99), [SELECT AGAIN], and [EXIT] is displayed. Touch the desired item.
 - Touch [NO]
 - Playback finishes
 - Stop playback

-
- You can also select combinations of scenes and parts of scenes.
 - You can select up to 99 scenes. (Each 3 second thumbnail of part of a scene is treated as a single scene.)
 - You can create a combined scene of up to about 6 hours long.
 - Skip Playback, Slow-motion Playback, Frame-by-frame Playback and Direct Playback are not possible.

- When saving a manually edited scene, check the free space on the SD card.
Before selecting the scene, check the table below and create sufficient free space for saving it.



(Approximate free space requirements for saving a manually edited scene)

Saving format	Total time of an edited scene	Free space required
[AVCHD 1920×1080/50i]	30 min	Approx. 4 GB
	1 h	Approx. 8 GB
[MP4 1280×720/25p]	30 min	Approx. 2 GB
	1 h	Approx. 4 GB
[MP4 640×360/25p]	30 min	Approx. 0.4 GB
	1 h	Approx. 0.8 GB

- “h” is an abbreviation for hour, “min” for minute and “s” for second.

■ To select a scene

Touch the scene to be played back.

- The scene selection is made as you touch it, and the indication appears on the thumbnail. To cancel the operation, touch the scene again.
- When part of a scene has been selected, the 3S indication appears on the thumbnail. If you touch the thumbnail, the scene will be displayed by 3 second thumbnails.
- Next (previous) page is displayed by touching  / .

■ To select part of a scene

1 Touch [3 sec].



- To cancel the operation, touch it again.

2 Touch the desired scene.

- The touched scene is displayed by 3 second thumbnails.

3 (To select a single thumbnail)

Touch the thumbnail of the part you want to play back.

- The thumbnail selection is made as you touch it, and the indication (white) appears on the thumbnail. To cancel the selection, touch the thumbnail again.
- Next (previous) thumbnail is displayed by touching  / .
- Touching [Return] when the thumbnail has been selected returns you to the screen that displays the thumbnails of scenes. The 3S indication appears on the thumbnail of the scene containing the selected part.

4 (To select thumbnails by specifying a range)

Touch [Range].

- To cancel the operation, touch it again.

5 (To select thumbnails by specifying a range)

Touch the range (start and finish points) you want to play back.

- The range between start and finish points are selected, and the indication (white) appears on the thumbnails.
- To cancel the selected thumbnails, from among the thumbnails with the indication (white), touch the range (start and finish points) you want to cancel.
- If you touch [Enter]/[Return]/[Music]/[Range] when a start point has been selected, the start point thumbnail will be cancelled.
- Touching [Return] when the thumbnail has been selected returns you to the screen that displays the thumbnails of scenes. The 3S indication appears on the thumbnail of the scene containing the selected part.
- You can also select multiple ranges within the same scene.
- Next (previous) thumbnail is displayed by touching / .
- To select other scenes, touch [Return] to return to the screen that displays the thumbnails of scenes, and perform the following operations.
 - When selecting a scene:
Touch the desired scene.
 - When selecting part of a scene:
Perform the operations in Steps 1-5.



- A** Start point
- B** Finish point

■ To set the music

1 Touch [Music].

2 Touch the desired sound.

- When [NO MUSIC] is selected, the audio recorded at the time of shooting is played back.
- [USER BGM] lets you use the music stored on your smartphone. To set [USER BGM], use the Wi-Fi function [Remote Ctrl] and create Highlight Playback from the smartphone app "Image App". The music data will be saved in this unit as [USER BGM].
- Only one track can be saved in this unit as music data for [USER BGM]. Each time you create Highlight Playback using the "Image App", music data will be replaced.
- For information on the file format and playback time of music data that can be used as [USER BGM], refer to the "Image App".
- To delete the music data saved as [USER BGM] in this unit, perform [DELETE USER BGM]. (→ 37)

(To test the music audio)

Touch [START].

- Touch the other music option to change the music to be tested.
- When you touch [STOP], the music playback stops.

3 Touch [ENTER].

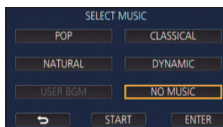

■ To save a manually-edited scene

You can save manually edited scenes as a single scene.

The recorded scenes can be saved in the SD card.

- 1 **Stop the playback of a manually-edited scene or wait until the playback is finished.**
- 2 **Touch [SAVE].**
- 3 **Select the format to save.**

[AVCHD 1920×1080/50i]:	It will be saved in high-definition image quality.
[MP4 1280×720/25p]:	It will be saved with an image quality, allowing you to upload it on the Internet in higher image quality. The format supports playback on a PC.
[MP4 640×360/25p]:	It will be saved with an image quality, allowing you to upload it on the Internet faster. The format supports playback on a PC.

(When [AVCHD 1920×1080/50i] is selected)

- Scenes recorded in 1080/50p are converted to 1080/50i (picture quality [HA] of [REC MODE]) and saved.
 - Scenes recorded in 1080/50i are recorded in [HA] regardless of [REC MODE] ([PH]/[HA]/[HG]/[HE]) of a scene.
- 4 **Touch [YES].**
 - If you are using the battery, a message recommending that you use the AC adaptor will be displayed. To start the saving operation, touch [START].
- 5 **Touch [EXIT].**

-
- You can save scenes even when using the battery, but we recommend that you use the AC adaptor.
 - Manually-edited scenes recorded as Backup for Twin Camera will be saved as normal AVCHD or MP4 scenes.
 - For information on the approximate free space requirements for saving a manually edited scene, refer to page 97.

Baby Calendar



When a baby's birthday and name are registered, scenes recorded since the baby's birthday are displayed as thumbnails for each age in months.

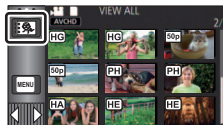

- You cannot select scenes recorded as Backup for Twin Camera.
- Scenes recorded before the birthday are not displayed.
- Scenes with no baby in them are also displayed.
- You can register up to 3 babies.

1 Touch .



2 (When registering for the first time)

Enter the baby's birthday.



- Touch the date to be set, then set the desired value using  / .
- The year can be set between 2000 and 2039.
- Touch [Enter].

3 (When registering for the first time)

Touch [YES], and enter the baby's name.

- If you touch [NO], the Baby Calendar will be displayed without the baby's name registered. ([Baby 1] is displayed.)
- Input method is same operation as for setting up the title. (→ 94)
- After entering the name, touch [Enter].
- A maximum of 9 characters can be entered.

4 Check the Baby Calendar.

- The name of the registered baby and its age in months are displayed.
- You can switch the age in months display by touching  / .

: Changes the age in months display to that of the previous month

If you touch this icon when the youngest age in months is displayed, the oldest age in months will be displayed.

: Changes the age in months display to that of the next month

If you touch this icon when the oldest age in months is displayed, the youngest age in months will be displayed.

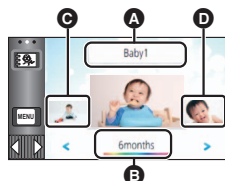

- A** Name display
- B** Age in months display
- C** Thumbnail for the previous age in months
- D** Thumbnail for the next age in months

- Except for months with no recordings, the age in months display is available for each month.
- If you touch the name display, the screen for selecting a registered baby is displayed. From among the 3 registered babies, select the baby you want to display, and touch [ENTER]. If you touch a name with no registered birthday ([Baby 1]/[Baby 2]/[Baby 3]), you can register a new baby. Perform step 2-3.

5 Touch the thumbnail in the centre.

- The thumbnails of the scenes recorded in the same age in months are displayed. Touch the desired scene to select the playback operation. (→ 28)
- The thumbnail display cannot be set to 1 scene/20 scenes display or to the Highlight & Time Frame Index.
- You cannot perform Highlight Playback if the number of scenes exceeds 99.
- Touching  returns you to the screen that lets you select the age in months.

To return to the normal thumbnail display

Touch the  while the Baby Calendar is displayed.

To change/add a baby's registered details

- 1 Touch the name display on the Baby Calendar (→ 100) or select the menu.

 : [VIDEO SETUP] → [Baby Calendar Setup]

- 2 Touch the name of the baby whose details are to be changed.

- When [Baby 1]/[Baby 2]/[Baby 3] is displayed, the birthday and name or name only are not registered.

- 3 Touch the desired item.

Name:	Register/change the name.
Birthday:	Register/change the birthday.

- The setting method is the same as when registering for the first time. (→ 100)

- 4 Touch [ENTER].

- The Baby Calendar of the registered baby is displayed.

To delete a baby's registered details

- 1 Touch the name display on the Baby Calendar (→ 100) or select the menu.

 : [VIDEO SETUP] → [Baby Calendar Setup]

- 2 Touch the name of the baby whose details are to be deleted.

- 3 Touch [DELETE].

- To delete the registered details of other babies, repeat Steps 2 to 3.

-
- When the Baby Calendar is displayed, the following operations are not available:
 - [SCENE PROTECT]
 - [SECTION DELETE]
 - [DIVIDE]
 - [MANUAL EDIT]
 - [SPLIT&DELETE]
 - [CONVERT TO MP4]
 - [Slow Speed Conversion]

Changing the playback settings and playing back the slide show



1 Touch . (→ 20)

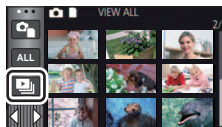

2 (Only when you would like to change the settings) Touch [SET] to select the item to change.

[DATE SETUP]:	Select the date to be played back.
[SLIDES INTERVAL]*:	Select the interval between still pictures at playback.
[EFFECT SETUP]*:	Select the effect for playback.
[MUSIC SELECT]:	Select the music to be played on playback.

* Setting is not possible when the operation in Step 1 is performed while thumbnails in the Stop Motion Animation Assist Mode are displayed. (→ 104)

3 (When [DATE SETUP] is selected) Touch the playback date.

(When [SLIDES INTERVAL] is selected)
Touch the interval of playback for the slide show.

[SHORT]:	Approx. 1 second
[NORMAL]:	Approx. 5 seconds
[LONG]:	Approx. 15 seconds

(When [EFFECT SETUP] is selected)
Touch the desired effect.

- Touch [ENTER].
- When [EFFECT SETUP] is changed, [MUSIC SELECT] will be set the same as [EFFECT SETUP]. (To set [EFFECT SETUP] and [MUSIC SELECT] to different settings, change [MUSIC SELECT] after setting [EFFECT SETUP].)
- [SLIDES INTERVAL] cannot be set, when [EFFECT SETUP] is set.

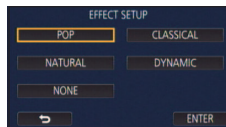

(When [MUSIC SELECT] is selected)

Touch the desired sound.

- Touch [ENTER].
- [USER BGM] lets you use the music stored on your smartphone. To set [USER BGM], use the Wi-Fi function [Remote Ctrl] and create Highlight Playback from the smartphone app "Image App". The music data will be saved in this unit as [USER BGM].
- Only one track can be saved in this unit as music data for [USER BGM]. Each time you create Highlight Playback using the "Image App", music data will be replaced.
- For information on the file format and playback time of music data that can be used as [USER BGM], refer to the "Image App".
- To delete the music data saved as [USER BGM] in this unit, perform [DELETE USER BGM]. (→ 37)

(To test the music audio)

Touch [START] and start the audio testing.

- Touch the other music option to change the music to be tested.
- When you touch [STOP], the music playback stops.

4 Touch [START].

5 Select the playback operation. (→ 28)

- When the playback is finished or stopped, the screen to select [REPLAY], [SELECT AGAIN] or [EXIT] is displayed. Touch the desired item.

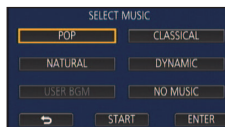

Playing back still pictures recorded in Stop Motion Animation Assist Mode as a slide show



- For details on recording in Stop Motion Animation Assist Mode, refer to page 55.

1 Touch .

- The recording group created most recently in Stop Motion Animation Assist Mode is displayed.
- Touching  again, returns the display to the normal thumbnail display.

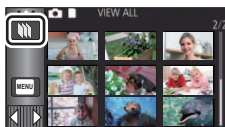

2 Touch a thumbnail to play back the slide show.

- The thumbnail display cannot be set to 9 scenes or 20 scenes display.

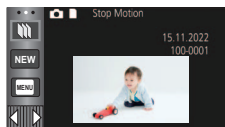

3 Select the playback operation. (→ 28)

- The display returns to the thumbnail display when playback is finished or stopped.

To play back other recording groups:

You can play back other recording groups by touching the date select icon.

1 Touch the date select icon.

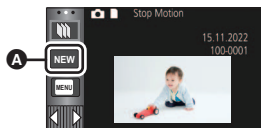

A Date select icon

2 Touch the playback date.

- Touch a date with the  indication.
- Recording groups in the selected date are displayed.
- Touch a thumbnail to play back the slide show.

-
- Slide shows can be played back with settings changed. (→ 102)
 - The recording group played back as a slideshow cannot be saved as a single scene.

Deleting scenes/still pictures

Deleted scenes/still pictures cannot be restored, so perform appropriate confirmation of the contents before proceeding with deletion.

◇ Press the recording/playback button to switch this unit to the Playback Mode.

■ To delete the scene or still picture being played back

Touch  while scenes or still pictures to be deleted are being played back.



■ To delete scenes or still pictures from the thumbnail display

● Switch to the thumbnail display of the scenes or still pictures to delete. (→ 27)

1 Touch . (→ 20)

- When the thumbnail display is 1 scene display or Highlight & Time Frame Index, the scene or still picture being displayed is deleted.
- When the thumbnails of still pictures recorded in Stop Motion Animation Assist Mode are displayed, the still pictures cannot be deleted. (→ 104)

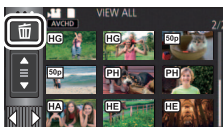

2 Touch [ALL SCENES], [MULTI] or [SINGLE].

- All the scenes or still pictures displayed as thumbnails will be deleted by selecting [ALL SCENES].
(In case of playing back scenes or still pictures by date, all the scenes or still pictures on the selected date will be deleted.)
- Protected scenes/still pictures cannot be deleted.

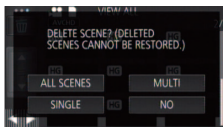

3 (When [MULTI] is selected in Step 2)

Touch the scene/still picture to be deleted.

- When touched, the scene/still picture is selected and the  indication appears on the thumbnail. Touch the scene/still picture again to cancel the operation.
- Up to 99 scenes can be selected to be deleted.

(When [SINGLE] is selected in Step 2)

Touch the scene/still picture to be deleted.

4 (When [MULTI] is selected in Step 2)

Touch [Delete].

- To continuously delete other scenes/still pictures, repeat Steps 3-4.

When you stop deleting halfway:

Touch [CANCEL] while deleting.

- The scenes or still pictures that have already been deleted when the deletion is cancelled cannot be restored.

To complete editing:

Touch [Return].

-
- You can also delete scenes by touching , selecting [EDIT SCENE] → [DELETE] → [ALL SCENES], [MULTI] or [SINGLE].

- You can also delete still pictures by touching , selecting [PHOTO SETUP] → [DELETE] → [ALL SCENES], [MULTI] or [SINGLE].

When the thumbnails of still pictures recorded in Stop Motion Animation Assist Mode are displayed, the still pictures cannot be deleted from the menu. (→ 104)

- During Highlight Playback, scenes/still pictures cannot be deleted.
- Scenes that cannot be played back (the thumbnails are displayed as ) cannot be deleted.
- In case of [ALL SCENES], the deletion may take time if there are many scenes or still pictures.
- If you delete scenes recorded on other products or still pictures conforming to DCF standard with this unit, all the data related to the scenes/still pictures may be deleted.
- When still pictures recorded on an SD card by other products are deleted, a still picture (other than JPEG) that cannot be played back on this unit, may be erased.

Deleting part of a scene (AVCHD/Backup for Twin Camera)



Unnecessary part of an AVCHD scene or a scene recorded as Backup for Twin Camera can be deleted.

The deleted scenes cannot be restored.

- Press the recording/playback button to switch this unit to the Playback Mode, and touch the play mode select icon. Then, select the AVCHD scene or a scene recorded as Backup for Twin Camera. (→ 27)

1 Select the menu.

[MENU] : [EDIT SCENE] → [SECTION DELETE]

2 Touch the scene with a part to delete.

3 Set the section to delete by touching and sliding the top and bottom section selection buttons .

- It is convenient to use Slow-motion Playback and Frame-by-frame Playback. (→ 83, 84)



4 Touch [ENTER].

5 Confirm (play back) the scene after editing by touching [YES].

- A confirmation message appears when [NO] is touched. Proceed to Step 7.

6 Stop the playback.

- A confirmation message appears.

7 Touch [ENTER].

- Repeat Steps 2-7 to continuously delete parts from other scenes.

To complete editing

Touch [Return].

- Deleting a part of a scene cannot be performed when there are 99 scenes in a single date.
- It may not be possible to delete part of a scene with a short recording time.
- The scene will be divided into two scenes when the middle part of a scene is deleted.

Dividing a scene (AVCHD/Backup for Twin Camera)



It is possible to divide an AVCHD scene or a scene recorded as Backup for Twin Camera. Any unwanted parts in the scene can be deleted after dividing.

- Press the recording/playback button to switch this unit to the Playback Mode, and touch the play mode select icon. Then select an AVCHD scene or a scene recorded as Backup for Twin Camera. (→ 27)

1 Select the menu.

MENU : [EDIT SCENE] → [DIVIDE] → [SET]

2 Touch and play back the scene you want to divide.

- It is convenient to use Slow-motion Playback and Frame-by-frame Playback. (→ 83, 84)

3 Touch to set the dividing point.

- Touch [YES].
- Touch [YES] to continue dividing the same scene. To continue dividing other scenes, touch [NO] and repeat Steps 2-3.



4 Touch [Return] to complete dividing.

- Unwanted parts can be deleted. (→ 105)

To delete all the divided points

MENU : [EDIT SCENE] → [DIVIDE] → [CANCEL ALL]

- The scenes that were deleted after division cannot be recovered.
- You cannot divide a scene if the number of scenes of a given date would exceed 99 scenes.
- It may not be possible to divide scenes with a short recording time.
- Data that has been recorded or edited on another device cannot be divided and the divided points cannot be deleted.

Dividing a scene to partially delete (MP4/iFrame)



Divide the MP4/iFrame scenes, and delete unnecessary parts.

This divides the recorded scenes in two and deletes the front half or back half.

The scenes deleted by dividing cannot be restored.

- Press the recording/playback button to switch this unit to the Playback Mode, and touch the play mode select icon. Then, select the MP4/iFrame scene. (→ 27)

1 Select the menu.

 : [EDIT SCENE] → [SPLIT&DELETE]

2 Touch and play back the scene you want to divide.

- It is convenient to use Slow-motion Playback and Frame-by-frame Playback. (→ 83, 84)

3 Touch to set the dividing point.

- Set the dividing point so there will be 2 seconds or more for the part for deletion, and 3 seconds or more for the part to be kept.

4 Touch the part for deletion.

5 Touch [YES] and confirm (play back) the part for deletion.

- A confirmation message appears when [NO] is touched. Proceed to Step 7.

6 Stop the playback.

- A confirmation message appears.

7 Touch [YES].

- To continue dividing and deleting other scenes, repeat Steps 2-7.



To complete editing

Touch [Return].

- It may not be possible to divide scenes with a short recording time.
- The actual division may slightly slip off the previously designated dividing point.

Protecting scenes/still pictures



Scenes/still pictures can be protected so that they are not deleted by mistake.

(Even if you protect some scenes/still pictures, formatting the media will delete them.)

- Press the recording/playback button to switch this unit to the Playback Mode.

1 Select the menu.

 : [VIDEO SETUP] or [PHOTO SETUP] → [SCENE PROTECT]

2 Touch the scene/still picture to be protected.

- When touched, the scene/still picture is selected and the  indication appears on the thumbnail. Touch the scene/still picture again to cancel the operation.
 - Touch [Return] to complete the settings.
-
- When the thumbnails of still pictures recorded in Stop Motion Animation Assist Mode are displayed, protection cannot be set on the still pictures.

Convert to MP4



You can convert and copy AVCHD scenes, scenes recorded as Backup for Twin Camera, and MP4 scenes. The image quality will be converted into a format that supports playback on a PC and online sharing (MP4 (1280×720/25p) or MP4 (640×360/25p)).

- Scenes recorded in iFrame or saved as MP4 (640×360/25p) cannot be converted to MP4.

1 Select the menu.

 : [EDIT SCENE] → [CONVERT TO MP4]

2 Touch the scene you want to convert.

- The scene selection is made as you touch it, and the  indication appears on the thumbnail. To cancel the operation, touch the scene again.
- You can select up to 99 scenes in succession.

3 Touch [Enter].

4 Select the quality after conversion.

[HD(1280×720/25p)]* : Convert to MP4 (1280×720/25p) and copy.

[VGA(640×360/25p)] : Convert to MP4 (640×360/25p) and copy.

* You cannot convert and copy MP4 [720/25p] scenes.

- MP4 scenes after conversion are saved to the same media as the scenes before conversion.

5 Touch [YES].

- To continue converting scenes to MP4, repeat steps 2 to 5.

To stop converting to MP4 halfway

Touch [CANCEL] during format conversion.

To exit the MP4 conversion

Touch [Return].

- A scene recorded over a long time may take time.
- When the following scenes are converted to MP4 scenes and copied, those exceeding 4 GB (approx.) or 30 minutes (approx.) will be automatically divided:
 - Scenes recorded with [1080/50M] in [MP4/iFrame]
 - AVCHD scenes
 - Scenes recorded as Backup for Twin Camera
- If you convert protected scenes to MP4, their protection will be cleared after the conversion.
- Scenes recorded as Backup for Twin Camera will be saved as normal MP4 scenes when converted to MP4 scenes and copied.

Slow speed conversion



You can convert the playback speed of parts recorded in FULL HD Slow Motion Video Mode (→ 53) to 1/4 normal speed, and copy them.

Once converting scenes recorded in FULL HD Slow Motion Video Mode, you can play them back on another device at 1/4 normal speed.

- Press the recording/playback button to switch this unit to the Playback Mode.
- Touch the play mode select icon, and select [ALL MP4/iFrame] or [1080/50p] in [MP4/iFrame].

1 Select the menu.

[MENU] : [EDIT SCENE] → [Slow Speed Conversion]

2 Touch a scene recorded in FULL HD Slow Motion Video Mode.

- On the thumbnail screen in Playback Mode, scenes recorded as FULL HD Slow Motion Video are displayed with the  indication.
- The scene selection is made as you touch it, and the ✓ indication appears on the thumbnail. To cancel the operation, touch the scene again.
- Up to 99 scenes can be selected in succession.

3 Touch [Enter].

- The converted scene will be saved in the same medium as the one storing the original scene.
- A message asking whether to delete the original scene will be displayed. To delete the scene, select [YES]. To keep it, select [NO].

To cancel the slow speed conversion or the deletion of the original scene midway

During the conversion or deletion, touch [CANCEL].

To exit the slow speed conversion

Touch [Return].

-
- When a converted scene is recorded in a medium, the scene becomes larger in size than the original one. The converted scene may be divided depending on its size.
 - It may take a while to convert a long scene.
 - If you perform [Slow Speed Conversion] on protected scenes, their protection will be cleared after the conversion.

Watching Video/Pictures on your TV



Confirm the terminals on your TV and use a cable compatible with the terminals. Image quality may vary with the connected terminals.

- A** High quality
- 1** HDMI terminal
- 2** Video terminal



- Use the HDMI micro cable (supplied).
- HDMI is the interface for digital devices. If you connect this unit to a HDMI compatible high-definition TV and then play back the recorded high-definition images, you can enjoy them in high resolution with high quality sound.

1 Connect this unit to a TV.

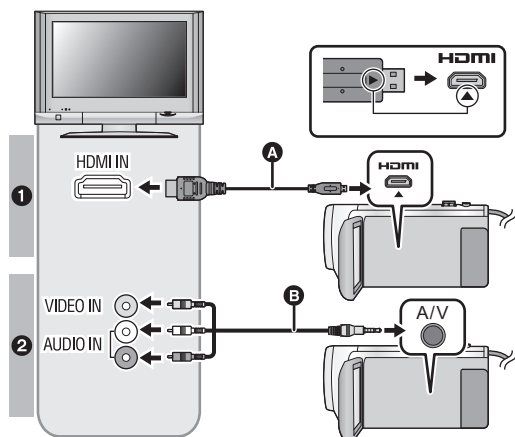

- A** HDMI micro cable (supplied)
- Be sure to connect to the HDMI terminal. (Insert the connector with the arrow side facing down.)
- Connecting with a HDMI micro cable (→ 115)
- Listening in 5.1 channel sound (AVCHD) (→ 115)
- Playback using VIERA Link (→ 116)
- B** AV cable (commercially-available)

Picture quality

- 1** High-definition images when connecting to HDMI terminal
- 2** Standard images when connecting to video terminal

- Check that the plugs are inserted as far as they go.
- Do not use any other HDMI micro cable except the supplied one.

2 Select the video input on the TV.

- Example:
Select the [HDMI] channel with a HDMI micro cable.
Select the [Video 2] channel with an AV cable.
(The name of the channel may differ depending on the connected TV.)
- Check the input setting (input switch) and the audio input setting on the TV. (For more information, please read the operating instructions for the TV.)

3 Change the mode to to play back.



- When this unit and the TV are connected with the HDMI micro cable (supplied) or an AV cable (commercially-available) in any of the following situations, no image will be displayed on the TV. Use the LCD monitor of this unit.
 - When recording a motion picture in HDR Movie Mode or during PRE-REC
 - When [HDMI RESOLUTION] is set to [576p] in HDR Movie Mode
 - FULL HD Slow Motion Video Mode
 - When recording a motion picture with [Backup for Twin Camera] set to [ON] or during PRE-REC
 - When saving the Highlight Playback scene or a manually edited scene
 - When performing [CONVERT TO MP4]/performing [Slow Speed Conversion]
 - If you connect this unit to the TV when this unit is set to Recording Mode, a squealing sound*¹ may be output. Before connecting this unit, set it to Playback Mode.
- *¹ The microphone may pick up the sound from the speakers, producing an abnormal sound.
- When connected to the TV, sound in Playback Mode is not output from this unit. Also, since the volume cannot be adjusted with this unit, adjust the volume of the TV.
 - Some screens, such as the menu screen, may be displayed in reduced sizes on the TV.
 - Image and audio is not output from this unit while using the Wi-Fi function.

■ To watch images on a regular TV (4:3) or when both sides of the images do not appear on the screen

Change the menu setting to display the images correctly. (Check the TV setting.)

[MENU] : [SETUP] → [TV ASPECT] → [4:3]

Example of images with a [16:9] aspect ratio on a regular TV (4:3)

[TV ASPECT] setting	
[16:9]	[4:3]
	

- If a wide-screen TV is connected, adjust the aspect setting on the TV. (Refer to the operating instructions of the TV for details.)

■ To display the on-screen information on the TV

When the menu setting is changed, the information displayed on the screen (operation icon and time code etc.) can be displayed/not displayed on the TV.

[MENU] : [SETUP] → [EXT. DISPLAY] → desired setting

[SIMPLE]^{*2}:	Information partially displayed
[DETAIL]:	Detailed information displayed
[OFF]:	Not displayed

- *² This setting is only available in Motion Picture Recording Mode or Still Picture Recording Mode.

Connecting with a HDMI micro cable

Select the desired method of HDMI output.

 : [SETUP] → [HDMI RESOLUTION] → [AUTO]/[1080p]/[1080i]/[576p]

- [AUTO] determines the output resolution automatically based on information from the connected TV.
If the images are not output on the TV when the setting is [AUTO], switch to the method [1080p], [1080i] or [576p] which enables the images to be displayed on your TV. (Please read the operating instructions for the TV.)
- Images may not be displayed on the television for several seconds in some cases, such as when changing between scenes.

Listening in 5.1 channel sound (AVCHD)

You still can listen to the 5.1 channel sound recorded from the internal microphones when this unit is connected to the 5.1 channel compatible AV amplifier or TV using the HDMI micro cable. Please read the AV amplifier and TV operating instructions for how to connect this unit to the AV amplifier and TV.

- If you connect this unit to a Panasonic AV amplifier that are compatible with VIERA Link, linked operations (VIERA Link) become possible. (→ [116](#))
- Audio recorded when [5.1ch/2ch] is set to [2ch] or recorded from an external microphone is in stereo (2ch).

Playback using VIERA Link



What is the VIERA Link (HDAVI Control™)?

- This function allows you to use your remote control for the Panasonic TV for easy operations when this unit has been connected to a VIERA Link compatible device using a HDMI micro cable (supplied) for automatic linked operations. (Not all operations are possible.)
- VIERA Link is a unique Panasonic function built on a HDMI control function using the standard HDMI CEC (Consumer Electronics Control) specification. Linked operations with HDMI CEC compatible devices made by other companies are not guaranteed.
When using devices made by other companies that are compatible with VIERA Link, refer to the operating instructions for the respective devices.
- This unit supports "VIERA Link Ver.5" function. "VIERA Link Ver.5" is the standard for Panasonic's VIERA Link compatible equipment. This standard is compatible with Panasonic's conventional VIERA Link equipment.

◇ Press the recording/playback button to switch this unit to the Playback Mode.

1 Select the menu.

 : [SETUP] → [VIERA Link] → [ON]

- If you are not using VIERA Link, set to [OFF].

2 Connect this unit to a Panasonic TV compatible with VIERA Link with a HDMI micro cable. (→ 113)

- It is recommended to connect this unit to an HDMI terminal other than the HDMI1 if there are 2 or more HDMI input terminals on the TV.
- VIERA Link must be activated on the connected TV. (Read the operating instructions of the TV for how to set etc.)

3 Operate with the remote control for the TV.

- You can select the scene or picture you want to play back by pressing the button up, down, left or right, and then the button in the centre.

(When selecting scenes)

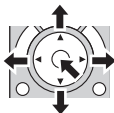

(When playing back)

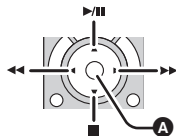

A Display/Cancel operation icons

- The following operations are available by pressing the colour buttons on the remote control.

Green	<ul style="list-style-type: none">• Switching the number of scenes/still pictures in thumbnail display (9 thumbnails → 20 thumbnails → 9 thumbnails...)• Zoom in on still picture
Yellow	<ul style="list-style-type: none">• Deleting scenes/still pictures
Red	<ul style="list-style-type: none">• Zoom out from still picture

■ Other linked operations

Turning the unit off:

If you use the remote control for the TV to turn off the power, this unit also turns off.

Automatic input switching:

If you connect with a HDMI micro cable and then turn on this unit, the input channel on the TV automatically switches to this unit's screen. If the TV's power is in standby status, it will turn on automatically (if [Set] has been selected for the TV's [Power on link] setting).

- Depending on the HDMI terminal on the TV, the input channel may not switch automatically. In this case, use the remote control for the TV to switch the input channel.

-
- If you are unsure whether or not the TV and AV amplifier you are using are compatible with VIERA Link, read the operating instructions for the devices.
 - Available linked operations between this unit and a Panasonic TV is different depending on the types of Panasonic TVs even if they are compatible with VIERA Link. Refer to the operating instructions of the TV for the operations that support on the TV.
 - Operation is not possible with a cable that is not based on the HDMI standard.

Copying/playing back with a USB HDD



- In these Operating Instructions, "USB hard disk drive" is indicated as "USB HDD". If you connect a USB HDD (commercially-available) to this unit by using a USB Connection Cable (commercially-available), you can copy motion pictures and still pictures recorded on this unit to a USB HDD.
- It can also play back the scenes and still pictures copied to the USB HDD.
- You can copy scenes and still pictures recorded with this unit while maintaining the image quality.
- Please read the operating instructions of the USB HDD for how to use it.

Preparing for copying/playing back

Refer to the following support site for information about USB HDD.

https://panasonic.jp/support/global/cs/e_cam
(This Site is English only)

When the USB HDD that requires formatting is connected, a message is displayed. Follow the instructions on the screen to format it.

Once the USB HDD has been formatted, all data stored on it will be deleted. The data cannot be recovered.

- In the following cases, a USB HDD cannot be used by connecting it to this unit:
 - A USB HDD with a capacity of below 160 GB or above 2 TB
 - When a USB HDD has two or more partitions
 - If a USB HDD is in a format other than FAT32
 - When connected by using a USB hub

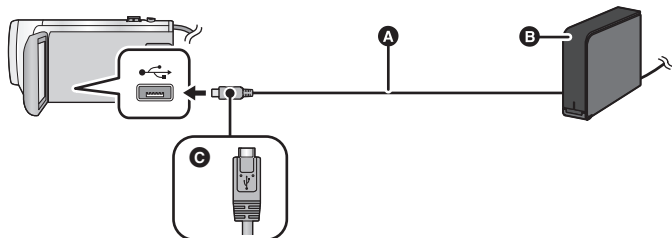

- A** USB Connection Cable (commercially-available)
 - B** USB HDD (commercially-available)
 - C** Turn the side with the symbol up to connect the micro A end of the USB Connection Cable to the USB terminal of this unit.
- Connect this unit to the AC adaptor

- 1** (When using a desktop HDD)
Connect the AC adaptor (supplied with USB HDD) to the USB HDD.
 - If you are using a bus-powered or portable USB HDD, this unit can supply power to the USB HDD by USB Connection Cable (commercially-available).
- 2** **Connect the AC adaptor and a sufficiently charged battery to this unit.**
 - If the AC adaptor is not connected to this unit, the USB HDD cannot be used.
- 3** **Turn on this unit, and press the recording/playback button to switch this unit to the Playback Mode.**
- 4** **Connect this unit to the USB HDD with the USB Connection Cable (commercially-available).**
 - Use a USB Connection Cable (commercially-available) compatible with the USB terminals of this unit and the USB HDD. Connect the micro A end of the USB Connection Cable to the USB terminal of this unit.
For information on the USB terminal of the USB HDD, refer to the operating instructions of the USB HDD.
 - It may take several minutes until the connection is completed.
- 5** **Touch the desired item.**

[Simple copy]:	Copies all scenes and still pictures recorded with this unit that have not been copied yet. (→ 121)
[Copy selected files]:	Allows you to select desired scenes/still pictures, and then copy. (→ 121)
[Playback HDD]:	Plays back scenes and still pictures stored in a USB HDD on this unit. (→ 122)
[Safe Removal]:	Allows you to safely remove this unit and a USB HDD.

- Following can be performed by connecting the USB HDD with the scenes and still pictures copied from this unit to other devices.
 - Save on a PC or rewrite on USB HDD using HD Writer AE 5.2

When the USB HDD is connected to other devices such as Blu-ray disc recorder, a message prompting to format the USB HDD may display. All the scenes and still pictures recorded on the USB HDD will be erased if formatted. Do not format as important data will get erased and it will be impossible to restore.

■ Points to check before copying

- When using a USB HDD for the first time, or using a USB HDD that has been used with other devices, first run [FORMAT MEDIA].
- Before copying, go to [MEDIA STATUS] to check the amount of free space on the USB HDD.
- In the following cases, copying may take longer:
 - There are lots of scenes
 - The temperature of this unit is high
- If you copy protected scenes or still pictures, the protection setting of the copied scenes or still pictures are cancelled.
- The order in which the scenes were copied cannot be changed.

Before you delete the data on the media after copying is complete, be sure to play back the USB HDD to check that they have been copied to correctly. (→ 122)

■ Formatting

This is for initialising the USB HDD.

- Please be aware that if a media is formatted then all the data recorded on the media is erased and cannot be recovered. Back up important data on a PC etc.
- Connect this unit to the USB HDD and touch [Playback HDD].

 : [SETUP] → [FORMAT MEDIA] → [HDD]

- When formatting is complete, touch [EXIT] to exit the message screen.
- Connect this unit and the USB HDD to format.
You may no longer be able to use the USB HDD if you format them on another device such as a PC etc.

■ Displaying media information

The used space of the USB HDD can be checked.

- Connect this unit to the USB HDD and touch [Playback HDD].

 : [SETUP] → [MEDIA STATUS]

- If you touch [CHANGE MEDIA], you can switch the display between the SD card and USB HDD.



Simple copy

- 1 Connect this unit to the USB HDD to prepare for copying. (→ 118)**
- 2 Touch [Simple copy].**
 - When [Copy selected files] or [Playback HDD] is selected, terminate the connection with the USB HDD (→ 122), and then perform the operation of Step 1.
- 3 Touch [YES].**
- 4 Touch [EXIT] when the copy complete message is displayed.**
 - The thumbnail view of the copy destination is indicated.

When you stop copying halfway:

Touch [CANCEL] while copying.

Copy selected files

- 1 Connect this unit to the USB HDD to prepare for copying. (→ 118)**
- 2 Touch [Copy selected files].**
 - You can also copy scenes or still pictures by touching , selecting [COPY].
- 3 Touch [NEXT].**
- 4 Touch the desired items following the instructions on the screen.**
 - It will return to the previous step by touching .
 - (When [SELECT SCENES] is selected)
When touched, the scene/still picture is selected and the  indication appears on the thumbnail. Touch the scene/still picture again to cancel the operation.
 - (When [SELECT DATE] is selected)
When touched, the date is selected and surrounded by red. Touch the date again to cancel the operation.
 - Up to 99 scenes/ 99 dates can be selected continuously.
- 5 Touch [EXIT] when the copy complete message is displayed.**
 - The thumbnail view of the copy destination is indicated.

When you stop copying halfway:

Touch [CANCEL] while copying.

Playing back the USB HDD

- Only motion picture/still picture that have been copied by connecting this unit to the USB HDD or copied with HD Writer AE 5.2 can be played back.

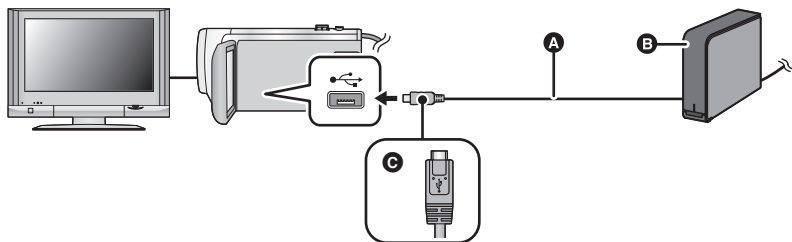

- A** USB Connection Cable (commercially-available)
- B** USB HDD (commercially-available)
- C** Turn the side with the symbol up to connect the micro A end of the USB Connection Cable to the USB terminal of this unit.

1 Connect this unit to the USB HDD to prepare for playback. (→ 118)

- When playing back on a TV, connect this unit to the TV. (→ 113)

2 Touch [Playback HDD].

3 Touch the scene or still picture to be played back and then play it back.



- The playback operation is performed the same as when playing back motion pictures or still pictures. (→ 27, 83)

To terminate the connection between this unit and the USB HDD

Touch  on the Touch Menu.

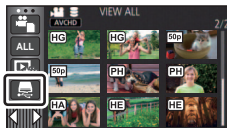
- Disconnect the USB Connection Cable from this unit.





- It is also possible to switch the media to play back by touching the play mode select icon. When the USB HDD is connected, the  (USB HDD) can be selected from the displayed media types. (→ 27)
- Scenes recorded as Backup for Twin Camera will be saved as normal AVCHD scenes when copied to the USB HDD.
- The scenes you have saved in Highlight Playback during playback of the USB HDD are saved in the SD card.
- Deleting scenes and still pictures on the USB HDD may take time.
- You cannot set the following items during playback of  (USB HDD).
 - [SCENE PROTECT]
 - [SECTION DELETE]
 - [DIVIDE]
 - [MANUAL EDIT]
 - [SPLIT&DELETE]
 - [Slow Speed Conversion]
 - [CONVERT TO MP4]

Dubbing with a Blu-ray disc recorder, video device, etc.

■ Check before dubbing

Check the equipment used for dubbing.

Equipment used for dubbing	Dubbing picture quality	To dub
Equipment with USB terminal	High-definition picture quality*	Connect with supplied USB cable (→ 124) 
Equipment without SD card slot or USB terminal	Standard picture quality This can be played back on equipment incompatible with high-definition (AVCHD), so it is convenient if you are dubbing for distribution.	Connect with AV cable (commercially-available) (→ 126) 

* Some equipment may not be compatible with high-definition (AVCHD) or MP4 (iFrame) picture quality. In such a case, connect with an AV cable (commercially-available) and dub with standard picture quality. (→ 126)

- For the positions of the USB terminal, or terminal for connecting the AV cable, refer to the operating instructions of the equipment used.
- The MP4/iFrame scenes cannot be dubbed by connecting with the USB cable. To dub MP4/iFrame scenes, refer to page 126.

You can dub scenes recorded with this unit to a Panasonic Blu-ray disc recorder or DVD recorder that supports the recording format or recording mode you want to use.

- **Note that the equipment described may not be available in certain countries and regions.**

Dubbing in high-definition picture quality



You can dub by connecting a USB cable.

- Use the AC adaptor to free you from worrying about the battery running down.
- **Turn on the unit.**

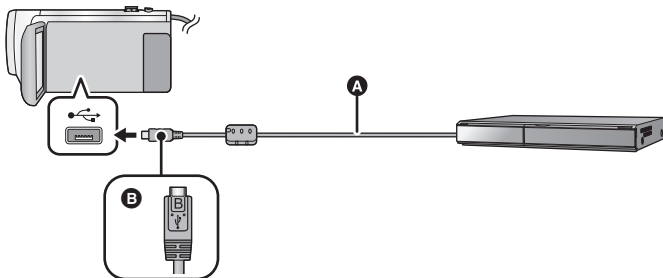

- A** USB cable (supplied)
 - B** Turn the side with the symbol up to connect the micro B end of the USB Cable to the USB terminal of this unit.
- Insert the plugs as far as they will go.

1 Connect the unit to the Blu-ray disc recorder or high-definition (AVCHD) compatible DVD recorder.

- The USB function selection screen will appear on the screen of the unit.

2 Touch [RECORDER] on the screen of this unit.

- When you select an option other than [RECORDER], reconnect the USB cable.
- When using the battery, the LCD monitor turns off after about 5 seconds. Touch the screen to turn the LCD monitor on.

3 Dubbing through operations on the Blu-ray disc recorder or high-definition (AVCHD) compatible DVD recorder.

About the screen indication of the unit

- When the unit is accessing the SD card, card access icon () appears on the unit screen or the access lamp is on.
- Be careful not to disconnect the USB cable, AC adaptor or battery while the unit is accessing the media, as this may result in the loss of recorded content.

-
- Do not use any other USB cables except the supplied one. (Operation is not guaranteed with any other USB cables.)
 - Scenes recorded as Backup for Twin Camera will be saved as normal AVCHD scenes when dubbed on a Panasonic Blu-ray disc recorder or a DVD recorder.
 - When this unit is connected to a Panasonic Blu-ray disc recorder or a DVD recorder using a USB cable while the unit is turned on, power is also supplied from the connected equipment to this unit.
 - For details on dubbing and playback methods, read the operating instructions of the Blu-ray disc recorder or DVD recorder.
 - When you connect the unit to a Blu-ray disc recorder, a dubbing operations screen may appear on the television connected to the Blu-ray disc recorder. In this case as well, perform the operations of Steps 1 to 3.
 - You cannot switch the Recording Mode/Playback Mode by pressing the recording/playback button on this unit while the Blu-ray disc recorder or DVD recorder is connected. Disconnect the USB cable before performing either of these operations.
 - If the battery runs down during dubbing, a message will appear. Operate the Blu-ray disc recorder to cancel the dubbing.



■ Dubbing using equipment without a USB terminal, or using a video device

You can dub by connecting an AV cable (commercially-available).

- Use the AC adaptor to free you from worrying about the battery running down.

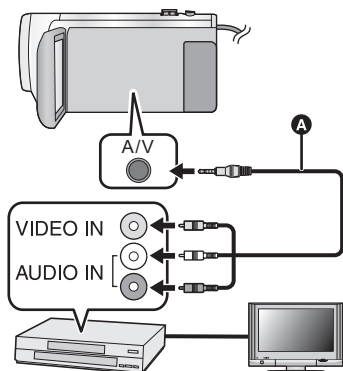

Change the video input on the video device and TV that this unit is connected to.

- The channel set will differ depending on the terminal to which the unit is connected.
- See the operating instructions of the video device for details.
- Insert the plugs as far as they will go.
- Ⓐ AV cable (commercially-available)

- Press the recording/playback button to switch this unit to the Playback Mode.

1 Connect this unit to a video device and start playback on this unit.

2 Start recording on the connected device.

- To stop recording (dubbing), stop playback on this unit after stopping recording on the recorder.

-
- Some screens, such as the menu screen, may be displayed in reduced sizes on the TV.
 - If the date and time display and function indication are not wanted, cancel them before dubbing. (→ 33, 114)

If the dubbed images are played back on a wide-screen TV, the images may be stretched vertically.

In this case, refer to the operating instruction for the device you are connecting to or read the operating instructions of the wide-screen TV and set the aspect ratio to 16:9.

Wi-Fi[®] function

■ Use this unit as a wireless LAN device

When using equipment or computer systems that require more reliable security than wireless LAN devices, ensure that the appropriate measures are taken for safety designs and defects for the systems used. Panasonic will not take any responsibility for any damage that arises when using this unit for any purpose other than as a wireless LAN device.

■ Use of the Wi-Fi function of this unit is presumed to be in countries where this unit is sold

There is the risk that this unit violates the radiowave regulations if used in countries other than those where this unit is sold, and Panasonic takes no responsibility for any violations.

■ There is the risk that data sent and received via radio waves may be intercepted

Please note that there is the risk that data sent and received via radio waves may be intercepted by a third party.

■ Do not use this unit in areas with magnetic fields, static electricity or interference

- Do not use this unit in areas with magnetic fields, static electricity or interference, such as near microwave ovens. Radio waves may not reach this unit.
- Using this unit near devices such as cordless telephones or any other wireless LAN device that use the 2.4 GHz radio wave band may cause a decrease in performance in both devices.

■ Do not connect to the wireless network you are not authorised to use

When this unit utilises its Wi-Fi function, wireless networks will be searched automatically. When this happens, wireless networks that you are not authorised to use (SSID*) may be displayed, however do not attempt to connect to the network as it may be considered as unauthorised access.

* SSID refers to the name of device that is used to identify a network over a wireless LAN connection. If the SSID matches for both devices, transmission is possible.

■ Before use

To use a Wi-Fi function with this unit, you need a wireless access point or destination device equipped with a wireless LAN function.

- For the operations and settings of your device such as the smartphone, please read the operating instructions of the device.

■ This unit is WPS-compatible

WPS (Wi-Fi Protected Setup™) is a function that allows you to easily set up a connection with a wireless LAN device and make security-related settings.

-
- This unit cannot be used to connect to a public wireless LAN connection.
 - Use a IEEE802.11b, IEEE802.11g or IEEE802.11n compatible device when using a wireless access point.
 - This unit uses the 2.4 GHz frequency band. You cannot establish a wireless LAN connection using the 5 GHz frequency band.
 - When using a wireless access point, we strongly recommend that you set a encryption to maintain information security.
 - When sending scenes or still pictures, we recommend you use the AC adaptor. If you are using the battery, we recommend you use the fully charged one.
 - When sending motion pictures or still pictures on a mobile network or tethering, high packet communication fees may be incurred depending on the details of your contract.
 - This unit may not connect to a wireless access point depending on the radio wave condition.
 - When motion picture or still picture transmission is not successful, point the Wi-Fi transmitter (→ 10) at the wireless device (smartphone, etc.).
 - When the battery indicator is flashing red, the connection with other equipment may not start or the connection may be disrupted.
 - The Wi-Fi transmitter may become warm when using the Wi-Fi function; however this is not a sign of a malfunction. (→ 10)

What you can do with the Wi-Fi function

This unit offers the following Wi-Fi functions when used in combination with another Wi-Fi compatible device.

[TWIN CAMERA]	You can display the image transmitted from a Wireless Sub Camera connected via Wi-Fi on this unit's Sub Window and record it simultaneously with the Main Camera's image. (→ 156)
[Remote Ctrl]	You can use a smartphone to remotely control recording and playback on this unit. (→ 130)
[DLNA Play]	Connecting this unit to a DLNA (DMR)-compatible TV via Wi-Fi, you can play back scenes and still pictures on the TV. (→ 135)
[Copy]	By setting up a Wi-Fi communication between this unit and a PC, you can copy scenes and still pictures recorded with this unit to the PC. (→ 137)
[History]	Each use of a Wi-Fi function is stored in the Wi-Fi connection history. Connecting from the history allows you to easily set up a connection using the previous connection settings. (→ 149)

- The following Wi-Fi functions have been terminated.
Related menus, etc., will still be displayed, but they can no longer be used.
 - [Baby Monitor]
 - [Hom.Monitor]
 - [Live Cast]

[Remote Ctrl]

You can use a smartphone to remotely control recording and playback on this unit.

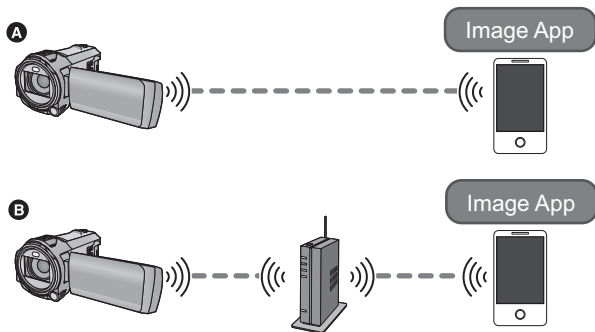

- A** When connecting directly to a smartphone
- B** When connecting to a wireless access point

- You need to turn on the Wi-Fi function of your smartphone.
- Do not remove the SD card during remote operations.

- Refer to [Help] in the "Image App" menu about how to operate.

Caution:

Be sure to pay special attention to the privacy, the likeness rights, etc. of the subject when you use this function. Use at your own risk.

Preparations before using [Remote Ctrl]

Install the smartphone application “Image App” on your smartphone. (→ 141)

Setting up a direct Wi-Fi connection between this unit and a smartphone

Operate this unit and the smartphone to set up a direct connection.

Check the [Direct Connection Password] setting in [Wi-Fi Setup]. (→ 153)

- The default setting for [Direct Connection Password] is [OFF].
Select [ON] as needed, for example when the setting seems necessary for your Wi-Fi environment.
- **When [Direct Connection Password] is set to [OFF]**
 - Connecting with [Direct Connection Password] set to [OFF] (→ 147)
- **When [Direct Connection Password] is set to [ON]**
 - [Easy Connection (WPS)] (→ 148)
 - Connecting with QR code (→ 148)
 - Connecting by entering an SSID and Password (→ 149)

When the Wi-Fi connection is complete, proceed to “Using [Remote Ctrl] with a direct connection”. (→ 132)

Setting up a Wi-Fi connection via a wireless access point

1 Check if the wireless access point is compatible with IEEE802.11b/g/n.

2 Set up a Wi-Fi connection between this unit and the wireless access point.

- [Easy Connection (WPS)] (→ 144)
- Searching for wireless access points to set up a connection (→ 145)
- Setting up a connection manually (→ 146)

When the Wi-Fi connection is complete, proceed to “Using [Remote Ctrl] with a wireless access point connection”. (→ 132)

-
- Using [Wi-Fi Setup Wizard], you can also set up a Wi-Fi connection in conjunction with the smartphone application “Image App”. (→ 143)

Using [Remote Ctrl] with a direct connection

Proceed to Step 2 when your Wi-Fi connection has been made via [Direct Connection] in [Wi-Fi Setup] (→ 147).

1 Press Wi-Fi button on this unit and touch [Remote Ctrl].  Wi-Fi

- It will go into connection standby for remote operation.

2 Start up the smartphone application “Image App”.

- (When [Direct Connection Password] is set to [OFF])
If this is the first time the smartphone is connecting to this unit, a message will be displayed on the screen of this unit. Touch [YES].
- When the connection is complete, images of this unit is displayed on the smartphone screen.

To exit [Remote Ctrl]:

Touch [EXIT] or press Wi-Fi button.

- The message is displayed. Touch [YES] to close the indication.

-
- The following operations allow you to register up to ten smartphones. If the number exceeds ten, smartphone information with the oldest registration date and time will be deleted.
 - Setting [Direct Connection Password] to [OFF] and connecting this unit and a smartphone directly.

Using [Remote Ctrl] with a wireless access point connection

1 Connect the smartphone to a wireless access point.

2 Press Wi-Fi button on this unit and touch [Remote Ctrl].  Wi-Fi

- It will go into connection standby for remote operation.

3 Start up the smartphone application “Image App”.

- When the connection is complete, images of this unit is displayed on the smartphone screen.

To exit [Remote Ctrl]:

Touch [EXIT] or press Wi-Fi button.

- The message is displayed. Touch [YES] to close the indication.

-
- The following operations allow you to register up to ten smartphones. If the number exceeds ten, smartphone information with the oldest registration date and time will be deleted.
 - Setting [Direct Connection Password] to [OFF] and connecting this unit and a smartphone directly.

About [Remote Ctrl]

Screen display during remote operations

Smartphone screen shots are example displayed in Motion Picture Recording Mode and Playback Mode.

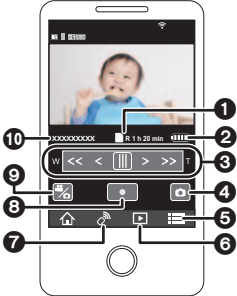
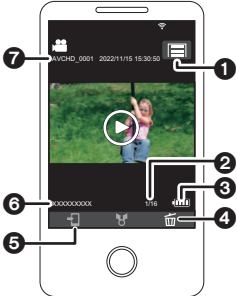
Recording screen	
	<ol style="list-style-type: none">1 Recording media/remaining recordable time2 Remaining battery power of this unit3 Zoom4 Photoshot button5 Menu display6 Playback mode button7 Remote control button8 Recording start/stop button9 Motion Picture Recording Mode/Still Picture Recording Mode toggle button10 Name of the connected device
Playback screen	
	<ol style="list-style-type: none">1 Camera function button2 Number of scenes3 Remaining battery power of this unit4 Delete5 Copy6 Name of the connected device7 Scene information display

- Depending on your OS or the version of the smartphone application "Image App", the screens may differ from the ones above.

Functions available for remote operations

■ In Recording Mode

- Recording motion pictures/still pictures
- Selecting a mode
- Using the zoom (Available in the medium or fast speed)
- Switching between the Recording Mode:
 - Intelligent Auto Mode
 - Manual Mode
 - FULL HD Slow Motion Video Mode ([Always])
 - Stop Motion Animation Assist Mode
- Backup for Twin Camera
- Recording format
- Picture size
- White Balance
- Backlight Compensation
- Night Mode
- Self-timer
- Aspect ratio
- Turning the unit off

■ In Playback Mode

- Playback
- Switching between thumbnails (AVCHD/MP4/Backup (Backup for Twin Camera)/JPEG (Still picture))
- Delete
- Save (Copy)
 - Scenes recorded in AVCHD cannot be copied.
 - Scenes recorded in iFrame can only be copied with iOS devices.
 - Depending on your smartphone, scenes recorded in MP4 format may not be copied.
- Smart Home Network
 - It is possible to perform playback operation when this unit is connected to the DLNA (DMR)-compatible TV via wireless access point using a smartphone.
- Creating and saving scenes with Highlight Playback

Highlight Playback is not available for the following scenes :

 - iFrame scenes
 - Scenes recorded with FULL HD Slow Motion Video Mode (→ 53)
 - Scenes recorded as Backup for Twin Camera
 - MP4 scenes saved as Highlight Playback
 - Scenes that were converted to MP4 scenes and copied (with the MP4 conversion function) (→ 111)
- Highlight Photo Collage
 - Parts that were recognised as clearly recorded are automatically extracted from multiple scenes and saved as still pictures. (Not available for MP4/iFrame scenes or scenes recorded as Backup for Twin Camera)
 - In addition, the multiple still pictures you have captured can be put in a frame and saved as a single still picture.

-
- Functions other than those listed above are not available for remote operation.
 - If you record an image when the LCD monitor of this unit is closed with the screen facing outward, the LCD monitor turns off.

[DLNA Play]

Connecting this unit to a DLNA (DMR)-compatible TV via Wi-Fi, you can play back scenes and still pictures on the TV.

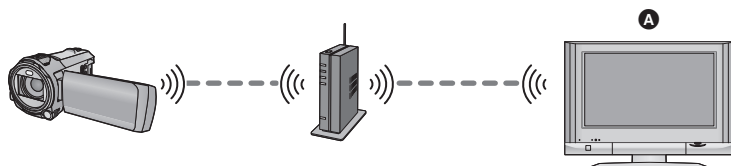

A DLNA (DMR)-compatible TV

- Please read the operating instructions for the TV about connecting TV to the wireless access point.
- Do not remove the SD card in playing back on a TV.

Preparations before using [DLNA Play]

- 1** Check if the wireless access point is compatible with IEEE802.11b/g/n.
 - 2** Check if the TV is DLNA-compatible.
 - 3** Set up a Wi-Fi connection between this unit and the wireless access point.
 - [Easy Connection (WPS)] (→ 144)
 - Searching for wireless access points to set up a connection (→ 145)
 - Setting up a connection manually (→ 146)
 - 4** When the Wi-Fi connection is complete, proceed to “Playing back on a TV”. (→ 136)
-
- Using [Wi-Fi Setup Wizard], you can also set up a Wi-Fi connection in conjunction with the smartphone application “Image App”. (→ 143)

Playing back on a TV

You can play back the scenes and still pictures recorded with or stored in this unit on a TV.

- The following scenes can be played back:
 - Scenes recorded in AVCHD
 - Scenes recorded as Backup for Twin Camera
 - Scenes recorded in MP4/iFrame [720]
 - Scenes saved in MP4 (1280×720/25p) or MP4 (640×360/25p)

1 Press Wi-Fi button on this unit and touch [DLNA Play]. Wi-Fi

- If you touch [Change AP], you can switch the wireless access point to another one that has been registered to this unit.
- If you touch [CANCEL], the Wi-Fi connection is cancelled.
- When the connection is complete, the screen of this unit turns off. To display it again, touch the screen.

2 Select this unit (SSID) by the TV side.

- Select SD media and select the motion picture ([AVCHD/MP4]) or still picture ([JPEG]) to play back.

3 Perform playback operations with the TV remote control.

- Playback operations may differ depending on the TV in use.
- The following operations can be performed if a colour button is pushed.
 - Blue/Red: Skip playback
- Fast forward/Fast rewind playback cannot be performed.
- You cannot perform playback operations with this unit.

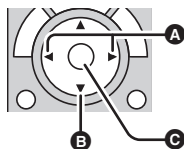

(Examples of operations during motion picture playback)

- A** Skip playback
- B** Stop
- C** Playback/Pause

To exit [DLNA Play]:

Touch [EXIT] or press Wi-Fi button.

- A message is displayed. Touch [YES] to exit.

-
- You cannot play back the following scenes:
 - Scenes recorded with [1080/50M], [1080/28M] or [iFrame] of [MP4/iFrame]
 - Scenes saved in MP4 (1920×1080/25p)
 - The scenes may not be played back smoothly depending on your environment, such as the network condition.

[Copy]

By setting up a Wi-Fi communication between this unit and a PC, you can copy scenes and still pictures recorded with this unit to the PC.

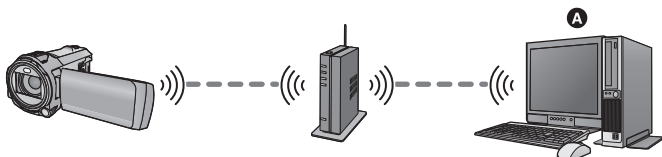

A PC

- If [CLOCK SET] (→ 21) is not set correctly, scenes and still pictures may not be able to be copied to a PC.
- For information on the connection between a PC and a wireless access point, refer to the operating instruction of the device in use.
- If this unit and a PC are not connected to the same wireless access point, copying is not possible.

Preparations before using [Copy]

- 1** Check if the wireless access point is compatible with IEEE802.11b/g/n.
 - 2** Check if the PC and the wireless access point are connected via Wi-Fi.
 - You can also use a LAN cable to connect the PC and the wireless access point.
 - 3** Set up a Wi-Fi connection between this unit and the wireless access point.
 - [Easy Connection (WPS)] (→ 144)
 - Searching for wireless access points to set up a connection (→ 145)
 - Setting up a connection manually (→ 146)
 - 4** When the Wi-Fi connection is complete, proceed to “Copying to a PC”. (→ 139)
-
- Using [Wi-Fi Setup Wizard], you can also set up a Wi-Fi connection in conjunction with the smartphone application “Image App”. (→ 143)

Creating a shared folder (destination folder) on the PC

To copy scenes and still pictures by setting up a Wi-Fi connection between this unit and the PC, complete the following preparations:

- Turn on the PC
- Create a shared folder (destination folder)*1

*1 The name of the folder must consist of 15 or less alphanumeric characters.

■ When using HD Writer AE 5.2

1 Install HD Writer AE 5.2.

- For information on the operating environment and installation, refer to “Operating environment” (→ 171) and “Installation” (→ 173).

2 Using HD Writer AE 5.2, create a destination folder.

- Select [Auto-create] or [Create manually]. The first option creates a destination folder automatically, while the second option allows you to specify a destination folder or create a new one. With the second option, you can also set password protection for a destination folder.
- For details, refer to the Operating Instructions of HD Writer AE 5.2 (PDF file). (→ 177)

■ When not using HD Writer AE 5.2

- If the workgroup setting of the connected PC has been changed from the standard one, you also need to change the [PC Connect Setup] setting of this unit. (→ 155)
- The user account of the PC (both the Account Name and the Password) must consist of 32 or less alphanumeric characters.*2
If you use non-alphanumeric characters for the user account, a destination folder may not be set up.

*2 If you use more than 32 characters for the user account, copying via a Wi-Fi connection is not possible.

(For Windows)

Supported OS: Windows 8.1/Windows 10

Example: Windows 10

1 Select a destination folder, and right-click.

2 Select [Properties], and enable sharing of the folder.

- For details on how to enable sharing, refer to the operating instructions of your PC or the help of your OS.

(For Mac)

Supported OS: macOS 11.2

Example: macOS 11.2

1 Select a destination folder, and click the following items:

[File] → [Get Info]

2 Enable sharing of the folder.

- For details on how to enable sharing, refer to the operating instructions of your PC or the help of your OS.

Copying to a PC

- Create a shared folder (destination folder) on the PC. (→ 138)

1 Press **Wi-Fi** button on this unit and touch **[Copy]**.  Wi-Fi

2 Touch the **PC** to be connected.

- To search for PCs again, touch **[Refresh]**.

(When the PC you want to connect to is not displayed)

Touch **[Set Manually]**.

3 (When **[Set Manually]** is touched)

Enter the computer name of the PC (NetBIOS name for Mac computers).

- Enter the computer name of your PC (NetBIOS name for Mac computers).
(A maximum of 15 characters can be entered.)
- When the computer name (or NetBIOS name) contains a space (blank character), etc., it may not be recognised correctly. If a connection attempt fails, we recommend that you change the computer name (or NetBIOS name) to the one consisting of only alphanumeric characters, with a maximum of 15 characters.
- Input method is same operation as for setting up the title. (→ 94)
- After entering the computer name of the PC, touch **[Enter]**.

4 Touch **[INPUT]**, and enter the name of the shared folder.

- If you have created a shared folder (destination folder) using HD Writer AE 5.2 (→ 138), touch **[NEXT]**.
- Enter the name of the shared folder you have created on your PC, and touch **[Enter]**.
(A maximum of 15 characters can be entered.)
- If a screen asking you to enter a user account and password is displayed after you have entered the name of the shared folder, enter the one you have created on your PC.
- When the connection to the PC is complete, copying starts.
- When copying is complete, this unit turns off automatically.

When you stop copying halfway

Touch **[CANCEL]** while copying.

If you intend to delete the original scenes or still pictures when the copying has finished, always play back the duplicate scenes or still pictures on PC before deletion to confirm that they have been copied normally.



- Copying can be performed even when the battery is used for power, but we recommend that the AC adaptor be used.
- Once scenes or still pictures are copied to a PC, the original scenes or still pictures cannot be copied to any PCs.
- If the total length of the scenes recorded on the same date on the SD card exceeds approximately 8 hours, the scenes will not be copied.
- If the copy source contains scenes or still pictures recorded on other devices, copying may be cancelled.
- Depending on your environment, copying may take time or may not be available.
- If the scene to be copied is long or copying fails, we recommend that the following be performed for copying.
 - Connecting this unit to the PC by USB cable (→ 174, 178)
 - Inserting the SD card to the built-in SD card slot of the PC or your SD card reader/writer directly

Install the “Image App”

- To use the following Wi-Fi functions, you need to install the smartphone application “Image App”.
 - [TWIN CAMERA] (→ 156)
 - [Remote Ctrl] (→ 130)

About the “Image App”

The “Image App” is an application provided by Panasonic.

OS	For Android™ apps	For iOS apps
	Android 4.4 or later*	iOS 9.3 or later*
Installation procedure	<ol style="list-style-type: none"> 1 Connect your Android device to a network. 2 Select “Google Play™ Store”. 3 Enter “Panasonic Image App” into the search box. 4 Select “Panasonic Image App” and install it. <ul style="list-style-type: none"> ● The icon will be added to the menu.  	<ol style="list-style-type: none"> 1 Connect your iOS device to a network. 2 Select “App Store”. 3 Enter “Panasonic Image App” into the search box. 4 Select “Panasonic Image App” and install it. <ul style="list-style-type: none"> ● The icon will be added to the menu. 

* The supported OS versions are current as of January 2022 and subject to change.

- Use the latest version.
- Refer to [Help] in the “Image App” menu about function of Image App.
- The service may not be able to be used properly depending on the type of smartphone being used. For information on the “Image App”, check the support website below.

https://panasonic.jp/support/global/cs/e_cam

(This Site is English only.)

- When downloading the app on a mobile network, high packet communication fees may be incurred depending on the details of your contract.

Setting Up a Wi-Fi Connection

To use the Wi-Fi function, connect this unit to a wireless access point or smartphone via Wi-Fi.

- Depending on the Wi-Fi connection method, available Wi-Fi functions differ.

Wi-Fi connection methods	Connecting to a wireless access point (→ 144)	Setting up a direct connection to a smartphone (→ 147)
Available Wi-Fi functions	<ul style="list-style-type: none"> • [Remote Ctrl] (→ 132) • [DLNA Play] (→ 135) • [Copy] (→ 137) 	<ul style="list-style-type: none"> • [Remote Ctrl] (→ 132)

- If you select [History], you can set up a Wi-Fi connection that uses the connection settings of a previously used Wi-Fi function. (→ 149)

■ About the status indicator and the connection status icon when connected to Wi-Fi

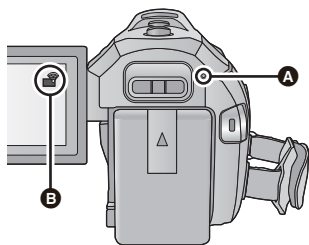

A Lit green

- The status indicator is lit green while this unit is connected to a destination device after completing a Wi-Fi connection.
- When Wi-Fi is disconnected, the status indicator is lit red again.

B The connection status icon

When connected to wireless access point:

- connected to Wi-Fi / not connected to Wi-Fi
- The display will change as follows according to the radio wave intensity: (Weak) → → → (Strong).

When directly connected:

- connected to Wi-Fi / not connected to Wi-Fi

- For information on how to set up a Wi-Fi connection for the Wireless Twin Camera function, refer to page 158; for information on the connection status icons, refer to 162.

Using the [Wi-Fi Setup Wizard] to set up a connection

With the smartphone application "Image App", you can transfer the following information between the smartphone and this unit.

- Set [Direct Connection Password] in [Wi-Fi Setup] to [ON]. (→ 153)
(The default setting is [OFF].)

Set on the smartphone and transfer to this unit	<ul style="list-style-type: none">• Clock information• Information on wireless access points (SSIDs and Passwords)
--	---

- Install the smartphone application "Image App" on your smartphone. (→ 141)

- 1 Press Wi-Fi button on this unit and touch [Wi-Fi Setup].**  Wi-Fi
- 2 Touch [Wi-Fi Setup Wizard].**
- 3 Touch [YES].**
- 4 Touch [QR code] or [Wi-Fi].**

When [QR code] is selected

- 1 Start up the smartphone application "Image App".**
- 2 On the smartphone, select [QR code], and scan the QR code displayed on the screen of this unit.**
 - The setup screen is displayed on the smartphone.
 - When using an iOS device, perform the following operations:
 - 1** Select the option that allows you to install the app on the profile screen of the "Image App", and follow the on-screen instructions to complete the installation.
 - 2** Press the home button to close the displayed screen.
 - 3** Touch [NEXT] on the screen of this unit to display its SSID.
 - 4** After selecting the network name (SSID) of this unit from the Wi-Fi setup of the smartphone, start up "Image App".
- 3 Follow the on-screen instructions of the smartphone to set up a connection.**
 - When the settings is complete, the smartphone and this unit are connected directly, allowing you to use remote operations. (→ 132)

When [Wi-Fi] is selected

- If you are using an Android device, start up the smartphone application "Image App".
- 1 (If the device is Android)
On the smartphone, select [Wi-Fi], and select the SSID displayed on this unit.
(If the device is iOS)
On the smartphone, select the SSID displayed on this unit from the Wi-Fi setup menu.
 - 2 (If the device is Android)
Enter the Password displayed on this unit.
(If the device is iOS)
After entering the Password displayed on this unit, start up the "Image App".
 - 3 **Follow the on-screen instructions of the smartphone to set up a connection.**
- When the settings is complete, the smartphone and this unit are connected directly, allowing you to use remote operations. (→ 132)

Connecting to a wireless access point

Check if the wireless access point you are using is compatible with WPS

- If the wireless access point is compatible with WPS:
Proceed to the following [Easy Connection (WPS)]
- If the wireless access point is not compatible with WPS:
"Searching for wireless access points to set up a connection" (→ 145)

[Easy Connection (WPS)]

- 1 Press **Wi-Fi** button on this unit.  Wi-Fi
 - 2 Touch [Wi-Fi Setup].
 - 3 Touch [Set Wireless Access Point].
 - 4 Touch the part with no display of a wireless access point.
- For information on how to delete wireless access points or change the search order of wireless access points, please refer to [Set Wireless Access Point] on page 152.
- 5 Touch [Easy Connection (WPS)].
 - 6 **Set the wireless access point to waiting for WPS.**
- For further details, please read the operating instructions for the wireless access point. (When using a tethering connection, please read the operating instructions for the smartphone.)
 - A message is displayed when the connection is complete. Touch [EXIT], and exit [Set Wireless Access Point].
 - A message is displayed when the connection attempt fails. Touch [EXIT], and set the connection again.

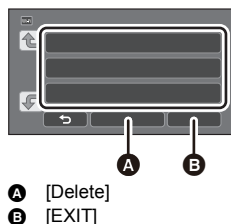

Enter a PIN code to set the Wi-Fi connection

1 Touch [PIN code] in Step 6.

2 Touch the wireless access point to be connected.

- If you touch [Refresh], you can search for wireless access points again.
- If you touch  and select a wireless access point, all characters will be displayed. In this case, touch [OK].

3 Enter the PIN code displayed on this unit screen into the wireless access point.

- For further details, please read the operating instructions for the wireless access point. (When using a tethering connection, please read the operating instructions for the smartphone.)

4 Touch [NEXT].

- A message is displayed when the connection is complete. Touch [EXIT], and exit [Set Wireless Access Point].
- A message is displayed when the connection attempt fails. Touch [EXIT], and set the connection again.

Confirming that the Wi-Fi connection is complete

- The status indicator of this unit is lit green
-  is displayed on the screen

Searching for wireless access points to set up a connection

- Confirm Encryption key (Password) of the selected wireless access point if the network authentication is encrypted.

1 Press Wi-Fi button on this unit. Wi-Fi

2 Touch [Wi-Fi Setup].

3 Touch [Set Wireless Access Point].

4 Touch the part with no display of a wireless access point.

- For information on how to delete wireless access points or change the search order of wireless access points, please refer to [Set Wireless Access Point] on page 152.

5 Touch [Search].

6 Touch the wireless access point to connect.

- If you touch [Refresh], you can search for wireless access points again.
- If you touch  and select a wireless access point, all characters will be displayed. In this case, touch [OK].
- When no wireless access points are displayed, refer to “Setting up a connection manually”. (→ 146)
- If an Encryption key (Password) is not set, the connection is complete and a message is displayed. Touch [EXIT], and exit [Set Wireless Access Point].



- A [Delete]
- B [EXIT]

7 (When there is an Encryption key (Password))

Enter the Password.

- For details on how to enter characters, refer to page 94.
- When the entry is complete, touch [Enter].
- A message is displayed when the connection is complete. Touch [EXIT], and exit [Set Wireless Access Point].

Confirming that the Wi-Fi connection is complete

- The status indicator of this unit is lit green
-  is displayed on the screen

Setting up a connection manually

- When connecting by [Set Manually], confirm the SSID (Identification name), Authentication method, Encryption type, and Encryption key (Password) of the wireless access point you are using.

1 Press Wi-Fi button on this unit. Wi-Fi

2 Touch [Wi-Fi Setup].

3 Touch [Set Wireless Access Point].

4 Touch the part with no display of a wireless access point.

- For information on how to delete wireless access points or change the search order of wireless access points, please refer to [Set Wireless Access Point] on page 152.

5 Touch [Set Manually].

6 Touch [INPUT], then enter the SSID of the wireless access point to be connected.

- For details on how to enter characters, refer to page 94.
- When the entry is complete, touch [Enter].

7 Touch the desired Network Authentication method.



- A [Delete]
- B [EXIT]

Network authentication type	Encryption types that can be set
[Open]	[NONE]/[WEP]
[WEP]	There is no setup of an encryption types.
[WPA-PSK]/[WPA2-PSK]	[TKIP]/[AES]

- When [WEP] is selected, proceed according to step 9.

8 Touch the desired Encryption method.

- If you select [NONE], a message is displayed after completing the connection. Touch [EXIT], and exit [Set Wireless Access Point].

9 (When selecting [WEP]/[TKIP]/[AES])

Touch [INPUT], then enter the Password.

- For details on how to enter characters, refer to page 94.
- When the entry is complete, touch [Enter].
- A message is displayed when the connection is complete. Touch [EXIT], and exit [Set Wireless Access Point].

Confirming that the Wi-Fi connection is complete

- The status indicator of this unit is lit green
-  is displayed on the screen

- Check the wireless access points instruction manual and settings when a saving wireless access point.
- The Encryption methods are [AES], [TKIP] and [WEP] in descending order of strength. We recommend you connect with the strongest possible Encryption method.
- When the signal of the wireless access point is weak, a connection may not be established. Refer to “Messages” (→ 182) and “Troubleshooting” (→ 184) for details.
- Transmission speed may decrease, or may not be usable depending on the environment it is used in.

Setting up a direct connection to a smartphone

Check the [Direct Connection Password] setting in [Wi-Fi Setup]. (→ 153)

- The default setting is [OFF].
Select [ON] as needed, for example when the setting seems necessary for your Wi-Fi environment.
- **When [Direct Connection Password] is set to [OFF]**
 - Proceed to the following “Connecting with [Direct Connection Password] set to [OFF]”
- **When [Direct Connection Password] is set to [ON]**
If your smartphone is compatible with WPS, refer to “[Easy Connection (WPS)]”. If not, refer to “Connecting with QR code”.
 - Proceed to the following [Easy Connection (WPS)]
 - Proceed to the following “Connecting with QR code”
 - Proceed to the following “Connecting by entering an SSID and Password”

Connecting with [Direct Connection Password] set to [OFF]

- 1 Press Wi-Fi button on this unit and touch [Wi-Fi Setup].**  Wi-Fi
- 2 Touch [Direct Connection].**
- 3 On the smartphone, select the SSID displayed on this unit from the Wi-Fi setup menu.**

Confirming that the Wi-Fi connection is complete

- The status indicator of this unit is lit green
-  is displayed on the screen

[Easy Connection (WPS)]

- 1 Press **Wi-Fi** button on this unit and touch **[Wi-Fi Setup]**.  Wi-Fi
- 2 Touch **[Direct Connection]**.
- 3 Touch **[Change connection type]**.
- 4 Touch **[Easy Connection (WPS)]**.
- 5 Set the smartphone to **WPS Mode**.

Confirming that the Wi-Fi connection is complete

- The status indicator of this unit is lit green
-  is displayed on the screen

Connecting with QR code

- 1 Press **Wi-Fi** button on this unit and touch **[Wi-Fi Setup]**.  Wi-Fi
- 2 Touch **[Direct Connection]**.
- 3 Touch **[Change connection type]**.
- 4 Touch **[QR code]**.
 - QR code is displayed on the screen of this unit.
- 5 Start up the smartphone application **“Image App”**.
- 6 On the smartphone, select **[QR code]**, and scan the QR code displayed on the screen of this unit.
 - When using an Android device, the smartphone and this unit are connected directly, allowing you to use remote operations. (→ 132)
 - When using an iOS device, perform the following operations:
 - 1 Select the option that allows you to install the app on the profile screen of the “Image App”, and follow the on-screen instructions to complete the installation.
 - 2 Press the home button to close the displayed screen.
 - 3 Select the network name (SSID) of this unit from the Wi-Fi setup of the smartphone.
 - When the QR code cannot be scanned, refer to “Connecting by entering an SSID and Password”.

Confirming that the Wi-Fi connection is complete

- The status indicator of this unit is lit green
-  is displayed on the screen

Connecting by entering an SSID and Password

- 1 Press **Wi-Fi** button and touch [**Wi-Fi Setup**].  Wi-Fi
- 2 Touch [**Direct Connection**].
- 3 Select the SSID displayed on this unit from the Wi-Fi setup menu.
- 4 Enter the Password displayed on this unit's screen on the smartphone.

Confirming that the Wi-Fi connection is complete

- The status indicator of this unit is lit green
-  is displayed on the screen

- Transmission speed may decrease, or may not be usable depending on the environment it is used in.

Connecting from the history

Each use of a Wi-Fi function is stored in the Wi-Fi connection history. Connecting from the history allows you to easily set up a connection using the previous connection settings.



- 1 Press **Wi-Fi** button on this unit and touch [**History**].  Wi-Fi
- 2 Touch the desired item to be connected.

- The history of Wi-Fi functions and connection destinations that have been used is displayed as a list.
- For periods when a smartphone, etc. and this unit were connected directly, only the list of Wi-Fi functions is displayed.
Each item stores its [Direct Connection Password] setting (→ 153). Connections without a password are displayed with [No Password] on the history list.
- To display the connection details, touch [DETAIL].

- 3 Touch [ENTER].

- When the connection is complete, a message will be displayed and the screen will switch to the Wi-Fi function screen selected in step 2. Perform the operation of the selected Wi-Fi function.
- If you have selected [Remote Ctrl], start up the smartphone application "Image App" after checking that "Under remote control" is displayed on the LCD monitor.
If the connection cannot be established, check the Wi-Fi setup of the smartphone.

Confirming that the Wi-Fi connection is complete

- The status indicator of this unit is lit green
- The following icons are displayed on the screen:
When connected to wireless access point: 
When directly connected: 

- The history can store up to 8 most-recently used Wi-Fi connections.
- If you set up a Wi-Fi connection from [Set Wireless Access Point] in [Wi-Fi Setup], the Wi-Fi connection will not be stored in the history.

If the Wi-Fi connection cannot be established

- Please refer to the operating instruction of the device in use for details about the setting of the wireless access point or smartphone.

Problem	Check points
<p>It cannot connect to the wireless access point.</p> <p>The wireless access point is not detected.</p>	<p>(General)</p> <ul style="list-style-type: none">• Turn ON the wireless access point.• Approach the wireless access point and reconnect.• If it takes time to complete the connection, the Wi-Fi connection will be aborted. Reset the connection settings.• Check how to connect to the wireless access point and how to set the security settings.• If the wireless access point supports both the 2.4 GHz band and the 5 GHz band, check if the setting for the 2.4 GHz band is enabled.• Make sure the wireless access point is registered in this unit. (→ 152)• The device may be unable to locate the wireless access point due to problems with the signal. Refer to "Setting up a connection manually". (→ 146) <p>([Easy Connection (WPS)])</p> <ul style="list-style-type: none">• Make sure the wireless access point is in the correct WPS standby mode.• Make sure the PIN code has been correctly input. <p>([Search] or [Set Manually])</p> <ul style="list-style-type: none">• Make sure the SSID and password have been correctly input.• Check the Authentication method, Encryption type, and Encryption key (Password).
<p>Radio waves of the wireless access point get disconnected.</p>	<ul style="list-style-type: none">• The condition may be improved by moving the location or changing the angle of the wireless access point.• If you use another 2.4 GHz band device such as a microwave oven or cordless telephone nearby, you may interrupt the signal. Keep a sufficient distance from these types of devices.

Problem	Check points
<p>The Wi-Fi connection is not possible between this unit and a smartphone.</p>	<p>(Wireless Access Point Connection)</p> <ul style="list-style-type: none"> ● Make sure the smartphone is properly connected to the wireless access point by checking the Wi-Fi settings of the smartphone. ● Make sure this unit and the smartphone are connected to the same wireless access point. ● Make sure the wireless access point is registered in this unit. (→ 152) <p>(Direct Connection)</p> <ul style="list-style-type: none"> ● Make sure the smartphone is properly connected to this unit by checking the Wi-Fi settings of the smartphone. ● Make sure the SSID and password have been correctly input. ● Make sure the smartphone is not connected to the wireless access point. If it is connected to the wireless access point, change the Wi-Fi access point using the smartphone's Wi-Fi set up.
<p>It takes long time every time to connect to a smartphone.</p>	<ul style="list-style-type: none"> ● It may take longer time to connect depending on the Wi-Fi connection setting of the smartphone, but it is not a malfunction.
<p>This unit is not displayed in the Wi-Fi setting screen of the smartphone.</p>	<ul style="list-style-type: none"> ● Try switching the ON/OFF of the Wi-Fi function in the Wi-Fi settings of the smartphone.
<p>The Wi-Fi connection is disconnected immediately.</p>	<ul style="list-style-type: none"> ● If there is a setting for avoiding poor connections in the Wi-Fi setting menu of the Android device, turn it OFF.
<p>When this unit is connected to a wireless access point and "Image App" is started up, it cannot find this unit.</p>	<ul style="list-style-type: none"> ● Close "Image App", and press the Wi-Fi button on this unit to terminate the Wi-Fi connection. After that, reconnect this unit to the wireless access point, and start up "Image App".

How to Use the [Wi-Fi Setup] Menu

Configure various settings necessary to use the Wi-Fi function.

When connected to Wi-Fi, the settings cannot be changed.

- 1 Press **Wi-Fi** button on this unit and touch **[Wi-Fi Setup]**.  Wi-Fi
- 2 Touch desired menu item.

- The following Wi-Fi functions have been terminated.
Related menus, etc., will still be displayed, but they can no longer be used.
 - [Baby Monitor]
 - [Hom.Monitor]
 - [Live Cast]

[Set Wireless Access Point]

You can add or delete wireless access points, or rearrange the display order of wireless access points.

- Up to 3 wireless access points can be set.
- Please refer to page 144 for details about [Set Wireless Access Point].

To add a wireless access point

- 1 Touch the part where no wireless access points are displayed.
- 2 Configure the wireless access point settings.
(→ 144)

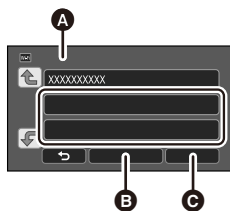



- A** [Set Wireless Access Point]
- B** [Delete]
- C** [EXIT]

To delete a wireless access point

- 1 Touch the wireless access point to be deleted.
 - 2 Touch **[Delete]**.
- The message is displayed. Touch **[YES]** to delete.

To switch the search order

- 1 Touch the access point you want to switch the order.
- 2 Switch the order by touching  or .

- To change the wireless access point, delete one of the registered wireless access points, and then add one.

[Wi-Fi Setup Wizard]

Please refer to page 143.

[Direct Connection]

Please refer to page 147.

[Direct Connection Password]

[ON]/[OFF]

This setting controls whether or not a password is required when you directly connect this unit and a smartphone to start remote operations or to use the Wireless Twin Camera function.

- If you select [OFF], you can directly connect this unit and a smartphone without entering the password for this unit's SSID into the smartphone.
- If you select [OFF], you cannot set up a connection with [Easy Connection (WPS)] or [QR code]. Set up a connection by setting this unit's SSID on the smartphone. (→ 147)
- The default setting is [OFF]. If you perform [Reset Wi-Fi Settings], the default setting will be restored. (→ 37, 154)

[Wireless Sub Camera]

You can use this unit as a Wireless Sub Camera.

For the connection procedure and other details, check the website below.

https://panasonic.jp/support/global/cs/e_cam

[ECONOMY (Wi-Fi)]

[ON]/[OFF]

If you set [ON], the LCD monitor turns off when remotely operating this unit with a smartphone (in Motion Picture Recording Mode or Still Picture Recording Mode) so that power consumption is reduced.

- When the LCD monitor is turned off, you can display the screen by touching it.
- If the Wi-Fi connection is turned off, this unit will turn off automatically approximately 15 minutes later.

[Wi-Fi Password]

[Setup]/[Delete]

This will set/clear the Password to limit the startup of the Wi-Fi setting menu. By setting the Password, it will prevent erroneous operation, prevent wrongful use of the Wi-Fi function by third party, and protect the set personal information.

1 Touch [Setup].

2 Touch [INPUT], and enter the Password (6 characters).

- After finish entering the Password, touch [Enter].
- If the Password has already been set, ✖ is displayed.
- For details on how to enter characters, refer to page 94.

3 Touch [NEXT].

4 Touch [INPUT], and enter the same Password again.

- After finish entering the Password, touch [Enter].
- If the Passwords match with each other, a message is displayed.

5 Touch [EXIT].

-
- If you set the Wi-Fi Password, you will need to enter the Password each time you touch [Wi-Fi Setup] on the Wi-Fi home screen.
 - When you forget your Wi-Fi Password, perform [Reset Wi-Fi Settings] from the Setup menu. This will set the Wi-Fi setting to the condition at the time of purchase, and you will be able to use the Wi-Fi setting menu. (→ 37)

[Reset Wi-Fi Settings]

You can change the Wi-Fi setting back to the default condition.

- The password for the Wi-Fi is deleted.
- Information on wireless access points, smartphones, and Wireless Sub Cameras registered to this unit is also deleted.

[Device Name]

You can view and change this unit's Device name (SSID), which is used for operating this unit as a wireless access point.

1 Touch [INPUT], and enter the desired Device name (SSID).

- Input up to 20 characters are recommended. All the characters cannot be confirmed when displaying the Device names on this unit if a long Device name is used. (→ 147)
- For details on how to enter characters, refer to page 94.
- Touch [Enter].

2 Touch [EXIT].

-
- If you are going to connect directly to a smartphone after changing the Device name (SSID), set the connection again with the changed Device name (SSID). (→ 147)
 - The Password entered during the setting of direct connection cannot be changed. (→ 147)

[Wireless LAN setup]

You can change or check your wireless LAN's network settings, such as the [IP Address], [Subnet Mask] and [MAC Address].

[IP Address]/[Subnet Mask]/[Gateway]/[Primary DNS]/[Secondary DNS]/[MAC Address]

- If you touch [AUTO], the network settings are configured automatically. If you touch [MANUAL], you can set each item. Select the item you want to set, and set it.
- [MAC Address] cannot be changed.

[Connection Test]

You can test the connection between this unit and the wireless access point. The following connections can be verified:

- Connection to the wireless access point

1 Touch [NEXT].

- The connection test starts.

2 Check the connection test result, and touch [EXIT].

- If the connection is successful, "○" is displayed. If the connection is not successful, "×" is displayed.

[PC Connect Setup]

[Change]/[Return to default]

You can change the workgroup setting.

- When copying scenes or still pictures to a PC using a Wi-Fi function [Copy], you need to create a shared folder on the PC and connect this unit to the workgroup to which the PC belongs. (The default setting is [WORKGROUP].)
- For information on how to create a shared folder, refer to page 138.

[Change]: Enter the name of the workgroup to which the destination PC belongs.

[Return to default]: This will set to the condition at the time of purchase.

- For details on how to enter characters, refer to page 94.
- A maximum of 15 characters can be entered.

Wireless Twin Camera function

When this unit and a smartphone are connected via Wi-Fi, you can display the image transmitted from the smartphone on this unit's Sub Window and record it simultaneously with the Main Camera's image. (Wireless Twin Camera)

■ Wireless Twin Camera



- A** Smartphone (Wireless Sub Camera)
- B** This unit (Main Camera)

Use your Wireless Sub Camera to enjoy recording your own face or any scenery different from what is being recorded with the Main Camera.

Recording different subjects in one motion picture



Recording the same subject from different angles

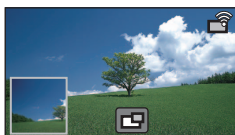

Recording a view seen from the subject



C Sub Window

- The image transmitted from the Wireless Sub Camera is displayed on the Sub Window.

These operating instructions describe the procedure for connecting this unit and a smartphone.

For information on non-smartphone devices that support the Wireless Sub Camera function and the procedures for using them, check the support website below. (As of January 2022)

https://panasonic.jp/support/global/cs/e_cam

Notes on the Wireless Twin Camera function

The performance of the Wireless Twin Camera function varies depending on the surrounding radio wave conditions. Since the human body blocks radio waves, it is also influenced by how crowded the area is.

■ Recording tips

- Use your Wireless Sub Camera in a position where as much of it as possible can be seen from the position of this unit.
- When the signal between this unit and the Wireless Sub Camera weakens, a warning icon appears. In such a case, close the distance between them.
- We recommend that you attach a tripod to this unit when recording.

■ When using a smartphone as a Wireless Sub Camera

- The Wireless Twin Camera function commands the smartphone to process images and transmit Wi-Fi signals.
- Image processing performance, Wi-Fi signal transmission performance, and the antenna location vary depending on the smartphone.
- The Sub Window's image, which is transmitted from the smartphone, is displayed with a slight delay compared to the Main camera's image.
- Depending on the device and environment, movement in the image transmitted from the smartphone may not look smooth or may look as if frames were missed. This is particularly the case with vertical orientation, which increases the smartphone's processing burden.

Keep the following points in mind when using a smartphone as a Wireless Twin Camera:

- We recommend that you use an Android device with a Quad Core or higher CPU or the latest iOS device.
- We recommend that you look at the image transmitted from your smartphone in advance to check the optimal recording distance for the smartphone, the easiest way to hold it, and other recording conditions.
- We recommend that you turn off the smartphone's GPS and Bluetooth functions, which may affect the Wireless Sub Camera's image.
- We recommend that you close as many other applications as possible.
- Recording consumes a large amount of battery power. When recording for a long period of time, pay attention to the remaining battery power.

-
- For information on the setup of your smartphone, refer to its operating instructions.
 - Please also refer to "If the Wi-Fi connection cannot be established". (→ 150)

Using a Smartphone as a Wireless Sub Camera

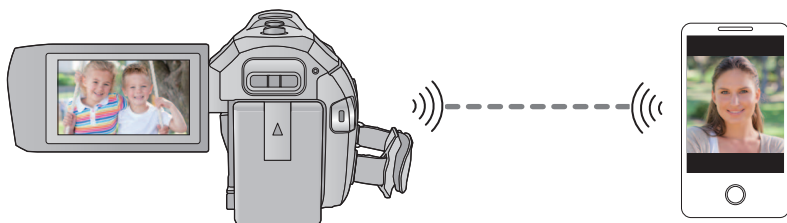

- You need to turn on the Wi-Fi function of your smartphone.
- Install the smartphone application “Image App” on your smartphone. (→ 141)

When connecting a smartphone to this unit as a Wireless Sub Camera for the first time

- The QR code is not displayed when [Direct Connection Password] (→ 153) is set to [OFF]. Refer to “Selecting this unit’s SSID and entering a password on the smartphone to set up a connection”
- The default setting for [Direct Connection Password] is [OFF].

■ Selecting this unit’s SSID and entering a password on the smartphone to set up a connection

1 (When using the Wi-Fi Setup menu)

Press **Wi-Fi** button on this unit and touch [TWIN CAMERA].

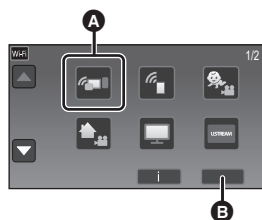

- A** [TWIN CAMERA]
- B** [EXIT]

(When using the recording screen)

Touch the recording screen on this unit and touch .



2 Touch [Smartphone] on the screen of this unit.

3 (When [Direct Connection Password] is set to [OFF]) On the smartphone, set the SSID displayed on the screen of this unit.

- When using an Android device, perform the following operations:

- 1 Start up the smartphone application "Image App".
- 2 On the smartphone, select [Wi-Fi], and select the SSID displayed on this unit.*

- When using an iOS device, perform the following operations:

- 1 On the smartphone, select the SSID displayed on this unit from the Wi-Fi setup menu.
- 2 Start up the smartphone application "Image App".*

* If this is the first time the smartphone is connecting to this unit, a message will be displayed on the screen of this unit. Touch [YES].

- When the connection is complete, the image being captured by the smartphone will be displayed on the Sub Window of this unit.

(When [Direct Connection Password] is set to [ON])

Touch [Wi-Fi] on the screen of this unit, and on the smartphone, set the SSID displayed on the screen of this unit.

- When using an Android device, perform the following operations:

- 1 Start up the smartphone application "Image App".
- 2 On the smartphone, select [Wi-Fi], and select the SSID displayed on this unit.
- 3 Enter the Password displayed on this unit.

- When using an iOS device, perform the following operations:

- 1 On the smartphone, select the SSID displayed on this unit from the Wi-Fi setup menu.
- 2 Enter the Password displayed on this unit.
- 3 Start up the smartphone application "Image App".

- When the connection is complete, the image being captured by the smartphone will be displayed on the Sub Window of this unit.

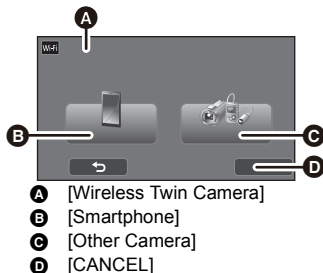

■ Scanning a QR code to set up a connection

1 (When using the Wi-Fi Setup menu)

Press **Wi-Fi** button on this unit and touch **[TWIN CAMERA]**.

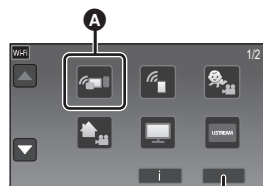

- A** [TWIN CAMERA]
- B** [EXIT]

(When using the recording screen)

Touch the recording screen on this unit and touch .



2 Touch **[Smartphone]** on the screen of this unit.

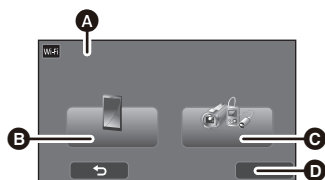

- A** [Wireless Twin Camera]
- B** [Smartphone]
- C** [Other Camera]
- D** [CANCEL]

3 Touch **[QR code]** on the screen of this unit.

4 Start up the smartphone application "Image App".

5 On the smartphone, select **[QR code]** to scan the QR code displayed on the screen of this unit.

● When using an iOS device, perform the following operations:

- 1** Select the option that allows you to install the app on the profile screen of the "Image App", and follow the on-screen instructions to complete the installation.
 - 2** Press the home button to close the displayed screen.
 - 3** Touch **[NEXT]** on the screen of this unit to display its SSID.
 - 4** After selecting the network name (SSID) of this unit from the Wi-Fi setup of the smartphone, start up "Image App".
- When the connection is complete, the image being captured by the smartphone will be displayed on the Sub Window of this unit.
- If the QR code cannot be scanned, refer to "Selecting this unit's SSID and entering a password on the smartphone to set up a connection". (→ 158)

When connecting for the second time or later

- 1 Touch the recording screen on this unit and touch .**
- 2 Start up the smartphone application “Image App”.**



- This unit and the smartphone will be connected via Wi-Fi. When the connection is complete, the image being captured by the smartphone will be displayed on the Sub Window of this unit.
- If the connection cannot be established or no image appears on the Sub Window, follow the steps below to set up the connection again:
 - 1** Close the smartphone application “Image App”.
 - 2** Touch the screen of this unit again and touch .
 - 3** Touch [Change Device] on the screen of this unit.

After completing the steps above, follow the procedure from Step 2 onwards in “When connecting a smartphone to this unit as a Wireless Sub Camera for the first time”.

- [History] allows you to set up a Wi-Fi connection with the Wi-Fi function settings you have used before. (→ 149)

Terminating the connection

- 1 Touch the recording screen on this unit and touch .**
- 2 Touch [EXIT] on the screen of this unit.**



- The Wi-Fi connection will be terminated.
 - Close the “Image App” on the smartphone.
-
- You can also terminate the connection by pressing the Wi-Fi button on this unit. If you press the Wi-Fi button during recording pause, a message will be displayed. To terminate the connection, touch [YES].

Recording with a Wireless Sub Camera (Wireless Twin Camera)

- An image recorded with the Main Camera and the Wireless Sub Camera's image displayed on the Sub Window are recorded as a single scene or still picture. When you play back such a scene or still picture, it is not possible to delete only the Sub Window image or hide it.
- If you set [Backup for Twin Camera] to [ON], when recording images with the Wireless Twin Camera function, you can also record the Main Camera's image without the Sub Window image as a separate scene. (→ 43)

- 1 Connect a smartphone to this unit as a Wireless Sub Camera. (→ 158)
- 2 Start recording.

Screen display when using a Wireless Sub Camera

■ Connection status icons for a Wireless Sub Camera

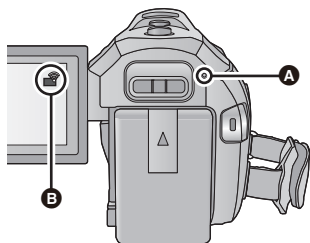





A Lit green



- The status indicator is lit green when the Wireless Twin Camera function is activated.
- When Wi-Fi is disconnected, the status indicator is lit red again.

B Connection status icon for a Wireless Sub Camera

When a Wireless Sub Camera is connected :

The display will change as follows according to the radio wave intensity:  (Weak) →  →  → 
(Strong).

When the Wi-Fi signal weakens

If the signal weakens when the Sub Window is displayed, the connection status icon changes to  (Weak) and  flashes on the Sub Window.

If the signal weakens further, the connection status icon changes to  and the Sub Window image disappears. (You cannot operate the Sub Window.)

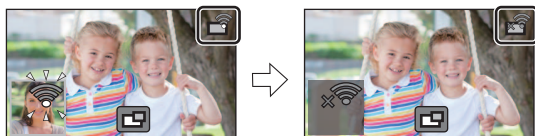

- You can operate the Sub Window again when the signal becomes stronger.

-
- Your Wi-Fi connection may be terminated depending on the smartphone.

■ Displaying or hiding the Sub Window

Touch .

- Each time you touch the icon, you can display or hide the Sub Window.
- When the Sub Window is hidden, the image of the smartphone will not be recorded.





■ Sub Window size when using a Wireless Twin Camera

The size of the image displayed on the Sub Window varies depending on the smartphone camera and the orientation of the smartphone.

Example: Sub Window display when the Main Camera's aspect ratio is set to 16:9

(The yellow frames correspond to the size of the image to be displayed on the Sub Window.)

Smartphone orientation	Vertical	Horizontal*
Sub Window display		



* Depending on the smartphone, it may not be possible to use horizontal orientation.

Changing the display position of the Sub Window

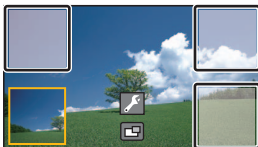
- 1 Touch Sub Window.
 - 2 Touch the display position you want to change.
- Depending on the display position of the Sub Window, the positions of the icons displayed on the screen may change.



Changing the colour of the Sub Window frame



- 1 Touch Sub Window.
- 2 Touch .
- 3 Touch , and select the desired frame.

- ① : Pink
- ② : Green
- ③ : Orange
- ④ : Grey
- ⑤ : Drop shadow*
- ⑥ : No frame

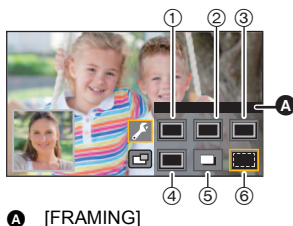
* This adds a drop shadow on the right and bottom sides.



A [FRAMING]

- It takes some time until the Sub Window appears.
- You cannot set this unit to Playback Mode when it is connected to a Wireless Sub Camera.
- Simultaneous recording of still pictures is not possible while recording a motion picture or using PRE-REC with the Wireless Twin Camera function.
- The following button icons may not be displayed when the Sub Window is displayed. To display them, touch the Main Camera's image on the screen.
 -  (Touch Menu)
 -  (Zoom button icons)
 -  (Recording button icon)
 - Recording Mode button icon (→ 45)
- The following functions do not work:
 - Creative Control
 - HDR Movie Mode
 - FULL HD Slow Motion Video Mode
 - Stop Motion Animation Assist Mode
 - Setup menu items
 - Switching to a Wi-Fi function other than Wireless Twin Camera

- The following functions do not work when the Sub Window is displayed:
 - Touch Shutter
 - [FACE FRAMING]
 - AF/AE tracking
 - Optical Image Stabilizer Lock
 - AF assist lamp
- You cannot change the following settings:
 - Sub Window settings (WB/Brightness/Focus)
- Depending on recording conditions, the colour balance, brightness and other settings may differ between the Main Camera and the Wireless Sub Camera.
- Recording menu items, operation icons, and functions such as Image Stabilizer, Level Shot Function and [QUICK POWER ON] work only for the Main Camera.
- When you record still pictures by using the Wireless Twin Camera function, it may take longer than usual to achieve focus. (→ 25)
- The Fade function's image effects do not affect the Sub Window.
- When no image is transmitted to the Sub Window continuously for approximately 4 minutes or longer, the Wi-Fi connection will be terminated.
- When the "Image App" screen disappears, image transmission to the Sub Window stops. (The Wi-Fi connection stays connected.) This may occur when, for example, the smartphone receives a call or you press the home button.
If you start up "Image App" on the smartphone again, image transmission to the Main Camera will restart and the Sub Window will be displayed automatically.
- You cannot record Wireless Twin Camera images on the smartphone.

If the Wi-Fi connection cannot be established (Wireless Twin Camera)

- For information on the setup of your smartphone, refer to its operating instructions.

Problem	Check points
<p>Cannot connect this unit to the smartphone.</p> <p>No image on the Sub Window.</p>	<ul style="list-style-type: none"> • Make sure the smartphone is properly connected to this unit by checking the Wi-Fi settings of the smartphone. • If the smartphone is connected to a wireless access point or another video camera that supports the Wireless Twin Camera function, select the SSID of this unit from the smartphone's Wi-Fi setup menu, and restart the "Image App". • If you are unsure about the SSID of this unit, connecting to a smartphone different from the previously connected smartphone or changed the [Direct Connection Password] setting after connecting to a smartphone, follow the steps below to set up the connection again: <ol style="list-style-type: none"> ① Close the "Image App" on the smartphone. ② Press Wi-Fi button on this unit and touch [TWIN CAMERA]. ③ Follow the procedure from Step 2 onwards in "When connecting a smartphone to this unit as a Wireless Sub Camera for the first time". (→ 159, 160)
<p>The Sub Window image is interrupted.</p> <p>The Sub Window image disappears.</p>	<ul style="list-style-type: none"> • The Sub Window image is interrupted when the Wi-Fi signal weakens. If the signal weakens further, the Sub Window image disappears automatically. • Depending on the orientation of this unit and the smartphone and the distance between them, the image may be interrupted. If the image reception is poor, close the distance and check the connection status icon (→ 162) at the same time. You can also point the Wi-Fi transmitter (→ 10) at the smartphone.

- Please also refer to "If the Wi-Fi connection cannot be established". (→ 150)

What you can do with a PC

HD Writer AE 5.2

You can copy the motion/still picture data to the HDD of PCs or write to media like Blu-ray discs, DVD discs or SD cards using HD Writer AE 5.2.

Check the website below to download/install the software.

- The software is available for download until the end of March 2026.

https://panasonic.jp/support/global/cs/soft/download/f_ae52.html

- Refer to the operating instructions of HD Writer AE 5.2 (PDF file) for details on how to use it. (→ 177)

■ Smart Wizard

The Smart Wizard Screen is automatically displayed when you connect this unit to a PC with HD Writer AE 5.2 installed. (→ 174)



Copy to PC:

You can copy motion/still picture data to the HDD of PCs.

Copy to disc:

You can copy to disc in high-definition picture quality or conventional standard picture quality (MPEG2 format).

- Select the function you wish to use and follow the on-screen instructions for easy copying.

What can be done with the HD Writer AE 5.2	Data type
Copying data to a PC	Motion picture and still picture
Copying in Blu-ray disc/AVCHD format: <ul style="list-style-type: none"> • The scenes recorded in 1080/50p can be copied as 1080/50p. (→ 168: Important Notice) • MP4/iFrame scenes cannot be copied in Blu-ray disc or in AVCHD format. 	
Copying in DVD-Video format: <ul style="list-style-type: none"> • Converted to conventional standard quality (MPEG2 format). 	Motion picture
Editing: Editing motion picture data copied on an HDD of a PC <ul style="list-style-type: none"> • Dividing, Trimming, Still picture, Title, Effect, Transition, BGM, Delete partially • Converting the motion picture data to MPEG2 • Converting part of motion picture into still picture 	

What can be done with the HD Writer AE 5.2	Data type
Online sharing: You can upload motion pictures on the Internet and share them with your family and friends.	Motion picture
Playing back on a PC: Play back the motion picture data in high-definition picture quality on a PC.	Motion picture and still picture
Formatting discs: Depending on the type of disc that you use, formatting is necessary.	Motion picture

- It is possible to play back still pictures on a PC using a image viewer standard to Windows or commercially available image browsing software, and copy still pictures to a PC using Windows Explorer.
- Please refer to page [178](#) for details about using a Mac.

Important Notice

- Do not insert a disc recorded in AVCHD format with HD Writer AE 5.2 in a device that does not support the AVCHD format. In some cases the disc may get stuck in the device.
- To play back a Blu-ray disc to which you have copied scenes recorded in 1080/50p, equipment is required that supports AVCHD Progressive.
- When inserting a disc containing recorded motion pictures into other devices, a message prompting you to format the disc may be displayed. Do not format the disc, since deleted data cannot be restored later.

- It is impossible to write data to this unit from a PC.
- Motion pictures that have been recorded on another device cannot be written to the software supplied with this unit.
- When motion picture data is written to and read from the SD card, correct operation of the unit cannot be guaranteed if software other than HD Writer AE 5.2 is used.
- Do not start HD Writer AE 5.2 and other software at the same time.

Before Installing HD Writer AE 5.2

Your installation or use of the Software defined below shall be conclusively deemed to constitute your acceptance of the terms of this Agreement. If you do not accept the terms of this Agreement, do not install, nor use the Software.

End User License Agreement

You ("Licensee") are granted a license for the Software defined in this End User License Agreement ("Agreement") on condition that you agree to the terms and conditions of this Agreement.

The following terms contain material representations regarding the disclaimers of Panasonic Corporation. Be sure to read through, understand and confirm the following terms.

Article 1 License

Licensee is granted the right to use the Software (the "Software" means the Software and other information such as manuals downloaded by Licensee through Panasonic website), but all applicable rights to patents, copyrights, trademarks and trade secrets in the Software are not transferred to Licensee.

Article 2 Use by a Third Party

Licensee may not use, copy, modify, transfer, rent, lease, lend or allow any third party, whether free of charge or not, to use, copy or modify the Software, except as expressly provided for in this Agreement.

Article 3 Restrictions on Copying the Software

Licensee may make a single copy of the Software in whole or a part solely for back-up purpose.

Article 4 Computer

Licensee may use the Software only on one computer, and may not use it on more than one computer. Further, Licensee may not use the Software for commercial software hosting services.

Article 5 Reverse Engineering, Decompiling or Disassembly

Licensee may not reverse engineer, decompile, or disassemble the Software, except to the extent either of them is permitted under law or regulation of the country where Licensee resides. Panasonic, or its distributors will not be responsible for any defects in the Software or damage to Licensee caused by Licensee's reverse engineering, decompiling, or disassembly of the Software.

Article 6 Indemnification

The Software is provided "AS-IS" without warranty of any kind, either expressed or implied, including, but not limited to, warranties of non-infringement, merchantability and/or fitness for a particular purpose. Further, Panasonic does not warrant that the operation of the Software will be uninterrupted or error free. Panasonic or any of its distributors will not be liable for any damage suffered by Licensee arising from or in connection with Licensee's use of the Software.

Article 7 Export Control

Licensee agrees not to export or re-export to any country the Software in any form without the appropriate export licenses under regulations of the country where Licensee resides, if necessary.

Article 8 Termination of License

The right granted to Licensee hereunder will be automatically terminated if Licensee contravenes any of the terms and conditions of this Agreement. In this event, Licensee must destroy the Software and related documentation together with all the copies thereof at Licensee's own expense.

Article 9 With regard to MICROSOFT SQL SERVER COMPACT 3.5 produced by Microsoft Corporation

(1) Licensee shall use the MICROSOFT SQL SERVER COMPACT 3.5 only when included in the Software, and shall not use the MICROSOFT SQL SERVER COMPACT 3.5 in any other configuration or method. Licensee shall not publish the MICROSOFT SQL SERVER COMPACT 3.5 or work around any technical limitations in the MICROSOFT SQL SERVER COMPACT 3.5.

(2) Licensee shall not use, copy, distribute, regrant for use or otherwise handle the Software in any way beyond the range of use granted under Article 9 (1), and shall not conduct operations such as reverse engineering, decompilation, disassembling, etc. of the MICROSOFT SQL SERVER COMPACT 3.5.

(3) All rights, including copyright, patent rights etc. relating to the MICROSOFT SQL SERVER COMPACT 3.5 shall belong to Microsoft Corporation. Licensee shall not claim any rights related to the MICROSOFT SQL SERVER COMPACT 3.5 whatsoever.

Operating environment

- Even if the system requirements mentioned in these operating instructions are fulfilled, some PCs cannot be used.
- A compatible Blu-ray disc/DVD writer drive and media are necessary for writing to a Blu-ray disc/DVD.
- Operation is not guaranteed in the following cases.
 - When 2 or more USB devices are connected to a PC, or when devices are connected through USB hubs or by using extension cables.

■ Operating environment for HD Writer AE 5.2

OS	Windows 10 (32 bit/64 bit) Windows 8.1 (32 bit/64 bit)
CPU	Intel Pentium 4 2.8 GHz or higher (including compatible CPU) <ul style="list-style-type: none"> • Intel Core 2 Duo 2.16 GHz or higher or AMD Athlon 64 X2 Dual-Core 5200+ or higher is recommended when using playback function. • Intel Core 2 Quad 2.6 GHz or higher is recommended when using editing function. • Intel Core i7 2.8 GHz or higher is recommended when using playback or editing function for 1080/50p.
RAM	2 GB or more (64 bit)/1 GB or more (32 bit)
Display	High Colour (16 bit) or more (32 bit or more recommended) Desktop resolution of 1024×768 pixels or more (1920×1080 pixels or more recommended) Graphics card complying with DirectX 9.0c (DirectX 10 recommended) and DirectDraw overlay PCI Express™×16 compatible recommended Video memory of 256 MB or more recommended
Free hard disk drive space	Ultra DMA — 100 or higher 450 MB or more (for installing the software) <ul style="list-style-type: none"> • If the compression setting is enabled, errors will occur during recording. Clear the check box for [Compress this drive to save disk space] in [Properties] for the hard disk drive.
Sound	DirectSound Support
Interface	USB port
Other requirements	Mouse or equivalent pointing device Internet connection

- HD Writer AE 5.2 is only for Windows.
- Input is not supported in languages other than English, German, French, Simplified Chinese and Russian.
- Operation cannot be guaranteed on all Blu-ray disc/DVD drives.
- Operation is not guaranteed on Windows 8.1 Enterprise, Windows 10 Enterprise or Windows RT.
- For Windows 8.1/Windows 10, this software is available only as a desktop application.
- This software is not compatible with a multi-boot environment.
- This software is not compatible with a multi-monitor environment.
- If using Windows 8.1/Windows 10, administrative account and standard account users only can use this software. (An administrative account user should install and uninstall this software.)

■ To use the HD Writer AE 5.2

You will need a high performance PC depending on the functions to be used. It may not properly play back or properly operate depending on the environment of the PC used. Refer to the operating environment and notes.

-
- Operation during the playback may become slow if the CPU or memory is not fulfilling the requirements of the operating environment.
 - Always use the most current driver for the video card.
 - Always make sure there is enough capacity on the HDD in the PC. It may become inoperable or the operation may stop suddenly if the capacity gets low.

■ Operating environment for the card reader function (mass storage)

OS	Windows 10 (32 bit/64 bit) Windows 8.1 (32 bit/64 bit)
CPU	1 GHz or higher 32-bit (×86) or 64-bit (×64) processor (including compatible CPU)
RAM	2 GB or more (64 bit)/1 GB or more (32 bit)
Interface	USB port
Other requirements	Mouse or equivalent pointing device

- The USB equipment operates with the driver installed as standard in the OS.

Installation

When installing the software, log on to your computer as the Administrator or with a user name with equivalent authorisation. (If you do not have authorisation to do this, consult your manager.)

- Before starting the installation, close all applications that are running.
- Do not perform any other operations on your PC while the software is being installed.
- Explanation of operations is based on Windows 10.

■ Installing HD Writer AE 5.2



Check the website below to download/install the software.

- The software is available for download until the end of March 2026.

https://panasonic.jp/support/global/cs/soft/download/f_ae52.html

■ Uninstalling HD Writer AE 5.2

Follow the steps below to uninstall any software applications that you no longer require.

- 1** Select [] → [] (**Settings**) → [**Apps**] → [**Apps & features**].
 - 2** Select [**HD Writer AE 5.2**], then click [**Uninstall**].
- Proceed with the uninstallation by following the on-screen instructions.
 - After uninstalling the software, be sure to reboot the PC.

Connecting to a PC

- Connect this unit to the PC after the software applications are installed.

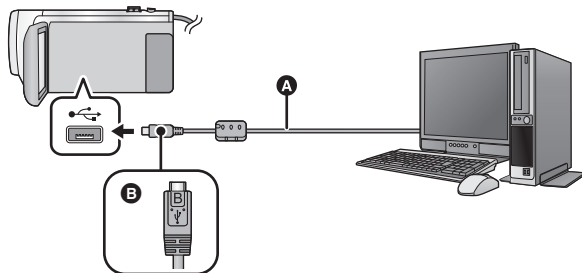

- A** USB cable (supplied)
 - B** Turn the side with the symbol up to connect the micro B end of the USB Cable to the USB terminal of this unit.
- Insert the plugs as far as they will go.

1 Connect this unit to the AC adaptor.

- Use the AC adaptor to free you from worrying about the battery running down.

2 Turn on the unit.

3 Connect this unit to a PC.

- The USB function selection screen will appear.

4 Touch [PC] on the screen of this unit.

- The Smart Wizard Screen is automatically displayed when HD Writer AE 5.2 is installed.
- This unit is automatically recognised as an external drive of the PC. (→ 176)
- When you select an option other than [PC], reconnect the USB cable.
- When using the battery, the LCD monitor turns off after about 5 seconds. Touch the screen to turn the LCD monitor on.

-
- Do not use any other USB cables except the supplied one. (Operation is not guaranteed with any other USB cables.)
 - When this unit is connected to a PC using a USB cable while the unit is turned on, power is also supplied from the PC to this unit.
 - When performing reading/writing between a PC and an SD card, be aware that some SD card slots built into PCs and some SD card readers are not compatible with the SDHC Memory Card or SDXC Memory Card.

■ To disconnect USB cable safely

Select the  icon in task tray displayed on the PC, and then select the model number of this unit to disconnect the USB cable.

- Depending on your PC's settings, this icon may not be displayed.

About the screen indication of the unit

- Do not disconnect the USB cable, battery, or AC adaptor while the access lamp is on or card access icon () appears on the unit screen.
- If the screen does not change when the unit is operated while connected to a PC, disconnect the battery and/or AC adaptor, wait approximately 1 minute, reconnect the battery and/or AC adaptor, wait approximately 1 minute again, and then turn the unit back on. (Data may be destroyed when above operation is performed while accessing the SD card.)

■ Charging the battery by connecting it to different devices

When using the battery, if you turn off the unit and connect it to a PC, Panasonic Blu-ray disc recorder or Panasonic DVD recorder, the battery will charge.

- **When connecting this unit to a PC for the first time, make sure to connect this unit to the PC with this unit turned on.**
- Insert the USB cable securely all the way. It will not operate properly if it is not inserted all the way.
- Do not use any other USB cables except the supplied one. (Operation is not guaranteed with any other USB cables.)
- You cannot charge the battery by connecting the supplied DC cable.
- Be sure to connect the unit directly to the PC, Blu-ray disc recorder or DVD recorder.
- During charging, the status indicator flashes.
- You cannot charge when the status indicator flashes rapidly, or when it does not light at all. Charge using the AC adaptor. (→ 12)
- It will take 2 or 3 times longer to charge compared to when using the AC adaptor.
- If the status indicator flashes at a particularly fast or slow rate, refer to page 191.

About the PC display

When the unit is connected to a PC, it is recognised as an external drive.

- Removable disk (Example:  CAM_SD (G:)) is displayed in [This PC].

We recommend using HD Writer AE 5.2 to copy motion picture data.

Using Windows Explorer or other programmes on the PC to copy, move or rename files and folders recorded with this unit will result in them being unusable with HD Writer AE 5.2.

It is impossible to write data to SD card on this unit from a PC.

Example folder structure of an SD card:

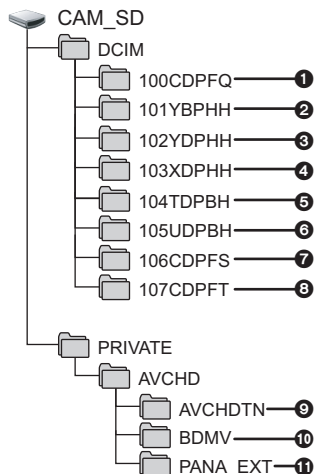

The following data will be recorded.

- 1 Up to 999 still pictures in JPEG format ([S1000001.JPG] etc.)
- 2-5 MP4 format motion picture files ([S1000001.MP4] etc.)
 - 2 MP4 (1080/50p)
 - 3 MP4 (1080/25p)
 - 4 MP4 (720/25p)
 - 5 MP4 (360/25p)
- 6 iFrame format motion picture files ([S1000001.MP4] etc.)
- 7 JPEG format still pictures created from the motion picture
- 8 JPEG format still pictures recorded in Stop Motion Animation Assist Mode
- 9 The motion picture thumbnails
- 10 AVCHD format motion picture files ([00000.MTS] etc.)
- 11 For management

■ Copying your still pictures to your PC

Card reader function (mass storage)

Still pictures recorded with this unit can be copied to the PC with Explorer or other programmes.

- 1 Double-click the folder that contains the still pictures. ([DCIM] → [100CDPFQ] etc.)
- 2 Drag and drop the still pictures onto the destination folder (on the PC's HDD).

- Do not delete the SD card's folders. Doing so may make the SD card unusable in this unit.
- Do not delete or edit files on the SD card or USB HDD on the PC. If you do so, this unit may not be able to read these files or its functions may not operate correctly.
- When data not supported by this unit has been recorded on a PC, it will not be recognised by this unit.
- Always use this unit to format SD cards.

With a PC

Starting HD Writer AE 5.2

- To use the software, log on as an Administrator or as user name for standard user account. The software cannot be used with the user name for a guest account.

(On the PC)

Select [Start] → [Panasonic] → [HD Writer AE 5.2].

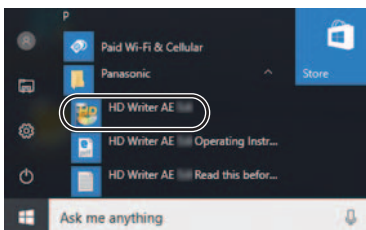

- For details on how to use the software applications, read the PDF operating instructions of the software.

Reading the operating instructions of the software applications

- You will need Adobe Acrobat Reader 5.0 or later or Adobe Reader 7.0 or later to read the PDF operating instructions.

Select [Start] → [Panasonic] → [HD Writer AE 5.2 Operating Instructions].

If using Mac (mass storage)

- HD Writer AE 5.2 is not available for Mac.
- iMovie and Final Cut Pro X supported. For details about iMovie and Final Cut Pro X, please contact Apple Inc.

■ Operating environment

PC	Mac
OS	macOS 11.2
CPU	Intel Core 2 Duo or better
RAM	2 GB or more
Interface	USB port
Other requirements	Mouse or equivalent pointing device

- Even if the system requirements mentioned in these operating instructions are fulfilled, some computers cannot be used.
- The USB equipment operates with the driver installed as standard in the OS.

■ Copying still pictures on a Mac

1 Connect this unit to a Mac via the supplied USB cable.

- The USB function selection screen will appear.

2 Touch [PC] on the screen of this unit.

- This unit is automatically recognised as an external drive of Mac.
- When you select an option other than [PC], reconnect the USB cable.
- When using the battery, the LCD monitor turns off after about 5 seconds. Touch the screen to turn the LCD monitor on.

3 Double-click [CAM_SD] displayed on the desktop.

- Files are stored in [100CDPFQ] or [102CDPFT] folder etc. in the [DCIM] folder.

4 Using a drag-and-drop operation, move the pictures you want to acquire or the folder storing those pictures to any different folder on the Mac.

■ To disconnect USB cable safely

Drag [CAM_SD] disk icon to the [Trash], and then disconnect the USB cable.

Indications

■ Recording indications

Motion Picture Recording Mode

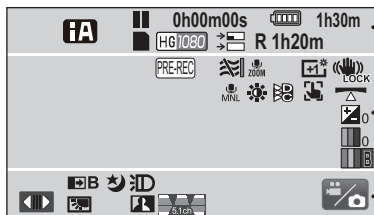

Still Picture Recording Mode

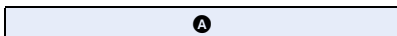
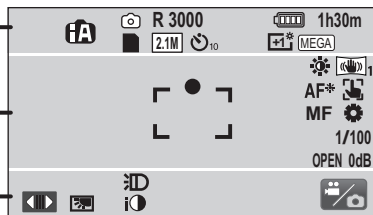

Intelligent Auto Mode (→ 46)



Intelligent Auto Plus Mode (→ 48)



Creative Control Mode (→ 48)

HDR HDR Movie Mode (→ 51)



Scene Mode (→ 52)

MNL Manual Mode (→ 56)

FULL HD Slow Motion Video Mode (→ 53)

Stop Motion Animation Assist Mode (→ 55)

●/II (Red) Recording

II (Green) Recording pause

0h00m00s Elapsed recording time (→ 23)

("h" is an abbreviation for hour, "m" for minute and "s" for second.)

Remaining battery power (→ 14)

1h30m Remaining battery time (→ 14)

(White) Card recording possible status

(Green) Recognising the card

1080/50p / PH1080 / HA1080 / HG1080 / HE1080 /
1080 50FPS / 1080 30FPS / 720 30FPS / iFrame 30FPS

Motion Picture Recording Mode (→ 72)

Backup for Twin Camera (→ 43)

R 1h20m Remaining time for motion picture recording (→ 23)

(White) Still picture recording icon

(Red) Recording still picture

R3000 Remaining number of still pictures (→ 26)



















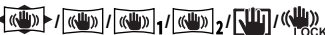

24M / 12.6M / 2.1M / 18M / 8M / 0.3M / 20M / 10.6M / 2M















Number of recording pixels for still pictures (→ 26, 81, 85)

In Playback Mode, the picture size is not displayed for still pictures recorded with other products that have different picture sizes from the sizes shown above.

10 / 2 Self-timer Recording (→ 67)

MEGA MEGA OIS (→ 25)

B	
	PRE-REC (→ 66)
	Time Lapse Recording (→ 50)
	Wind Noise Canceller (→ 76)
	Lowcut (→ 76)
	Zoom Microphone (→ 78)
	Focus Microphone (→ 78)
	Stereo Microphone (→ 78)
	Power LCD (→ 36)
	Image Stabilizer (→ 61)/ Optical Image Stabilizer Lock (→ 63)
	Sound Scene Select (→ 77)
	Picture Adjustment (→ 80)
	Digital Cinema Colour (→ 75)
	Brightness Adjustment (Miniature Effect/8mm movie/ Silent movie) (→ 49, 50)
	Vividness Adjustment (Miniature Effect) (→ 49)
	Colour balance Adjustment (8mm movie) (→ 50)
HDR 	HDR Effect (→ 69)
	AF/AE tracking (→ 62)
	Level Shot Function (→ 42)
	Touch Shutter (→ 64)
MF	Manual Focus (→ 59)
	White Balance (→ 57)
1/100	Shutter Speed (→ 58)
OPEN/F2.0	Iris value (→ 58)
0dB	Gain value (→ 58)
○ (White) ● (Green)	
Focus indication (→ 25)	
AF*	AF assist lamp (→ 82)

C	
	Display Touch Menu (→ 20)
	Backlight Compensation (→ 67)
	Intelligent Contrast Control (→ 66)
	Microphone Level (→ 79)
	Sound recording disabled (→ 53)
	Fade (White), Fade (Black) (→ 66)
	Night Mode (→ 68)
	Video Light (→ 68)
	Intelligent Exposure (→ 67)
	Wide Conversion Lens setting (→ 76)
	World Time setting (→ 31)
	Sub Window icon (→ 163)
	Sub Camera setting icon (→ 164)
	Recording mode switching icon (→ 18)
15. 11. 2022	Date indication (→ 21)
12:34	Time indication (→ 21)

■ Playback indications



Display during playback (→ 28, 83)

0h00m00s	Playback Time (→ 28)
No.10	Scene Number
	Repeat Playback (→ 86)
	Resume Playback (→ 86)
100-0001	Still picture folder/file name
	Protected motion pictures/still pictures (→ 110)



Play mode selection display (→ 27)

	AVCHD [1080/50p] scene (→ 27)
	AVCHD [PH] scene (→ 27)
	AVCHD [HA] scene (→ 27)
	AVCHD [HG] scene (→ 27)
	AVCHD [HE] scene (→ 27)
	MP4 [1080/50p (50M)] scene (→ 28)
	MP4 [1080/50p (28M)] scene/ MP4 [1080/25p] scene (→ 28)
	MP4 [720/25p] scene (→ 28)
	MP4 [360/25p] scene (→ 28)
	iFrame scene (→ 28)
	FULL HD Slow Motion Video-recorded scene (→ 53)
MINI	Miniature-recorded scene (→ 49)
	Time lapse-recorded scene (→ 50)
	Scenes saved with Highlight Playback (→ 95)

■ Indication of connection to Wi-Fi

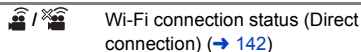
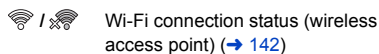

■ Indication of connection to USB HDD



■ Indication of connection to other devices

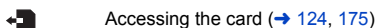

■ Confirmatory indications

-- (Time display) The built-in battery is low. (→ 21)

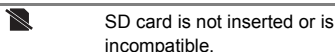
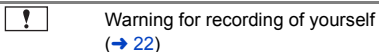

■ Indication of Wireless Twin Camera

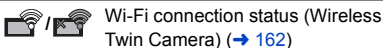
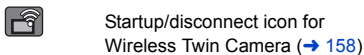

■ Indication of Sub Window

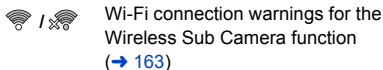

Messages

Major confirmation/error messages to be indicated on the screen in text.

CHECK CARD.

This card is not compatible or it cannot be recognised by the unit.

If this message appears even though motion pictures and still pictures are recorded on an SD card, the card may be unstable. Reinsert the SD card, then turn the unit off and then on again.

THIS BATTERY CANNOT BE USED.

- Use a battery that is compatible with this unit. (→ 11)

If using a Panasonic battery compatible with this unit, remove the battery and then insert it again. If the message appears even after repeating this several times, this unit needs repair. Detach the power and consult the dealer who you purchased this unit from. Do not attempt to repair it by yourself.

- You are attempting to connect an AC adaptor not compatible with this unit. Use the supplied AC adaptor. (→ 12)

THIS EXTERNAL DRIVE CANNOT BE USED./

PLEASE CHECK THE EXTERNAL DRIVE.

The external drive that this unit cannot recognise is connected. Check if the USB HDD can be connected and used with this unit and try to reconnect. (→ 118)

Failed to connect wireless access point/

No wireless access point found

- Check the Wi-Fi set up of your wireless access point and smartphone.
- [Easy Connection (WPS)] can establish a connection only between two devices: this unit and a device that will connect to this unit. Check if multiple devices are trying to establish a connection in the WPS waiting state simultaneously.
- Read page 150 if the Wi-Fi connection cannot be established.

Network disconnected.

- When using [DLNA Play], if you do not operate the DLNA-compatible device you are connected to for a while, it will be displayed. Check the status of the DLNA device you are connected to.

About recovery

If faulty management information is found, the messages may appear and a repair is performed. (Repairing may take time depending on the error.)

-  is displayed when abnormal management information is detected when the scenes are displayed in thumbnail.
-

- Use a sufficiently charged battery or the AC adaptor.
- Depending on the condition of the data, it may not be possible to completely repair the data.
- If recovery fails, it will not be possible to play back scenes recorded before the unit turned off.
- When data recorded on another device is recovered, it may not be possible to play back the data on this unit or the other device.
- If recovery fails, turn the unit off and on again after waiting a while. If recovery fails repeatedly, format a media on the unit. Please be aware that if a media is formatted, then all the data recorded on the media will be erased.
- If the thumbnail information is recovered, displaying the thumbnails may become slower.
- You cannot recover information on scenes recorded as Backup for Twin Camera and Highlight Playback scenes in MP4 format.



Troubleshooting

■ It is not a malfunction in following cases

A clicking sound is heard when the unit is shaken.	<ul style="list-style-type: none"> This is the sound of the lens moving and is not a defect. This sound will no longer be heard when the unit is turned on and set this unit to the Motion Picture Recording Mode or Still Picture Recording Mode.
Object seems to be warped.	<ul style="list-style-type: none"> Object seems to be warped slightly when the object moves across the image very fast, but this is because the unit is using MOS for the image sensor. This is not a malfunction.
The lens or LCD monitor fog up.	<ul style="list-style-type: none"> This is due to condensation. It is not a malfunction. Please refer to page 2.

Power	
Problem	Check points
<p>This unit cannot be turned on.</p> <p>This unit does not stay on long enough.</p> <p>Battery runs down quickly.</p>	<ul style="list-style-type: none"> Charge the battery again to ensure it is sufficiently charged. (→ 12) In cold places, the battery using time becomes shorter. The battery has a limited life. If the operating time is still too short even after the battery is fully charged, the battery has worn out and needs to be replaced.
This unit is turned off automatically.	<ul style="list-style-type: none"> If the unit turns off when you turn off the power to the TV using the TV remote control, the VIERA Link is at work. If you are not using the VIERA Link, set [VIERA Link] to [OFF]. (→ 116)
<p>This unit cannot be operated though it is turned on.</p> <p>This unit does not operate normally.</p>	<ul style="list-style-type: none"> Remove the battery or AC adaptor, wait about 1 minute and then reconnect the battery or AC adaptor. Then about 1 minute later, turn on the unit again. (Conducting the above operation while the media is being accessed may damage the data on the media.) If normal operation is still not restored, detach the power connected, and consult the dealer who you purchased this unit from.
"ERROR OCCURRED. PLEASE TURN UNIT OFF, THEN TURN ON AGAIN." is displayed.	<ul style="list-style-type: none"> The unit has automatically detected an error. Restart the unit by turning the unit off and on. The unit will be turned off in about 1 minute if the unit is not turned off and on. Repair is needed if it is repeatedly displayed even if it is restarted. Detach the power connected, and consult the dealer who you purchased this unit from. Do not attempt to repair the unit by yourself.

Indication	
Problem	Check points
Remaining battery indication is not displayed properly.	<ul style="list-style-type: none"> The remaining battery capacity indication is an approximation. If the remaining battery capacity indication is not displayed correctly, fully charge the battery, discharge it and then charge it again.

Recording	
Problem	Check points
The unit arbitrarily stops recording.	<ul style="list-style-type: none"> Use an SD card that can be used for motion picture recording. (→ 15) The recordable time may have shortened due to the deterioration of the data writing speed or repeated recording and deletion. Using the unit, format the SD card. (→ 38) If [AGS] is [ON], record in the normal horizontal position or set [AGS] to [OFF]. (→ 74)
Auto Focus function does not work.	<ul style="list-style-type: none"> Switch to Intelligent Auto Mode or Intelligent Auto Plus Mode. If you are trying to record a scene which is hard to bring into focus in Auto Focus Mode, use the Manual Focus Mode to adjust the focus. (→ 47, 59)
Colour balance of images is strange when recording in a place such as a gymnasium.	<ul style="list-style-type: none"> In a place with multiple light sources, such as a gymnasium or a hall, set the White Balance setting to  (Indoor mode 2). If you cannot record clearly with the  (Indoor mode 2), set it to  (Manual adjustment mode). (→ 57)
<p>Colour or brightness of the image changes, or you may see horizontal bars in the image.</p> <p>The LCD monitor flickers indoors.</p>	<ul style="list-style-type: none"> Colour or brightness of the image may change, or you may see horizontal bars in the image when the object is recorded under fluorescent light, mercury light or sodium light, etc., but this is not a malfunction. In Motion Picture Recording Mode, record in Intelligent Auto Mode/Intelligent Auto Plus Mode or set the shutter speed to 1/100 in areas where the power supply frequency is 50 Hz, or 1/125 in areas of 60 Hz. In Still Picture Recording Mode, this will not affect the recorded image. In FULL HD Slow Motion Mode, setting the shutter speed to 1/100 seconds reduces the intensity of the problem.

Playback	
Problem	Check points
Scenes/still pictures cannot be played back.	<ul style="list-style-type: none"> Any scenes/still pictures where the thumbnails are displayed as  cannot be played back.

Playback	
Problem	Check points
Scenes cannot be deleted.	<ul style="list-style-type: none"> ● Release the protect setting. (→ 110) ● Any scenes/still pictures where the thumbnails are displayed as  cannot be deleted. If the scenes/still pictures are unnecessary, format the media to erase the data. (→ 38) Please be aware that if a media is formatted then all the data recorded on the media is erased and cannot be recovered. Back up important data on a PC, disc etc.

With other products	
Problem	Check points
<p>Even when this unit is correctly connected to a TV, images or sounds are not output.</p> <p>The images are squeezed horizontally.</p>	<ul style="list-style-type: none"> ● Please read the operating instructions of your TV and select the channel that matches the input used for the connection. ● Change the [TV ASPECT] setting to match the aspect ratio of the TV. (→ 114) ● The audio during playback mode is not output from this unit when connected to a TV. Sound levels cannot be adjusted using this unit, so adjust the sound on the TV.
Even when this unit is connected to the TV by the HDMI micro cable, images or sounds are not output.	<ul style="list-style-type: none"> ● Check if the HDMI micro cable is connected correctly. ● Insert the HDMI micro cable all the way in.
If the SD card is inserted in another device, it is not recognised.	<ul style="list-style-type: none"> ● Check that the device is compatible with the capacity or type of SD card (SD Memory Card/SDHC Memory Card/SDXC Memory Card) that you inserted. Refer to the operating instructions of the device for details.
When connected by the USB cable, this unit is not detected by the other devices.	<ul style="list-style-type: none"> ● When connected to other devices using only the battery, reconnect using the AC adaptor.
VIERA Link does not work.	<p>(Setting on this unit)</p> <ul style="list-style-type: none"> ● Connect with a HDMI micro cable (supplied). (→ 113) ● Touch , then touch [SETUP] → [VIERA Link] → [ON]. (→ 116) ● Turn the unit off and then back on again. <p>(Setting on other devices)</p> <ul style="list-style-type: none"> ● If the TV input does not switch automatically, switch the input using the TV remote control. ● Check the VIERA Link setting on the connected device. ● Please refer to the operating instructions of the connected device.
Cannot copy scenes on the SD card by connecting to other equipment with the USB cable.	<ul style="list-style-type: none"> ● Other equipment might have not recognised the SD card. Unplug the USB cable once, and reconnect it.

With a PC

Problem	Check points
When connected by the USB cable, this unit is not detected by the PC.	<ul style="list-style-type: none"> ● After re-inserting the SD card into the unit, reconnect the supplied USB cable. ● Select another USB terminal on the PC. ● Check the operating environment. (→ 171, 178) ● Connect the supplied USB cable again after restarting the PC and turning on this unit again.
When the USB cable is disconnected, an error message will appear on the PC.	<ul style="list-style-type: none"> ● To disconnect the USB cable safely, select the  icon in task tray displayed on the PC, and then select the model number of this unit to disconnect the USB cable.
Cannot see the PDF operating instructions for HD Writer AE 5.2.	<ul style="list-style-type: none"> ● You will need Adobe Acrobat Reader 5.0 or later or Adobe Reader 7.0 or later to read the PDF operating instructions for HD Writer AE 5.2.

About the Wi-Fi function

Problem	Check points
Cannot connect to wireless access point or smartphone.	<ul style="list-style-type: none"> ● Read page 150 if the Wi-Fi connection cannot be established.
Cannot operate from smartphone using [Remote Ctrl].	<ul style="list-style-type: none"> ● Install the smartphone app "Image App" on your smartphone. (→ 141)
When I look at the recording screen with the smartphone, mosaic-like noise appears on the screen and the image movement does not look smooth.	<ul style="list-style-type: none"> ● When this unit is set to any of the following recording formats or recording modes, mosaic-like noise may appear on the screen and the image movement may not look smooth. (Recorded images will not be affected.) <ul style="list-style-type: none"> – Recording mode [1080/50p] for the recording format [AVCHD] – Recording mode [1080/50M] or [1080/28M] for the recording format [MP4/iFrame]
Cannot use [DLNA Play].	<ul style="list-style-type: none"> ● Make sure the television is compatible with DLNA. Read the instructions for the television you are using. ● Make sure the wireless access point and this device are properly connected. ● Approach the wireless access point and reconnect. ● If a connection cannot be made between this device and a DLNA-compatible device, try to reconnect and make sure they connect properly.
I have forgotten the password for the Wi-Fi.	<ul style="list-style-type: none"> ● Perform [Reset Wi-Fi Settings] from the Setup menu (→ 37). This will set the Wi-Fi setting to the condition at the time of purchase, and you will be able to use the Wi-Fi setting menu. When performing [Reset Wi-Fi Settings], all Wi-Fi settings including registered wireless access points will be deleted.

Others	
Problem	Check points
If the SD card is inserted in this unit, it is not recognised.	<ul style="list-style-type: none"> ● If the SD card is formatted on a PC, it may not be recognised by this unit. Use this unit to format SD cards. (→ 38)

■ If AVCHD scenes do not change smoothly when played back on another device

The images may be still for several seconds at the joins between the scenes if the following operations are performed when multiple scenes have been continuously played back using another unit.

- Just how smoothly the scenes will be played back depends on the playback unit. Depending on the unit used, the images may stop moving and become still for a moment even when none of the following conditions are applicable.
- A continuous recording of motion picture data that exceeds 4 GB may momentarily stop at every 4 GB of data when played back with another device.
- It may not play back smoothly when the editing of scenes was done with the HD Writer AE 5.2, but it will play back smoothly if you set the seamless settings in the HD Writer AE 5.2. Refer to the operating instructions for the HD Writer AE 5.2.

Principal reasons for not playing back smoothly
● When the scenes were recorded on different dates
● When scenes lasting under 3 seconds have been recorded
● When PRE-REC was used for recording
● When the Miniature Effect recording is used
● When the Time Lapse Recording is used
● When deleting scenes
● When scenes recorded more than 99 scenes on the same date

Cautions for use

About this unit

The unit and the SD card become warm during use. This is not a malfunction.

Keep this unit as far away as possible from electromagnetic equipment (such as microwave ovens, TVs, video games etc.).

- If you use this unit on top of or near a TV, the pictures and/or sound on this unit may be disrupted by electromagnetic wave radiation.
- Do not use this unit near cell phones because doing so may result in noise adversely affecting the pictures and/or sound.
- Recorded data may be damaged, or pictures may be distorted, by strong magnetic fields created by speakers or large motors.
- Electromagnetic wave radiation generated by microprocessors may adversely affect this unit, disturbing the pictures and/or sound.
- If this unit is adversely affected by electromagnetic equipment and stops functioning properly, turn this unit off and remove the battery or disconnect AC adaptor. Then reinsert the battery or reconnect AC adaptor and turn this unit on.

Do not use this unit near radio transmitters or high-voltage lines.

- If you record near radio transmitters or high-voltage lines, the recorded pictures and/or sound may be adversely affected.

When this unit is turned on, do not use it in direct contact with the skin for a long period of time.

- When using this unit for a long period of time, use a support such as a tripod. Low temperature burns may result if any high temperature part of this unit is in direct contact with the skin for a long period of time.

Make sure to use the supplied cords and cables. If you use optional accessories, use the cords and the cables supplied with them.

Do not extend the cords and the cables.

Do not spray insecticides or volatile chemicals onto the unit.

- If the unit is sprayed with such chemicals, its body may be marred and the surface finish may peel off.
- Do not leave rubber or plastic products in contact with the unit for a long time.

When you use the unit in a sandy or dusty place such as a beach, do not let sand or fine dust get into the body and terminals of the unit.

Also, keep the unit away from sea water.

- Sand or dust may damage the unit. (Care should be taken when inserting and removing a card.)
- If sea water splashes onto the unit, wipe off the water with a well wrung cloth. Then wipe the unit again with a dry cloth.

When carrying the unit, do not drop or bump it.

- A strong impact can break the unit's casing, causing it to malfunction.

Cleaning

- Before cleaning, detach the battery or pull the AC adaptor from the AC outlet, and then wipe the unit with a soft, dry cloth.
- If the unit is very dirty, dip a cloth in water and squeeze firmly, and then wipe the unit with the damp cloth. Next, dry the unit with a dry cloth.
- Use of benzine, paint thinner, alcohol, or dishwashing liquid may alter the camera body or peel the surface finish. Do not use these solvents.
- When using a chemical dust cloth, follow the instructions that came with the cloth.

Do not use the unit for surveillance purposes or other business uses.

- This unit was designed for consumer intermittent use. It was not intended for continuous use, or for any industrial or commercial application resulting in prolonged use.
- In certain situations, continuous use could cause the unit to overheat and cause a malfunction. Such use is strongly discouraged.

When you are not going to use the unit for an extended time

- When storing the unit in a cupboard or cabinet, it is recommended that you place a desiccant (silica gel) in with it.

About the battery

The battery used in this unit is a rechargeable lithium-ion battery. It is susceptible to humidity and temperature and the effect increases the more the temperature rises or falls. In cold areas, the full charge indication may not appear or the low battery indication may appear about 5 minutes after starting use. At high temperatures, the protection function may be triggered, making it impossible to use the unit.

Be sure to detach the battery after use.

- If the battery is left attached, a minute amount of current continues to flow even if the unit is off. Keeping the unit in this state may result in over discharge of the battery. This may result in you not being able to use the battery even after it is charged.
- The battery should be stored in the vinyl bag so metal does not come into contact with the terminals.
- The battery should be stored in a cool place free from humidity, with as constant temperature as possible. (Recommended temperature: 15 °C to 25 °C, Recommended humidity: 40%RH to 60%RH)
- Extremely high temperatures or low temperatures will shorten the life of the battery.
- If the battery is kept in high-temperature, high-humidity, or oily-smoky places, the terminals may rust and cause malfunctions.
- To store the battery for a long period of time, we recommend you charge it once every year and store it again after you have completely used up the charged capacity.
- Dust and other matter attached to the battery terminals should be removed.

Prepare spare batteries when going out for recording.

- Prepare batteries enough to last for 3 to 4 times the period you are planning to record for. Cold places such as a ski resort can shorten recording time.

If you drop the battery accidentally, check to see if the terminals are damaged.

- Inserting a battery with damaged terminals can damage the unit.

Do not throw an old battery into fire.

- Heating a battery or throwing it into a fire may result in an explosion.

If the operating time is very short even after the battery has been recharged, the battery has worn out. Please purchase a new battery.

About the AC adaptor

- If the temperature of the battery is extremely high or extremely low, charging may take time or the battery may not be charged.
- If you use the AC adaptor near a radio, radio reception may be disturbed. Keep the AC adaptor 1 m or more away from the radio.
- When using the AC adaptor, it may generate whirring sounds. However, this is normal.
- After use, be sure to disconnect the AC adaptor. (If it is left connected, a minute amount of current is consumed.)
- Always keep the electrodes of the AC adaptor and battery clean.

About status indicator during charging

When the status indicator is flashing at a particularly fast or slow rate, the following should be considered.

Flashing with approx. 4 second period (off for approx. 2 seconds, on for approx.

2 seconds):

- When the battery is over discharged or the temperature of the battery is too high or low. It can be charged, but it may take a few hours to complete the charging normally.
- It will flash in approx. 2 second intervals when normal charging resumes. Even in such cases, it may start flashing in approx. 4 second intervals until charging is completed depending on the conditions of use.

Flashing with approx. 0.5 second period (off for approx. 0.25 second, on for approx.

0.25 second):

- The battery is not charged. Remove the battery from the unit, and try charging again.
- Check that the terminals of the unit or battery are not dirty or covered with a foreign object, and connect the battery correctly once again. If a foreign object or dirt is present, turn off the unit before removing.
- The battery or environment is at an extremely high or low temperature. Wait until the temperature has returned to an appropriate level and try charging again. If you are still unable to charge, there may be a fault in the unit, battery or AC adaptor.

Off:

- Charging has finished.
- If the status indicator stays off despite the charging being unfinished, there may be a fault in the unit, battery or AC adaptor. Refer to page [190](#) for details on the battery.

About the SD card

When disposing of or giving away the SD card, note that:

- Formatting and deletion of data on this unit or computer only changes the file management information and does not completely delete the data in the SD card.
- It is recommended that the SD card is physically destroyed or the SD card is physically formatted using this unit when disposing of or giving away the SD card.

To physically format the SD card, connect the unit via the AC adaptor, select [SETUP] → [FORMAT MEDIA] → [YES] from the menu, and then press and hold the recording start/stop button on the screen below for about 3 seconds. When the SD card data deletion screen appears, select [YES], and then follow the on-screen instructions.

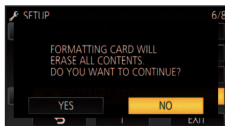

- The customer is responsible for the management of the data in the SD card.

LCD monitor

- When the LCD screen is dirty or condensation has occurred, please wipe it using a soft cloth such as eyeglass cleaner.
- Do not touch the LCD monitor with your fingernails, or rub or press with strong force.
- It may become hard to see or hard to recognise the touch when the LCD protection sheet is affixed.
- When the unit has become very cold, for example due to storage in a cold area, its LCD monitor will be slightly darker than usual immediately after the unit is turned on. The normal brightness will be restored when the unit's internal temperature rises.

Extremely high precision technology is employed to produce the LCD Monitor screen. The result is more than 99.99% effective dots with a mere 0.01% of the dots inactive or always lit. However, this is not a malfunction and does not affect the recorded picture.

About personal information

When a name or birthday is set by Baby Calendar, personal information will be included in this unit.

When the Wi-Fi function is used, the SSID, Password, and other personal information will be included in this unit.

Setting a Wi-Fi password is recommended to protect personal information. (→ 154)

Disclaimer

- Information including personal information may be altered or vanish due to erroneous operation, effect of static electricity, accident, malfunction, repair, or other handlings.
Please note in advance that Panasonic is not liable in any way for any direct or indirect damage from the alteration or vanishing of information or personal information.

When requesting a repair, transferring to another party, or disposing.

- After making a copy of personal information, always delete information such as personal information and wireless LAN connection settings that you have saved within this unit with [Reset Wi-Fi Settings]. (→ 37)
- To protect personal information, delete the registered details of Baby Calendar unless they are necessary for the repair. (→ 101)
- Remove the Memory Card from this unit when requesting a repair.
- Settings may return to factory default when this unit is repaired.
- Please contact the dealer where you purchased this unit or Panasonic if above operations are not possible due to malfunction.

When transferring to another party, or disposing of the Memory Card, please refer to “When disposing of or giving away the SD card, note that:”. (→ 192)

When uploading images on web services

- Images may contain information that can be used for identifying individuals such as titles and recording dates. When uploading images on web services, check carefully, and then upload.

About copyright

■ Carefully observe copyright laws

Recording of pre-recorded tapes or discs or other published or broadcast material for purposes other than your own private use may infringe copyright laws. Even for the purpose of private use, recording of certain material may be restricted.

■ Licenses

- SDXC Logo is a trademark of SD-3C, LLC.
- “AVCHD”, “AVCHD Progressive” and the “AVCHD Progressive” logo are trademarks of Panasonic Corporation and Sony Corporation.
- Manufactured under license from Dolby Laboratories.
Dolby, Dolby Audio, and the double-D symbol are trademarks of Dolby Laboratories Licensing Corporation.
- The terms HDMI and HDMI High-Definition Multimedia Interface, and the HDMI Logo are trademarks or registered trademarks of HDMI Licensing Administrator, Inc. in the United States and other countries.
- HDAVI Control™ is a trademark of Panasonic Corporation.
- x.v.Colour™ is a trademark.
- Microsoft® and Windows® are either registered trademarks or trademarks of Microsoft Corporation in the United States and/or other countries.
- Microsoft product screen shot(s) reprinted with permission from Microsoft Corporation.
- Intel®, Pentium® and Intel® Core™ are trademarks of Intel Corporation in the U.S. and/or other countries.
- AMD Athlon™ is a trademark of Advanced Micro Devices, Inc.
- iMovie, Final Cut Pro, Mac and macOS are trademarks of Apple Inc. registered in the U.S. and other countries.
- App Store is a service mark of Apple Inc.
- Google, Android and Google Play are trademarks of Google LLC.
- The Wi-Fi CERTIFIED™ Logo is a registered trademark of Wi-Fi Alliance®.
- The Wi-Fi Protected Setup™ Logo is a trademark of Wi-Fi Alliance®.
- “Wi-Fi®” is a registered trademark of Wi-Fi Alliance®.
- “Wi-Fi Protected Setup™”, “WPA™”, and “WPA2™” are trademarks of Wi-Fi Alliance®.
- DLNA, the DLNA Logo and DLNA CERTIFIED are trademarks, service marks, or certification marks of the Digital Living Network Alliance.
- QR Code is a registered trademark of DENSO WAVE INCORPORATED.
- Other names of systems and products mentioned in these instructions are usually the registered trademarks or trademarks of the manufacturers who developed the system or product concerned.

This product is licensed under the AVC Patent Portfolio License for the personal use of a consumer or other uses in which it does not receive remuneration to (i) encode video in compliance with the AVC Standard (“AVC Video”) and/or (ii) decode AVC Video that was encoded by a consumer engaged in a personal activity and/or was obtained from a video provider licensed to provide AVC Video. No license is granted or shall be implied for any other use. Additional information may be obtained from MPEG LA, L.L.C.

See <http://www.mpegla.com>.

Recording modes/approximate recordable time

- SD cards are only mentioned with their main memory size. The stated times are the approximate recordable times for continuous recording.

Recording format		[AVCHD]				
Recording mode		[1080/50p]	[1080/50i]			
Picture size/Frame rate			[PH]	[HA]	[HG]	[HE]
		1920×1080/50p	1920×1080/50i	1920×1080/50i	1920×1080/50i	1920×1080/50i
SD card	4 GB	19 min	21 min	30 min	40 min	1 h 30 min
	16 GB	1 h 20 min	1 h 30 min	2 h	2 h 40 min	6 h 40 min
	64 GB	5 h 20 min	6 h	8 h 30 min	11 h	27 h 30 min

- A** Favours image quality
- B** Favours Recording time

Recording format		[MP4/iFrame]			
Recording mode		[1080/50M]	[1080/28M]	[720]	[iFrame]
Picture size/Frame rate		1920×1080/50p	1920×1080/50p	1280×720/25p	960×540/25p
SD card	4 GB	11 min	19 min	1 h	19 min
	16 GB	45 min	1 h 20 min	4 h 10 min	1 h 20 min
	64 GB	3 h	5 h 20 min	16 h 50 min	5 h 20 min

- “h” is an abbreviation for hour, “min” for minute and “s” for second.
- If recording for long periods, prepare batteries for 3 or 4 times the period you wish to record for. (→ 13)
- The default setting for [REC FORMAT] is [AVCHD], and the default setting for [REC MODE] is [HG].
- Maximum continuously recordable time for one scene: 6 hours
- The recording is paused once when the recording time for one scene exceeds 6 hours, and the recording will automatically resume after a few seconds.
- The recordable time may be reduced if recording with a lot of action is recorded or recording of short scene is repeated.
- Use time in the row of 4 GB in above table as a guideline for the time that can be copied onto one DVD disc (4.7 GB).
- Recordable times will be approximately half the times in the above table when Backup for Twin Camera is in operation.

Approximate number of recordable pictures

- SD cards are only mentioned with their main memory size. The stated number is the approximate number of recordable pictures.

Picture size		24M	12.6M	2.1M
		6528×3672	4736×2664	1920×1080
Aspect ratio		16:9		
SD card	4 GB	250	500	3200
	16 GB	1100	2100	12500
	64 GB	4700	8500	52000

Picture size		18M	8M	0.3M
		4896×3672	3264×2448	640×480
Aspect ratio		4:3		
SD card	4 GB	350	750	28000
	16 GB	1500	3100	117000
	64 GB	6000	12500	475000

Picture size		20M	10.6M	2M
		5472×3648	3984×2656	1728×1152
Aspect ratio		3:2		
SD card	4 GB	300	600	2200
	16 GB	1300	2400	8500
	64 GB	5500	10000	36000

- The number of recordable pictures depends on the subject being recorded.
- Maximum number of recordable pictures that can be displayed is 9999. If the number of recordable pictures exceeds 9999, R 9999+ is displayed. The number will not change when the picture is taken until the number of recordable pictures is 9999 or less.
- The memory capacity indicated on the label of an SD card is the total of the capacity for copyright protection and management and the capacity which can be used on the unit, a PC etc.

Optional accessories

Some optional accessories may not be available in some countries.

Attaching the Conversion Lens/Filter Kit

Attach the Wide Conversion Lens (VW-W4907H: optional) ND filter or MC protector of the Filter Kit (VW-LF49N: optional) in front of the lens.

- You will not be able to use the video light. Set the video light setting to **D** ([OFF]) and the [AF ASSIST LAMP] setting to [OFF]. (→ 68, 82)
- When using a Wide Conversion Lens (optional), set [WIDE CONV. LENS SET] to [ON]. (→ 76)

Be careful about the following.

When 2 lens accessories, such as the ND filter and Wide Conversion Lens, are fitted and the zoom lever is pressed toward the W side, the 4 corners of an image will be darkened. (Vignetting)

Attaching the lens cap of the Filter Kit (VW-LF49N: optional)

- When the Filter Kit (VW-LF49N: optional) is used, protect the lens surface while the unit is not used with the lens cap supplied with the Filter Kit.

Attaching the supplied shoe adaptor

You can attach a variety of optional accessories to the shoe adaptor. For information on how to attach and use those accessories, refer to their manuals.

■ When attaching the shoe adaptor

Insert the shoe adaptor into the shoe adaptor mounting part.

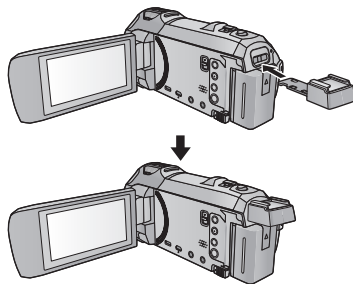

■ When removing the shoe adaptor

When removing the shoe adaptor, slide the SHOE ADAPTOR RELEASE lever, and remove the shoe adaptor while sliding the lever.

