



Lenovo ThinkSystem SR635 Server Product Guide

The Lenovo ThinkSystem SR635 is a 1-socket 1U server that features the new AMD EPYC 7002 "Rome" family of processors. With up to 64 cores per processor and support for the new PCIe 4.0 standard for I/O, the SR635 offers the ultimate in single-socket server performance in a space-saving 1U form factor. With up to 128 PCIe lanes, the server is ideal for dense workloads that can take advantage of GPU processing and high-performance NVMe drives.

Suggested uses: AI Inference, VDI, OLTP, Analytics, HPC, software-defined storage



Figure 1. Lenovo ThinkSystem SR635

Did you know?

By using a high-performance server with only one processor installed, you can take advantage of lower software costs when the software licensing is using a per-socket model. In addition, The server offers onboard NVMe PCIe ports that allow direct connections to 16x NVMe SSDs, which frees up I/O slots and helps lower NVMe solution acquisition costs.

The SR635 has been designed to take advantage of the features of the EPYC 7002 "Rome" processors, such as the full performance of 225W 64-core processors, support for 3200 MHz memory and PCIe Gen 4.0 support. Competitive servers that are based on the older EPYC 7001 "Naples" designs may not be able to offer these performance features.

Key features

Combining performance and flexibility, the SR635 server is a great choice for enterprises of all sizes. The server offers a broad selection of drive and slot configurations and offers high performance features that industries such as finance, healthcare and telco need. Outstanding reliability, availability, and serviceability (RAS) and high-efficiency design can improve your business environment and can help save operational costs.

Scalability and performance

The SR635 offers numerous features to boost performance, improve scalability and reduce costs:

- Supports the new AMD EPYC 7002 family of processors
- Supports processors with up to 64 cores and 128 threads, core speeds of up to 3.2 GHz, and TDP ratings of up to 225W.
- Support for up to 16 TruDDR4 memory DIMMs, with 8 memory channels and 2 DIMMs per channel. With 1 DIMM installed per channel (8 DIMMs total), memory operates at up to 3200 MHz. With 2 DIMMs per channel (16 DIMMs total), memory operating at up to 2933 MHz.
- Using 64GB DIMMs, the server supports up to 1TB of system memory.
- Supports up to three single-width GPUs, each up to 75W. A 3:1 ratio of GPUs to CPUs means substantial processing power is available with just one CPU.
- Supports up to 16x 2.5-inch hot-swap drive bays, by using combinations of front-accessible (up to 10 bays), mid-accessible (4 bays), and rear-accessible (2 bays).
- Supports four 3.5-inch drive bays for lower-cost high-capacity storage. 2.5-inch and 3.5-inch drive bays can be mixed in several combinations.
- Supports 16x NVMe drives without oversubscription of PCIe lanes (1:1 connectivity) and without the need for additional NVMe adapters. The use of NVMe drives maximizes drive I/O performance, in terms of throughput, bandwidth, and latency.
- Supports 12x SATA drives using the onboard SATA controller (no additional adapter needed), enabling lower cost, high capacity storage solution for cold storage workloads.
- Supports 12x SAS drives using a variety of support RAID controllers or SAS HBAs.
- Supports high-speed RAID controllers from Broadcom providing 12 Gb SAS connectivity to the drive backplanes. A variety of RAID adapters are available, with cache and support for 16 drives on a single controller.
- Supports M.2 drives for convenient operating system boot functions or data storage. Available M.2 adapters support either one M.2 drive or two M.2 drives in a RAID 1 configuration for performance and reliability.
- The server has a dedicated industry-standard OCP 3.0 small form factor (SFF) slot, with a PCIe 4.0 x16 interface, supporting a variety of Ethernet network adapters. Simple-swap mechanism with thumbscrews and pull-tab enables tool-less installation and removal of the adapter. Supports shared BMC network sideband connectivity to enable out-of-band systems management.
- The server offers PCI Express 4.0 I/O expansion capabilities that doubles the theoretical maximum bandwidth of PCIe 3.0 (16GT/s in each direction for PCIe 4.0, compared to 8 GT/s with PCIe 3.0). A PCIe 4.0 x16 slot provides 64 GB/s bandwidth, enough to support a 400GbE network connection.
- A total of up to four PCIe 4.0 slots (3 with rear access, 1 internal for a RAID adapter) plus a slot dedicated to the OCP adapter.

Availability and serviceability

The SR635 provides many features to simplify serviceability and increase system uptime:

- The server uses ECC memory and supports memory RAS features including Single Device Data Correction (SDDC, also known as Chipkill), Patrol/Demand Scrubbing, DRAM Address Command Parity with Replay, and DRAM Uncorrected ECC Error Retry.
- The server offers hot-swap drives, supporting RAID redundancy for data protection and greater system uptime.
- The M.2 SATA RAID Boot Adapter supports RAID-1 which enables two installed M.2 drives to be configured as a redundant pair.
- The server has up to two hot-swap redundant power supplies and seven hot-swap redundant fans to provide availability for business-critical applications.
- The power-source-independent light path diagnostics uses LEDs to lead the technician to failed (or failing) components, which simplifies servicing, speeds up problem resolution, and helps improve system availability.
- Solid-state drives (SSDs) offer more reliability than traditional mechanical HDDs for greater uptime.
- The built-in ASPEED AST2500 baseboard management controller (BMC) continuously monitors system parameters, triggers alerts, and performs recovery actions in case of failures to minimize downtime.
- Proactive Platform Alerts: Voltage regulators, memory, fans, power supplies, server ambient and subcomponent temperatures. Alerts can be surfaced through the BMC to managers such as Lenovo XClarity Administrator. These proactive alerts let you take appropriate actions in advance of possible failure, thereby increasing server uptime and application availability.
- Web-based ThinkSystem System Manager (TSM) provides remote access to the BMC for remote management.
- Lenovo XClarity Provisioning Manager Lite (LXPM Lite) tool can be used to install an operating system on the server and perform system diagnostics.
- Three-year or one-year customer-replaceable unit and onsite limited warranty, 9 x 5 next business day. Optional service upgrades are available.

Manageability and security

Systems management features simplify local and remote management of the SR635:

- Supports Lenovo XClarity Provisioning Manager Lite (LXPM Lite) for system setup and firmware upgrades.
- An integrated industry-standard Unified Extensible Firmware Interface (UEFI) enables improved setup, configuration, and updates, and simplifies error handling.
- Support for industry standard management protocols, IPMI 2.0, SNMP 3.0, Redfish REST API, serial console via IPMI
- An integrated hardware Trusted Platform Module (TPM) supporting TPM 2.0 enables advanced cryptographic functionality, such as digital signatures and remote attestation.
- Administrator and power-on passwords help protect from unauthorized access to the server.
- Support for Lenovo XClarity Energy Manager, which captures real-time power and temperature data from the server and integrates with Redfish-based applications to provide automated controls to lower energy costs.
- Supports AMD Secure Root-of-Trust, Secure Run and Secure Move features to minimize potential attacks and protect data as the OS is booted, as applications are run and as applications are migrated from server to server.
- Supports Secure Boot to ensure only a digitally signed operating system can be used.
- Industry-standard Advanced Encryption Standard (AES) NI support for faster, stronger encryption.

Energy efficiency

The SR635 offers the following energy-efficiency features to save energy, reduce operational costs, and increase energy availability:

- Energy-efficient planar components help lower operational costs.
- High-efficiency power supplies with 80 PLUS Platinum and Titanium certifications
- Intel Intelligent Power Capability turns individual processor elements on and off as needed to reduce power draw.
- Low-voltage 1.2 V DDR4 memory offers energy savings compared to 1.35 V and 1.5 V DDR3 DIMMs.
- Solid-state drives (SSDs) consume as much as 80% less power than traditional spinning 2.5-inch HDDs.
- The server uses hexagonal ventilation holes, which can be grouped more densely than round holes, providing more efficient airflow through the system and thus keeping your system cooler.
- Optional Lenovo XClarity Energy Manager provides advanced data center power notification and analysis to help achieve lower heat output and reduced cooling needs.

Components and connectors

The following figure shows the front of the server.

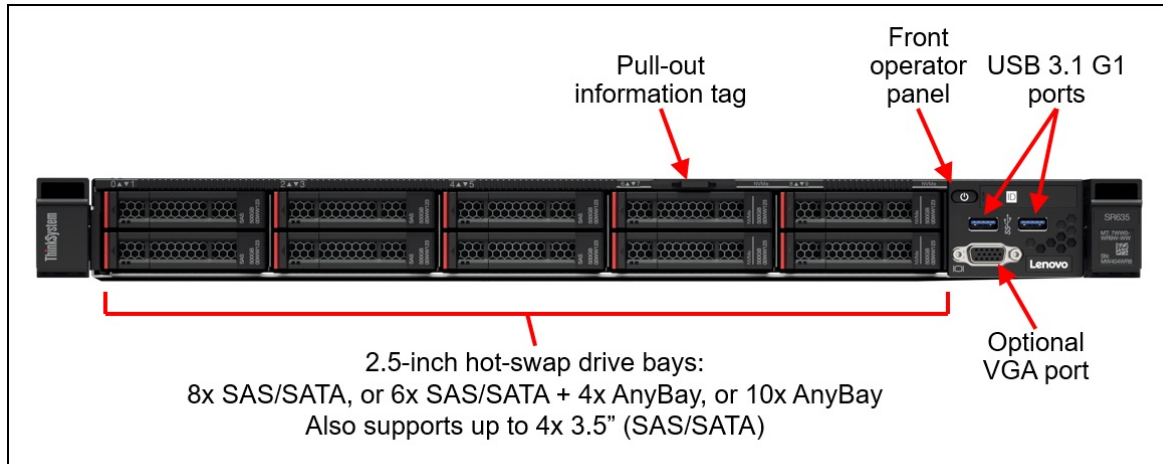

Figure 2. Front view of the Lenovo ThinkSystem SR635

The following figure shows the components visible from the rear of the server. As shown, there are three different configurations available

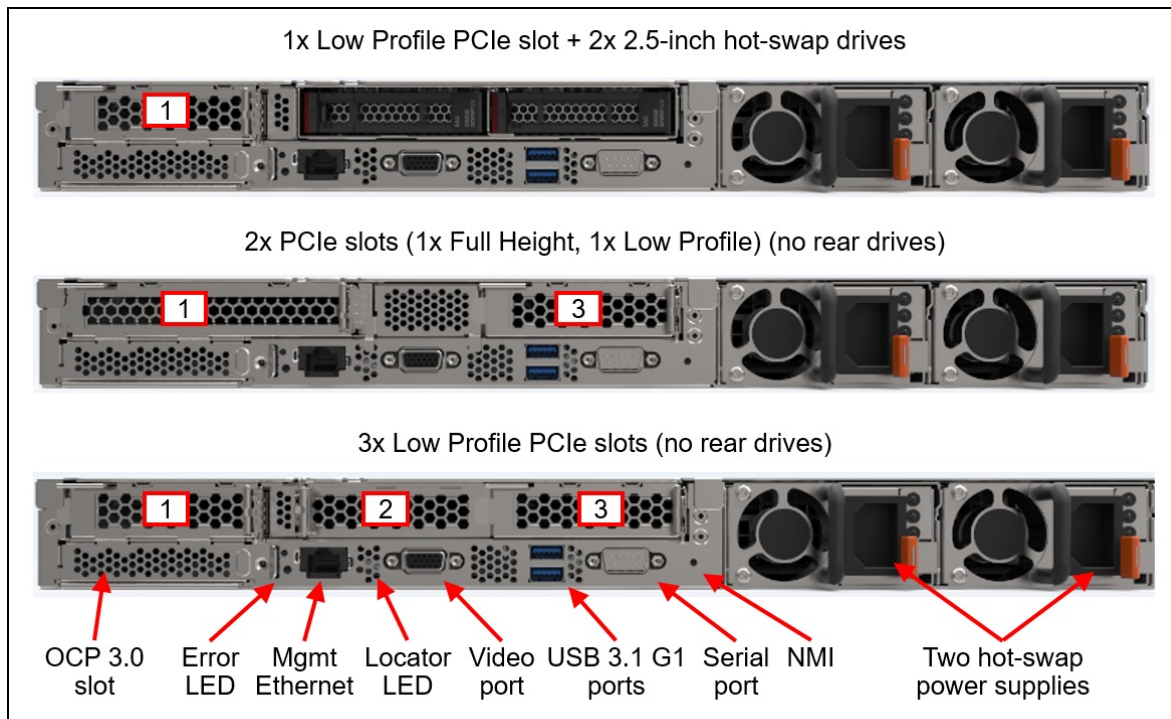

Figure 3. Rear view of the Lenovo ThinkSystem SR635

The following figure shows the locations of key components inside the server.

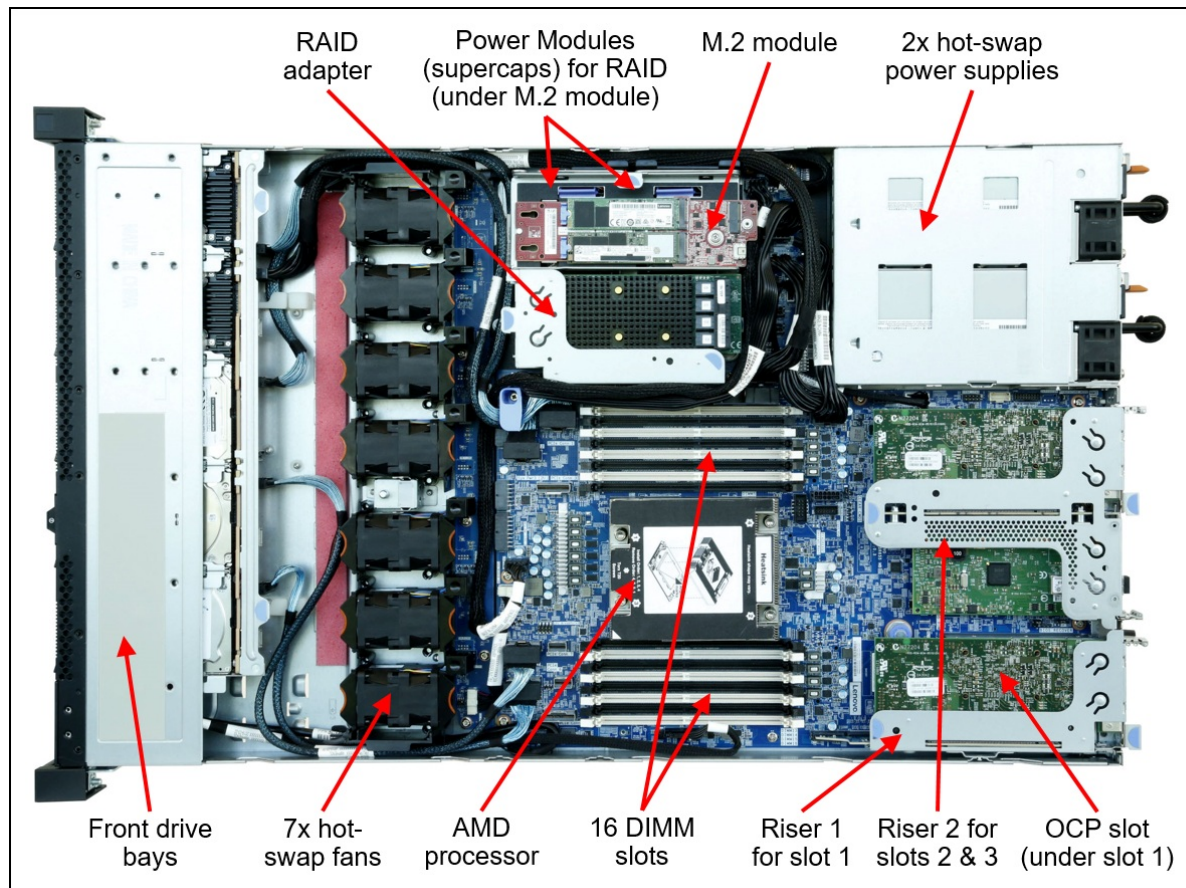

Figure 4. Internal view of the Lenovo ThinkSystem SR635

System architecture

The following figure shows the architectural block diagram of the SR635, showing the major components and their connections.

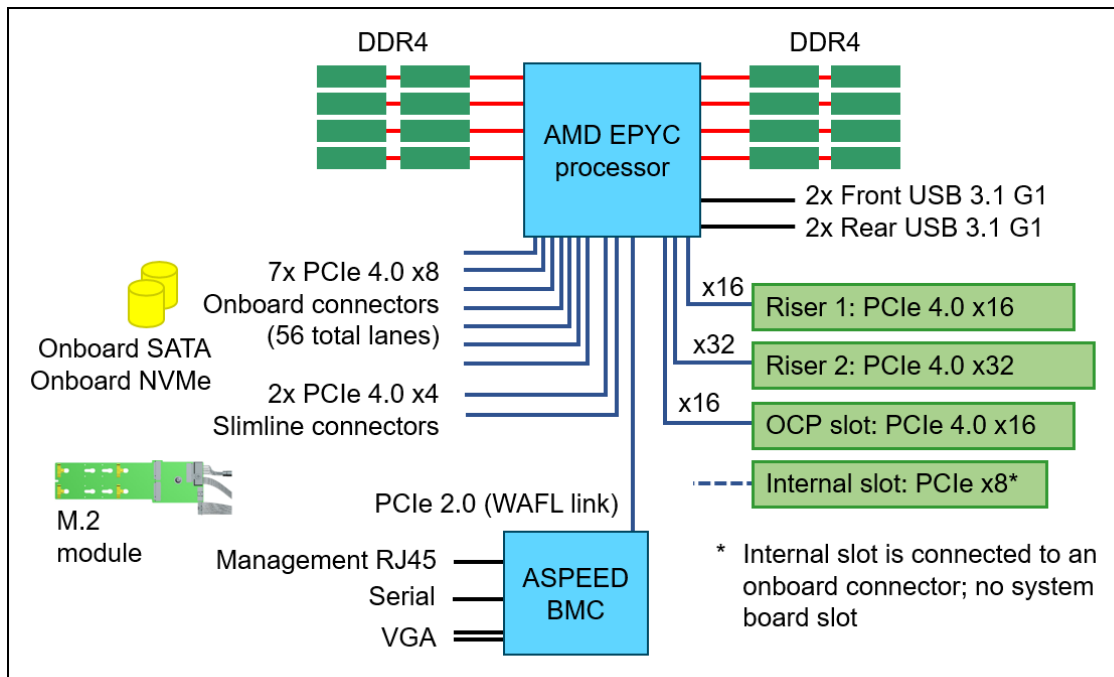

Figure 5. SR635 system architectural block diagram

Standard specifications

The following table lists the standard specifications.

Table 1. Standard specifications

Components	Specification
Machine types	7Y98 - 1 year warranty 7Y99 - 3 year warranty
Form factor	1U rack.
Processor	One AMD EPYC 7002 Series processor (formerly codenamed "Rome"). Supports processors up to 64 cores, core speeds of up to 3.2 GHz, and TDP ratings of up to 225W.
Memory	16 DIMM slots. The processor has 8 memory channels, with 2 DIMMs per channel. Lenovo TruDDR4 RDIMMs are supported. DIMMs are available in two speeds: 3200 MHz and 2933 MHz. With 3200 MHz memory, the server supports a 3200 MHz memory bus speed at 1 DIMM per channel (DPC) and 2933 MHz at 2 DPC. With 2933 MHz memory, the server supports a 2933 MHz memory bus speed at both 1 and 2 DPC.
Memory maximum	Up to 1TB with 16x 64GB RDIMMs
Persistent memory	Not supported.
Memory protection	ECC, SDDC, Patrol/Demand Scrubbing, DRAM Address Command Parity with Replay, DRAM Uncorrected ECC Error Retry, Post Package Repair

Components	Specification
Disk drive bays	<p>Up to 4x 3.5-inch or 16x 2.5-inch hot-swap drive bays:</p> <ul style="list-style-type: none"> • Front bays can be one of the following: <ul style="list-style-type: none"> ◦ 4x 3.5-inch hot-swap SAS/SATA ◦ 8x 2.5-inch hot-swap SAS/SATA ◦ 6x 2.5-inch hot-swap SAS/SATA + 4x 2.5-inch hot-swap AnyBay ◦ 10x 2.5-inch hot-swap AnyBay • Mid (internal): 4x 2.5-inch hot-swap NVMe bays • Rear can be one of the following: <ul style="list-style-type: none"> ◦ 2x 2.5-inch hot-swap SAS/SATA bays ◦ 2x 2.5-inch hot-swap NVMe bays <p>See Supported drive bay combinations for details. AnyBay bays support SAS, SATA or NVMe drives. NVMe bays only support NVMe drives. Both mid and rear drive bays can be used in conjunction with 2.5-inch front drive bays. Mid bays are hot-swap drive bays and are accessible by removing the top cover of the server. The server supports up to 16x NVMe drives (10 front, 4 mid, 2 rear) all with direct connections (no oversubscription).</p>
Maximum internal storage	<ul style="list-style-type: none"> • All NVMe: 87.04 TB using 10x 6.4 TB NVMe (front) + 6x 3.84TB NVMe SSDs (4x mid, 2x rear) • All SSDs: 107.52 TB using 12x 7.68TB SSDs (10x front, 2x rear) + 4x 3.84TB NVMe (mid) • All HDDs in front (with NVMe): 55.36 TB using 4x 10TB 3.5-inch HDDs (front) + 4x 3.84TB NVMe SSDs (mid) • Mix of SSDs/HDDs supported but not in the same array
Storage controller	<ul style="list-style-type: none"> • Onboard SATA supporting up to 12 SATA drives (no RAID) • 12 Gb SAS/SATA RAID adapters: <ul style="list-style-type: none"> ◦ RAID 530i (cacheless) supports RAID 0, 1, 10, 5, 50 ◦ RAID 730-8i with 1GB cache supports RAID 0, 1, 10, 5, 50 ◦ RAID 730-8i with 2GB flash-backed cache supports RAID 0, 1, 10, 5, 50, 6, 60 ◦ RAID 930-8i with 2GB flash-backed cache supports RAID 0, 1, 10, 5, 50, 6, 60 ◦ RAID 930-16i with 4GB flash-backed cache supports RAID 0, 1, 10, 5, 50, 6, 60 • 12 Gb SAS/SATA non-RAID: 430-8i and 430-16i HBAs
Optical drive bays	No internal optical drive.
Tape drive bays	No internal backup drive.
Network interfaces	Dedicated OCP 3.0 SFF slot with PCIe 4.0 x16 host interface. Supports a variety of 2-port and 4-port adapters with 1GbE, 10GbE and 25GbE network connectivity. One port can optionally be shared with the ASPEED management processor for Wake-on-LAN and NC-SI support.
PCI Expansion slots	<p>A total of up to 4 PCIe 4.0 slots (3 with rear access, 1 internal for a RAID adapter) plus a slot dedicated to the OCP adapter. Slot availability is based on riser selection.</p> <p>Three choices for rear-access slots:</p> <ul style="list-style-type: none"> • 3x PCIe 4.0 x16 low-profile slots • 1x PCIe 4.0 x16 full-height half-length slot + 1x PCIe 4.0 x16 low-profile slot • 1x PCIe 4.0 x16 low-profile slot (supports 2x rear 2.5-inch drive bays) <p>Optionally, an additional internal PCIe 4.0 x8 low-profile slot for an internal drive controller.</p>

Components	Specification
Ports	<p>Front: Two USB 3.1 G1 (5 Gb/s) ports, optional VGA port.</p> <p>Rear: USB 3.1 G1 (5 Gb/s) ports, one VGA video port, one DB-9 serial port, and one RJ-45 1GbE systems management port.</p> <p>Internal: Optional M.2 module supporting up to two M.2 drives (for OS boot and drive storage support; not available in all configurations).</p>
Cooling	Six or seven N+1 redundant hot swap 40 mm fans, configuration dependent. One fan integrated in each power supply.
Power supply	Up to two hot-swap redundant AC power supplies (all 80 PLUS Platinum certification): 550 W, 750 W, 1100 W and 1600 W AC options, supporting 220 V AC. 550 W, 750 W and 1100 W options also support 110V input supply. In China only, all power supply options support 240 V DC.
Video	Onboard graphics with 512 MB memory with 2D hardware accelerator, integrated into the ASPEED AST2500 BMC management processor. Maximum resolution is 1920x1200 at 60Hz, 32bpp
Hot-swap parts	Drives, power supplies, and fans.
Systems management	ASPEED AST2500 embedded management processor, XClarity Provisioning Manager Lite (LXPM Lite) for system setup and firmware upgrades. XClarity Administrator centralized infrastructure management, and XClarity Energy Manager centralized server power management. Light path diagnostics for local failure detection and reporting.
Security features	Power-on password, administrator's password, Trusted Platform Module (TPM), supporting TPM 2.0. In China only, optional Natonz TPM 2.0. Optional lockable front security bezel. Planned support for a chassis intrusion switch.
Operating systems supported	Microsoft Windows Server, Red Hat Enterprise Linux, SUSE Linux Enterprise Server, VMware ESXi. See the Operating system support section for specifics.
Limited warranty	Three-year or one-year (model dependent) customer-replaceable unit and onsite limited warranty with 9x5 next business day (NBD).
Service and support	Optional service upgrades are available through Lenovo Services: 4-hour or 2-hour response time, 6-hour fix time, 1-year or 2-year warranty extension, software support for Lenovo hardware and some third-party applications.
Dimensions	Height: 43 mm (1.3 in.), width: 434 mm (17.1 in.), depth: 778 mm (30.6 in.)
Weight	Maximum: 19.2 kg (42.3 lb)

Models

Models of the SR635 are defined based on whether the server has 2.5-inch drive bays at the front (called the 10x 2.5" chassis or simply the 2.5-inch chassis) or whether it has 3.5-inch drive bays at the front (called the 4x 3.5" chassis or simply the 3.5-inch chassis). For models, the feature codes for these chassis bases are as listed in the following table.

Table 2. Chassis base feature codes

Feature code	Description
B5VL	ThinkSystem SR635 10x2.5" Chassis
B5VM	ThinkSystem SR635 4x3.5" Chassis

The following tables list the available models, grouped by region.

- [Models for Australia and New Zealand](#)
- [Models for South East Asian regions \(ASEAN\)](#)
- [Models for Brazil](#)
- [Models for EMEA regions](#)
- [Models for Hong Kong, Taiwan, Korea \(HTK\)](#)
- [Models for India](#)
- [Models for Japan](#)
- [Models for Latin American regions \(except Brazil\)](#)
- [Models for USA and Canada](#)

Refer to the Specifications section for information about standard features of the server.

Models for Australia and New Zealand

Table 3. Models for Australia and New Zealand

Model	AMD EPYC processor†	Memory	RAID	Drive bays	OCP adapter	Slots*	Power supplies	Power cords	Front VGA	Fans	Rail kit
TopSeller models with a 3-year model (machine type 7Y99)											
7Y99A00XAU	7302P 16C 155W 3.0GHz	1x 32GB 3200	730-8i 2GB	8x 2.5" SAS Open bay	4x1Gb	1x FHHL x16 / 0	2x 750W	Yes	Yes	6x Std	Fric
7Y99A014AU	7402P 24C 180W 2.8GHz	1x 32GB 3200	730-8i 2GB	8x 2.5" SAS Open bay	4x1Gb	1x FHHL x16 / 0	2x 750W	Yes	Yes	6x Perf	Fric
7Y99A00UAU	7502P 32C 180W 2.5GHz	1x 32GB 3200	730-8i 2GB	8x 2.5" SAS Open bay	4x1Gb	1x FHHL x16 / 0	2x 750W	Yes	Yes	6x Perf	Fric
7Y99A00WAU	7702P 64C 200W 2.0GHz	1x 32GB 3200	730-8i 2GB	8x 2.5" SAS Open bay	4x1Gb	1x FHHL x16 / 0	2x 750W	Yes	Yes	6x Perf	Fric

† Processor description: AMD EPYC model, number of cores, thermal design power (TDP), core frequency

* Slots are listed as (x / y) where x = rear-accessible slots, y = internal slot)

Models for South East Asian regions (ASEAN)

Table 4. Models for South East Asian regions (ASEAN)

Model	AMD EPYC processor†	Memory	RAID	Drive bays	OCP adapter	Slots*	Power supplies	Power cords	Front VGA	Fans	Rail kit
TopSeller models with a 3-year model (machine type 7Y99)											
7Y99A00VSG	7302P 16C 155W 3.0GHz	1x 32GB 3200	730-8i 2GB	8x 2.5" SAS Open bay	4x1Gb	1x FHHL x16 / 0	2x 750W	Yes	Yes	6x Std	Fric
7Y99A00QSG	7402P 24C 180W 2.8GHz	1x 32GB 3200	730-8i 2GB	8x 2.5" SAS Open bay	4x1Gb	1x FHHL x16 / 0	2x 750W	Yes	Yes	6x Perf	Fric
7Y99A00YSG	7502P 32C 180W 2.5GHz	1x 32GB 3200	730-8i 2GB	8x 2.5" SAS Open bay	4x1Gb	1x FHHL x16 / 0	2x 750W	Yes	Yes	6x Perf	Fric
7Y99A00RSG	7702P 64C 200W 2.0GHz	1x 32GB 3200	730-8i 2GB	8x 2.5" SAS Open bay	4x1Gb	1x FHHL x16 / 0	2x 750W	Yes	Yes	6x Perf	Fric

† Processor description: AMD EPYC model, number of cores, thermal design power (TDP), core frequency

* Slots are listed as (x / y) where x = rear-accessible slots, y = internal slot)

Models for Brazil

Table 5. Models for Brazil

Model	AMD EPYC processor†	Memory	RAID	Drive bays	OCP adapter	Slots*	Power supplies	Power cords	Front VGA	Fans	Rail kit
Standard models with a 3-year model (machine type 7Y99)											
7Y99A01GBR	7262 8C 155W 3.2GHz	1x 16GB 2933	530-8i	8x 2.5" SAS Open bay	4x1Gb	3x LP x16 / 0	1x 750W	Yes	Yes	6x Std	Slide
7Y99A01HBR	7302P 16C 155W 3.0GHz	1x 16GB 2933	530-8i	8x 2.5" SAS Open bay	4x1Gb	3x LP x16 / 0	1x 750W	Yes	Yes	6x Std	Slide
7Y99A01JBR	7302P 16C 155W 3.0GHz	1x 32GB 2933	730-8i 1GB	8x 2.5" SAS Open bay	4x1Gb	3x LP x16 / 0	1x 750W	Yes	Yes	6x Std	Slide
7Y99A01FBR	7402P 24C 180W 2.8GHz	1x 32GB 2933	730-8i 1GB	8x 2.5" SAS Open bay	4x1Gb	3x LP x16 / 0	1x 1100W	Yes	Yes	6x Perf	Slide

† Processor description: AMD EPYC model, number of cores, thermal design power (TDP), core frequency

* Slots are listed as (x / y) where x = rear-accessible slots, y = internal slot)

Models for EMEA regions

Table 6. Models for EMEA regions

Model	AMD EPYC processor†	Memory	RAID	Drive bays	OCP adapter	Slots*	Power supplies	Power cords	Front VGA	Fans	Rail kit
Standard models with a 3-year model (machine type 7Y99)											
7Y99A00KEA	7262 8C 155W 3.2GHz	1x 32GB 3200	Onboard AHCI	10x 2.5" (6xSAS + 4xAny) Open bay	Open	Open	1x 750W	Yes	Yes	6x Std	Slide
7Y99A00LEA	7302P 16C 155W 3.0GHz	1x 32GB 3200	Onboard AHCI	10x 2.5" (6xSAS + 4xAny) Open bay	Open	Open	1x 750W	Yes	Yes	6x Std	Slide
7Y99A00NEA	7302P 16C 155W 3.0GHz	1x 32GB 3200	Onboard AHCI	4x 3.5" SAS Open bay	Open	Open	1x 750W	Yes	Yes	6x Std	Slide
7Y99A00JEA	7502P 32C 180W 2.5GHz	1x 32GB 3200	Onboard AHCI	10x 2.5" (6xSAS + 4xAny) Open bay	Open	Open	1x 750W	Yes	Yes	6x Perf	Slide
7Y99A00HEA	7702P 64C 200W 2.0GHz	1x 32GB 3200	Onboard AHCI	10x 2.5" (6xSAS + 4xAny) Open bay	Open	Open	1x 750W	Yes	Yes	6x Perf	Slide
7Y99A00MEA	7742 64C 225W 2.25GHz	1x 32GB 3200	Onboard AHCI	10x 2.5" (6xSAS + 4xAny) Open bay	Open	Open	1x 1100W	Yes	Yes	6x Perf	Slide

† Processor description: AMD EPYC model, number of cores, thermal design power (TDP), core frequency

* Slots are listed as (x / y) where x = rear-accessible slots, y = internal slot

Models for Hong Kong, Taiwan, Korea (HTK)

Table 7. Models for Hong Kong, Taiwan, Korea (HTK)

Model	AMD EPYC processor†	Memory	RAID	Drive bays	OCP adapter	Slots*	Power supplies	Power cords	Front VGA	Fans	Rail kit
TopSeller models with a 3-year model (machine type 7Y99)											
7Y99A00ZCN	7302P 16C 155W 3.0GHz	1x 32GB 3200	730-8i 2GB	8x 2.5" SAS Open bay	4x1Gb	1x FHHL x16 / 0	2x 750W	Yes	Yes	6x Std	Fric
7Y99A010CN	7402P 24C 180W 2.8GHz	1x 32GB 3200	730-8i 2GB	8x 2.5" SAS Open bay	4x1Gb	1x FHHL x16 / 0	2x 750W	Yes	Yes	6x Perf	Fric
7Y99A012CN	7502P 32C 180W 2.5GHz	1x 32GB 3200	730-8i 2GB	8x 2.5" SAS Open bay	4x1Gb	1x FHHL x16 / 0	2x 750W	Yes	Yes	6x Perf	Fric
7Y99A013CN	7702P 64C 200W 2.0GHz	1x 32GB 3200	730-8i 2GB	8x 2.5" SAS Open bay	4x1Gb	1x FHHL x16 / 0	2x 750W	Yes	Yes	6x Perf	Fric

† Processor description: AMD EPYC model, number of cores, thermal design power (TDP), core frequency

* Slots are listed as (x / y) where x = rear-accessible slots, y = internal slot

Models for India

Table 8. Models for India

Model	AMD EPYC processor†	Memory	RAID	Drive bays	OCP adapter	Slots*	Power supplies	Power cords	Front VGA	Fans	Rail kit
TopSeller models with a 3-year model (machine type 7Y99)											
7Y99A011SG	7302P 16C 155W 3.0GHz	1x 32GB 3200	730-8i 2GB	8x 2.5" SAS Open bay	4x1Gb	1x FHHL x16 / 0	2x 750W	Yes	Yes	6x Std	Fric
7Y99A00SSG	7402P 24C 180W 2.8GHz	1x 32GB 3200	730-8i 2GB	8x 2.5" SAS Open bay	4x1Gb	1x FHHL x16 / 0	2x 750W	Yes	Yes	6x Perf	Fric
7Y99A00PSG	7502P 32C 180W 2.5GHz	1x 32GB 3200	730-8i 2GB	8x 2.5" SAS Open bay	4x1Gb	1x FHHL x16 / 0	2x 750W	Yes	Yes	6x Perf	Fric
7Y99A00TSG	7702P 64C 200W 2.0GHz	1x 32GB 3200	730-8i 2GB	8x 2.5" SAS Open bay	4x1Gb	1x FHHL x16 / 0	2x 750W	Yes	Yes	6x Perf	Fric

† Processor description: AMD EPYC model, number of cores, thermal design power (TDP), core frequency

* Slots are listed as (x / y) where x = rear-accessible slots, y = internal slot

Models for Japan

Table 9. Models for Japan

Model	AMD EPYC processor†	Memory	RAID	Drive bays	OCP adapter	Slots*	Power supplies	Power cords	Front VGA	Fans	Rail kit
TopSeller models with a 3-year model (machine type 7Y99)											
7Y99A01BJP	7262 8C 155W 3.2GHz	1x 16GB 3200	530-8i	8x 2.5" SAS Open bay	4x1Gb	1x FHHL x16 / 0	1x 750W	Opt	Yes	6x Std	Slide
7Y99A015JP	7302P 16C 155W 3.0GHz	1x 16GB 3200	530-8i	8x 2.5" SAS Open bay	4x1Gb	1x FHHL x16 / 0	1x 750W	Opt	Yes	6x Std	Slide
7Y99A019JP	7502P 32C 180W 2.5GHz	1x 16GB 3200	730-8i 2GB	8x 2.5" SAS Open bay	4x1Gb	1x FHHL x16 / 0	1x 750W	Opt	Yes	6x Perf	Slide
7Y99A01DJP	7702P 64C 200W 2.0GHz	1x 16GB 3200	730-8i 2GB	8x 2.5" SAS Open bay	4x1Gb	1x FHHL x16 / 0	1x 750W	Opt	Yes	6x Perf	Slide

† Processor description: AMD EPYC model, number of cores, thermal design power (TDP), core frequency

* Slots are listed as (x / y) where x = rear-accessible slots, y = internal slot

Models for Latin American regions (except Brazil)

Table 10. Models with a 1-year warranty for Latin American regions (except Brazil)

Model	AMD EPYC processor†	Memory	RAID	Drive bays	OCP adapter	Slots*	Power supplies	Power cords	Front VGA	Fans	Rail kit
Standard models with a 3-year model (machine type 7Y99)											
7Y991000LA	7262 8C 155W 3.2GHz	1x 16GB 3200	530-8i	8x 2.5" SAS Open bay	4x1Gb	3x LP x16 / 0	1x 750W	Yes	Yes	6x Std	Slide
7Y991001LA	7302P 16C 155W 3.0GHz	1x 32GB 3200	530-8i	8x 2.5" SAS Open bay	4x1Gb	3x LP x16 / 0	1x 750W	Yes	Yes	6x Std	Slide

† Processor description: AMD EPYC model, number of cores, thermal design power (TDP), core frequency

* Slots are listed as (x / y) where x = rear-accessible slots, y = internal slot)

Models for USA and Canada

Table 11. Models for USA and Canada

Model	AMD EPYC processor†	Memory	RAID	Drive bays	OCP adapter	Slots*	Power supplies	Power cords	Front VGA	Fans	Rail kit
Standard models with a 3-year model (machine type 7Y99)											
7Y99A01CNA	7302P 16C 155W 3.0GHz	1x 8GB 2933	Option	Optional 2.5" Open bay	Open	Open	1x 750W	Yes	Yes	6x Std	Slide
7Y99A017NA	7502P 32C 180W 2.5GHz	1x 32GB 3200	Option	Optional 2.5" Open bay	Open	Open	1x 1100W	Yes	Yes	6x Perf	Slide
7Y99A018NA	7702P 64C 200W 2.0GHz	1x 32GB 3200	Option	Optional 2.5" Open bay	Open	Open	1x 1100W	Yes	Yes	6x Perf	Slide
TopSeller models with a 3-year model (machine type 7Y99)											
7Y99A01ANA	7302P 16C 155W 3.0GHz	1x 16GB 3200	Option	Optional 2.5" Open bay	Open	Open	1x 750W	Yes	Yes	6x Std	Slide
7Y99A016NA	7402P 24C 180W 2.8GHz	1x 32GB 3200	Option	Optional 2.5" Open bay	Open	Open	1x 1100W	Yes	Yes	6x Perf	Slide

† Processor description: AMD EPYC model, number of cores, thermal design power (TDP), core frequency

* Slots are listed as (x / y) where x = rear-accessible slots, y = internal slot)

Processor options

The SR635 supports processors in the second-generation AMD EPYC family of processors. The server supports one processor.

The table below lists the supported AMD processors.

All supported processors have the following characteristics:

- Second-generation AMD EPYC processors (formerly codenamed "Rome")
- 7 nm process technology
- Eight DDR4 memory channels
- 128 PCIe 4.0 I/O lanes

Part numbers: Processors do not include an option part number because there are no field upgrades supported.

Table 12. Processor options for the SR635

Feature code	Description
B6TS	ThinkSystem AMD EPYC 7262 8C 155W 3.2GHz Processor

Feature code	Description
B6TV	ThinkSystem AMD EPYC 7302 16C 155W 3.0GHz Processor
B6VV	ThinkSystem AMD EPYC 7302P 16C 155W 3.0GHz Processor
B6VW	ThinkSystem AMD EPYC 7402 24C 180W 2.8GHz Processor
B6TT	ThinkSystem AMD EPYC 7402P 24C 180W 2.8GHz Processor
B6TU	ThinkSystem AMD EPYC 7452 32C 155W 2.35 GHz Processor
B5XG	ThinkSystem AMD EPYC 7502 32C 180W 2.5GHz Processor
B6VX	ThinkSystem AMD EPYC 7502P 32C 180W 2.5GHz Processor
B6TR	ThinkSystem AMD EPYC 7702 64C 200W 2.0GHz Processor
B6VY	ThinkSystem AMD EPYC 7702P 64C 200W 2.0GHz Processor
B5XF	ThinkSystem AMD EPYC 7742 64C 225W 2.25 GHz Processor

Processor features

The following table lists the features of the supported processors.

P suffix: Processor models with a P suffix are designated as single-socket processors. They have identical features to the non-P equivalent processors.

Table 13. Processor specifications

EPYC model	Cores / Threads	Base Frequency	Max Boost Frequency†	L3 Cache	Memory channels	Memory bus	TDP
7262	8 / 16	3.2 GHz	3.40 GHz	128 MB	8	3200 MHz	155W
7302	16 / 32	3.0 GHz	3.30 GHz	128 MB	8	3200 MHz	155W
7302P	16 / 32	3.0 GHz	3.30 GHz	128 MB	8	3200 MHz	155W
7402	24 / 48	2.8 GHz	3.35 GHz	128 MB	8	3200 MHz	180W
7402P	24 / 48	2.8 GHz	3.35 GHz	128 MB	8	3200 MHz	180W
7452	32 / 64	2.35 GHz	3.35 GHz	128 MB	8	3200 MHz	155W
7502	32 / 64	2.5 GHz	3.35 GHz	128 MB	8	3200 MHz	180W
7502P	32 / 64	2.5 GHz	3.35 GHz	128 MB	8	3200 MHz	180W
7702	64 / 128	2.0 GHz	3.35 GHz	256 MB	8	3200 MHz	200W
7702P	64 / 128	2.0 GHz	3.35 GHz	256 MB	8	3200 MHz	200W
7742	64 / 128	2.25 GHz	3.40 GHz	256 MB	8	3200 MHz	225W

† The maximum single-core frequency at which the processor is capable of operating

Memory options

The server uses Lenovo TruDDR4 memory operating at up to 3200 MHz. The processors have 8 memory channels and support 2 DIMMs per channel, for a total of 16 DIMMs.

The server supports up to 1TB of memory using 16x 64 GB RDIMMs.

The server supports these memory DIMMs:

- 2933 MHz DIMMs, that operate at 2933 MHz both at 1 DIMM per channel and 2 DIMMs per channel
- 3200 MHz DIMMs, that operate at 3200 MHz at 1 DIMM per channel, and at 2933 MHz at 2 DIMMs per channel

Note that if the processor selected has a memory bus speed of 2666 MHz, then all DIMMs will operate at 2666 MHz, even if the DIMMs are rated for a higher speed MHz.

The following table lists the memory options that are available for the server.

Lenovo TruDDR4 memory uses the highest quality components that are sourced from Tier 1 DRAM suppliers and only memory that meets the strict requirements of Lenovo is selected. It is compatibility tested and tuned to maximize performance and reliability. From a service and support standpoint, Lenovo TruDDR4 memory automatically assumes the system warranty, and Lenovo provides service and support worldwide.

Table 14. Supported memory options

Part number	Feature code	Description	Maximum supported	Memory vendor
2933 MHz memory				
4ZC7A08739	B7MS	ThinkSystem 8GB TruDDR4 2933MHz (1Rx8 1.2V) RDIMM-A	16	Micron
4ZC7A08740	B7MT	ThinkSystem 16GB TruDDR4 2933MHz (1Rx4 1.2V) RDIMM-A	16	Hynix
4ZC7A08741	B7MU	ThinkSystem 16GB TruDDR4 2933MHz (2Rx8 1.2V) RDIMM-A	16	Hynix
4ZC7A08742	B7MV	ThinkSystem 32GB TruDDR4 2933MHz (2Rx4 1.2V) RDIMM-A	16	Samsung
4ZC7A08744	B7MW	ThinkSystem 64GB TruDDR4 2933MHz (2Rx4 1.2V) RDIMM-A	16	Samsung
3200 MHz memory				
4ZC7A15121	B5XD	ThinkSystem 16GB TruDDR4 3200MHz (2Rx8 1.2V) RDIMM-A	16	Micron
4ZC7A15122	B5XE	ThinkSystem 32GB TruDDR4 3200MHz (2Rx4 1.2V) RDIMM-A	16	Samsung
4ZC7A15124	B5XC	ThinkSystem 64GB TruDDR4 3200MHz (2Rx4 1.2V) RDIMM-A	16	Hynix

The following rules apply when selecting the memory configuration:

- The server currently supports only RDIMMs.
- Mixing of DIMM vendor is supported, but not in the same channel (see the table above)
- Mixing x4 and x8 DIMMs is supported, but not in the same channel
- Mixing of DIMM rank counts is supported. Follow the required installation order installing the DIMMs with the higher rank counts first.
- Mixing of DIMM capacities is supported, however only two different capacities are supported across all channels of the processor (eg 32GB and 64GB). Follow the required installation order installing the larger DIMMs first.
- Mixing of 3200 MHz and 2933 MHz DIMMs is supported, but not in the same channel
- Memory mirroring and memory rank sparing are not supported.

For best performance, consider the following:

- Ensure the memory installed is at least the same speed as the memory bus of the selected processor.
- Populate memory DIMMs in quantities of 8 or 16, so that all memory channels are used.
- Populate memory channels so they all have the same total memory capacity.

The following memory protection technologies are supported:

- ECC detection/correction
- SDDC (for x4-based memory DIMMs; look for "x4" in the DIMM description)
- Patrol/Demand Scrubbing
- DRAM Address Command Parity with Replay
- DRAM Uncorrected ECC Error Retry
- Post Package Repair

Internal storage

The SR635 supports 4x 3.5-inch or 16x 2.5-inch drive bays or a combination of drive bays, depending on the selected chassis and backplane configuration. The server also supports configurations without any drive bays if desired.

All drives are hot-swap and are accessible from the front, from the rear, or from drive bays that are located in the middle of the server (accessible when you remove the top cover of the server).

The three drive bay zones are as follows:

- Front: 4x 3.5-inch hot-swap bays or up to 10x 2.5-inch hot-swap bays
- Mid (internal): 4x 2.5-inch hot-swap bays
- Rear: up to 2x 2.5-inch hot-swap bays

The server also supports one or two M.2 drives, installed in an M.2 adapter.

In this section:

- [NVMe drive support](#)
- [Front drive bays](#)
- [Mid drive bays](#)
- [Rear drive bays](#)
- [Supported drive bay combinations](#)
- [Adapters selections](#)
- [Field upgrades](#)
- [M.2 drives](#)

NVMe drive support

No hot-swap support: NVMe drives currently do not support hot-swap functionality. An update to UEFI firmware to fix this restriction is planned for 4Q/2019.

The SR635 supports NVMe drives to maximize storage performance. The server supports up to 16 NVMe drives without oversubscription (that is, each x4 drive has a full x4 connection (4 lanes) to the processor):

- 10x NVMe drives in the front bays
- 4x NVMe drives in the mid bays
- 2x NVMe drives in the rear bays

The specifics of these configurations plus other NVMe-rich configurations are covered in the [Supported drive bay combinations](#) and [Adapters selections](#) sections.

15mm NVMe drives: 15mm NVMe SSDs are not supported in the mid or rear drive bays due to thermal requirements. Only 7mm NVMe drives are supported in those zones.

Front drive bays

The front drive bay zone supports the following configurations:

- 3.5-inch drive bays
 - No backplane and no drives (supports field upgrades)
 - 4x 3.5-inch SAS/SATA
- 2.5-inch drive bays
 - No backplane and no drives (supports field upgrades)
 - 8x 2.5-inch hot-swap SAS/SATA
 - 6x 2.5-inch hot-swap SAS/SATA + 4x 2.5-inch hot-swap AnyBay
 - 10x 2.5-inch hot-swap AnyBay

These configurations are shown in the following figure.

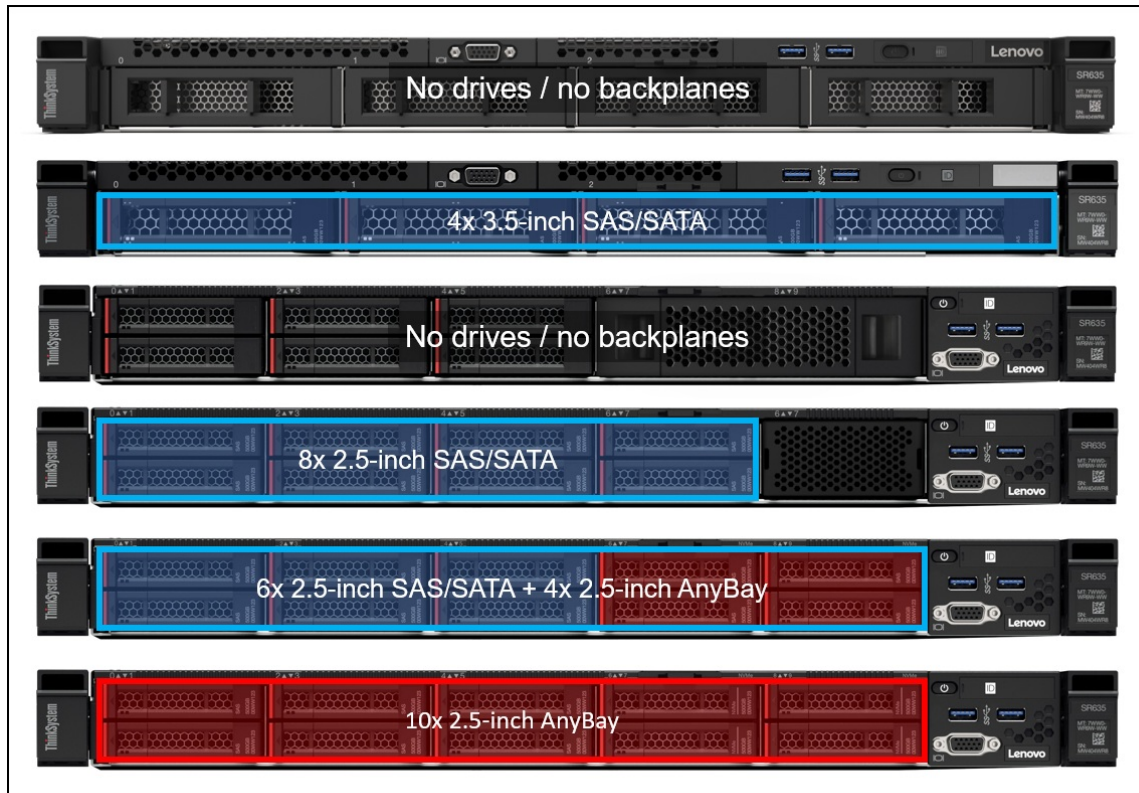

Figure 6. SR635 front drive bay configurations

The backplanes used to provide these drive bays are listed in the following table.

Table 15. Backplanes for front drive bays

Part number	Feature code	Description	Maximum supported
Front 3.5-inch drive backplanes			
See note*	AUW8	ThinkSystem 1U 3.5" SATA/SAS 4-Bay Backplane (4x 3.5-inch SAS/SATA backplane)	1
Front 2.5-inch drive backplanes			
See note*	B7K3	ThinkSystem SR635 2.5" SATA/SAS 8-Bay Backplane (8x 2.5-inch SAS/SATA backplane)	1
See note*	AUW9	ThinkSystem 1U 2.5" 4 AnyBay 10-Bay Backplane (10-bay 2.5-inch backplane with 6x SAS/SATA + 4x AnyBay bays†)	1
See note*	B5VS	ThinkSystem SR635 2.5" 10 Gen4 AnyBay BP (10-bay 2.5-inch backplane with 10x AnyBay bays†)	1

* Backplanes are available as part numbers for field upgrades using upgrade kits, as described in the [Field upgrades](#) section below.

† AnyBay bays support SAS or SATA or NVMe drives

Mid drive bays

The SR635 optionally supports 4x 2.5-inch hot-swap NVMe drive bays installed in the middle of the server chassis. The drive bays are accessible by removing the top lid of the server and levering the mid drive chassis into an angled open position.

The drive bays, angled up, are shown in the following figure.

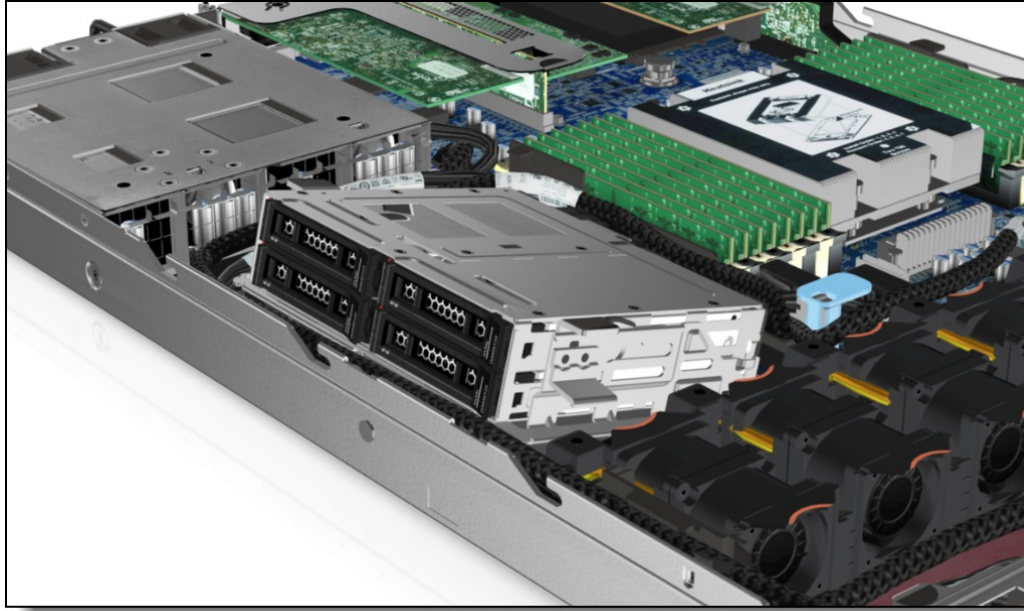

Figure 7. Mid-chassis drive bays (open position)

The backplanes used to provide these drive bays are listed in the following table.

Table 16. Backplanes for mid drive bays

Part number	Feature code	Description	Maximum supported
Mid - 2.5-inch drive backplanes			
See note*	B5VN	ThinkSystem SR635/SR655 2.5" NVMe 4-Bay Backplane (4x 2.5-inch NVMe backplane)	1

* Backplanes are available as part numbers for field upgrades using upgrade kits, as described in the [Field upgrades](#) section below.

The use of drive bays in the mid-chassis area has the following configuration rules:

- Only NVMe drives are supported in the mid chassis area. SAS and SATA drives are not supported.
- The mid drive cage is only supported in conjunction with the 10x 2.5-inch AnyBay backplane (feature AUW9) or the 4x 3.5-inch SAS/SATA backplane (feature AUW8) for the front drives. The use of other front-drive backplanes with the mid cage is not supported.
- The mid drive cage occupies the same physical space as the M.2 module, internal PCIe slot (slot 4) and two of the three holders for RAID power module (supercaps). As a result, the M.2 module, slot 4 and two supercaps cannot be installed.

Rear drive bays

The SR635 supports hot-swap drives installed at the rear of the server chassis. Supported configurations are as follows:

- 2x 2.5-inch hot-swap SAS/SATA drive bays
- 2x 2.5-inch hot-swap NVMe drive bays

The configurations are shown in the following figure.

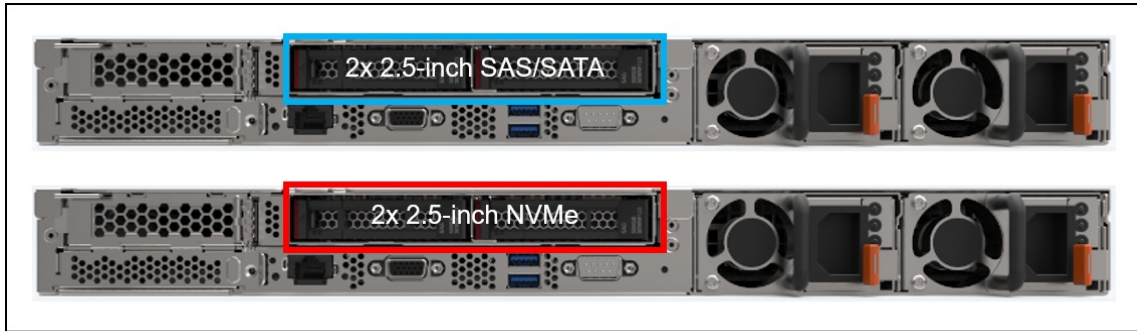

Figure 8. Rear drive bay configurations

The backplanes used to provide these drive bays are listed in the following table.

Table 17. Backplanes for rear drive bays

Part number	Feature code	Description	Maximum supported
Rear - 2.5-inch drive backplanes			
See note*	B5VR	ThinkSystem SR635 2.5" SATA/SAS 2-Bay Rear Backplane (2x 2.5-inch SAS/SATA backplane)	1
See note*	B5VQ	ThinkSystem SR635 2.5" NVMe Gen4 2-Bay Rear BP (2x 2.5-inch NVMe backplane)	1

* Backplanes are available as part numbers for field upgrades using upgrade kits, as described in the [Field upgrades](#) section below.

The use of rear drive bays has the following configuration rules:

- Slots 2 and 3 are not available
- Slot 1 is a low-profile slot
- GPUs are not supported

Supported drive bay combinations

This section describes the various combinations of 3.5-inch and 2.5-inch drives that the server supports. The drive bay combinations are grouped based on the drive type at the front of the server, 3.5-inch or 2.5-inch.

3.5-inch drive bay chassis

The following table shows the supported combinations when the server is configured with a 3.5-inch chassis (where the front drive bays are 3.5-inch). The choice of storage controller for each configuration is listed in the [Adapter selections](#) section.

Table 18. Drive bay combinations with 3.5-inch chassis (Blue cells = SAS/SATA, Red cells = NVMe)

Config	Total drives	Front bays (3.5")	Mid bays (2.5")	Rear bays (2.5")	
		SAS/SATA	NVMe	SAS/SATA	NVMe
A	4	4	0	0	0
B	6	4	0	2	0
C	6	4	0	0	2
D	8	4	4	0	0

2.5-inch drive bay chassis

The following table shows the supported combinations when the server is configured with a 2.5-inch chassis (where the front drive bays are 2.5-inch). The choice of storage controller for each configuration is listed in the [Adapter selections](#) section.

Table 19. Drive bay combinations with 2.5-inch chassis (Blue cells = SAS/SATA, Red cells = NVMe, Purple cells = AnyBay)

Config	Total drives	Front bays (2.5")		Mid bays (2.5")	Rear bays (2.5")	
		SAS/SATA	AnyBay	NVMe	SAS/SATA	NVMe
2.5-inch chassis - only SAS/SATA drives in the front bays						
A	8	8	0	0	0	0
B	10	8	0	0	2	0
C	10	8	0	0	0	2
2.5-inch chassis - mix of SAS/SATA-only bays and AnyBay bays in the front						
D	10	6	4	0	0	0
E	12	6	4	0	2	0
F	12	6	4	0	0	2
2.5-inch chassis - all AnyBay bays in the front						
G	10	0	10	0	0	0
H	12	0	10	0	2	0
I	12	0	10	0	0	2
J	14	0	10	4	0	0
K	16	0	10	4	2	0
L	16	0	10	4	0	2

Adapter selections

The following tables lists the supported drive bay combinations plus the list of supported controller combinations supported by each of those drive bay combinations. Information about the controllers can be found in the [Controllers for internal storage](#) section.

Table 20. Drive bay combinations with 3.5-inch chassis (Blue cells = SAS/SATA, Red cells = NVMe)

Cfg	Total drives	Front bays (3.5")		Mid bays (2.5")		Rear bays (2.5")		Supported controller combinations (choose one) (OB = Onboard)
		SAS/SATA	NVMe	SAS/SATA	NVMe	SAS/SATA	NVMe	
A	4	4	0	0	0	0	0	<ul style="list-style-type: none"> • OB SATA • 530-8i • 730-8i 1G • 730-8i 2G • 930-8i • 430-8i
B	6	4	0	2	0	0	0	<ul style="list-style-type: none"> • OB SATA • 530-8i • 730-8i 1G • 730-8i 2G • 930-8i • 430-8i
C	6	4	0	0	0	2	0	<ul style="list-style-type: none"> • OB SATA + OB NVMe • 530-8i + OB NVMe • 730-8i 1G + OB NVMe • 730-8i 2G + OB NVMe • 930-8i + OB NVMe • 430-8i + OB NVMe
D	8	4	4	0	0	0	0	<ul style="list-style-type: none"> • OB SATA + OB NVMe (no M.2*) • 530-8i + OB NVMe (no M.2*) • 730-8i 1G + OB NVMe (no M.2*) • 430-8i + OB NVMe (no M.2*)

* The configurations with 4 mid drives do not support the M.2 Module because the mid drive bays and the M.2 Module occupy the same physical space.

Table 21. Drive bay combinations with 2.5-inch chassis (Blue cells = SAS/SATA, Red cells = NVMe, Purple cells = AnyBay)

Cfg	Total drives	Front bays (2.5")		Mid bays (2.5")	Rear bays (2.5")		Supported controller combinations (choose one) (OB = Onboard)
		SAS/SATA	AnyBay	NVMe	SAS/SATA	NVMe	
2.5-inch chassis - only SAS/SATA drives in the front bays							
A	8	8	0	0	0	0	<ul style="list-style-type: none"> • OB SATA • 530-8i • 730-8i 1G • 730-8i 2G • 930-8i • 430-8i

Cfg	Total drives	Front bays (2.5")		Mid bays (2.5")	Rear bays (2.5")		Supported controller combinations (choose one) (OB = Onboard)
		SAS/SATA	AnyBay	NVMe	SAS/SATA	NVMe	
B	10	8	0	0	2	0	<ul style="list-style-type: none"> • OB SATA • 2x 530-8i • 2x 730-8i 1G • 1x 530-8i + 1x 430-8i • 1x 930-16i • 2x 430-8i
C	10	8	0	0	0	2	<ul style="list-style-type: none"> • OB SATA + OB NVMe • 530-8i + OB NVMe • 730-8i 1G + OB NVMe • 730-8i 2G + OB NVMe • 930-8i + OB NVMe • 430-8i + OB NVMe
2.5-inch chassis - mix of SAS/SATA-only bays and AnyBay bays in the front							
D	10	6	4	0	0	0	<ul style="list-style-type: none"> • OB SATA + OB NVMe • 2x 530-8i + OB NVMe • 2x 730-8i 1G + OB NVMe • 1x 930-16i + OB NVMe • 2x 430-8i + OB NVMe • 1x 430-16i + OB NVMe
E	12	6	4	0	2	0	<ul style="list-style-type: none"> • OB SATA + OB NVMe (no M.2*) • 2x 530-8i + OB NVMe • 2x 730-8i 1G + OB NVMe • 1x 930-16i + OB NVMe • 2x 430-8i + OB NVMe • 1x 430-16i + OB NVMe
F	12	6	4	0	0	2	<ul style="list-style-type: none"> • OB SATA + OB NVMe • 2x 530-8i + OB NVMe • 2x 730-8i 1G + OB NVMe • 1x 930-16i + OB NVMe • 2x 430-8i + OB NVMe • 1x 430-16i + OB NVMe
2.5-inch chassis - all AnyBay bays in the front							
G	10	0	10	0	0	0	<ul style="list-style-type: none"> • OB SATA + OB NVMe • 2x 530-8i + OB NVMe • 2x 730-8i 1G + OB NVMe • 1x 930-16i + OB NVMe • 2x 430-8i + OB NVMe • 1x 430-16i + OB NVMe
H	12	0	10	0	2	0	<ul style="list-style-type: none"> • OB SATA + OB NVMe (no M.2*) • 2x 530-8i + OB NVMe • 2x 730-8i 1G + OB NVMe • 1x 930-16i + OB NVMe • 2x 430-8i + OB NVMe • 1x 430-16i + OB NVMe

Cfg	Total drives	Front bays (2.5")		Mid bays (2.5")	Rear bays (2.5")		Supported controller combinations (choose one) (OB = Onboard)
		SAS/SATA	AnyBay	NVMe	SAS/SATA	NVMe	
I	12	0	10	0	0	2	<ul style="list-style-type: none"> • 2x 530-8i + OB NVMe • 2x 730-8i 1G + OB NVMe • 1x 930-16i + OB NVMe • 2x 430-8i + OB NVMe • 1x 430-16i + OB NVMe
J	14	0	10	4	0	0	<ul style="list-style-type: none"> • 1x 930-16i+OB NVMe (no M.2*) • 1x 430-16i+OB NVMe (no M.2*)
K	16	0	10	4	2	0	<ul style="list-style-type: none"> • 1x 930-16i+OB NVMe (no M.2*) • 1x 430-16i+OB NVMe (no M.2*)
L	16	0	10	4	0	2	<ul style="list-style-type: none"> • 1x 930-16i+OB NVMe (no M.2*) • 1x 430-16i+OB NVMe (no M.2*)

* These configurations, with 12 total SATA drives connected to the onboard SATA controller, or 4 mid drive bays, do not support the use of the M.2 Module. The M.2 Module and the onboard SATA bays use the same ports on the system board and the mid drive bays occupy the same space as the M.2 Module.

Field upgrades

The following table lists the option part numbers for the backplane kits that allow you to add additional drive bays as field upgrades. The table also lists what major components are included in each kit.

When adding drive bays, you will also need to add the appropriate storage controller(s). Consult the tables in the [Adapter selections](#) section to determine what controller sections are supported and what additional controllers you will need. Controllers are described in the [Controllers for internal storage](#) section.

Table 22. Drive backplane field upgrades

Part number	Description	Maximum supported
Front - 3.5-inch drive backplane (see Front drive bays)		
4XH7A09825	ThinkSystem SR635 3.5" SATA/SAS 4-Bay Backplane Kit <ul style="list-style-type: none"> • 1x 4-bay SAS/SATA backplane • SATA Cable Kits (power and SATA cables) • SAS/SATA Cable Kit (power cable, miniSAS-HD cable) 	1
Front - 2.5-inch drive backplanes (see Front drive bays)		
4XH7A09826	ThinkSystem SR635 2.5" SATA/SAS 8-Bay Backplane Kit <ul style="list-style-type: none"> • 1x 8-bay SAS/SATA backplane • 2-bay filler • SATA Cable Kits (power and SATA cables) • SAS/SATA Cable Kits (power cables, miniSAS-HD cables) 	1

Part number	Description	Maximum supported
4XH7A09827	ThinkSystem SR635 2.5" 4 Gen3 AnyBay 10-Bay BP Kit (10-bay 2.5-inch backplane with 6x SAS/SATA bays + 4x AnyBay bays†) <ul style="list-style-type: none"> • 1x 10-bay backplane (4 bays are AnyBay) • SATA Cable Kits (power and SATA cables) • SAS/SATA Cable Kits (power cables, miniSAS-HD cables) • NVMe cables (two slimline 1x8-to-2x4 cables) 	1
4XH7A09828	ThinkSystem SR635 2.5" 10 Gen4 AnyBay BP Kit (10-bay 2.5-inch backplane where all bays are AnyBay bays†) <ul style="list-style-type: none"> • 1x 10-bay backplane (all bays are AnyBay) • SATA Cable Kits (power and SATA cables) • SAS/SATA Cable Kits (power cables, miniSAS-HD cables) • NVMe cable kit 	1
Mid - 2.5-inch drive backplane (see Mid drive bays)		
4XH7A09856	ThinkSystem SR635 2.5" NVMe Gen4 4-Bay Middle Drive Kit <ul style="list-style-type: none"> • Mid-chassis 2.5-inch drive cage • 4-bay 2.5-inch NVMe backplane • 7x Performance fans (replaces existing fans) • Air baffle (replace existing baffle) • NVMe Cable Kit (power cable, signal cable) 	1
Rear - 2.5-inch drive backplanes (see Rear drive bays)		
4XH7A09852	ThinkSystem SR635 2.5" SATA/SAS 2-Bay Rear Drive Kit <ul style="list-style-type: none"> • Rear 2.5-inch drive cage • 2-bay 2.5-inch SAS/SATA rear backplane • 7x Performance fans (replaces existing fans) • SATA Cable Kit (power cable, SATA cable) • SAS/SATA Cable Kit (power cable, miniSAS-HD cable) 	1
4XH7A09853	ThinkSystem SR635 2.5" NVMe Gen4 2-Bay Rear Drive Kit <ul style="list-style-type: none"> • Rear 2.5-inch drive cage • 2-bay 2.5-inch NVMe rear backplane • 7x Performance fans (replaces existing fans) • NVMe Cable Kit (power cable, signal cable) 	1

† AnyBay bays support SAS or SATA or NVMe drives

If you plan to add one of the RAID adapters that includes a RAID flash power module (supercap) as a field upgrade, then you will also need to order a Supercap installation kit for the power module. For CTO orders, the components in the installation kit are automatically derived when you select the RAID adapter. The adapters that this applies to are as follows:

- ThinkSystem RAID 730-8i 2GB Flash PCIe 12Gb Adapter
- ThinkSystem RAID 930-8i 2GB Flash PCIe 12Gb Adapter
- ThinkSystem RAID 930-16i 4GB Flash PCIe 12Gb Adapter

There are three possible locations for supercaps, as shown in the following figure.

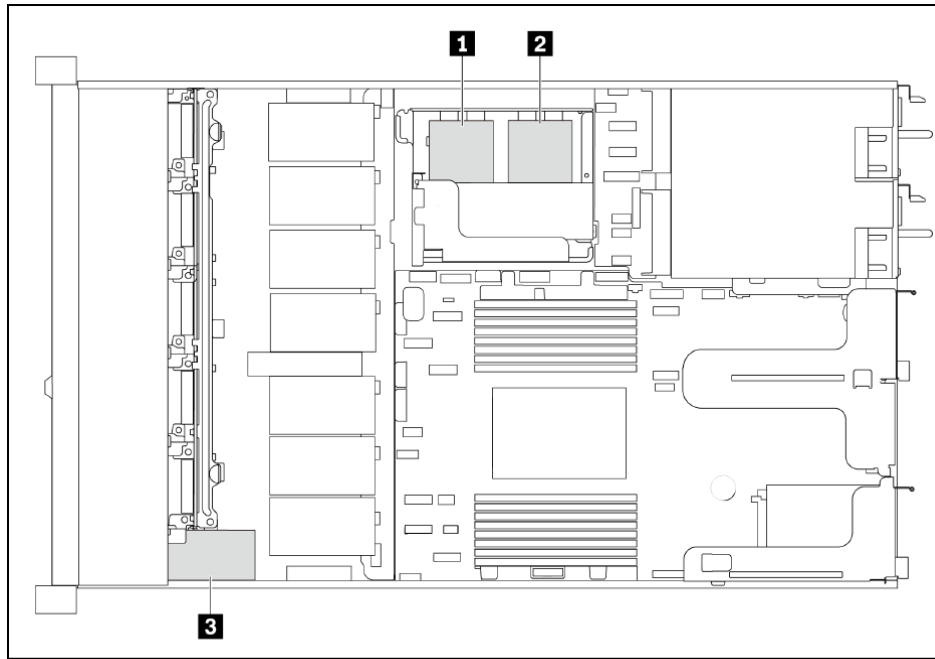

Figure 9. Location of all three supercaps in the SR635

The following configuration rules apply to the use of supercaps:

- Locations 1 and 2 are not available if the mid-chassis drive cage is installed
- Location 3 is only available with 2.5-inch front drive bays. It is not available if 3.5-inch front drives are used

When adding a RAID adapter and supercap as a field upgrade, order the supercap installation kit list listed in the following table.

Table 23. RAID Flash Power Module installation kit

Part number	Feature code	Description
4XH7A09847	B72A	ThinkSystem SR635/SR655 Supercap Installation Kit <ul style="list-style-type: none"> • 1x Bracket to hold two supercaps in their holders • 3x Supercap holders

The following figure shows the use of the components of the option kit to install 1 or 2 supercaps. The third supercap is installed in location 3 in front of the cooling fans and behind the front operator panel as shown in the preceding figure (2.5-inch chassis only; not available with 3.5-inch front drives).

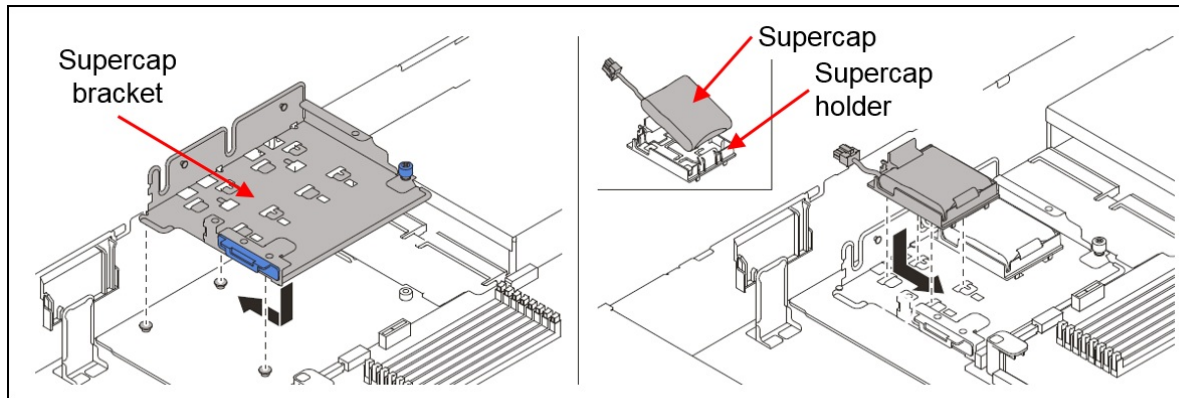

Figure 10. Supercap Installation Kit (locations 1 and 2)

M.2 drives

The server supports one or two M.2 form-factor SATA drives for use as an operating system boot solution or as additional storage. The M.2 drives install into an M.2 module which is mounted horizontally in the server adjacent to the internal storage controller slot as shown in the [Components and connectors](#) section.

M.2 restriction: The M.2 Module cannot be used in certain drive bay combinations:

- When 12 SATA or AnyBay drive bays are configured (10 front, 2 rear) and the SATA drives are connected to the onboard SATA controller (onboard SATA and M.2 use the same connector)
- When 4 mid-chassis drive bays are configured (M.2 occupies the same space)

See [Adapter selections](#) for the specific combinations where the M.2 Module is not supported.

There are two M.2 modules supported, as listed in the following table.

Table 24. M.2 modules

Part number	Feature code	Description	Maximum supported
4Y37A09739	B5XH	ThinkSystem M.2 SATA 2-Bay RAID Enablement Kit	1
4Y37A09738	B5XJ	ThinkSystem M.2 SATA/NVMe 2-Bay Enablement Kit	1

Supported drives are listed in the [Internal drive options](#) section.

The SATA RAID Enablement Kit has the following features:

- Supports one or two SATA M.2 drives
- Support 42mm, 60mm and 80mm drive form factors (2242, 2260 and 2280)
- RAID support via an onboard Marvell 88SE9230 SATA RAID Controller
- Support JBOD, RAID-0 and RAID-1 (RAID support requires two M.2 drives)
- PCIe 2.0 x2 host interface; 6Gbps SATA connection to the drives
- Management and configuration support via UEFI and OS-based tools
- Supports monitoring and reporting of events and temperature through I2C
- Firmware update via Lenovo firmware update tools

The SATA/NVMe Enablement Kit has the following features:

- Supports one or two M.2 drives, either SATA or NVMe
- When two drives installed, they must be either both SATA or both NVMe
- Support 42mm, 60mm and 80mm drive form factors (2242, 2260 and 2280)
- JBOD support only; no RAID support
- Either 6Gbps SATA or PCIe 3.0 x4 interface to the drives depending on the drives installed
- Supports monitoring and reporting of events and temperature through I2C
- Firmware update via Lenovo firmware update tools

For further details about M.2 components, see the *ThinkSystem M.2 Drives and M.2 Adapters* product guide: <https://lenovopress.com/lp0769-thinksystem-m2-drives-adapters>

Controllers for internal storage

The SR635 offers a variety of controller options for internal drives:

- Onboard SATA ports for up to 12 SATA drives
- RAID adapters and HBAs for SAS/SATA drives
- Onboard NVMe ports (for up to 16 NVMe drives)

The following table lists the adapters used for the internal storage of the server.

Table 25. Internal Storage adapter support

Part number	Feature code	Description	Power module (supercap)	Slots supported	Maximum supported
SAS/SATA RAID					
7Y37A01082	AUNG	ThinkSystem RAID 530-8i PCIe 12Gb Adapter	No	4, 1, 3, 2	2
7Y37A01083*	AUNH*	ThinkSystem RAID 730-8i 1GB Cache PCIe 12Gb Adapter	No	4, 1, 3, 2	2
4Y37A09722	B4RQ	ThinkSystem RAID 730-8i 2GB Flash PCIe 12Gb Adapter	Included	4, 1, 3, 2	1
7Y37A01084	AUNJ	ThinkSystem RAID 930-8i 2GB Flash PCIe 12Gb Adapter	Included	4, 1, 3, 2	1
7Y37A01085	AUNK	ThinkSystem RAID 930-16i 4GB Flash PCIe 12Gb Adapter	Included	4, 1, 3, 2	1
SAS/SATA HBA					
7Y37A01088	AUNL	ThinkSystem 430-8i SAS/SATA 12Gb HBA	No	1, 3, 2	2
7Y37A01089	AUNM	ThinkSystem 430-16i SAS/SATA 12Gb HBA	No	1, 3, 2	1

* The RAID 730-8i 1GB Cache adapter is not available in USA and Canada.

Field upgrades: If you are adding a RAID adapter to the SR635 as a field upgrade, you may need a Supercap Installation Kit as described in the [Field upgrades](#) section. Take note of the configuration rules in that section.

The following two tables compare the functions of the storage adapters.

Table 26. Comparison of internal storage controllers - RAID controllers

Feature	RAID 530-8i	RAID 730-8i 1GB**	RAID 730-8i 2GB	RAID 930-8i	RAID 930-16i
Adapter type	RAID controller	RAID controller	RAID controller	RAID controller	RAID controller
Part number	7Y37A01082	7Y37A01083	4Y37A09722	7Y37A01084	7Y37A01085 4Y37A09721
Form factor	PCIe HHHL	PCIe low profile	PCIe low profile	PCIe HHHL	PCIe HHHL
Controller chip	LSI SAS3408	LSI SAS3108	LSI SAS3108	LSI SAS3508	LSI SAS3516
Broadcom equivalent	MegaRAID 9440-8i	MegaRAID 9361-8i	MegaRAID 9361-8i	MegaRAID 9460-8i	MegaRAID 9460-16i
Host interface	PCIe 3.0x8	PCIe 3.0x8	PCIe 3.0x8	PCIe 3.0x8	PCIe 3.0x8
Port interface	12 Gb SAS	12 Gb SAS	12 Gb SAS	12 Gb SAS	12 Gb SAS
Number of ports	8	8	8	8	16
Port connectors	2x Mini-SAS HD x4 (SFF-8643)	2x Mini-SAS HD x4 (SFF-8643)	2x Mini-SAS HD x4 (SFF-8643)	2x Mini-SAS HD x4 (SFF-8643)	4x Mini-SAS HD x4 (SFF-8643)
Drive interface	SAS, SATA	SAS, SATA	SAS, SATA	SAS, SATA	SAS, SATA
Drive type	HDD, SED, SSD	HDD, SSD	HDD, SED, SSD	HDD, SED, SSD	HDD, SED, SSD
Hot-swap drives	Yes	Yes	Yes	Yes	Yes
Max devices	8	8	8	8	16
RAID levels	0, 1, 10, 5, 50	0, 1, 10, 5, 50	0, 1, 10, 5, 50, 6, 60	0, 1, 10, 5, 50, 6, 60	0, 1, 10, 5, 50, 6, 60
JBOD mode	Yes	Yes	Yes	Yes	Yes
Cache	None	1GB (Standard)	2GB (Standard)	2GB (Standard)	4GB or 8GB (Standard)
CacheVault cache protection	No	No	Yes (Flash)	Yes (Flash)	Yes (Flash)
Performance Accelerator (FastPath)	Yes	No	Yes	Yes	Yes
SSD Caching (CacheCade Pro 2.0)	No	No	No	No	No
SED support*	Yes	No	Yes	Yes	Yes

* SAS HBAs support SEDs (self-encrypting drives) by using software on the server and simply passing SED commands through the HBA to the drives. SED support by RAID controllers is provided using the built-in MegaRAID SafeStore functionality of the adapter.

** The RAID 730-8i 1GB Cache adapter is not available in USA and Canada.

Table 27. Comparison of internal storage controllers - HBAs

Feature	430-8i	430-16i
Adapter type	HBA	HBA
Part number	7Y37A01088	7Y37A01089
Form factor	PCIe low profile	PCIe low profile
Controller chip	LSI SAS3408	LSI SAS3416
Broadcom equivalent	HBA 9400-8i	HBA 9400-16i
Host interface	PCIe 3.0 x8	PCIe 3.0 x8
Port interface	12 Gb SAS	12 Gb SAS
Number of ports	8	16
Port connectors	2x Mini-SAS HD x4 (SFF-8643)	4x Mini-SAS HD x4 (SFF-8643)
Drive interface	SAS, SATA	SAS, SATA
Drive type	HDD, SSD, SED*	HDD, SSD, SED*
Hot-swap drives	Yes	Yes
Max devices	8	16
RAID levels	No RAID	No RAID
JBOD mode	Yes	Yes
Cache	No	No
CacheVault cache protection with Flash	No	No
Performance Accelerator (FastPath)	No	No
SSD Caching (CacheCade Pro 2.0)	No	No
SED support*	Yes	Yes

* SAS HBAs support SEDs (self-encrypting drives) by using software on the server and simply passing SED commands through the HBA to the drives. SED support by RAID controllers is provided using the built-in MegaRAID SafeStore functionality of the adapter.

For more information about the adapters see the product guides in the RAID adapters or HBA sections of the Lenovo Press web site:

<https://lenovopress.com/servers/options/raid>

<https://lenovopress.com/servers/options/hba>

Internal drive options

The following tables list the hard disk drive and solid-state drive options for the internal disk storage of the server.

- Table 27: [2.5-inch hot-swap 12 Gb SAS HDDs](#)
- Table 28: [2.5-inch hot-swap 6 Gb SAS/SATA HDDs](#)
- Table 29: [2.5-inch hot-swap 6 Gb SAS/SATA SSDs](#)
- Table 30: [2.5-inch U.2 NVMe SSDs](#)
- Table 31: [3.5-inch hot-swap 12 Gb SAS HDDs](#)
- Table 32: [3.5-inch hot-swap 6 Gb SAS/SATA HDDs](#)
- Table 33: [3.5-inch hot-swap 6 Gb SAS/SATA SSDs](#)
- Table 34: [M.2 drives](#)

Tip: The use of M.2 drives requires an additional adapter as described in the [M.2 drives](#) subsection.

Table 28. 2.5-inch hot-swap 12 Gb SAS HDDs

Part number	Feature	Description	Maximum supported
2.5-inch hot-swap HDDs - 12 Gb SAS 10K			
7XB7A00024	AULY	ThinkSystem 2.5" 300GB 10K SAS 12Gb Hot Swap 512n HDD	12
7XB7A00025	AULZ	ThinkSystem 2.5" 600GB 10K SAS 12Gb Hot Swap 512n HDD	12
7XB7A00026	AUM0	ThinkSystem 2.5" 900GB 10K SAS 12Gb Hot Swap 512n HDD	12
7XB7A00027	AUM1	ThinkSystem 2.5" 1.2TB 10K SAS 12Gb Hot Swap 512n HDD	12
7XB7A00028	AUM2	ThinkSystem 2.5" 1.8TB 10K SAS 12Gb Hot Swap 512e HDD	12
2.5-inch hot-swap HDDs - 12 Gb SAS 15K			
7XB7A00021	AULV	ThinkSystem 2.5" 300GB 15K SAS 12Gb Hot Swap 512n HDD	12
7XB7A00022	AULW	ThinkSystem 2.5" 600GB 15K SAS 12Gb Hot Swap 512n HDD	12
2.5-inch hot-swap HDDs - 12 Gb NL SAS			
7XB7A00034	AUM6	ThinkSystem 2.5" 1TB 7.2K SAS 12Gb Hot Swap 512n HDD	12
7XB7A00035	AUM7	ThinkSystem 2.5" 2TB 7.2K SAS 12Gb Hot Swap 512n HDD	12
2.5-inch hot-swap SED HDDs - 12 Gb SAS 10K			
7XB7A00031	AUM5	ThinkSystem 2.5" 600GB 10K SAS 12Gb Hot Swap 512n HDD SED	12

Table 29. 2.5-inch hot-swap 6 Gb SAS/SATA HDDs

Part number	Feature	Description	Maximum supported
2.5-inch hot-swap HDDs - 6 Gb NL SATA			
7XB7A00036	AUUE	ThinkSystem 2.5" 1TB 7.2K SATA 6Gb Hot Swap 512n HDD	12
7XB7A00037	AUUJ	ThinkSystem 2.5" 2TB 7.2K SATA 6Gb Hot Swap 512e HDD	12

Table 30. 2.5-inch hot-swap 6 Gb SAS/SATA SSDs

Part number	Feature	Description	Maximum supported
2.5-inch hot-swap SSDs - 6 Gb SATA - Enterprise Mainstream (3-5 DWPD)			
4XB7A10238	B489	ThinkSystem 2.5" 5200 480GB Mainstream SATA 6Gb Hot Swap SSD	12
4XB7A10239	B48A	ThinkSystem 2.5" 5200 960GB Mainstream SATA 6Gb Hot Swap SSD	12
2.5-inch hot-swap SSDs - 6 Gb SATA - Enterprise Entry (<3 DWPD)			
4XB7A10153	B2X2	ThinkSystem 2.5" 5200 480GB Entry SATA 6Gb Hot Swap SSD	12
4XB7A10154	B2X3	ThinkSystem 2.5" 5200 960GB Entry SATA 6Gb Hot Swap SSD	12
4XB7A10155	B2X4	ThinkSystem 2.5" 5200 1.92TB Entry SATA 6Gb Hot Swap SSD	12
4XB7A10156	B2X5	ThinkSystem 2.5" 5200 3.84TB Entry SATA 6Gb Hot Swap SSD	12
4XB7A10157	B2X6	ThinkSystem 2.5" 5200 7.68TB Entry SATA 6Gb Hot Swap SSD	12

Table 31. 2.5-inch U.2 NVMe SSDs

Part number	Feature	Description	Maximum supported
2.5-inch SSDs - NVMe - Enterprise Mainstream (3-5 DWPD)			
4XB7A08516	B21W	ThinkSystem U.2 Toshiba CM5-V 800GB Mainstream NVMe PCIe 3.0 x4 Hot Swap SSD	10*
4XB7A08517	B21X	ThinkSystem U.2 Toshiba CM5-V 1.6TB Mainstream NVMe PCIe 3.0 x4 Hot Swap SSD	10*
4XB7A08518	B21Y	ThinkSystem U.2 Toshiba CM5-V 3.2TB Mainstream NVMe PCIe 3.0 x4 Hot Swap SSD	10*
4XB7A08519	B2XJ	ThinkSystem U.2 Toshiba CM5-V 6.4TB Mainstream NVMe PCIe 3.0 x4 Hot Swap SSD	10*
2.5-inch SSDs - NVMe - Enterprise Entry (<3 DWPD)			
4XB7A10175	B34N	ThinkSystem U.2 PM983 1.92TB Entry NVMe PCIe 3.0 x4 Hot Swap SSD	16
4XB7A10176	B34P	ThinkSystem U.2 PM983 3.84TB Entry NVMe PCIe 3.0 x4 Hot Swap SSD	16

* Toshiba CM5-V drives are 15mm high drives and are only supported in the front drive bays due to thermal requirements

No hot-swap support: NVMe drives currently do not support hot-swap functionality. An update to UEFI firmware to fix this restriction is planned for 4Q/2019.

Table 32. 3.5-inch hot-swap 12 Gb SAS HDDs

Part number	Feature	Description	Maximum supported
3.5-inch hot-swap HDDs - 12 Gb SAS 15K			
7XB7A00039	AUU3	ThinkSystem 3.5" 600GB 15K SAS 12Gb Hot Swap 512n HDD	4
7XB7A00040	AUUC	ThinkSystem 3.5" 900GB 15K SAS 12Gb Hot Swap 512e HDD	4
3.5-inch hot-swap HDDs - 12 Gb NL SAS			
7XB7A00042	AUU5	ThinkSystem 3.5" 2TB 7.2K SAS 12Gb Hot Swap 512n HDD	4
7XB7A00043	AUU6	ThinkSystem 3.5" 4TB 7.2K SAS 12Gb Hot Swap 512n HDD	4
7XB7A00044	AUU7	ThinkSystem 3.5" 6TB 7.2K SAS 12Gb Hot Swap 512e HDD	4
7XB7A00046	AUUG	ThinkSystem 3.5" 10TB 7.2K SAS 12Gb Hot Swap 512e HDD	4
3.5-inch hot-swap SED HDDs - 12 Gb NL SAS			
7XB7A00047	AUUH	ThinkSystem 3.5" 4TB 7.2K SAS 12Gb Hot Swap 512n HDD FIPS	4

Table 33. 3.5-inch hot-swap 6 Gb SAS/SATA HDDs

Part number	Feature	Description	Maximum supported
3.5-inch hot-swap HDDs - 6 Gb NL SATA			
7XB7A00050	AUUD	ThinkSystem 3.5" 2TB 7.2K SATA 6Gb Hot Swap 512n HDD	4
7XB7A00051	AUU8	ThinkSystem 3.5" 4TB 7.2K SATA 6Gb Hot Swap 512n HDD	4
7XB7A00052	AUUA	ThinkSystem 3.5" 6TB 7.2K SATA 6Gb Hot Swap 512e HDD	4
7XB7A00054	AUUB	ThinkSystem 3.5" 10TB 7.2K SATA 6Gb Hot Swap 512e HDD	4

Table 34. 3.5-inch hot-swap 6 Gb SAS/SATA SSDs

Part number	Feature	Description	Maximum supported
3.5-inch hot-swap SSDs - 6 Gb SATA - Enterprise Mainstream (3-5 DWPD)			
4XB7A10243	B48E	ThinkSystem 3.5" 5200 480GB Mainstream SATA 6Gb Hot Swap SSD	4
4XB7A10244	B48F	ThinkSystem 3.5" 5200 960GB Mainstream SATA 6Gb Hot Swap SSD	4
3.5-inch hot-swap SSDs - 6 Gb SATA - Enterprise Entry (<3 DWPD)			
4XB7A10158	B2X7	ThinkSystem 3.5" 5200 480GB Entry SATA 6Gb Hot Swap SSD	4
4XB7A10159	B2X8	ThinkSystem 3.5" 5200 960GB Entry SATA 6Gb Hot Swap SSD	4
4XB7A10160	B2X9	ThinkSystem 3.5" 5200 1.92TB Entry SATA 6Gb Hot Swap SSD	4

Table 35. M.2 drives

Part number	Feature	Description	Maximum supported
M.2 SSDs - 6 Gb SATA - Enterprise Entry (<3 DWPD)			
7N47A00130	AUUV	ThinkSystem M.2 128GB SATA 6Gbps Non-Hot Swap SSD	2
7SD7A05703	B11V	ThinkSystem M.2 5100 480GB SATA 6Gbps Non-Hot Swap SSD	2
4XB7A14048	B5UP	ThinkSystem M.2 5100 960GB SATA 6Gbps Non-Hot Swap SSD	2

Internal backup units

The server does not support any internal backup units, such as tape drives or RDX drives. External backup units are available as described in the [External backup units](#) section.

Optical drives

The server does not support an internal optical drive. An external USB optical drive is available, listed in the following table.

Table 36. External optical drive

Part number	Feature code	Description
7XA7A05926	AVV8	ThinkSystem External USB DVD RW Optical Disk Drive

I/O expansion

The server supports a total of up to 4 PCIe 4.0 slots (3 with rear access, 1 internal for a RAID adapter or HBA) plus a dedicated OCP 3.0 SFF slot for networking. Slot availability is based on riser selection.

- Slot 1: PCIe 4.0 x16 LP or FHHL
- Slot 2: PCIe 4.0 x16 LP (not present if slot 1 is FHHL or rear drive bays are present)
- Slot 3: PCIe 4.0 x16 LP (not present if rear drive bays are present)
- Slot 4: PCIe 4.0 x8 LP (internal slot; physically a x16 slot)

The following figure shows the locations of the rear-accessible slots for each configuration selection. The OCP slot is located in the lower-left corner.

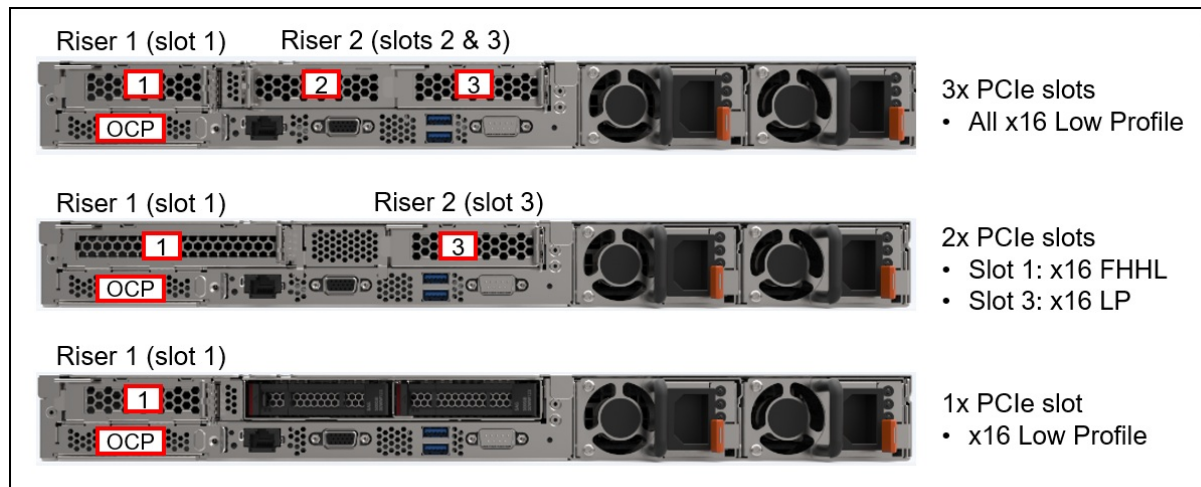

Figure 11. SR635 slots

The slots and riser cards are as follows:

- Riser 1: Slot 1 (PCIe x16)
 - Slot 1: Low Profile or FHHL, PCIe 4.0 x16 slot
- Riser 2: Slots 2 & 3 (each PCIe x16)
 - Slot 2: Low Profile, PCIe 4.0 x16 (only available in 3x LP slot configuration)
 - Slot 3: Low Profile, PCIe 4.0 x16 (not available in configurations with rear drive bays)
- Internal Riser: Slot 4 (PCIe x8)
 - Low Profile PCIe 4.0 x8 slot for internal drive controller (physically a x16 slot)

The riser cards and slot brackets used to provide the above slot combinations in configure-to-order (CTO) configurations are listed in the following table.

Tip: It is also possible to not have any slot selections, in which case slot fillers will be derived in the configurator. Slots can be added later as field upgrades using option part numbers.

Table 37. Riser slot selections - Feature codes for CTO

Feature code	Description	Maximum Supported	Purpose
Riser 1			
B5VV	ThinkSystem SR635/SR655 x16 PCIe Riser1	1	Riser for slot 1
B5WZ	ThinkSystem SR635 MS FH Riser BKT	1	FHHL slot bracket for slot 1
B5WD	ThinkSystem SR635 MS LP Riser BKT Slot1	1	Low Profile slot bracket for slot 1
Riser 2			
B5W0	ThinkSystem SR635/SR655 x16/x16 PCIe Riser2 (BF)	1	Riser for slots 2 & 3
B5X4	ThinkSystem SR635 MS LP+LP BF Riser BKT	1	Low Profile brackets for slots 2 & 3
B715	ThinkSystem SR635 MS LP Riser BKT Slot3	1	Low Profile bracket for slot 3
Internal			
B5VW	ThinkSystem SR635/SR655 x8 PCIe Internal Riser	1	Riser for Internal slot
B5WN	ThinkSystem SR635 Internal Riser BKT	1	Internal slot bracket

Slot configurations can also be ordered as field upgrades using option part numbers, as listed in the following figure.

Table 38. Field upgrades for PCIe slots

Part number	Description	Maximum Supported
4XH7A09835	ThinkSystem SR635/SR655 x16 PCIe 1U Riser 1 Kit <ul style="list-style-type: none"> • FHHL riser bracket for slot 1 • Low Profile riser bracket for slot 1 • PCIe 4.0 x16 riser for riser slot 1 	1
4XH7A09836	ThinkSystem SR635/SR655 x16/x16 PCIe Riser2 LP Kit <ul style="list-style-type: none"> • LP "butterfly" riser bracket for slots 2 & 3 • PCIe 4.0 x16 riser for riser slot 2 	1
4XH7A09843	ThinkSystem SR635/SR655 x8 PCIe Internal Riser Kit <ul style="list-style-type: none"> • Low profile riser bracket for internal slot • PCIe 4.0 x8 riser for internal slot • 2x supercap brackets 	1

Network adapters

The server has a dedicated OCP 3.0 SFF slot with PCIe 4.0 x16 host interface. See [Figure 3](#) for the location of the OCP slot.

The following table lists the supported OCP adapters. One port can optionally be shared with the ASPEED management processor for Wake-on-LAN and NC-SI support. Only 1 OCP card can be installed in the server.

Table 39. Supported OCP adapters

Part number	Feature code	Description
Gigabit		
4XC7A08235	B5T1	ThinkSystem Broadcom 5719 1GbE RJ45 4-port OCP Ethernet Adapter
10 GbE		
4XC7A08236*	B5ST*	ThinkSystem Broadcom 57416 10GBASE-T 2-port OCP Ethernet Adapter
25 GbE		
4XC7A08237	B5SZ	ThinkSystem Broadcom 57414 10/25GbE SFP28 2-port OCP Ethernet Adapter
4XC7A08242*	B5SV*	ThinkSystem Broadcom 57454 10/25GbE SFP28 4-port OCP Ethernet Adapter
4XC7A08246	B5T2	ThinkSystem Mellanox ConnectX-4 Lx 10/25GbE SFP28 2-port OCP Ethernet Adapter
4XC7A08264	B5SW	ThinkSystem Marvell QL41232 10/25GbE SFP28 2-Port OCP Ethernet Adapter

* Planned for September 2019

For more information, including the transceivers and cables that each adapter supports, see the list of Lenovo Press Product Guides in the Networking adapters category:

<https://lenovopress.com/servers/options/ethernet>

The following table lists additional supported network adapters that can be installed in the regular PCIe slots.

Table 40. Supported PCIe Network Adapters

Part number	Feature code	Description	Slots supported	Maximum supported
Gigabit Ethernet				
7ZT7A00484	AUZV	ThinkSystem Broadcom 5719 1GbE RJ45 4-Port PCIe Ethernet Adapter	1, 3, 2	3
7ZT7A00482	AUZX	ThinkSystem Broadcom 5720 1GbE RJ45 2-Port PCIe Ethernet Adapter	1, 3, 2	3
7ZT7A00533*	AUZZ*	ThinkSystem I350-F1 PCIe 1Gb 1-Port SFP Ethernet Adapter	1, 3, 2	3
7ZT7A00534*	AUZY*	ThinkSystem I350-T2 PCIe 1Gb 2-Port RJ45 Ethernet Adapter	1, 3, 2	3
7ZT7A00535*	AUZW*	ThinkSystem I350-T4 PCIe 1Gb 4-Port RJ45 Ethernet Adapter	1, 3, 2	3
10 GbE				
00MM860	ATPX	Intel X550-T2 Dual Port 10GBase-T Adapter	1, 3, 2	3
7ZT7A00537*	AUKX*	ThinkSystem Intel X710-DA2 PCIe 10Gb 2-Port SFP+ Ethernet Adapter	1, 3, 2	3
25 GbE				
4XC7A08238	B5T0	ThinkSystem Broadcom 57414 10/25GbE SFP28 2-port PCIe Ethernet Adapter	1, 3, 2	3
4XC7A08270	B652	ThinkSystem Marvell QL41232 10/25GbE SFP28 2-Port PCIe Ethernet Adapter	1, 3, 2	3
4XC7A08249	B653	ThinkSystem Mellanox ConnectX-4 Lx 10/25GbE SFP28 2-port PCIe Ethernet Adapter	1, 3, 2	3

* Planned for September 2019

For more information, including the transceivers and cables that each adapter supports, see the list of Lenovo Press Product Guides in the Networking adapters category:
<https://lenovopress.com/servers/options/ethernet>

Fibre Channel host bus adapters

The following table lists the Fibre Channel HBAs supported by the SR635.

Table 41. Fibre Channel HBAs

Part number	Feature code	Description	Slots supported	Maximum supported
32 Gb Fibre Channel HBAs				
4XC7A08250	B5SX	ThinkSystem Emulex LPe35000 32Gb 1-port PCIe Fibre Channel Adapter	1, 3, 2	3
4XC7A08251	B5SY	ThinkSystem Emulex LPe35002 32Gb 2-port PCIe Fibre Channel Adapter	1, 3, 2	3
7ZT7A00516	AUNS	ThinkSystem QLogic QLE2740 PCIe 32Gb 1-Port SFP+ Fibre Channel Adapter	1, 3, 2	3
7ZT7A00518	AUNU	ThinkSystem QLogic QLE2742 PCIe 32Gb 2-Port SFP+ Fibre Channel Adapter	1, 3, 2	3
16 Gb Fibre Channel HBAs				
01CV840	ATZV	Emulex 16Gb Gen6 FC Dual-port HBA	1, 3, 2	3
01CV830	ATZU	Emulex 16Gb Gen6 FC Single-port HBA	1, 3, 2	3
01CV760	ATZC	QLogic 16Gb Enhanced Gen5 FC Dual-port HBA	1, 3, 2	3
01CV750	ATZB	QLogic 16Gb Enhanced Gen5 FC Single-port HBA	1, 3, 2	3

For more information, see the list of Lenovo Press Product Guides in the Host bus adapters category:
<https://lenovopress.com/servers/options/hba>

SAS adapters for external storage

The following table lists SAS HBAs and RAID adapters supported by SR635 server for use with external storage.

Table 42. Adapters for external storage

Part number	Feature code	Description	Slots supported	Maximum supported
SAS HBAs				
7Y37A01090	AUNR	ThinkSystem 430-8e SAS/SATA 12Gb HBA	1, 3, 2	3
7Y37A01091	AUNN	ThinkSystem 430-16e SAS/SATA 12Gb HBA	1, 3, 2	3
External RAID adapters				
7Y37A01087	AUNQ	ThinkSystem RAID 930-8e 4GB Flash PCIe 12Gb Adapter	1, 3, 2	3*

* See configuration rules below

Configuration rules

The RAID 930-8e uses a flash power module (supercap), which can be installed in one of 3 locations as shown in the following figure.

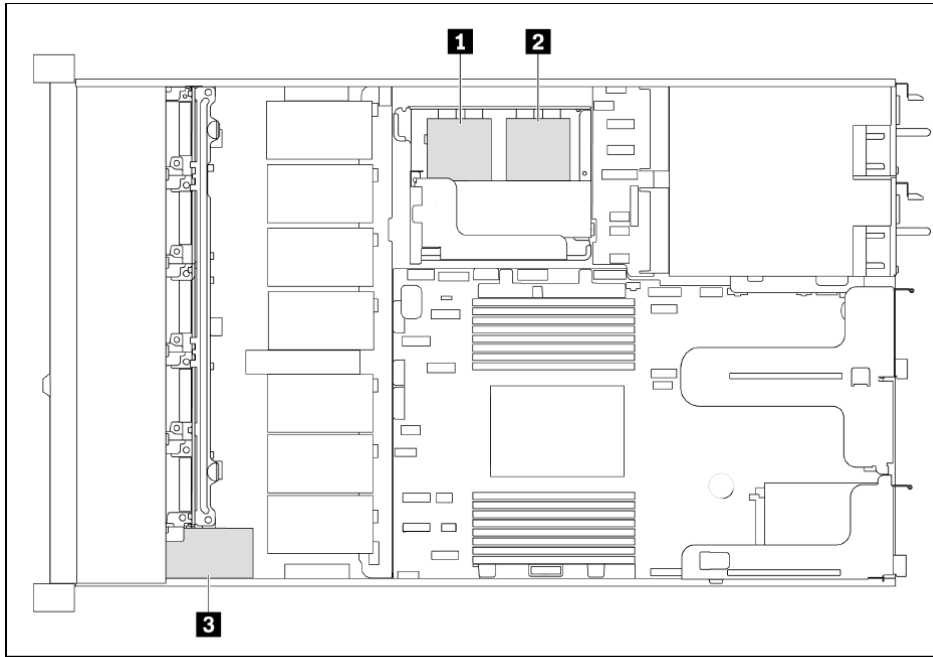

Figure 12. Location of all three supercaps in the SR635 (2.5-inch drive configuration)

The number of supercap locations is reduced depending on installed components:

- For configurations with 2.5-inch front drives and no mid drive cage, 3x 930-8e adapters and supercaps can be installed (locations 1, 2, and 3).
- For configurations with 2.5-inch front drives and a mid drive cage installed, 1x 930-8e adapter and supercap can be installed (location 3 only).
- For configurations with 3.5-inch front drives, and no mid drive cage, 2x 930-8e adapters and supercaps can be installed (location 1 and 2; location 3 is not present).
- For configurations with 3.5-inch front drives and a mid drive cage installed, no 930-8e adapters and supercaps can be installed.
- If any internal RAID adapters with flash power modules are installed, the maximum number of 930-8e adapters supported is further reduced by that number.

For more information, see the list of Lenovo Press Product Guides in the Host bus adapters and RAID adapters categories:

<https://lenovopress.com/servers/options/hba>

<https://lenovopress.com/servers/options/raid>

The following table compares the specifications of the external SAS HBAs and RAID adapters.

Table 43. Comparison of external storage adapters

Feature	430-8e	430-16e	930-8e
Adapter type	HBA	HBA	External RAID
Part number	7Y37A01090	7Y37A01091	7Y37A01087
Controller chip	LSI SAS3408	LSI SAS3416	LSI SAS3516
Broadcom equivalent	HBA 9400-8e	HBA 9400-16e	MegaRAID 9480-8e
Host interface	PCIe 3.0x8	PCIe 3.0x8	PCIe 3.0x8
Port interface	12 Gb SAS	12 Gb SAS	12 Gb SAS
Number of ports	8	16	8
Port connectors	2x Mini-SAS HD SFF8644	4x Mini-SAS HD SFF8644	2x Mini-SAS HD SFF8644
Drive interface	SAS/SATA	SAS/SATA	SAS,SATA
Drive type	HDD/SSD/SED*	HDD/SSD/SED*	HDD,SED,SSD
Hot-swap drives	Yes	Yes	Yes
Maximum devices	512 (planned: 1024)	512 (planned: 1024)	64 (planned: 216)
RAID levels	None	None	0/1/10/5/50/6/60
JBOD mode	Yes	Yes	Yes
Cache	None	None	4GB (Standard)
CacheVault cache protection	None	None	Yes (Flash)
Performance Accelerator (FastPath)	No	No	Yes
SSD Caching (CacheCade Pro 2.0)	No	No	No
SED support*	Yes	Yes	Yes

* SAS HBAs support SEDs (self-encrypting drives) by using software on the server and simply passing SED commands through the HBA to the drives. SED support by RAID controllers is provided using the built-in MegaRAID SafeStore functionality of the adapter.

Flash storage adapters

The SR635 supports the PCIe Flash Storage adapters listed in the following table.

Table 44. Flash Storage Adapters

Part number	Feature code	Description	Slots supported	Maximum supported
Mainstream NVMe PCIe Adapters - Optimized for mixed-intensive application workloads with an endurance of 3-5 DWPD.				
4XB7A08520	B32L	ThinkSystem HHHL Toshiba CM5-V 1.6TB Mainstream NVMe PCIe 3.0 x4 Flash Adapter	1, 3, 2	3
4XB7A08521	B32M	ThinkSystem HHHL Toshiba CM5-V 3.2TB Mainstream NVMe PCIe 3.0 x4 Flash Adapter	1, 3, 2	3

For details about these adapters, see the Lenovo Press product guides in the Flash Adapters category: <https://lenovopress.com/servers/options/ssdadapter>

Configuration rules

The following configuration requirements must be met when installing flash storage adapters:

- GPU adapters are not supported
- Maximum processor TDP is 155W
- Performance fans are required and will be derived by the configurator for configure-to-order builds.
- When adding Flash adapters as field upgrades, you will be required to replace all standard fans with performance fan modules. The ordering part number is listed in the following table - you will be required to order 7 fans.

Table 45. Performance fan ordering information

Part number	Feature code	Description	Quantity required
4F17A14483	B5X0	ThinkSystem SR635 Performance Fan Module	7

GPU adapters

The SR635 supports the following graphics processing units (GPUs).

Table 46. Supported GPUs

Part number	Feature code	Description	Slots supported	Maximum supported
4X67A14926	B4YB	ThinkSystem NVIDIA Tesla T4 16GB PCIe Passive GPU	1, 3, 2	3*

* See configuration rules below

For information about these GPUs, see the ThinkSystem GPU Summary, available at: <https://lenovopress.com/lp0768-thinksystem-thinkagile-gpu-summary>

Configuration rules

The following configuration requirements must be met when installing GPUs:

- All GPUs installed must be identical
- Rear drive bays and mid-chassis drive bays are not supported.
- With two GPUs installed, processor TDP greater than 200W not supported
 - If ambient temperature is 35°C, then processor TDP greater than 120W not supported
 - If ambient temperature is 30°C, then processor TDP greater than 200W not supported
- With three GPUs installed, processor TDP greater than 120W not supported
- The following additional drive backplane rules apply if 3 GPUs are installed (rules do not apply if only 2 GPUs installed):
 - 3.5-inch drive bay backplane (AUW8) is fully supported
 - 8x 2.5-inch drive backplane (B7K3) supported, however 2 drive bays (6, 7) must be empty
 - 6x 2.5-inch SAS/SATA + 4x AnyBay backplane (AUW9) supported, however all AnyBay bays (6, 7, 8, 9) must be empty
 - 10x 2.5-inch AnyBay backplane (B5VS), however 4 bays (6, 7, 8, 9) must be empty
 - Ambient temperature great than 30°C is not supported
 - Processor TDP greater than 120W not supported
- Flash storage adapters are not supported.
- 1100W power supplies (or in some configurations, 750W power supplies) are required.

GPU field upgrades

When ordering GPUs as part of a CTO configuration, the necessary cooling features are automatically selected as part of the order. However when ordering the GPUs as field upgrades, you will need to also order 7 performance fans which will replace the standard fans already installed. Seven part numbers will need to be ordered per server.

Table 47. Performance fan ordering information

Part number	Feature code	Description	Quantity required
4F17A14483	B5X0	ThinkSystem SR635 Performance Fan Module	7

Cooling

The SR635 server has seven 40 mm dual-rotor hot-swap fans and either 6 or 7 fans are standard depending on the configuration. The server offers N+1 redundancy. The server also has one additional fan integrated in each of the two power supplies.

Under all of the following conditions, only 6 fans are required:

- No M.2 Module
- No internal riser slot
- No mid drive bays
- No rear drives
- No GPUs

For all other configurations, all 7 fans are required.

Table 48. Fan ordering information

Part number	Feature code	Description	Maximum supported
4F17A12358	B5X1	ThinkSystem SR635 1U Fan Module	7
4F17A14483	B5X0	ThinkSystem SR635 Performance Fan Module	7

Some configurations, such as the use of high-TDP processors, GPUs, flash storage adapters, mid drive or rear drives, will require the use of high performance fans which have higher RPMs. For configure-to-order builds, the DCSC configurator will automatically select the required fans. For field upgrades, the option part numbers include the upgraded fans when they are needed.

See these sections for details:

- [Drive bay upgrade kits](#)
- [GPU upgrade kits](#)
- [Flash storage adapters](#)

Power supplies

The server supports up to two redundant hot-swap power supplies.

The power supply choices are listed in the following table. Both power supplies used in server must be identical.

Tip: Use Lenovo Capacity Planner to determine exactly what power your server needs:
<https://datacentersupport.lenovo.com/us/en/solutions/invo-lcp>

Table 49. Power supply options

Part number	Feature code	Description	Maximum supported	110V AC	220V AC	240V DC China only
7N67A00882	AVWC	ThinkSystem 550W(230V/115V) Platinum Hot-Swap Power Supply	2	Yes	Yes	Yes
7N67A00883	AVWD	ThinkSystem 750W(230/115V) Platinum Hot-Swap Power Supply	2	Yes	Yes	Yes
7N67A00884	AVW9	ThinkSystem 750W (230V) Titanium Hot-Swap Power Supply	2	No	Yes	Yes
7N67A00885	AVWF	ThinkSystem 1100W (230V/115V) Platinum Hot-Swap Power Supply	2	Yes	Yes	Yes

Dual-voltage power supplies are auto-sensing and support both 110V AC (100-127V 50/60 Hz) and 220V AC (200-240V 50/60 Hz) power. For China customers, all power supplies support 240V DC.

Power supply options do not include a line cord.

For server configurations, the inclusion of a power cord is model dependent. Configure-to-order models can be configured without a power cord if desired.

Power cords

Line cords and rack power cables can be ordered as listed in the following table.

110V customers: If you plan to use the ThinkSystem 1100W power supply with a 110V power source, select a power cable that is rated above 10A. Power cables that are rated at 10A or below are not supported with 110V power.

Table 50. Power cords

Part number	Feature code	Description
Rack cables		
00Y3043	A4VP	1.0m, 10A/100-250V, C13 to C14 Jumper Cord
39Y7937	6201	1.5m, 10A/100-250V, C13 to C14 Jumper Cord
4L67A08369	6570	2.0m, 13A/100-250V, C13 to C14 Jumper Cord
4L67A08366	6311	2.8m, 10A/100-250V, C13 to C14 Jumper Cord
4L67A08370	6400	2.8m, 13A/100-250V, C13 to C14 Jumper Cord
39Y7932	6263	4.3m, 10A/100-250V, C13 to C14 Jumper Cord
4L67A08371	6583	4.3m, 13A/100-250V, C13 to C14 Jumper Cord
Line cords		
39Y7930	6222	2.8m, 10A/250V, C13 to IRAM 2073 (Argentina) Line Cord
81Y2384	6492	4.3m, 10A/250V, C13 to IRAM 2073 (Argentina) Line Cord
39Y7924	6211	2.8m, 10A/250V, C13 to AS/NZS 3112 (Australia/NZ) Line Cord
81Y2383	6574	4.3m, 10A/250V, C13 to AS/NZS 3112 (Australia/NZ) Line Cord
69Y1988	6532	2.8m, 10A/250V, C13 to NBR 14136 (Brazil) Line Cord
81Y2387	6404	4.3m, 10A/250V, C13 to NBR 14136 (Brazil) Line Cord
39Y7928	6210	2.8m, 10A/220V, C13 to GB 2099.1 (China) Line Cord
81Y2378	6580	4.3m, 10A/250V, C13 to GB 2099.1 (China) Line Cord
39Y7918	6213	2.8m, 10A/250V, C13 to DK2-5a (Denmark) Line Cord
81Y2382	6575	4.3m, 10A/250V, C13 to DK2-5a (Denmark) Line Cord
39Y7917	6212	2.8m, 10A/250V, C13 to CEE 7/7 (Europe) Line Cord
81Y2376	6572	4.3m, 10A/250V, C13 to CEE 7/7 (Europe) Line Cord
39Y7927	6269	2.8m, 10A/250V, C13 to IS 6538 (India) Line Cord
81Y2386	6567	4.3m, 10A/250V, C13 to IS 6538 (India) Line Cord
39Y7920	6218	2.8m, 10A/250V, C13 to SI 32 (Israel) Line Cord
81Y2381	6579	4.3m, 10A/250V, C13 to SI 32 (Israel) Line Cord
39Y7921	6217	2.8m, 10A/250V, C13 to CEI 23-16 (Italy) Line Cord
81Y2380	6493	4.3m, 10A/250V, C13 to CEI 23-16 (Italy) Line Cord
4L67A08362	6495	4.3m, 12A/200V, C13 to JIS C-8303 (Japan) Line Cord
39Y7922	6214	2.8m, 10A/250V, C13 to SABS 164-1 (South Africa) Line Cord

Part number	Feature code	Description
81Y2379	6576	4.3m, 10A/250V, C13 to SANS 164-1 (South Africa) Line Cord
39Y7926	6335	4.3m, 12A/100V, C13 to JIS C-8303 (Japan) Line Cord
39Y7925	6219	2.8m, 12A/220V, C13 to KSC 8305 (S. Korea) Line Cord
81Y2385	6494	4.3m, 12A/250V, C13 to KSC 8305 (S. Korea) Line Cord
39Y7919	6216	2.8m, 10A/250V, C13 to SEV 1011-S24507 (Swiss) Line Cord
81Y2390	6578	4.3m, 10A/250V, C13 to SEV 1011-S24507 (Swiss) Line Cord
23R7158	6386	2.8m, 10A/125V, C13 to CNS 10917 (Taiwan) Line Cord
81Y2375	6317	2.8m, 10A/250V, C13 to CNS 10917 (Taiwan) Line Cord
81Y2374	6402	2.8m, 13A/125V, C13 to CNS 10917 (Taiwan) Line Cord
4L67A08363	AX8B	4.3m, 10A/125V, C13 to CNS 10917 (Taiwan) Line Cord
81Y2389	6531	4.3m, 10A/250V, C13 to CNS 10917 (Taiwan) Line Cord
81Y2388	6530	4.3m, 13A/125V, C13 to CNS 10917 (Taiwan) Line Cord
39Y7923	6215	2.8m, 10A/250V, C13 to BS 1363/A (UK) Line Cord
81Y2377	6577	4.3m, 10A/250V, C13 to BS 1363/A (UK) Line Cord
90Y3016	6313	2.8M, 10A/125V, C13 to NEMA 5-15P (US) Line Cord
46M2592	A1RF	2.8m, 10A/250V, C13 to NEMA 6-15P (US) Line Cord
00WH545	6401	2.8M, 13A/125V, C13 to NEMA 5-15P (US) Line Cord
4L67A08359	6370	4.3m, 10A/125V, C13 to NEMA 5-15P (US) Line Cord
4L67A08361	6373	4.3m, 10A/250V, C13 to NEMA 6-15P (US) Line Cord
4L67A08360	AX8A	4.3m, 13A/125V, C13 to NEMA 5-15P (US) Line Cord

Integrated virtualization

The server supports booting from an operating system or hypervisor installed on an M.2 solid-state drive. See the [M.2 drives section](#) for details and the list of available options.

You can download supported VMware vSphere hypervisor images from the following web page and load it on the M.2 drive using the instructions provided:
https://vmware.lenovo.com/content/custom_iso/

Systems management

The server contains an integrated service processor which provides advanced control, monitoring, and alerting functions. The service processor is based on the ASPEED AST2500 baseboard management controller (BMC).

Local management

The SR635 offers a front operator panel with key LED status indicators, as shown in the following figure.

Tip: The Network LED only shows network activity of the installed OCP network adapter.

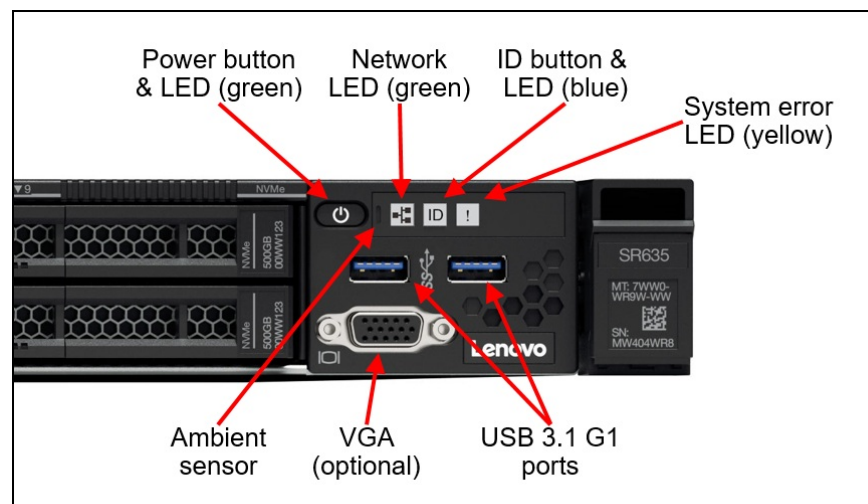

Figure 13. Front operator panel

The server offers light path diagnostics. If an environmental condition exceeds a threshold or if a system component fails, the ASPEED service processor lights LEDs inside the server to help you diagnose the problem and find the failing part. The SR635 has fault LEDs next to the following components:

- Each memory DIMM
- Each drive bay
- Each system fan
- Each power supply

The front of the server also houses an information pull-out tab (also known as the network access tag). See [Figure 2](#) for the location. A label on the tab shows the network information (MAC address and other data) to remotely access the service processor.

Remote management

Remote server management is provided through industry-standard interfaces:

- Intelligent Platform Management Interface (IPMI) Version 2.0
- Simple Network Management Protocol (SNMP) Version 3 (traps and gets)
- Redfish support to the Redfish Schema 2018.1 (DMTF DSP0266 1.5.0 compliant)
- Web browser - HTML 5-based browser interface (Java and ActiveX not required) using a responsive design (content optimized for the device being used - laptop, tablet, phone) with NLS support

Remote connectivity is provided by a dedicated 1Gb Ethernet management port (see the locations of ports at the rear of the server in the [Components and connectors](#) section). Remote management can also be performed via the first port of the installed OCP adapter using the shared management capability of the adapter via NC-SI. NC-SI connectivity is 10/100 Mbps Ethernet.

A virtual presence (iKVM remote control and virtual media) capability also comes standard in the server for remote server management.

The remote control functions include the following:

- Remotely viewing video with graphics resolutions up to 1920x1080 at 60 Hz and 32 bits per pixel, regardless of the system state
- Remotely accessing the server using the keyboard and mouse from a remote client
- Full remote administration with seamless access from UEFI POST through to operating system load
- OS independent - no drivers or OS agents required
- Support for up to four remote users simultaneously

The remote media functions include:

- USB 2.0 compliant connectivity
- Up to four simultaneously mounted diskette, HDD, CD, DVD, USB flash drive, or image files
- Optional encryption on connections
- Requires Java Runtime Environment (JRE) 1.4.2 or later
- Can be used as a boot device
- Persistent session across system reset (but not across AC power loss)

Lenovo XClarity Administrator

Lenovo XClarity Administrator is a centralized resource management solution designed to reduce complexity, speed response, and enhance the availability of Lenovo systems and solutions.

Lenovo XClarity Administrator provides agent-free hardware management for ThinkSystem servers, in addition to other Lenovo servers. The administration dashboard is based on HTML 5 and allows fast location of resources so tasks can be run quickly.

Lenovo XClarity Administrator supports only a subset of functions with the SR635:

- Discovery
- Inventory
- Monitoring & alerting
- Call home

Functions that are not supported are:

- Centralized user management
- Cryptography modes, server certificates, and encapsulation
- Configuration patterns
- Operating system deployment
- Firmware updates

For more information about Lenovo XClarity Administrator, including ordering part numbers, see the Lenovo XClarity Administrator Product Guide: <https://lenovopress.com/tips1200-lenovo-xclarity-administrator>

Lenovo XClarity Provisioning Manager Lite

Lenovo XClarity Provisioning Manager Lite (LXPM Lite) v2 is an embedded application for system setup and firmware upgrades. The tool is accessed during system boot by pressing F11 when prompted.

The software tool provides the following functions:

- Easy-to-use, language-selectable graphical interface
- Integrated help system
- Automatic hardware detection
- Ability to install an operating system and device drivers either in an unattended mode or manually
- Ability to clone the settings in one server to other similarly configured Lenovo servers
- Supports RAID setup
- Diagnostics for memory test, hard disk drive test, and RAID log collection.

The LXPM Lite user interface is shown in the following figure.

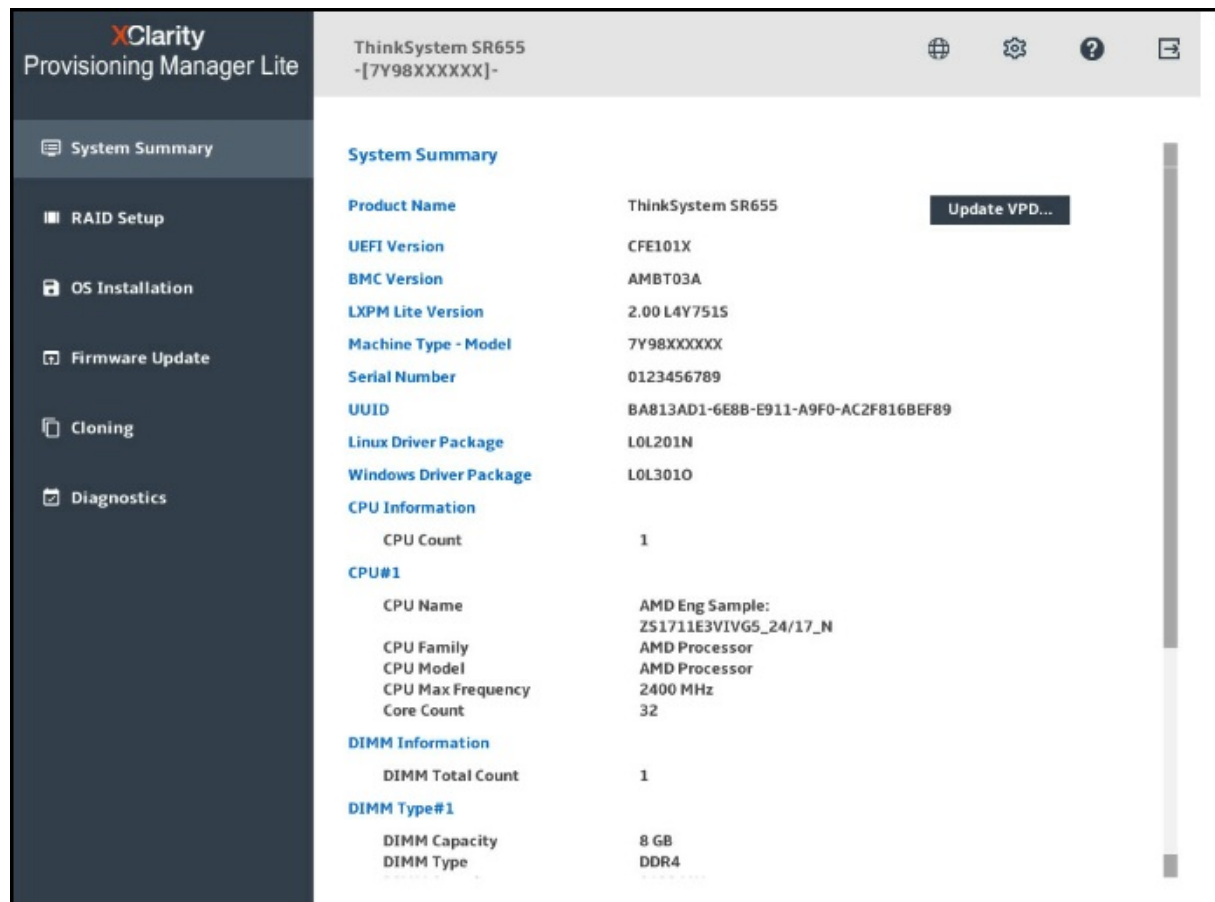

Figure 14. Lenovo XClarity Provisioning Manager Lite user interface (pre-production server)

For more information about LXPM Lite, see the following support page:

<https://datacentersupport.lenovo.com/us/en/solutions/HT507133>

Lenovo XClarity Essentials

Lenovo offers the following XClarity Essentials software tools that can help you set up, use, and maintain the server at no additional cost:

- Lenovo Essentials OneCLI

OneCLI is a collection of server management tools that uses a command line interface program to collect full system health information (including health status).

Note: OneCLI on the SR635 is limited to inventory and log collection functions only. Functions such as configuring system settings, and updating system firmware and drivers are not supported.

- Lenovo Essentials Bootable Media Creator

The Bootable Media Creator (BoMC) tool is used to create bootable media for offline firmware update.

Note: UpdateXpress is not supported on the SR635.

For more information and downloads, visit the Lenovo XClarity Essentials web page:

<http://support.lenovo.com/us/en/documents/LNVO-center>

Lenovo XClarity Energy Manager

Lenovo XClarity Energy Manager provides a stand-alone, web-based agent-less power management console that provides real time data and enables you to observe, plan and manage power and cooling for Lenovo servers. Using built-in intelligence, it identifies server power consumption trends and ideal power settings and performs cooling analysis so that you can define and optimize power-saving policies.

Lenovo XClarity Energy Manager offers the following capabilities:

- Monitors room, row, rack, and device levels in the data center
- Reports vital server information, such as power, temperature and resource utilization
- Monitors inlet temperature to locate hot spots, reducing the risk of data or device damage
- Provides finely-grained controls to limit platform power in compliance with IT policy
- Generates alerts when a user-defined threshold is reached

Note: In the SR635, system power capping function is not supported on Lenovo XClarity Energy Manager.

Lenovo XClarity Energy Manager is an optional software component that is licensed on a per managed node basis, that is, each managed server requires a license. To manage systems, a node license pack should be purchased. The following table lists the geo-specific Lenovo XClarity Energy Manager software license options.

Table 51. Lenovo XClarity Energy Manager software options

Description	Part number (NA, AP, Japan)*	Part number (EMEA, LA)**	Quantity
Lenovo XClarity Energy Manager, 1 Node w/ 1 Yr S&S	01DA225	01DA228	1

For more information, refer to the Lenovo XClarity Energy Manager web page:

<http://datacentersupport.lenovo.com/us/en/solutions/Invo-lxem>

Lenovo Capacity Planner is a power consumption evaluation tool that enhances data center planning by enabling IT administrators and pre-sales professionals to understand various power characteristics of racks, servers, and other devices. Capacity Planner can dynamically calculate the power consumption, current, British Thermal Unit (BTU), and volt-ampere (VA) rating at the rack level, improving the planning efficiency for large scale deployments.

For more information, refer to the Capacity Planner web page:

<http://datacentersupport.lenovo.com/us/en/solutions/Invo-lcp>

Security

The SR635 server offers the following security features:

- Administrator and power-on password
- Integrated Trusted Platform Module (TPM) supporting TPM 2.0
- Optional Nationz TPM 2.0, available only in China
- Optional lockable front security bezel
- Planned support for a chassis intrusion switch

The optional lockable front security bezel is shown in the following figure and includes a key that enables you to secure the bezel over the drives and system controls thereby reducing the chance of unauthorized or accidental access to the server.

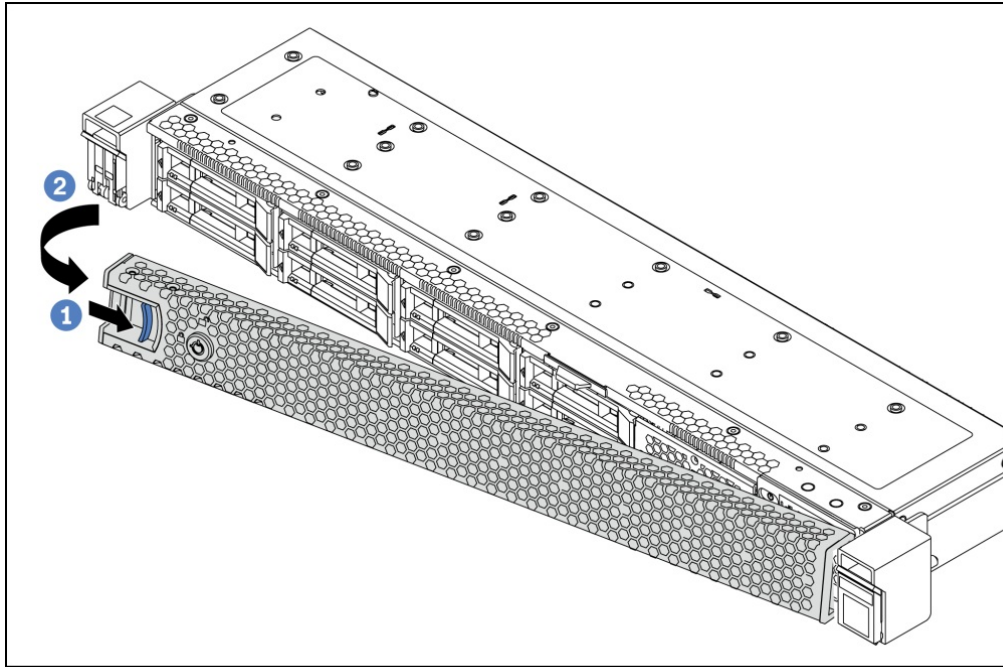

Figure 15. Lockable front security bezel

The dimensions of the security bezel are:

- Width: 437 mm (17.2 in.)
- Height: 43 mm (1.3 in.)
- Width: 23 mm (0.9 in.)

The following table lists the security options for the SR635.

Table 52. Security features

Part number	Feature code	Description
None*	B22N	ThinkSystem Nationz Trusted Platform Module v2.0 (China customers only)
7Z17A02581	AUWR	ThinkSystem 1U Security Bezel

* Not available as a field upgrade. The component is CTO or pre-configured models only.

Rack installation

The following table lists the rack installation options that are available for the server.

The VGA Upgrade Kit allows you to upgrade your server by adding a VGA video port to the front of the server (if the server does not already come with a front VGA port). When the front VGA is in use, the rear VGA port is automatically disabled.

Table 53. Rack installation options

Option	Feature Code	Description
Optional front VGA port		
4XH7A09849	AUWU or B5TX*	ThinkSystem SR635 Front VGA Upgrade Kit (adds a VGA port to the front of the server)
4-post rail slides		
4M17A13564	B42B	ThinkSystem Toolless Friction Rail v2
7M27A05702	AXCA	ThinkSystem Toolless Slide Rail
7M27A05701	AXCB	ThinkSystem Toolless Slide Rail Kit with 1U CMA

* B5TX is a 950mm cable for configurations with 3.5-inch drive bays in the front of the server; AUWU is a 715mm cable for configurations with 2.5-inch drive bays in the front of the server. The option part number contains both cables.

The following table summarizes the rail kit features and specifications.

Table 54. Rail kit features and specifications summary

Feature	ThinkSystem Toolless Slide Rail	ThinkSystem Toolless Friction Rail v2
Part number	7M27A05702 (no CMA) 7M27A05701 (with CMA)	4M17A13564
Rail type	Full-out slide (ball bearing)	Half-out slide (friction)
Toolless installation	Yes	Yes
Cable Management Arm (CMA) support	Yes (7M27A05701 only)	No
In-rack server maintenance	Yes	No
1U PDU support	Yes	Yes
0U PDU support	Limited*	Limited**
Rack type	Lenovo and IBM 4-post, IEC standard-compliant	Lenovo and IBM 4-post, IEC standard-compliant
Mounting holes	Square or round	Square or round
Mounting flange thickness	2 mm - 3.3 mm (0.08 - 0.13 in.)	2 mm - 3.3 mm (0.08 - 0.13 in.)
Distance between front and rear mounting flanges	610 mm - 864 mm (24 - 34 in.)	610 mm - 864 mm (24 - 34 in.)
Rail length***	730 mm (28.74 in.)	751 mm (29.6 in.)

* For 0U PDU support, the rack must be at least 1100 mm (43.31 in.) deep without a CMA, or at least 1200 mm (47.24 in.) deep if a CMA is used.

** For 0U PDU support with the friction rail kit, the rack must be at least 1000 mm (39.37 in.) deep.

*** Measured when mounted on the rack, from the front surface of the front mounting flange to the rear most point of the rail.

Rack shipment: The following restriction applies when shipping the SR635 in a rack:

- No 2.5-inch rear drive bays

Operating system support

The server supports the following operating systems:

- Microsoft Windows Server 2016
- Microsoft Windows Server 2019
- Red Hat Enterprise Linux 7.6
- Red Hat Enterprise Linux 8.0
- SUSE Linux Enterprise Server 12 SP4
- SUSE Linux Enterprise Server 12 SP4 with Xen
- SUSE Linux Enterprise Server 15 SP1
- SUSE Linux Enterprise Server 15 SP1 with Xen
- VMware vSphere Hypervisor (ESXi) 6.5 U3 + EP15
- VMware vSphere Hypervisor (ESXi) 6.7 U3

For a complete list of supported, certified and tested operating systems, plus additional details and links to relevant web sites, see the Operating System Interoperability Guide: <https://lenovopress.com/osig>

For configure-to-order configurations, the server can be preloaded with VMware ESXi installed on M.2 cards. Ordering information is listed in the following table.

Table 55. VMware ESXi preload

Part number	Feature code	Description
CTO only	B6U0	VMware ESXi 6.5 U3 (factory installed)
CTO only	B88T	VMware ESXi 6.7 U3 (factory installed)

Physical and electrical specifications

Dimensions and weight:

- Height: 43 mm (1.3 in.)
- Width: 434 mm (17.1 in.)
- Depth: 778 mm (30.6 in.)
- Maximum weight: 19.2 kg (42.3 lb)

Electrical specifications:

- Electrical - Input voltage
 - 100 - 127 (nominal) V AC, 50 Hz or 60 Hz
 - 200 - 240 (nominal) V AC, 50 Hz or 60 Hz
 - 180 - 300 V DC (China only)
- Inlet current:
 - 100-127 V:
 - 550W power supply: 6.2 A
 - 750W power supply: 8.4 A
 - 1100W power supply: 12 A
 - 200-240 V:
 - 550W power supply: 3.0 A
 - 750W power supply: 4.1 A
 - 1100W power supply: 6 A

Operating environment

The ThinkSystem SR635 server complies with ASHRAE Class A2 specifications with most configurations, and depending on the hardware configuration, also complies with ASHRAE Class A3 and Class A4 specifications. System performance may be impacted when operating temperature is outside ASHRAE A2 specification.

The restrictions to ASHRAE A2 support are as follows:

- Two GPUs and a processor with a TDP greater than 120W requires the ambient temperature be no more than 30°C
- Three GPUs requires the ambient temperature be no more than 30°C
- Mid drive bays requires the ambient temperature be no more than 30°C
- Rear drive bays requires the ambient temperature be no more than 30°C

To comply with ASHRAE class A3 and class A4 specifications, the server models must meet the following hardware configuration requirements:

- Processor TDP greater than 155W not supported
- No support for 10x 2.5" front drive bays (the 4x 3.5-inch and 8x 2.5-inch bay configurations are supported)
- No support for NVMe drives
- No support for rear drive bays or mid drive bays
- No support for GPUs
- No support for M.2
- No support for PCIe flash storage adapters
- No support for OCP networking adapters
- Advanced heatsink (feature B5UR) and performance fans (feature B5X0) must be configured

The server is supported in the following environment:

- Air temperature:
 - Operating:
 - ASHRAE Class A2: 10°C to 35°C (50°F to 95°F); the maximum ambient temperature decreases by 1°C for every 300 m (984 ft) increase in altitude above 900 m (2,953 ft).
 - ASHRAE Class A3: 5°C to 40°C (41°F to 104°F); the maximum ambient temperature decreases by 1°C for every 175 m (574 ft) increase in altitude above 900 m (2,953 ft).
 - ASHRAE Class A4: 5°C to 45°C (41°F to 113°F); the maximum ambient temperature decreases by 1°C for every 125 m (410 ft) increase in altitude above 900 m (2,953 ft).
 - Server off: 5°C to 45°C (41°F to 113°F)
 - Shipment/storage: -40°C to 60°C (-40°F to 140°F)
- Maximum altitude: 3,050 m (10,000 ft)
- Relative Humidity (non-condensing):
 - Operating
 - ASHRAE Class A2: 8% to 80%; maximum dew point: 21°C (70°F)
 - ASHRAE Class A3: 8% to 85%; maximum dew point: 24°C (75°F)
 - ASHRAE Class A4: 8% to 90%; maximum dew point: 24°C (75°F)
 - Shipment/storage: 8% to 90%

The server generates the following heat and noise:

- Heat/thermal output:
 - Minimum configuration: 346 BTU/hr, 101 W
 - Maximum configuration: 3197 BTU/hr, 937 W
- Noise level (LWAm)
 - Sound power, idling: 5.1 bels (minimum), 5.8 bels (typical), 6.2 bels (maximum)
 - Sound power, operating: 5.1 bels (minimum), 5.8 bels (typical), 6.2 bels (maximum)

The server has the following vibration and shock limits:

- Vibration:
 - Operating: 0.21 G rms at 5 Hz to 500 Hz for 15 minutes across 3 axes
 - Non-operating: 1.04 G rms at 2 Hz to 200 Hz for 15 minutes across 6 surfaces
- Shock:
 - Operating: 15 G for 3 milliseconds in each direction (positive and negative X, Y, and Z axes)
 - Non-operating:
 - 12 kg - 22 kg: 50 G for 152 in./sec velocity change across 6 surfaces

Warranty and Support

The SR635 has a 1-year or 3-year warranty based on the machine type of the system:

- 7Y98: 1 year warranty
- 7Y99: 3 year warranty

The standard warranty terms are customer-replaceable unit (CRU) and onsite (for field-replaceable units FRUs only) with standard call center support during normal business hours and 9x5 Next Business Day Parts Delivered.

Lenovo's additional support services provide a sophisticated, unified support structure for your data center, with an experience consistently ranked number one in customer satisfaction worldwide. Available offerings include:

- **Premier Support**

Premier Support provides a Lenovo-owned customer experience and delivers direct access to technicians skilled in hardware, software, and advanced troubleshooting, in addition to the following:

- Direct technician-to-technician access through a dedicated phone line
- 24x7x365 remote support
- Single point of contact service
- End to end case management
- Third-party collaborative software support
- Online case tools and live chat support
- On-demand remote system analysis

- **Warranty Upgrade (Preconfigured Support)**

Services are available to meet the on-site response time targets that match the criticality of your systems.

- 3, 4, or 5 years of service coverage
- 1-year or 2-year post-warranty extensions
- **Foundation Service:** 9x5 service coverage with next business day onsite response. YourDrive YourData is an optional extra (see below).
- **Essential Service:** 24x7 service coverage with 4-hour onsite response or 24-hour committed repair (available only in select countries). Bundled with YourDrive YourData.
- **Advanced Service:** 24x7 service coverage with 2-hour onsite response or 6-hour committed repair (available only in select countries). Bundled with YourDrive YourData.

- **Managed Services**

Lenovo Managed Services provides continuous 24x7 remote monitoring (plus 24x7 call center availability) and proactive management of a your data center using state of the art tools, systems, and practices by a team of highly skilled and experienced Lenovo services professionals.

Quarterly reviews check error logs, verify firmware & OS device driver levels, and software as needed. We'll also maintain records of latest patches, critical updates, and firmware levels, to ensure you systems are providing business value through optimized performance.

- **Technical Account Management (TAM)**

A Lenovo Technical Account Manager helps you optimize the operation of your data center based on a deep understanding of your business. You gain direct access to your Lenovo TAM, who serves as your single point of contact to expedite service requests, provide status updates, and furnish reports to track incidents over time. In addition, your TAM will help proactively make service recommendations and manage your service relationship with Lenovo to make certain your needs are met.

- **Enterprise Server Software Support**

Enterprise Software Support is an additional support service providing customers with software support on Microsoft, Red Hat, SUSE, and VMware applications and systems. Around the clock availability for critical problems plus unlimited calls and incidents helps customers address challenges fast, without incremental costs. Support staff can answer troubleshooting and diagnostic questions, address product comparability and interoperability issues, isolate causes of problems, report defects to software vendors, and more.

- **YourDrive YourData**

Lenovo's YourDrive YourData is a multi-drive retention offering that ensures your data is always under your control, regardless of the number of drives that are installed in your Lenovo server. In the unlikely event of a drive failure, you retain possession of your drive while Lenovo replaces the failed drive part. Your data stays safely on your premises, in your hands. The YourDrive YourData service can be purchased in convenient bundles, and is optional with Foundation Service. It is bundled with Essential Service and Advanced Service.

- **Health Check**

Having a trusted partner who can perform regular and detailed health checks is central to maintaining efficiency and ensuring that your systems and business are always running at their best. Health Check supports Lenovo-branded server, storage, and networking devices, as well as select Lenovo-supported products from other vendors that are sold by Lenovo or a Lenovo-Authorized Reseller.

Examples of region-specific warranty terms are second or longer business day parts delivery or parts-only base warranty.

If warranty terms and conditions include onsite labor for repair or replacement of parts, Lenovo will dispatch a service technician to the customer site to perform the replacement. Onsite labor under base warranty is limited to labor for replacement of parts that have been determined to be field-replaceable units (FRUs). Parts that are determined to be customer-replaceable units (CRUs) do not include onsite labor under base warranty.

If warranty terms include parts-only base warranty, Lenovo is responsible for delivering only replacement parts that are under base warranty (including FRUs) that will be sent to a requested location for self-service. Parts-only service does not include a service technician being dispatched onsite. Parts must be changed at customer's own cost and labor and defective parts must be returned following the instructions supplied with the spares parts.

Lenovo Service offerings are region-specific. Not all preconfigured support and upgrade options are available in every region. For information about Lenovo service upgrade offerings that are available in your region, refer to the following resources:

- Service part numbers in Lenovo Data Center Solution Configurator (DCSC):
<http://dcsc.lenovo.com/#/services>
- Lenovo Services Availability Locator
<http://lenovolocator.com/>

For service definitions, region-specific details, and service limitations, please refer to the following documents:

- Lenovo Statement of Limited Warranty for Data Center Group (DCG) Servers and System Storage
<http://pcsupport.lenovo.com/us/en/solutions/ht503310>
- Lenovo Data Center Services Agreement
<http://support.lenovo.com/us/en/solutions/ht116628>

Services

Lenovo Services is a dedicated partner to your success. Our goal is to reduce your capital outlays, mitigate your IT risks, and accelerate your time to productivity.

Here's a more in-depth look at what we can do for you:

- **Asset Recovery Services**

Asset Recovery Services (ARS) helps customers recover the maximum value from their end-of-life equipment in a cost-effective and secure way. On top of simplifying the transition from old to new equipment, ARS mitigates environmental and data security risks associated with data center equipment disposal. Lenovo ARS is a cash-back solution for equipment based on its remaining market value, yielding maximum value from aging assets and lowering total cost of ownership for your customers.

- **Assessment Services**

An Assessment helps solve your IT challenges through an onsite, multi-day session with a Lenovo technology expert. We perform a tools based assessment which provides a comprehensive and thorough review of a company's environment and technology systems. In addition to the technology based functional requirements, the consultant also discusses and records the non-functional business requirements, challenges, and constraints. Assessments help organizations like yours, no matter how large or small, get a better return on your IT investment and overcome challenges in the ever-changing technology landscape.

- **Design Services**

Professional Services consultants perform infrastructure design and implementation planning to support your strategy. The high-level architectures provided by the assessment service are turned into low level designs and wiring diagrams, which are reviewed and approved prior to implementation. The implementation plan will demonstrate an outcome-based proposal to provide business capabilities through infrastructure with a risk-mitigated project plan.

- **Basic Hardware Installation**

Lenovo experts can seamlessly manage the physical installation of your server, storage, or networking hardware. Working at a time convenient for you (business hours or off shift), the technician will unpack and inspect the systems on your site, install options, mount in a rack cabinet, connect to power and network, check and update firmware to the latest levels, verify operation, and dispose of the packaging, allowing your team to focus on other priorities.

- **Deployment Services**

When investing in new IT infrastructures, you need to ensure your business will see quick time to value with little to no disruption. Lenovo deployments are designed by development and engineering teams who know our Products & Solutions better than anyone else, and our technicians own the process from delivery to completion. Lenovo will conduct remote preparation and planning, configure & integrate systems, validate systems, verify and update appliance firmware, train on administrative tasks, and provide post-deployment documentation. Customer's IT teams leverage our skills to enable IT staff to transform with higher level roles and tasks.

- **Integration, Migration, and Expansion Services**

Move existing physical & virtual workloads easily, or determine technical requirements to support increased workloads while maximizing performance. Includes tuning, validation, and documenting ongoing run processes. Leverage migration assessment planning documents to perform necessary migrations.

Some service options may not be available in all countries. For more information, go to <https://www.lenovo.com/systems/services>. For information about Lenovo service upgrade offerings that are available in your region, contact your local Lenovo sales representative or business partner.

Regulatory compliance

The SR635 server conforms to the following standards:

- Energy Star 3.0
- FCC: Verified to comply with Part 15 of the FCC Rules, Class A
- Canada ICES-003, issue 6, Class A
- UL/IEC 60950-1
- CSA C22.2 No. 60950-1
- NOM-019
- Argentina IEC60950-1
- Japan VCCI, Class A
- Australia/New Zealand AS/NZS CISPR 32, Class A; AS/NZS 60950.1
- IEC 60950-1 (CB Certificate and CB Test Report)
- China CCC (GB4943.1), GB9254 Class A, GB17625.1
- Taiwan BSMI CNS13438, Class A; CNS14336-1
- Korea KN32, Class A; KN35
- Russia, Belorussia and Kazakhstan, EAC: TP TC 004/2011(for Safety); TP TC 020/2011(for EMC)
- CE Mark (EN55032 Class A, EN60950-1, EN55024, EN61000-3-2, and EN61000-3-3)
- CISPR 32, Class A
- TUV-GS (EN60950-1 /IEC60950-1, EK1-ITB2000)
- India BIS certification

External drive enclosures

The server supports attachment to external drive enclosures using a RAID controller with external ports or a SAS host bus adapter. Adapters supported by the server are listed in the [SAS adapters for external storage](#) section.

Note: Information provided in this section is for ordering reference purposes only. For the operating system and adapter support details, refer to the interoperability matrix for a particular storage enclosure that can be found on the Lenovo Data Center Support web site:

<http://datacentersupport.lenovo.com>

Table 56. External drive enclosures

Description	Part number		
	Worldwide	Japan	PRC
Lenovo Storage D1212 LFF Disk Expansion with Dual SAS IO Modules	4587A11	4587A1J	4587A1C
Lenovo Storage D1224 SFF Disk Expansion with Dual SAS IO Modules	4587A31	4587A3J	4587A3C
Lenovo Storage D3284 4TB x 84 HD Expansion Enclosure	641311F		
Lenovo Storage D3284 6TB x 84 HD Expansion Enclosure	641312F		
Lenovo Storage D3284 8TB x 84 HD Expansion Enclosure	641313F		
Lenovo Storage D3284 10TB x 84 HD Expansion Enclosure	641314F		

For details about supported drives, adapters, and cables, see the following Lenovo Press Product Guides:

- Lenovo Storage D1212 and D1224
<http://lenovopress.com/lp0512>
- Lenovo Storage D3284
<http://lenovopress.com/lp0513>

External storage systems

The following table lists the external storage systems that are currently offered by Lenovo.

Note: Information provided in this section is for ordering reference purposes only. End-to-end storage configuration support *must* be verified through the interoperability matrix for a particular storage system that can be found on the Lenovo Data Center Support web site:

<http://datacentersupport.lenovo.com>

Table 57. External storage systems: DE Series

Description	Part number	
	Worldwide	Japan
Lenovo ThinkSystem DE Series Storage (SAS connectivity)		
Lenovo ThinkSystem DE2000H SAS Hybrid Flash Array LFF	7Y70A000WW	7Y701003JP
Lenovo ThinkSystem DE2000H SAS Hybrid Flash Array SFF	7Y71A000WW	7Y711003JP
Lenovo ThinkSystem DE4000H SAS Hybrid Flash Array 4U60	7Y77A002WW	7Y771000JP
Lenovo ThinkSystem DE4000H SAS Hybrid Flash Array LFF	7Y74A000WW	7Y74A000JP
Lenovo ThinkSystem DE4000H SAS Hybrid Flash Array SFF	7Y75A000WW	7Y75A000JP
Lenovo ThinkSystem DE4000F SAS All Flash Array SFF	7Y76A000WW	7Y76A000JP
Lenovo ThinkSystem DE6000H SAS Hybrid Flash Array 4U60	7Y80A000WW	7Y801002JP
Lenovo ThinkSystem DE6000H SAS Hybrid Flash Array SFF	7Y78A000WW	7Y781002JP
Lenovo ThinkSystem DE6000F SAS All Flash Array SFF	7Y79A000WW	7Y79A000JP
Lenovo ThinkSystem DE Series Storage (iSCSI connectivity)		
Lenovo ThinkSystem DE2000H 10GBASE-T Hybrid Flash Array LFF	7Y70A003WW	7Y701001JP
Lenovo ThinkSystem DE2000H 10GBASE-T Hybrid Flash Array SFF	7Y71A002WW	7Y711005JP
Lenovo ThinkSystem DE2000H iSCSI Hybrid Flash Array LFF	7Y70A004WW	7Y701000JP
Lenovo ThinkSystem DE2000H iSCSI Hybrid Flash Array SFF	7Y71A003WW	7Y711006JP
Lenovo ThinkSystem DE4000H iSCSI Hybrid Flash Array 4U60	7Y77A000WW	7Y771002JP
Lenovo ThinkSystem DE4000H iSCSI Hybrid Flash Array LFF	7Y74A002WW	7Y74A002JP
Lenovo ThinkSystem DE4000H iSCSI Hybrid Flash Array SFF	7Y75A001WW	7Y75A001JP
Lenovo ThinkSystem DE4000F iSCSI All Flash Array SFF	7Y76A002WW	7Y76A002JP
Lenovo ThinkSystem DE6000H iSCSI Hybrid Flash Array 4U60	7Y80A002WW	7Y801000JP
Lenovo ThinkSystem DE6000H iSCSI Hybrid Flash Array SFF	7Y78A002WW	7Y781000JP
Lenovo ThinkSystem DE6000F iSCSI All Flash Array SFF	7Y79A002WW	7Y79A002JP
Lenovo ThinkSystem DE Series Storage (FC connectivity)		
Lenovo ThinkSystem DE2000H FC Hybrid Flash Array LFF	7Y70A002WW	7Y701002JP
Lenovo ThinkSystem DE2000H FC Hybrid Flash Array SFF	7Y71A001WW	7Y711004JP
Lenovo ThinkSystem DE4000H FC Hybrid Flash Array 4U60	7Y77A001WW	7Y771001JP
Lenovo ThinkSystem DE4000H FC Hybrid Flash Array LFF	7Y74A001WW	7Y74A001JP
Lenovo ThinkSystem DE4000H FC Hybrid Flash Array SFF	7Y75A002WW	7Y75A002JP
Lenovo ThinkSystem DE4000F FC All Flash Array SFF	7Y76A001WW	7Y76A001JP
Lenovo ThinkSystem DE6000H FC Hybrid Flash Array 4U60	7Y80A001WW	7Y801001JP
Lenovo ThinkSystem DE6000H FC Hybrid Flash Array SFF	7Y78A001WW	7Y781001JP
Lenovo ThinkSystem DE6000F FC All Flash Array SFF	7Y79A001WW	7Y79A001JP

Table 58. External storage systems: DM Series

Description	Part number		
	Worldwide	Japan	PRC
Lenovo ThinkSystem DM Series Storage (iSCSI or FC connectivity)			
Lenovo ThinkSystem DM3000H Hybrid Storage Array (2U12 LFF, CTO only)	7Y42CTO1WW		
Lenovo ThinkSystem DM3000H 48TB (12x 4TB HDDs) (Universal SFP+)	7Y420001EA*		
Lenovo ThinkSystem DM3000H 48TB (12x 4TB HDDs) (10GBASE-T)	7Y420002EA*		
Lenovo ThinkSystem DM5000H Hybrid Storage Array (2U24 SFF, CTO only)	7Y57CTO1WW		
Lenovo ThinkSystem DM5000H 11.5TB (12x 960GB SSDs) (Universal SFP+)	7Y570001EA*		
Lenovo ThinkSystem DM5000H 11.5TB (12x 960GB SSDs) (10GBASE-T)	7Y570002EA*		
Lenovo ThinkSystem DM5000H 29TB (24x 1.2TB 10K HDDs) (Universal SFP+)	7Y570003EA*		
Lenovo ThinkSystem DM5000H 29TB (24x 1.2TB 10K HDDs) (10GBASE-T)	7Y570004EA*		
Lenovo ThinkSystem DM5000F Flash Storage Array (2U24 SFF, CTO only)	7Y41CTO1WW		
Lenovo ThinkSystem DM7000H Hybrid Storage Array (3U, CTO only)	7Y56CTO1WW		
Lenovo ThinkSystem DM7000F Flash Storage Array (3U, CTO only)	7Y40CTO1WW		

* Available only in EMEA.

Table 59. External storage systems: DS Series

Description	Part number		
	Worldwide	Japan	PRC
Lenovo ThinkSystem DS Series Storage (SAS connectivity)			
Lenovo ThinkSystem DS2200 LFF SAS Dual Controller Unit	4599A41	4599A4J	4599A4C
Lenovo ThinkSystem DS2200 SFF SAS Dual Controller Unit	4599A21	4599A2J	4599A2C
Lenovo ThinkSystem DS4200 LFF SAS Dual Controller Unit	4617A41	4617A4J	4617A4C
Lenovo ThinkSystem DS4200 SFF SAS Dual Controller Unit	4617A21	4617A2J	4617A2C
Lenovo ThinkSystem DS6200 SFF SAS Dual Controller Unit	4619A21	4619A2J	4619A2C
Lenovo ThinkSystem DS Series Storage (iSCSI or FC connectivity)			
Lenovo ThinkSystem DS2200 LFF FC/iSCSI Dual Controller Unit	4599A31	4599A3J	4599A3C
Lenovo ThinkSystem DS2200 SFF FC/iSCSI Dual Controller Unit	4599A11	4599A1J	4599A1C
Lenovo ThinkSystem DS4200 LFF FC/iSCSI Dual Controller Unit	4617A31	4617A3J	4617A3C
Lenovo ThinkSystem DS4200 SFF FC/iSCSI Dual Controller Unit	4617A11	4617A1J	4617A1C
Lenovo ThinkSystem DS6200 SFF FC/iSCSI Dual Controller Unit	4619A11	4619A1J	4619A1C
DS6200F 12x 400GB 10DWD SSDs, 1x 8Gb FC SFP, 512 Snapshots, Replication	4619A1F	4619J1F	4619C1F
DS6200F 12x 800GB 3DWD SSDs, 1x 8Gb FC SFP, 512 Snapshots, Replication	4619A2F	4619J2F	4619C2F
DS6200F 12x 1.6TB 3DWD SSDs, 1x 8Gb FC SFP, 512 Snapshots, Replication	4619A3F	4619J3F	4619C3F
DS6200F 12x 3.84TB 1DWD SSDs, 1x 8Gb FC SFP, 512 Snapshots, Replication	4619A4F	4619J4F	4619C4F

Table 60. External storage systems: V Series and Storwize for Lenovo

Description	Part number
Lenovo Storage V Series (SAS [except V7000/V7000F], iSCSI, or FC connectivity)	
Lenovo Storage V3700 V2 LFF Control Enclosure	6535C1D
Lenovo Storage V3700 V2 SFF Control Enclosure	6535C2D
Lenovo Storage V3700 V2 XP LFF Control Enclosure	6535C3D
Lenovo Storage V3700 V2 XP SFF Control Enclosure	6535C4D
Lenovo Storage V5030 LFF Control Enclosure 3Yr S&S	6536C12
Lenovo Storage V5030 LFF Control Enclosure 5Yr S&S	6536C32
Lenovo Storage V5030 SFF Control Enclosure 3Yr S&S	6536C22
Lenovo Storage V5030 SFF Control Enclosure 5Yr S&S	6536C42
Lenovo Storage V5030F SFF Control Enclosure 3Yr S&S	6536B1F
Lenovo Storage V5030F SFF Control Enclosure 5Yr S&S	6536B2F
Lenovo Storage V7000 SFF Control Enclosure 3Yr S&S PRC	6538R11^
Lenovo Storage V7000 SFF Control Enclosure 5Yr S&S PRC	6538R21^
Lenovo Storage V7000F SFF Control Enclosure 3Yr S&S PRC	6538R1G^
Lenovo Storage V7000F SFF Control Enclosure 5Yr S&S PRC	6538R2G^
IBM Storwize for Lenovo (iSCSI or FC connectivity)	
IBM Storwize V7000 SFF Control Enclosure, 3YR SWMA	6195C32†
IBM Storwize V7000 SFF Control Enclosure, 3YR SWMA, LA	6195C3L‡
IBM Storwize V7000 SFF Control Enclosure, 5YR SWMA	6195C52†
IBM Storwize V7000 SFF Control Enclosure, 5YR SWMA, LA	6195C5L‡

^ Available only in PRC.

† Available worldwide except Latin America.

‡ Available only in Latin America.

For more information, see the list of Product Guides in the following categories:

- Lenovo DE Series, DM Series, DS Series, and V Series storage:
<http://lenovopress.com/storage/san/lenovo#rt=product-guide>
- IBM Storwize for Lenovo storage:
<http://lenovopress.com/storage/san/ibm#rt=product-guide>

External backup units

The server supports both USB-attached RDX backup units and SAS-attached tape drives.

The following table lists the available external SAS tape backup options.

Tip: Verify the end-to-end support of an IBM tape backup solution through the IBM System Storage Interoperation Center (SSIC): <http://www.ibm.com/systems/support/storage/ssic>

Table 61. External SAS backup options

Part number	Description
External SAS tape backup drives	
6160S6E	IBM TS2260 Tape Drive Model H6S
6160S7E	IBM TS2270 Tape Drive Model H7S
6160S8E	IBM TS2280 Tape Drive Model H8S
External SAS tape backup autoloaders	
6171S6R	IBM TS2900 Tape Autoloader w/LTO6 HH SAS
6171S7R	IBM TS2900 Tape Autoloader w/LTO7 HH SAS
6171S8R	IBM TS2900 Tape Autoloader w/LTO8 HH SAS
External tape backup libraries	
6741A1F	IBM TS4300 3U Tape Library-Base Unit
SAS backup drives for TS4300 Tape Library	
01KP934	LTO 6 HH SAS Drive
01KP937	LTO 7 HH SAS Drive
01KP953	LTO 8 HH SAS Drive

For more information, see the list of Product Guides in the Backup units category: <https://lenovopress.com/servers/options/backup>

The following table lists the external RDX backup options available.

Table 62. External RDX dock and cartridges

Part number	Feature code	Description
External RDX docks		
4T27A10725	B32R	ThinkSystem RDX External USB 3.0 Dock (No cartridge included with the drive)
Cartridges		
7TP7A01601	AVF8	ThinkSystem RDX 500GB Cartridge
7TP7A01602	AVF1	ThinkSystem RDX 1TB Cartridge
7TP7A01603	AVF0	ThinkSystem RDX 2TB Cartridge
7TP7A04318	AXD1	ThinkSystem RDX 4TB Cartridge

For more information, see the Lenovo RDX USB 3.0 Disk Backup Solution product guide: <https://lenovopress.com/tips0894-rdx-usb-30>

Top-of-rack Ethernet switches

The following table lists the Ethernet LAN switches that are offered by Lenovo.

Table 63. Ethernet LAN switches

Part number	Description
1 Gb Ethernet Rack switches	
7Y810011WW	Lenovo ThinkSystem NE0152T RackSwitch (Rear to Front)
7Z320011WW	Lenovo ThinkSystem NE0152TO RackSwitch (Rear to Front, ONIE)
7159BAX	Lenovo RackSwitch G7028 (Rear to Front)
7159CAX	Lenovo RackSwitch G7052 (Rear to Front)
7159G52	Lenovo RackSwitch G8052 (Rear to Front)
7165H1X	Juniper EX2300-C PoE Switch
7165H2X	Juniper EX2300-24p PoE Switch
1 Gb Ethernet Campus switches	
7Z340011WW	Lenovo CE0128TB Switch (3-Year Warranty)
7Z360011WW	Lenovo CE0128TB Switch (Limited Lifetime Warranty)
7Z340012WW	Lenovo CE0128PB Switch (3-Year Warranty)
7Z360012WW	Lenovo CE0128PB Switch (Limited Lifetime Warranty)
7Z350021WW	Lenovo CE0152TB Switch (3-Year Warranty)
7Z370021WW	Lenovo CE0152TB Switch (Limited Lifetime Warranty)
7Z350022WW	Lenovo CE0152PB Switch (3-Year Warranty)
7Z370022WW	Lenovo CE0152PB Switch (Limited Lifetime Warranty)
10 Gb Ethernet switches	
7159A1X	Lenovo ThinkSystem NE1032 RackSwitch (Rear to Front)
7159B1X	Lenovo ThinkSystem NE1032T RackSwitch (Rear to Front)
7159C1X	Lenovo ThinkSystem NE1072T RackSwitch (Rear to Front)
7159CRW	Lenovo RackSwitch G8272 (Rear to Front)
7159GR6	Lenovo RackSwitch G8296 (Rear to Front)
25 Gb Ethernet switches	
7159E1X	Lenovo ThinkSystem NE2572 RackSwitch (Rear to Front)
7Z210021WW	Lenovo ThinkSystem NE2572O RackSwitch (Rear to Front, ONIE)
100 Gb Ethernet switches	
7159D1X	Lenovo ThinkSystem NE10032 RackSwitch (Rear to Front)
7Z210011WW	Lenovo ThinkSystem NE10032O RackSwitch (Rear to Front, ONIE)

For more information, see the list of Product Guides in the following switch categories:

- 1 Gb Ethernet switches: <http://lenovopress.com/networking/tor/1gb?rt=product-guide>
- 10 Gb Ethernet switches: <http://lenovopress.com/networking/tor/10gb?rt=product-guide>
- 25 Gb Ethernet switches: <http://lenovopress.com/networking/tor/25gb?rt=product-guide>
- 40 Gb Ethernet switches: <http://lenovopress.com/networking/tor/40gb?rt=product-guide>
- 100 Gb Ethernet switches: <https://lenovopress.com/networking/tor/100Gb?rt=product-guide>

Fibre Channel SAN switches

The following table lists the Fibre Channel SAN switches that are offered by Lenovo and can be used with this system.

Table 64. Fibre Channel SAN switches

Part number	Description
8 Gb FC	
3873AR6	Lenovo B300, E_Port License, 8 ports licensed, 8x 8Gb SWL SFPs, 1 PS, Rail Kit, 1Yr FW
16 Gb FC	
6559F2A	Lenovo ThinkSystem DB610S, 8 ports licensed, 8x 16Gb SWL SFPs, 1 PS, Rail Kit, 1Yr FW
6559F1A	Lenovo ThinkSystem DB610S, ENT Bundle, 24 ports licensed, 24x 16Gb SWL SFPs, 1 PS, Rail Kit, 1Yr FW
6559D1Y	Lenovo ThinkSystem DB610S, ENT Bundle, 24 ports licensed, 24x 16Gb SWL SFPs, 1 PS, Rail Kit, 3Yr FW
3873ER1	Lenovo B6505, 12 ports licensed, 12x 16Gb SWL SFPs, 1 PS, Rail Kit, 1Yr FW
3873AR5	Lenovo B6505, 12 ports licensed, 12x 16Gb SWL SFPs, 1 PS, Rail Kit, 3Yr FW
3873IR1	Lenovo B6510, 24 ports licensed, 24x 16Gb SWL SFPs, 2 PS, Rail Kit, 1Yr FW
3873BR3	Lenovo B6510, 24 ports licensed, 24x 16Gb SWL SFPs, 2 PS, Rail Kit, 3Yr FW
32 Gb FC	
6559F3A	Lenovo ThinkSystem DB610S, 8 ports licensed, No SFPs, 1 PS, Rail Kit, 1Yr FW
6559D3Y	Lenovo ThinkSystem DB610S, 8 ports licensed, No SFPs, 1 PS, Rail Kit, 3Yr FW
6415G3A	Lenovo ThinkSystem DB620S, 24 ports licensed, No SFPs, 2 PS, Rail Kit, 1Yr FW
6415H11	Lenovo ThinkSystem DB620S, 24 ports licensed, 24x 32Gb SWL SFPs, 2 PS, Rail Kit, 1Yr FW
6415G11	Lenovo ThinkSystem DB620S, 24 ports licensed, 24x 32Gb SWL SFPs, 2 PS, Rail Kit, 3Yr FW
6415H2A	Lenovo ThinkSystem DB620S, ENT Bundle, 48 ports licensed, 48x 32Gb SWL SFPs, 2 PS, Rail Kit, 1Yr FW
7D1SA001WW	Lenovo ThinkSystem DB630S, 48 ports licensed, No SFPs, 2 PS, Rail Kit, 1Yr FW
7D1SA002WW	Lenovo ThinkSystem DB630S, 48 ports licensed, 48x 32Gb SWL SFPs, 2 PS, Rail Kit, 1Yr FW
7D1SA003WW	Lenovo ThinkSystem DB630S, ENT, 96 ports licensed, 96x 32Gb SWL SFPs, 2 PS, Rail Kit, 1Yr FW
6684D2A	Lenovo ThinkSystem DB400D 32Gb FC Director, ENT. Feature set, 4 Blade slots, 8U, 1Yr FW
6684B2A	Lenovo ThinkSystem DB400D 32Gb FC Director, ENT. Feature set, 4 Blade slots, 8U, 3Yr FW
6682D1A	Lenovo ThinkSystem DB800D 32Gb FC Director, ENT. Feature set, 8 Blade slots, 14U, 1Yr FW

For more information, see the list of Product Guides in the Rack SAN Switches category:

<http://lenovopress.com/storage/switches/rack#rt=product-guide>

Uninterruptible power supply units

The following table lists the uninterruptible power supply (UPS) units that are offered by Lenovo.

Table 65. Uninterruptible power supply units

Part number	Description
55941AX	RT1.5kVA 2U Rack or Tower UPS (100-125VAC)
55941KX	RT1.5kVA 2U Rack or Tower UPS (200-240VAC)
55942AX	RT2.2kVA 2U Rack or Tower UPS (100-125VAC)
55942KX	RT2.2kVA 2U Rack or Tower UPS (200-240VAC)
55943AX	RT3kVA 2U Rack or Tower UPS (100-125VAC)
55943KX	RT3kVA 2U Rack or Tower UPS (200-240VAC)
55945KX	RT5kVA 3U Rack or Tower UPS (200-240VAC)
55946KX	RT6kVA 3U Rack or Tower UPS (200-240VAC)
55948KX	RT8kVA 6U Rack or Tower UPS (200-240VAC)
55949KX	RT11kVA 6U Rack or Tower UPS (200-240VAC)
55948PX	RT8kVA 6U 3:1 Phase Rack or Tower UPS (380-415VAC)
55949PX	RT11kVA 6U 3:1 Phase Rack or Tower UPS (380-415VAC)
55943KT†	ThinkSystem RT3kVA 2U Standard UPS (200-230VAC) (2x C13 10A, 2x GB 10A, 1x C19 16A outlets)
55943LT†	ThinkSystem RT3kVA 2U Long Backup UPS (200-230VAC) (2x C13 10A, 2x GB 10A, 1x C19 16A outlets)
55946KT†	ThinkSystem RT6kVA 5U UPS (200-230VAC) (2x C13 10A outlets, 1x Terminal Block output)
5594XKT†	ThinkSystem RT10kVA 5U UPS (200-230VAC) (2x C13 10A outlets, 1x Terminal Block output)

† Only available in China and countries in the Asia Pacific region.

For more information, see the list of Product Guides in the UPS category:

<https://lenovopress.com/servers/options/ups>

Power distribution units

The following table lists the power distribution units (PDUs) that are offered by Lenovo.

Table 66. Power distribution units

Part number	Description
0U Basic PDUs	
00YJ776	0U 36 C13/6 C19 24A/200-240V 1 Phase PDU with NEMA L6-30P line cord
00YJ777	0U 36 C13/6 C19 32A/200-240V 1 Phase PDU with IEC60309 332P6 line cord
00YJ778	0U 21 C13/12 C19 32A/200-240V/346-415V 3 Phase PDU with IEC60309 532P6 line cord
00YJ779	0U 21 C13/12 C19 48A/200-240V 3 Phase PDU with IEC60309 460P9 line cord
Switched and Monitored PDUs	
00YJ780	0U 20 C13/4 C19 Switched and Monitored 32A/200-240V/1Ph PDU w/ IEC60309 332P6 line cord
00YJ781	0U 20 C13/4 C19 Switched and Monitored 24A/200-240V/1Ph PDU w/ NEMA L6-30P line cord
00YJ782	0U 18 C13/6 C19 Switched / Monitored 32A/200-240V/346-415V/3Ph PDU w/ IEC60309 532P6 cord
00YJ783	0U 12 C13/12 C19 Switched and Monitored 48A/200-240V/3Ph PDU w/ IEC60309 460P9 line cord
46M4002	1U 9 C19/3 C13 Switched and Monitored DPI PDU (without line cord)
46M4003	1U 9 C19/3 C13 Switched and Monitored 60A 3 Phase PDU with IEC 309 3P+Gnd line cord
46M4004	1U 12 C13 Switched and Monitored DPI PDU (without line cord)
46M4005	1U 12 C13 Switched and Monitored 60A 3 Phase PDU with IEC 309 3P+Gnd line cord
Ultra Density Enterprise PDUs (9x IEC 320 C13 + 3x IEC 320 C19 outlets)	
71762NX	Ultra Density Enterprise C19/C13 PDU Module (without line cord)
71763NU	Ultra Density Enterprise C19/C13 PDU 60A/208V/3ph with IEC 309 3P+Gnd line cord
C13 Enterprise PDUs (12x IEC 320 C13 outlets)	
39M2816	DPI C13 Enterprise PDU+ (without line cord)
39Y8941	DPI Single Phase C13 Enterprise PDU (without line cord)
C19 Enterprise PDUs (6x IEC 320 C19 outlets)	
39Y8948	DPI Single Phase C19 Enterprise PDU (without line cord)
39Y8923	DPI 60A 3 Phase C19 Enterprise PDU with IEC 309 3P+G (208 V) fixed line cord
Front-end PDUs (3x IEC 320 C19 outlets)	
39Y8938	DPI 30amp/125V Front-end PDU with NEMA L5-30P line cord
39Y8939	DPI 30amp/250V Front-end PDU with NEMA L6-30P line cord
39Y8934	DPI 32amp/250V Front-end PDU with IEC 309 2P+Gnd line cord
39Y8940	DPI 60amp/250V Front-end PDU with IEC 309 2P+Gnd line cord
39Y8935	DPI 63amp/250V Front-end PDU with IEC 309 2P+Gnd line cord
NEMA PDUs (6x NEMA 5-15R outlets)	
39Y8905	DPI 100-127V PDU with Fixed NEMA L5-15P line cord
Line cords for PDUs that ship without a line cord	
40K9611	DPI 32a Line Cord (IEC 309 3P+N+G)
40K9612	DPI 32a Line Cord (IEC 309 P+N+G)
40K9613	DPI 63a Cord (IEC 309 P+N+G)
40K9614	DPI 30a Line Cord (NEMA L6-30P)
40K9615	DPI 60a Cord (IEC 309 2P+G)
40K9617	DPI Australian/NZ 3112 Line Cord

Part number	Description
40K9618	DPI Korean 8305 Line Cord

For more information, see the Lenovo Press documents in the PDU category:
<https://lenovopress.com/servers/options/pdu>

Rack cabinets

The following table lists the supported rack cabinets.

Table 67. Rack cabinets

Part number	Description
93072RX	25U Standard Rack
93072PX	25U Static S2 Standard Rack
93634PX	42U 1100mm Dynamic Rack
93634EX	42U 1100mm Dynamic Expansion Rack
93604PX	42U 1200mm Deep Dynamic Rack
93614PX	42U 1200mm Deep Static Rack
93084EX	42U Enterprise Expansion Rack
93084PX	42U Enterprise Rack
93074RX	42U Standard Rack
Withdrawn rack cabinets	
201886X*	11U Office Enablement Kit
93604EX*	42U 1200mm Deep Dynamic Expansion Rack
93614EX*	42U 1200mm Deep Static Expansion Rack
93074XX*	42U Standard Rack Extension
93624PX*	47U 1200mm Deep Static Rack
93624EX*	47U 1200mm Deep Static Expansion Rack
93634BX*	PureFlex System 42U Expansion Rack
93634DX*	PureFlex System 42U Expansion Rack
93634AX*	PureFlex System 42U Rack
93634CX*	PureFlex System 42U Rack

* Withdrawn from marketing

For specifications about these racks, see the Lenovo Rack Cabinet Reference, available from:
<https://lenovopress.com/lp0658-lenovo-rack-cabinet-reference>

For more information, see the list of Product Guides in the Rack cabinets category:
<https://lenovopress.com/servers/options/racks>

KVM console options

The following table lists the supported KVM consoles, keyboards, and KVM switches.

Table 68. Console keyboards

Part number	Description
Consoles	
17238BX	1U 18.5" Standard Console (without keyboard)
Console keyboards	
7ZB7A05469	ThinkSystem Keyboard w/ Int. Pointing Device USB - Arabic 253 RoHS v2
7ZB7A05468	ThinkSystem Keyboard w/ Int. Pointing Device USB - Belg/UK 120 RoHS v2
7ZB7A05206	ThinkSystem Keyboard w/ Int. Pointing Device USB - Czech 489 RoHS v2
7ZB7A05207	ThinkSystem Keyboard w/ Int. Pointing Device USB - Danish 159 RoHS v2
7ZB7A05208	ThinkSystem Keyboard w/ Int. Pointing Device USB - Dutch 143 RoHS v2
7ZB7A05210	ThinkSystem Keyboard w/ Int. Pointing Device USB - Fr/Canada 445 RoHS v2
7ZB7A05209	ThinkSystem Keyboard w/ Int. Pointing Device USB - French 189 RoHS v2
7ZB7A05211	ThinkSystem Keyboard w/ Int. Pointing Device USB - German 129 RoHS v2
7ZB7A05212	ThinkSystem Keyboard w/ Int. Pointing Device USB - Greek 219 RoHS v2
7ZB7A05213	ThinkSystem Keyboard w/ Int. Pointing Device USB - Hebrew 212 RoHS v2
7ZB7A05214	ThinkSystem Keyboard w/ Int. Pointing Device USB - Hungarian 208 RoHS v2
7ZB7A05215	ThinkSystem Keyboard w/ Int. Pointing Device USB - Italian 141 RoHS v2
7ZB7A05216	ThinkSystem Keyboard w/ Int. Pointing Device USB - Japanese 194 RoHS v2
7ZB7A05217	ThinkSystem Keyboard w/ Int. Pointing Device USB - Korean 413 RoHS v2
7ZB7A05218	ThinkSystem Keyboard w/ Int. Pointing Device USB - LA Span 171 RoHS v2
7ZB7A05219	ThinkSystem Keyboard w/ Int. Pointing Device USB - Norwegian 155 RoHS v2
7ZB7A05220	ThinkSystem Keyboard w/ Int. Pointing Device USB - Polish 214 RoHS v2
7ZB7A05221	ThinkSystem Keyboard w/ Int. Pointing Device USB - Portuguese 163 RoHS v2
7ZB7A05222	ThinkSystem Keyboard w/ Int. Pointing Device USB - Russian 441 RoHS v2
7ZB7A05223	ThinkSystem Keyboard w/ Int. Pointing Device USB - Slovak 245 RoHS v2
7ZB7A05231	ThinkSystem Keyboard w/ Int. Pointing Device USB - Slovenian 234 RoHS v2
7ZB7A05224	ThinkSystem Keyboard w/ Int. Pointing Device USB - Spanish 172 RoHS v2
7ZB7A05225	ThinkSystem Keyboard w/ Int. Pointing Device USB - Swed/Finn 153 RoHS v2
7ZB7A05226	ThinkSystem Keyboard w/ Int. Pointing Device USB - Swiss F/G 150 RoHS v2
7ZB7A05227	ThinkSystem Keyboard w/ Int. Pointing Device USB - Thai 191 RoHS v2
7ZB7A05467	ThinkSystem Keyboard w/ Int. Pointing Device USB - Trad Chinese/US 467 RoHS v2
7ZB7A05228	ThinkSystem Keyboard w/ Int. Pointing Device USB - Turkish 179 RoHS v2
7ZB7A05229	ThinkSystem Keyboard w/ Int. Pointing Device USB - UK Eng 166 RoHS v2
7ZB7A05470	ThinkSystem Keyboard w/ Int. Pointing Device USB - US Eng 103P RoHS v2
7ZB7A05230	ThinkSystem Keyboard w/ Int. Pointing Device USB - US Euro 103P RoHS v2
ThinkSystem Digital and Analog KVM Console switches and cables	
1754D1T	ThinkSystem Digital 2x1x16 KVM Switch (DVI video output port)
1754A1T	ThinkSystem Analog 1x8 KVM Switch (DVI video output port)
4X97A11108	ThinkSystem VGA to DVI Conversion Cable
4X97A11109	ThinkSystem Single-USB Conversion Cable for Digital KVM

Part number	Description
4X97A11107	ThinkSystem Dual-USB Conversion Cable for Digital KVM
4X97A11106	ThinkSystem USB Conversion Cable for Analog KVM
GCM and LCM Console switches and cables	
1754D2X	Global 4x2x32 Console Manager (GCM32)
1754D1X	Global 2x2x16 Console Manager (GCM16)
1754A2X	Local 2x16 Console Manager (LCM16)
1754A1X	Local 1x8 Console Manager (LCM8)
43V6147	Single Cable USB Conversion Option (UCO)
39M2895	USB Conversion Option (4 Pack UCO)
46M5383	Virtual Media Conversion Option Gen2 (VCO2)
46M5382	Serial Conversion Option (SCO)

For more information, see the list of Product Guides in the KVM Switches and Consoles category:
<http://lenovopress.com/servers/options/kvm>

Lenovo Financial Services

Lenovo Financial Services reinforces Lenovo's commitment to deliver pioneering products and services that are recognized for their quality, excellence, and trustworthiness. Lenovo Financial Services offers financing solutions and services that complement your technology solution anywhere in the world.

We are dedicated to delivering a positive finance experience for customers like you who want to maximize your purchase power by obtaining the technology you need today, protect against technology obsolescence, and preserve your capital for other uses.

We work with businesses, non-profit organizations, governments and educational institutions to finance their entire technology solution. We focus on making it easy to do business with us. Our highly experienced team of finance professionals operates in a work culture that emphasizes the importance of providing outstanding customer service. Our systems, processes and flexible policies support our goal of providing customers with a positive experience.

We finance your entire solution. Unlike others, we allow you to bundle everything you need from hardware and software to service contracts, installation costs, training fees, and sales tax. If you decide weeks or months later to add to your solution, we can consolidate everything into a single invoice.

Our Premier Client services provide large accounts with special handling services to ensure these complex transactions are serviced properly. As a premier client, you have a dedicated finance specialist who manages your account through its life, from first invoice through asset return or purchase. This specialist develops an in-depth understanding of your invoice and payment requirements. For you, this dedication provides a high-quality, easy, and positive financing experience.

For your region specific offers please ask your Lenovo sales representative or your technology provider about the use of Lenovo Financial Services. For more information, see the following Lenovo website:

<https://www.lenovo.com/us/en/landingpage/lenovo-financial-services/>

Related publications and links

For more information, see these resources:

- Lenovo ThinkSystem SR635 product page:
<https://www.lenovo.com/us/en/data-center/servers/racks/ThinkSystem-SR635-Server/p/77XX7SRSR35>
- Interactive 3D Tour of the ThinkSystem SR635:
<https://lenovopress.com/lp1182>
- Lenovo Press video walk-through of the ThinkSystem SR635:
<https://lenovopress.com/lp1184>
- ThinkSystem SR635 drivers and support
<http://datacentersupport.lenovo.com/products/servers/thinksystem/sr635/7y99/downloads>
- Lenovo ThinkSystem SR635 product publications:
<http://thinksystem.lenovofiles.com/help/index.jsp>
 - Quick Start
 - Rack Installation Guide
 - Setup Guide
 - Hardware Maintenance Manual
 - Messages and Codes Reference
 - Memory Population Reference
- ServerProven hardware compatibility:
<http://www.lenovo.com/us/en/serverproven>

Related product families

Product families related to this document are the following:

- [1-Socket Rack Servers](#)
- [ThinkSystem SR635 Server](#)

Notices

Lenovo may not offer the products, services, or features discussed in this document in all countries. Consult your local Lenovo representative for information on the products and services currently available in your area. Any reference to a Lenovo product, program, or service is not intended to state or imply that only that Lenovo product, program, or service may be used. Any functionally equivalent product, program, or service that does not infringe any Lenovo intellectual property right may be used instead. However, it is the user's responsibility to evaluate and verify the operation of any other product, program, or service. Lenovo may have patents or pending patent applications covering subject matter described in this document. The furnishing of this document does not give you any license to these patents. You can send license inquiries, in writing, to:

Lenovo (United States), Inc.
1009 Think Place - Building One
Morrisville, NC 27560
U.S.A.
Attention: Lenovo Director of Licensing

LENOVO PROVIDES THIS PUBLICATION "AS IS" WITHOUT WARRANTY OF ANY KIND, EITHER EXPRESS OR IMPLIED, INCLUDING, BUT NOT LIMITED TO, THE IMPLIED WARRANTIES OF NON-INFRINGEMENT, MERCHANTABILITY OR FITNESS FOR A PARTICULAR PURPOSE. Some jurisdictions do not allow disclaimer of express or implied warranties in certain transactions, therefore, this statement may not apply to you.

This information could include technical inaccuracies or typographical errors. Changes are periodically made to the information herein; these changes will be incorporated in new editions of the publication. Lenovo may make improvements and/or changes in the product(s) and/or the program(s) described in this publication at any time without notice.

The products described in this document are not intended for use in implantation or other life support applications where malfunction may result in injury or death to persons. The information contained in this document does not affect or change Lenovo product specifications or warranties. Nothing in this document shall operate as an express or implied license or indemnity under the intellectual property rights of Lenovo or third parties. All information contained in this document was obtained in specific environments and is presented as an illustration. The result obtained in other operating environments may vary. Lenovo may use or distribute any of the information you supply in any way it believes appropriate without incurring any obligation to you.

Any references in this publication to non-Lenovo Web sites are provided for convenience only and do not in any manner serve as an endorsement of those Web sites. The materials at those Web sites are not part of the materials for this Lenovo product, and use of those Web sites is at your own risk. Any performance data contained herein was determined in a controlled environment. Therefore, the result obtained in other operating environments may vary significantly. Some measurements may have been made on development-level systems and there is no guarantee that these measurements will be the same on generally available systems. Furthermore, some measurements may have been estimated through extrapolation. Actual results may vary. Users of this document should verify the applicable data for their specific environment.

© Copyright Lenovo 2019. All rights reserved.

This document, LP1160, was created or updated on August 20, 2019.

Send us your comments in one of the following ways:

- Use the online Contact us review form found at:
<http://lenovopress.com/LP1160>
- Send your comments in an e-mail to:
comments@lenovopress.com

This document is available online at <http://lenovopress.com/LP1160>.

Trademarks

Lenovo and the Lenovo logo are trademarks or registered trademarks of Lenovo in the United States, other countries, or both. A current list of Lenovo trademarks is available on the Web at <https://www.lenovo.com/us/en/legal/copytrade/>.

The following terms are trademarks of Lenovo in the United States, other countries, or both:

AnyBay®
Bootable Media Creator
Lenovo Services
Lenovo®
RackSwitch
ServerProven®
ThinkSystem
TopSeller
TruDDR4
XClarity®

The following terms are trademarks of other companies:

Intel® is a trademark or registered trademark of Intel Corporation or its subsidiaries in the United States and other countries.

Linux® is a trademark of Linus Torvalds in the United States, other countries, or both.

ActiveX®, Microsoft®, Windows Server®, and Windows® are trademarks of Microsoft Corporation in the United States, other countries, or both.

Other company, product, or service names may be trademarks or service marks of others.