

# USER MANUAL

# *ProLite*

## Touch Computer

ENGLISH

### *ProLite T2234AS*

Thank you very much for choosing the iiyama Touch Computer

We recommend that you take a few minutes to read this comprehensive manual carefully before installing and switching on the Touch Computer. Please keep this manual in a safe place for your future reference.



**Dear user, we congratulate you on the purchase of your iiyama LCD.**

For details on warranty and locally used pixel policies that apply directly after installation of your product please check the iiyama website.

**To report a fault, please contact your local support centre found at [www.iiyama.com/service](http://www.iiyama.com/service)**

**Things to check before you call the iiyama information line**

- | if the power cable is connected securely and turned on?
- | if the display has been turned on?
- | if the signal cable is connected securely and the correct input selected?
- | if the computer has been restarted with the display connected?
- | if the graphics card is correctly installed with the latest drivers possible?
- | if the correct native resolution has been selected via 'Display Properties'?
- | If the R/G/B signal configuration is correct?
- | if the displays On Screen Menu is shown?
- | if the correct brightness and contrast settings have been set?
- | if given display tolerances and compatibility have been considered?
- | if via the On Screen Menu you have performed a Factory Reset/Recall?

**Before reporting the screen defect, please prepare the following information/evidence:**

- | model number \*
- | purchase receipt and serial number \*
- | name and address for collection
- | telephone/fax number, for availability during the day
- | convenient collection date (date, time)
- | short description of the defect

**Important Note:**

If there is no fault found in the collected equipment after inspection, the transferring party shall incur charges for transport and administration.

If you have checked all of the above and there is still no picture, call our information line for assistance in your country.

\* see the identification plate on the back of the case.

## CE MARKING DECLARATION OF CONFORMITY

This Touch Computer complies with the requirements of the EC/EU Directive 2014/30/EU “EMC Directive”, 2014/35/EU “Low Voltage Directive”, 2009/125/EC “ErP Directive” and 2011/65/EU “RoHS Directive”.

### Warning

This is a class A product. In a domestic environment this product may cause radio interference in which case the user may be required to take adequate measures.

IYYAMA CORPORATION: Wijkmeerstraat 8, 2131 HA Hoofddorp, The Netherlands

Model No. : PL2234A

This product is to be supplied by a UL Listed ITE power supply rated output +12Vdc, 4A minimum (complied with LPS) with Manufacturers recommended ambient not above 40 degree C and altitude not over 3048m.



We recommend recycling of used product. Please contact your dealer or iiyama service center. Recycle information is obtained via the Internet, using the address: <http://www.iiyama.com>

You can access the Web page of different countries from there.

- We reserve the right to change specifications without notice.
- All trademarks used in this user manual are the property of their respective owners.

# TABLE OF CONTENTS

FOR YOUR SAFETY.....	1
SAFETY PRECAUTIONS.....	1
SPECIAL NOTES ON LCD SCREEN .....	3
CUSTOMER SERVICE .....	3
CLEANING .....	3
BEFORE YOU OPERATE THE TOUCH COMPUTER.....	4
FEATURES.....	4
CHECKING THE CONTENTS OF THE PACKAGE .....	4
WALL MOUNTING .....	5
BUILT-IN EQUIPMENT.....	5
SPECIAL NOTES ON TOUCH PANEL.....	5
CONTROLS AND CONNECTORS.....	6
CONNECTING YOUR TOUCH COMPUTER.....	7
ADJUSTING THE VIEWING ANGLE .....	9
OPERATING THE TOUCH COMPUTER .....	10
TROUBLE SHOOTING .....	12
RECYCLING INFORMATION.....	12
APPENDIX .....	13
SPECIFICATIONS : ProLite T2234AS .....	13
DIMENSIONS.....	14

# FOR YOUR SAFETY

## SAFETY PRECAUTIONS

### WARNING

#### **STOP OPERATING THE TOUCH COMPUTER WHEN YOU SENSE TROUBLE**

If you notice any abnormal phenomena such as smoke, strange sounds or fumes, unplug the Touch Computer and contact your dealer or iiyama service center immediately. Further use may be dangerous and can cause fire or electric shock.

#### **NEVER REMOVE THE CABINET**

High voltage circuits are inside the Touch Computer. Removing the cabinet may expose you to the danger of fire or electric shock.

#### **DO NOT PUT ANY OBJECT INTO THE TOUCH COMPUTER**

Do not put any solid objects or liquids such as water into the Touch Computer. In case of an accident, unplug your Touch Computer immediately and contact your dealer or iiyama service center. Using the Touch Computer with any object inside may cause fire, electric shock or damage.

#### **INSTALL THE TOUCH COMPUTER ON A FLAT, STABLE SURFACE**

The Touch Computer may cause an injury if it falls or is dropped.

#### **DO NOT USE THE TOUCH COMPUTER NEAR WATER**

Do not use where water may be splashed or spilled onto the Touch Computer as it may cause fire or electric shock.

#### **OPERATE UNDER THE SPECIFIED POWER SUPPLY**

Be sure to operate the Touch Computer only with the specified power supply. Use of an incorrect voltage will cause malfunction and may cause fire or electric shock.

#### **CORRECT USE OF THE AC ADAPTER**

Use only the AC Adapter provided by iiyama. Any deviation from this by using another type of adapter may result in damage to the accessory and the Touch Computer by fire or electric shock.

#### **DO NOT DISASSEMBLE THE AC ADAPTER**

Disassembling the AC Adapter may expose you to the danger of fire or electric shock.

#### **PROTECT THE CABLES**

Do not pull or bend the AC adapter, the power cable and signal cable. Do not place the Touch Computer or any other heavy objects on the cables. If damaged, the cables may cause fire or electric shock.

#### **ADVERSE WEATHER CONDITIONS**

It is advisable not to operate the Touch Computer during a heavy thunder storm as the continual breaks in power may cause malfunction. It is also advised not to touch the plug in these circumstances as it may cause electric shock.

## CAUTION

### INSTALLATION LOCATION

Do not install the Touch Computer where sudden temperature changes may occur, or in humid, dusty or smoky areas as it may cause fire, electric shock or damage. You should also avoid areas where the sun shines directly on the Touch Computer.

### DO NOT PLACE THE TOUCH COMPUTER IN A HAZARDOUS POSITION

The Touch Computer may topple and cause injury if not suitably located. Please also ensure that you do not place any heavy objects on the Touch Computer, and that all cables are routed such that children may not pull the cables and possibly cause injury.

### MAINTAIN GOOD VENTILATION

Ventilation slots are provided to keep the Touch Computer from overheating. Covering the slots may cause fire. To allow adequate air circulation, place the Touch Computer at least 10 cm (or 4 inches) from any walls.

Do not remove the tilt stand when operating the Touch Computer. Ventilation slots on the back of the cabinet will be blocked and the Touch Computer may overheat if the stand is removed. This may cause fire or damage. Operating the Touch Computer on its back, side, upside down or on a carpet or any other soft material may also cause damage.

### DISCONNECT THE CABLES WHEN YOU MOVE THE TOUCH COMPUTER

When you move the Touch Computer, turn off the power switch, unplug the Touch Computer and be sure the signal cable is disconnected. If you do not disconnect them, it may cause fire or electric shock.

### UNPLUG THE TOUCH COMPUTER

If the Touch Computer is not in use for a long period of time it is recommended that it is left unplugged to avoid accidents.

### HOLD THE PLUG WHEN DISCONNECTING

To disconnect the AC adapter, the power cable or signal cable, always pull it by the plug. Never pull on the cable itself as this may cause fire or electric shock.

### DO NOT TOUCH THE PLUG WITH WET HANDS

Pulling or inserting the plug with wet hands may cause electric shock.

### CARE TO A HAND AND FINGERS!

Careful attention is required not to catch your fingers or hands when you change the angle.

### REMARK FOR 24/7 USAGE

This product is not specifically designed for 24/7 usage in all environments.

### BATTERY NOTICE CAUTION

The product has a built-in lithium battery. Risk of explosion if battery is replaced by an incorrect type. If you need to replace the battery, contact your dealer or iiyama service center.

## OTHERS

### ERGONOMIC RECOMMENDATIONS

To eliminate eye fatigue, do not operate the Touch Computer against a bright background or in a dark room. For optimal viewing comfort, the Touch Computer should be just below eye level and 40-60 cm (16-24 inches) away from your eyes. When using the Touch Computer over a prolonged time, a ten minute break every hour is recommended as looking at the screen continuously can cause eye strain.

## SPECIAL NOTES ON LCD SCREEN

The following symptoms are normal with LCD screen and do not indicate a problem.

### NOTE

- You may find slightly uneven brightness on the screen depending on the desktop pattern you use.
- Due to the nature of the LCD screen, an afterimage of the previous screen may remain after switching the image, when the same image is displayed for hours. In this case, the screen is recovered slowly by changing the image or turning off the Power Switch for some hours.

## CUSTOMER SERVICE

### NOTE

- If you have to return your unit for service and the original packaging has been discarded, please contact your dealer or iiyama service center for advice or replacement packaging.

## CLEANING

### WARNING

- If you drop any materials or liquids such as water into the Touch Computer when cleaning, unplug the power cable immediately and contact your dealer or iiyama service center.

### NOTE

- To protect the Touch screen surface, do not scratch or rub the screen with a hard object.
- Never use any of the following strong solvents. These will damage the cabinet and the Touch screen surface.  
Abrasive cleaner Wax Solvent
- Touching the cabinet with any product made from rubber or plastic for a long time may cause degeneration or loss of paint on the cabinet.

### CABINET

Stains can be removed with a cloth lightly moistened with a mild detergent solvent. Then wipe the cabinet with a soft dry cloth.

### TOUCH SCREEN

Touch screen surface may be cleaned using a soft clean cloth moistened with mild window glass commercial cleaners or 50/50 mixture of water and IPA(ISO-propyl-alcohol). Don't use acid or alkaline solvent to clean the surface of the panel (or screen).

# BEFORE YOU OPERATE THE TOUCH COMPUTER

## FEATURES

- ◆ Supports Resolutions up to 1920 × 1080
- ◆ High Contrast 1000:1 (Typical) / Brightness 350cd/m<sup>2</sup> (Typical)
- ◆ Digital Character Smoothing
- ◆ Automatic Set-up
- ◆ Stereo Speakers  
2 × 2W Stereo Speakers
- ◆ Plug & Play VESA DDC2B Compliant  
Windows<sup>®</sup> XP/Vista/7/8/8.1/10 Compliant
- ◆ Supports Android OS
- ◆ Power Management (VESA DPMS Compliant)
- ◆ VESA Mounting Standard (100mm×100mm) Compliant
- ◆ IP65 Standard Compliant (Only front face)
- ◆ Anti fingerprint finish

## CHECKING THE CONTENTS OF THE PACKAGE

The following accessories are included in your package. Check to see if they are enclosed with the Touch Computer. If anything is missing or damaged, please contact your local iiyama dealer or regional iiyama office.

- |                |                |                     |
|----------------|----------------|---------------------|
| ■ Power Cable* | ■ AC Adapter*  | ■ Screw (M3x6mm)    |
| ■ Option Parts | ■ Safety Guide | ■ Quick Start Guide |

### CAUTION

#### \* 1. TO USERS IN 120V AREA

The rating of the Power Cable enclosed in 120V area is 10A/125V. If you are using a power supply higher than this rating, then a power cable with a rating of 10A/250V must be used. However, all guarantees and warranties are void for any problems or damage caused by a power cable or AC adapter not supplied by iiyama.

#### 2. Applicable AC Adapter

AC Adapter Type Name : ADP-50YH B (DELTA ELECTRONICS, INC.)

#### 3. An approved power cable greater or equal to H05VVF, 3G, 0.75mm<sup>2</sup> must be used.



## WALL MOUNTING

**WARNING** When you use with the wall mounting, in consideration of thickness of the mounting stage, tighten the M4 Screw with washer which “L” length is 5.5mm to fasten the Touch Computer. Using the screw longer than this may cause electric shock or damage because it may contact with the electrical parts inside the Touch Computer.

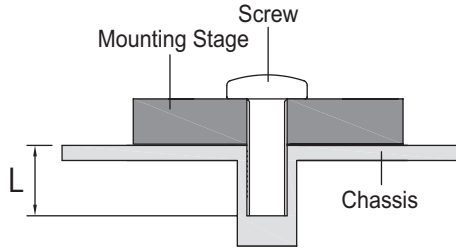

## BUILT-IN EQUIPMENT

**WARNING** This product is not designed for the purpose of being used in high temperature environment.  
If the product is placed in an external cabinet, you need to design cooling fans and vents to keep the temperature low enough to fit in the product temperature specification.

## SPECIAL NOTES ON TOUCH PANEL

**CAUTION** Permanent damage can occur if Sharp Edged, Pointed or Metal items are used to activate Touch.  
This could invalidate any remaining warranty.  
We recommend you use a plastic stylus (tip R0.8 or over) or finger.

## CONTROLS AND CONNECTORS

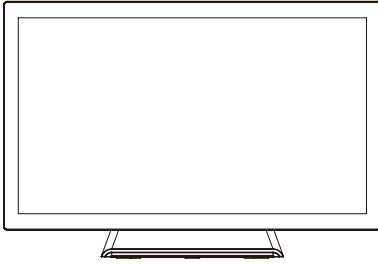

<Front>

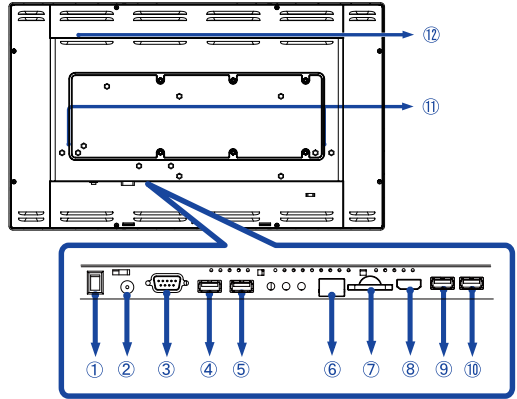

<Back>

- ① Power Switch (I (ON) / O (OFF))
- ② Connector for AC Adapter(⎓ : Direct current) (DC)
- ③ RS232C Connector
- ④ USB Connector (USB)
- ⑤ USB Connector (USB)
- ⑥ RJ45 Connector
- ⑦ SD slot
- ⑧ HDMI output Connector (HDMI)
- ⑨ USB Connector (USB for OTG)
- ⑩ USB Connector (USB)
- ⑪ Speakers
- ⑫ Option Port

## CONNECTING YOUR TOUCH COMPUTER

- ① Ensure that the Touch Computer is switched off.
- ② Connect the AC Adapter to the Touch Computer and the Power Cable to the AC Adapter first and then connect to the power source.
- ③ Turn on your Touch Computer.

### NOTE

- The Class I pluggable equipment Type A must be connected to protective earth.
- The socket-outlet shall be installed near the equipment and shall be easily accessible.
- The initial setup of the operating system takes approximately 5-10 minutes.
- To setup the Android OS for the touch computer, turn on the touch computer and follow the instructions on the screen.

[Example of Connection]

<Back>

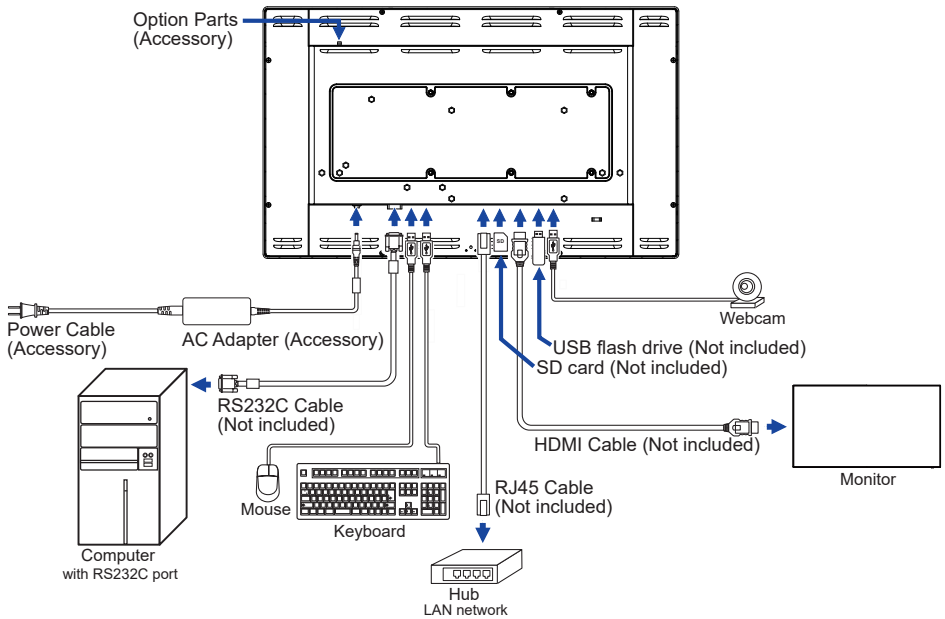

### [Fitting and Removal of Cable Cover]

Put a piece of soft cloth on the table beforehand to prevent the Touch Computer from being scratched. Lay the Touch Computer flat on a table with front face down.

#### < Removal >

- ① Move the stand into position as shown in Step1.
- ② Remove the cable cover as shown in Step2.

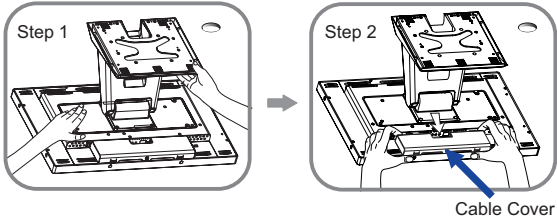

#### < Fitting >

- ① As shown in Step3, connect the cables and put those through the cable holes.
- ② As shown in Step4, place the cable cover and fix it firmly using a screw.

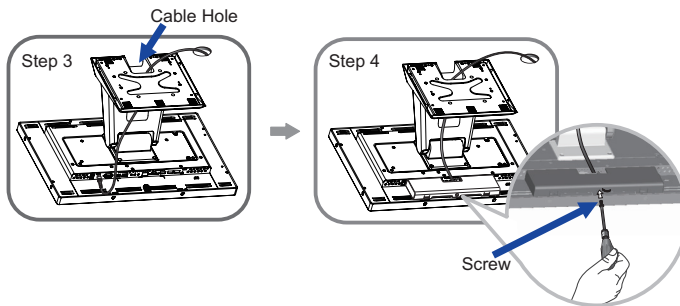

### [Collect Cables]

Put the cables through the cable hole to bundle them.

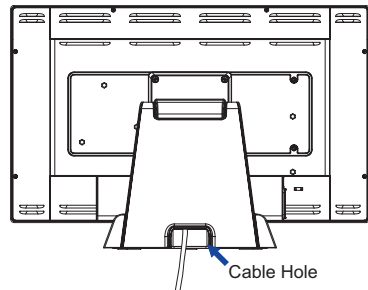

## ADJUSTING THE VIEWING ANGLE

- For optimal viewing it is recommended to look at the full face of the Touch Computer.
- Hold the panel so that the Touch Computer does not topple when you change the Touch Computer's angle.
- You are able to adjust the Touch Computer's angle up to 90 degrees upward, 5 degrees downward.

- NOTE**
- Do not touch the LCD screen when you change the angle. It may cause damage or break the LCD screen.
  - Careful attention is required not to catch your fingers or hands when you change the angle.

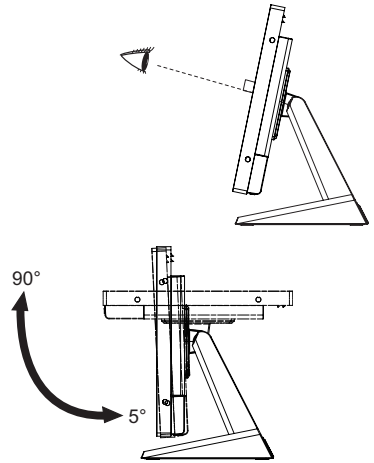

# OPERATING THE TOUCH COMPUTER

The home screen is displayed when the Touch Computer is turned on.

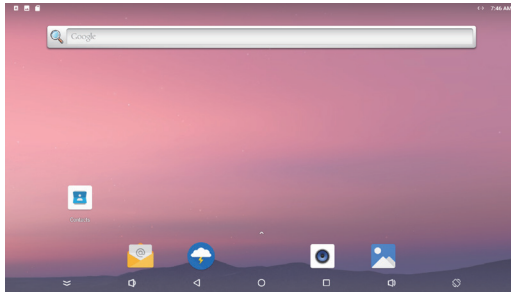





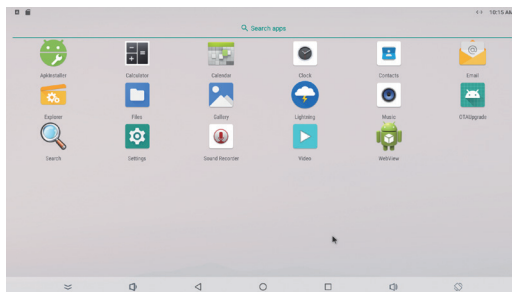











## <System bar icons>

- ⏏ : Hides the system bar of the currently displayed interface and displays it in full screen mode.
- ⏪ : Return to exit and the previous page.
- ⏩ : Return to the home screen.
- ◻ : Show a list of recently run applications.
- 🔊 : Volume up
- 🔇 : Volume down
- 🔄 : The screen rotates.  
The screen rotates 90 ° clockwise each time you click the icon.
- ⌵ : Display all apps.



## <Applications>

-  : Install or uninstall application.
-  : Calculator
-  : Calendar
-  : Clock and alarm
-  : Manage contact information.
-  : Manage emails.
-  : Manage files.
-  : Manage files.
-  : View photo albums.
-  : Access web pages.
-  : Play audio files.
-  : Update the system online.
-  : Search engine
-  : System preferences
-  : Sound recorder
-  : Play video files.
-  : Access web pages.

## TROUBLE SHOOTING

If the Touch Computer fails to operate correctly, please follow the steps below for a possible solution.

1. Perform the adjustments described in OPERATING THE TOUCH COMPUTER, depending on the problem you have. If the Touch Computer does not get a picture, skip to 2.
2. Consult the following items if you cannot find an appropriate adjustment item in OPERATING THE TOUCH COMPUTER or if the problem persists.
3. If you are experiencing a problem which is not described below or you cannot correct the problem, discontinue using the Touch Computer and contact your dealer or iiyama service center for further assistance.

<b>Problem</b>	<b>Check</b>
① The picture does not appear.	<input type="checkbox"/> The AC Adapter is firmly seated in the connector. <input type="checkbox"/> The Power Cable is firmly seated in the socket of the AC Adapter. <input type="checkbox"/> The Power Cable is firmly seated in the socket. <input type="checkbox"/> The Power Switch is turned ON. <input type="checkbox"/> The AC socket is live. Please check with another piece of equipment. <input type="checkbox"/> The pins of the connectors are not crooked or broken.
② The screen is shaking.	<input type="checkbox"/> The power voltage is within the specification of the Touch Computer.
③ No sound.	<input type="checkbox"/> The Volume is turned up. <input type="checkbox"/> The Mute is OFF.
④ The touch screen does not work.	<input type="checkbox"/> It takes about 15 seconds or more to activate the P-CAP touch screen function after power is turned off and on. This is normal operation. Please wait for a certain period.

## RECYCLING INFORMATION

For better environment protection please don't dispose your Touch Computer.  
 Please visit our web site: [www.iiyama.com](http://www.iiyama.com) for Touch Computer recycling.



# APPENDIX

Design and specifications are subject to change without prior notice.

## SPECIFICATIONS : ProLite T2234AS

Touch Screen	Technology	Projected capacitive 10pt touch
	Light transmission	87%
	Hardness	7H
	Thickness	2.5mm
	Surface finish	Anti fingerprint coating
Size Category		22"
LCD Panel	Panel technology	IPS
	Size	Diagonal: 21.5" (55cm)
	Pixel pitch	0.247mm H × 0.247mm V
	Brightness	350cd/m <sup>2</sup> (Typical), 305cd/m <sup>2</sup> (with Touch panel)
	Contrast ratio	1000 : 1 (Typical: with Touch panel)
	Viewable angle	Horizontal : 178 degrees, Vertical: 178 degrees (Typical)
	Response time	>8ms (Gray to Gray)
Display Colors		Approx. 16.7M
CPU		Rockchip RK3288, Quad-core Cortex-A17 up to 1.8GHz
GPU		Mali-T760 MP4
Storage		16GB eMMC
Memory		2GB DDR3
Graphics		LVDS × 1 Resolution: 1920 × 1080 P-60
Maximum Resolution		1920 × 1080, 2.1 MegaPixels
External IO Port		SD × 1, LAN × 1, HDMI(output) × 1, RS232C(output) × 1, USB2.0 × 3, USB2.0(for OTG) × 1, Option Port × 1
OS version		Android 8.1 without GMS
Plug & Play		VESA DDC2B™
Speakers		2W × 2 (Stereo speakers)
Maximum Screen Size		476.6mm W × 268.1mm H / 18.8" W × 10.6" H
Power Source		12VDC, 4A
AC Adapter (accessory)		Input: 100-240VAC, 50/60Hz
Power Consumption* <sup>1</sup>		25W typical, Power management mode: 0.5W maximum
Dimensions / Net Weight		517.5 × 351.5 × 219.0mm / 20.4 × 13.8 × 8.6" (W×H×D) 6.6kg / 14.5lbs (Excluding the AC Adapter)
Tilt Angle		Upward: 90 degrees Downward: 5 degrees
Environmental Considerations		Operating: Temperature 0 to 40°C / 32 to 104°F Humidity 20 to 80% (No condensation) Storage: Temperature -20 to 60°C / -4 to 140°F Humidity 10 to 90% (No condensation)
Approvals		CE, cULus, CCC, CU, IP65* <sup>2</sup>

**NOTE** \*<sup>1</sup> USB peripherals is not connected.

\*<sup>2</sup> IP65 Standard Compliant : Only front face

# DIMENSIONS

ENGLISH

