

# **GIGABYTE™**

## **GSM Server**

### Installation and Configuration Guide

Rev. 1.2

## **Copyright**

© 2021 GIGA-BYTE TECHNOLOGY CO., LTD. All rights reserved.

The trademarks mentioned in this manual are legally registered to their respective owners.

## **Disclaimer**

Information in this manual is protected by copyright laws and is the property of GIGABYTE. Changes to the specifications and features in this manual may be made by GIGABYTE without prior notice. No part of this manual may be reproduced, copied, translated, transmitted, or published in any form or by any means without GIGABYTE's prior written permission.

## **Documentation Classifications**

In order to assist in the use of this product, GIGABYTE provides the following types of documentation:

- User Manual: detailed information & steps about the installation, configuration and use of this product (e.g. motherboard, server barebones), covering hardware and BIOS.
- User Guide: detailed information about the installation & use of an add-on hardware or software component (e.g. BMC firmware, rail-kit) compatible with this product.
- Quick Installation Guide: a short guide with visual diagrams that you can reference easily for installation purposes of this product (e.g. motherboard, server barebones).

Please see the support section of the online product page to check the current availability of these documents.

## **For More Information**

For related product specifications, the latest firmware and software, and other information please visit our website at <http://www.gigabyte.com>

For GIGABYTE distributors and resellers, additional sales & marketing materials are available from our reseller portal: <http://reseller.b2b.gigabyte.com>

For further technical assistance, please contact your GIGABYTE representative or visit <https://esupport.gigabyte.com/> to create a new support ticket

For any general sales or marketing enquiries, you may also message GIGABYTE server directly by email: [server.grp@gigabyte.com](mailto:server.grp@gigabyte.com)

# Table of Contents

Chapter 1 GSM Server Overview .....	5
1-1 GSM (GIGABYTE Server Management) Software Package Overview .....	5
Chapter 2 GSM Server Installation .....	7
2-1 Using GSM Server .....	7
2-2 Hardware Requirements .....	7
2-3 Software Requirements.....	7
2-3-1 Prerequisites for remote management server .....	7
2-4 Installing GSM Server (Windows) .....	8
2-4-1 Installation Procedure.....	8
2-4-2 Getting Started .....	10
2-5 Installing GSM Server (Linux) .....	11
2-5-1 Install/Un-install Steps for Ubuntu, Debian (Login as root).....	11
2-5-2 Install/Un-install Steps for CentOS 7, RHEL, Fedora (Login as root) .....	12
Chapter 3 Using GSM Server.....	13
3-1 Overview .....	13
3-1-1 GSM Server Setup Wizard .....	14
3-2 Enter GSM Server.....	18
3-3 System Manager.....	20
3-3-1 Information.....	22
3-3-2 Monitoring.....	23
3-3-3 Remote Access.....	24
3-3-4 Network Configuration .....	28
3-3-5 Event Log .....	29
3-3-6 Alert Management .....	30
3-3-7 Updates .....	31
3-3-8 Power Consumption .....	32
3-3-9 SOL Terminal.....	33
3-3-10 Software .....	34
3-3-11 Remote BIOS Setup .....	35
3-4 Group Manager.....	36
3-4-1 Information.....	38
3-4-2 Remote Access.....	39
3-4-3 Updates .....	41
3-4-4 Event Log .....	42
3-4-5 Power Consumption .....	43
3-4-6 Network Configuration .....	44

3-4-7	Alert Management .....	44
3-5	Deployment .....	45
3-6	Alert.....	46
3-7	Account .....	47
3-8	Preference.....	50
3-8-1	IP Range.....	51
3-8-2	Event Log .....	52
3-8-3	Alert Management .....	53
3-8-4	Database .....	55
3-8-5	Properties .....	56
3-8-6	Gbt Interactive Utility .....	57
3-8-7	Update .....	58
3-8-8	Language.....	58
3-9	Help.....	59
3-10	Logout .....	60
Chapter 5	Appendix .....	61
5-1	Event Log List .....	61

# Chapter 1 GSM Server Overview

## 1-1 GSM (GIGABYTE Server Management) Software Package Overview

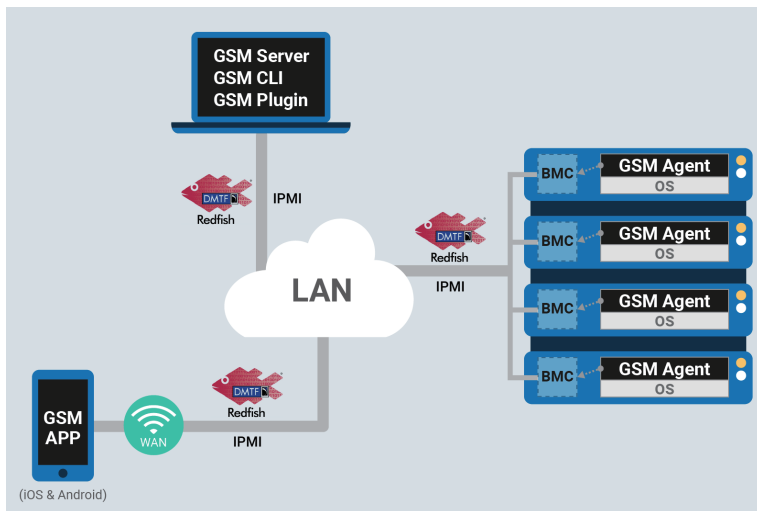

**GSM (GIGABYTE Server Management)** is GIGABYTE's proprietary multiple server remote management software platform. GSM is compatible with either IPMI or Redfish (RESTful API) connection interfaces, and comprises the following

**GSM Server**, a software program with an easy to use browser-based GUI to enable global remote monitoring and management of multiple GIGABYTE servers via each server node's BMC.

**GSM CLI (GBT Utility)**, a command-line interface program to enable global remote monitoring and management of multiple GIGABYTE servers via each server node's BMC.

**GSM Agent**, a software program installed locally on each GIGABYTE server node that retrieves additional node information (CPU/Mem/HDD/PCI/...) from the OS and passes it to the BMC. This information can then be utilized by GSM Server or GSM CLI.

**GSM Mobile**, a remote server management mobile APP, available for both Android and iOS.

**GSM Plugin**, a plugin available for VMware's vCenter, allowing the user to perform remote

monitoring and management of GIGABYTE server nodes without having to switch to a separate software platform.

A logical diagram of these different software sub-programs can be seen below:

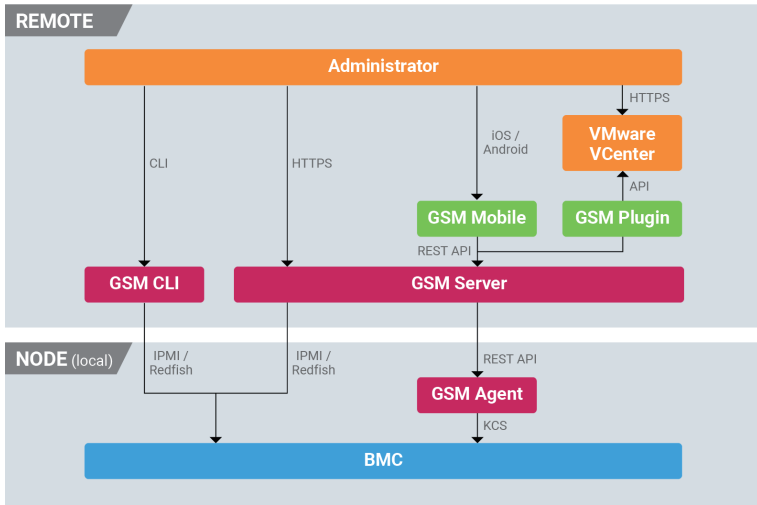

Each sub-program is available to download for free from each GIGABYTE server product page\*.  
\*Depending on product compatibility, some programs may not be available. Please download GSM Mobile from the Google (Android) or iOS Store.

## Chapter 2 GSM Server Installation

### 2-1 Using GSM Server

GSM (Gigabyte Server management) Server has a user-friendly Graphics User Interface (GUI) called the GSM Server GUI. It is designed to be easy to use. It has a low learning curve because it uses a standard Internet browser. You can expect to be up and running in less than five minutes. This chapter allows you to become familiar with the GSM Server GUI's various functions. Each function is described in detail.

### 2-2 Hardware Requirements

Before using GSM Server, please check your system for the following required configuration requirements:

- System Processor: 2 GHz and above
- System Memory: Minimum 4 GB RAM
- Free Disk Space: 1000 GB at least
- Node servers : 255 maximum

### 2-3 Software Requirements

#### 2-3-1 Prerequisites for remote management server

##### Supported Browsers:

- Google Chrome 39.0.2171.65 m or later
- Mozilla Firefox 33.1.1

##### Operating System:

- Windows 2008 / 2012 R2 / 2019
- Ubuntu 16.04 or later
- Redhat/CentOS 6.3 or later

## 2-4 Installing GSM Server (Windows)

### 2-4-1 Installation Procedure

1. Unzip the file and run **GSM\_Setup.exe**.
2. Then, a series of installation wizards appear.
3. Click **Next**.

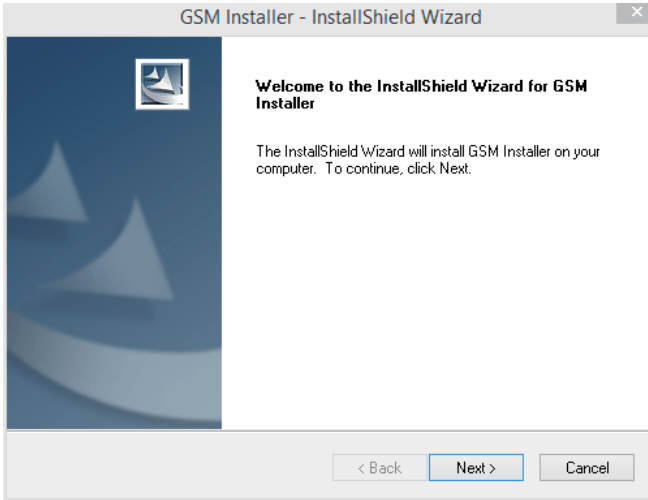

4. Click **Install** to start the installation.

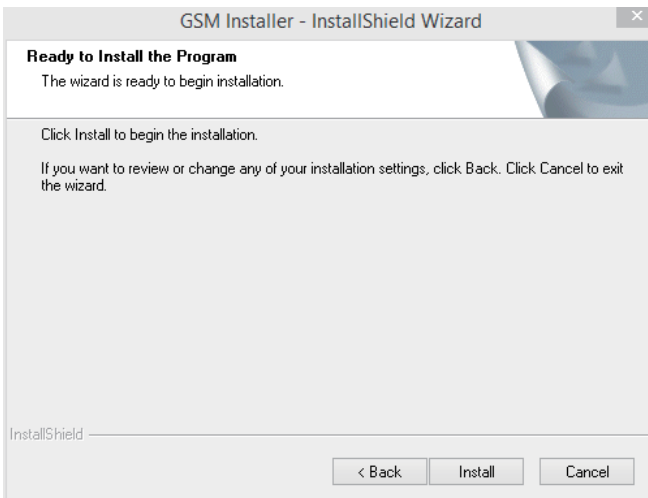



5. Installation completed, click **Finish**.

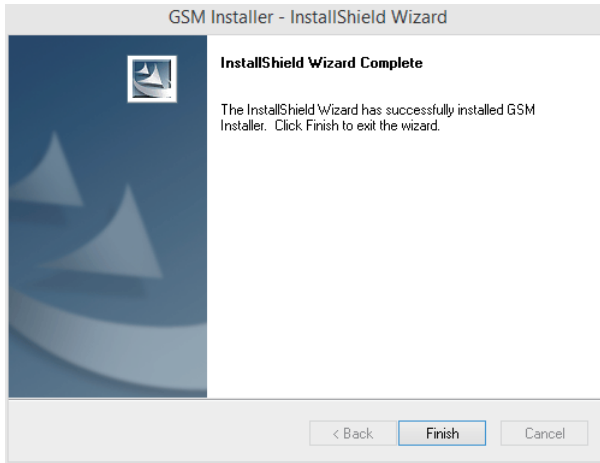

**CAUTION!**

Please make sure you have enough space on your hard drive for the program.

## 2-4-2 Getting Started

1. Open a browser and type in your identified IP. The IP address can be found using your DHCP server.

Local URL: <https://localhost:8443/GSM>

Remote URL: [https://\[Server IP\]:8443/GSM](https://[Server IP]:8443/GSM)

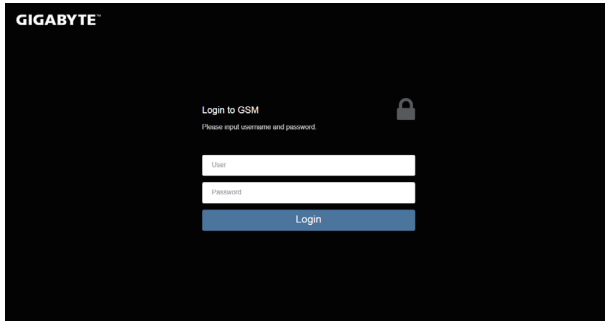

### NOTE!

If you can't connect to the GSM Server, perhaps the firewall blocks the connection, please check the rule settings:

2. 2. If the GSM UI works appropriately after installing the latest version of GSM server, please clear the browser cache data and try again.

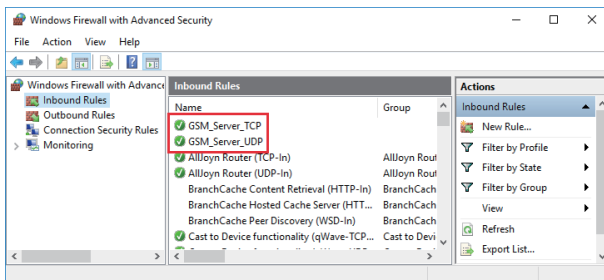

## 2-5 Installing GSM Server (Linux)

### 2-5-1 Install/Un-install Steps for Ubuntu, Debian (Login as root)

1. Before installation, please check the packages `sudo` and `ufw` are already installed. Otherwise, GSM Server installation will fail.

```
#apt-get install sudo ufw
```

2. 2.2 Use deb package to install GSM.

```
#dpkg -i gsm_x.x_all.deb
```

3. Make sure that the package 'fontconfig' has already been installed before starting GSM. Install the package: 'fontconfig'.

```
#apt-get install fontconfig
```

4. Finish and start up GSM web page.

Connect to GSM: `https://{your IP address}:8443/GSM`

5. Uninstall GSM

```
#dpkg -r gsm
```



#### NOTE!

1. Installation will install and place Java sources for GSM to `/opt`. Do not modify and remove them. It's very important.
2. After finishing installation, installer would add firewall exception, such as 8080, 8443, 162, 69 and tftp to public zone. If you do not use public zone as default, please add firewall exception manually.

## 2-5-2 Install/Un-install Steps for CentOS 7, RHEL, Fedora (Login as root)

1. Before installation, please check that packages sudo and firewalld have already been installed, or GSM installation will be failed.

```
#yum install sudo firewalld
```

2. Use RPM package to install GSM.

```
# rpm -ivh gsm-x.x-1.x86_64.rpm
```

3. Make sure that the package 'fontconfig' has already been installed before starting GSM.

Install the package: 'fontconfig'.

```
#yum install fontconfig
```

4. Finish and start up GSM web page

Connect to GSM: <https://{your IP address}:8443/GSM>

5. Uninstall GSM Server

```
#rpm -e gsm-x.x-1.x86_64
```



### NOTE!

1. Installation will install and place Java sources for GSM to /opt. Do not modify and remove them. It's very important.
2. After finishing installation, installer would add firewall exception, such as 8080, 8443, 162, 69 and tftp to public zone. If you do not use public zone as default, please add firewall exception manually.

# Chapter 3 Using GSM Server

## 3-1 Overview

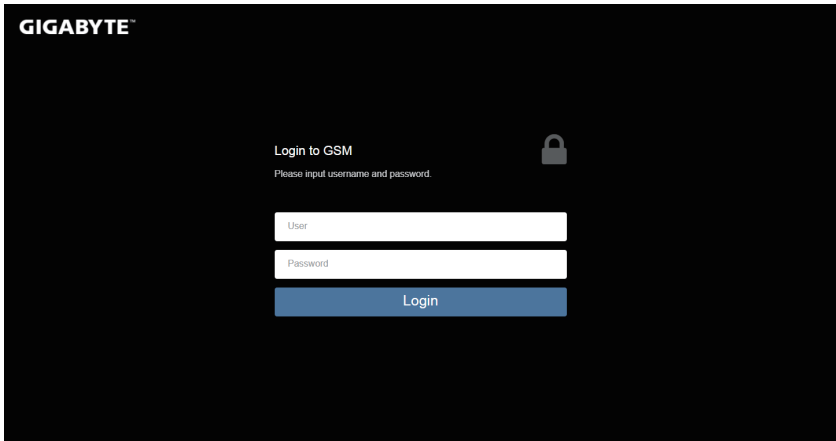

1. Open a web browser and type in your identified IP. The IP address can be found using your DHCP server.
2. Enter the following factory default values:
  - Username: **admin**
  - Password: **password**



- The default user name and password are in lower-case characters.
- When you log in using the root user name and password, you have full administrative powers. It is advised that once you log in, you change the root password.

### 3-1-1 GSM Server Setup Wizard

When you log into your GSM Server management console for the first time, you will be required to configure the basic settings via the setup wizard.

Setup Procedures:

1. Select your preferred language and click **Next**.

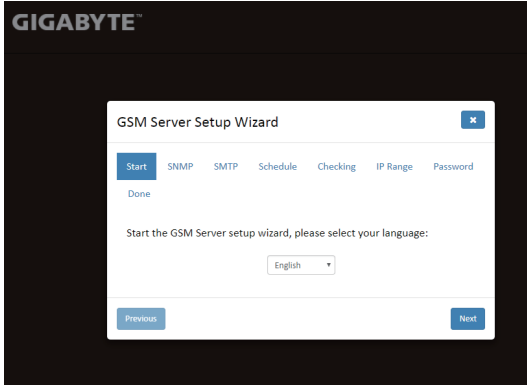

2. Configure the SNMP setting and click **Next**.

A screenshot of the GSM Server Setup Wizard interface, specifically the SMTP configuration step. The window title is "GSM Server Setup Wizard". The progress bar shows "SMTP" as the active step. The main heading is "Set up SMTP configuration to receive the GSM alerts". Under "Setting", there are input fields for "Server Host", "Server Port" (with a default value of "0"), "Account", "Password", and "Email Address". There are checkboxes for "Authentication" and "TLS". Under "Email Address Destination", there is a table with three rows, each with an "Enable" checkbox, an "Email Address" input field, and an "Event Level" dropdown menu (all set to "Unknown"). A note at the bottom states: "\* Note: The ordering of event alert levels is Critical > Non-Critical > Unknown". At the bottom of the form are "Previous" and "Next" buttons.

3. Configure the SMTP setting and click **Next**.

GSM Server Setup Wizard ✕

Start **SNMP** **SMTP** Schedule Checking IP Range Password

Done

Set up SMTP configuration to receive the GSM alerts

**Setting**

Server Host	<input type="text"/>
Server Port	<input type="text" value="0"/>
Account	<input type="text"/>
Password	<input type="text"/>
Email Address	<input type="text"/>
Authentication	<input type="checkbox"/>
TLS	<input type="checkbox"/>

**Email Address Destination**

Enable	Email Address	Event Level
<input type="checkbox"/>	<input type="text"/>	Unknown ▾
<input type="checkbox"/>	<input type="text"/>	Unknown ▾
<input type="checkbox"/>	<input type="text"/>	Unknown ▾

\* Note: The ordering of event alert levels is Critical > Non-Critical > Unknown

[Previous](#) [Next](#)

4. Set the Schedule and click **Next**.

**GIGABYTE**

GSM Server Setup Wizard ✕

Start **SNMP** **SMTP** **Schedule** Checking IP Range Password

Done

Set the background schedule of GSM Server

**Check**

GSM will clean data to make sure system has enough space to store data

Check system in each  hour(s)

**BMC Node Update Setting**

GSM will follow setting to update BMC node during fixed period.

Node quantity     nodes

Node update period    minutes

[Previous](#) [Next](#)

5. Set the check process and click **Next**.

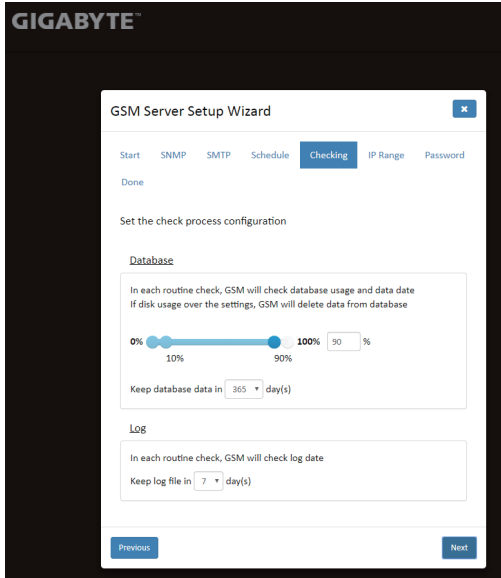

6. Configure the IP range and click **Next**.

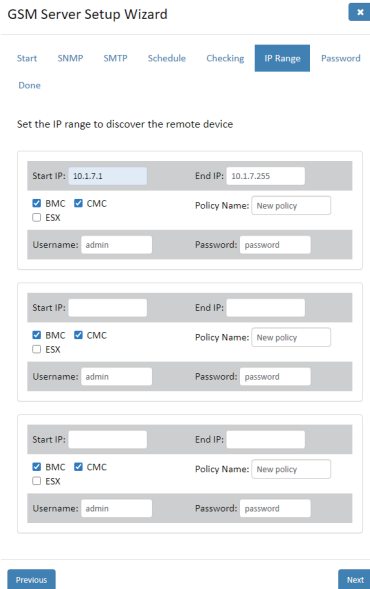



7. Set the password for administrator and click **Next**.

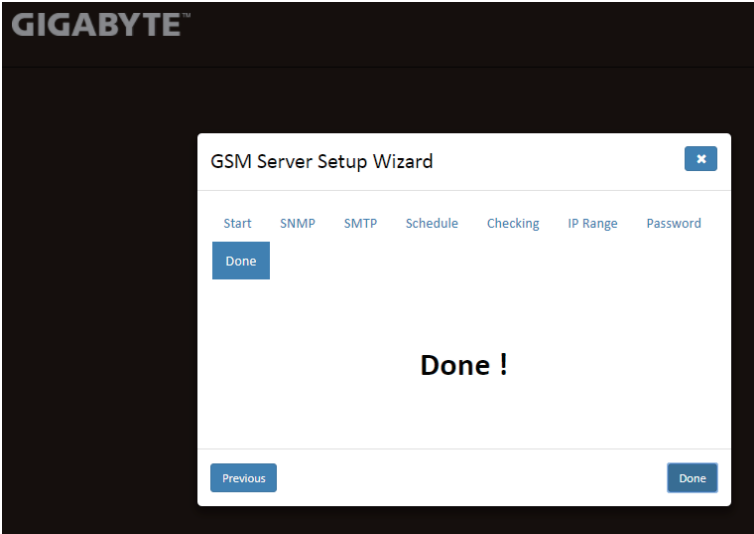

8. Setup completed, click **DONE** to close the wizard.

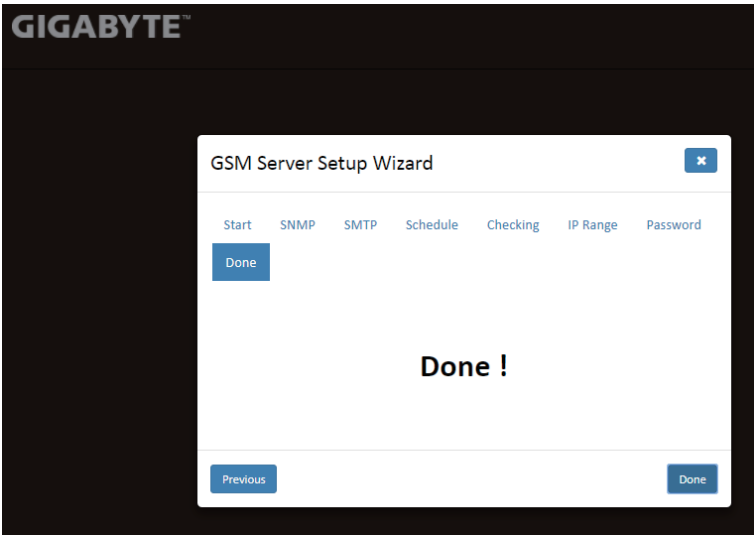

### 3-2 Enter GSM Server

After you successfully log into GSM Server, the Remote Management GUI appears. Click **Node Status image** for advanced configuration.

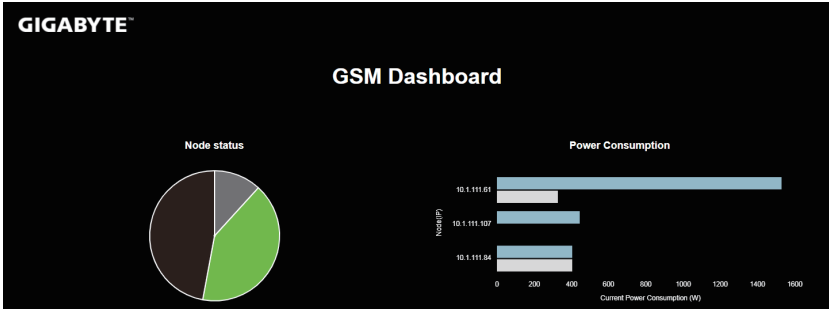

After you entering into your Management Console, the Management Console GUI appears.

Management Console Information shows the general system health status of the current remote node. The node health status will appear on the left side in different colors, the definition of each color is described below:

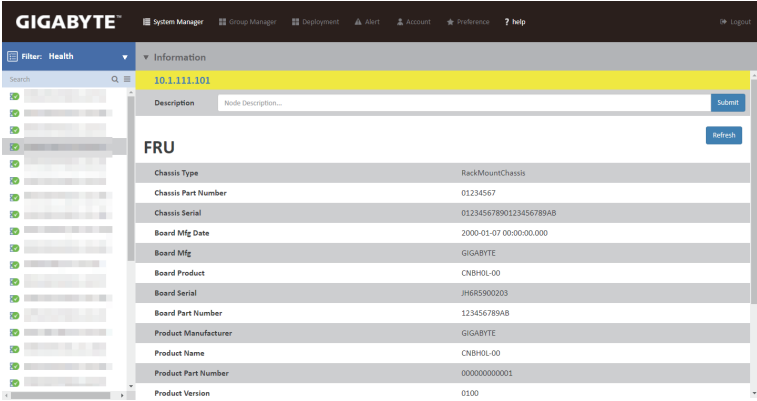

Icon	Decription/Resulting Action
	Normal: All nodes and sensors are normal and there's no sensor that has any alert.
	Warning: There's at least one node/sensor that has warning alert.
	Unknown: There's a non-critical alert or an alert classified as unknown status.
	Critical: There's at least one node/sensor that has a critical alert.
	Not Connected: This indicates the identified node is not connected.

### 3-3 System Manager

System Manager lists all connected node systems. Click the drop-down list to filter and select specific node group.

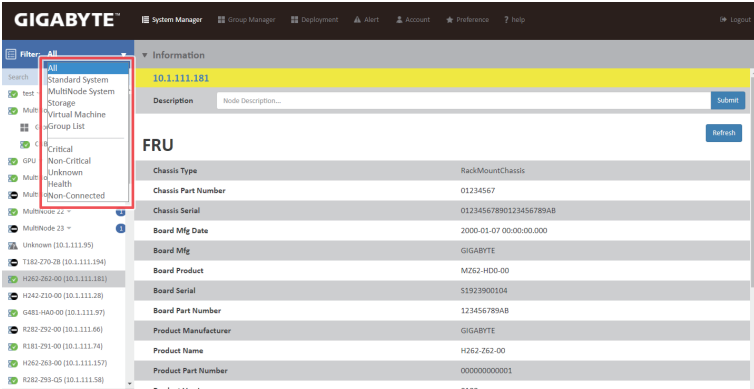

Parameter	Description/Resulting Action
Standard System	Server Node connected via BMC function.
MultiNode System	System Node connected via CMC function.
Storage	Lists JBOD system nodes information.
Virtual Machine	Lists the connected virtual machine information.
Group List	Lists the grouped system node information.
Critical	There's at least one sensor that has a critical alert.
Non-critical	There's at least one sensor that has a warning alert.
Unknown	There's at least one sensor that has a unknown alert.
Health	All sensors are normal and there's no sensor that has any alert.
Non-Connected	There's non system node is connected.

And the click the drop-down list for advanced configuration.

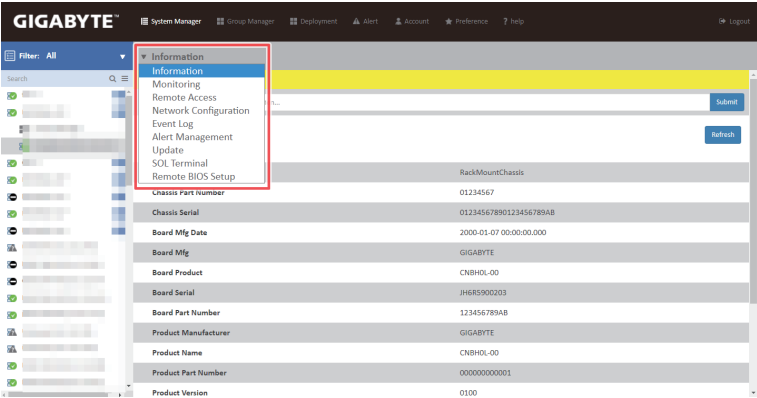

### 3-3-1 Information

The **Information** is a display page for basic system health information, such as FRU information,, Hardware Information, Software Information, and BIOS Information. Items on this window are non-configurable.

Information

Description

**FRU**

Chassis Type	RackMountChassis
Chassis Part Number	01234567
Chassis Serial	01234567890123456789AB
Board Mfg Date	2000-01-07 00:00:00.000
Board Mfg	GIGABYTE
Board Product	M292-F50-00
Board Serial	JG799500047
Board Part Number	123456789AB
Product Manufacturer	GIGABYTE
Product Name	F182-292-00
Product Part Number	00000000001
Product Version	0100
Product Serial	GIG8F8912A0008
Product Asset Tag	01234567890123456789AB

Hardware ...

Software ...

BIOS Info ...

### 3-3-2 Monitoring

**Monitoring** displays a real-time record of the node system fan and voltage information. Click **View** to check SDR of specified device.

Status	Sensor type	
OK	Fan	<a href="#">View</a>
NG	Temperature	<a href="#">View</a>
OK	Voltage	<a href="#">View</a>
OK	Current	<a href="#">View</a>

### Sensor Monitoring

Click  to monitor specified sensor and time frame.

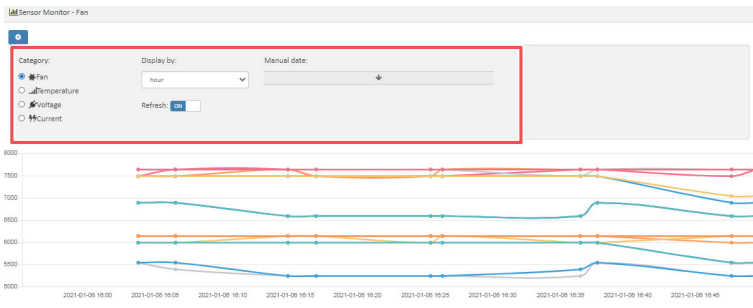

### 3-3-3 Remote Access

**Remote Access** provides the following remote functions:





- Power Control Configuration
- Chassis Identify
- Boot Option
- iKVM
- BMC Account Configuration
- GSM Agent Account Configuration

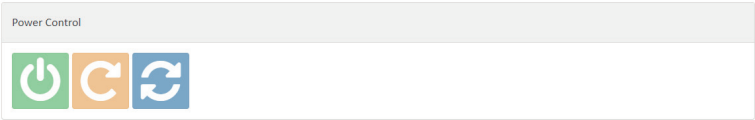

# Power Control

User can power on/off/cycle/and hard reset the remote host system in **Power Control**.



Icon	Description/Resulting Action
	Power on system.
	Power off system.
	Power cycle system.
	Hard reset system.

## Chassis Identify

Chassis Identify

Light on chassis identify in  second(s)

Boot Option

## Boot Option

Boot Option

## iKVM

iKVM

BMC Account Configuration

This setting using on GSM is for accessing BMC, the original bmc account and password will not be changed.

User Name

Password

## BMC Account Configuration

BMC Account Configuration

This setting using on GSM is for accessing BMC, the original bmc account and password will not be changed.

User Name

Password

## GSM Account Configuration

GSM Agent Account Configuration

This setting helps GSM access remote GSM Agent, the original GSM agent account and password will not be changed.

User Name

Password

Parameter	Description/Resulting Action
Chassis Identify	Define the chassis lighting time. When you finish the configuration, click <b>Submit</b> .
Boot Option	Select boot option by clicking specified device tab.
iKVM	<p>Click <b>Launch</b> to launch the redirection console and manage the server remotely. Please ensure that you have latest version of JAVA tool to active the Java KVM console.</p> <p><b>NOTE!</b> Before using the KVM console, you need to set the Java security settings first. Then set the IP address of the remote system in the Exception Site List area.</p>
BMC Account Configuration	Configure the administrator ID and password in this section. After finishing configuration, click <b>Submit</b> .
GSM Account Configuration	Set the User Name and password to connect to the GSM Agent account. Click <b>Submit</b> when setting is complete.

### 3-3-4 Network Configuration

This page provides Group IPv4 and IPv6 DHCP configuration.

IPv4 Settings

Enabled	Enable
Use DHCP	<input checked="" type="checkbox"/>
IP Address	10.1.111.24
Subnet Mask	255.255.255.0
Gateway	10.1.111.253

IPv6 Settings

Enabled	Enable
Use DHCP	<input checked="" type="checkbox"/>
IP Address	::
Gateway	::
Link Local Address	FE80:0000:0000:0000:B62E:99FF:FE88:4DBA

Parameter	Description/Resulting Action
IPv4 setting	
IPv6 Setting	
Enabled	Displays IPv4/IPv6 enabled status.
Use DHCP	Click on tab to enable or disable this function
IP Address	Identify the IP address.
Subnet Mask	Configure the Subnet Mask address.
Gateway	Define the Gateway address

When you finish the configuration, click **Submit** to save your configuration.

### 3-3-5 Event Log

**Event Log** displays the connected Node system event log information.

Click **Clear** to clear current system event log.

Click **Download** to download current system event log.

**NOTE!**

Users can configure Severity, Event Dir & Sensor Type by selecting the drop-down bar.

The screenshot shows the Event Log interface. At the top, there are buttons for 'Node SEL', 'Clear', and 'Download'. To the right, there are three dropdown menus for filtering: 'Severity: Show All', 'Event Dir: Show All', and 'Sensor Type: Show All'. Below these is a search bar and a 'Show 10 entries' dropdown. The main area contains a table with columns for Source, TimeStamp, and Description. The table lists several events, all with a severity of 'Error' (indicated by a red circle) and a status of 'OK' (indicated by a green checkmark). The events are sorted by TimeStamp in descending order. At the bottom, there is a pagination control showing 'Showing 1 to 10 of 40 entries' and buttons for 'Previous', '1', '2', '3', '4', and 'Next'.

Source	TimeStamp	Description
System	2020-12-30 15:39:34.000	System: Processor sensor event was assertion. Event message : ProcessorPresenceDetected
System	2020-12-30 15:39:34.000	System: Processor sensor event was assertion. Event message : ProcessorPresenceDetected
System	2020-12-30 15:39:56.000	System: Processor sensor event was assertion. Event message : ProcessorPresenceDetected
System	2020-12-30 15:39:56.000	System: Processor sensor event was assertion. Event message : ProcessorPresenceDetected
System	2020-12-30 15:55:05.000	System: SystemEvent sensor event was assertion. Event message : OemSystemBootEvent
System	2020-12-30 15:55:12.000	System: SystemEvent sensor event was assertion. Event message : TimestampClockSynch
System	2020-12-30 15:55:12.000	System: SystemEvent sensor event was assertion. Event message : TimestampClockSynch
System	2020-12-30 16:44:15.000	System: SystemEvent sensor event was assertion. Event message : TimestampClockSynch
System	2020-12-30 16:44:17.000	System: SystemEvent sensor event was assertion. Event message : TimestampClockSynch
System	2020-12-30 16:47:00.000	System: SystemEvent sensor event was assertion. Event message : OemSystemBootEvent

### 3-3-6 Alert Management

#### SNMP Trap Setting

In the Trap Settings, user can set the IPv4 and IPv6 Destination List.

IPv6 and IPv4 are two completely separate protocols. IPv6 is not backwards compatible with IPv4, and IPv4 hosts and routers will not be able to deal directly with IPv6 traffic.

IPv6 has a significantly larger address space than IPv4. This results from the use of a 128-bit address, whereas IPv4 uses only 32 bits.

When you finish the configuration, click **Submit** to save configuration.

SNMP Trap Setting

IP Destination	Enable	IPv4/IPv6	Address
1	<input checked="" type="checkbox"/>	<input checked="" type="radio"/> IPv4 <input type="radio"/> IPv6	<input type="text" value="10.1.27.222"/>
2	<input type="checkbox"/>	<input type="radio"/> IPv4 <input type="radio"/> IPv6	<input type="text" value="0.0.0.0"/>
3	<input type="checkbox"/>	<input type="radio"/> IPv4 <input type="radio"/> IPv6	<input type="text" value="0.0.0.0"/>
4	<input type="checkbox"/>	<input type="radio"/> IPv4 <input type="radio"/> IPv6	<input type="text" value="0.0.0.0"/>
5	<input type="checkbox"/>	<input type="radio"/> IPv4 <input type="radio"/> IPv6	<input type="text" value="0.0.0.0"/>
6	<input type="checkbox"/>	<input type="radio"/> IPv4 <input type="radio"/> IPv6	<input type="text" value="0.0.0.0"/>
7	<input type="checkbox"/>	<input type="radio"/> IPv4 <input type="radio"/> IPv6	<input type="text" value="0.0.0.0"/>
8	<input type="checkbox"/>	<input type="radio"/> IPv4 <input type="radio"/> IPv6	<input type="text" value="0.0.0.0"/>
9	<input type="checkbox"/>	<input type="radio"/> IPv4 <input type="radio"/> IPv6	<input type="text" value="0.0.0.0"/>
10	<input type="checkbox"/>	<input type="radio"/> IPv4 <input type="radio"/> IPv6	<input type="text" value="0.0.0.0"/>
11	<input type="checkbox"/>	<input type="radio"/> IPv4 <input type="radio"/> IPv6	<input type="text" value="0.0.0.0"/>
12	<input type="checkbox"/>	<input type="radio"/> IPv4 <input type="radio"/> IPv6	<input type="text" value="0.0.0.0"/>
13	<input type="checkbox"/>	<input type="radio"/> IPv4 <input type="radio"/> IPv6	<input type="text" value="0.0.0.0"/>
14	<input type="checkbox"/>	<input type="radio"/> IPv4 <input type="radio"/> IPv6	<input type="text" value="0.0.0.0"/>
15	<input type="checkbox"/>	<input type="radio"/> IPv4 <input type="radio"/> IPv6	<input type="text" value="0.0.0.0"/>

### 3-3-7 Updates

The user can update node last log, BMC/BIOS firmware, CPLD in this page.

To update specific items, follow the instructions below:

1. Select package from the drop-down list.
2. Select the file on your local system using **Browse**.
3. Click **Update** to update to the new version of firmware.

Update firmware Log

BMC Version: 12.49.06  
BIOS Version: R18b

Select package and update (File format: .zip)

BMC  Browse

Update



**NOTE!** To make sure the Update function works properly, please ensure the GSM Server and the BMC network connections are in the same domain before processing the Update function.

### 3-3-8 Power Consumption

This screen displays information on the system power consumption. The information includes Current Power Consumption, Power Consumption Configuration and Power Consumption Monitoring.

To configure power limit, set Power Limit Management Activated to **ON** and input the value in the respective column. Click **Submit** to save the configuration.

▼ Power Consumption

10.1.111.120

**Power Reading**

Current Power Consumption	381
Max Power Consumption	1087
Min Power Consumption	26
Average Power Consumption	264

**Power Limit**

Power Limit Management Activated	<input type="checkbox"/> off
Power Limit In Watts (1~32767)	<input type="text"/> Watts
Sampling Period (1~3600)	<input type="text"/> Seconds
Correction Time Limit (6000~600000)	<input type="text"/> Milliseconds
Exception Action	No Action ▼

**Monitor**

Display time duration by: hour Manual date: ↓

Refresh

Time	Power Consumption (Watts)
2021-01-08 16:10	800
2021-01-08 16:20	800
2021-01-08 16:40	1000
2021-01-08 16:50	1050
2021-01-08 17:00	400



### 3-3-9 SQL Terminal

This screen displays SQL Terminal information of the system.

To connect SQL terminal, follow the instructions below:

1. Select **Character set** from the drop-down list.
2. Select the file on your local system using **Reconnect**.

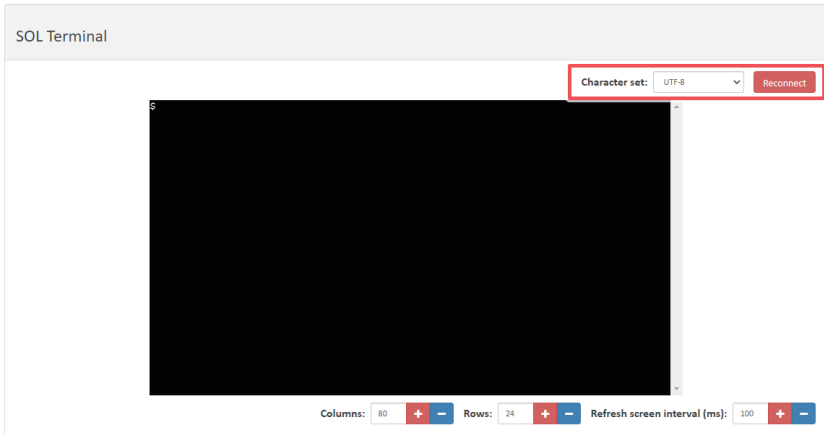

### 3-3-10 Software

This pages provides user to view the related software information. Software information includes GSM Agent Status, System Information, Network Information, PCI Information, and RAID Card Information. Please install GSM Agent separately on each server / node for which you wish to monitor this related information. Please see "GSM Agent User Manual" for more information. System Info, Network Info, PCI Info, RAID Information and SMART Information. Please install GSM Agent separately on each server / node for which you wish to monitor this related information. Please see "GSM Agent User Manual" for more information.

▼ Software

Agent Status: Off-line

### RAID Card Information

N/A

▼ Software

10.1.7.80

Agent Status: On-line

### System Info

OS version	Ubuntu 16.04
CPU Info	Intel(R) Xeon(R) W-2123 CPU @ 3.60GHz
Memory Info	DDR4 2666 MHz
Hostname	gigabyte-MF51-E53-QZ
BMC version	12.49
CPU usage	25.11%
Memory usage	98.66%

### Network Info

<b>enp3i0</b>	
NIC IPv4 Address	10.1.7.88
NIC IPv6 Address	fe80::9885:345:884d:543f
NIC MAC Address	b4:2e:99:25:dd:a2
NIC Description	enp3i0

▼ Software

<b>enp4i0</b>	
NIC IPv4 Address	0.0.0.0
NIC IPv6 Address	0:0:0:0:0:0:0:0
NIC MAC Address	b4:2e:99:25:dd:e2
NIC Description	enp4i0

### PCI Info

PCI Manufacturer	Intel Corporation
PCI Type	
<b>Sky Lake-E RAS Configuration Registers</b>	
PCI Manufacturer	Intel Corporation
PCI Type	System peripheral
<b>Sky Lake-E RAS Configuration Registers</b>	
PCI Manufacturer	Intel Corporation
PCI Type	System peripheral
<b>Sky Lake-E RAS Configuration Registers</b>	
PCI Manufacturer	Intel Corporation

### RAID Card Information

N/A

### 3-3-11 Remote BIOS Setup

User can update BIOS settings through Remote BIOS Setup function. Using .json file to configure BIOS settings.

**Browse:** Select .json file from locale side

**Import:** Import file which you selected **Export:** Download currently BIOS settings

**Reset Default:** Reset BIOS settings

**Save:** Save modified BIOS settings

Remote BIOS Setup		<a href="#">Browse</a>	<a href="#">Import</a>	<a href="#">Export</a>	<a href="#">Reset Default</a>	<a href="#">Save</a>
Administrator Password ⓘ	<input checked="" type="radio"/> No action <input type="radio"/> Set <input type="radio"/> Delete					
	<input type="text" value="Password"/>					
User Password ⓘ	<input checked="" type="radio"/> No action <input type="radio"/> Set <input type="radio"/> Delete					
	<input type="text" value="Password"/>					
ErP Mode ⓘ	Disabled					
Security Device Support ⓘ	Enable					
Disable Block Sid ⓘ	Disabled					
TPM State ⓘ	Enabled					
Pending operation ⓘ	None					
Security Device Support ⓘ	Enable					
TCM State ⓘ	Enabled					
Device Select ⓘ	Auto					
SHA-1 PCR Bank ⓘ	Enabled					

### 3-4 Group Manager

Group Manager provides the function of Create group, Edit group, Delete group, and Search function of current remote grouped client systems. Click **Group Manager** for advanced configuration.

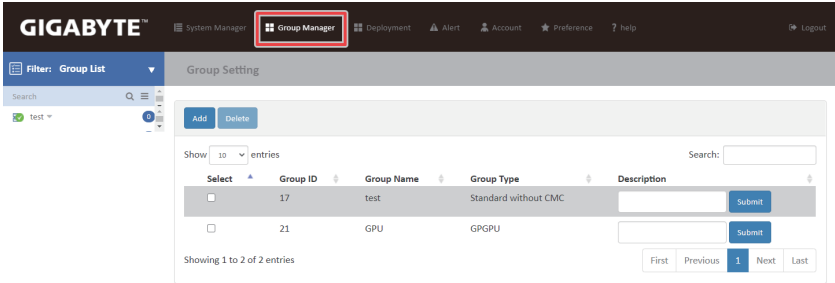

Parameter	Description/Resulting Action
Select	Check <b>Select</b> box to configure connected nodes in the same group.
Group ID	Displays the connected group ID information.
Group Name	Displays the group name. Click on selected <b>Group Name</b> to view the Group dashboard information and Group remote management functions.
Group Type	Displays the group type information.
Description	User can add a description for selected group. When you have finished configuration, click <b>Submit</b> .

## Create a Group

1. Click **Add**.
2. Define the new group name in the respective column.
3. Select Group type from the drop-down list.
4. When you have finished configuration, click **Submit**.

Group Setting

**Add** **Delete**

Show 10 entries Search:

Select	Group ID	Group Name	Group Type	Description
<input type="checkbox"/>	17	test	Standard without CMC	<input type="text"/> <b>Submit</b>
<input type="checkbox"/>	21	GPU	GPGPU	<input type="text"/> <b>Submit</b>

Showing 1 to 2 of 2 entries

First Previous **1** Next Last

---

Group Name

Group Type

**Submit** **Close**

## Group Manager

Group Manager provides Add IP, Delete IP, and rename a specified group of nodes.

**GIGABYTE** System Manager Group Manager Deployment Alert Account Preference Help

Filter: Group List Information

Search: test

**GPU2**

**Add IP** **Delete IP** **Group Rename**

Show 10 entries Search:

Select	BMC MAC	BMC IP	BMC Connection	BMC Version	Node Type	BIOS Info	Download Last Crash Screen
<input type="checkbox"/>	B4:2E:99:26:FF:0C	10.1.111.117	false	N/A	BMC	<a href="#">View</a>	<a href="#">Download</a>
<input type="checkbox"/>	18:CO:4D:80:62:CE	10.1.111.120	true	R17a	BMC	<a href="#">View</a>	<a href="#">Download</a>
<input type="checkbox"/>	ED:D5:5E:CD:A5:63	10.1.111.130	false	R14	BMC	<a href="#">View</a>	<a href="#">Download</a>
<input type="checkbox"/>	B4:2E:99:3B:7E:B5	10.1.111.134	true	R08	BMC	<a href="#">View</a>	<a href="#">Download</a>
<input type="checkbox"/>	B4:2E:99:A1:65:02	10.1.111.138	true	R19	BMC	<a href="#">View</a>	<a href="#">Download</a>
<input type="checkbox"/>	18:CO:4D:80:AA:8A	10.1.111.139	true	D07	BMC	<a href="#">View</a>	<a href="#">Download</a>
<input type="checkbox"/>	ED:D5:5E:C7:0D:F1	10.1.111.141	true	R23	BMC	<a href="#">View</a>	<a href="#">Download</a>
<input type="checkbox"/>	ED:D5:5E:E7:EC:61	10.1.111.144	true	R13	BMC	<a href="#">View</a>	<a href="#">Download</a>
<input type="checkbox"/>	ED:D5:5E:C7:3D:CD	10.1.111.155	true	R31	BMC	<a href="#">View</a>	<a href="#">Download</a>
<input type="checkbox"/>	ED:D5:5E:65:90:82	10.1.111.157	true	R18b	BMC	<a href="#">View</a>	<a href="#">Download</a>

Showing 1 to 10 of 33 entries

Previous **1** 2 3 4 Next

### 3-4-1 Information

To add a new BMC node to a group, follow the steps as below:

1. Click **Add IP** and select the BMC node you want to add in a group.
2. When you have finished configuration, click **Submit**.

To delete an existing BMC node, follow the steps as below:

1. Click **Delete IP** and select the BMC node you want to delete from a group.

To rename the group, follow the steps as below:

1. Click **Group Rename** and enter the new name for the group.
2. Click **Submit** to apply changes.

The screenshot displays the GIGABYTE System Manager interface. At the top, there are navigation tabs for System Manager, Group Manager, Deployment, Alert, Account, Preference, and Help. The main header shows the current group as 'GPU2'. Below this, there are three buttons: 'Add IP', 'Delete IP', and 'Group Rename'. A search bar is present on the right side of the table area.

Select	BMC MAC	BMC IP	BMC Connection	BMC Version	Node Type	BIOS Info	Download Last Crash Screen
<input type="checkbox"/>	B4:2E:99:26:FF:0C	10.1.111.117	false	N/A	BMC	<a href="#">View</a>	<a href="#">Download</a>
<input type="checkbox"/>	18:C0:4D:80:62:CE	10.1.111.120	true	R17a	BMC	<a href="#">View</a>	<a href="#">Download</a>
<input type="checkbox"/>	E0:D5:5E:CD:A5:63	10.1.111.130	false	R14	BMC	<a href="#">View</a>	<a href="#">Download</a>
<input type="checkbox"/>	B4:2E:99:38:7E:B5	10.1.111.134	true	R08	BMC	<a href="#">View</a>	<a href="#">Download</a>
<input type="checkbox"/>	B4:2E:99:A1:65:02	10.1.111.138	true	R19	BMC	<a href="#">View</a>	<a href="#">Download</a>
<input type="checkbox"/>	18:C0:4D:80:AA:8A	10.1.111.139	true	D07	BMC	<a href="#">View</a>	<a href="#">Download</a>
<input type="checkbox"/>	E0:D5:5E:C7:0D:F1	10.1.111.141	true	R23	BMC	<a href="#">View</a>	<a href="#">Download</a>
<input type="checkbox"/>	E0:D5:5E:E7:EC:61	10.1.111.144	true	R13	BMC	<a href="#">View</a>	<a href="#">Download</a>
<input type="checkbox"/>	E0:D5:5E:C7:0D:CD	10.1.111.155	true	R31	BMC	<a href="#">View</a>	<a href="#">Download</a>
<input type="checkbox"/>	E0:D5:5E:65:90:82	10.1.111.157	true	R18b	BMC	<a href="#">View</a>	<a href="#">Download</a>

Showing 1 to 10 of 33 entries

Navigation: Previous | 1 | 2 | 3 | 4 | Next

---

Add (All)

Select	BMC MAC	BMC IP	Node Type
<input type="checkbox"/>	B4:2E:99:26:FF:0C	10.1.111.117	BMC
<input type="checkbox"/>	18:C0:4D:80:62:CE	10.1.111.120	BMC
<input type="checkbox"/>	E0:D5:5E:CD:A5:63	10.1.111.130	BMC
<input type="checkbox"/>	B4:2E:99:38:7E:B5	10.1.111.134	BMC
<input type="checkbox"/>	18:C0:4D:80:AA:8A	10.1.111.139	BMC
<input type="checkbox"/>	E0:D5:5E:C7:0D:F1	10.1.111.141	BMC
<input type="checkbox"/>	E0:D5:5E:E7:EC:61	10.1.111.144	BMC
<input type="checkbox"/>	E0:D5:5E:C7:0D:CD	10.1.111.155	BMC
<input type="checkbox"/>	E0:D5:5E:65:90:82	10.1.111.157	BMC
<input type="checkbox"/>	E0:D5:5E:65:8F:04	10.1.111.161	BMC

Showing 1 to 10 of 35 entries

Navigation: Previous | 1 | 2 | 3 | 4 | Next

Buttons: **Submit** **Close**

### 3-4-2 Remote Access

**Remote Access** provides the following remote functions for managing grouped nodes:

- Power Control Configuration
- Chassis Identify
- Boot Option

Please refer section 3-3-3 Remote Access for advanced configuration.



#### NOTE!

1. Specify the node system from the group list and click Submit to complete the configuration.

▼ Remote Access

GPU2

Power Control

Chassis Identify

Light on chassis identify in  second(s)

Boot Option

Group Reboot BMC

▼ Remote Access

Group Reboot BMC

BMC Backup/Restore Configure

Restore BMC Configure (File format: .bin)

BIOS Setup Information

Select JSON file for importing BIOS Setup information. (File format: .json)

Remote Access

BIOS Setup information

Select JSON file for importing BIOS Setup information. (File format: .json)

[Browse](#) [Import](#) [Export](#)

New Network Time Protocol

Operation Mode	Disabled
New Network Time Protocol Server 1	xxx.xxx.xxx.xxx
New Network Time Protocol Server 2	xxx.xxx.xxx.xxx
New Network Time Protocol Server 3	xxx.xxx.xxx.xxx
Requested Mode's Update Frequency (minutes)	Integer

Setting



### 3-4-3 Updates

Users can configure the TFTP server and update node last log,PSU/BMC/BIOS/ firmware, CPLD\_MD, and CPLD\_BPB in this page. Follow the steps below to update group firmware remotely.

1. Select the BMC node you want to update firmware.
2. Then select the package type by using **Browse**.
3. Click Update to update the firmware.
4. To update image file, select the package type by using **Browse**.
5. Click Update to update the image file.

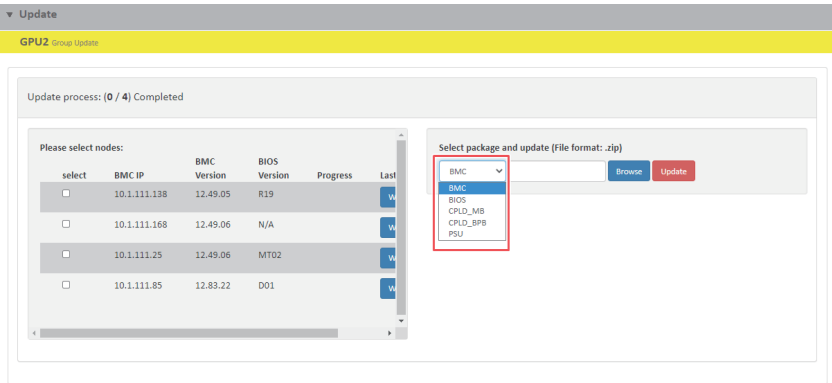

### 3-4-4 Event Log

**Event Log** records an event when a sensor is in an abnormal state. When the log matches a pre-defined alert, the system will send out a notification automatically if it is pre-configured.

1. Click **Clear** to clear all history log information.
2. Click **Download** to download current system event log.

Event Log

GPU2

Clear Download

Show 10 entries Search:

Timestamp	Level	Description
2021-01-07 02:59:10.308	2	Add group member: 10.1.111.97
2021-01-07 02:59:10.260	2	Add group member: 10.1.111.91
2021-01-07 02:59:10.209	2	Add group member: 10.1.111.90
2021-01-07 02:59:10.150	2	Add group member: 10.1.111.87
2021-01-07 02:59:10.091	2	Add group member: 10.1.111.85
2021-01-07 02:59:10.043	2	Add group member: 10.1.111.79
2021-01-07 02:59:09.989	2	Add group member: 10.1.111.77
2021-01-07 02:59:09.943	2	Add group member: 10.1.111.74
2021-01-07 02:59:09.898	2	Add group member: 10.1.111.67
2021-01-07 02:59:09.849	2	Add group member: 10.1.111.66

Showing 1 to 10 of 39 entries

Previous 1 2 3 4 Next

### 3-4-5 Power Consumption

**Power Consumption** displays a Group's power usage status for each system and the average usage status of a Group. This function also allows users to configure the power policies for the system.

The screenshot shows the 'Power Consumption' interface for a group named 'GPU2'. It is divided into two main sections: 'Policy' and 'Current total watts'. Both sections feature a table with columns for 'Power Limit in Watts', 'Start Time', and 'End Time'. The 'Policy' section has 'Add' and 'Delete' buttons and shows 'No data available in table'. The 'Current total watts' section has columns for 'BMC MAC', 'BMC IP', 'Power Consumption', 'Average Power', and 'Power Limit in Watts', also showing 'No data available in table'. Both sections include search bars, pagination controls, and 'Previous/Next' buttons.

Parameter	Description/Resulting Action
Policy	Click <b>Add</b> to add the execution time of Power limit. The start time is the initial time, and Duration (hour) is to set the duration. You can check the setting item and click Delete to cancel the setting of Power Limit.
Current total watts	Displays the power limit of each System and its average value.

### 3-4-6 Network Configuration

Network Configuration provides Group IPv4 and IPv6 DHCP configuration.

Network Configuration

GPU2

Network configuration

IPv4 Settings

DHCP

IPv6 Settings

DHCP

### 3-4-7 Alert Management

Please refer section 3-3-6 Alert Management for advanced configuration.



**NOTE!** Only all system nodes in a group can be configurable.

Alert Management

Trap Setting

IP Destination	Enable	IPv4/IPv6	Address
1	<input type="checkbox"/> OFF	<input checked="" type="radio"/> IPv4 <input type="radio"/> IPv6	0.0.0.0
2	<input type="checkbox"/> OFF	<input checked="" type="radio"/> IPv4 <input type="radio"/> IPv6	0.0.0.0
3	<input type="checkbox"/> OFF	<input checked="" type="radio"/> IPv4 <input type="radio"/> IPv6	0.0.0.0
4	<input type="checkbox"/> OFF	<input checked="" type="radio"/> IPv4 <input type="radio"/> IPv6	0.0.0.0
5	<input type="checkbox"/> OFF	<input type="radio"/> IPv4 <input checked="" type="radio"/> IPv6	::
6	<input type="checkbox"/> OFF	<input type="radio"/> IPv4 <input checked="" type="radio"/> IPv6	::
7	<input type="checkbox"/> OFF	<input type="radio"/> IPv4 <input checked="" type="radio"/> IPv6	::
8	<input type="checkbox"/> OFF	<input type="radio"/> IPv4 <input checked="" type="radio"/> IPv6	::

Submit

## 3-5 Deployment

User can create the deployment for specified node or multi nodes.

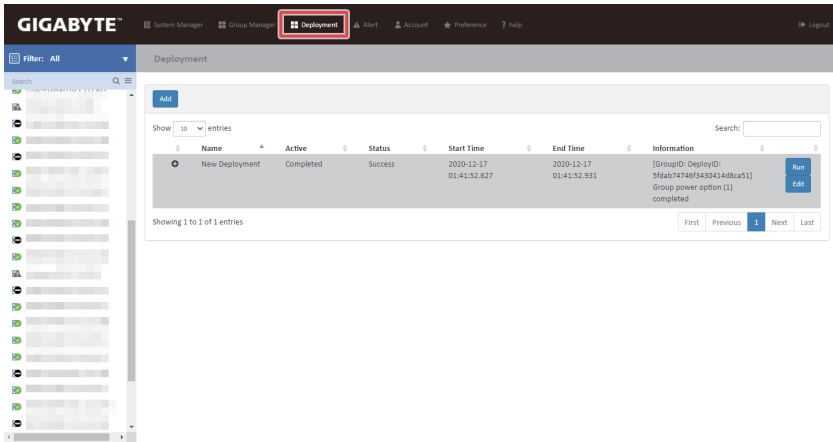

### Create a Deployment

1. Click **Add**.
2. Define the new deployment name in the respective column.
3. Define deployment conditions from the drop-down list.
4. When you have finished configuration, click **Submit**.

Add Deployment

Deployment Name:

Remote Access  Power Control  Power on

Show 10 entries

<input type="checkbox"/>	BMC IP	BMC MAC	Node Type
<input type="checkbox"/>	10.1.111.101	B4:2E:99:75:C6:76	CMC
<input type="checkbox"/>	10.1.111.117	18:C0:4D:05:31:2F	Unknown
<input type="checkbox"/>	10.1.111.120	18:C0:4D:80:62:CE	BMC
<input type="checkbox"/>	10.1.111.121	00:00:00:1F:2D:32	BMC
<input type="checkbox"/>	10.1.111.123	00:00:00:14:CC:FD	BMC
<input type="checkbox"/>	10.1.111.130	E0:D5:5E:CD:A5:63	BMC
<input type="checkbox"/>	10.1.111.134	B4:2E:99:38:7E:85	BMC
<input type="checkbox"/>	10.1.111.138	B4:2E:99:A1:65:02	BMC
<input type="checkbox"/>	10.1.111.139	18:C0:4D:80:AA:8A	BMC
<input type="checkbox"/>	10.1.111.141	E0:D5:5E:C7:0D:F1	BMC

Showing 1 to 10 of 52 entries

First Previous 1 2 3 4 5 6 Next Last

Submit Reset

### 3-6 Alert

Alert page shows you data related to the sensor's health, such as sensor reading.



**NOTE!** The number beside the Alert header represents the number of Alert events that have occurred.

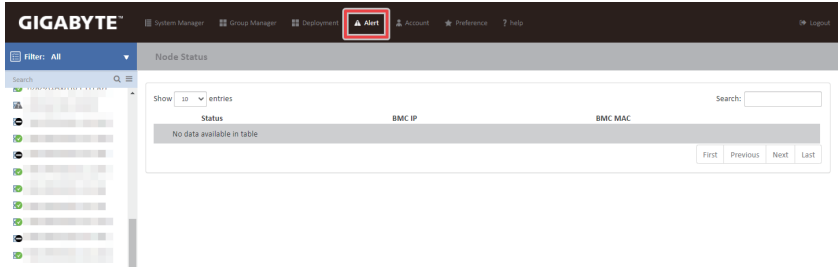

### 3-7 Account

This page provides the function to create a specific user account. Click **Account** for advanced configuration.

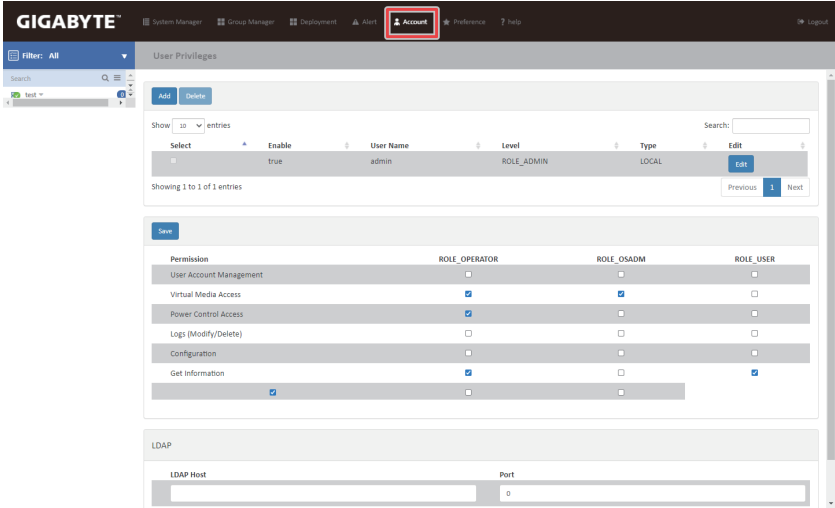

#### Create an Account

Follow the steps below to create a new account.

1. Click **Add** and define the **User Name** and **Password**.
2. Define **Enable** function.
3. Select Privileges **Level**.
4. When you finish the configuration, click **Submit**.

#### Add Member

<b>User Name</b>	<b>Password</b>
<input type="text"/>	<input type="text"/>
<b>Enable</b>	<b>Level</b>
<input checked="" type="radio"/> true <input type="radio"/> false	<input type="text" value="ROLE_ADMIN"/>
<input type="button" value="Submit"/> <input type="button" value="Close"/>	

<b>Privilege Level</b>	
ROLE_ADMIN	All BMC commands are allowed, including configuration commands. An Administrator can even execute configuration commands that would disable the channel that the Administrator is communicating over.
ROLE_OSADM	Only allow to execute remote console and virtual media commands for OS level by default
ROLE_OPERATORS	All BMC commands are allowed, except for configuration commands that can change the behavior of the out-of-band interfaces. For example, Operator privilege does not allow the capability to disable individual channels, or change user access privileges.
ROLE_USER	This may be considered the lowest privilege level.



## LDAP

LDAP configuration page.

When you finish the configuration, click **Submit**.

LDAP

LDAP Host	Port
<input type="text"/>	<input type="text" value="0"/>
<input type="button" value="Submit"/>	



### NOTE!

When configuring the LDAP Server, you need to set the LDAP Host and Port in advance.

- LDAP Host: LDAP Serve IP address.
- LDAP Port: 389.

### 3-8 Preference

Preference displays the database usage and IP range configuration for remote node or group system.

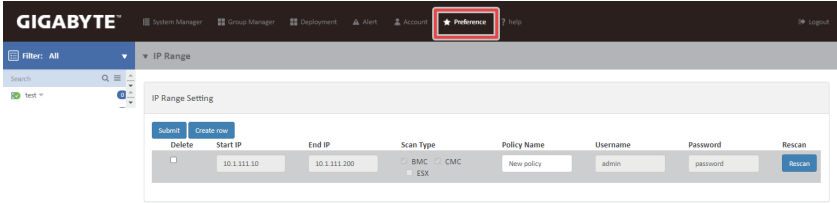

Click the drop-down list for advanced configuration.

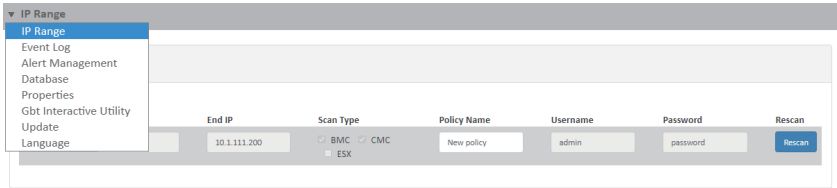

### 3-8-1 IP Range

User can specify the IP range that is scanned during a normal discovery run. Follow the steps outlined below to configure IP discover.

1. Select Connection Interface to search BMC Server.
2. Click **Create row** to specify the IP range in the respective columns.
3. Enter Start IP and End IP in the respective columns.
4. Select **Scan Type** and define the **Policy Name**.
5. When you finish the configuration, click **Submit** to save your configuration.

▼ IP Range

IP Range Setting

[Submit](#) [Create row](#)

Delete	Start IP	End IP	Scan Type	Policy Name	Username	Password	Rescan
<input type="checkbox"/>	10.1.111.10	10.1.111.200	<input type="radio"/> BMC <input checked="" type="radio"/> CMC <input type="radio"/> ESX	New policy	admin	password	<a href="#">Rescan</a>

Scan Type	Description
BMC	Baseboard management controller, which gives a user or administrator the ability to control a remote system and the ability to perform a variety of functions. With BMC, data is only transmitted within the local area network.
CMC	Chassis Management Controller, which provides functionality for managing multiple server nodes within a single chassis, or multiple chassis. CMC is a higher level of control and monitoring of one or multiple chassis.
ESX	VMware ESX Server Controller.

### 3-8-2 Event Log

Event Log displays event log information for all nodes/systems within the defined IP range.

Event Log

Clear Download

Show 10 entries Search:

Timestamp	Level	Description
2021-01-07 06:20:49.136	2	Get RMC/CMC node, group ID: 24
2021-01-07 06:20:43.275	2	Get RMC/CMC node, group ID: 23
2021-01-07 06:20:38.827	2	Get RMC/CMC node, group ID: 22
2021-01-07 06:20:37.790	2	Get RMC/CMC node, group ID: 20
2021-01-07 06:09:40.741	2	Get RMC/CMC node, group ID: 25
2021-01-07 06:09:35.099	2	Get RMC/CMC node, group ID: 24
2021-01-07 06:09:29.205	2	Get RMC/CMC node, group ID: 23
2021-01-07 06:09:24.776	2	Get RMC/CMC node, group ID: 22
2021-01-07 06:09:23.766	2	Get RMC/CMC node, group ID: 20
2021-01-07 05:20:46.647	2	Get RMC/CMC node, group ID: 25

Showing 1 to 10 of 1,645 entries

Previous 1 2 3 4 5 ... 165 Next

User Action's Log

Show 10 entries Search:

No.	Timestamp	User Name	Client IP	Action	Description	Result
154	2021-01-07 06:38:14.221	admin	10.1.2.29	LOGIN	Log in	SUCCESS
153	2021-01-07 06:28:46.997	admin	10.1.2.29	LOGIN	Log in	SUCCESS

### User Action's Log Event Log

Displays the action event log of users.

User Action's Log

Show 10 entries Search:

No.	Timestamp	User Name	Client IP	Action	Description	Result
154	2021-01-07 06:38:14.221	admin	10.1.2.29	LOGIN	Log in	SUCCESS
153	2021-01-07 06:28:46.997	admin	10.1.2.29	LOGIN	Log in	SUCCESS
152	2021-01-07 05:39:47.504	admin	10.1.7.151	LOGIN	Log in	SUCCESS
151	2021-01-07 05:39:23.536	admin	10.1.7.151	DELETE	Delete IP with 10.1.111.85 from group ID with 27	SUCCESS
150	2021-01-07 05:39:23.482	admin	10.1.7.151	DELETE	Delete IP with 10.1.111.25 from group ID with 27	SUCCESS
149	2021-01-07 05:39:23.430	admin	10.1.7.151	DELETE	Delete IP with 10.1.111.168 from group ID with 27	SUCCESS
148	2021-01-07 05:39:23.374	admin	10.1.7.151	DELETE	Delete IP with 10.1.111.138 from group ID with 27	SUCCESS
147	2021-01-07 05:39:12.782	admin	10.1.7.151	DELETE	Delete IP with 10.1.111.120 from group ID with 17	SUCCESS
146	2021-01-07 05:39:12.720	admin	10.1.7.151	DELETE	Delete IP with 10.1.111.117 from group ID with 17	SUCCESS
145	2021-01-07 05:38:29.936	admin	10.1.7.151	LOGIN	Log in	SUCCESS

Showing 1 to 10 of 155 entries

Previous 1 2 3 4 5 ... 16 Next

Download

### 3-8-3 Alert Management

**Alert Management** enables the following configuration: **GSM SNMP Setting** and **IPv4 Destination** configuration, **SMTP Server** configuration, and **Send Mail** configuration for all nodes/systems within the defined IP range.

#### GSM SNMP

GSM SNMP trap configuration includes SNMP setting and SNMP destination configuration.

Alert Management

GSM SNMP

**Setting**

Alerting Enable  OFF

Host Address

Alerting Level

\* Note: The ordering of event alert levels is Critical > Non-Critical > Unknown  
- Critical: Only Critical event  
- Non-Critical: Critical event and Non-Critical event  
- Unknown: All event

**Destination**

IPv4 Destination	Enable	IPv4 Address
1	<input type="checkbox"/> OFF	<input type="text" value="0.0.0.0"/>
2	<input type="checkbox"/> OFF	<input type="text" value="0.0.0.0"/>
3	<input type="checkbox"/> OFF	<input type="text" value="0.0.0.0"/>
4	<input type="checkbox"/> OFF	<input type="text" value="0.0.0.0"/>

Parameter	Description/Resulting Action
Alerting Enable	Determine whether the trap is sent by connected node.
Host address	Displays the host address information.
Alerting Level	Determine the alerting level from the drop-down list. Please refer to Section 3-3-5 Event Log for description of alerting level.

## Destination

GSM SNMP Destination configuration for all nodes/systems within the defined IP range.

Alert Management

Destination

IPv4 Destination	Enable	IPv4 Address
1	<input type="checkbox"/> OFF	0.0.0.0
2	<input type="checkbox"/> OFF	0.0.0.0
3	<input type="checkbox"/> OFF	0.0.0.0
4	<input type="checkbox"/> OFF	0.0.0.0

Submit

Parameter	Description/Resulting Action
Destination	
IPv4 Destination	User can configure 4 IPv4 Destination.
Enable	Select ON to configure IPv4 address
IPv4 Address	Enter specified IP address. When you finish the configuration, click <b>Submit</b> to save your configuration.

### 3-8-4 Database

**Database** shows DB location information, provides a backup function, and enables firmware update for all nodes/systems within the defined IP range.

Database

---

Database usage

Category	Value
Total Size	81.98%
Other Usage	37.46%
Other Usage	18.22 GB
Database Usage	0.17 GB
Free Space	11.01 GB

---

Database Restore/Backup

Restore the database data (File format: .zip)

[Browse](#) [Restore](#) [Backup](#)

---

Database Reset

Reset the database data

[Reset](#)

### 3-8-5 Properties

**Properties** enables GSM TFTP server configuration for all nodes/systems within the defined IP range. Follow steps outlined below to configure TFTP server.

1. Define **Database** usage.
2. Define checking time. In each routine check, GSM will check log date
3. When you finish the configuration, click **Submit**.

**Database**

In each routine check, GSM will check database usage and data date

If disk usage over the settings, GSM will delete data from database

0% 10% 90% 100%  %

Keep database data in  day(s)

**Log**

In each routine check, GSM will check log date

Keep log file in  day(s)

**Log rotation**

Keep log files down to a manageable size

Rotate the log files each

Rotation size

**BMC Node Update Setting**

GSM will follow setting to update BMC node during fixed period.

Node quantity    nodes

Node update period    minutes

### BMC Node Update Setting

Configuration of interval and number of nodes.

Parameter	Description
Node quantity	Search number of nodes.
Node update period	Update node intervals.



### 3-8-6 Gbt Interactive Utility

User can use Gbt Interactive Utility to set the path of Gbt Utility.jar. Then, execute related command.

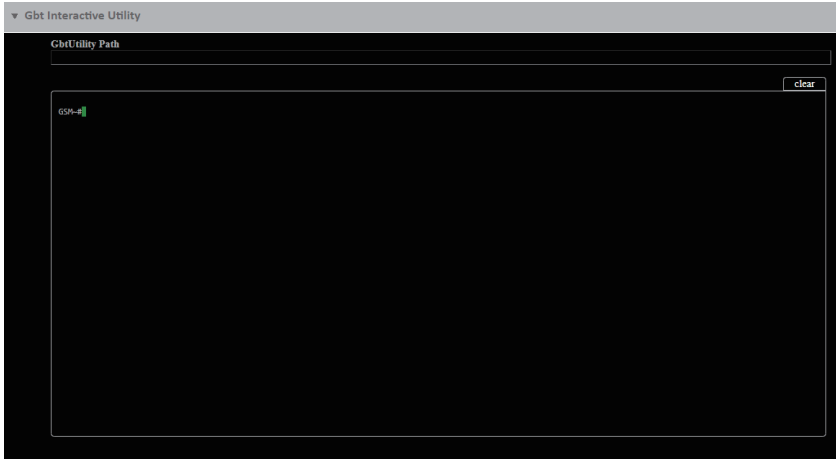

### 3-8-7 Update

User can update GSM firmware and reset the system to default settings for all nodes/systems within the defined IP range from this page.

To update, select the file on your local system using Browse.

1. Click **Update** to update to the new version of firmware.
2. To update Keystore, click **Choose File** and enter keystore password, then click **Update**.
3. To reset system to the factory default, click **Reset**.

▼ Update

Update

Select package and update (File format: .war)

Current Version: GIGABYTE GSM Server v2.04

No file chosen

Update Server

IP:

Update keystore

Keystore file:  No file chosen

### 3-8-8 Language

User can select the preference language in this page.

▼ Language

🌐 Language

Language ▼

# 3-9 Help

Help page provides general information including System manager, Group manager, Deployment, Alert, Account, and Preference.

Current Version: GIGABYTE GSM Server v2.04

Menu Description					
System Manager	Group Manager	Deployment	Alert	Account	Preference

Hardware requirements
<ul style="list-style-type: none"><li>- System Processor: 2 GHZ and above</li><li>- System Memory: Minimum 4 GB RAM</li><li>- Free Disk Space: 1000 GB at least</li><li>- Node Servers : 255 maximum</li></ul>

# 3-10 Logout

Click  to logout of the system.

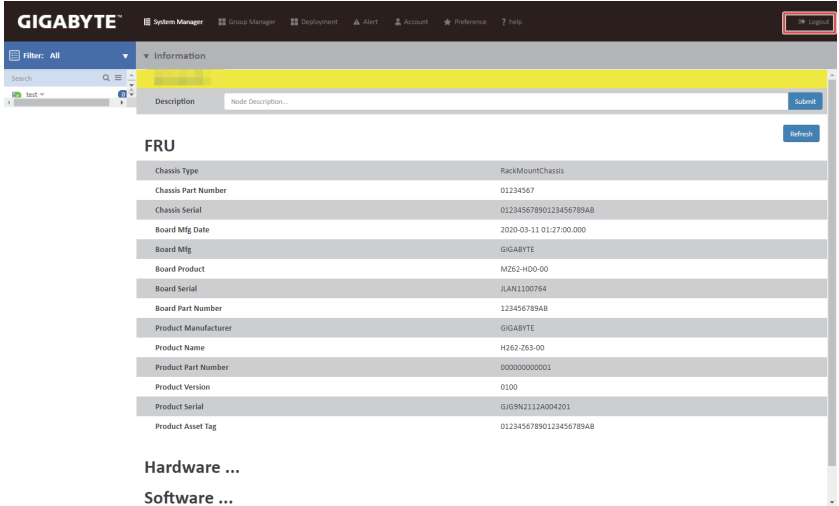

**GIGABYTE™** System Manager Group Manager Deployment Alert Account Preference Help

Filter: All

Information

Description:

### FRU

Chassis Type	RackMountChassis
Chassis Part Number	01234567
Chassis Serial	01234567890123456789AB
Board Mfg Date	2020-03-11 01:27:00.000
Board Mfg	GIGABYTE
Board Product	M2S2-H00-00
Board Serial	JLAN1100764
Board Part Number	123456789AB
Product Manufacturer	GIGABYTE
Product Name	H262-263-00
Product Part Number	00000000001
Product Version	0100
Product Serial	GIGSN2112A004201
Product Asset Tag	01234567890123456789AB

Hardware ...

Software ...

## Chapter 5 Appendix

### 5-1 Event Log List

SNMP ID	Event Level	Event Function	Event Description
D06F00	FATAL	DB	Database connection failed.
D06F01	ERROR	DB	Database connection denied.
D16F00	ERROR	Network Configuration	Get IPv4 configuration failed
D16F01	ERROR	Network Configuration	Set IPv4 configuration failed
D16F02	ERROR	Network Configuration	Get IPv6 configuration failed
D16F03	ERROR	Network Configuration	Set IPv6 configuration failed
D26F00	ERROR	Chassis Control	Power control failed
D26F01	ERROR	Chassis Control	Set chassis identify failed
D26F02	ERROR	Chassis Control	Get chassis status failed
D36F00	ERROR	Power Limit	Get power limit failed
D36F01	ERROR	Power Limit	Power limit configuration failed
D36F02	ERROR	Power Limit	Power limit configuration failed
D46F00	ERROR	Platform Event	Platform event log failed
D46F01	ERROR	Platform Event	Set platform event failed
D56F00	ERROR	Trap Destination	Get IPv4 destination failed
D56F01	ERROR	Trap Destination	Set IPv4 destination failed
D56F02	ERROR	Trap Destination	Get IPv4 activate status failed
D56F03	ERROR	Trap Destination	Set IPv4 activate status failed
D56F04	ERROR	Trap Destination	Get IPv6 destination failed
D56F05	ERROR	Trap Destination	Set IPv6 destination failed
D56F06	ERROR	Trap Destination	Get IPv6 activate status failed
D56F07	ERROR	Trap Destination	Set IPv6 activate status failed
D36F03	WARN	Group Power Limit	Policy already exist
D36F04	INFO	Group Power Limit	Add new policy
D36F05	INFO	Group Power Limit	Delete policy
D36F06	INFO	Group Power Limit	Group XXX: enable power limit
D36F07	INFO	Group Power Limit	Group XXX: reduce power limit to XXX
D36F08	INFO	Group Power Limit	Group XXX: disable power limit
D66F00	WARN	User Management	User account: XXX already exist
D66F01	INFO	User Management	Add new user account: XXX
D66F02	INFO	User Management	Delete user account: XXX
D76F00	INFO	System Reset	System reset success
D76F01	ERROR	System Reset	System reset failed, please wait a few minutes
D86F00	INFO	Group Setting	Create group
D86F01	INFO	Group Setting	Delete group
D86F02	INFO	Group Setting	Add group member
D86F03	INFO	Group Setting	Delete group member
D86F04	INFO	Group Setting	Rename group

D96F00	INFO	Background(GSM) : IP Discover	Found new OpenRack1.0 RMC IP(with ip)
D96F01	INFO	Background(GSM) : IP Discover	Found new IPMI IP(with ip/mac/type)
D96F02	INFO	Background(GSM) : Node Status	Add node(with mac information)
D96F03	INFO	Background(GSM) : Node Status	Start monitor after a random time has expired
D96F04	INFO	Background(GSM) : Node Status	Delete node(with mac information)
D96F05	INFO	Background(GSM) : Monitor high frequency	Add node(with mac information)
D96F06	INFO	Background(GSM) : Monitor high frequency	Start monitor after a random time has expired
D96F07	INFO	Background(GSM) : Monitor high frequency	Delete node(with mac information)
D96F08	INFO	Background(GSM) : System info high frequency	Add node(with mac information)
D96F09	INFO	Background(GSM) : System info high frequency	Start monitor after a random time has expired
D96F0A	INFO	Background(GSM) : System info high frequency	Delete node(with mac information)
D96F0B	INFO	Background(GSM) : System info low frequency	Add node(with mac information)
D96F0C	INFO	Background(GSM) : System info low frequency	Start monitor after a random time has expired
D96F0D	INFO	Background(GSM) : System info low frequency	Delete node(with mac information)
D96F0E	INFO	Background(GSM) : Power reading	Add node(with mac information)
D96F0F	INFO	Background(GSM) : Power reading	Start monitor after a random time has expired
D96F10	INFO	Background(GSM) : Power reading	Delete node(with mac information)
DA6F00	WARN	Background(Each node) : Node Status	Node disconnect, terminate all service process
DA6F01	WARN	Background(Each node) : Node Status	IPMI damage retry count
DA6F02	ERROR	Background(Each node) : Node Status	IPMI damage, terminate all service process except node status itself

DA6F03	INFO	Background(Each node) : Node Status	Node has been terminated
DA6F04	ERROR	Background(Each node) : Monitor high frequency	Send command exception(Could be raw command fail or sql command fail)
DA6F05	INFO	Background(Each node) : Monitor high frequency	Node has been terminated
DA6F06	ERROR	Background(Each node) : System info high frequency	Exception information(get free port fail)
DA6F07	WARN	Background(Each node) : System info high frequency	Node management status is true/false
DA6F08	INFO	Background(Each node) : System info high frequency	Node has been terminated
DA6F09	ERROR	Background(Each node) : System info low frequency	Get FRU fail
DA6F0A	ERROR	Background(Each node) : System info low frequency	Get SDR fail
DA6F0B	ERROR	Background(Each node) : System info low frequency	Get 3 Net MAC fail
DA6F0C	ERROR	Background(Each node) : System info low frequency	Get SMBIOS info fail
DA6F0D	INFO	Background(Each node) : System info low frequency	Node has been terminated
DA6F09	ERROR	Background(Each node) : System info low frequency	Get FRU fail
DA6F0A	ERROR	Background(Each node) : System info low frequency	Get SDR fail
DA6F0B	ERROR	Background(Each node) : System info low frequency	Get 3 Net MAC fail
DA6F0C	ERROR	Background(Each node) : System info low frequency	Get SMBIOS info fail

DA6F0D	INFO	Background (Each node) : System info low frequency	Node has been terminated
DC6F03	ERROR	Node BMC Update	No compatible image, end process
DC6F04	ERROR	Node BMC Update	Cannot connect to TFTP server, end process
DC6F05	ERROR	Node BMC Update	Update BMC fail:[message]
DD6F00	INFO	Node BIOS Update	Start update BIOS
DD6F01	INFO	Node BIOS Update	Update BIOS success
DD6F02	WARN	Node BIOS Update	Node is busy, end process
DD6F03	ERROR	Node BIOS Update	No compatible image, end process
DD6F04	ERROR	Node BIOS Update	Cannot connect to TFTP server, end process
DD6F05	ERROR	Node BIOS Update	Update BIOS fail:[message]
DE6F00	INFO	Get Node SEL	Getting node SEL
DE6F01	INFO	Get Node SEL	Get node SEL complete
DE6F02	WARN	Get Node SEL	Cannot find SEL record
DE6F03	INFO	Clear Node SEL	Clearing node SEL
DE6F04	INFO	Clear Node SEL	Clear node SEL complete
DE6F05	INFO	Dump Node SEL	Starting to dump node SEL file
DE6F06	INFO	Dump Node SEL	Dump node SEL complete