

## M Public Display Stand 210 Dual Screen 70"-110"

Stand for LCD / plasma panel - aluminum - black - Dual screen size: 70" - 110"  
- mounting interface: up to 1200 x 900 mm - wheel-standing

- ar يضرراً نوي زفلت لم اح
- dk Gulvstativ
- de Bodenständer
- el Επιδαπέδια βάση
- en Floor Stand
- es Soporte de suelo
- fi Lattiateline
- fr Socle au sol
- it Supporto da terra
- no Gulvstativ
- pl Podstawa na podłogę
- ru Напольная подставка
- se Golvstativ
- tr Zemin Sehpası
- zh 落地架

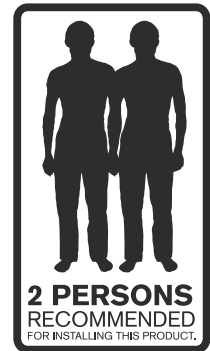



**مهم!**  
 قبل تثبيت البلازما أو LCD أو التلفاز أو جهاز العرض أو شاشة جهاز العرض أو أجهزة هاي فاي الأخرى لجهاز ذات قيمة عالية، اكدت الطراحي مرفقة، فقد لا تكون مناسبة لعمامة الجدار أو السقف أو الأرضية.  
 عندئذ بالطراحي أخرى مناسبة إذا لزم الأمر.  
 • حذرة عدم المماثلة بأي جزئية من جزئيات تركيب هذا المنتج، يرجى استشارة فني متخصص.



**VIGTIGT!**  
 Din plasmaskærm, LCD-skærm, tv, projektor, projektor-skærm eller andet HiFi-udstyr repræsenterer en betydelig værdi.  
 Hvis der medfølger skruer, passer de muligvis ikke til materialet i væggen, loftet eller gulvet.  
 Udskift skruerne med passende skruer, hvis det er nødvendigt.

Hvis du er i tvivl om noget i forbindelse med monteringen af produktet, skal du kontakte en ekspert.



**ACHTUNG!**  
 Ihr Plasma-, LCD-, TV-Gerät, Ihr Projektor, Ihre Leinwand oder sonstige HiFi-Ausrüstung stellt einen beträchtlichen Wert dar.  
 Die möglicherweise im Lieferumfang enthaltenen Schrauben sind unter Umständen nicht für das Material ihrer Wände, Decken oder Böden geeignet.  
 Ersetzen Sie sie bei Bedarf durch geeignete Schrauben.

Wenn Sie bezüglich der Montage des Produkts unsicher sind, wenden Sie sich an einen Fachman



**ΣΗΜΑΝΤΙΚΟ!**  
 Οι τηλεοράσεις Plasma, LCD, οι κανονικές τηλεοράσεις, οι οθόνες προβολέων ή άλλες συσκευές HiFi έχουν μία αξιοσημείωτη αξία.  
 Αν περιλαμβάνονται βίδες ίσως να μην είναι κατάλληλες για το υλικό του τοίχου, του ταβανιού ή του πατώματός σας.  
 Αντικαταστήστε τις βίδες με κατάλληλες αν είναι απαραίτητο.

Στην περίπτωση που δεν είστε σίγουροι για κάποιες ζητήματα σχετικά με την προσάρτηση αυτού του προϊόντος, παρακαλούμε συμβουλευτείτε έναν ειδικό.



**IMPORTANT!**  
 Your Plasma, LCD, TV, Projector, Projector Screen or other HiFi equipment represents a considerable value.  
 If screws are included they may not be suitable for the material of your wall, ceiling or floor.  
 Replace the screws with suitable ones if needed.

In case you are unsure regarding any aspects of the mounting of this product please Consult a professional.



**IMPORTANTE**  
 Los equipos de plasma o LCD, los televisores, proyectores y pantallas de proyección, así como otros equipos de alta fidelidad suponen una inversión considerable.  
 Si incluyen tornillos, puede que no sean adecuados para el material del que estén formados la pared, el techo o el suelo.  
 Sustituya estos tornillos por otros más adecuados si es preciso.

Si no está seguro sobre cualquier aspecto del montaje de este producto, consulte a un profesional.



**TÄRKEÄÄ!**  
 Plasma- tai nestekidenäyttöjen, televisioiden, projektorien ja niiden valkokankaiden sekä muiden hi-fi-laitteiden arvo on huomattava.  
 Laitteen mukana toimitettavat ruuvit eivät välttämättä sovellu seinien, katon tai lattian materiaaliin.  
 Korvaa ne tarvittaessa sopivilla ruuveilla.

Mikäli olet epävarma mistä tahansa tämän tuotteen kiinnittämiseen liittyvästä seikasta, ota yhteys asiantuntijaan.



**IMPORTANT!**  
 Vos écrans plasma, LCD, télévisions, projecteurs, écrans de projection ou autre matériel Hi Fi ont une valeur considérable.  
 Les vis fournies peuvent ne pas être compatibles à la nature de vos murs, plafonds et sols.  
 Remplacez-les par des vis adaptées.

Si vous avez des doutes quant au montage de ce produit, veuillez consulter un professionnel.



**IMPORTANTE!**  
 I vostri plasma, LCD, TV, proiettori, schermi di proiezione o altri apparecchi Hi-Fi rappresentano un notevole investimento.  
 Le viti in dotazione potrebbero rivelarsi non adatte per il materiale della parete, del soffitto o del pavimento.  
 Sostituitele quindi con viti più idonee in caso di necessità.

Nel caso riscontriate problemi nel montaggio di questo prodotto, consultate un tecnico specializzato.



**VIKTIG!**  
 Din plasma, LCD, TV, projektor, projektor-skjerm eller annet HiFi-utstyr har betydelig verdi.  
 Hvis skruer følger med, er det ikke sikkert at de passer til materialet i veggen, taket eller gulvet.  
 Bytt skruene i skruer som er egnet om nødvendig.

Hvis du er usikker når det gjelder monteringen av dette produktet, må du kontakte en profesjonell.



**UWAGA!**  
 Monitor plazmowy, LCD, telewizor, projektor, ekran projekcyjny lub inny sprzęt HiFi stanowią znaczną wartość.  
 Jeśli dołączono do niego śruby mocujące, mogą one nie być odpowiednie do materiału, z którego wykonane są dane ściany, sufit lub podłoga.  
 W razie potrzeby należy je zastąpić odpowiednimi śrubami.

W razie jakichkolwiek wątpliwości dotyczących montowania tego urządzenia należy zasięgnąć porady u specjalisty.



**ВНИМАНИЕ!**  
 Каким бы оборудованием HiFi вы ни пользовались, будь то плазменный, ЖК или стандартный телевизор, проектор или проекционный экран, - все они представляют значительную ценность.  
 Не всегда крепления, прилагаемые в комплекте, подходят к материалу ваших стен, потолка или пола.  
 При необходимости замените их на более подходящие.

Если у вас есть какие-либо сомнения относительно того, как крепить данный продукт, пожалуйста, проконсультируйтесь у квалифицированного специалиста.



**VIKTIGT!**  
 Din plasmaskärm, LCD-skärm, TV, projektor, projektor-skärm eller annan HiFi-utrustning representerar ett anseeligt värde.  
 Om skruvar medföljer utrustningen är det inte säkert att de passar för materialet i väggen, taket eller golvet!  
 Byt ut skruvarna mot lämpliga skruvar om så krävs.  
 Kontakta en expert om du är osäker på något i samband med monteringen av produkten.



**ÖNEMLİ!**  
 Plazma, LCD, TV, Projektör, Projektör Ekranınız veya diğer HiFi cihazınız son derece değerlidir.  
 Birlikte verilen vidalar duvar, tavan veya döşeme teçhizatınıza uygun olmayabilir.  
 Gerektiğinde vidaları uygun olanlarla değiştirin.

Bu ürünün monte şekilleri ile ilgili sorunlarınız olması halinde bir uzmandan yardım alın.



**重要提示!**  
 您的等离子、LCD、TV、投影机、投影仪屏幕或其它 HiFi 设备都有着不菲的价值。  
 如果附带有螺钉，它们可能不适合您的墙壁、天花板或地板。  
 如果需要，请将螺钉更换为适当的型号。

如果对本产品安装的任何方面有疑问，请咨询专业人士。

## WARRANTY CARD

MULTIBRACKETS . C ● M

MULTIBRACKETS™ Limited Warranty  
 Multibrackets warrants its products to be free of defects in material and workmanship for the product's Warranty Period. The Warranty Period commences on the original purchase date of the product.

All Multibrackets products are covered by a limited product warranty:

- FIVE (5) years for metal video monitor mounts; all racks and non-electrical rack accessories
- ONE (1) year for all motorized and/or automated products, plastic speaker mounts; all speaker stands; all furniture; all wood (MDF) accessories









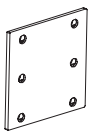
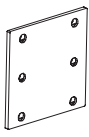
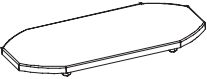
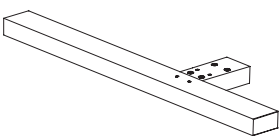
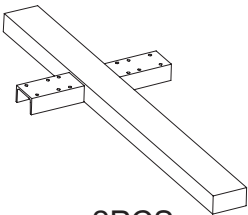
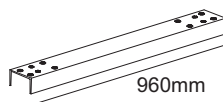
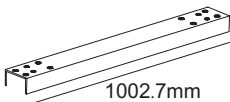
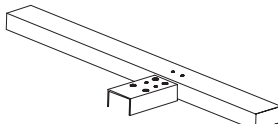
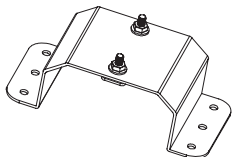
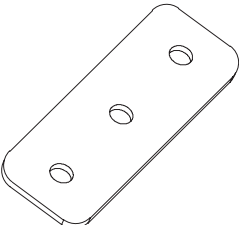
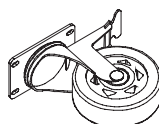
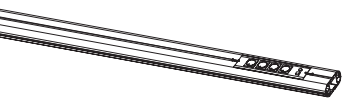
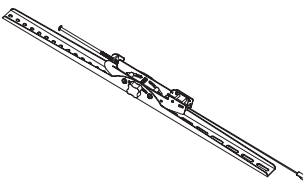
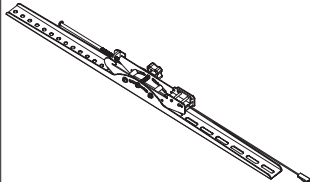
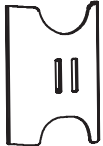









For warranty claims made during the Warranty Period, MULTI BRACKETS will replace any defective product part free of charge. Should a part on your Multibrackets product fail, please create an RMA case on [www.multibrackets.com/support](http://www.multibrackets.com/support) to make a warranty claim. We will await your documentation and then discuss the problem with you and once we confirm the product is under warranty, we will ship replacement parts to you. This Limited Warranty does not cover the costs of removing and replacing defective parts from your Multibrackets product. So, if your problem requires a repair technician, you must pay any labor charges.

This Limited Warranty extends only to the original purchaser of the product and is automatically void if your Multibrackets product is modified in any way, improperly installed, taxed beyond its stated weight capacity or otherwise misused or abused. All Multibrackets products are intended for indoor use only and any

outdoor use voids this Limited Warranty. The Limited Warranty for wall and ceiling mounts is void if the mount is moved from its initial installation. To the maximum extent permitted by applicable law, Multibrackets disclaims any other warranties, express or implied, including warranties of fitness for a particular purpose and warranties of merchantability. Multibrackets will not be liable for any damages whatsoever arising out of the use or inability to use its products, even if Multibrackets has been advised of the possibility of such damages. To the maximum extent permitted by applicable law, Multibrackets disclaims any responsibility for incidental or consequential damages.

Multibrackets™ Stockholm Sweden 2014, [www.multibrackets.com](http://www.multibrackets.com)

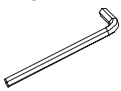
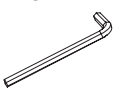
			
2PCS	1PCS	1PCS	4PCS
		 960mm	 1002.7mm
1PCS	2PCS	1PCS	2PCS
			
1PCS	4PCS	8PCS	4PCS
			
4PCS	2PCS	2PCS	20PCS

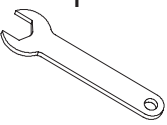
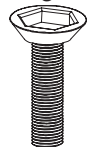
<b>A</b>  M8x15 32PCS  M8 32PCS		<b>B</b>  M8x25 32PCS		<b>C</b>  M8x35 8PCS  M8 8PCS		<b>D</b>  M8x20 18PCS  M8 18PCS		<b>E</b>  M8 8PCS		<b>F</b>  M10x25 8PCS  M8x25 8PCS  M6x25 8PCS  M5x15 8PCS	
<b>G</b>  M10 8PCS  M8 8PCS  M6 8PCS  M5 8PCS				<b>H</b> 8mm  2PCS 6mm  2PCS 5mm  2PCS 4mm  2PCS				<b>I</b>  14mm 1PCS		<b>J</b>  M8x35 8PCS	

# 1

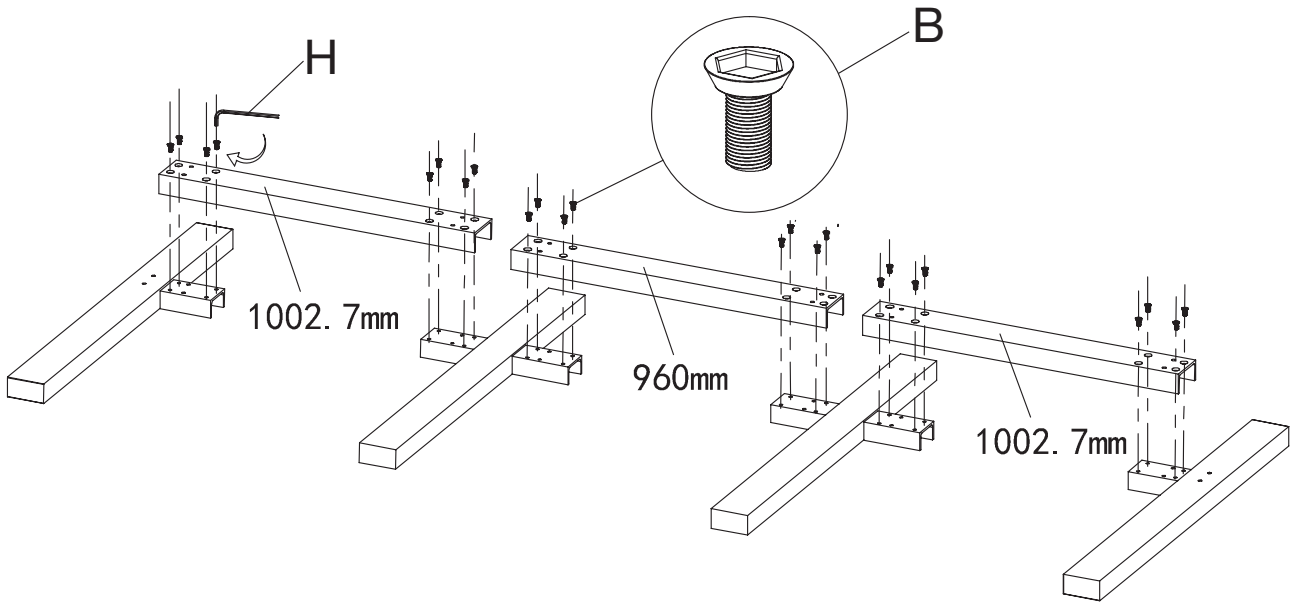

# 2

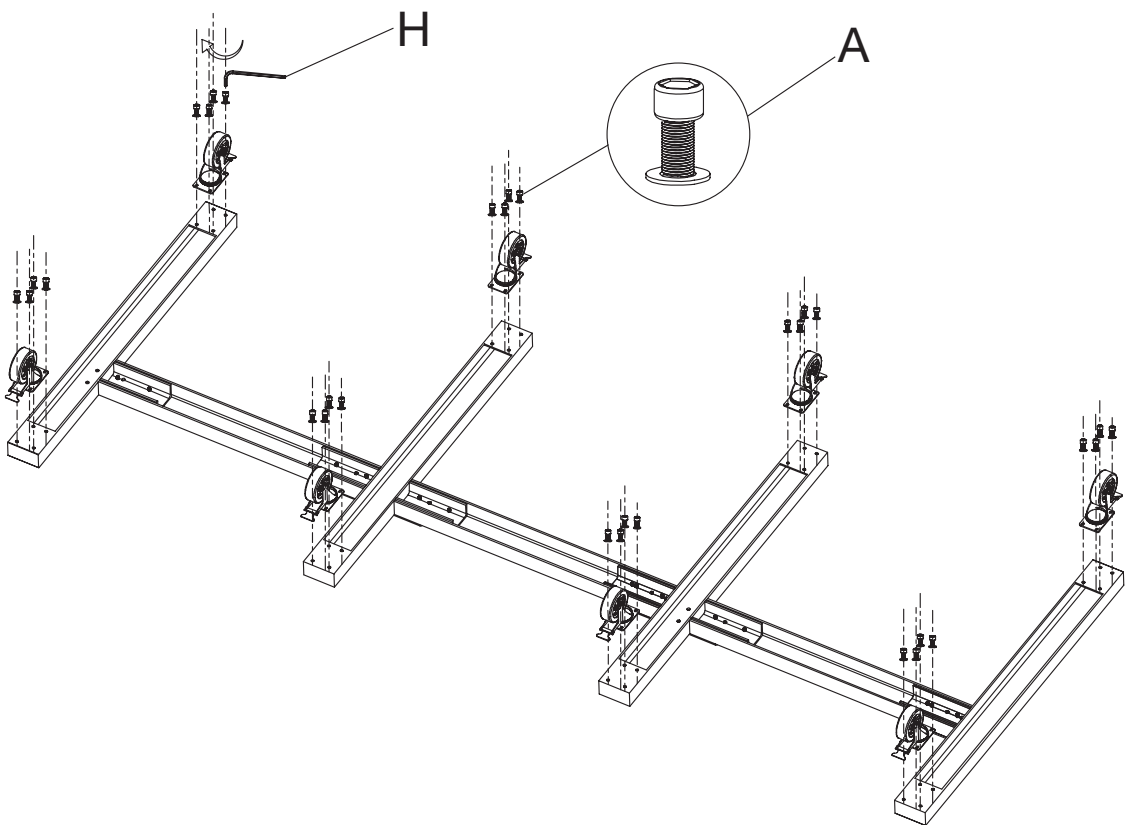

3

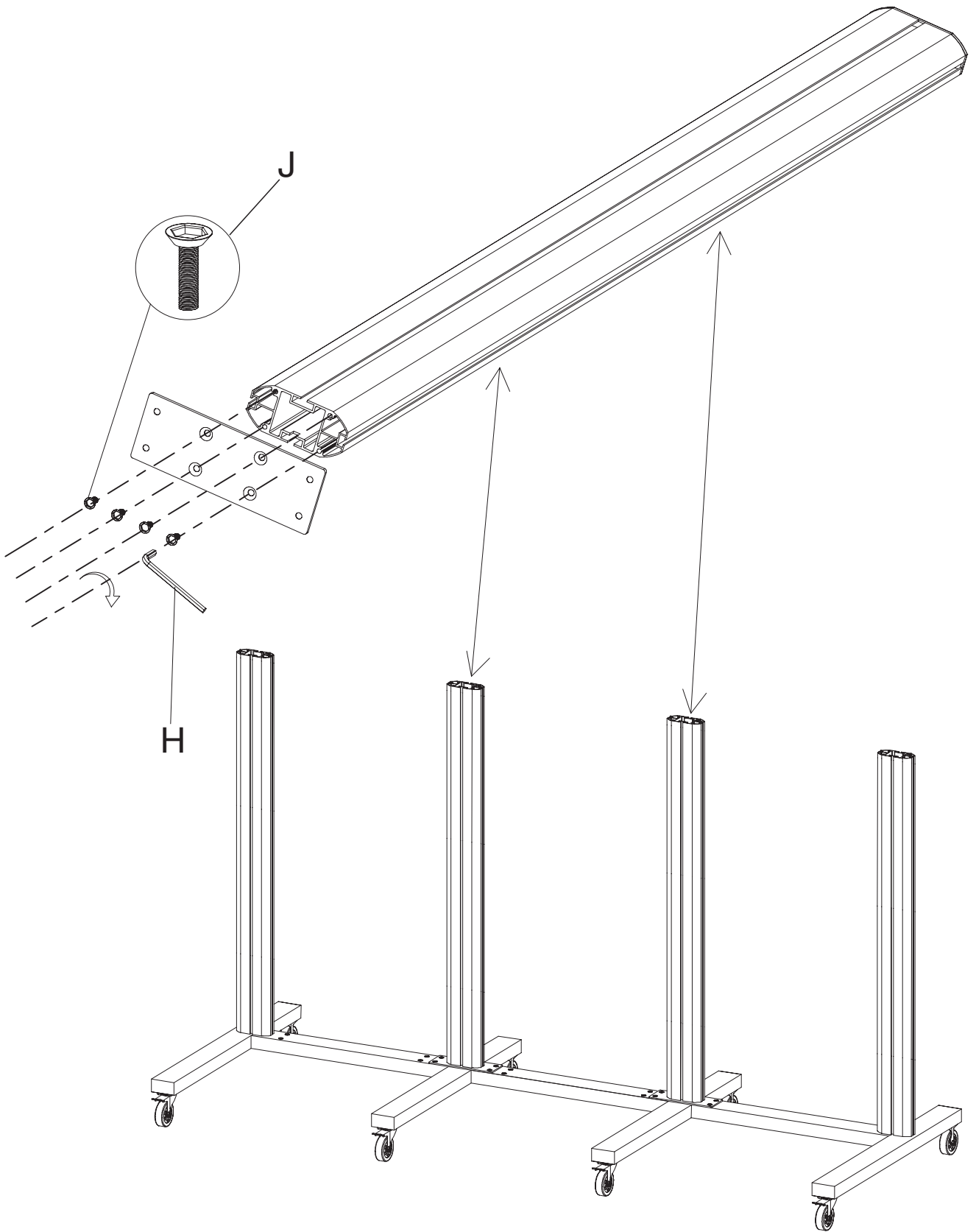



4

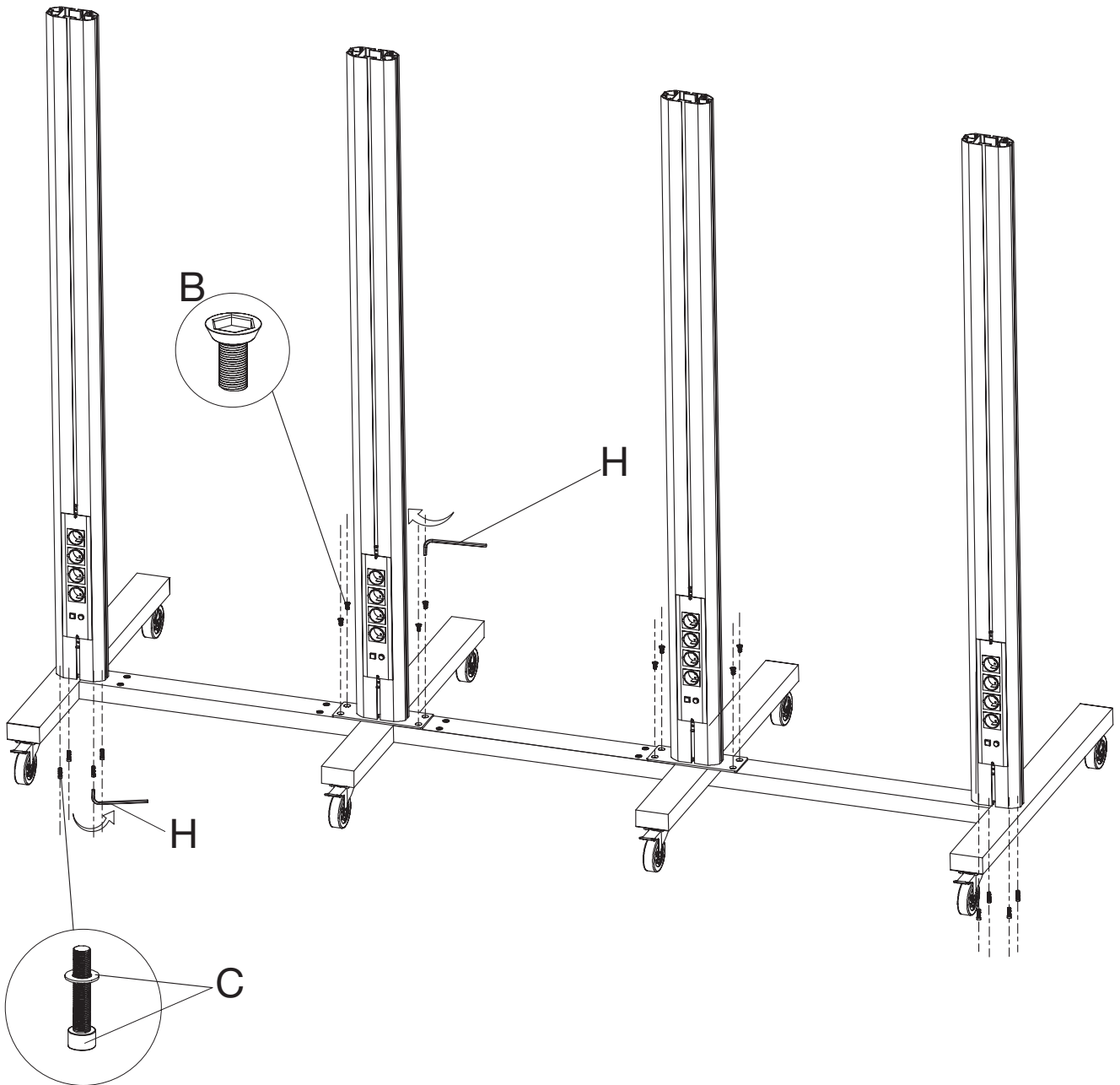

# 5

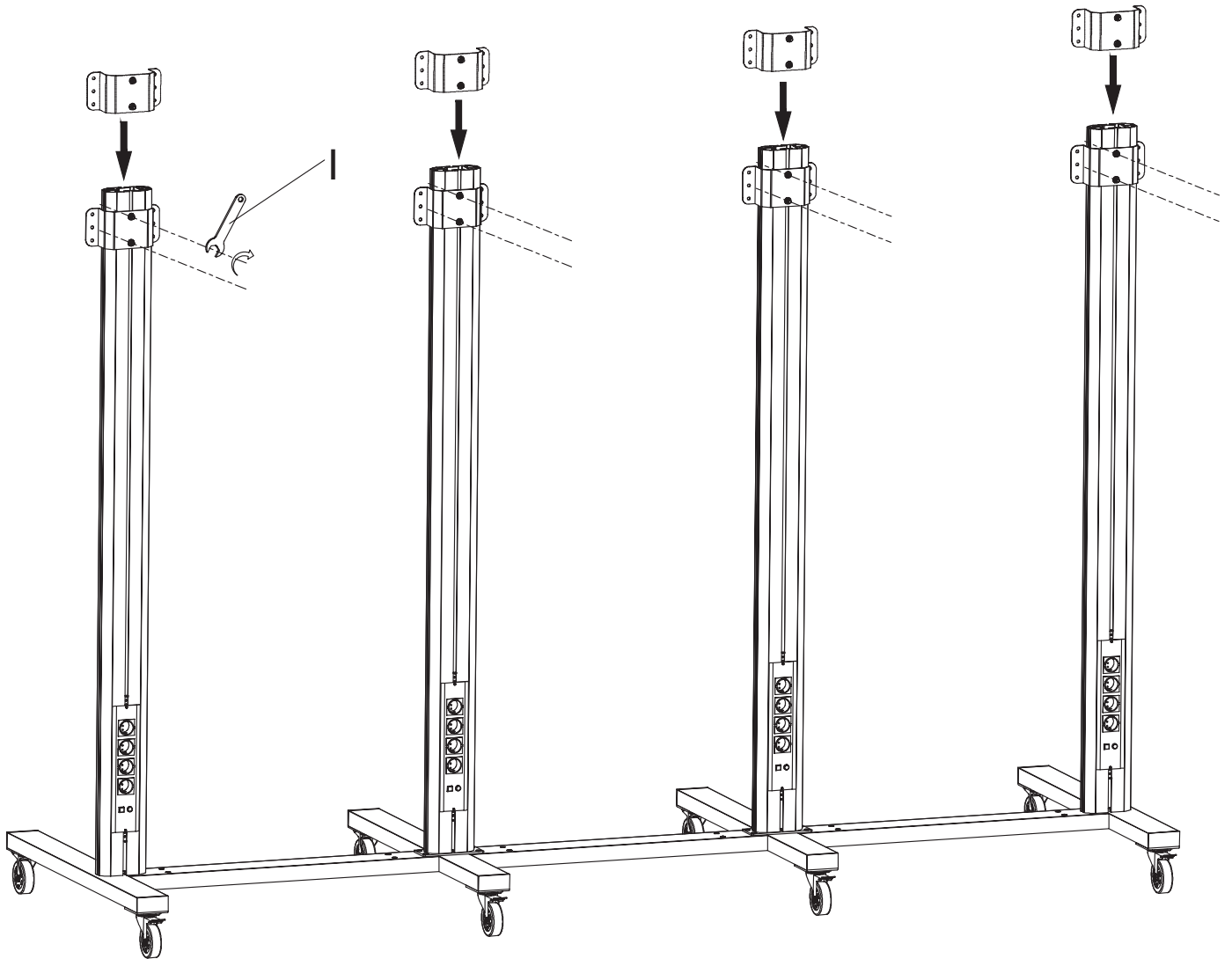

6

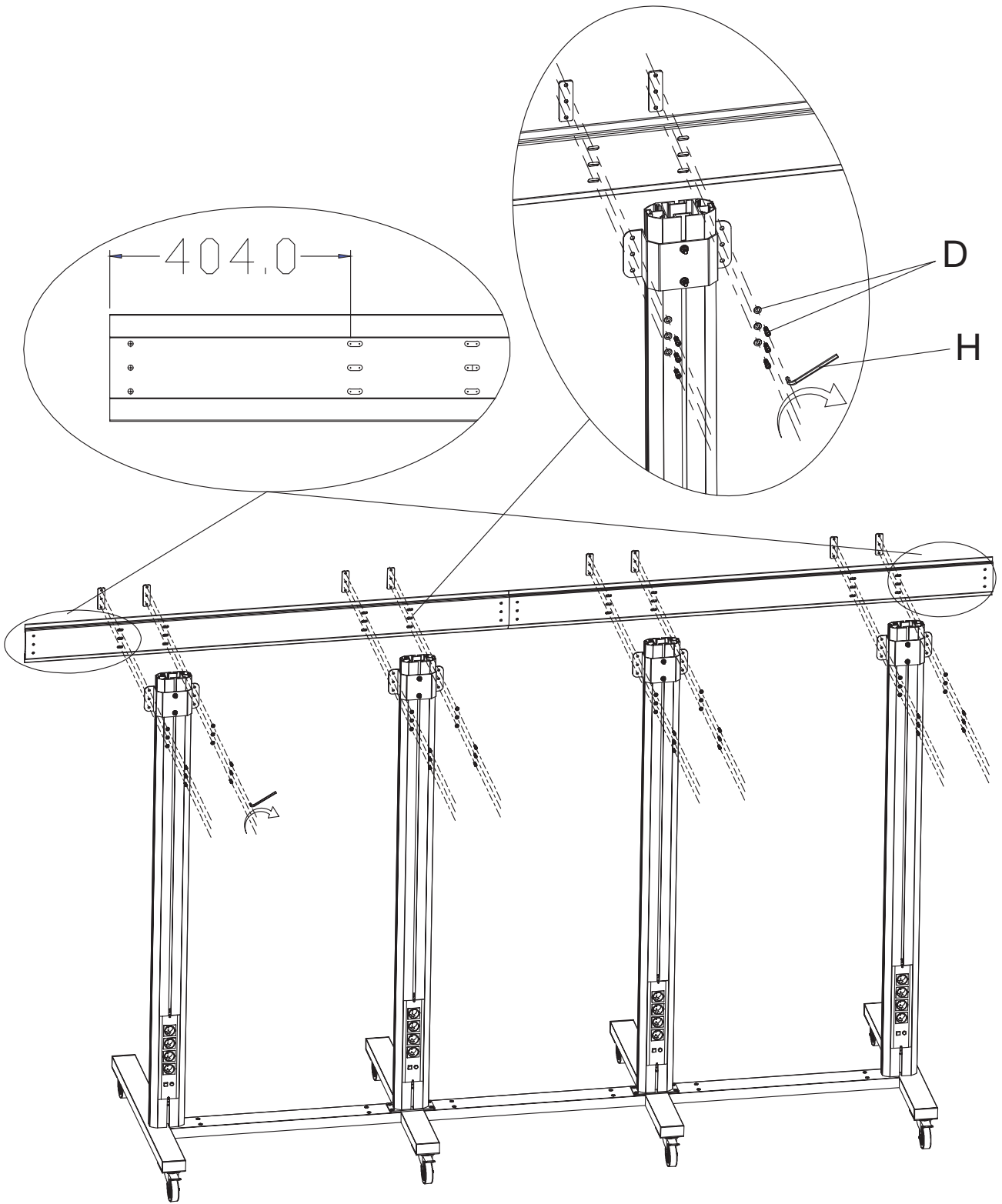



7

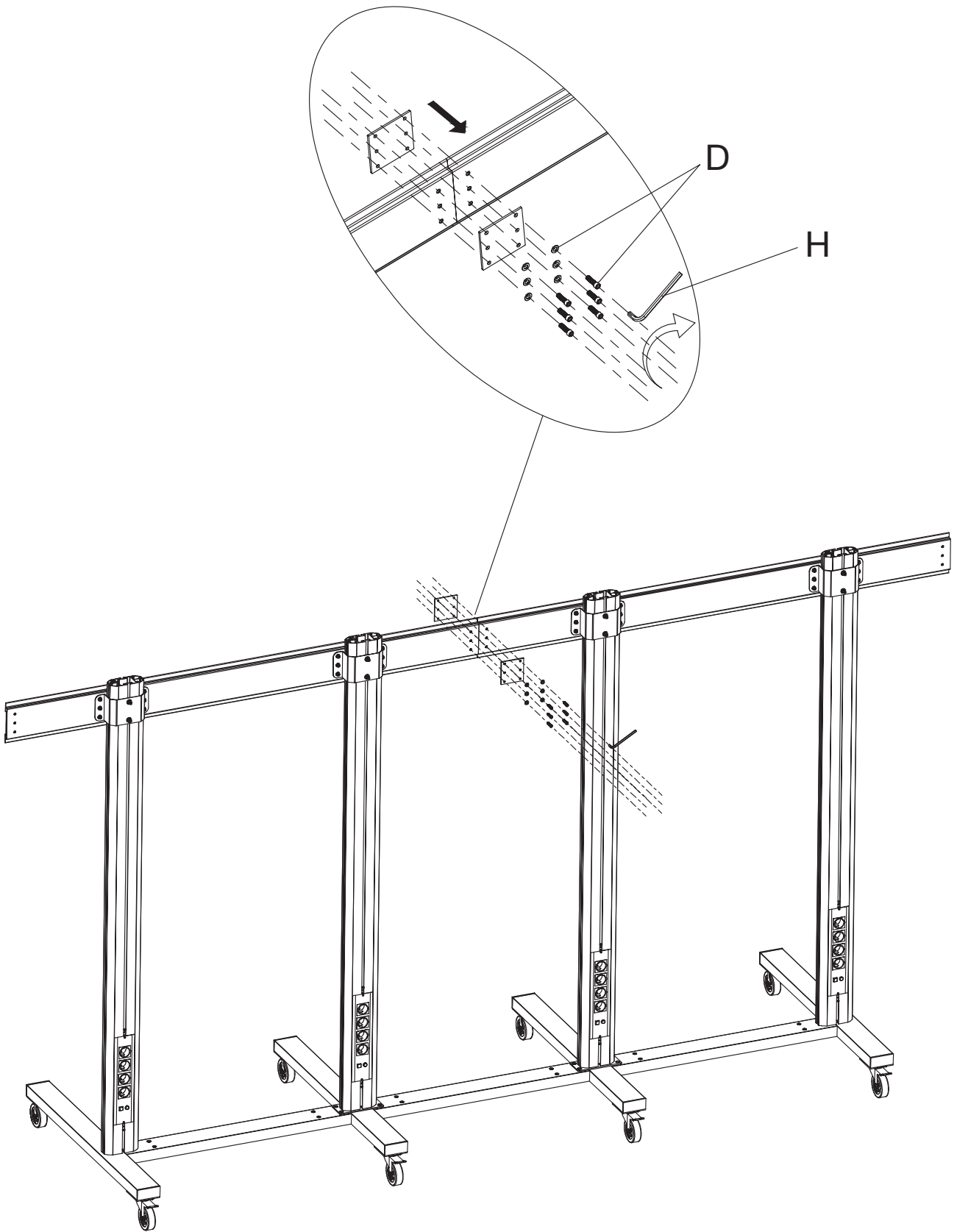

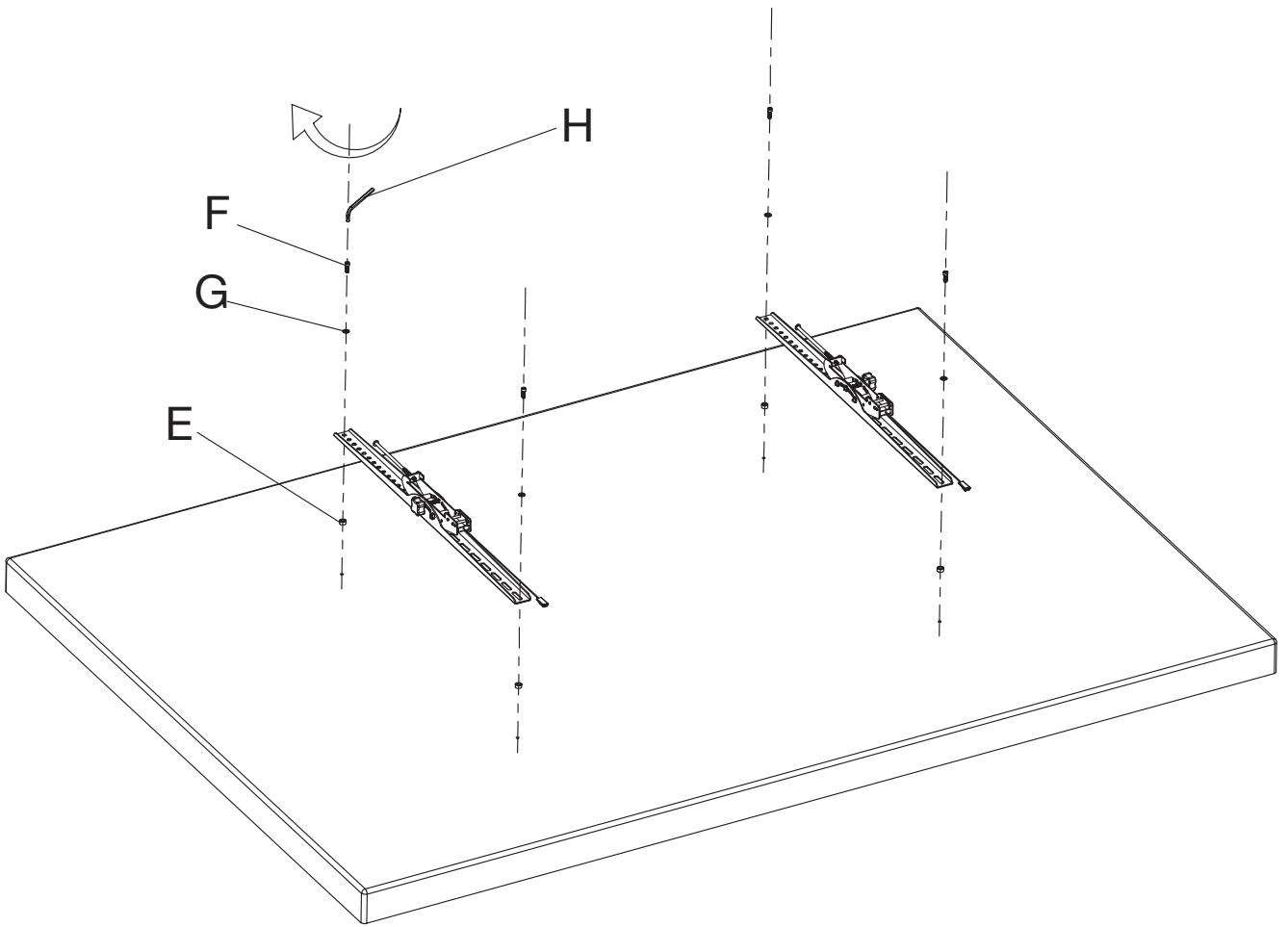

9

