

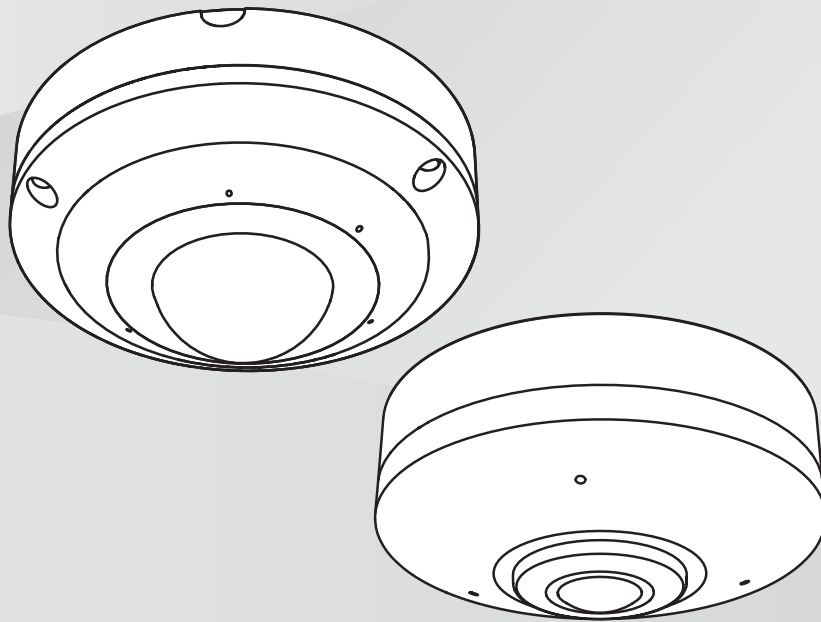

BOSCH

FLEXIDOME panoramic 5100i | FLEXIDOME panoramic 5100i IR

NDS-5703-F360 | NDS-5704-F360 | NDS-5703-F360LE |
NDS-5704-F360LE



en

User manual

Table of contents

1	Browser connection	5
1.1	System requirements	5
1.2	Establishing the connection	5
1.3	Password protection in camera	5
2	System overview	7
2.1	Live	7
2.2	Playback	7
2.3	Configuration	7
2.4	Dashboard	8
3	Operation via the browser	9
3.1	Live page	9
3.2	Playback page	11
3.2.1	Selecting the recording stream	11
3.2.2	Searching for recorded video	12
3.2.3	Exporting recorded video	12
3.2.4	Track list	12
3.2.5	Controlling playback	12
3.3	Dashboard	12
4	Configuration	14
4.1	General	14
4.1.1	Identification	14
4.1.2	User Management	14
4.1.3	Date/Time	15
4.2	Web Interface	16
4.2.1	Appearance	16
4.2.2	'Live' functions	18
4.3	Connectivity	19
4.3.1	Cloud services	19
4.3.2	Accounts	19
4.3.3	DynDNS	20
4.4	Camera	20
4.4.1	Installer Menu	20
4.4.2	Display Stamping	21
4.4.3	Positioning	22
4.4.4	Scene Mode	24
4.4.5	Color	25
4.4.6	ALC (Automatic Level Control)	25
4.4.7	Enhance	27
4.4.8	Scene mode scheduler	27
4.4.9	Encoder Streams	27
4.4.10	Encoder Statistics	29
4.4.11	Privacy Masks	30
4.4.12	Audio	30
4.4.13	Pixel Counter	31
4.5	Recording	31
4.5.1	Storage Management	31
4.5.2	Recording Profiles	33
4.5.3	Maximum Retention Time	34

4.5.4	Recording Scheduler	35
4.5.5	Recording Status	35
4.5.6	Recording Statistics	35
4.5.7	Image Posting	36
4.5.8	SD Card Status	36
4.6	Alarm	37
4.6.1	Alarm Connections	37
4.6.2	Video Content Analysis (VCA)	38
4.6.3	Audio Alarm	38
4.6.4	Alarm E-Mail	39
4.6.5	Alarm Inputs	40
4.6.6	Alarm Outputs	40
4.6.7	Alarm Task Editor	40
4.7	Network	41
4.7.1	Network Services	41
4.7.2	Network Access	41
4.7.3	Advanced	43
4.7.4	Network Management	43
4.7.5	Multicast	44
4.7.6	IPv4 Filter	45
4.8	Service	46
4.8.1	Maintenance	46
4.8.2	Licenses	47
4.8.3	Certificates	47
4.8.4	Logging	47
4.8.5	System Overview	48
5	Troubleshooting	49
5.1	Physical reset button	49
6	Appendices	50
6.1	Copyright notices	50
6.2	More information	50

1 Browser connection

A computer with a web browser (Google Chrome, Microsoft Edge, or Mozilla Firefox) is used to receive live images, control the unit, and replay stored sequences. The unit is configured over the network using the browser.

1.1 System requirements

Our recommendations are:

- Computer with Dual core HyperThreading processor or better
- Graphic card with performance that matches or is better than the resolution of the camera
- Windows 10 or later
- Network access
- Google Chrome, Microsoft Edge, or Mozilla Firefox

- or -

Application software, for example, Video Security Client, Bosch Video Client or BVMS.

1.2 Establishing the connection

The unit must have a valid IP address and a compatible subnet mask to operate on your network. By default, DHCP is pre-set at the factory to **On** and so your DHCP server assigns an IP address. With no DHCP server the default address is 192.168.0.1

The Project Assistant app or Configuration Manager (version 7.50 or higher) can be used to find the IP address. Download the software from <https://downloadstore.boschsecurity.com/>:

1. Start the web browser.
2. Enter the IP address of the device as the URL.
3. During the initial installation, confirm any security questions that show.

If a RADIUS server is used for network access control (802.1x authentication), you must configure the device before the device can communicate with the network.

To configure the device, connect it directly to a computer using a network cable and then set the service-level password.

Note:

If you cannot connect, the unit may have reached its maximum number of connections.

Depending on the device and network configuration, each unit can have up to 50 web browser connections, or up to 100 connections via Bosch Video Client or BVMS.

1.3 Password protection in camera

The device is password-protected. The first time that any user accesses the device, the device will prompt the user to set a password at the service level.

The camera requires a strong password. Follow the prompts in the dialog box, which specifies what is required. The system measures the strength of the password that you enter.

Make sure the password obeys these conditions:

- 8 to 19 characters in length
- Upper and lower case letters
- Minimum of 1 digit
- Minimum of 1 special character

These special characters are not allowed: '@', '&', '<', '>', ':', '+'

When you use Configuration Manager to access your device for the first time, you must set the initial password of the device in Configuration Manager. The Users section (General > Unit Access > Users) displays the message, "Before you can use this device you have to secure it with an initial password."

Note: After you set the initial password, a "lock" icon appears next to the device name in the **Devices** list in Configuration Manager.

You can also launch the device webpage directly. In the device webpage, an initial password page appears, displaying input fields and a password strength gauge.

Enter the user name ("**service**") and a password in the appropriate fields. Refer to the section **User Management** for more information.







After a service-level password is set for the device, the device displays a dialog box that prompts users to enter the user name ("**service**") and the service-level password every time that they access the device.

1. Fill in the fields **User name** and **Password**.
2. Click **OK**. If the password is correct, the desired page appears.

Note: New releases of software may require you to set a new and stronger password.

2 System overview

Note: None of the pages are accessible until after you set a service-level password. When a connection is established, the **Live** page is initially displayed. The application bar displays the following icons:

	Live	Click this icon to view the live video stream.
	Playback	Click this icon to play back recorded sequences. This link is only visible if a storage medium has been configured for recording. (With VRM recording, this option is not active.)
	Configuration	Click this icon to configure the device.
	Dashboard	Click this icon to see detailed system information.
	Links	Click this icon to navigate to the Bosch download store.
	Logout	Click this icon to log out of the device.
		Click this icon to get context-sensitive help for the page you are browsing.

2.1 Live

The **Live** page is used to display the live video stream and control the unit.

2.2 Playback

The **Playback** page is used for playing back recorded sequences.

2.3 Configuration

The **Configuration** page is used to configure the unit and the application interface.

Making Changes

Each configuration screen shows the current settings. You can change the settings by entering new values or by selecting a predefined value from a list field.

Not every page has a **Set** button. Changes to pages without a **Set** button are set immediately. If a page does show a **Set** button, you must click the **Set** button for a change to take effect.



Notice!

Save each change with the associated **Set** button.

Clicking the **Set** button saves the settings only in the current field. Changes in any other fields are ignored.

Some changes only take effect after the unit is rebooted. In this case, the **Set** button changes to **Set and Reboot**.

1. Make the desired changes.

2. Click the **Set and Reboot** button. The camera reboots and the changed settings are activated.

2.4 Dashboard

The **Dashboard** page is used to display detailed information about the device.

The **Dashboard** is only visible in the application bar if the **Show 'Dashboard'** option is enabled by a service-level user in the **Configuration -> Web Interface -> Appearance** page.

3 Operation via the browser

3.1 Live page

After the connection is established, the **Live** page is initially displayed. It shows the live video image on the right of the browser window. Depending on the configuration, various text overlays may be visible on the live video image.

Other information may also be shown next to the live video image. The items shown depend on the settings on the '**Live**' functions page.

Connection

In the **Connection** group, you can configure the **Dewarping** and the **Stream** option.

Dewarping



Notice!

For client-side dewarping, it is recommend to use Configuration Manager, BVMS, or a third-party video management system. Edge dewarping will be supported in a future firmware release.

You can select one of the three available video channels for viewing:

1. On the left side of the browser, expand the **Connection** group if necessary.
2. Click the **Dewarping** drop-down arrow to see the options. The options include:
 - **Off**
 - **E-PTZ**
 - **Full panoramic**: One panoramic image is shown.
 - **Double panoramic**: Two independent panoramic images are shown. They can be adjusted independently on the **Live** preview.
 - **Corridor**: Two independent corridor images are shown. They can be adjusted independently on the **Live** preview.
 - **Quad**: Four independent panoramic images are shown. They can be adjusted independently on the **Live** preview.
3. Select the dewarping option you wish to use.

Image selection

To view a live stream:

1. On the left side of the browser, expand the **Connection** group if necessary.
2. Click the **Stream** drop-down arrow to see the options.
3. Select the stream you wish to view.

Digital I/O

(Only applicable to FLEXIDOME panoramic 5100i IR: NDS-5703-F360LE, NDS-5704-F360LE)

Depending on the configuration of the unit, the alarm input and the output are displayed next to the image. Expand the Digital I/O group if necessary.

The alarm symbol is for information and indicates the status of an alarm input:

- The symbol lights when the input alarm is active.

The alarm output allows the operation of an external device (for example, a light switch or a door opener).

- To activate the output, click the checkmark symbol.
 - The symbol lights when the output is activated.

Image orientation



Notice!

For client-side dewarping, it is recommend to use Configuration Manager, BVMS, or a third-party video management system. Image orientation with edge dewarping will be supported in a future firmware release.

With dewarping on, you can control the image with the mouse.

- Place the cursor within the image.
- Click an arrow to orientate the image.
- Use the scroll wheel to zoom in and out.

To see the correct orientation of the image, ensure that the mount position and height have been filled-in correctly in **Configuration >> Camera >> Installer menu >> Positioning**.

Recording status



The hard drive icon below the live camera image changes during an automatic recording. The icon lights up and displays a moving graphic to indicate a running recording. If no recording is taking place, a static icon is displayed.

Full-screen display



Click the full-screen icon to view the selected stream in full-screen mode; press **Esc** on the keyboard to return to the normal viewing window.

Start Video Security app



To start the Video Security app, click .

Show latest event



Click the **Show latest event** icon to watch the last recorded important events. The **Playback** page opens.

Storage, CPU and network status



When accessing the unit with a browser, the local storage, processor and network status icons are shown in the upper right of the window.

When a local storage card is available, the memory card icon changes color (green, orange or red) to indicate the local storage activity. If you hover over this icon with the mouse the storage activity is shown as a percentage.

If you hover over the middle icon, the CPU load is shown.

If you hover over the right-hand icon, the network load is shown.

This information can help with problem solving or when fine tuning the unit. For example:

- if the storage activity is too high, change the recording profile,
- if the CPU load is too high, change the VCA settings,
- if the network load is too big, change the encoder profile to reduce bitrate.

Status icons

Various overlays in the video image provide important status information. The overlays provide the following information:



Decoding error

The frame might show artifacts due to decoding errors.



Alarm flag

Indicates that an alarm has occurred.



Communication error

A communication error, such as a connection failure to the storage medium, a protocol violation or a timeout, is indicated by this icon.



Gap

Indicates a gap in the recorded video.



Watermark valid

The watermark set on the media item is valid. The color of the check mark changes according to the video authentication method that has been selected.



Watermark invalid

Indicates that the watermark is not valid.



Motion alarm

Indicates that a motion alarm has occurred.



Storage discovery

Indicates that recorded video is being retrieved.

3.2

Playback page



Click **Playback** in the application bar to view, search or export recordings. This link is only visible when a direct iSCSI or memory card is configured for recording (with Video Recording Manager (VRM) recording this option is not active).

On the left side of the screen, there are four groups:

- **Connection**
- **Search**
- **Export**
- **Track list**

3.2.1

Selecting the recording stream

On the left side of the browser, expand the **Connection** group if necessary.

To view a recording stream:

1. Select the **Dewarping** option.
2. Click the **Recording** arrow to see the options.
3. Select recording stream 1 or 2.

3.2.2 Searching for recorded video

On the left side of the browser, expand the **Search** group if necessary.

1. To limit the search to a particular time range, enter the date and times for the start and stop points.
2. Select an option from the drop-down box to define a search parameter.
3. Click **Search**.
4. The results are shown.
5. Click a result to play it back.
6. Click **Back** to define a new search.

3.2.3 Exporting recorded video

On the left side of the browser, expand the **Export** group if necessary:

1. Select a track in the track list or in the search results.
2. The start and stop date and time are filled for the selected track. If necessary, change the times.
3. In the **Time lapse** drop-down box, select **Original**, to export the recorded video as its original, **Condensed** to export the recorded video condensed to the given output time.
4. In the **Location** drop-down box, select a target.
5. Click **Export** to save the video track.

Note:

The target server address is set on the **Connectivity > Accounts** page.

3.2.4 Track list

The **Track list** shows all the available recordings.

3.2.5 Controlling playback

The time bar below the video image allows quick orientation. The time interval associated with the sequence is displayed in the bar in gray. Arrows indicate the position of the image currently being played back within the sequence.

The time bar offers various options for navigation in and between sequences.

- If required, click in the bar at the point in time at which the playback should begin.
- Change the time interval displayed by clicking the plus or minus icons or use the mouse scroll wheel. The display can span a range from six months to one minute.
- Click the alarm jump buttons to go from one alarm event to the next or to the previous one. Red bars indicate the points in time where alarms were triggered.

Controls

Control playback by means of the buttons below the video image.

The buttons have the following functions:

- Start/Pause playback
- Select the playback (forward or backward) speed using the speed regulator
- Step forward or backward frame-by-frame when paused (small arrows)

3.3 Dashboard

The **Dashboard** page shows information on 4 topics:

- **Device status**
- **Recording status**
- **Connection Status**
- **Services**

You can also download a .JSON file with information about the device:

1. At the bottom of the page, locate the **Export** button
2. Click the **Export** button
3. Select a location in your hard drive to store the file

4 Configuration

4.1 General

4.1.1 Identification

Device name

Assign a unique name to assist in identification. This name simplifies the management of multiple devices in more extensive systems.

The name is used for remote identification, for example, in the event of an alarm. Choose a name that makes it as easy as possible to identify the location unambiguously.

Device ID

Each device should be assigned a unique identifier that can be entered here as an additional means of identification.

Video name

Each video channel can be given a name. Click the + sign to add an extra line.

Host name

Enter the host name registered for the device.

Initiator extension

Add text to an initiator name to make identification easier in large iSCSI systems. This text is added to the initiator name, separated from it by a full stop. (You can see the initiator name in the System Overview page.)

Click **Set** to apply the changes.

4.1.2 User Management

A password prevents unauthorized access to the device. You can use different authorization levels to limit access.

Proper password protection is only guaranteed when all higher authorization levels are also protected with a password. Therefore, you must always start from the highest authorization level when assigning passwords.

You can define and change a password for each authorization level if you are logged into the “service” user account.

Authentication modes

The section **Authentication modes** provides information about the authentication modes set in the camera. A checkmark appears in the checkbox to the left of the mode if the mode is set. If the mode is not set, the phrase “No certificate installed” appears to the right of the mode name.

This device has three authentication modes:

- **Password** indicates a password is set for the camera. It prevents unauthorized access to the device, and can use different authorization levels to limit access.
Proper password protection is only guaranteed when all higher authorization levels are also protected with a password. Therefore, you must always start from the highest authorization level when assigning passwords.
You can define and change a password for each authorization level if you are logged into the service user account.
- **Certificate.** A check mark in this check box indicates that at least one certificate is loaded onto the device.
The Trusted certificate is a root certificate for Bosch Security Systems that proves that the device meets the following criteria:
 - It originates from a Bosch factory that is a secure environment.

- It has not been tampered with.
The Trusted certificate is issued by Escrypt. Escrypt is a Bosch company and Certificate Authority (CA).
- **Active Directory server (AD FS)**. A check mark in this check box indicates that the device uses an active directory server.

Click **Set** to apply the changes.

Creating a new user

To create a new user, click **Add** in the section below **Authentication modes**.

In the box **User**, fill in the fields:

1. **User name**, Enter a name with a minimum of 5 and a maximum of 31 characters.
2. **Group**, select the appropriate authorization level:
 - live is the lowest authorization level. At this level, it is only possible to view the live video image, and switch between the different live image displays.
 - user is a middle authorization level. At this level, it is possible to operate the device and playback recordings, but configuration changes are not possible.
 - **IVA configuration** is a middle authorization level. At this level, it is only possible to configure VCA, but access is available to all user level functions like PTZ and Replay.
 - service is the highest authorization level. Entering the correct password gives access to all the functions, and allows all configuration settings to be changed.
3. **Type**, select either:
 - **Password** for a new password.
Use a minimum of 8 and a maximum of 19 characters. The password must have upper-case and lower-case letters, one or more numerical digits and one or more of these special characters ! ? " # \$ % () { } [] * - = . , ; ^ _ | ~ \
 - Special characters such as space @ : < > ' & + are not valid.
In this case, enter the new password a second time to eliminate typing mistakes.
 - **Certificate** for a certificate that the new user is authorized to use.
4. Click **Set** to confirm and create a new user.

To edit a password

To edit a password, click the pencil icon to the right of the column **Type** for the appropriate **User name**.

4.1.3

Date/Time

Date format

Select the required date format from the dropdown menu.

Device date/Device time



Notice!

Make sure that recording is stopped before synchronizing to the PC.

If there are multiple devices operating in your system or network, it is important to synchronize their internal clocks. For example, it is only possible to identify and correctly evaluate simultaneous recordings when all units are operating on the same time.

1. Enter the current date. Since the unit time is controlled by the internal clock, there is no need to enter the day of the week - it is added automatically.
2. Enter the current time or click the **Sync to PC** button to copy your computer's system time to the camera.

Note: It is important that the date/time is correct for recording. An incorrect date/time setting could prevent correct recording.

Device time zone

Select the time zone in which the system is located.

Daylight saving time

The internal clock can switch automatically between normal and daylight saving time (DST). The unit already contains the data for DST switch-overs for many years in advance. If the date, time and zone have been set up correctly, a DST table is automatically created.

If you decide to create alternative daylight saving time dates by editing the table, note that values occur in linked pairs (DST start and end dates).

First, check the time zone setting. If it is not correct, select the appropriate time zone and click **Set**.

1. Click **Details** to edit the DST table.
2. Click **Generate** to fill the table with the preset values from the unit.
3. Click one of the entries in the table to make changes. The entry is highlighted.
4. Click **Delete** to remove the entry from the table.
5. Choose other values from the list boxes under the table, to change the selected entry. Changes are immediate.
6. If there are empty lines at the bottom of the table, for example after deletions, add new data by marking the row and selecting values from the list boxes.
7. When finished, click **OK** to save and activate the table.

Time server address

The camera can receive the time signal from time server using various time server protocols, and then use it to set the internal clock. The unit polls the time signal automatically once every minute.

Enter the IP address of a time server here.

You can choose to have the DHCP server give a time server date by selecting the **Overwrite by DHCP** option.

Time server type

Select the protocol that is supported by the selected time server.

- Select **Time protocol** if the server uses the protocol RFC 868.
- The **SNTP protocol** supports a high level of accuracy and is required for special applications and subsequent function extensions.
- Select **TLS protocol** if the server uses the RFC 5246 protocol.
- Select **Off** to disable the time server.

Click **Set** to apply the changes.

4.2 Web Interface

4.2.1 Appearance

You can adapt the appearance of the web interface and change the website language to meet your requirements.

Website language

Select the language for the user interface.

The default language is English.

After setting the new language, the page refreshes automatically. The GUI now displays field names and options, as well as OSD messages, in the selected language.

Company logo

To replace the company's logo in the top-right part of the window, enter the path to a suitable image in this field. The image file must be stored on a web server.

Device logo

To replace the device name in the top-left part of the window, enter the path to a suitable image in this field. The image file must be stored on a web server.

GIF or JPEG images can be used to replace the company and device logos. The image can be stored on a web server (for example, <http://www.myhostname.com/images/logo.gif>). Ensure that a connection to the web server is always available to display the image, since the image files are not stored on the unit.

To reuse the original image, delete the entries in the fields **Company logo** and **Device logo**.

Show VCA metadata

When video content analysis (VCA) is activated, additional information is displayed in the live video stream. With the MOTION+ analysis type, for example, the sensor fields in which motion is recorded are marked with yellow rectangles.

Using Intelligent Video Analytics, the outlines of detected objects are displayed in these colors:

- Red: Objects that generate an alarm event under the current settings appear on the camera image inside a red outline.
- Orange: An object that triggered an alarm event but does not generate another one appears inside an orange outline (example: object has crossed a line). During forensic search, an object that triggers an alarm event has an orange outline from the beginning.
- Yellow: Objects that are detected as moving but do not generate an alarm event under the current settings appear inside a yellow outline.

Show VCA trajectories

For devices with Essential Video Analytics or Intelligent Video Analytics, the trajectories (motion lines of objects) from the video content analysis are shown in the live video image if a corresponding analysis type is activated. The trajectory is shown as a green line that follows the object's base point.

Show overlay icons

Select this check box to show overlay icons on the live video image.

Show VCA items

Select this checkbox to show VCA items on the live video image.

Shows alarm fields, lines and routes configured for the video analytics in the following colors:

- Green: Fields, lines and routes used in a task are displayed in green. They can be edited but not deleted.
- Red: Fields, lines and routes currently in alarm mode are displayed in red.

Show 'Dashboard'

Select this checkbox to enable the **Dashboard** in the application bar.

Secure cookies

Select this checkbox to secure the cookies sent through the camera.



Notice!

If cookies are secured, authentication forwarding to MPEG ActiveX and the Video Security App is prohibited.

HTTP referrer check

Click this option to disable HTTP referrer checking. This option is enabled by default.

The HTTP referrer check works as a protection against a CSRF (Cross-site request forgery) attack.

If a use case requires not sending the HTTP referrer, you can disable this option. In this situation, you might require other mitigations against CSRF attacks.

Video player

Select the type of player to be used for live mode viewing.

Latency mode

Select the required latency mode:

- **Low delay:** Default mode. Provides marginal buffering to display fluent video under normal network conditions.
- **Smooth video:** Allows the buffer to automatically adjust to cover network jitter, inducing higher latency.
- **No buffering:** Shows video as it is received by the decoder with minimum latency. Allows the video to jerk if there is network jitter.

Video buffer

The value shown is calculated from the **Latency mode** setting. It cannot be changed.

JPEG resolution

You can specify the size of the JPEG image on the **Live** page. Options are **Small**, **Medium**, **Large**, and **Resource based** (default).

JPEG interval

You can specify the interval at which the individual images should be generated for the M-JPEG image on the **Live** page.

Enter a time interval (in milliseconds). The default is 0.

JPEG quality

You can specify the quality at which the JPEG images appear on the **Live** page.

This option is only available, if **JPEG resolution** is not set to **Resource based**.

Click **Set** to apply the changes.

4.2.2

'Live' functions

You can adapt the **Live** page functions to meet your requirements. Choose from a variety of different options for displaying information and controls.

1. Select the check boxes for the functions to be displayed on the **Live** page. The selected elements are checked.
2. Check to see if the desired items are shown.

Transmit audio

When selected, the audio from the camera (if set to **On** on the **Audio** page) is sent to the computer. This setting applies only to the computer on which the selection is made.

Transmitting audio data requires additional network bandwidth.

Auto logout time [min]

Set a time frame (in minutes) for the automatic logout. Default value is 0 (no automatic logout).

Show alarm inputs

The alarm inputs are displayed next to the video image as icons along with their assigned names. If an alarm is active, the corresponding icon changes color.

Show alarm outputs

Alarm outputs are shown next to the video image as icons along with their assigned names. If an output is switched, the icon changes color.

Click **Set** to apply the changes.

4.3 Connectivity

4.3.1 Cloud services

Remote Portal

Operation

The operation mode determines how the camera communicates with the Remote Portal.

- Select **On** to poll the server constantly.
- Select **Off** to block polling.

Connectivity state

This field indicates the device's connectivity state with Remote Portal.

- If the device is registered and the operation mode is set to **On**, the state will indicate that the device is **Connected** (to the cloud service).

Note: The **Visit Remote Portal** button will become active.

- If the device is not registered or the operation mode is set to **Off**, the state will indicate that the device is **Not available**.

Note: The **Register** button will become active only if you have not registered the device to the Remote Portal.

4.3.2 Accounts

Four separate accounts can be defined for posting and recording export.

Type

Select either FTP or Dropbox for the account type.

Before using a Dropbox account ensure that the time settings of the device have been correctly synchronized.

Account name

Enter an account name to be shown as the target name.

FTP server IP address

For an FTP server, enter the IP address.

FTP server login

Enter your login name for the account server.

FTP server password

Enter the password that gives access to the account server. Click **Check** to confirm that it is correct.

Path

Enter an exact path to post the images on the account server. Click **Browse...** to browse to the required path.

Maximum bit rate

Enter the maximum bit rate in kbps that will be allowed when communicating with the account.

Encryption

Tick the box to use a secure FTP over TLS connection.

Click **Set** to apply the changes.

4.3.3

DynDNS

A dynamic Domain Name Service (DNS) allows you to select the unit via the Internet using a host name, without having to know the current IP address of the unit. You can enable this service here. To do this, you must have an account with one of the dynamic DNS providers and you must register the required host name for the unit on that site.

Note:

For information about the service, registration process and available host names refer to the provider.

Provider

Select your dynamic DNS Provider from the drop-down list.

Host name

Enter the host name registered for the unit.

User name

Enter the user name you registered.

Password

Enter the password you registered.

Force registration now

Force the registration by transferring the IP address to the DynDNS server. Entries that change frequently are not provided in the Domain Name System. It is a good idea to force the registration when setting up the device for the first time. Only use this function when necessary and no more than once a day, to avoid the possibility of being blocked by the service provider. To transfer the IP address of the device, click the **Register** button.

Status

The status of the DynDNS function is displayed here for information purposes; these settings cannot be changed.

Click **Set** to apply the changes.

4.4

Camera

4.4.1

Installer Menu

Sensor mode

The **Sensor mode** specifies how many images per second the sensor captures and also in what resolution it captures these images.

(Only applicable to FLEXIDOME panoramic 5100i: NDS-5704-F360 and FLEXIDOME panoramic 5100i IR: NDS-5704-F360LE)

You can also switch between single and multi-exposure (HDR) mode.

Mirror image

Select **On** to output a mirror image of the camera picture.

Camera LED

Disable the **Camera LED** on the camera to switch it off.

You can also select **Auto disable** for the LED light to switch off after a certain time period, to avoid interfering with the sensor.

HDMI output

Select **On** to enable HDMI output for the device.

A dropdown selection enables you to further customize the output. You can select, for instance, 1080p or 720 x 480 resolution.

Reboot device

Click **Reboot** to restart the device.

Restore settings

Click **Restore** to restore all settings, except network settings, to their defaults.

Note: Clicking this button also clears the service-level password. Operators must reset the password before doing anything else.

Factory defaults

Click **Defaults** to restore the factory defaults for the camera. A confirmation screen appears. Allow several seconds for the camera to optimize the picture after a reset.

Click **Set** to apply the changes.

4.4.2

Display Stamping

Various overlays or stamps in the video image provide important supplementary information. These overlays can be enabled individually and arranged on the image in a clear manner.

The drop-down menus below allow the configuration of the individual stamping options. The respective sample windows show a preview of the configured text and background styles.

Click **Set** to apply the changes.

Global configuration



Notice!

These options can also be configured individually for all stamping settings.

Any changes to the global configuration settings will be applied to all stamping settings!

– Stamping size

Select the desired font size of the overlays on the OSD: **Normal Large** or **Custom**.

Select **Custom** to enable the **Font size (%)** field.

– Text color

Select the color for the alarm message to be displayed in.

– Background color

Select the background color for the alarm message to be displayed in.

If you have enabled the **Transparent background** option, the background color is not displayed in the OSD.

Camera name stamping

– Position

Select the position of the camera name overlay in the drop-down box. It can be displayed at the **Top**, at the **Bottom**, or at a position of choice using the **Custom** option, or it can be set to **Off** for no overlay information.

If the **Custom** option is selected, enter values in the X and Y position fields.

Optionally, tick the **Underlay with full-width bar** box to place a full-width background-bar beneath the time stamp.



Notice!

Camera / video names can be changed under **General > Identification**.

Logo stamping

– Logo

To place a logo on the image, select and upload an uncompressed .bmp file with a maximum size of 300 x 300 pixels and 256 colors to the camera.

– Logo position

Use the drop-down menu to select the position of the logo or to hide it (**Off**).

Time stamping

– Display milliseconds

Click this check box to display the milliseconds in the time stamp.

Note: This information can be useful for recorded video images, however, it does increase the processor's computing time.

Alarm mode stamping

– Alarm message

Enter the message to be displayed on the image in the event of an alarm. The maximum text length is 32 characters.

Stream security

Select from the **Video authentication** drop-down box a method for verifying the integrity of the video.

If you select **Watermarking**, all images are marked with an icon. The icon indicates if the sequence (live or saved) has been manipulated.

If you want to add a digital signature to the transmitted video images to ensure their integrity, select one of the cryptographic algorithms for this signature.

Set the **Signature interval [s]** for the selected authentication method.

Click **Set** to apply the changes.

4.4.3

Positioning

The **Positioning** feature describes the location of the camera and the perspective in the camera's field of view.

Perspective information is essential to Video Analytics, as it enables the system to compensate for the illusory smallness of distant objects.

Only through use of perspective information is it possible to distinguish objects such as persons, bicycles, cars and trucks, and accurately compute their real size and speeds as they move through 3D space.

However, to calculate perspective information accurately, the camera must be directed at a single, flat horizontal plane. Multiple and inclined planes, hills, stairs can falsify perspective information and produce incorrect object information such as size and speed.

Mounting position

The mounting position describes the perspective information that is also often called calibration.

In general, the mounting position is determined by the parameters of the camera such as height, roll angle, tilt angle, and focal length.

The height of the camera must always be entered manually. Whenever possible, roll angle and tilt angle are provided by the camera itself. The focal length is provided, if the camera has a built-in lens.

Tilt angle [°]

Enter the tilt angle if the value is not determined by the camera.

The tilt angle describes the angle between the horizontal and the camera.

A tilt angle of 0° means that the camera is mounted in the ceiling.

A tilt angle of 90° means that the camera is mounted in a wall.

The flatter the tilt angle is set, the less accurate the estimate of object sizes and speeds will be. The settings must be between 0° and 90°. Estimates are no longer possible when you have reached 0°.

Roll angle [°]

Enter the roll angle if the value is not determined by the camera.

The roll angle describes the angle between the roll axis and the horizontal plane. The angle can deviate from the horizontal by up to 45°.

Height [m]

Enter the height in meters of the position of the camera.

The height describes the vertical distance from the camera to the ground plane of the captured image. Typically the elevation of the mounted camera above the ground.

Show sensor values...

Click to automatically see the camera parameters, for example, **Tilt angle [°]**, **Roll angle [°]** and **Focal length [mm]**. These calibration values are measured by the device sensors. Click **OK** to transfer them to the **Positioning** settings page.

Coordinate system

Select the coordinate system and enter the appropriate values in the additional input fields that appear depending on the coordinate system selected.

The **Coordinate system** feature describes the position of the camera in a local **Cartesian** or the global **WGS 84** coordinate system. The camera and the objects tracked by the video analytics are displayed on a map.

Cartesian

The Cartesian coordinate system describes each point in the space by a combination of the position on three orthogonal axes X, Y and Z. A right-handed coordinate system is used, where X and Y span the ground plane and Z describes the elevation of the ground plane.

X [m]

The location of the camera on the ground on the X-axis.

Y [m]

The location of the camera on the ground on the Y-axis.

Z [m]

The elevation of the ground plane. To determine the elevation of the camera, add the **Z [m]** value and the **Height [m]** value of the camera.

Azimuth [°]

The orientation of the camera in a counter-clockwise angle starting with 0° in the east (WGS 84) or on the X-axis (**Cartesian**). If the camera is directed towards the north (WGS 84) or the Y-axis (Cartesian), the azimuth is 90°.

WGS 84

The WGS 84 coordinate system is a spherical coordinate system description of the world and used in many standards including GPS.

Latitude

Latitude is the north-south position of the camera in the spherical coordinate system WGS 84.

Longitude

Longitude is the east-west position of the camera in the spherical coordinate system WGS 84.

Ground level [m]

The elevation of the ground above sea level. To determine the elevation of the camera, add the **Ground level [m]** value and the **Height [m]** value of the camera.

Azimuth [°]

The orientation of the camera in a counter-clockwise angle starting with 0° in the east (WGS 84) or on the X-axis (**Cartesian**). If the camera is directed towards the north (WGS 84) or the Y-axis (Cartesian), the azimuth is 90°.

Click **Set** to apply the changes.

4.4.4**Scene Mode**

A scene mode is a collection of image parameters that are set in the device when that particular mode is selected (installer menu settings are excluded). Several pre-defined modes are available for typical scenarios. After a mode has been selected, additional changes can be made through the user interface.

Current mode**Notice!**

Some modes might behave differently in single exposure sensor mode and HDR sensor mode.

Standard

This mode is optimized for most standard scenes both indoor and outdoor.

Sodium lighting

This mode can be used in applications with street (sodium vapor) lighting. A special white balance algorithm compensates for the yellow / orange color of the lights.

Fast movement

This mode is used for monitoring fast moving objects like cars in traffic scenes. Motion artifacts are minimized and the image is optimized for a sharp and detailed picture in color and monochrome.

Sensitivity boost

This mode provides maximum sensitivity in low light scenes by using longer exposure times, resulting in bright images even in extreme low light. It can introduce motion blur because of the slow shutter speed.

Backlight

In this mode backlight compensation is enabled. It can be used to improve recognition of people and objects in front of a bright background, for example an entrance of a building.

Vibrant

This mode provides a more vivid image with increased contrast, sharpness and saturation. This is at the expense of slightly reduced color accuracy and higher bit-rate.

Color only

In this mode the camera will not switch to monochrome mode at low light levels. It can be used for scenarios where color images are required day and night, like in city surveillance.

Sports and gaming

This mode is for high-speed capture, and improved color rendition and sharpness.

Retail

This mode has improved color rendition and sharpness with reduced bandwidth requirements.

Mode ID

The name of the selected mode is displayed.

Copy mode to

Select the mode from the drop-down menu to which you wish to copy the active mode.

Restore Mode Defaults

Click Restore Mode Defaults to restore the factory default modes.

4.4.5

Color

Brightness (0...255)

Adjust the brightness with the slider from 0 to 255.

Contrast (0...255)

Adjust the contrast with the slider from 0 to 255.

Saturation (0...255)

Adjust the color saturation with the slider from 0 to 255.

White balance

Select the appropriate white balance mode from the drop-down list.

- **Basic auto** mode allows the device to continually adjust for optimal color reproduction using an average reflectance method. This is useful indoor light sources and for colored LED light illumination.
- **Standard auto** mode allows the device to continually adjust for optimal color reproduction in an environment with natural light sources.
- **Sodium lamp auto** mode allows the device to continually adjust for optimal color reproduction in an environment with sodium vapor light sources (street lighting).
- In **Manual RGB** mode the Red, Green, and Blue gain can be manually set to a desired position.

Apply white balance

Click **Hold** to put ATW on hold and save the current color settings. The mode changes to manual.

The table below identifies the options available in the field **White balance** and the additional fields that appear depending on the options selected.

Option in field "White balance"	Additional fields for configuration	NOTES
Basic auto		The three fields R-gain , G-gain , and B-gain only appear when the hold button is pushed.
Standard auto		
Sodium lamp auto		
Manual RGB	R-gain G-gain B-gain	

4.4.6

ALC (Automatic Level Control)

ALC mode

Select the appropriate automatic high-level control mode from the drop-down list.

- Fluorescent 50 Hz
- Fluorescent 60 Hz
- **Standard**

ALC level

Adjust the video output level (-15 to 0 to +15).

Select the range within which the ALC will operate. A positive value is more useful for low-light conditions; a negative value is more useful for very bright conditions.

ALC - average vs. peak

The ALC - average vs. peak slider configures the ALC level so that it controls mainly on scene average level (slider position - 15) or on scene peak level (slider position +15). Scene peak level is useful for capturing images that contain car headlights.

Maximum gain [dB]

Use the slider to adjust the maximum gain.

Exposure**Maximum shutter [s]**

The shutter speed is the time each frame is exposed for. Select a value in this field as the maximum speed of the shutter. The limit on the shutter speeds improves the motion performance.

Default shutter [s]

Select the amount of time for the shutter to remain open.

With this option, you can set the value the camera should keep as long as possible.

When it gets very dark, the shutter can change the value to a lower speed. When it gets very bright, the shutter can change to a faster speed.

Day/night

Select the appropriate mode from the drop-down list.

- **Auto** - the device switches the IR cut-off filter on and off depending on the scene illumination level.
- **Color** - the device always produces a color signal regardless of light levels.
- **Monochrome** - the IR cut-off filter is removed, giving full IR sensitivity.

Day-to-night switchover

Adjust the slider to set the video level at which the device switches from color to monochrome operation and from monochrome to color operation (-15 to +15). This slider affects both day-to-night and night-to-day switchover.

A low (negative) value means that the device switches over at a lower light level. A high (positive) value means that the device switches over at a higher light level.

IR function

(Only applicable to FLEXIDOME panoramic 5100i IR: NDS-5703-F360LE, NDS-5704-F360LE)

Select the control setting for IR illumination:

- **Auto**: the camera automatically switches the IR illumination.
- **On**: the IR illumination is always on.
- **Off**: the IR illumination is always off.

Intensity level

(Only applicable to FLEXIDOME panoramic 5100i IR: NDS-5703-F360LE, NDS-5704-F360LE)

Set the intensity of the IR beam (0 to 30).

Regional intensity

(Only applicable to FLEXIDOME panoramic 5100i IR: NDS-5703-F360LE, NDS-5704-F360LE)

Select this option to enable the control of IR intensity in 5 zones.

The device has an integrated 360° IR. The integrated IR provides the flexibility to control IR intensity in 5 zones in order to prevent IR saturation.

Installing the device near a white wall or a white object might overexpose them due to reflection of the IR light. The integrated IR LEDs are individually adjustable to solve this effect and optimize the scene.

Intensity level region 1 to 5

(Only applicable to FLEXIDOME panoramic 5100i IR: NDS-5703-F360LE, NDS-5704-F360LE)

The device has 5 controllable IR zones. You can individually control the intensity of the IR LEDs. To do so, adjust the sliders from 0 to +30.

Region 1 is always in the center. Regions 2, 3, 4, and 5 are outer parts of the visible scene. If the lens is rotated mechanically, it will be positioned differently in relation to the IR LEDs. Note that the IR zones are mapped correctly only when the lens is rotated in the default position. The two arrows on the camera and lens must point at each other. If adjusted correctly, regions 2, 3, 4, and 5 shown in the image match the IR zones from the camera.

4.4.7

Enhance

Backlight compensation

- Select **Off** to switch off backlight compensation.
- Select **On** to capture details in high-contrast and extremely bright-dark conditions.

Contrast enhancement

The slider adjusts the contrast enhancement level between 0 and +15.

Sharpness level

The slider adjusts the sharpness level between -15 and +15. The zero position of the slider corresponds to the factory default level.

A low (negative) value makes the picture less sharp. Increasing sharpness brings out more detail. Extra sharpness can enhance the details of license plates, facial features and the edges of certain surfaces but will increase bandwidth requirements.

Temporal noise filtering

Adjusts the **Temporal noise filtering** level between -15 and +15. The higher the value, the more noise filtering.

Spatial noise filtering

Adjusts the **Spatial noise filtering** level between -15 and +15. The higher the value, the more noise filtering.

4.4.8

Scene mode scheduler

The scene mode scheduler is used to determine which scene mode should be used during the day and which scene mode should be used during the night.

1. Select the mode you wish to use during the day from **Marked range** drop-down box.
2. Select the mode you wish to use during the night from **Unmarked range** drop-down box.
3. Use the two slider buttons to set the **Time ranges**.

To set the **Marked range** as the single mode of the device, select the complete time range.

The text “Always” will appear after the **Marked range** menu.

Click **Set** to apply the changes.

4.4.9

Encoder Streams

When this menu is accessed while the device is recording, the following message appears at the top of the page: “Recording is currently active. At ‘Active profile’ the stream profile used for recording is displayed, and overrules the ‘Non-recording profile’.”

Stream limits (H.264/H.265)

In the dropdown, select the maximum stream resolution as provided per stream.

Stream limits is a mandatory selection to pre-assign the maximum available resolution for each of the four H.264 / H.265 streams. If a lower resolution is selected, you will be more flexible in streaming options on the second and third stream. The fourth JPEG stream always shows the maximum resolution available in the camera.

Stream prioritization

Select the stream that should not drop any frame.

Coding standard

Select the coding standard you want to use for the stream.

Active profile

Active profile shows the profile that is in use and can be set differently per stream

If no edge recording or VRM recording is active, the device switches to the **Non-recording profile**. Please refer to section **Non-recording profile**.

(Only applicable to FLEXIDOME panoramic 5100i: NDS-5703-F360 and FLEXIDOME panoramic 5100i IR: NDS-5703-F360LE)

Profile number	Default Profile name	Description
Profile 1	Image Optimized 4.5 MP	For a full resolution image, the video bit rate and frame quality are adjusted to ensure that the picture quality is the priority.
Profile 2	Balanced 4.5 MP	For a full resolution image, the video bit rate and frame quality are adjusted to a median profile for everyday use.
Profile 3	Bitrate Optimized 4.5 MP	For a full resolution image, the video bit rate and frame quality are adjusted to ensure that the bit rate is the priority.
Profile 4	Image Optimized	For a reduced resolution image, the video bit rate and frame quality are adjusted to ensure that the picture quality is the priority.
Profile 5	Balanced	For a reduced resolution image, the video bit rate and frame quality are adjusted to a median profile for everyday use.
Profile 6	Bitrate Optimized	For a reduced resolution image, the video bit rate and frame quality are adjusted to ensure that the bit rate is the priority.
Profile 7	SD DSL Optimized	Ideal for encoding on a DSL uplink where bit rate limitations are critical.
Profile 8	SD 3G Optimized	Ideal for encoding on a 3G uplink where bit rate limitations are critical.

(Only applicable to FLEXIDOME panoramic 5100i: NDS-5704-F360 and FLEXIDOME panoramic 5100i IR: NDS-5704-F360LE)

Profile number	Default Profile name	Description
Profile 1	Image Optimized 9 MP	For a full resolution image, the video bit rate and frame quality are adjusted to ensure that the picture quality is the priority.
Profile 2	Balanced 9 MP	For a full resolution image, the video bit rate and frame quality are adjusted to a median profile for everyday use.
Profile 3	Bitrate Optimized 9 MP	For a full resolution image, the video bit rate and frame quality are adjusted to ensure that the bit rate is the priority.
Profile 4	Image Optimized	For a reduced resolution image, the video bit rate and frame quality are adjusted to ensure that the picture quality is the priority.
Profile 5	Balanced	For a reduced resolution image, the video bit rate and frame quality are adjusted to a median profile for everyday use.
Profile 6	Bitrate Optimized	For a reduced resolution image, the video bit rate and frame quality are adjusted to ensure that the bit rate is the priority.
Profile 7	SD DSL Optimized	Ideal for encoding on a DSL uplink where bit rate limitations are critical.
Profile 8	SD 3G Optimized	Ideal for encoding on a 3G uplink where bit rate limitations are critical.

Stream 1 always runs at maximum selected resolution in stream limits. On stream 2 and 3, you can select various downscaled resolutions.

Each stream has its own set of profiles, which can be set up differently.

Non-recording profile

Select one of the resolutions from the drop-down menu for each stream.

If you activate the recording function, the active profile switches from **Non-recording profile** to **Active profile**.

The **Active profile** follows the scheduled profiles under **Recording Profiles**. Please refer to section **Recording Profiles**.

This behavior is only applicable when using Bosch recording solutions, including edge recording or VRM recording. Third-party recording solutions might use the **Non-recording profile**.

If no edge recording or VRM recording is active, the active profile is managed via the drop-down of **Non-recording profile**.

If edge recording or VRM recording is active, the active profile is managed via the menu in **Recording Profiles**. Please refer to section **Recording Profiles**.

Click **Set** to apply the changes.

4.4.10

Encoder Statistics

This section gives the user information about the bit rate of the device. For each scene, it is possible to determine the best target/max bit rate through the graphic shown.

Stream

Identifies the current stream.

Zoom

Identifies the current zoom factor of the camera (1x, 2x, 4x, or 8x).

Averaging period

Identifies how often (in seconds, minutes, hours, days or weeks) the encoder time is synchronized to the actual time.

4.4.11**Privacy Masks**

Privacy Masks block specific areas of a scene from being seen in the camera's field of view.

This can be useful when public spaces are in the coverage area or monitoring will be limited to a particular zone.

Pattern

Select the color of the mask as it will appear in the live video: **Black, Gray, White** or

Custom color.

To configure a **Privacy mask**:

- Select the mask number from the drop-down list.
- Click the plus button.
- Adjust the mask in the image:
- Double-click on the edges to add or remove nodes.
- Click and drag the nodes to position them correctly.
- Check the **Enabled** check box to activate the related mask.
- Click the **Set** button to apply the related changes.

To delete a **Privacy mask**:

- Select the mask number from the drop-down list.
- Click the trashcan icon.
- Click the **Set** button to apply the changes.

4.4.12**Audio**

You can set the gain of the audio signals to suit your specific requirements. The live video image is shown in the window to help you check the audio source. Your changes are effective immediately.

If you connect via Web browser, you must activate the audio transmission on the '**Live**' **functions** page. For other connections, the transmission depends on the audio settings of the respective system.

The audio signals are sent in a separate data stream parallel to the video data, and so increase the network load. The audio data is encoded according to the selected format and requires additional bandwidth. If you do not want any audio data to be transmitted, select **Off**.

Audio

Enable or disable the audio recording option.

Audio input

Select which audio input you want to use. Available options are **Line In** or integrated

Microphone.**Microphone volume**

Adjust the audio level with the slider(s). Adjust so that the indicator does not go into the red zone.

Line Out

Adjust the audio level with the slider(s). Adjust so that the indicator does not go into the red zone.

Recording format

Select a format for audio recording. The default value is **AAC 48 kbps**. You can select **AAC 80 kbps**, G.711 or L16 depending on the required audio quality or sampling rate.

AAC audio technology is licensed by Fraunhofer IIS.

(<http://www.iis.fraunhofer.de/amm/>)

Send audio

Audio can be sent via the **Send audio** button if the unit supports audio. The button activates the audio backchannel connection.

1. Click and hold the **Send audio** button to send an audio signal to the unit.
2. Release the button to stop sending audio.

You must have a speaker or similar connected to the line out of the camera in order to send the audio.

Click **Set** to apply the changes.

4.4.13

Pixel Counter

The number of horizontal and vertical pixels covered by the highlighted area is displayed below the picture. With these values you can check whether the requirements for specific functions, for example, identification tasks, are fulfilled.

1. Click **Freeze** to freeze the camera image if the object that you want to measure is moving.
2. To reposition a zone, place the cursor over the zone, hold down the mouse button and drag into position.
3. To change the shape of a zone, place the cursor over the edge of the zone, hold down the mouse button and drag the edge of the zone to the required position.

4.5

Recording

Images can be recorded to an appropriately configured iSCSI system or, for devices with an SD slot, locally to an SD card.

SD cards are the ideal solution for shorter storage times and temporary recordings. They can be used for local alarm recording or to improve the overall reliability of video recording.

For long-term authoritative images use an appropriately sized iSCSI system.

Two recording tracks are available (**Recording 1** and **Recording 2**). The encoder streams and profiles can be selected for each of these tracks for both standard and alarm recordings.

Ten recording profiles are available where these recording tracks can be defined differently. These profiles are then used for building schedules.

A Video Recording Manager (VRM) can control all recording when accessing an iSCSI system. The VRM is an external program for configuring recording tasks for video servers.

4.5.1

Storage Management

Device manager

The Device manager indicates if storage is controlled locally or by a VRM system.

An external Video Recording Manager (VRM) system for the unit is configured via the Configuration Manager.

Recording media

Select a media tab to connect to the available storage media.

iSCSI Media

To use an **iSCSI system** as the storage medium, a connection to the desired iSCSI system is required to set the configuration parameters.

The storage system selected must be available on the network and completely set up. It must have an IP address and be divided into logical drives (LUNs).

1. Enter the IP address of the required iSCSI destination in the **iSCSI IP address** field.
2. If the iSCSI destination is password protected, enter the password into the **Password** field.
3. Click **Read**.
 - The connection to the IP address is established.

The **Storage overview** field displays the logical drives.

Local Media

A microSD card inserted in the camera can be used for local recording.

- ▶ If the microSD card is password protected, enter the password into the **Password** field.

The **Storage overview** field shows the local media.

Note: microSD card recording performance is highly dependent on the speed (class) and performance of the microSD card. It is recommended to use an Industrial microSD card.

Local storage

To activate the ANR settings, **Recording 1** must be assigned to an iSCSI target and **Recording 2** to a local storage.

This function enables recording to the iSCSI target. If there is a network disconnection, the video is recorded to the local storage. When the network is recovered, the video recorded to the local storage is transferred to the iSCSI target and completes the missing information.

Activating and configuring storage media

Available media or iSCSI drives must be transferred to the **Managed storage media** list, activated, and configured for storage.

Note:

An iSCSI target storage device can only be associated with one user. If a target is being used by another user, ensure that the current user no longer needs the target before decoupling that user.

1. In the **Storage overview** section, double-click a storage medium, an iSCSI LUN or one of the other available drives.
 - The medium is added as a target in the **Managed storage media** list.
 - Newly added media is shown as **Not active** in the **Status** column.
2. Click **Set** to activate all media in the **Managed storage media** list.
 - The **Status** column shows all media as **Online**.
3. Check the box in the **Rec. 1** or **Rec. 2** column to specify the recording tracks to be recorded on the target selected.

Deactivating storage media

A storage medium in the **Managed storage media** list can be deactivated. It is then no longer used for recordings.

1. Click a storage medium in the **Managed storage media** list to select it.
2. Click **Remove** below the list. The storage medium is deactivated and removed from the list.

Formatting and wiping storage media

Formatting the storage media can be necessary to delete all data and recreate a valid file structure to be usable.

All recordings on a storage medium can be deleted at any time. Check the recordings before deleting and back-up important sequences on the computer's hard drive.

1. Click a storage medium in the **Managed storage media** list to select it.
2. Click **Edit** below the list.
3. Click **Format** in the new window to delete all recordings in the storage medium.
4. Click **OK** to close the window.

Wiping the storage media deletes all data without recreating a valid file structure.

To wipe the recordings from the storage media:

1. Click a storage medium in the **Managed storage media** list to select it.
2. Click **Edit** below the list.
3. Click **Wipe** in the new window to wipe the recordings in the storage medium.
4. Click **Close** to close the window.

Click **Set** to apply the changes.

4.5.2

Recording Profiles

A recording profile contains the characteristics of the tracks that are used for recording. These characteristics can be defined for ten different profiles. The profiles can then be assigned to days or times of day on the **Recording Scheduler** page.

Each profile is color-coded. The names of the profiles can be changed on the **Recording Scheduler** page.

To configure a profile click its tab to open its settings page:

- To copy the currently visible settings to other profiles, click **Copy Settings**. A window opens to select the target profiles for the copied settings.
- If you change a profile's settings, click **Set** to save.
- If necessary, click **Default** to return all settings to their factory defaults.

Stream profile settings

Select the encoder profile setting that is to be used with stream 1 and 2 when recording. This selection is independent of the selection for live stream transmission. (The properties of the encoder profiles are defined on the **Encoder Streams** page.)

Settings for selected recordings

Recording includes

Select what is to be included in the recordings:

- **Audio:** If audio is not enabled, **Off** is shown. Click on **Off** and the page is redirected to the **Audio** section.
- **Metadata.**

You can specify whether, in addition to video data, audio data and metadata (for example alarms, VCA data and serial data) should also be recorded. Including metadata could make subsequent searches of recordings easier but it requires additional storage capacity.



Caution!

Without metadata, it is not possible to include video content analytics in recordings.

Select the mode for standard recordings:

- **Continuous:** the recording proceeds continuously. If the maximum recording capacity is reached, older recordings are overwritten automatically.

- **Pre-alarm:** recording takes place in the pre-alarm time, during the alarm and during the post-alarm time only.
- **Off:** no automatic recording takes place.

Stream

Select the stream to be used for standard recordings:

- **Stream 1**
- **Stream 2**
- **I-frames only**

Alarm recording

Select a period for the **Pre-alarm time** from the list box. The RAM option allows the pre-alarm recording ring buffer to be stored in RAM as long as it fits, depending on bit rate settings. This avoids writing to the SD card or iSCSI. The pre alarm ring is written to storage only on alarm. Select a period for the **Post-alarm time** from the list box.

Alarm stream

Select the stream to be used for alarm recordings:

- **Stream 1**
- **Stream 2**
- **I-frames only**

Check the **encoding interval and bit rates from profile:** box and select an encoder profile to set the associated encoding interval for alarm recording.

Export to account

To send standard H.264 or H.265 files to the target address, select an account and check

Export from memory.

If the target has not yet been defined, click **Configure accounts** to jump to the **Accounts** page where the server information can be entered.

Alarm triggers

Select the alarm type that is to trigger an alarm recording:

- **Alarm input**
- **Analysis alarm**

Select the **Virtual alarm** sensors that are to trigger a recording, via RCP+ commands or alarm scripts, for example.

Configure accounts

Sends you to the **Accounts** page.

Copy Settings

You can copy the settings from one profile to another with the **Copy Settings** button. Select the target profile and click **OK**.

Default

The default values are restored.

Click **Set** to apply the changes.

4.5.3

Maximum Retention Time

Recordings are overwritten when the retention time entered here has expired.

Enter the required retention time in days for each recording track.

Click **Set** to apply the changes.

4.5.4 Recording Scheduler

The recording scheduler allows you to link the created recording profiles to the days and times at which the camera's images are to be recorded. Schedules can be defined for weekdays and for holidays.

Weekdays

Assign as many time periods (in 15-minute intervals) as needed for any day of the week. Move the mouse cursor over the table - the time is displayed.

1. Click the profile to be assigned in the **Time periods** box.
2. Click a field in the table and, while holding down the left mouse button, drag the cursor across all of the fields to be assigned to the selected profile.
3. Click the **No recordings** profile in the **Time periods** box to deselect the intervals.
4. Click **Select All** to select all of the intervals to be assigned to the selected profile.
5. Click **Clear All** to deselect all of the intervals.
6. When finished, click **Set** to save the settings to the device.

Holidays

Define holidays whose settings will override the settings for the normal weekly schedule.

1. Click the **Holidays** tab. Days that have already been defined are shown in the table.
2. Click **Add**. A new window opens.
3. Select the desired **From** date from the calendar.
4. Click in the **To** box and select a date from the calendar.
5. Click **OK** to accept the selection which is handled as a single entry in the table. The window closes.
6. Assign the defined holidays to the recording profile as described above.
7. To delete a user-defined holiday, click on the trashcan of the respective holiday. Click **Set** to apply the changes.

Time periods

Change the names of the recording profiles listed in the **Time periods** box.

1. Click a profile.
2. Click **Rename**.
3. Enter the new name and click **Rename** again.

Activating recording

After completing configuration, activate the recording schedule and start scheduled recording. Once activated, the **Recording Profiles** and the **Recording Scheduler** are deactivated and the configuration cannot be modified. Stop scheduled recording to modify the configuration.

1. Click **Start** to activate the recording schedule.
2. Click **Stop** to deactivate the recording schedule. Recordings that are currently running are interrupted and the configuration can be modified.

Click **Set** to apply the changes.

4.5.5 Recording Status

Details of the recording status are displayed here for information. These settings cannot be changed.

4.5.6 Recording Statistics

The bit rate of the recorded video (blue) and other data (grey), such as audio and metadata, are shown in the graphic.

Recording

Identifies the current recording profile (1 or 2).

Zoom

Identifies the current zoom factor of the camera (1x, 2x, 4x, or 8x).

Averaging period

Select the appropriate averaging period as a means of stabilizing the long term bit rate.

4.5.7**Image Posting**

Save individual JPEG images on an FTP server at specific intervals.

JPEG**Image size**

Select the size of the JPEG images that are to be sent from the camera. JPEG resolution corresponds to the highest setting from the two data streams.

File name

Select how file names are created for the individual images that are transmitted.

- **Overwrite:** The same file name is always used and any existing file will be overwritten by the current file.
- **Increment:** A number from 000 to 255 is added to the file name and automatically incremented by 1. When it reaches 255, it starts again from 000.
- **Date/time suffix:** The date and time are automatically added to the file name. When setting this parameter, make sure that the date and time of the device are always set correctly. For example, the file snap011005_114530.jpg was stored on October 1, 2005 at 11:45 and 30 seconds.

VCA overlays

If you have enabled the display of VCA overlays on the **Appearance** page, select the **VCA overlays** check box to have the overlays also visible in the JPEG image.

Posting interval

Enter the interval in seconds at which the images are sent to an FTP server. Enter zero for no images to be sent.

Target

Select the target account for JPEG posting.

**Notice!**

You must configure an account in order to have functionality for **Image Posting**. Click on **Configure accounts** to do so.

Click **Set** to apply the changes.

4.5.8**SD Card Status**

This section identifies the details about the SD card installed in the device:

- **Manufacturer**
- **Product**
- **Size**
- **State**
- **Lifespan.**

For non-industrial SD cards, the lifespan options are not available.

Lifespan alarm

Set the alarm warning to a defined percentage of the lifespan. The alarms can be given as:

- An audio alarm
- An e-mail

- A warning through the Video Management System
If a SD card is not installed, '**SD card not found**' is shown.



Notice!

Bosch recommends the use of industrial micro SD cards with health monitoring.

4.6

Alarm

4.6.1

Alarm Connections

In the event of an alarm, the unit can automatically connect to a pre-defined IP address. The unit can contact up to ten IP addresses in the order listed until a connection is made.

Connect on alarm

Select **On** so that the unit automatically connects to a pre-defined IP address in the event of an alarm.

Select **Follows input 1** so that the unit maintains the connection for as long as an alarm exists on alarm input 1.

Auto-connect

Select **On** to automatically re-establish a connection to one of the previously specified IP addresses after each reboot, connection breakdown, or network failure.

Number of destination IP address

Specify the numbers of the IP addresses to be contacted in the event of an alarm. The unit contacts the remote locations one after the other in the numbered sequence until a connection is made.

Destination IP address

For each number, enter the corresponding IP address for the desired remote station.

Destination password

If the remote station is password protected, enter the password here.

Only ten passwords can be defined here. Define a general password if more than ten connections are required. The unit connects to all remote stations protected by the same general password. To define a general password:

1. Select 10 in the **Number of destination IP address** list box.
2. Enter 0.0.0.0 in the **Destination IP address** field.
3. Enter the password in the **Destination password** field.
4. Set the user password of all the remote stations to be accessed using this password. Setting destination 10 to the IP-address 0.0.0.0 overrides its function as the tenth address to try.

Video transmission

If the unit is operated behind a firewall, select **TCP (HTTP port)** as the transfer protocol. For use in a local network, select **UDP**.

To enable multicast operation, select **UDP** for the **Video transmission** parameter here and on the **Network Access** page.

Note:

In the event of an alarm, a larger network bandwidth is sometimes required for additional video streams (if multicast operation is not possible).

Stream

Select a stream to be transmitted.

Remote port

Select an appropriate browser port depending on the network configuration.
The ports for HTTPS connections are only available if **SSL encryption** is set to **On**.

Video output

If a hardware receiver is used, select the analog video output to which the signal should be switched. If the destination device is unknown, select **First available**. This places the image on the first video output with no signal.

The connected monitor only displays images when an alarm is triggered.

Note:

Refer to the destination unit documentation for more information on image display options and available video outputs.

Decoder

If a split image is set for the selected video output, select a decoder to display the alarm image. The decoder selected determines the position in the split image.

SSL encryption

SSL encryption protects data used for establishing a connection, such as the password. By selecting **On**, only encrypted ports are available for the **Remote port** parameter. SSL encryption must be activated and configured on both sides of a connection.

The appropriate certificates must also have been uploaded. (Certificates can be uploaded on the **Certificates** page.)

Configure and activate encryption for media data (such as video, metadata or audio when available) on the **Encryption** page (encryption is only available if the appropriate license is installed).

Audio

Select **On** to transmit the audio stream with an alarm connection.
Click **Set** to apply the changes.

4.6.2**Video Content Analysis (VCA)**

The camera has integrated Video Content Analysis (VCA) which detects and analyzes changes in the picture using image processing algorithms. Such changes can be due to movements in the camera's field of view. Detection of movement can be used to trigger an alarm and to transmit metadata.

Various VCA configurations can be selected and adapted to your application, as required. Configure the VCA setting in the Bosch Configuration Manager.

4.6.3**Audio Alarm**

Alarms can be generated based on audio signals. Configure signal strengths and frequency ranges so that false alarms, for example, machine noise or background noise, are avoided. Set up normal audio transmission before configuring the audio alarm.

Audio alarm

Select **On** for the device to generate audio alarms.

Name

The name makes it easier to identify the alarm in extensive video monitoring systems. Enter a unique and clear name here.

Signal Ranges

Exclude particular signal ranges in order to avoid false alarms. For this reason the total signal is divided into 13 tonal ranges (mel scale). Check or uncheck the boxes below the graphic to include or exclude individual ranges.

Threshold

Set up the threshold on the basis of the signal visible in the graphic. Set the threshold using the slide control or move the white line directly in the graphic using the mouse.

Sensitivity

Use this setting to adapt the sensitivity to the sound environment and effectively suppress individual signal peaks. A high value represents a high level of sensitivity.

Click **Set** to apply the changes.

4.6.4

Alarm E-Mail

Alarm states can be documented by e-mail. The camera automatically sends an e-mail to a user-defined e-mail address. This makes it possible to notify a recipient who does not have a video receiver.

Send alarm e-mail

Select **On** for the device to automatically send an alarm e-mail in the event of an alarm.

Mail server IP address

Enter the IP address of a mail server that operates on the SMTP standard (Simple Mail Transfer Protocol). Outgoing e-mails are sent to the mail server via the address entered. Otherwise, leave the box blank (**0.0.0.0**).

SMTP port

Select the appropriate SMTP port.

SMTP user name

Enter a registered user name for the chosen mail server.

SMTP password

Enter the required password for the registered user name.

Format

Select the data format of the alarm message.

- **Standard (with JPEG):** e-mail with JPEG image file attachment.
- **SMS:** e-mail in SMS format to an e-mail-to-SMS gateway without an image attachment.

When a mobile phone is used as the receiver, make sure to activate the e-mail or SMS function, depending on the format, so that these messages can be received. Obtain information on operating your mobile phone from your mobile phone provider.

Image size

Select the size of the JPEG images that are to be sent from the camera.

Attach JPEG from camera

To send a JPEG image from a particular video channel, check the appropriate box.

VCA overlays

Select the **VCA overlays** check box, to place the outline of the object that triggered an alarm into the camera image sent as snapshot via e-mail.

Destination address

Enter the e-mail address for alarm e-mails here. The maximum address length is 49 characters.

Sender address

Enter a unique name for the e-mail sender, for example, the location of the device. This makes it easier to identify the origin of the e-mail.

Test e-mail

Click **Send Now** to test the e-mail function. An alarm e-mail is immediately created and sent. Click **Set** to apply the changes.

4.6.5**Alarm Inputs****Active**

Configure the alarm triggers for the unit.

Select **N.C.** (Normally Closed) if the alarm is to be triggered by opening the contact.

Select **N.O.** (Normally Open) if the alarm is to be triggered by closing the contact.

Name

Enter a name for the alarm input. This is then displayed below the icon for the alarm input on the **Live** page (if configured).

Action

Select a type of action to be performed when an alarm input occurs:

- **None**
- **Monochrome**
This switches the camera to the monochrome mode.
- **Switch mode**
When this is selected, you can select the **Scene Mode** to be used for the active and inactive period of the alarm.

Click **Set** to apply the changes.

4.6.6**Alarm Outputs**

Configure the switching behavior of the output.

Select different events that automatically activate an output. For example, turn on a floodlight by triggering a motion alarm and then turn the light off again when the alarm has stopped.

Idle state

Select **Open** for the output to operate as a normally open contact, or select **Closed** if the output is to operate as a normally closed contact.

Operating mode

Select the way the output works.

For example, if you want an activated alarm to stay on after the alarm ends, select **Bistable**. If you wish an activated alarm to stay on for ten seconds for example, select **10 s**.

Output follows

Select the event that triggers the output.

Output name

The alarm output can be assigned a name here. This name appears on the Live page.

Toggle

Click the button to switch the alarm output manually (for example, for testing purposes or to operate a door opener).

Click **Set** to apply the changes.

4.6.7**Alarm Task Editor**

Editing scripts on this page overwrites all settings and entries on the other alarm pages. This procedure cannot be reversed.

To edit this page, you should have programming knowledge and be familiar with the information in the Alarm Task Script Language document and the English language.

As an alternative to the alarm settings on the various alarm pages, enter the desired alarm functions in script form here. This will overwrite all settings and entries on the other alarm pages.

1. Click **Examples** under the Alarm Task Editor field to see some script examples. A new window opens.
2. Enter new scripts in the Alarm Task Editor field or change existing scripts in line with your requirements.
3. When finished, click **Set** to transmit the scripts to the device. If the transfer was successful, the message **Script successfully parsed.** is displayed over the text field. If it was not successful, an error message is displayed with further information.

4.7 Network

The settings on these pages are used to integrate the device into a network. Some changes only take effect after a reboot. In this case **Set** changes to **Set and Reboot**.

1. Make the desired changes.
2. Click **Set and Reboot**.

The device is rebooted and the changed settings are activated.

4.7.1 Network Services

This page shows an overview of all available network services. Use the checkbox to activate or deactivate a network service. Click on the settings symbol next to the network service to go to the settings page for this network service.

Click **Set** to apply the changes.

Some changes only take effect after the unit is rebooted. In this case, the **Set** button changes to **Set and Reboot**.

4.7.2 Network Access

If the IP address, subnet mask, or gateway address is changed, then the device is only available under the new addresses after the reboot.

Automatic IPv4 assignment

If the network has a DHCP server for the dynamic assignment of IP addresses, select **On** to automatically accept the DHCP-assigned IP address.

For certain applications, the DHCP server must support the fixed assignment between IP address and MAC address, and must be appropriately set up so that, once an IP address is assigned, it is retained each time the system is rebooted.

Ethernet

The Ethernet options are defined in this section.

IPv4

IP address

Enter the desired IP address for the camera. The IP address must be valid for the network.

Subnet mask

Enter the appropriate subnet mask for the set IP address.

Gateway address

For the device to establish a connection to a remote location in a different subnet, enter the IP address of the gateway here. Otherwise, this field can remain empty (0.0.0.0).

IPv6

IP address

Enter the desired IP address for the camera. The IP address must be valid for the network.

Automatic address

Displays the automatic address.

Prefix length

Enter the appropriate prefix length for the set IP address.

Gateway address

For the device to establish a connection to a remote location in a different subnet, enter the IP address of the gateway here. Otherwise, this field can remain empty (0.0.0.0).

DNS server address 1/DNS server address 2

The device is easier to access if it is listed on a DNS server. For example, to establish an Internet connection to the camera, it is sufficient to enter the name given to the device on the DNS server as a URL in the browser. Enter the DNS server's IP address. Servers are supported for secure and dynamic DNS.

Video transmission

If the device is used behind a firewall, TCP (HTTP port) should be selected as the transmission protocol. For use in a local network, choose UDP.

Multicast operation is only possible with the UDP protocol. The TCP protocol does not support multicast connections.

HTTP browser port

Select a different HTTP browser port from the list if required. The default HTTP port is 80. To limit connection to HTTPS, deactivate the HTTP port. To do this, activate the **Off** option.

HTTPS browser port

To limit browser access to encrypted connections, choose an HTTPS port from the list. The standard HTTPS port is 443.

The camera uses the TLS 1.0 protocol. Ensure that the browser has been configured to support this protocol. Also ensure that Java application support is activated (in the Java Plug-in Control Panel of the Windows Control Panel).

To limit connections to SSL encryption, set the **Off** option in the HTTP browser port and the RCP+ port. This deactivates all unencrypted connections allowing connections on the HTTPS port only.

Allow HTTP basic authentication

Select **On** if you want to allow HTTP basic authentication. This is a less secure authentication option where passwords are transmitted in clear text. This option should only be used if the network and system are otherwise secured.

HSTS

Select this option to use the web security policy HTTP Strict Transport Security (HSTS) to provide secure connections.

RCP+ port 1756

Activating RCP+ port 1756 allows unencrypted connections on this port. To allow only encrypted connections, set the **Off** option to deactivate the port.

Discovery port (0 = Off)

Enter the number of the port that you want to discover.

To deactivate the port, enter 0.

Interface mode ETH

If necessary, select the Ethernet link type for interface ETH. Depending on the device connected, it may be necessary to select a special operation type.

Network MSS [Byte]

Set the maximum segment size for the IP packet's user data here. This gives the option to adjust the size of the data packets to the network environment and to optimize data transmission. In UDP mode, comply with the MTU value set below.

Network MTU [Byte]

Specify a maximum value in bytes for the package size (including IP header) to optimize data transmission.

Click **Set** to apply the changes.

4.7.3

Advanced

RTSP

RTSP port

If necessary, select a different port for the exchange of the **RTSP** data from the list. The standard **RTSP port** is 554. Select **Off** to deactivate the **RTSP** function.

TCP metadata input

TCP port

The device can receive data from an external TCP sender, for example an ATM or POS device, and store it as metadata. Select the port for TCP communication. Select **Off** to deactivate the function.

Sender IP address

Enter a valid **Sender IP address**.

Syslog

Server IP address

Enter the appropriate IP address of the server.

Server port (0 = Off)

Enter the number of the server port.

Protocol

Select the appropriate protocol: **UDP**, **TCP**, or **TLS**.

Click **Set** to apply the changes.

4.7.4

Network Management

SNMP

The camera supports two versions of Simple Network Management Protocol (SNMP) for managing and monitoring network components, and can send SNMP messages (traps) to IP addresses. The unit supports SNMP MIB II in the unified code.

Select either of the options that follow for the **SNMP** parameter:

- **SNMP v1 legacy**
- **SNMP v3**

If you select either of the SNMP version, but do not enter an SNMP host address, the camera does not send messages (traps) automatically, but only replies to SNMP requests.

Select **Off** to deactivate the SNMP function.

1. SNMP host address / 2. SNMP host address

If you wish to send SNMP traps automatically, enter the IP addresses of one or two required target units here.

SNMP v3

When you select **SNMP v3** in the field **SNMP**, the tabs **User** and **Trap user** show.

The same fields show in both tabs.

User name

Enter the appropriate user name.

Authentication protocol

Select the appropriate authentication protocol: None, MD5, or SHA1.

Authentication password

Enter the appropriate password for authentication.

Privacy protocol

Select the appropriate privacy protocol: None, DES, or AES.

Privacy password

Enter the appropriate password.

Read-only

To make this information read-only, select this check box.

Quality of service

The camera offers Quality of Service (QoS) configuration options to ensure fast network response to PTZ data and images. Quality of Service (QoS) is the set of techniques to manage network resources. QoS manages the delay, delay variation (jitter), bandwidth, and packet loss parameters to guarantee the ability of a network to deliver predictable results. QoS identifies the type of data in a data packet and divides the packets into traffic classes that can be prioritized for forwarding.

Consult with your network administrator for assistance configuring the **Audio, Video, Control**, and the **Alarm video** settings, and to select the appropriate **Post-alarm time**.

Post-alarm time has a time period from 0 s [seconds] to 3 h [hours]; 15 s [seconds] is the default option.

Click **Set** to apply the changes.

Some changes only take effect after the unit is rebooted. In this case, the **Set** button changes to **Set and Reboot**.

4.7.5

Multicast

The device can enable multiple receivers to receive the video signal simultaneously. The stream is either duplicated and then distributed to multiple receivers (Multi-unicast), or it is sent as a single stream to the network, where it is simultaneously distributed to multiple receivers in a defined group (**Multicast**).

Multicast operation requires a multicast-enabled network that uses **UDP** and the Internet Group Management protocol (**IGMP V2**). The network must support group IP addresses. Other group management protocols are not supported. The **TCP** protocol does not support multicast connections.

A special IP address from 225.0.0.0 to 239.255.255.255 (class D address) must be configured for multicast operation in a multicast-enabled network. The multicast address can be the same for multiple streams, however, it is necessary to use a different port in each case.

The settings must be made individually for each stream. Enter a dedicated multicast address and port for each stream.

The video channels can be individually selected for each stream.

Enable

Enable simultaneous data reception on receivers that need to activate the multicast function. To do this, check the box and enter the multicast address.

Multicast Address

Enter a valid multicast address to be operated in multicast mode (duplication of the data stream in the network).

With a 0.0.0.0 setting, the encoder for the stream operates in multi-unicast mode (copying of data stream in device). The camera supports multi-unicast connections for up to five simultaneously connected receivers.

Duplication of data places a heavy demand on the CPU and can lead to impairment of the image quality under certain circumstances.

Port

Enter the port address for the stream here.

Streaming

Click the checkbox to activate multicast streaming mode. An activated stream is marked with a check. (Streaming is typically not required for standard multicast operation.)

Metadata

You can enable multicast metadata here. The configuration follows the same pattern as for video multicast, but without the streaming option.

Define a multicast address and define a port.

Audio

You can enable multicast audio for different encoders here. The configuration follows the same pattern as for video multicast, but without the streaming option.

Define a multicast address and define a port for the different encoders.

Multicast packet TTL

A value can be entered to specify how long the multicast data packets are active on the network. If multicast is to be run via a router, the value must be greater than 1.

IGMP version

Set the multicast IGMP version to comply with the device.

Click **Set** to apply the changes.

Some changes only take effect after the unit is rebooted. In this case, the **Set** button changes to **Set and Reboot**.

4.7.6

IPv4 Filter

Use this setting to configure a filter that allows or blocks network traffic that matches a specified address or protocol.

IP Address 1 / 2

Enter the IPv4 address that you want to allow or block

Mask 1 / 2

Enter the subnet mask for the appropriate IPv4 address.

Click **Set** to apply the changes.

4.8 Service

4.8.1 Maintenance



Notice!

Before starting a firmware update, make sure to select the correct upload file.

Do not interrupt the firmware installation. Even changing to another page or closing the browser window leads to interruption.

Uploading the wrong files or interrupting the upload can result in the device no longer being addressable, requiring it to be replaced.

The camera functions and parameters can be updated by uploading new firmware. To do this, the latest firmware package is transferred to the device via the network. The firmware is installed there automatically. Thus, a camera can be serviced and updated remotely without requiring a technician to make changes to the device on site. The latest firmware can be obtained from your customer service center or from the download area.

Update server

The address of the update server appears in the address box.

1. Click **Check** to make a connection to this server.
2. Select the appropriate version for your camera to download the firmware from the server.

Firmware

To update the firmware:

1. First, store the firmware file on your hard disk.
2. Enter the full path for the firmware file in the field or click **Browse...** to locate and select the file.
3. Click **Upload** to begin transferring the file to the device. The progress bar allows monitoring of the transfer.

The new firmware is unpacked and the Flash memory is reprogrammed. The time remaining is shown by the message going to reset Reconnecting in ... seconds. When the upload is completed successfully, the device reboots automatically.

Upload history

Click **Show** to view the firmware upload history.

Configuration

Save configuration data for the device to a computer and load saved configuration data from a computer to the device.

To load configuration data from the computer to the device:

1. Click **Browse....** A dialog box appears.
Make certain that the file to be loaded comes from the same device type as the device to be reconfigured.
2. Locate and open the desired configuration file. If the configuration file is password-protected, enter the password.
3. Click **Upload**.
The progress bar allows monitoring of the transfer. The time remaining is shown by the message going to reset Reconnecting in ... seconds. When the upload is completed successfully, the device reboots automatically.

To save the camera settings:

1. Click **Download**. A dialog box appears.
2. Enter a password to protect the configuration file.
3. Enter a file name if required and save the file.

Maintenance log

Download an internal maintenance log from the device to send it to Customer Service for support purposes. Click **Download** and select a storage location for the file.

4.8.2

Licenses

This window activates more functions with use of an **Activation key**. An overview of the **Installed licenses** is shown. Also, the **Installation code** of the unit is shown. Click **Set** to apply the changes.

4.8.3

Certificates

Add a certificate/file to the file list

Click **Add**.

In the **Add certificate** window, select:

- **Upload certificate** to select a file that is available:
 - Click **Browse...** to navigate to the necessary file.
 - Click **Upload**.
- **Generate signing request** for a signing authority to create a new certificate:
 - Fill in all the necessary fields.
 - Click **Generate**.
- **Generate certificate** to create a new self-assigned certificate:
 - Fill in all the necessary fields.
 - Click **Generate**.

Note: When using certificates for mutual authentication, the device must use a solid and trusted time base. In case the time differs too much from the actual time, a client can be locked out. Then, only a reset to factory defaults will access to the device again.

Delete a certificate from the file list

Click the trashcan icon to the right of the certificate. The Delete file window appears. To confirm deletion, click OK. To cancel deletion, click Cancel.

Note: You can only delete certificates that you have added; you cannot delete the default certificate.

Download a certificate

Click on the download icon and a window opens with base64 encoded text of the certificate. Click **Set** to apply the changes.

4.8.4

Logging

Event Logging

Current log level

Select the level of event for which to display log entries or to log.

Number of displayed entries

Select the number of entries to display.

Software Sealing

Enable software sealing

Select this check box to enable software protection that prevents users from adjusting camera settings. This function also protects the camera from unauthorized access.

Debug Logging

Retrieves detailed information of the active logs.

Reload

Reloads the displayed entries.

Download log

Save a copy of the entries from the device to a computer.

To save the entries:

1. Click **Download log**; a dialog box appears.

Enter a file name if required and save

4.8.5**System Overview**

This window is for information only and cannot be modified. Keep this information at hand when seeking technical support.

Select the text on this page with a mouse and copy it so that it can be pasted into an e-mail if required.

5 Troubleshooting

5.1 Physical reset button

Each camera has a hardware reset button. You may need to press the reset button to reset the camera to factory defaults if you encounter the following circumstances:

- You can power up the camera but cannot log on to the camera using the web browser.
- The camera doesn't start up, or fails to power up via PoE.
- The camera cannot search an IP address.
- The camera's firmware crashed.
- You forgot the password to access the camera.
- The image becomes frozen.
- You cannot update the firmware.
- The camera disconnects from the network at random and needs a reboot.
- The camera no longer finds pre-positions (preset positions).
- You cannot configure the camera using the web browser.
- The camera has no video out.



Notice!

A factory default deletes all camera settings including passwords, network settings, and image settings.

Complete the following sequence of steps only if you have no other option to restore operation to the camera.

Steps to complete a hardware reset for all camera models

1. Apply power to the camera.
2. Find the hardware reset button on the camera block. (See each section below to locate the reset button for your camera model.)
3. Push and hold the reset button for more than 10 seconds. The red LED indicator on the device will begin flashing to show that the hardware reset started.
4. Let the camera complete a self-check. When the self-check completes, the red LED will turn off.
5. Search again for the IP address. Access the camera using the web browser. Set the initial password for the camera.

For FLEXIDOME panoramic 5100i, the reset button is near the micro HDMI connection port. To access the reset button, remove the camera cover. Note that the reset button does not show the text RESET to prevent tampering.

For FLEXIDOME panoramic 5100i IR, the reset button is close to the golden 2x 10-pin connector. To access the reset button, remove the camera dome cover.

6 Appendices

6.1 Copyright notices

The firmware uses the fonts "Adobe-Helvetica-Bold-R-Normal--24-240-75-75-P-138-ISO10646-1" and "Adobe-Helvetica-Bold-R-Normal--12-120-75-75-P-70-ISO10646-1" under the following copyright:

Copyright 1984-1989, 1994 Adobe Systems Incorporated.

Copyright 1988, 1994 Digital Equipment Corporation.

Permission to use, copy, modify, distribute and sell this software and its documentation for any purpose and without fee is hereby granted, provided that the above copyright notices appear in all copies and that both those copyright notices and this permission notice appear in supporting documentation, and that the names of Adobe Systems and Digital Equipment Corporation not be used in advertising or publicity pertaining to distribution of the software without specific, written prior permission.

This software is based in part on the work of the Independent JPEG Group.

Stratocast is a trademark of Genetec, Inc.

Dropbox is a trademark of Dropbox, Inc.

6.2 More information



Support

Access our **support services** at www.boschsecurity.com/xc/en/support/.

Bosch Security and Safety Systems offers support in these areas:

- [Apps & Tools](#)
- [Building Information Modeling](#)
- [Warranty](#)
- [Troubleshooting](#)
- [Repair & Exchange](#)
- [Product Security](#)



Bosch Building Technologies Academy

Visit the Bosch Building Technologies Academy website and have access to **training courses**, **video tutorials** and **documents**: www.boschsecurity.com/xc/en/support/training/



Bosch Security Systems B.V.

Torenallee 49

5617 BA Eindhoven

Netherlands

www.boschsecurity.com

© Bosch Security Systems B.V., 2021