



**KVM Switch  
KH1508A / KH1516A  
User Manual**



## FCC, CE Information

**FEDERAL COMMUNICATIONS COMMISSION INTERFERENCE STATEMENT:** This equipment has been tested and found to comply with the limits for a Class A digital device, pursuant to Part 15 of the FCC Rules. These limits are designed to provide reasonable protection against harmful interference when the equipment is operated in a commercial environment. This equipment generates, uses, and can radiate radio frequency energy and, if not installed and used in accordance with the instruction manual, may cause harmful interference to radio communications. Operation of this equipment in a residential area is likely to cause harmful interference in which case the user will be required to correct the interference at his own expense.

**FCC Caution:** Any changes or modifications not expressly approved by the party responsible for compliance could void the user's authority to operate this equipment.

**CE Warning:** This is a class A product. In a domestic environment this product may cause radio interference in which case the user may be required to take adequate measures.

## RoHS

This product is RoHS compliant.

## SJ/T 11364-2006

The following contains information that relates to China.

部件名称	有毒有害物质或元素					
	铅	汞	镉	六价铬	多溴联苯	多溴二苯醚
电器部件	●	○	○	○	○	○
机构部件	○	○	○	○	○	○

- : 表示该有毒有害物质在该部件所有均质材料中的含量均在SJ/T 11363-2006规定的限量要求之下。
- : 表示符合欧盟的豁免条款, 但该有毒有害物质至少在该部件的某一均质材料中的含量超出SJ/T 11363-2006的限量要求。
- ×: 表示该有毒有害物质至少在该部件的某一均质材料中的含量超出SJ/T 11363-2006的限量要求。



## User Information

---

### Online Registration

Be sure to register your product at our online support center:

International	<a href="http://eservice.aten.com">http://eservice.aten.com</a>
---------------	---

### Telephone Support

For telephone support, call this number:

International	886-2-8692-6959
China	86-10-5255-0110
Japan	81-3-5615-5811
Korea	82-2-467-6789
North America	1-888-999-ATEN ext 4988
United Kingdom	44-8-4481-58923

### User Notice

All information, documentation, and specifications contained in this manual are subject to change without prior notification by the manufacturer. The manufacturer makes no representations or warranties, either expressed or implied, with respect to the contents hereof and specifically disclaims any warranties as to merchantability or fitness for any particular purpose. Any of the manufacturer's software described in this manual is sold or licensed *as is*. Should the programs prove defective following their purchase, the buyer (and not the manufacturer, its distributor, or its dealer), assumes the entire cost of all necessary servicing, repair and any incidental or consequential damages resulting from any defect in the software.

The manufacturer of this system is not responsible for any radio and/or TV interference caused by unauthorized modifications to this device. It is the responsibility of the user to correct such interference.

The manufacturer is not responsible for any damage incurred in the operation of this system if the correct operational voltage setting was not selected prior to operation. **PLEASE VERIFY THAT THE VOLTAGE SETTING IS CORRECT BEFORE USE.**

## Package Contents

---

The KH1508A / KH1516A package consists of:

- 1 KH1508A or KH1516A Cat 5 High-Density KVM Switch
- 1 Firmware Upgrade Cable
- 1 Power Cord
- 1 Mounting Kit
- 1 Foot Pad Set (4 pcs.)
- 1 User Instructions\*

Check to make sure that all of the components are present and in good order. If anything is missing, or was damaged in shipping, contact your dealer.

Read this manual thoroughly and follow the installation and operation procedures carefully to prevent any damage to the switch or to any other devices on the KH1508A / KH1516A installation.

---

\* Features may have been added to the KH1508A / KH1516A since this manual was published. Please visit our web site to download the most up-to-date version of the manual.

---

Copyright © 2013 ATEN® International Co., Ltd.  
Manual Part No. PAPE-0268-AX4G  
Manual Date: 2013-11-20

Altusen and the Altusen logo are registered trademarks of ATEN International Co., Ltd. All rights reserved.  
All other brand names and trademarks are the registered property of their respective owners.

# Contents

---

FCC, CE Information . . . . .	ii
RoHS . . . . .	ii
SJ/T 11364-2006 . . . . .	ii
User Information . . . . .	iii
Online Registration . . . . .	iii
Telephone Support . . . . .	iii
User Notice . . . . .	iii
Package Contents . . . . .	iv
About This Manual . . . . .	viii
Overview . . . . .	viii
Conventions . . . . .	ix
Product Information . . . . .	ix

## Chapter 1.

### Introduction

Overview . . . . .	1
Features and Benefits . . . . .	2
Requirements . . . . .	4
Console . . . . .	4
Computers . . . . .	4
KVM Adapter Cables . . . . .	5
Operating Systems . . . . .	5
Components . . . . .	6
Front View . . . . .	6
KH1508A . . . . .	6
KH1516A . . . . .	6
Rear View . . . . .	8
KH1508A . . . . .	8
KH1516A . . . . .	8

## Chapter 2.

### Hardware Setup

Overview . . . . .	11
Before you Begin . . . . .	11
Stacking and Rack Mounting . . . . .	12
Stacking . . . . .	12
Rack Mounting . . . . .	13
Single Station Installation . . . . .	14
Daisy Chaining . . . . .	18

**Chapter 3.****Basic Operation**

Port Selection . . . . .	21
Manual . . . . .	21
OSD . . . . .	21
Hotkey . . . . .	21
Hot Plugging . . . . .	22
Hot Plugging Stations . . . . .	22
Hot Plugging KVM Ports . . . . .	22
Hot Plugging Console Ports . . . . .	22
Powering Off and Restarting . . . . .	23
Port ID Numbering . . . . .	23

**Chapter 4.****OSD Operation**

OSD Overview . . . . .	25
OSD Navigation . . . . .	27
OSD Main Screen Headings . . . . .	27
OSD Functions . . . . .	28
F1: GOTO . . . . .	28
F2: LIST . . . . .	29
F3: SET . . . . .	30
F4: ADM . . . . .	33
F5: SKP . . . . .	36
F6: BRC . . . . .	37
F7: SCAN . . . . .	38
F8: LOUT . . . . .	39

**Chapter 5.****Hotkey Operation**

Hotkey Port Control . . . . .	41
Invoking Hotkey Mode . . . . .	42
Number Lock and Minus Keys . . . . .	42
Control and F12 Keys . . . . .	42
Hotkey Mode Environment . . . . .	42
Exiting Hotkey Mode . . . . .	42
Selecting the Active Port . . . . .	43
Auto Scan Mode Switching . . . . .	44
Setting the Scan Interval . . . . .	44
Invoking Auto Scan . . . . .	44
Exiting Auto Scan . . . . .	45
Skip Mode Switching . . . . .	46
Entering Skip Mode . . . . .	46
Exiting Skip Mode . . . . .	46
Computer Keyboard / Mouse Reset . . . . .	47

---

Setting the Hotkey Beeper ON/OFF . . . . .	47
Setting the Hotkey key combination . . . . .	48
Setting the OSD Hotkey combination . . . . .	48
Setting the Port Operating System . . . . .	49
Restore the Default Values . . . . .	49
Hotkey Summary Table. . . . .	50

## **Chapter 6.**

### **Keyboard Emulation**

Mac Keyboard . . . . .	51
Sun Keyboard . . . . .	52

## **Chapter 7.**

### **The Firmware Upgrade Utility**

Introduction . . . . .	53
Before You Begin . . . . .	53
Performing the Upgrade . . . . .	55
Starting the Upgrade . . . . .	55
Upgrade Succeeded . . . . .	58
Upgrade Failed . . . . .	59
Firmware Upgrade Recovery . . . . .	59
Main Board Firmware Upgrade Recovery . . . . .	59
Adapter Cable Firmware Upgrade Recovery. . . . .	60

## **Appendix**

Safety Instructions. . . . .	61
General . . . . .	61
Rack Mounting . . . . .	63
Technical Support. . . . .	64
International. . . . .	64
North America . . . . .	64
Specifications . . . . .	65
Connection Tables . . . . .	67
KH1508A . . . . .	67
KH1516A. . . . .	67
Compatible Switches. . . . .	68
OSD Factory Default Settings. . . . .	69
Administrator Login Failure . . . . .	70
Troubleshooting . . . . .	71
Overview . . . . .	71
Limited Warranty. . . . .	72

## About This Manual

---

This User Manual is provided to help you get the most from your KH1508A / KH1516A system. It covers all aspects of installation, configuration and operation. An overview of the information found in the manual is provided below.

### Overview

**Chapter 1, Introduction**, introduces you to the KH1508A / KH1516A system. Its purpose, features and benefits are presented, and its front and back panel components are described.

**Chapter 2, Hardware Setup**, describes how to set up your installation. The necessary steps – from a basic single stage hookup to a complete daisy chained operation are provided.

**Chapter 3, Basic Operation**, explains the fundamental concepts involved in operating the KH1508A / KH1516A.

**Chapter 4, OSD Operation**, provides a complete description of the KH1508A / KH1516A's OSD (On Screen Display), and how to work with it.

**Chapter 5, Hotkey Operation**, details all of the concepts and procedures involved in the keyboard hotkey operation of your KH1508A / KH1516A installation.

**Chapter 6, Keyboard Emulation**, provides tables that list the PC to Mac and PC to Sun keyboard emulation mappings.

**Chapter 7, The Firmware Upgrade Utility**, explains how to upgrade the KH1508A / KH1516A's firmware with the latest available versions.

**An Appendix**, provides specifications and other technical information regarding the KH1508A / KH1516A.



## Conventions

This manual uses the following conventions:

- Monospaced      Indicates text that you should key in.
- [ ]                Indicates keys you should press. For example, **[Enter]** means to press the **Enter** key. If keys need to be chorded, they appear together in the same bracket with a plus sign between them: [Ctrl+Alt].
1.                 Numbered lists represent procedures with sequential steps.
- ◆                 Bullet lists provide information, but do not involve sequential steps.
- Indicates selecting the option (on a menu or dialog box, for example), that comes next. For example, *Start* → *Run* means to open the *Start* menu, and then select *Run*.
-                 Indicates critical information.

## Product Information

---

For information about all ALTUSEN products and how they can help you connect without limits, visit ALTUSEN on the Web or contact an ALTUSEN Authorized Reseller. Visit ALTUSEN on the Web for a list of locations and telephone numbers:

International	<a href="http://www.aten.com">http://www.aten.com</a>
North America	<a href="http://www.aten-usa.com">http://www.aten-usa.com</a>

This Page Intentionally Left Blank

# Chapter 1

## Introduction

### Overview

---

A KH1508A or KH1516A KVM switch is a control unit that allows IT administrators to access and control multiple computers from a single PS/2 or USB KVM (keyboard, monitor, and mouse) console. A single KH1508A / KH1516A can control up to 8 / 16 computers.

By daisy chaining up to 31 additional switches, as many as 512 computers can be controlled from the original KVM console. An auto-sensing function recognizes the position of each station on the chain, eliminating the need to manually set the position, and a seven-segment front panel LED displays each Station's position for easy identification.

Compact, high-density, RJ-45 connectors and CAT 5e/6 cable make for a compact, efficient, wiring configuration, while the use of PS/2 and USB *KVM Adapter Cables* to link to the computers, permits any combination of PCs, Macs, Sun computers, and serial devices to coexist on the installation.

Setting up the KH1508A / KH1516A is fast and easy – plugging cables into their appropriate ports is all that is entailed. Because the KH1508A / KH1516A intercepts keyboard and mouse input directly, there is no software to configure and no complex installation routines.

Access to any computer on the installation is easily accomplished – either by pressing front panel port selection pushbuttons; entering hotkey combinations from the keyboard; or by means of a powerful OSD (On Screen Display) menu system. A convenient Auto Scan function also permits automatic scanning and one-by-one monitoring of the activities of selected computers.

Your KH1508A / KH1516A investment is protected through firmware upgrades. You can download firmware update files from our website, and use the *Firmware Upgrade* function to quickly and conveniently install them.

There is no better way to save time and money than with a KH1508A / KH1516A installation. By allowing a single console to manage up to 512 computers, you: (1) eliminate the expense of purchasing separate keyboards, monitors, and mice; (2) save space; (3) save on energy costs; and (4) eliminate the inconvenience and wasted effort involved in constantly having to move from one computer to another.

## Features and Benefits

The features and benefits provided by a KH1508A / KH1516A deployment are described in the following table:

Features	Benefits
Simple Installation and Operation	Plug-and-play installation – no software required – connecting cables is all it takes. Station positions are automatically recognized. Computer selection via front panel switches; hotkeys; or multi-language OSD (On Screen Display) menus.
Single Console Control	Access and control up to 8 (KH1508A) or 16 (KH1516A) computers from a single PS/2 or USB KVM (keyboard, monitor, and mouse) console.
Scalability	By daisy chaining up to 31 additional KH1508A / KH1516A switches, as many as 512 computers can be controlled from the original KVM console – eliminating the expense of purchasing separate peripherals for each server.
Easy Installation	Setting up the KH1508A / KH1516A is fast and easy – plugging cables into their appropriate ports is all that is entailed. Because there is no software to configure, incompatibility and configuration issues are non-existent.
Easy Operation	<p>Three port selection methods: Manual (via front panel pushbuttons), Hotkey, and multi-language OSD (On Screen Display).</p> <p>Multi-language keyboard support includes English (US / UK), French, German, Japanese, Korean, and Traditional Chinese.</p>
Hardware Independent Cross-Platform Support	The KH1508A / KH1516A supports Windows 2000/XP/Vista/7, Linux, Unix, Novell, FreeBSD, Sun, and Mac.
Space-Saving RJ-45 Connectors and Cat 5e/6 Cabling	<p>This space-saving innovation means that the KH1508A / KH1516A can be conveniently installed in a 1U system rack, and the installation can take advantage of the internal network wiring built into most modern commercial buildings.</p> <p>Reduces cable clutter for a neat and tidy data center environment</p>
KVM Adapter Cables to Connect to Servers and Devices	<p>For convenience and flexibility that allows mixing the PS/2, USB and serial interfaces, the KH1508A / KH1516A's design utilizes KVM adapter cables that serve as intermediaries between the KVM switch and the connected devices.</p> <p>KVM adapter cables are available in PS/2, USB, and Serial interfaces to support a wide variety of data center servers and devices.</p>
Two-Level Password Security	Supports one administrator and ten user profiles. Strong password protection prevents unauthorized accessing to the installation – keeping your valuable data secure.

Features	Benefits
Upgradeable Firmware	Stay current with the latest functionality improvements and updates by downloading firmware upgrade files from our website and installing them with the built-in firmware upgrade utility.
Effortless Upgrades	Simultaneous firmware upgrades to all daisy-chained KVM switches and dongles through the daisy-chain cable.
Auto Scanning and Broadcast Mode	Auto scanning provides hands-free monitoring of selected devices at variable rates. Broadcast Mode sends commands from the console to all computers – allowing you to perform operations (such as software installation, upgrades, shutdowns, etc.), on them simultaneously
Superior Video Quality	Supports the video resolutions up to 1600x1200@60hz for up to 40 meters, and 1280x1024@75hz for up to 50 meters with the new ATEN KVM Cable Adapter KA7000 series.
Multiple User Accounts	Supports up to 10 user and 1 administrator accounts
Hot Pluggable	Ability to add or remove components without having to power off the KVM switch.
Adapter Cables with ID	<p>The KH1508A / KH1516A KVM series supports automatic ID recognition of the new ATEN KVM Cable Adapter KA7000 series ( <i>KVM Adapter Cables</i>). Using the new adapter cables with ID means it is not required to change cable configuration settings when moving cables from port to port.</p> <p>Device ID and attributes are stored in the adapter cables allowing you to hot-swap port connections without having to reconfigure attributes.</p>

## **Requirements**

---

### **Console**

- ◆ A VGA, SVGA, or multisync monitor capable of the highest resolution that you will be using on any computer in the installation
- ◆ A PS/2 or USB mouse
- ◆ A PS/2 or USB keyboard

### **Computers**

The following equipment must be installed on the computers that connect to the KH1508A or KH1516A KVM ports:

- ◆ A VGA, SVGA or multisync port
- ◆ A Type A USB port and USB host controller (for USB KVM adapter cable connection, see following section)  
- or -
- ◆ 6-pin Mini-DIN keyboard and mouse ports (for PS/2 KVM adapter cable connection, see following section)

## **KVM Adapter Cables**

- ♦ Cat 5e/6 cable is required to connect the KH1508A / KH1516A to one of the KVM adapter cables.
- ♦ The following KVM adapter cables are required for use with the KH1508A / KH1516A:

Function	Module
Connect to devices with PS/2 ports	KA7920 / KA7520 / KA7120 KA9520 / KA9120
Connect to devices with USB ports	KA7166 / KA7168 / KA7169 / KA7970 / KA7570 / KA7170 KA9570 / KA9170
Connect to Sun Legacy systems (with 13W3 port)	KA9130 / KA7130
Connect to Sun USB systems	KA9170 / KA7170
Connect to serial based devices	KA9140

- Note:** 1. KVM adapter cables are referred to as *I/O Modules* in some dialog boxes.
2. The following cable models support the Adapter Cable ID function:  
KA7166 / KA7168 / KA7169 / KA7920 / KA7970 / KA7520 / KA7570  
/ KA7120 / KA7130 / KA7170.

## **Operating Systems**

Supported operating systems are shown in the table, below:

OS	Version	
Windows	NT <sup>1</sup> , 2000, XP, 2003 Server, 2008 Server, Vista	
Linux <sup>2</sup>	RedHat	9.0, Fedora and higher, RHEL AS 4, RHEL 5
	SuSE	10 and higher, OpenSUSE 10.2; SLES 10 SP1
	Debian	3.1, 4.0
	Ubuntu	7.04, 7.10
UNIX	IBM	AIX4.3, 5L (V5.2,V5.3), V6 (V6.1)
	FreeBSD	5.5, 6.1, 6.2
Novell	Netware	5.0 and higher
Sun		Solaris 8, 9, 10
Mac		9.0, 9.1, 10.1, 10.2, 10.3, 10.4 , 10.5
DOS		6.2 and higher <sup>1</sup>

<sup>1</sup> Does not support USB. <sup>2</sup> Kernels below 2.6 do not support USB 2.0

# Components

---

## Front View

### KH1508A

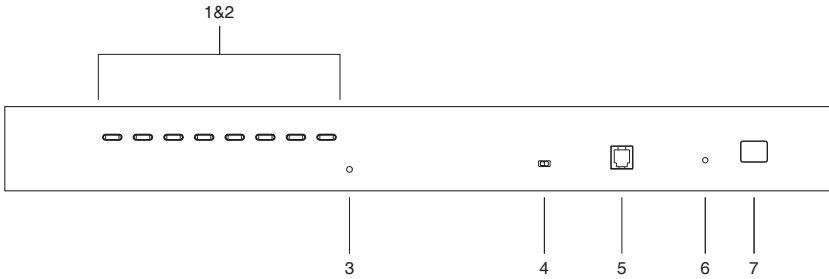

### KH1516A

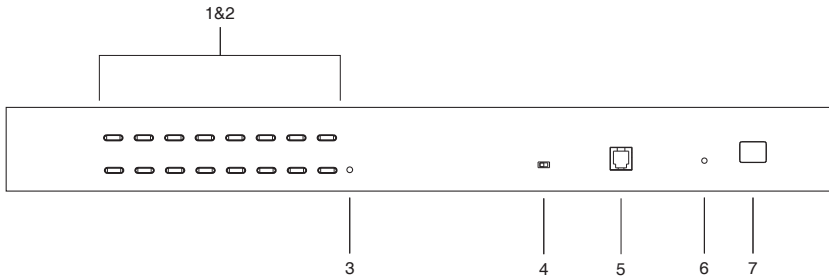



No.	Component	Description
1	Port Selection Pushbuttons	<ul style="list-style-type: none"> <li>◆ Press a pushbutton to give the KVM focus to the computer attached to its corresponding port.</li> <li>◆ Simultaneously pressing pushbuttons 1 and 2 for 3 seconds performs a keyboard and mouse reset.</li> <li>◆ Simultaneously pressing pushbuttons 7 and 8 (KH1508A) or 15 and 16 (KH1516A) starts Auto Scan mode (see F7: SCAN, page 38, for auto scan details).</li> </ul>
2	Port LEDs	<p>The Port LEDs are built into the Port Selection Pushbuttons. The left ones are the <i>On Line</i> LEDs; the right ones are the <i>Selected Port</i> LEDs:</p> <ul style="list-style-type: none"> <li>◆ An <i>On Line</i> LED lights GREEN to indicate that the computer attached to its corresponding port is up and running. A flashing LED indicates that the Port is being used for cascading to another switch.</li> <li>◆ A <i>Selected</i> LED lights ORANGE to indicate that the computer attached to its corresponding port is the one that has the KVM focus. The LED is steady under normal conditions, but flashes when its port is accessed under Auto Scan mode (see F7: SCAN, page 38, for auto scan details).</li> </ul>
3	Reset Switch	<p>Pressing this switch in performs a system reset.</p> <p><b>Note:</b> The switch is recessed and must be pushed with a small object, such as the end of a paper clip, or a ballpoint pen.</p>
4	Firmware Upgrade Recovery Switch	<p>During normal operation and while performing a firmware upgrade, this switch should be in the NORMAL position. If a firmware upgrade operation does not complete successfully, this switch is used to perform a firmware upgrade recovery. See <i>Firmware Upgrade Recovery</i>, page 59 for details.</p>
5	Firmware Upgrade Port	<p>The Firmware Upgrade Cable that transfers the firmware upgrade data from the administrator's computer to the KH1508A / KH1516A (see page 53), plugs into this RJ-11 connector.</p>
6	Power LED	<p>Lights to indicate that the KH1508A / KH1516A is powered and ready to operate.</p>
7	Station ID LED	<p>The KH1508A / KH1516A's Station ID is displayed here. If this is a single station installation (see page 14), or the first station on a daisy chained installation (see page 16), the KH1508A / KH1516A has a station ID of 01.</p> <p>On a daisy chained installation, the KH1508A / KH1516A auto-senses its position and displays the station ID that corresponds to its place in the chain. (see <i>Port ID Numbering</i>, page 23, for details).</p>

## Rear View

### KH1508A

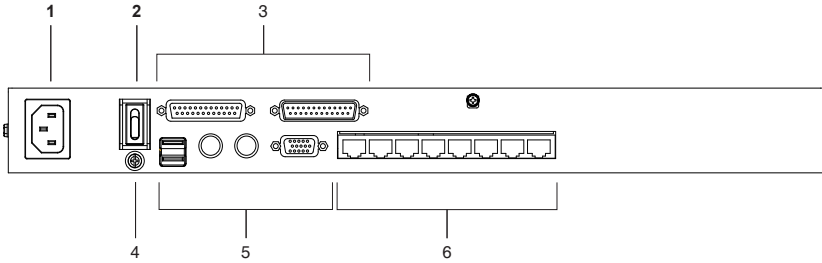

### KH1516A

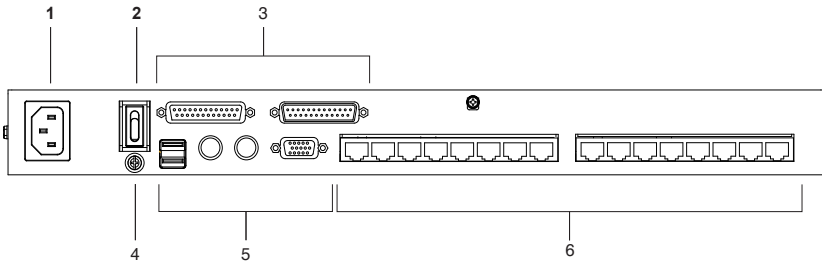

No.	Component	Description
1	Power Socket	The power cord to the AC source plugs in here.
2	Power Switch	This is a standard rocker switch that powers the KH1508A / KH1516A on and off.
3	Daisy Chain Ports	When daisy chaining units (see , page 16), the daisy chain cables plug in here. The port on the left is the <i>Chain In</i> port; the port on the right is the <i>Chain Out</i> port.
4	Grounding Terminal	The wire used to ground the unit connects here.
5	Console Ports	If this is a single station installation, or if this is the first station of a daisy chained installation, the keyboard, monitor, and mouse that make up the Local Console plug in here. You can use any combination of PS/2 and USB keyboards and mice for the console.
6	KVM Port Section	The Cat 5e/6 cables that link to the KVM adapter cables (which link to the computers) plug in here.

This Page Intentionally Left Blank

# Chapter 2

## Hardware Setup

### Overview

---

For convenience and flexibility that allows mixing the PS/2, USB and serial interfaces, the KH1508A / KH1516A's design utilizes KVM adapter cables that serve as intermediaries between the KVM switch and the connected devices:

A separate KVM adapter cable is required for each computer or device connection. The KVM adapter cables are listed in the *KVM Adapter Cables* section on page 5. Consult your dealer to find out which KVM adapter cables best fit your needs.

### Before you Begin

---



1. Important safety information regarding the placement of this device is provided on page 61. Please review it before proceeding.
2. Make sure that the power to any device that you connect to the installation has been turned off. You must unplug the power cords of any computers that have the Keyboard Power On function.

## **Stacking and Rack Mounting**

---

The KH1508A / KH1516A can be stacked on the desktop or rack mounted at the front or rear of the rack. The following sections take you through the procedures for each method.

- 
- Note:** 1. Allow at least 5.1 cm on each side for adequate ventilation and 12.7 cm at the rear for power cord and cable clearance.
2. The standard rack mount kit does not include rack mount screws or cage nuts. If you need additional rack mount screws or cage nuts, contact your rack dealer.
- 

### **Stacking**

The KH1508A / KH1516A can be placed on any appropriate level surface that can safely support its weight plus the weight of its attached cables. To place the KH1508A / KH1516A, or to stack units if you are daisy chaining them, remove the backing material from the bottom of the rubber feet that came with this package, and stick them onto the switch's bottom panel at the corners, as shown in the diagram, below:

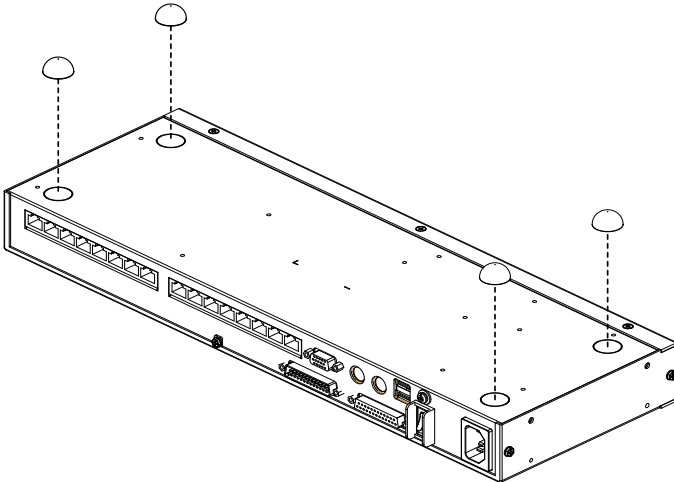

## Rack Mounting

The KH1508A / KH1516A can be mounted in a 19" (1U) rack. The mounting brackets can screw into either the front or the back of the unit so that it can attach to the front or the back of the rack. To rack mount the unit:

1. Remove the screws at the front or the rear, as shown in the diagram below.

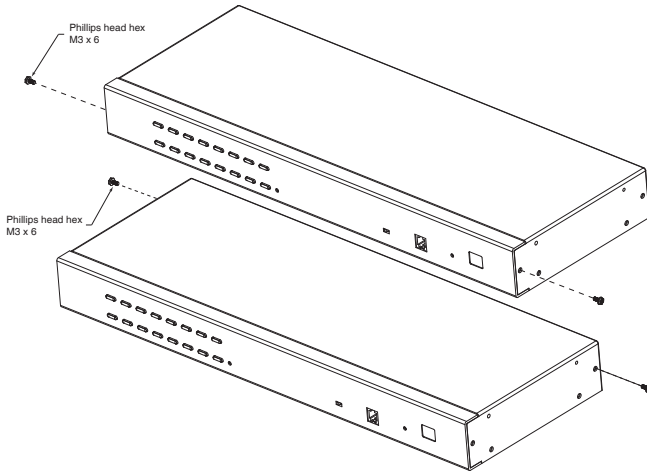

2. Screw the mounting brackets into the sides of the unit at the front or the rear, as shown in the diagram below.

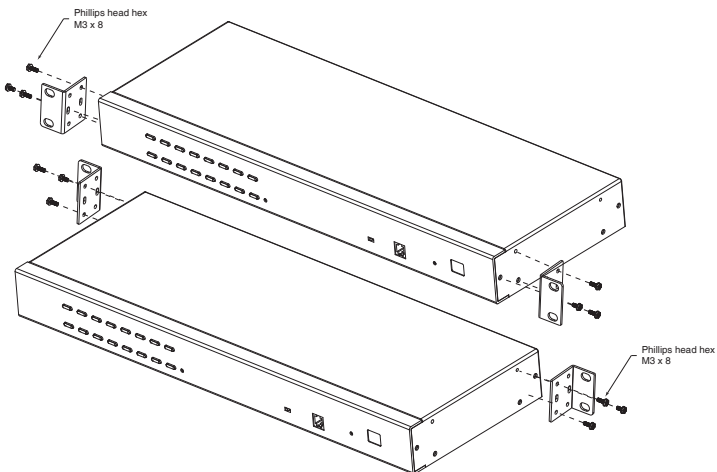

3. Slide the unit into the front or rear of the rack and secure it to the rack.

## Single Station Installation

---

In a single stage installation, there are no additional KVM switches daisy chained down from the KH1508A / KH1516A. To set up a single stage installation, refer to the installation diagrams starting on page 15 (the numbers in the diagram correspond with the numbers of the instruction steps), and do the following:

1. Ground the KH1508A / KH1516A by connecting one end of a grounding wire to the grounding terminal, and the other end of the wire to a suitable grounded object.

---

**Note:** Do not omit this step. Proper grounding helps to prevent damage to the unit from surges or static electricity.

---

2. Plug the the console keyboard, monitor, and mouse into the unit's console ports. The ports are color coded and marked with icons for easy identification.

---

**Note:** You can use any combination of keyboard and mouse connections. For example, you can use a PS/2 keyboard with a USB mouse.

---

3. Use Cat 5e/6 cable to connect any available KVM port to a KVM adapter cable that is appropriate for the computer you are installing (see *KVM Adapter Cables*, page 5 for details).

---

**Note:** To support a resolution of 1280x1024, the recommended maximum distance between the unit and the KVM adapter cable is 50 meters.

---

4. Connect the KVM adapter cable to the computer.  
Plug the connectors on the KVM adapter cable into the appropriate ports of the computer you are installing. (See *KVM Adapter Cable Installation Diagrams*, page 16 for connection examples.)
5. Plug the female end of the power cord into the KH1508A / KH1516A's power socket; plug the male end into an AC power source.

After the KH1508A / KH1516A is cabled up, you can turn on the power. After it is powered up, you can turn on the servers.



## Single Stage Installation Diagram

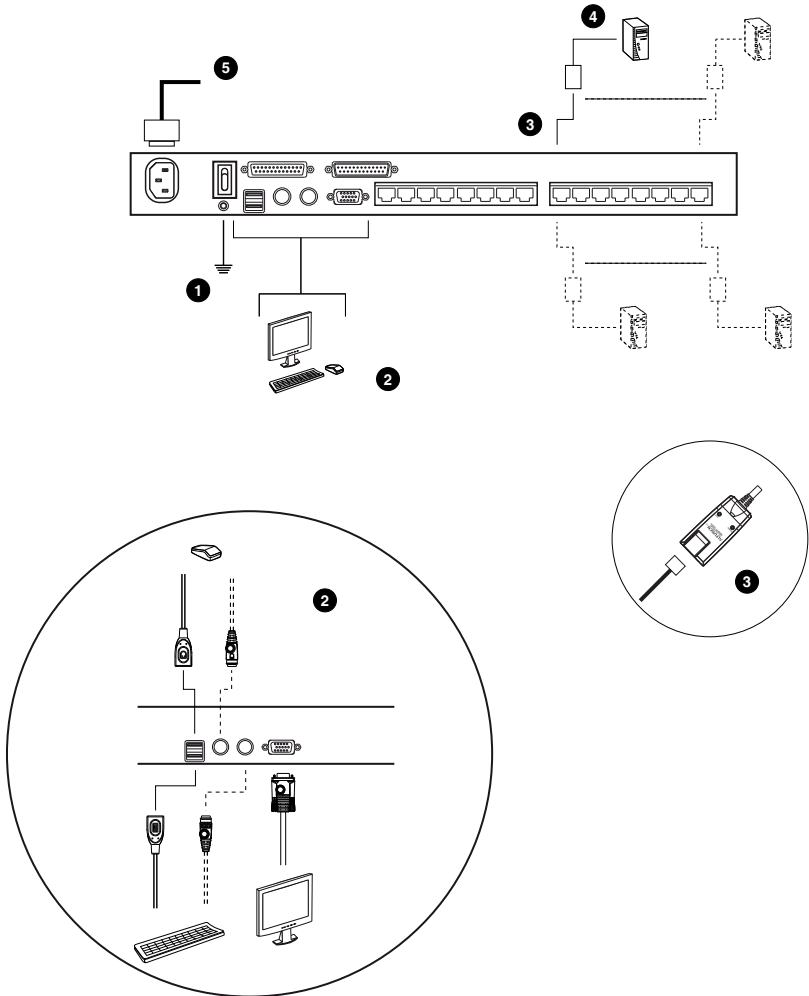

## KVM Adapter Cable Installation Diagrams

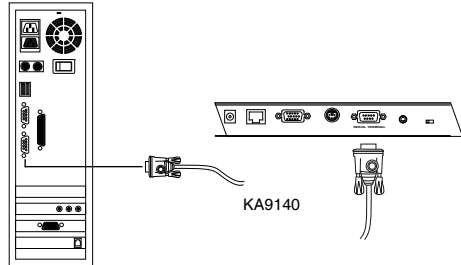
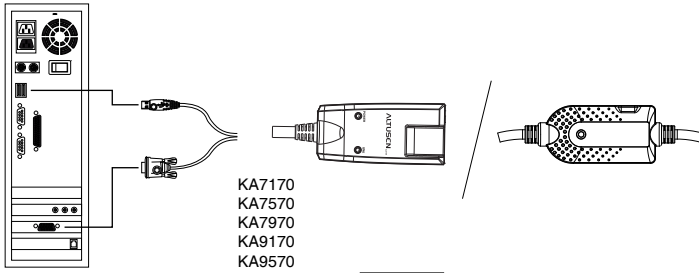
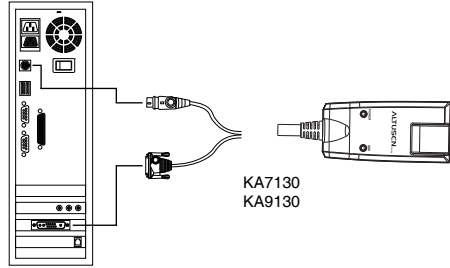
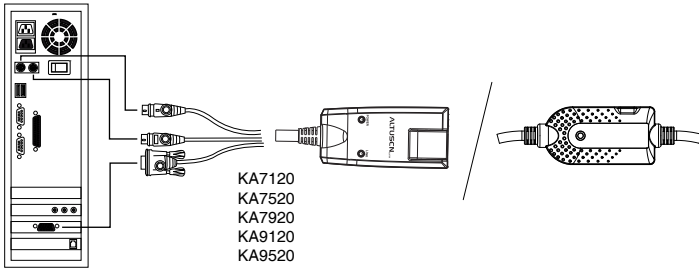

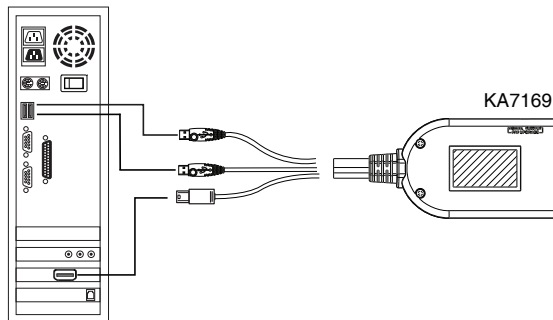
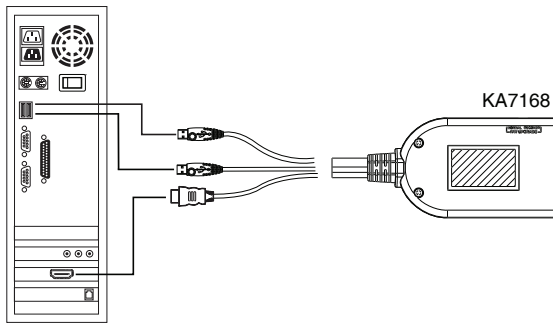
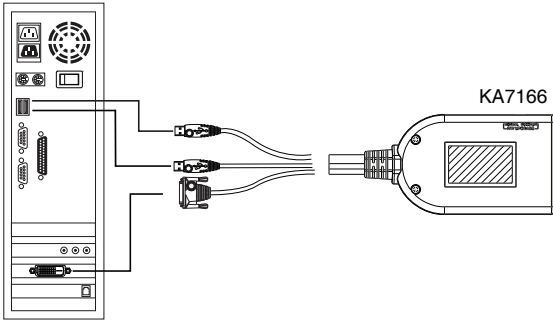
**KVM Adapter Cable Installation Diagrams cont.**

## Daisy Chaining

---

To control even more computers, up to 31 additional KH1508A / KH1516A KVM switches can be daisy chained from the original KH1508A or KH1516A. As many as 512 computers can be controlled from a single console in a complete installation.

---

**Note:** Please see the table, *Compatible Switches*, page 68 for a list of ATEN switches that can be installed on a KH1508A / KH1516A daisy chain.

---

Tables showing the relation between the number of computers and the number of KH1508A / KH1516A units needed to control them are provided on page 65.

To set up a daisy chained installation, do the following:

1. Use a daisy chain cable set to connect the *Chain Out* port of the parent KH1508A / KH1516A unit to the *Chain In* port of the child KH1508A / KH1516A unit (first station out to second station in, second station out to third station in, etc.).

---

**Note:**

1. You cannot use the chain in port of the First Station, since it is the highest level parent.
2. Daisy chain cable sets require a separate purchase. See your dealer for details.

---

2. Cable up the computers and the switch according to the information provided under *Single Station Installation*, page 14.
3. Repeat the above for any other switches you want to add to the chain.
4. Power up the installation according to the following procedure:
  - a) Plug in the power cord for the first station. Wait for the unit to ascertain its station ID and display it on the Station ID LED. (The station ID for the first stage unit is 01, the ID for the second stage unit is 02, the ID for the third stage unit is 03, etc.)
  - b) Power on each station on the installation in turn (second station, then third station, etc.). In each case, wait for the station ID to be ascertained and displayed before powering on the next station.
  - c) After all the stations are up, power on the computers.

## Daisy Chain Installation Diagram

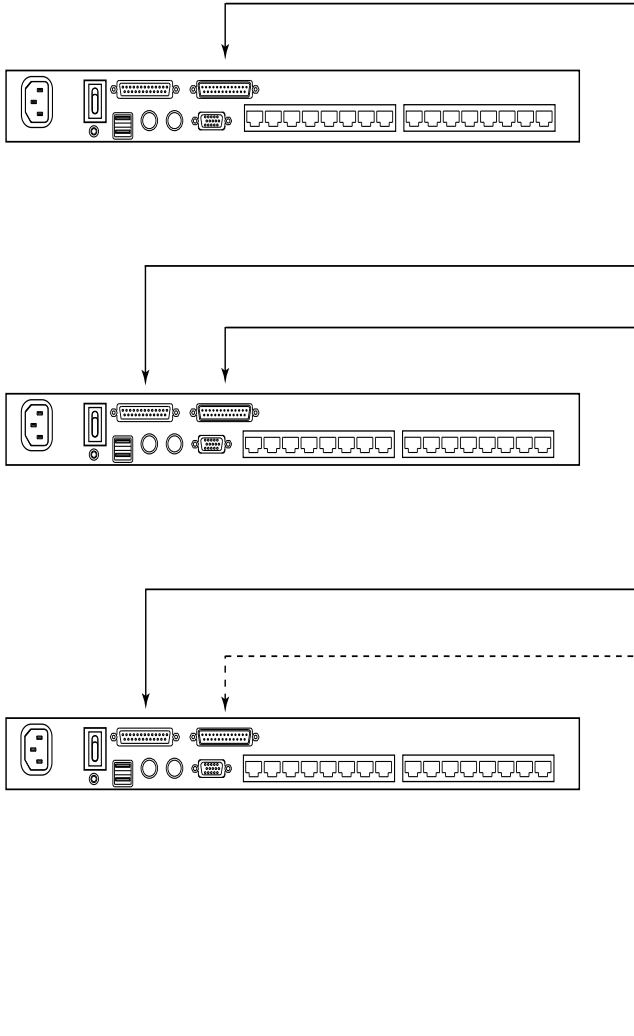

This Page Intentionally Left Blank

# Chapter 3

## Basic Operation

### **Port Selection**

---

KH1508A / KH1516A installations provide three methods to obtain instant access to any computer on your installation: Manual, OSD (on-screen display), and Hotkey.

#### **Manual**

Manual port selection simply involves pressing the port selection switch that corresponds to the device you wish to access.

#### **OSD**

The OSD provides a menu driven interface to the computer switching procedure. OSD operation is discussed in the next chapter.

#### **Hotkey**

Hotkeys allow you to conveniently provide KVM focus to a particular computer from the keyboard instead of having to manually select them by pressing port selection switches, or accessing the OSD. Keyboard operation is discussed in Chapter 5.

## Hot Plugging

---

The KH1508A / KH1516A supports hot plugging – components can be removed and added back into the installation by unplugging and replugging their cables without the need to shut the unit down. In order for hot plugging to work properly, however, the procedures described below should be followed.

### **Hot Plugging Stations**

You can switch station positions by simply unplugging from the old parent and plugging into a new one. After you do, in order for the OSD menus to correspond to the change, you should reset the OSD. See *RESET STATION IDS*, page 34, for details.

### **Hot Plugging KVM Ports**

After switching KVM ports, in order for the OSD menus to correspond to the change, you may need to reconfigure the OSD information for the new port information. The settings of the port name, operating system, and keyboard language will be restored to the KVM switch from any previously used adapter cables after they are plugged in. See *F3: SET*, page 30, and the port setting selections under the *F4 ADM* function, page 33, for details.

- 
- Note:** 1. If a computer's operating system doesn't support hot plugging, this function may not work properly.
2. Empty ports that previously were connected to an adapter cable will retain their prior configuration data.
- 

### **Hot Plugging Console Ports**

The keyboard, monitor, and mouse can be hot plugged. When hot plugging the mouse, however, be aware of the following:

- ♦ If you unplug the mouse (to reset the mouse, for example), you must use the *same* mouse when you plug back in.
- ♦ If you plug in a different mouse, all the stations and all the computers on the installation must be shut down for 10 seconds, then restarted following the sequence given under *Powering Off and Restarting* on page 23.
- ♦ Some older operating systems may not support hot-plugging.

---

**Note:** If, after hot plugging (or at any other time), there is no response to keyboard and/or mouse input, perform a keyboard and mouse reset by pressing in the Reset switch (see page 7).

---



## Powering Off and Restarting

---

If it becomes necessary to power off the KH1508A / KH1516A, or if the switch loses power and needs to be restarted, before starting it back up you should follow these procedures to prevent possible equipment issues:

1. Shut down all the computers that are attached to it.

---

**Note:** You must unplug the power cords of any computers that have the Keyboard Power On function.

---

2. Wait 10 seconds then power it back on. If you have shut down more than one station, power up the highest station first and work your way down to the lowest one. Wait for each station to display its station ID on the front panel LED before powering on the next one.
3. After the station(s) is (are) up, power the computers back on.

## Port ID Numbering

---

Each computer on the installation is assigned a unique port ID. The port ID is a one or two segment number that is determined by the stage level and port number of the switch that the computer is connected to.

The first segment represents the stage level of the switch (04, for example); the second segment represents the number of the port that the computer is plugged into.

For example, if a computer is connected to KVM port 3 of a switch that is in the 12th position of the daisy chain, it would have a port ID of 12-03.

---

**Note:** Single digit numbers (1–9) are padded with a preceding zero (0).

---

This Page Intentionally Left Blank

# Chapter 4

## OSD Operation

### OSD Overview

---

The On Screen Display (OSD) is a menu driven method to handle computer control and switching operations. All procedures start from the OSD Main Screen. To display the Main Screen, tap the OSD hotkey twice.

The default hotkey is [Scroll Lock]. You can change the hotkey to the Ctrl key or the Alt key if you like (see *OSD HOTKEY*, page 30).

- 
- Note:**
1. If you use the Ctrl or Alt key method you must press the same Ctrl or Alt key both times.
  2. Once you start the OSD, the keyboard lock will be controlled by the device. The number lock and caps lock will always be on when the OSD is being accessed.
- 

The OSD incorporates a two level (administrator / user) password system. Before the OSD Main Screen comes up, a login dialog box appears that asks for a username and password. You must provide a valid username and password in order to continue.

If this is the first time that the OSD is being run, or if the password function has not been set, simply press **[Enter]**. The OSD main screen displays in administrator mode. In this mode, you have administrator privileges, with access to all administrator and user functions, and can set up operations (including password authorization) as you like.

After logging in with the default username and password, the OSD Main Screen opens in Administrator mode. In this mode, you have administrator privileges, with access to all administrator and user functions, and can set up operations (including password authorization for the future), as you would like.

When you invoke the OSD, a screen similar to the one below appears:

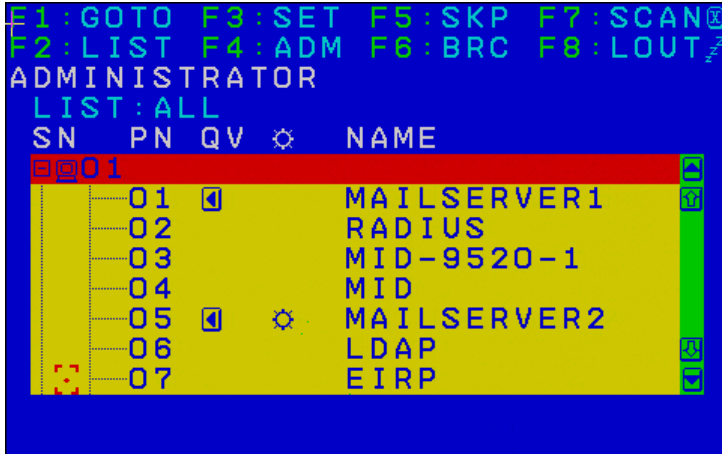

```
F1:GOTO F3:SET F5:SKP F7:SCAN
F2:LIST F4:ADM F6:BRC F8:LOUT
ADMINISTRATOR
LIST:ALL
SN  PN  QV  ☼  NAME
01  ☐  ☐  ☐  MAILSERVER1
02  ☐  ☐  ☐  RADIUS
03  ☐  ☐  ☐  MID-9520-1
04  ☐  ☐  ☐  MID
05  ☐  ☐  ☼  MAILSERVER2
06  ☐  ☐  ☐  LDAP
07  ☐  ☐  ☐  EIRP
```

The screenshot shows a terminal window with a blue background. At the top, function keys F1 through F8 are listed with their corresponding actions: F1:GOTO, F2:LIST, F3:SET, F4:ADM, F5:SKP, F6:BRC, F7:SCAN, and F8:LOUT. Below this, the text 'ADMINISTRATOR' is displayed, followed by 'LIST:ALL'. A table of ports is shown with columns for SN, PN, QV, a gear icon (☼), and NAME. The ports listed are 01 (MAILSERVER1), 02 (RADIUS), 03 (MID-9520-1), 04 (MID), 05 (MAILSERVER2), 06 (LDAP), and 07 (EIRP). Port 05 has a gear icon in the QV column. The table is highlighted in yellow, and there are red and green bars on the left and right sides of the table area.

- 
- Note:** 1. The diagram depicts the Administrator's Main Screen. The User Main Screen does not show the **F4** and **F6** functions, since these are reserved for the administrator and can't be accessed by ordinary users.
2. Only the ports that have been set accessible by the Administrator for the currently logged in user are visible (see *SET ACCESSIBLE PORTS*, page 33, for details).
-

## OSD Navigation

- ◆ To dismiss the menu, and deactivate the OSD, click the **X** at the upper right corner of the OSD Window or press **Esc**.
- ◆ To Logout click **F8** or the **ZZZ** symbol at the top of the Main Screen, or press **[F8]**.
- ◆ The OSD uses a tree view. To see the ports for a particular station, click the plus sign **[ + ]** in front of the station number. The port number list drops down. To dismiss the list, click the circle symbol **[ o ]** in front of the station number.
- ◆ To move up or down through the list one line at a time, click the up and down triangle symbols (**▲▼**) or use the up and down arrow keys. If there are more list entries than there is room for on the Main Screen, the screen will scroll.
- ◆ To move up or down through the list one screen at a time, click the up and down arrow symbols (**↑↓**), or use the **[Pg Up]** and **[Pg Dn]** keys. If there are more list entries than there is room for on the Main Screen, the screen will scroll.
- ◆ To bring the KVM focus to a port, double-click it, or move the highlight bar to it and then press **[Enter]**.
- ◆ After executing any action, you automatically go back to the menu one level above.

## OSD Main Screen Headings

Heading	Explanation
SN-PN	This column lists the port ID numbers (station number-port number) for all the KVM ports on the installation. The simplest method to access a particular computer is to click it, or move the highlight bar to it, and then press <b>[Enter]</b> .
QV	If a port has been selected for Quick View scanning (see <i>SET QUICK VIEW PORTS</i> , page 32), an arrowhead displays in this column.
	The computers that are powered on and are online have a sun symbol in this column.
NAME	If a port has been given a name (see <i>EDIT PORT NAMES</i> , page 34), its name appears in this column.

## OSD Functions

---

OSD functions are used to configure and control the OSD. For example, you can rapidly switch to any port, scan selected ports only, limit the list you wish to view, designate a port as a Quick View Port, create or edit a port name, or make OSD setting adjustments.

To access an OSD function:

1. Either click a function key field at the top of the Main Screen, or press a function key on the keyboard.
2. In the submenus that appear make your choice either by double clicking it, or moving the highlight bar to it, and then pressing **[Enter]**.
3. Press **[Esc]** to return to the previous menu level.

### **F1: GOTO**

Accessing the GOTO function allows you to switch directly to a port either by keying in the port's name or its port ID.

- ♦ To use the Name method, key in **1**, key in the port's name, and then press **[Enter]**.
- ♦ To use the Port ID method, key in **2**, key in the port ID, and then press **[Enter]**.

---

**Note:** You can key in a partial name or port ID. The screen will show all the computers that the user has *View* rights to (see *SET ACCESSIBLE PORTS*, page 33), that match the name or port ID pattern, regardless of the current *List* settings (see *F2: LIST*, page 29, for details).

---

To return to the OSD Main Menu without making a choice, press **[Esc]**.

## **F2: LIST**

Many of the switch's OSD functions only operate on the computers currently selected for listing on the Main Screen. Accessing this function lets you broaden or narrow the scope of ports that get listed. The submenu choices and their meanings are given in the table below:

<b>Choice</b>	<b>Meaning</b>
ALL	Lists all of the ports on the installation.
QUICK VIEW	Lists only the ports that have been selected as Quick View Ports (see <i>SET QUICK VIEW PORTS</i> , page 32).
POWERED ON	Lists only the ports that have attached computers Powered On.
QUICK VIEW + POWERED ON	Lists only the ports that have been selected as Quick View Ports (see <i>SET QUICK VIEW PORTS</i> , page 32), and that have their attached computers Powered On.

Move the highlight bar to the choice you want, then press **[Enter]**. An icon appears before the choice to indicate that it is the currently selected one.

### **F3: SET**

Accessing this function allows the administrator and each user to set up an individual working environment. A separate profile for each operator is stored by the OSD and is activated according to the username provided during login.

To change a setting:

1. Double-click it; or move the highlight bar to it, then press **[Enter]**.
2. After you select an item, a submenu with further choices appears. To make a selection, either double click it; or move the highlight bar to it, then press **[Enter]**. An icon appears before the selected choice to indicate which one it is. The settings are explained in the following table:

<b>Setting</b>	<b>Function</b>
OSD HOTKEY	Selects which hotkey activates the OSD function: [Scroll Lock] [Scroll Lock]; [Ctrl] [Ctrl] or [Alt] [Alt]. Since the [Ctrl] or [Alt] key combinations may conflict with programs running on the computers, the default is the [Scroll Lock] combination.
PORT ID DISPLAY POSITION	Allows you to position where the port ID appears on the monitor. The default is the upper left corner, but you can choose to have it appear anywhere on the screen. Use the mouse or the arrow Keys plus Pg Up, Pg Dn, Home, End, and 5 (on the numeric keypad with Num Lock off), to position the port ID display, then click or press [Enter] to lock the position and return to the Set submenu. <b>Note:</b> The setting affects the currently selected port. If you don't want to use the default position, you must change the setting for each port individually.
PORT ID DISPLAY DURATION	Determines how long a port ID displays on the monitor after a port change has taken place. There are two choices: <b>3 seconds</b> and <b>Off</b> .
PORT ID DISPLAY MODE	Selects how the port ID is displayed: the port number alone ( <b>PORT NUMBER</b> ); the port name alone ( <b>PORT NAME</b> ); or the port number plus the port name ( <b>PORT NUMBER + PORT NAME</b> ). The default is <b>PORT NUMBER + PORT NAME</b> .
SCAN DURATION	Determines how long the focus dwells on each port as it cycles through the selected ports in Auto Scan mode (see <i>F7: SCAN</i> , page 38). Key in a value from 1–255 seconds, then press <b>[Enter]</b> . Default is 5 seconds; a setting of 0 disables the Scan function.



Setting	Function
SCAN/SKIP MODE	<p>Selects which computers will be accessed under Skip mode (see <i>F5: SKP</i>, page 36), and Auto Scan mode (see <i>F7: SCAN</i>, page 38). Choices are:</p> <p><b>ALL</b> – All the ports which have been set Accessible (see <i>SET ACCESSIBLE PORTS</i>, page 33);</p> <p><b>QUICK VIEW</b> – Only those ports which have been set Accessible and have been selected as Quick View Ports (see <i>SET QUICK VIEW PORTS</i>, page 32);</p> <p><b>POWERED ON</b> – Only those ports which have been set Accessible and are Powered On;</p> <p><b>QUICK VIEW + POWERED ON</b> – Only those ports which have been set Accessible and have been selected as Quick View Ports and are Powered On. The default is ALL.</p>
SCREEN BLANKER	<p>If there is no input from the console for the amount of time set with this function, the screen is blanked. Key in a value from 1–30 minutes, then press <b>[Enter]</b>. A setting of 0 disables this function. The default is Off.</p>
HOTKEY COMMAND MODE	<p>Enables / Disables the Hotkey function (see <i>Hotkey Operation</i>, page 41), in case a conflict with programs running on the computers occurs. The default is On.</p>
HOTKEY	<p>This setting selects the Hotkey invocation keys (see <i>Hotkey Operation</i>, page 41). Choices are <b>[NUM LOCK] + [-]</b>, or <b>[CTRL] + [F12]</b>. The default is <b>[NUM LOCK] + [-]</b>.</p>
SET OSD LANGUAGE	<p>Sets the language that the OSD displays in. Choices are: English, German, Japanese, Simplified Chinese and Traditional Chinese. The default is English.</p>
SET CONSOLE KEYBOARD	<p>Sets the keyboard language mapping of the console keyboard. The default is Auto. If the switch does not automatically receive language mapping from the keyboard, it will set to English (US).</p>
SET LOGOUT TIMEOUT	<p>If there is no input from the console for the amount of time set with this function, the operator is automatically logged out. A login is necessary before the console can be used again.</p> <p>This enables other operators to gain access to the computers when the original operator is no longer accessing them, but has forgotten to log out. To set the timeout value, key in a number from 1–180 minutes, then press <b>[Enter]</b>. If the number is 0 (zero), this function is disabled. Default is Off.</p> <p><b>Note:</b> This feature does not function if Set Login Mode is disabled. See <i>SET LOGIN MODE</i>, page 35.</p>
ACTIVATE BEEPER	<p>Choices are <b>Y</b> (for Yes), or <b>N</b> (for No). When activated, the beeper sounds whenever a port is changed, when activating the Auto Scan function (see <i>F7: SCAN</i>, page 38), or an invalid entry is made on an OSD menu. The default is On.</p>

Setting	Function
SET QUICK VIEW PORTS	<p>This function lets the administrator select which ports to include as Quick View ports.</p> <ul style="list-style-type: none"> <li>◆ To select/deselect a port as a Quick View Port, use the navigation keys to move the highlight bar to it, then press the [Spacebar].</li> <li>◆ When a port has been selected as a Quick View Port, an arrowhead displays in the QV column of the LIST on the Main Screen to indicate so. When a port is deselected, the arrowhead disappears.</li> <li>◆ If one of the Quick View options is chosen for the LIST view (see <i>F2: LIST</i>, page 29), only a port that has been selected here will display on the List.</li> <li>◆ If one of the Quick View options is chosen for Auto Scanning (see <i>SCAN/SKIP MODE</i>, page 31), only a port that has been selected here will be Auto Scanned.</li> </ul> <p>The default is for no ports to be selected.</p>
PREFERRED RESOLUTION	<p>This function allows you to set a preferred resolution that the switch will send to the KVM adapter cables. The KVM adapter cables provide the connected computer's video card with EDID information about the monitor connected to the switch. This affects the video quality displaying on the console monitor. Choices are:</p> <ul style="list-style-type: none"> <li>◆ <b>MONITOR DEFAULT SETTING</b> – Sends the EDID information provided by the display connected to the console port – directly to the KVM adapter cable.</li> <li>◆ <b>Alternative Resolution</b> – Sends an alternative resolution (EDID information) to the KVM adapter cables. Select a resolution that best suits the video display on the monitor connected to the console port.</li> </ul> <p><b>Note:</b> We strongly recommend using the Monitor Default Setting. Only use an alternative resolution if the video quality on the console monitor isn't displaying properly.</p>

## F4: ADM

F4 is an administrator only function. Accessing this function allows the administrator to configure and control the overall operation of the OSD. To change a setting double click it; or use the up and down arrow keys to move the highlight bar to it, then press **[Enter]**.

After you select an item, a submenu with further choices appears. Double click the choice you want, or move the highlight bar to it, then press **[Enter]**. An icon appears before the selected choice. The settings are explained in the table on the next three pages:

Setting	Function
SET USER ACCOUNT	<p>This function is used to set usernames and passwords for the administrator and users:</p> <ul style="list-style-type: none"> <li>◆ One Administrator and 10 user passwords can be set.</li> <li>◆ After you select the administrator field or one of the user fields, a screen that allows you to key in your username and password appears. The username and password may be up to 16 characters long, and can consist of any combination of letters and numbers (A-Z, 0-9).</li> <li>◆ For each individual, key in the username and password, then press <b>[Enter]</b>.</li> <li>◆ To modify or delete a previous username and/or password, use the backspace key to erase individual letters or numbers.</li> <li>◆ The  icon indicates data is stored in the account.</li> </ul>
SET ACCESSIBLE PORTS	<p>This function allows the administrator to define user access to the computers on the installation on a port-by-port basis.</p> <p>For each user, select the target port, then press the [Spacebar] to cycle through the choices: <b>F</b> (Full access), <b>V</b> (View Only), or <b>N</b> (No Access). Repeat until all access rights have been set, then press [Esc]. The default is <b>F</b> for all users on all ports.</p> <p><b>Note:</b> An <b>N</b> setting means that no access rights are granted. The port will not show up on the user's LIST on the Main Screen.</p>

Setting	Function
EDIT PORT NAMES	<p>To identify which computer is attached to a particular port, every port can be assigned a name. This function allows the administrator to create, modify, or delete port names. To assign a port name:</p> <ol style="list-style-type: none"> <li>1. Click the port you want, or use the navigation keys to move the highlight bar to it, then press <b>[Enter]</b>.</li> <li>2. Key in the new port name, or modify/delete the old one. The maximum number of characters allowed for the port name is 14. Legal characters include: <ul style="list-style-type: none"> <li>◆ All alpha characters: <b>A–Z*</b></li> <li>◆ All numeric characters: <b>0–9</b></li> </ul> <p>*You can enter the port names in either upper or lower case however the OSD displays the port name only in UPPERCASE.</p> </li> <li>3. When you have finished editing, press <b>[Enter]</b> to have the change take effect. To abort the change, press <b>[Esc]</b>.</li> </ol>
RESTORE DEFAULT VALUES	<p>This function is used to undo all changes and return the setup to the original factory default settings (see <i>OSD Factory Default Settings</i>, page 69) – except for the <i>Names</i> settings that were assigned to the ports, which are saved.</p>
CLEAR THE NAME LIST	<p>This function clears the port name list.</p>
RESET STATION IDS	<p>If you change the position of one of the stations in the daisy chain, the OSD settings will no longer correspond to the new situation. This function directs the OSD to rescan the station positions of the entire installation and updates the OSD so that the OSD station information corresponds to the new physical layout.</p> <p><b>Note:</b> Only the station numbers get updated. Except for the port names, all administrator settings (such as Set Accessible Ports, Set Quick View Ports, etc.), for all of the computers affected by the change, have to be manually redone.</p>
SET OPERATING SYSTEM	<p>Specifies the operating platform of the computer attached to each port. You must configure each port on the installation. For each port, press the [Spacebar] to cycle through the choices (PC, Mac or Sun). Repeat until all the ports have been set, then press [Esc]. The default is PC.</p> <p><b>Note:</b> If you are installing a Sun or Mac computer it may not boot when you run it for the first time unless you first set the correct operating system for the port it is connected to.</p>
SET CAT 5 LENGTH	<p>Lets you specify how long the Cat 5e/6 cable between the port and the KVM adapter cable is. Press <b>[Spacebar]</b> to cycle through the cable length settings:</p> <ul style="list-style-type: none"> <li><b>S:</b> Short – for up to 25 m</li> <li><b>M:</b> Medium – for between 20 and 35 m</li> <li><b>L:</b> Long – for above 35 m</li> </ul> <p>An S, M, or L appears next to the port to indicate the choice.</p>

Setting	Function
SET KEYBOARD LANGUAGE	Sets the keyboard language layout for the computers attached to each port. Press <b>[Spacebar]</b> to cycle through the choices: The default is English (US).
FIRMWARE UPGRADE	In order to upgrade the KH1508A / KH1516A and adapter cable firmware (see <i>The Firmware Upgrade Utility</i> , page 53) you must first enable <i>Firmware Upgrade</i> mode with this setting. When you bring up this menu, the current firmware version levels display. Select <b>Y</b> to enable Firmware Upgrade mode, or <b>N</b> to leave this menu without enabling it.
ADAPTER UPGRADE	This function allows the administrator to check the firmware version of the KVM adapter cable. When you bring up this menu, the current firmware version levels display. See <i>FIRMWARE UPGRADE</i> , above, also.
SET LOGIN MODE	This function allows the administrator to request users to login or not. When the login dialog box is disabled, the system disables the login/logout function. If the system is re-started, the login/logout function remains disabled.

## **F5: SKP**

This function enables you to easily skip backward or forward, switching the console focus from the currently active KVM Port to the previous or next available one.

- ◆ The selection of computers to be available for Skip mode switching is made with the *Scan/Skip* mode setting under the **F3 SET** function (see page 31).
- ◆ When you are in Skip mode, press:
  - ← To skip to the previous port in the List.
  - To skip to the next port in the List.
  - ↑ To skip to the last port of the previous station in the List.
  - ↓ To skip to the first port of the next station in the List.

---

**Note:** When you skip, you only skip to the previous or next available computer that is in the *Scan/Skip* mode selection (see page 31).

---

- ◆ If a port has been selected for *Scan/Skip* mode, when the focus switches to that port a left/right triangle symbol appears before its port ID display.
- ◆ While Skip mode is in effect, the console will not function normally. You must exit Skip mode in order to regain control of the console.
- ◆ To exit Skip mode, press the [Spacebar] or [Esc].

## **F6: BRC**

F6 is an administrator only function. When this function is in effect, commands sent from the console are broadcast to all available computers on the installation.

This function is particularly useful for operations that need to be performed on multiple computers, such as performing a system wide shutdown, installing or upgrading software, etc.

- ◆ While BRC mode is in effect, a speaker symbol appears before the port ID display of the port that currently has the console focus.
- ◆ While BRC mode is in effect, the mouse will not function normally. You must exit BRC mode in order to regain control of the mouse.
- ◆ To exit BRC mode, invoke the OSD (with the OSD Hotkey), then click the **F6** field, or press [F6], to turn BRC mode off.

## **F7: SCAN**

This function automatically switches among the available computers at regular intervals so that you can monitor their activity without having to take the trouble of switching manually.

- ◆ The selection of computers to be included for Auto Scanning is made with the *Scan/Skip* mode setting under the **F3 SET** function (see page 31).
- ◆ The amount of time that each port displays for is set with the *Scan Duration* setting under the **F3 SET** function (see page 30).
- ◆ As each computer is accessed, an **S** appears in front of the port ID display to indicate that it is being accessed under *Auto Scan* mode.
- ◆ While you are in Auto Scan mode, you can pause the scanning in order to keep the focus on a particular computer either by pressing **P**, or with a left click of the mouse. To resume scanning, press any key or left click again. See *Auto Scan Mode Switching*, page 44, for details.
- ◆ While Auto Scan mode is in effect, the console will not function normally. You must exit Auto Scan mode in order to regain control of the console.
- ◆ To exit Auto Scan mode, press the [Spacebar] or [Esc].



## **F8: LOUT**

Clicking the **F8** field, or pressing [**F8**], logs you out of the OSD and blanks the console screen. This is different from simply deactivating the OSD when you are at the Main Screen by pressing [Esc].

With this function you must log in all over again to regain access to the OSD, whereas with [Esc], all you have to do to reenter the OSD is tap the OSD Hotkey.

- 
- Note:**
1. When you reenter the OSD after logging out, the screen stays blank except for the login dialog box. You must input your username and password before you can continue (see page 25). If login has been disabled by the administrator (see page 35), the F8 function is also disabled.
  2. If you reenter the OSD after logging out, and immediately use [Esc] to deactivate the OSD without having selected a port from the OSD menu, a Null Port message displays on the screen. The OSD hotkey will bring up the OSD Main Screen.
-

This Page Intentionally Left Blank

# Chapter 5

## Hotkey Operation

### Hotkey Port Control

---

Hotkey port control allows you to provide KVM focus to a particular computer directly from the keyboard. The KH1508A / KH1516A provides the following Hotkey port control features:

- ◆ Selecting the Active Port
- ◆ Auto Scan Mode Switching
- ◆ Skip Mode Switching
- ◆ Computer Keyboard / Mouse Reset

The following settings can also be controlled in *Hotkey* mode:

- ◆ Setting the Beeper
- ◆ Setting the Quick Hotkey
- ◆ Setting the OSD Hotkey
- ◆ Setting the Port Operating System
- ◆ Restoring the OSD Default Values

## Invoking Hotkey Mode

---

All Hotkey operations begin by invoking *Hotkey* mode.<sup>1</sup> To invoke *Hotkey* mode you may use two possible keystroke sequences shown below. Only one of the two key-sequences below can be operational (see *Setting the Hotkey key combination* on page 48):

### Number Lock and Minus Keys

1. Hold down the **[Num Lock]** key;
2. Press and release the **[Minus]** key;
3. Release the **[Num Lock]** key:

**[Num Lock] + [-]**

### Control and F12 Keys

1. Hold down the **[Ctrl1]** key;
2. Press and release the **[F12]** key;
3. Release the **[Ctrl1]** key:

**[Ctrl1] + [F12]**

### Hotkey Mode Environment

When *Hotkey* mode is active:

- ♦ A command line appears on the monitor screen. The command line prompt is the word *Hotkey:* in white text on a blue background, and displays the subsequent Hotkey information that you key in.
- ♦ Ordinary keyboard and mouse functions are suspended – only Hotkey compliant keystrokes (described in the sections that follow), can be input.

### Exiting Hotkey Mode

Pressing **[Esc]** exits Hotkey mode.

---

1. Make sure that the *Hotkey Command Mode* function is enabled and that you key in the appropriate *Hotkey*. See page 31 for details.

## Selecting the Active Port

---

Each computer port is assigned a port ID (see *Port ID Numbering*, page 23). You can directly access any computer with a Hotkey combination that specifies the port ID that the computer is connected to. The steps are:

1. Invoke Hotkey mode:

**[Num Lock] + [-] or [Ctrl] + [F12]**

2. Key in the port ID.

The port ID numbers display on the command line as you key them in. If you make a mistake, use **[Backspace]** to erase it.

3. Press **[Enter]**.

After you press [Enter], the KVM focus switches to the designated computer and you automatically exit Hotkey mode.

---

**Note:** In Hotkey mode, the KVM focus will not switch to a port if an invalid switch or port number is entered. The Hotkey command line will continue to display on the screen until you enter a valid switch and port number combination, or exit Hotkey mode.

---

## Auto Scan Mode Switching

---

Auto Scan automatically switches among all the active computer ports that are accessible to the currently logged on user at regular intervals. This allows their activity to be monitored automatically (See *SKAN/SKIP MODE* of the OSD F3 SET function, page 31).

### Setting the Scan Interval

The amount of time Auto Scan keeps the focus on each port is set with the *SCANDURATION* setting of the OSD **F3 SET** function (see page 30). You can change the scan interval, before you activate Hotkey Auto Scanning, by entering the following Hotkey combination:

1. Invoke Hotkey mode:

**[Num Lock] + [-] or [Ctrl] + [F12]**

2. Key in **[A] [n]**

Where **[A]** is the letter **A**, and **[n]** is a number from 1–255 that represents the length of the focus time in seconds.

The letter **A** and the numbers display on the command line as you key them in. Use **[Backspace]** to erase any wrong entry.

3. Press **[Enter]**

After you press [Enter], you exit Hotkey mode, and are ready to start Auto Scanning.

### Invoking Auto Scan

To invoke Auto Scanning mode, key in the following Hotkey combination:

1. Invoke Hotkey mode:

**[Num Lock] + [-] or [Ctrl] + [F12]**

2. Press **[A] + [Enter]**.

- ♦ While you are in Auto Scan mode, you can pause the scanning to keep the focus on a particular computer by pressing **[P]**. When Auto Scanning is paused, the Command Line displays: **Auto Scan: Paused.**

*(Continues on next page.)*

*(Continued from previous page.)*

When you want to keep the focus on a particular computer, *Pausing* is more convenient than exiting Auto Scan mode. When you resume scanning it starts at the computer where you paused. If you exited and then restarted Auto Scanning, it starts, at the beginning, from the first computer on the installation.

To resume Auto Scanning, press any key. Scanning continues from the computer you paused at.

- ◆ While the Auto Scan mode is operating, ordinary keyboard and mouse functions are suspended - only Auto Scan mode compliant keystrokes can be input. You must exit Auto Scan mode to regain normal control of the console.

### **Exiting Auto Scan**

1. To exit Auto Scan mode press **[Esc]** or **[Spacebar]**. Auto Scanning stops when you exit Auto Scan mode.

## Skip Mode Switching

---

This feature allows you to switch between computers in order to monitor them manually. You can focus on a particular port for as long as you like – as opposed to auto-scanning, which automatically switches the port focus after a fixed interval.

### Entering Skip Mode

To enter *Skip* mode, key in the following Hotkey combination:

1. Invoke Hotkey mode:  
**[Num Lock] + [-] or [Ctrl] + [F12]**
2. Press one of the **[Arrow]** keys.

After you press one of the keyboard arrows, you automatically exit Hotkey mode and enter *Skip* mode where you can switch ports as follows:

←	Skips to the first accessible port. (See <i>SCAN/SKIP MODE</i> , page 31, for information regarding accessible ports.)
→	Skips to the next accessible port.
↑	Skips to the last accessible port of the previous station.
↓	Skips to the first accessible port of the next station.

Once you are in *Skip* mode, you can continue skipping by pressing the arrow keys. You do not have to use the [Num Lock] + [-] combination again.

While *Skip* mode is in effect, ordinary keyboard and mouse functions are suspended – only *Skip* mode compliant keystrokes can be input. You must exit *Skip* mode to regain normal control of the console.

### Exiting Skip Mode

1. To exit *Skip* mode, press [Esc] or [Spacebar] .



## Computer Keyboard / Mouse Reset

---

If either the keyboard or mouse stop functioning on the computer connected to the currently selected port, you can perform a keyboard / mouse reset on the computer by executing the following steps:

1. Invoke Hotkey mode:

**[Num Lock] + [-] or [Ctrl] + [F12]**

2. Press **[F5]**.

After you press [F5] you automatically exit *Hotkey* mode and regain keyboard and mouse control on the computer connected to the KVM port. If you fail to regain keyboard / mouse control on the computer after pressing [F5], perform a system reset. For more information see *Reset Switch*, page 7.

This function is essentially the same as unplugging and replugging the keyboard and mouse on the target computer.

## Setting the Hotkey Beeper ON/OFF

---

The beeper (see Activate Beeper, page 31) can be turned on and off with Hotkeys by the following steps:

1. Invoke Hotkey mode:

**[Num Lock] + [-] or [Ctrl] + [F12]**

2. Press **[B]**.

After you press **[B]**, the beeper turns on or off. The command line displays *Beeper On* or *Beeper Off* for one second; then the message disappears and you automatically exit Hotkey mode.

## Setting the Hotkey key combination

---

The keys used to enter the *Hotkey Mode* (see *HOTKEY COMMAND MODE*, page 31) can be switched between:

**[Num Lock] + [-]**, and **[Ctrl] + [F12]**

by the following steps:

1. Invoke Hotkey mode:

**[Num Lock] + [-]** or **[Ctrl] + [F12]**

2. Press **[H]**.

After you press **[H]**, the command line displays *HOTKEY HAS BEEN CHANGED* for one second; then the message disappears and you automatically exit *Hotkey mode*.

## Setting the OSD Hotkey combination

---

The *Hotkeys* used to access the *OSD* (see *OSD HOTKEY*, page 30) can be switched between **[Scroll Lock]**, **[Scroll Lock]**, **[Ctrl]**, **[Ctrl]**, and **[Alt]**, **[Alt]** by the following steps:

1. Invoke Hotkey mode:

**[Num Lock] + [-]** or **[Ctrl] + [F12]**

2. Press **[T]**.

After you press **[T]**, the command line displays *HOTKEY HAS BEEN CHANGED* for one second; then the message disappears and you automatically exit *Hotkey mode*.

## Setting the Port Operating System

---

A port's operating system configuration can be matched to that of the computer attached to the port by performing the following steps:

1. Invoke Hotkey mode:  
**[Num Lock] + [-] or [Ctrl] + [F12]**
2. Press a **[Function]** key, where **[Function]** refers to one of the function keys in the following table:

Key	Description
<b>F1</b>	Sets the Port OS to Windows
<b>F2</b>	Sets the Port OS to Mac
<b>F3</b>	Sets the Port OS to Sun

After pressing a function key you automatically exit *Hotkey* mode.

## Restore the Default Values

---

This administrator-only Hotkey restores the KH1508A / KH1516A default values (see *RESTORE DEFAULT VALUES* on page 34) by performing the following steps:

1. Invoke Hotkey mode:  
**[Num Lock] + [-] or [Ctrl] + [F12]**
2. Press **[R]**.
3. Press **[Enter]**.

After you press **[Enter]**, the command line displays *RESET TO DEFAULT SETTING* for three seconds; then the message disappears and you automatically exit *Hotkey* mode.

## Hotkey Summary Table

[Num Lock] + [-] or [Ctrl] + [F12]	[A] [Enter]	Invokes <i>Auto Scan</i> mode. When <i>Auto Scan</i> mode is in effect, [P] or left-click pauses auto-scanning. When auto-scanning is paused, pressing any key or another left-click resumes auto-scanning.
	[B]	Toggles the Beeper On or Off.
	[Esc] or [Spacebar]	Exits hotkey mode.
	[F1]	Sets Operating System to Windows
	[F2]	Sets Operating System to Mac
	[F3]	Sets Operating System to Sun
	[F5]	Performs a keyboard / mouse reset on the target computer.
	[H]	Toggles the Hotkey invocation keys.
	[Port ID] [Enter]	Switches access to the computer that corresponds to that Port ID.
	[R] [Enter]	Administrator only hotkey. It returns the switch's settings to their default values.
	[T]	Toggles the <i>OSD Hotkey</i> between [Ctrl] [Ctrl] and [Scroll Lock] [Scroll Lock].
	[←]	Invokes Skip Mode and skips from the current port to the first accessible port previous to it.
	[→]	Invokes Skip Mode and skips from the current port to the next accessible port.
	[↑]	Invokes Skip Mode and skips from the current port to the last accessible port of the previous Station.
	[↓]	Invokes Skip Mode and skips from the current port to the first accessible port of the next Station.









# Chapter 6

## Keyboard Emulation

### Mac Keyboard

---

The PC compatible (101/104 key) keyboard can emulate the functions of the Mac keyboard. The emulation mappings are listed in the table below.

PC Keyboard	Mac Keyboard
[Shift]	Shift
[Ctrl]	Ctrl
	
[Ctrl] [1]	
[Ctrl] [2]	
[Ctrl] [3]	
[Ctrl] [4]	
[Alt]	Alt
[Print Screen]	F13
[Scroll Lock]	F14
	=
[Enter]	Return
[Backspace]	Delete
[Insert]	Help
[Ctrl] 	F15







---

**Note:** When using key combinations, press and release the first key (Ctrl), then press and release the activation key.

---

## Sun Keyboard

The PC compatible (101/104 key) keyboard can emulate the functions of the Sun keyboard when the Control key [Ctrl] is used in conjunction with other keys. The corresponding functions are shown in the table below.

PC Keyboard	Sun Keyboard
[Ctrl] [T]	Stop
[Ctrl] [F2]	Again
[Ctrl] [F3]	Props
[Ctrl] [F4]	Undo
[Ctrl] [F5]	Front
[Ctrl] [F6]	Copy
[Ctrl] [F7]	Open
[Ctrl] [F8]	Paste
[Ctrl] [F9]	Find
[Ctrl] [F10]	Cut
[Ctrl] [1]	
[Ctrl] [2]	
[Ctrl] [3]	
[Ctrl] [4]	
[Ctrl] [H]	Help
	Compose
	

**Note:** When using key combinations, press and release the first key (Ctrl), then press and release the activation key.

# Chapter 7

## The Firmware Upgrade Utility

### Introduction

---

The purpose of the Windows-based Firmware Upgrade Utility is to provide an automated process for upgrading the KH1508A / KH1516A and compatible adapter cable firmware. The program comes as part of a Firmware Upgrade Package that is specific for each device.

The latest revisions of new firmware for the KH1508A / KH1516A, and supported KVM Adapter Cables are posted as Firmware Upgrade Packages on our web site. Check the website regularly to find the latest firmware packages and information relating to them.

- 
- Note:**
1. A single upgrade package contains the upgrade files for the Main Board and all the supported KVM Adapter Cables.
  2. KVM Adapter Cables are referred to as *I/O Modules* in some dialog boxes.
- 

### Before You Begin

To prepare for the firmware upgrade, do the following:

1. From a computer that is not part of your KVM installation go to the ATEN Internet support site and choose the model name that relates to your device to get a list of available Firmware Upgrade Packages.
2. Choose the Firmware Upgrade Package you want to install (usually the most recent), and download it to your computer.

*(Continues on next page.)*

(Continued from previous page.)

- Use the firmware upgrade cable (provided with this unit), to connect a COM port on your computer to the firmware upgrade port of your device.

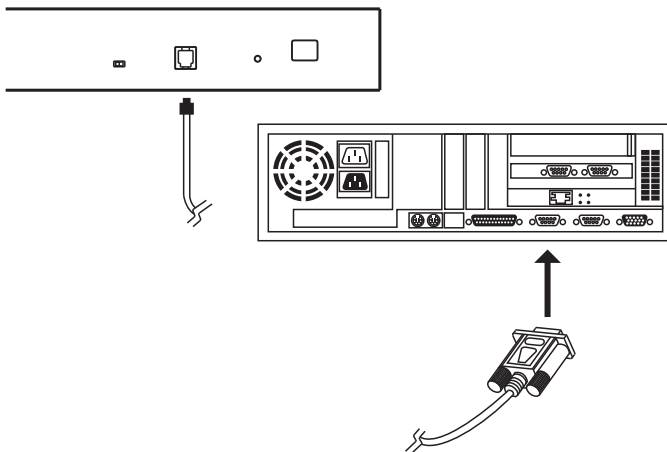

---

**Note:** On a daisy chained installation, connect the cable to the first station (master) unit. The chained stations (slaves) that are the same model will receive the upgrade via the daisy chain cables.

---

- Shut down all of the computers except those that are attached to cable adapters that require upgrade. The cable adapters require the computers power source to be upgraded. Do not shut down the stations on the KVM installation that you want to upgrade.
- From your KVM switch console, bring up the OSD (see page 25) and select the **F4ADM** function.
- Scroll down to FIRMWARE UPGRADE. Press **[Enter]**, then press **[Y]** to start the Firmware Upgrade mode (see page 35).

---

**Note:** 1. The upgrade to the KVM Adapter Cables takes place via the Cat 5e/6 cable that connects the adapter cable to the KVM switch, so there is no separate firmware upgrade cable to attach.

2. Adapter cable firmware selected with the upgrade utility will upgrade in a single session all connected adapter cable models that match the firmware type.

---



## Performing the Upgrade

### Starting the Upgrade

To upgrade your firmware:

1. Run the downloaded Firmware Upgrade Package file, either by double clicking the file icon, or by opening a command line and keying in the full path to it.

The Firmware Upgrade Utility *Welcome* screen appears:

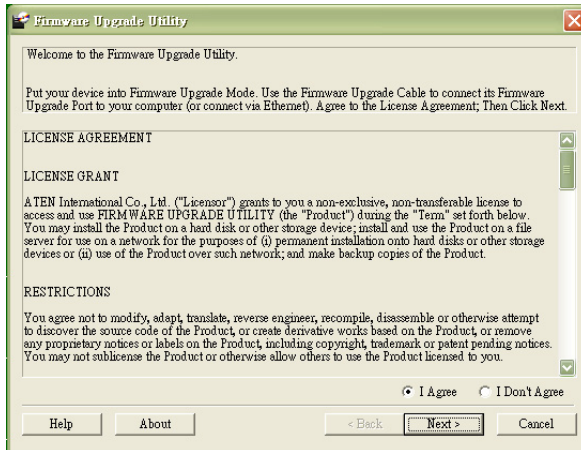

2. Read and *Agree* to the License Agreement (enable the I Agree radio button).

*(Continues on next page.)*

(Continued from previous page.)

3. Click **Next** to continue. The Firmware Upgrade Utility main screen appears:

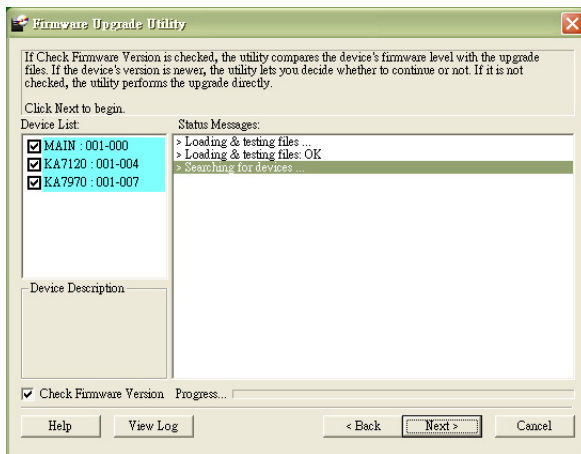

The Utility checks to make sure the KH1508A / KH1516A is in the Firmware Upgrade Mode and then lists all firmware needed preselected in the *Device List* panel.

- 
- Note:**
1. The Device List lists all the models of KVM Adapter Cable that require upgrading.
  2. If the Utility fails to list any firmware check that the KH1508A / KH1516A is connected and in the Firmware Upgrade Mode. Alternatively the Firmware Package maybe corrupted or the wrong version therefore obtain a new copy of the file and retry.
-

4. Select MAIN to upgrade the firmware for the Main Board. Deselect any KVM Adapter Cable types that are not required to be upgraded. After you have made your selection(s), click **Next** to perform the upgrade.

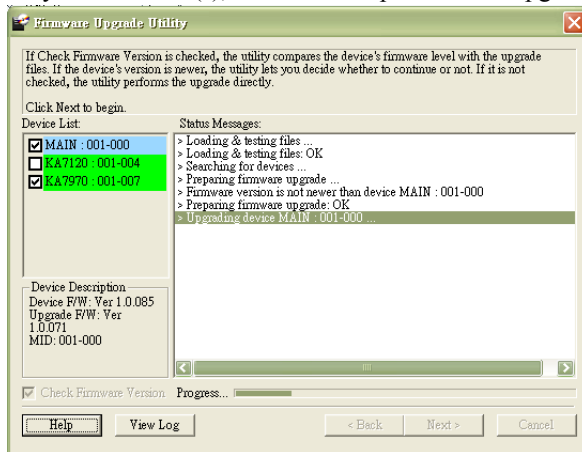

- ◆ *Check Firmware Version* - when selected the utility compares the Main Board firmware level with the upgrade files MAIN. If the device versions are higher than the upgrade versions a dialog box informs you and gives you the option to continue or cancel.

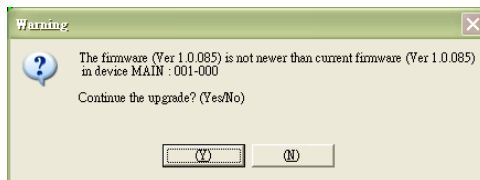

If you didn't enable *Check Firmware Version*, the utility installs the upgrade files without checking whether they are a higher level, or not.

- ◆ As the upgrade proceeds status messages appear in the *Status Messages* panel, and the progress toward completion is shown on the *Progress* bar.
- ◆ To abort the upgrade procedure before it completes, click **Cancel**.

If you cancel before completion, a dialog box warns you that the upgrade will not finish and shows the options to proceed or abort the cancel operation. The Mainboard and OSD firmware may be missing or corrupted upon rebooting the switch.

To recover from missing or corrupt firmware, see *Firmware Upgrade Recovery*, page 59.

## Upgrade Succeeded

After the upgrade has completed, a screen appears to inform you that the procedure was successful:

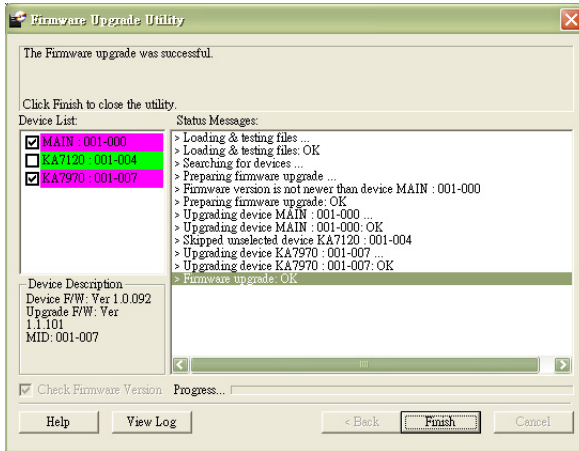

Click **Finish** to close the Firmware Upgrade Utility.

---

**Note:** At the completion of the upgrade, the KH1508A / KH1516A restarts.

---

## Upgrade Failed

If the upgrade failed to complete successfully a dialog box appears asking if you want to retry. Click **Yes** to retry. If you click **No**, the *Upgrade Failed* screen appears.

Click **Cancel** to close the Firmware Upgrade Utility. See the next section, *Firmware Upgrade Recovery*, for how to proceed.

## Firmware Upgrade Recovery

Should the firmware on the switch be missing or corrupted it may not be possible to operate or boot the switch. This could be due to:

- ◆ Starting the Firmware Upgrade mode (see *FIRMWARE UPGRADE*, page 35), and then canceling the upgrade.
- ◆ An interruption of the firmware upgrade.
- ◆ The firmware upgrade procedure failing.
- ◆ The unit's firmware becoming corrupted for unknown reasons.

## Main Board Firmware Upgrade Recovery

To perform a firmware upgrade recovery, do the following:

1. On the KVM Switch slide the *Firmware Upgrade Recovery Switch* (see page 7) to the **Recover** position.
2. Power off and restart the switch according to the instructions given in the *Powering Off and Restarting* section (see page 23).
3. Proceed with the firmware upgrade as described in *Performing the Upgrade*, starting on page 55.
4. When the upgrade ends, power off the switch
5. Slide the *Firmware Upgrade Recovery Switch* back to the **Normal** position.
6. Power on the switch.

---

**Note:** If one of the child KVM units fails to upgrade successfully, unchain it from the installation and perform the recovery and upgrade operation on it independently. After it has been successfully upgraded, plug it back into the chain

---

## Adapter Cable Firmware Upgrade Recovery

To perform an adapter cable firmware upgrade recovery, do the following:

1. Unplug the adapter cable from the computer it is connected to.
2. Slide its *Firmware Upgrade Recovery Switch* (located next to the RJ45 connector) to the **Recover** position.
3. Plug the adapter cable back into the computer.
4. From your KVM switch console, bring up the OSD (see page 26) and select the **F4ADM** function.
5. Scroll down to *FIRMWARE UPGRADE*. Press **[Enter]**.
6. Press **[Y]** to invoke Upgrade mode.
7. Proceed with the firmware upgrade as described in *Performing the Upgrade*, starting on page 55.
8. After the upgrade completes and the switch restarts, unplug the adapter cable from the computer and slide the *Firmware Upgrade Recovery Switch* back to the **Normal** position.
9. Plug the adapter cable back into the computer.

## Safety Instructions

---

### General

- ◆ This product is for indoor use only.
- ◆ Read all of these instructions. Save them for future reference.
- ◆ Follow all warnings and instructions marked on the device.
- ◆ Do not place the device on any unstable surface (cart, stand, table, etc.). If the device falls, serious damage will result.
- ◆ Do not use the device near water.
- ◆ Do not place the device near, or over, radiators or heat registers.
- ◆ The device cabinet is provided with slots and openings to allow for adequate ventilation. To ensure reliable operation, and to protect against overheating, these openings must never be blocked or covered.
- ◆ The device should never be placed on a soft surface (bed, sofa, rug, etc.) as this will block its ventilation openings. Likewise, the device should not be placed in a built in enclosure unless adequate ventilation has been provided.
- ◆ Never spill liquid of any kind on the device.
- ◆ Unplug the device from the wall outlet before cleaning. Do not use liquid or aerosol cleaners. Use a damp cloth for cleaning.
- ◆ The device should be operated from the type of power source indicated on the marking label. If you are not sure of the type of power available, consult your dealer or local power company.
- ◆ The device is designed for IT power distribution systems with 230V phase-to-phase voltage.
- ◆ To prevent damage to your installation it is important that all devices are properly grounded.
- ◆ The device is equipped with a 3-wire grounding type plug. This is a safety feature. If you are unable to insert the plug into the outlet, contact your electrician to replace your obsolete outlet. Do not attempt to defeat the purpose of the grounding-type plug. Always follow your local/national wiring codes.

- ◆ Do not allow anything to rest on the power cord or cables. Route the power cord and cables so that they cannot be stepped on or tripped over.
- ◆ If an extension cord is used with this device make sure that the total of the ampere ratings of all products used on this cord does not exceed the extension cord ampere rating. Make sure that the total of all products plugged into the wall outlet does not exceed 15 amperes.
- ◆ To help protect your system from sudden, transient increases and decreases in electrical power, use a surge suppressor, line conditioner, or uninterruptible power supply (UPS).
- ◆ Position system cables and power cables carefully; Be sure that nothing rests on any cables.
- ◆ Never push objects of any kind into or through cabinet slots. They may touch dangerous voltage points or short out parts resulting in a risk of fire or electrical shock.
- ◆ Do not attempt to service the device yourself. Refer all servicing to qualified service personnel.
- ◆ If the following conditions occur, unplug the device from the wall outlet and bring it to qualified service personnel for repair.
  - ◆ The power cord or plug has become damaged or frayed.
  - ◆ Liquid has been spilled into the device.
  - ◆ The device has been exposed to rain or water.
  - ◆ The device has been dropped, or the cabinet has been damaged.
  - ◆ The device exhibits a distinct change in performance, indicating a need for service.
  - ◆ The device does not operate normally when the operating instructions are followed.
- ◆ Only adjust those controls that are covered in the operating instructions. Improper adjustment of other controls may result in damage that will require extensive work by a qualified technician to repair.
- ◆ Do not connect the RJ-11 connector marked “UPGRADE” to a public telecommunication network.



## **Rack Mounting**

- ◆ Before working on the rack, make sure that the stabilizers are secured to the rack, extended to the floor, and that the full weight of the rack rests on the floor. Install front and side stabilizers on a single rack or front stabilizers for joined multiple racks before working on the rack.
- ◆ Always load the rack from the bottom up, and load the heaviest item in the rack first.
- ◆ Make sure that the rack is level and stable before extending a device from the rack.
- ◆ Use caution when pressing the device rail release latches and sliding a device into or out of a rack; the slide rails can pinch your fingers.
- ◆ After a device is inserted into the rack, carefully extend the rail into a locking position, and then slide the device into the rack.
- ◆ Do not overload the AC supply branch circuit that provides power to the rack. The total rack load should not exceed 80 percent of the branch circuit rating.
- ◆ Make sure that all equipment used on the rack – including power strips and other electrical connectors – is properly grounded.
- ◆ Ensure that proper airflow is provided to devices in the rack.
- ◆ Ensure that the operating ambient temperature of the rack environment does not exceed the maximum ambient temperature specified for the equipment by the manufacturer
- ◆ Do not step on or stand on any device when servicing other devices in a rack.

## Technical Support

---

### International

- ◆ For online technical support – including troubleshooting, documentation, and software updates: <http://support.aten.com>
- ◆ For telephone support, see *Telephone Support*, page iii.

### North America

Email Support		<a href="mailto:support@aten-usa.com">support@aten-usa.com</a>
Online Technical Support	Troubleshooting Documentation Software Updates	<a href="http://www.aten-usa.com/support">http://www.aten-usa.com/support</a>
Telephone Support		1-888-999-ATEN ext 4988

When you contact us, please have the following information ready beforehand:

- ◆ Product model number, serial number, and date of purchase.
- ◆ Your computer configuration, including operating system, revision level, expansion cards, and software.
- ◆ Any error messages displayed at the time the error occurred.
- ◆ The sequence of operations that led up to the error.
- ◆ Any other information you feel may be of help.

# Specifications

Function		KH1508A	KH1516A	
Computer Connections	Direct	8	16	
	Max.	256 (via Daisy Chain)	512 (via Daisy Chain)	
Port Selection		OSD (On Screen Display); Hotkeys Pushbuttons		
Connectors	Console	KB	1 x 6-pin Mini-DIN F (Purple) 1 x USB Type A F	
		Video	1 x HDB-15 F	
		Mouse	1 x 6-pin Mini-DIN F (Green) 1 x USB Type A F	
	KVM Ports		8 x RJ-45	16 x RJ-45
	Daisy Chain	In	1 x DB-25 F	
		Out	1 x DB-25 M	
	F/W Upgrade		1 x RJ-11	
	Power		3-Prong AC socket	
Switches	Port Selection		8 x Pushbutton	16 x Pushbutton
	KVM Reset		1 x Recessed pushbutton	
	F/W Upgrade		1 x Slide	
	Power		1 x Rocker	
LEDs	Port	On Line	8 (Green)	16 (Green)
		Selected	8 (Orange)	16 (Orange)
	Power		1 (Blue)	
	Station ID		1 x 2 Digit 7-segment (Orange)	
Emulation	Keyboard		PS/2; USB	
	Mouse		PS/2; USB	
Scan Interval		1–255 sec.		
Video		1600 x 1200 @ 60Hz (40 m with KA7xx Adapter Cable) 1280 x 1024 @ 75Hz (50 m with KA7xx Adapter Cable)		
I/P Rating		100-240 VAC; 50/60 Hz; 1A		
Power Consumption		120V 5.8W / 230V 6W	120V 5.9W / 230V 6.1W	
Environment	Operating Temp.		0–40° C	
	Storage Temp.		-20–60° C	
	Humidity		0–80% RH	

Function		KH1508A	KH1516A
Physical Properties	Housing	Metal	
	Weight	2.74 kg	2.77 kg
	Dimensions	43.30 x 16.00 x 4.40 cm	

## Connection Tables

The following table indicates the relationship between the number of KH1508A / KH1516A units and the number of computers that they control

### **KH1508A**

No.	Computers	No.	Computers	No.	Computers	No.	Computers
1	1 - 8	9	65 - 72	17	129 - 136	25	193 - 200
2	9 - 16	10	73 - 80	18	137 - 144	26	201 - 208
3	17 - 24	11	81 - 88	19	145 - 152	27	209 - 216
4	25 - 32	12	89 - 96	20	153 - 160	28	217 - 224
5	33 - 40	13	97 - 104	21	161 - 168	29	225 - 232
6	41 - 48	14	105 - 112	22	169 - 176	30	233 - 240
7	49 - 56	15	113 - 120	23	177 - 184	31	241 - 248
8	57 - 64	16	121 - 128	24	185 - 192	32	249 - 256

### **KH1516A**

No.	Computers	No.	Computers	No.	Computers	No.	Computers
1	1 - 16	9	129 - 144	17	257 - 272	25	385 - 400
2	17 - 32	10	145 - 160	18	273 - 288	26	401 - 416
3	33 - 48	11	161 - 176	19	289 - 304	27	417 - 432
4	49 - 64	12	177 - 192	20	305 - 320	28	433 - 448
5	65 - 80	13	193 - 208	21	321 - 336	29	449 - 464
6	81 - 96	14	209 - 224	22	337 - 352	30	465 - 480
7	97 - 112	15	225 - 240	23	353 - 368	31	481 - 496
8	113 - 128	16	241 - 256	24	369 - 384	32	497 - 512

## Compatible Switches

---

The following ATEN switches can be installed on a KH1508A / KH1516A daisy chain:

ACS1208 / ACS1216	CS1708A / CS1716A CS1708i / CS1716i*	KH1508 / KH1516
-------------------	---	-----------------

**Note:** The CS1708i / CS1716i must be installed as the master switch when Daisy Chained with KH1508A or KH1516A switches.

---

## OSD Factory Default Settings

The factory default settings are as follows:

Setting	Default
OSD Hotkey	[Scroll Lock] [Scroll Lock]
Port ID Display Position	Upper Left Corner
Port ID Display Duration	3 Seconds
Port ID Display Mode	The Port Number plus the Port Name
Scan Duration	5 Seconds
Scan/Skip Mode	All
Screen Blanker	OFF
Hotkey Command Mode	ON
Hotkey	[Num Lock] + [-]
Logout Timeout	OFF
Beeper	ON
Accessible Ports	F (Full Access) For all Users on all Ports
Operation Mode	Share
OSD Language	English

## Administrator Login Failure

---

If you are unable to perform an Administrator login (because the Username and Password information has become corrupted or you have forgotten it, for example) you can clear the login information with the following procedure:

1. Power off the KH1508A / KH1516A and remove its housing.
2. Short the jumper labeled **J15**.

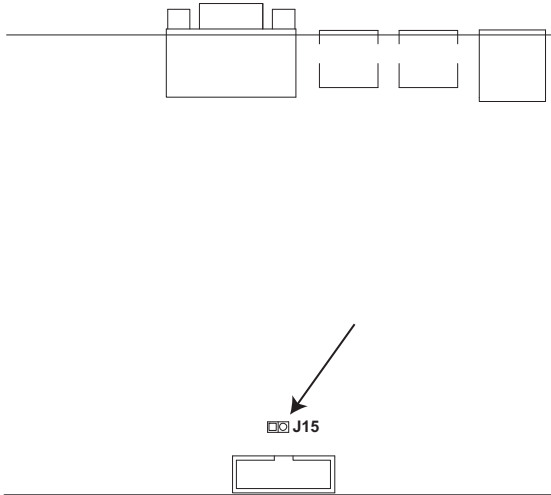

3. Power on the switch.  
The on screen display will show a message informing you that the password information has been cleared.
4. Power off the switch.
5. Remove the jumper cap from **J15**.
6. Close the housing and start the KH1508A / KH1516A back up.

After you start back up, you can use the default Username and Password (see *OSD Overview*, page 25) to log in.



## Troubleshooting

### Overview

Operation problems can be due to a variety of causes. The first step in solving them is to make sure that all cables are securely attached and seated completely in their sockets.

In addition, updating the product's firmware may solve problems that have been discovered and resolved since the prior version was released. If your product is not running the latest firmware version, we strongly recommend that you upgrade. See *The Firmware Upgrade Utility*, page 53, for upgrade details.

Symptom	Action
Mouse and/or Keyboard not responding.	<p>The mouse and/or keyboard need to be reset by either of the two following methods:</p> <ul style="list-style-type: none"> <li>◆ Unplug the cable(s) from the console port(s), then plug it (them) back in.</li> <li>◆ Perform a keyboard/mouse reset by hotkey (see <i>Computer Keyboard / Mouse Reset</i>, page 47) or by front panel pushbuttons (see <i>Port Selection Pushbuttons</i>, page 7)</li> </ul>
All Station IDs display as 01.	<ul style="list-style-type: none"> <li>◆ Station 1 suddenly lost its power. Wait a few seconds for the system to reinitialize the station sequence and display the proper IDs.</li> <li>◆ Perform a reset on station ID. See <i>RESET STATION IDS</i>, page 34.</li> <li>◆ Unplug the daisy-chain cable, then plug it back in.</li> </ul>

## Limited Warranty

---

ALTUSEN warrants this product against defects in material or workmanship for a period of one (1) year from the date of purchase. If this product proves to be defective, contact ALTUSEN's support department for repair or replacement of your unit. ALTUSEN will not issue a refund. Return requests can not be processed without the original proof of purchase.

When returning the product, you must ship the product in its original packaging or packaging that gives an equal degree of protection. Include your proof of purchase in the packaging and the RMA number clearly marked on the outside of the package.

This warranty becomes invalid if the factory-supplied serial number has been removed or altered on the product.

This warranty does not cover cosmetic damage or damage due to acts of God, accident, misuse, abuse, negligence or modification of any part of the product. This warranty does not cover damage due to improper operation or maintenance, connection to improper equipment, or attempted repair by anyone other than ALTUSEN. This warranty does not cover products sold AS IS or WITH FAULTS.

IN NO EVENT SHALL ALTUSEN'S LIABILITY EXCEED THE PRICE PAID FOR THE PRODUCT. FURTHER, ALTUSEN SHALL NOT BE RESPONSIBLE FOR DIRECT, INDIRECT, SPECIAL, INCIDENTAL OR CONSEQUENTIAL DAMAGES RESULTING FROM THE USE OF THE PRODUCT, ITS ACCOMPANYING SOFTWARE, OR ITS DOCUMENTATION. ALTUSEN SHALL NOT IN ANY WAY BE RESPONSIBLE FOR, WITHOUT LIMITATION, LOSS OF DATA, LOSS OF PROFITS, DOWNTIME, GOODWILL, DAMAGE OR REPLACEMENT OF EQUIPMENT OR PROPERTY, AND ANY EXPENSES FROM RECOVERY, PROGRAMMING, AND REPRODUCTION OF ANY PROGRAM OR DATA.

ALTUSEN makes no warranty or representation, expressed, implied, or statutory with respect to its products, contents or use of this documentation and all accompanying software, and specifically disclaims its quality, performance, merchantability, or fitness for any particular purpose.

ALTUSEN reserves the right to revise or update its product, software or documentation without obligation to notify any individual or entity of such revisions, or update.

For details about extended warranties, please contact one of our dedicated value added resellers.

# Index

## A

- Adapter cable installation, 16
- Administrator Login Failure, 70
- Auto Scanning, 30, 44
  - Invoking Auto Scan, 44
  - Pausing Auto Scan, 44
  - Setting the Scan Interval, 44
  - Stopping, 45

## B

- Benefits, 2

## C

- Components
  - Front View, 6
  - Rear View, 8
- Connection Tables, 65
- console modules, 11

## D

- Daisy chaining, 16

## F

- Factory Default Settings, 69
- Features, 2
- Firmware Upgrade
  - Recovery, 60
- Firmware upgrade
  - cable, 54
  - port, 54
  - recovery, 59
- Firmware Upgrade Mode
  - Invoking, 54
- Front View, 6

## H

- Hardware Setup, 11

- Hot Plugging, 22

- Hotkey, 25

- Selecting the Active Port, 43
- Summary Table, 50

- Hotkey Mode

- Exiting, 42
- Invoking, 42

- Hotkey Port Control, 41

## I

- Installation

- Daisy chaining, 16
- Single Station, 14

- Invoking Hotkey Mode, 42

## K

- Keyboard Emulation

- Mac, 51
- Sun, 52

- Keyboard port operation, 41

- Keyboard Reset, 47

- KH1508

- Rear View, 8

- KH1516

- Rear View, 8

- KVM Adapter Cables, 5

- KVM adapter cables, 11

- KVM adapter installation, 16

## L

- LEDs

- Port, 7
- Station ID, 7

## M

- Mouse Reset, 47

## O

Online

Registration, iii

OSD

Factory Default Settings, 69

Functions, 28

Hotkey, 25

Main Screen Headings, 27

Navigation, 27

Overview, 25

## P

Port

LEDs, 7

Selection, 21

Port ID

Numbering, 23

Powering Off and Restarting, 23

## R

Rack Mounting, 13

Rear View, 8

Requirements

Computer, 4

Console, 4

KVM adapter cables, 5

Operating Systems, 5

OS Support, 5

Reset Switch, 7

RoHS, ii

## S

Safety Instructions

General, 61

Rack Mounting, 63

Scan Duration, 30

Selecting the Active Port, 43

Setting the Auto Scan Interval, 30,  
44

Setting the Scan Interval, 30

SJ/T 11364-2006, ii

Skip Mode, 46

Stacking, 12

Station ID LEDs, 7

## T

Technical Support, 64

Telephone support, iii

Troubleshooting, 71

## U

User Notice, iii