



RAZER PRO CLICK MINI

MASTER GUIDE

Make the world your office with the **Razer Pro Click Mini**—your perfect go-to mouse for productivity on-the-go. With silent clicks and effortless navigation all packed into a compact design, this portable performer is the perfect fit for your workday no matter where you are.

CONTENTS

1. WHAT'S INSIDE / WHAT'S NEEDED	3
2. LET'S GET YOU COVERED	5
3. GETTING STARTED	6
4. USING YOUR MOUSE	10
5. CONFIGURING YOUR RAZER PRO CLICK MINI	12
6. SAFETY AND MAINTENANCE	26
7. LEGALESE.....	28

1. WHAT'S INSIDE / WHAT'S NEEDED

WHAT'S INSIDE

- Razer Pro Click Mini

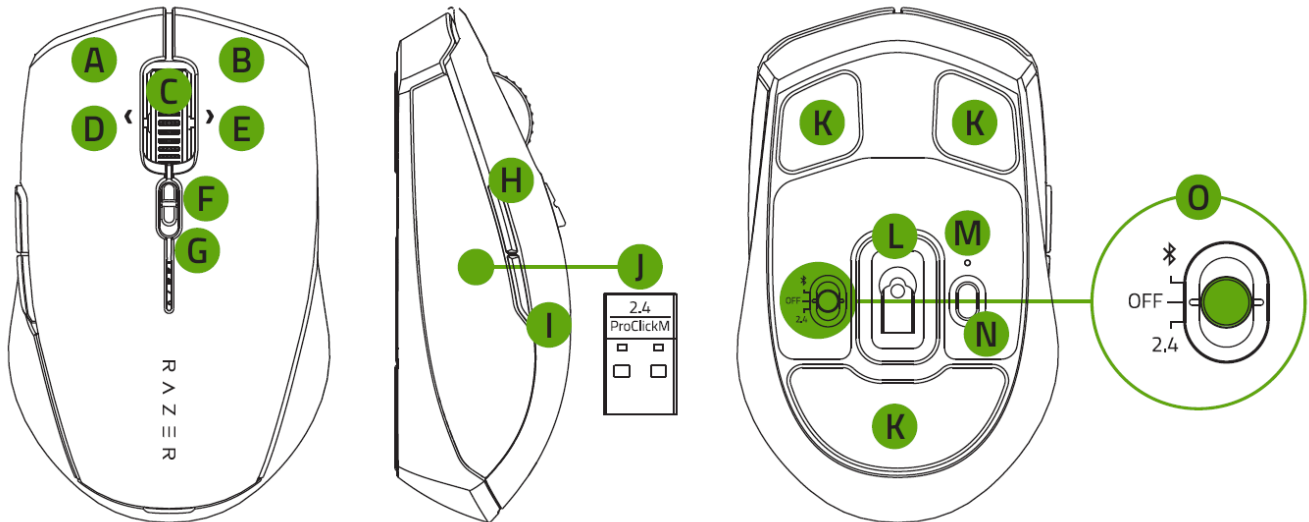

- A. Left mouse button
- B. Right mouse button
- C. Razer™ HyperScroll Tilt Wheel
- D. Left tilt-click
- E. Right tilt-click
- F. Razer™ HyperScroll Tilt Wheel mode switch
 - Free-spin mode
 - Tactile mode
- G. Low battery indicator
- H. Mouse button 5

- I. Mouse button 4
- J. Razer™ Productivity dongle
- K. Silent ultra-smooth mouse feet
- L. True 12K DPI 5G optical sensor
- M. Pairing indicator
- N. Pair/switch button
- O. Slider switch
 - Bluetooth mode
 - Power off mode
 - Razer™ HyperSpeed Wireless (2.4 GHz) mode

- 2 x AA batteries

- Important Product Information Guide

WHAT'S NEEDED

Product requirements

- USB-A port or Bluetooth 5.1 connectivity
- 2 x AA batteries*

Razer Synapse requirements

- Windows® 10 64-bit (or higher)
- Internet connection for software installation

**The Razer Pro Click Mini will also work on just one AA battery.*

2. LET'S GET YOU COVERED

You've got a great device in your hands, complete with a 2-year limited warranty coverage. Now maximize its potential and score exclusive Razer benefits by registering at razerid.razer.com

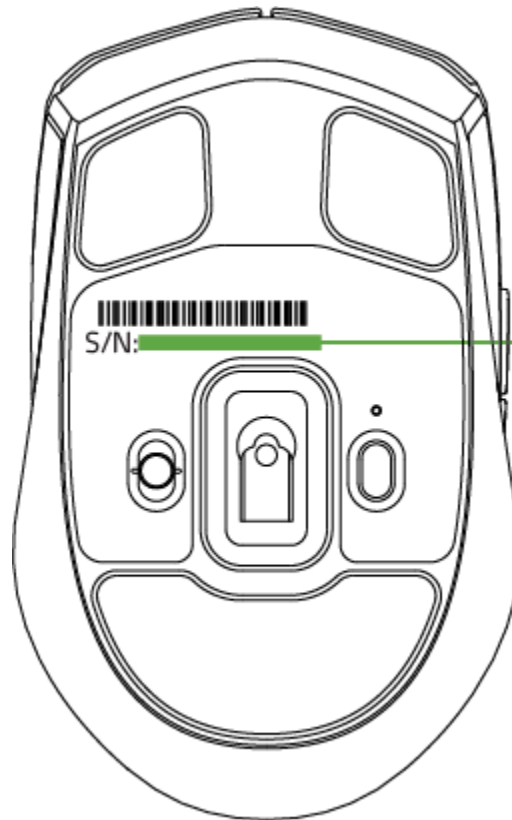

Your product's serial number can be found here.

Got a question? Ask the Razer Support Team at support.razer.com

3. GETTING STARTED

INSERTING THE BATTERY

1. Remove the top cover of the mouse and insert the AA batteries as indicated in the battery compartment.

i *The Razer Pro Click Mini will also work on just one AA battery.*

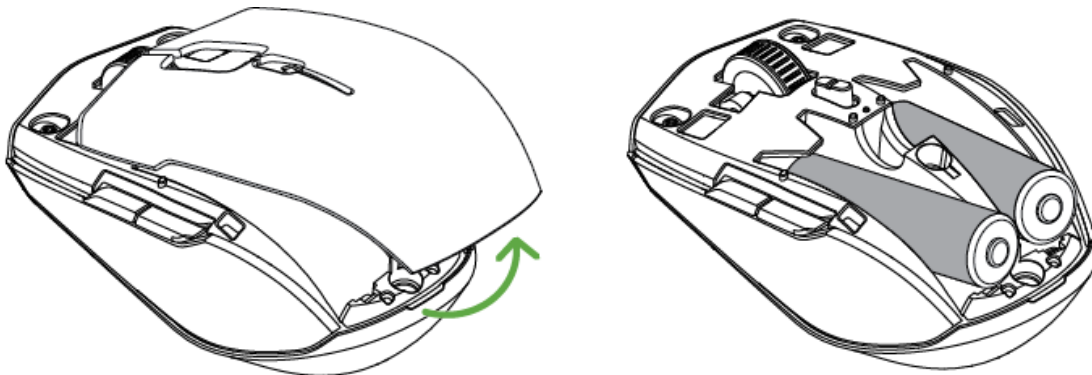

Caution: The two included AA batteries are non-rechargeable. Dispose of these batteries in accordance with your local environmental laws. For your safety, use only alkaline batteries and don't mix old batteries with new ones.

2. Reattach the top cover onto the mouse and make sure that it's tightly secured.

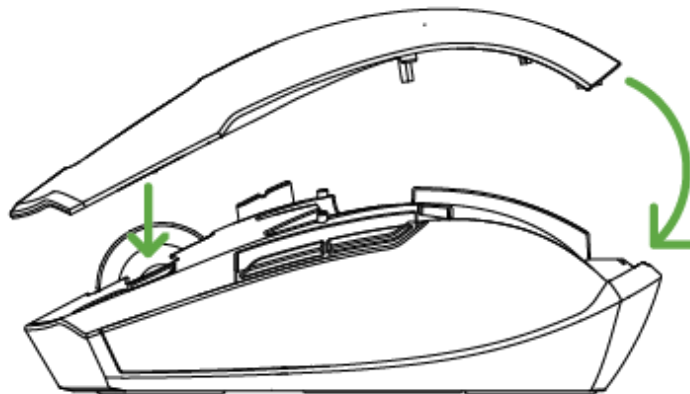

i *It's highly recommended to remove the batteries from the mouse if you're not intending to use it for a prolonged period of time.*

CONNECTING YOUR MOUSE

A. VIA RAZER™ HYPER SPEED (2.4 GHz) MODE

1. Remove the top cover of the mouse and take out the Razer™ Productivity Dongle.

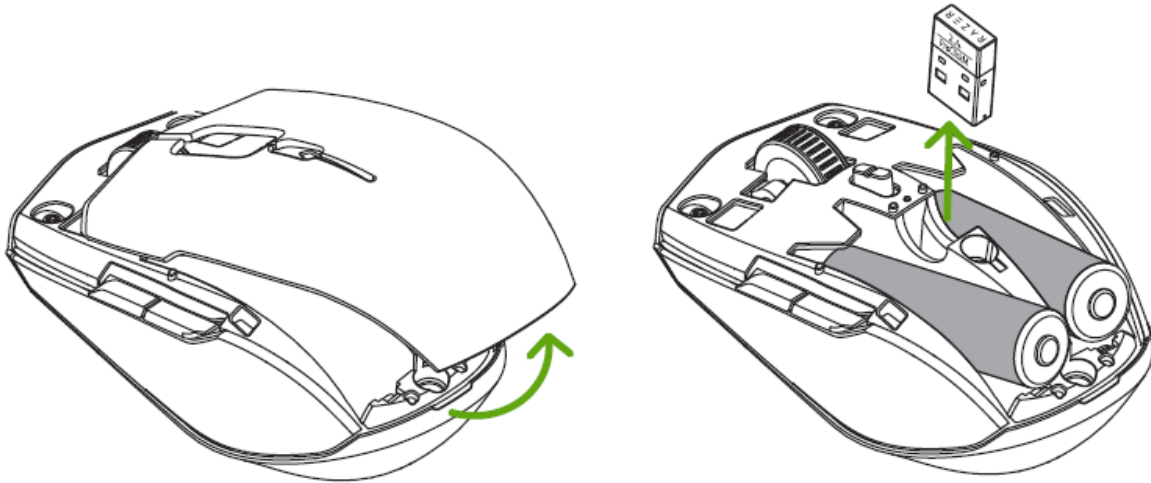

2. Close the top cover and insert the Razer™ Productivity dongle into the USB port of your PC.

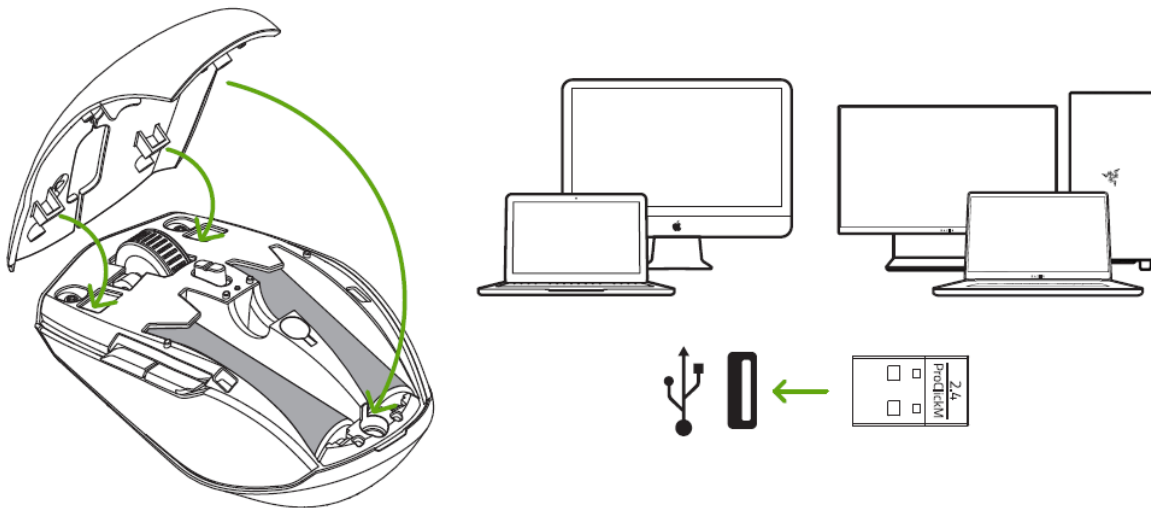

3. Push the slider switch to Razer™ HyperSpeed wireless (2.4 GHz) mode. When connected, the pairing indicator will briefly turn static white.

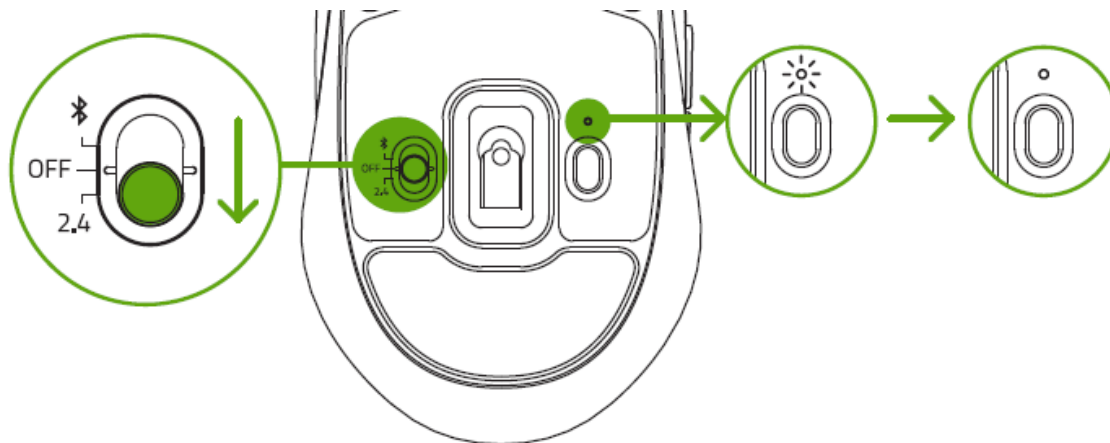

Your Razer Pro Click Mini is now ready for use in wireless mode.

B. VIA BLUETOOTH MODE

1. Push the slider switch to Bluetooth mode (⌘).

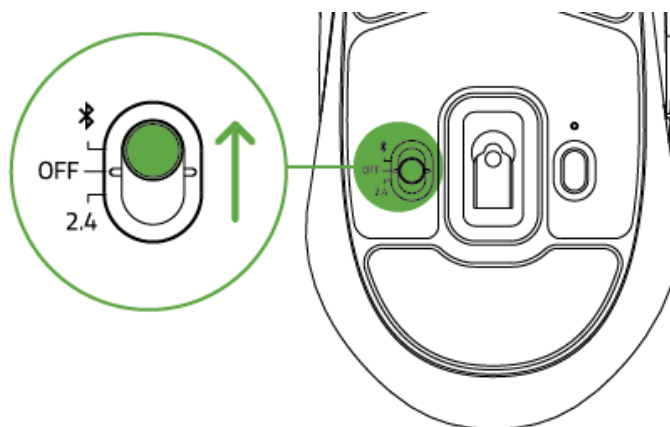

2. Press the pair/switch button to select a slot for your Bluetooth device. You can pair up to 3 Bluetooth devices on your Razer Pro Click Mini. The pairing indicator will blink twice in repeated intervals to show that the mouse is in pairing mode.

Slot	Color
1 (Default)	Blue
2	Green
3	Yellow

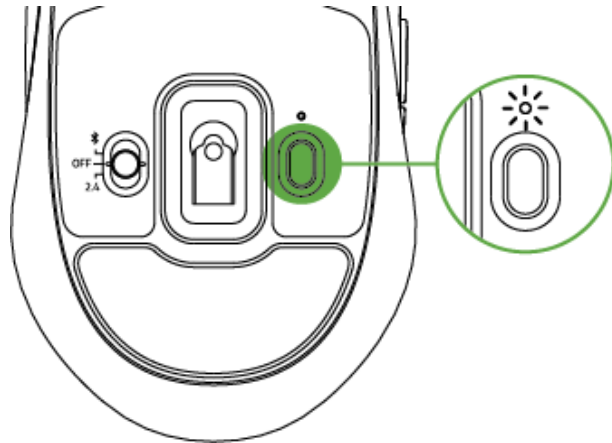

3. Activate Bluetooth on your device and select "ProClick M" from the list of devices found.
4. Wait until both devices are paired. When paired, the pairing indicator will briefly change to static before turning off.

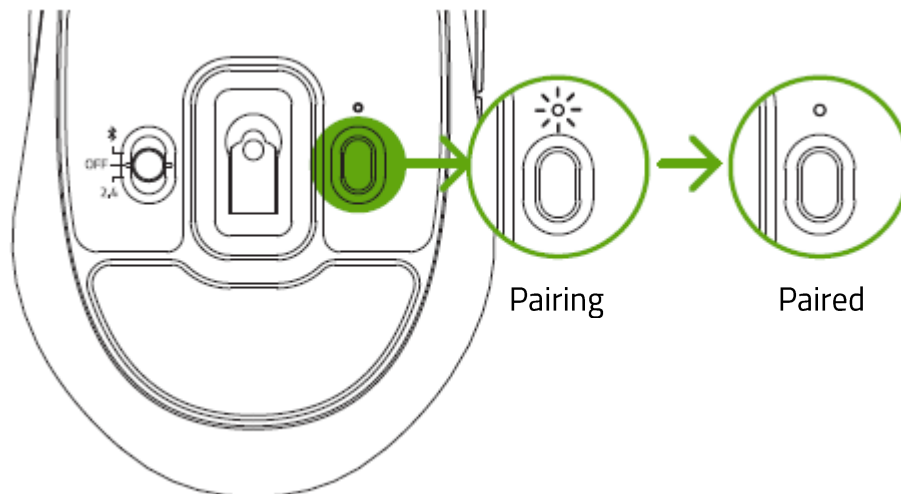

i Once paired, your Razer Pro Click Mini will automatically reconnect to the last paired device whenever in Bluetooth mode and within range. Keep the pairing devices within close proximity of each other for faster and more stable connection.

Congratulations, your Razer Pro Click Mini is now ready to use in Bluetooth mode.

4. USING YOUR MOUSE

PAIRING NEW DEVICES TO A BLUETOOTH SLOT

To pair a new device to any Bluetooth slot currently in use, select a slot by pressing the pair/switch button, and then press and hold the pair/switch button for 3 seconds to activate its pairing mode. The pairing indicator will blink twice in repeated intervals to show that the device is in pairing mode.

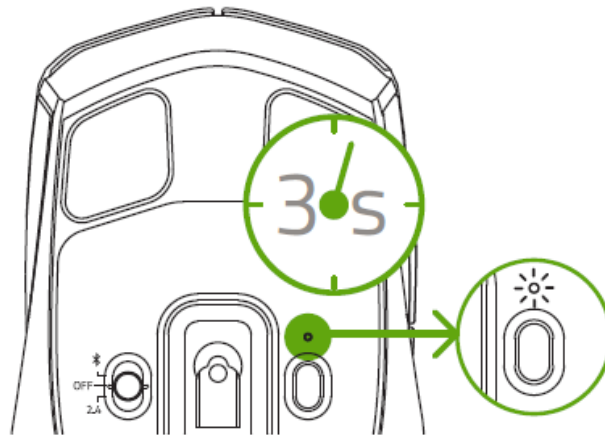

Follow your device's instructions to pair it with your mouse. Once paired, the pairing indicator will briefly change to static before turning off.

LOW BATTERY NOTIFICATION

The low battery indicator will blink red twice in repeated intervals to indicate that the battery level of the inserted battery is less than 5%*. This lighting sequence will repeat until the battery is fully drained. Once you receive this notification, it's time to replace the battery.

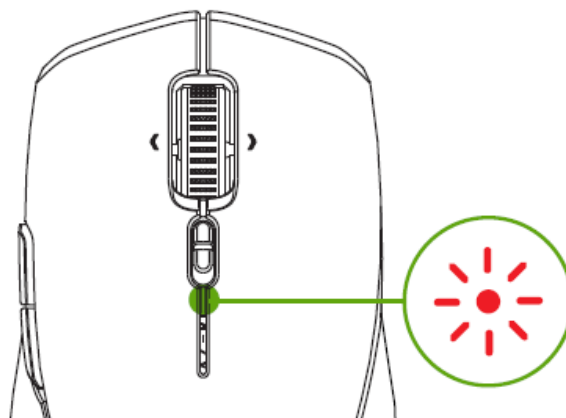

SWITCHING SCROLL MODES

The Razer™ HyperScroll Tilt Wheel mode switch allows you to control how you navigate through long documents and pages. To switch scroll modes, push the Razer™ HyperScroll Tilt Wheel mode switch forward to enable unbridled scroll wheel freedom for faster navigation in Free-Spin mode; or nudge it backward to precisely control scroll wheel movement in Tactile mode.

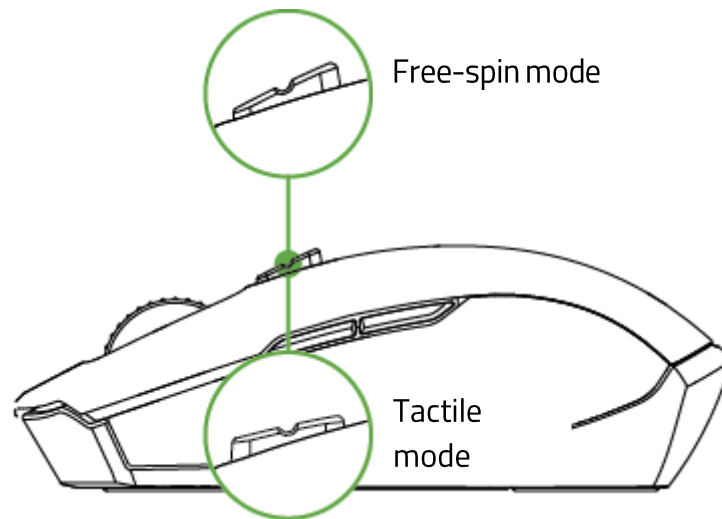

PERSONALIZING YOUR MOUSE

Use the Razer Synapse app to change your mouse's DPI to match your work style, fine-tune your own sensitivity setting, and customize other features available on your mouse.

 *Install Razer Synapse when prompted or download the installer from razer.com/synapse*

5. CONFIGURING YOUR RAZER PRO CLICK MINI

i *Internet connection is required for installation, updates and cloud-based features. Registering for a Razer ID account is recommended, but optional. All listed features are subject to change based on the current software version, connected device(s), and supported apps and software.*

SYNAPSE TAB

The Synapse tab is your default tab when you first launch Razer Synapse. This tab allows you to navigate the Dashboard subtab.

Dashboard

The Dashboard subtab is an overview of your Razer Synapse where you can access all your Razer devices, modules, and online services.

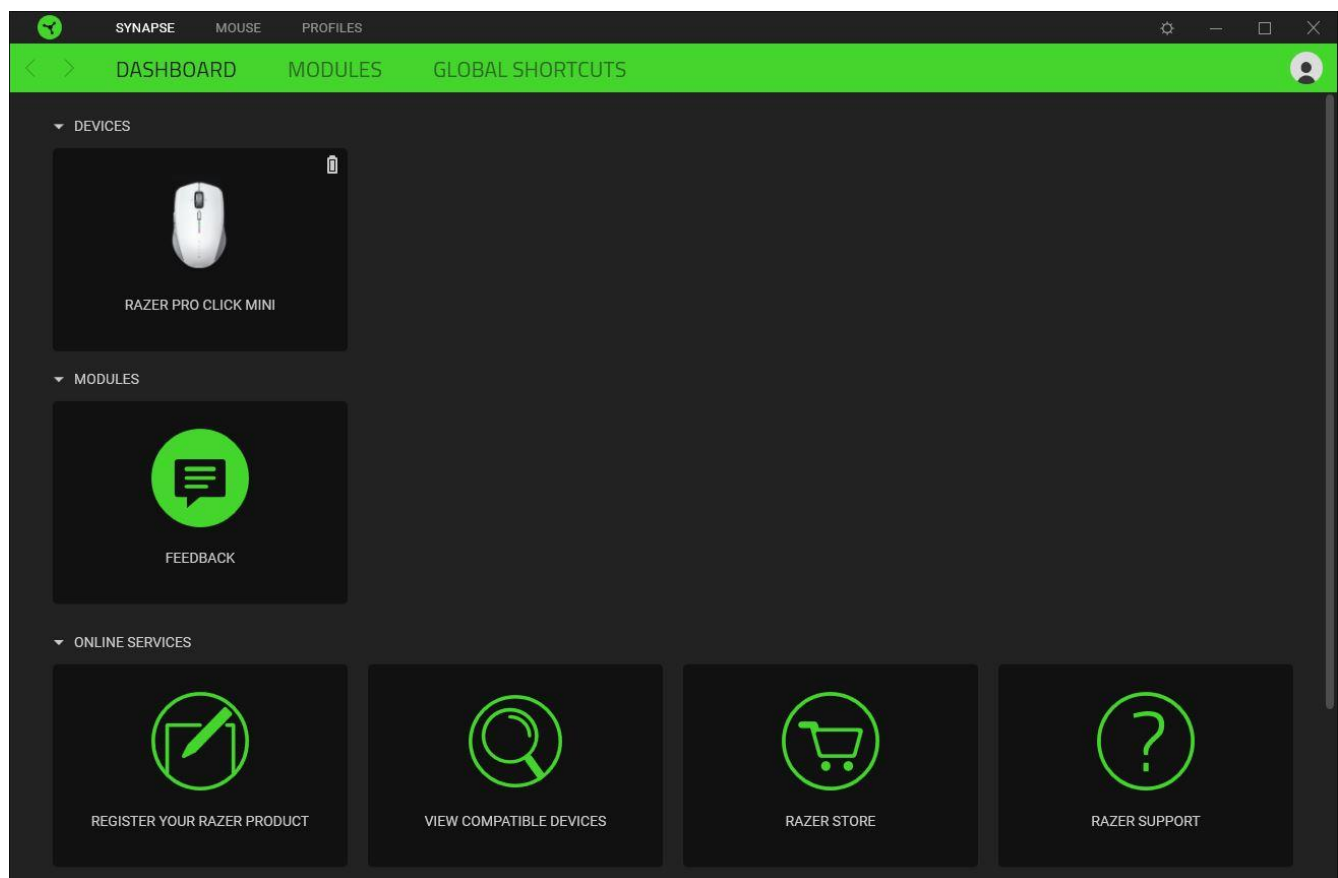

Modules

The Modules subtab displays all installed and available modules for installation.

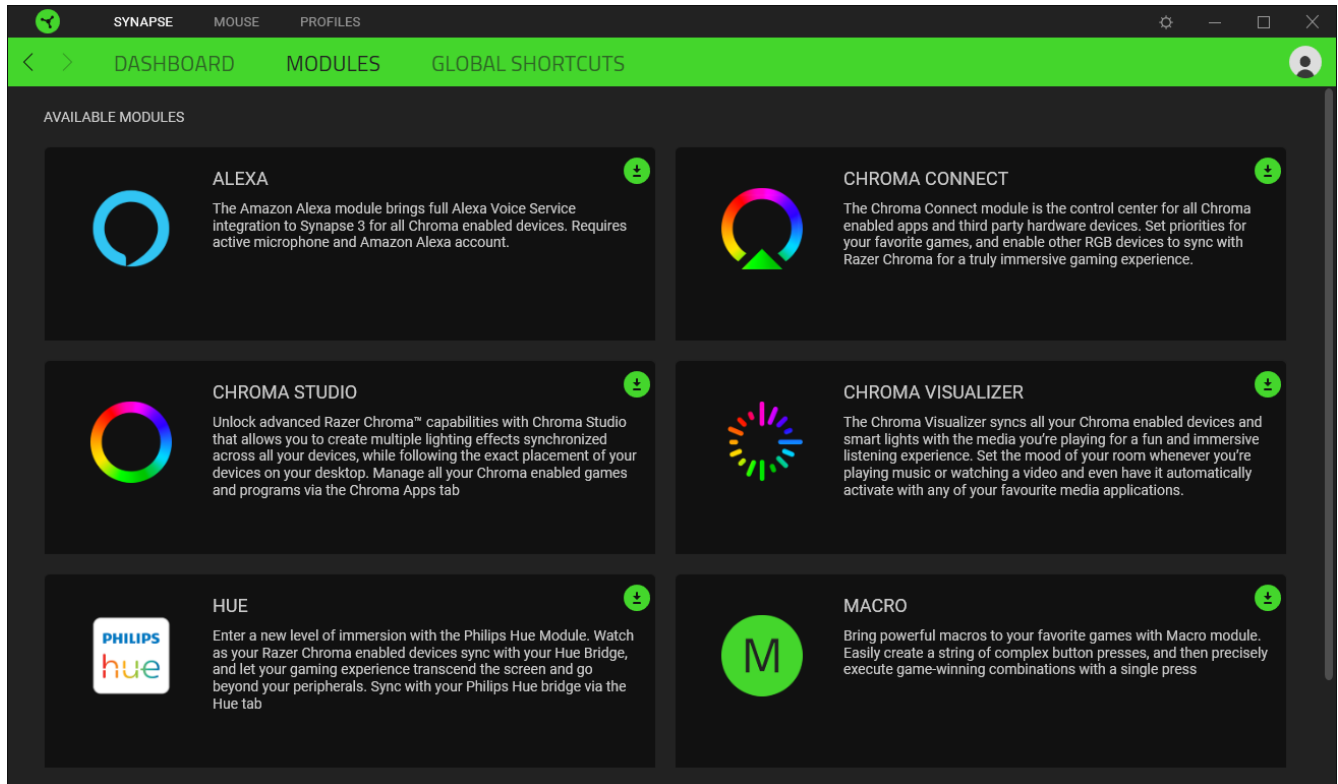

Global Shortcuts

Bind operations or Razer Synapse functions to custom key-combinations from any Razer Synapse-enabled device inputs which apply across all device profiles. [Learn more about Profiles](#)

 *Only Razer Synapse-enabled device inputs will be recognized.*

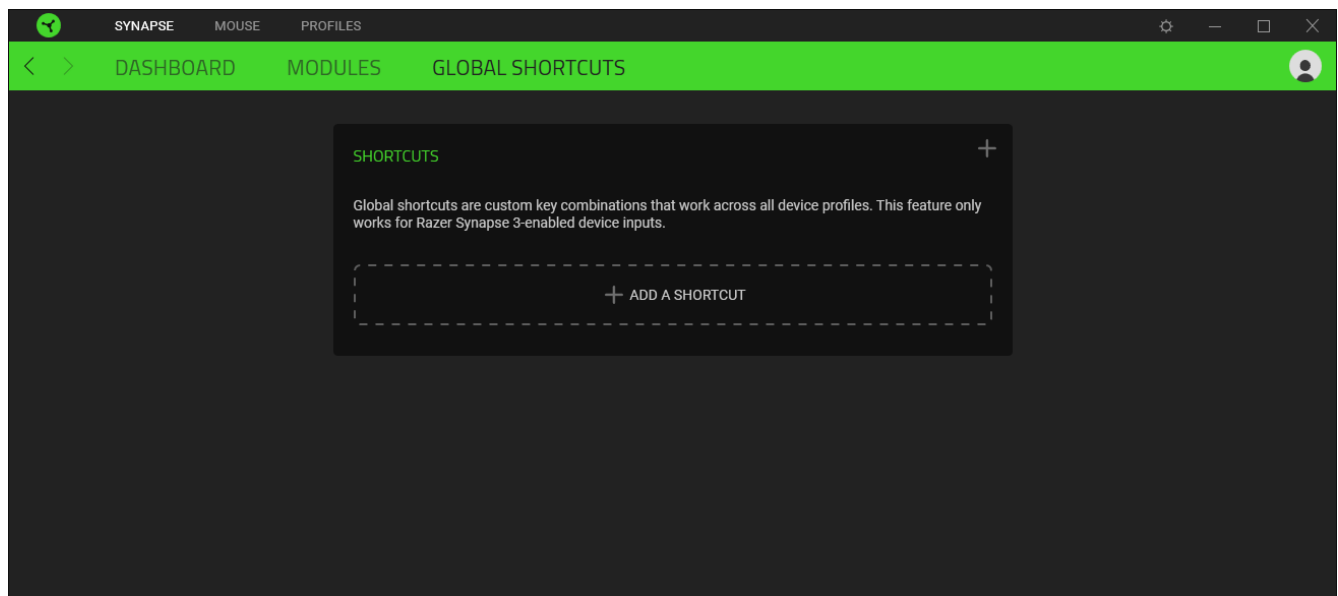

MOUSE TAB

The Mouse tab is the main tab for your Razer Pro Click Mini. From here, you can change your device's settings such as button assignment and DPI sensitivity. Changes made under this tab are automatically saved to your system and cloud storage.

Customize

The Customize subtab is for modifying your mouse's button assignments.

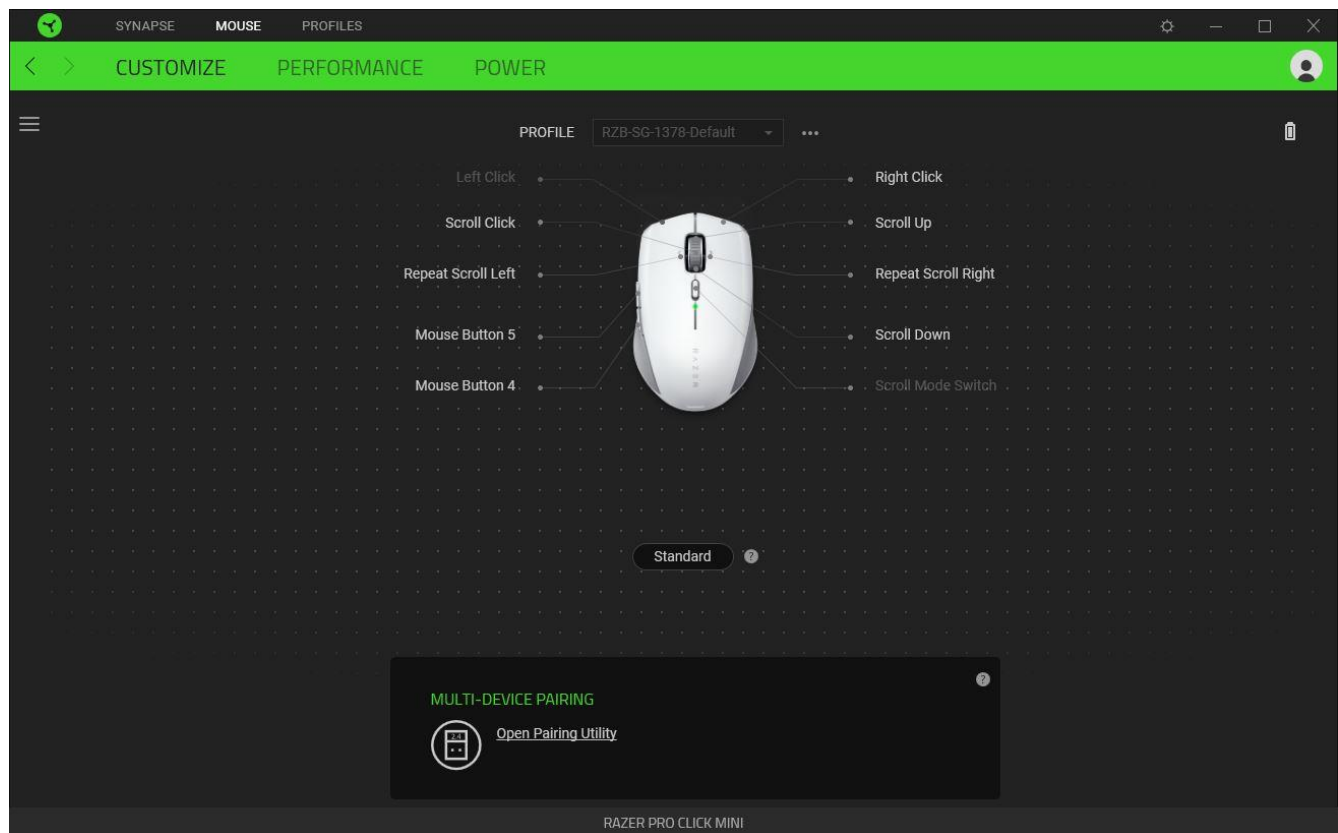

Profile

A Profile is a data storage for keeping all your Razer peripheral's settings. By default, the profile name is based on your system's name. To add, rename, duplicate, or delete a profile, simply press the Miscellaneous button (⋮).

Standard / Hypershift

Hypershift mode is a secondary set of button assignments that is activated when the Hypershift key is held down. By default, the Hypershift key is assigned to the fn key of your Razer Synapse supported keyboard however, you can also assign any mouse button as a Hypershift key.

Multi-Device Pairing

Use this feature to pair an additional HyperSpeed-compatible device with the Razer™ Productivity dongle of your Razer Pro Click Mini. As the Razer™ Productivity dongle can support a keyboard and mouse at the same time, you'll be able to remove the usage of separate dongles for each peripheral.



Your Razer Pro Click Mini must be connected via HyperSpeed (2.4 GHz) wireless mode to use this feature. Each peripheral can only connect to one dongle at a time.

Sidebar

Clicking the Sidebar button (☰) will reveal all current button assignments for your Razer Pro Click Mini.

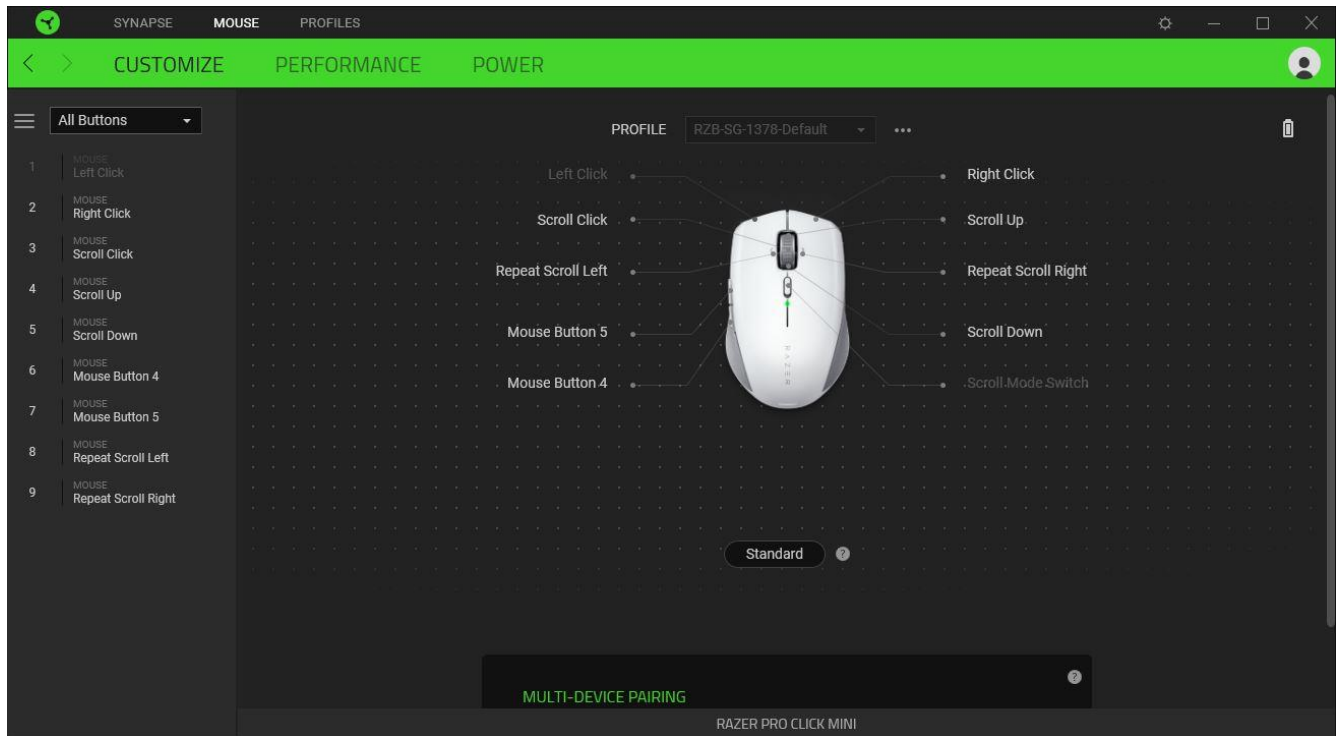

Alternatively, you can skip to a specific button assignment by selecting it on the Customize tab.

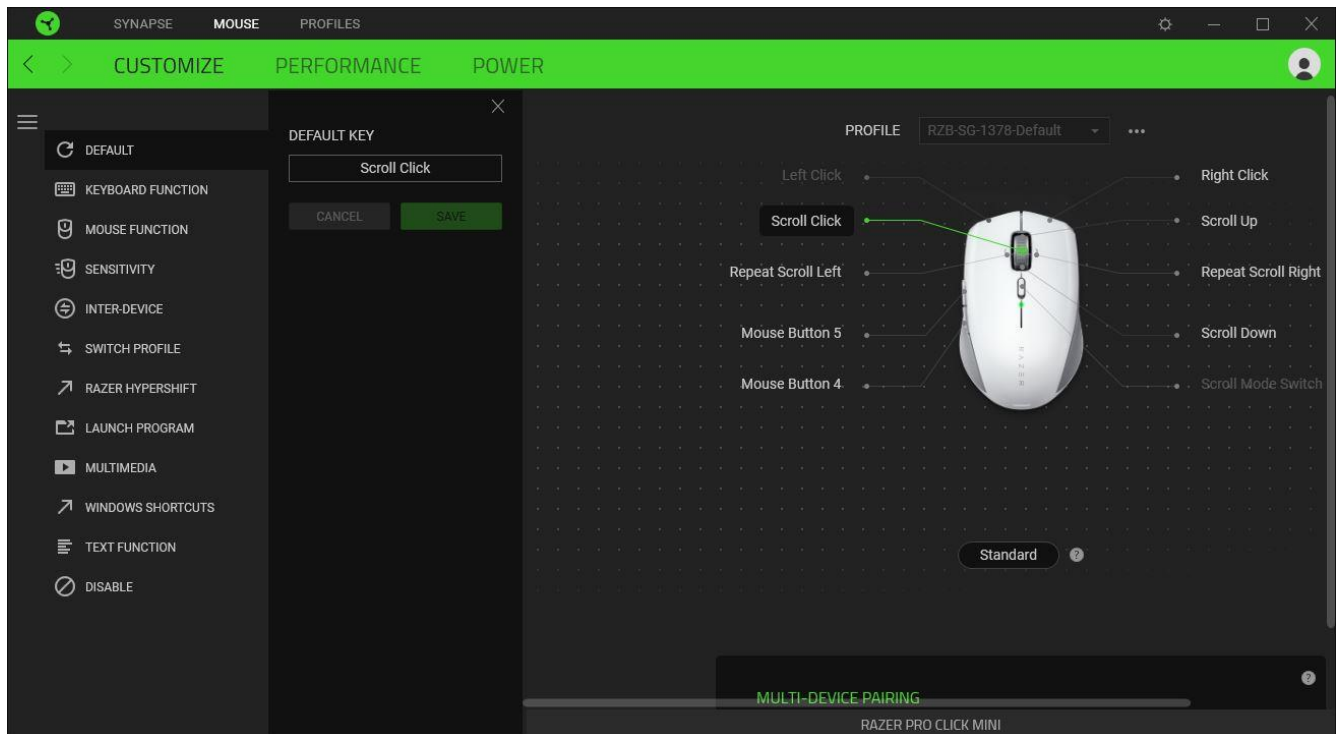

Upon selecting a button assignment, you may then change it to one of the following functions:

Default

This option enables you to return the mouse button to its original setting.

Keyboard Function

This option changes the button assignment into a keyboard function. You can also choose to enable Turbo mode which allows you to emulate a repeated keyboard function while the button is held down.

Mouse Function

This option substitutes the current button assignment into another mouse function. Listed below are the functions which you can choose from:

- Left Click - Performs a left mouse click using the assigned button.
- Right Click - Performs a right mouse click using the assigned button.
- Scroll Click - Activates the universal scrolling function.
- Double Click - Performs a double left click using the assigned button.
- Mouse Button 4 - Performs a "Backward" command for most internet browsers.
- Mouse Button 5 - Performs a "Forward" command for most internet browsers.
- Scroll Up - Performs a "Scroll Up" command using the assigned button.
- Scroll Down - Performs a "Scroll Down" command using the assigned button.
- Scroll Left - Performs a "Scroll Left" command using the assigned button.
- Scroll Right - Performs a "Scroll Right" command using the assigned button.

You can also choose to enable Turbo mode in some of the mouse functions which allow you to emulate repeatedly pressing and releasing said function while the button is held down.

Sensitivity

This function allows you to manipulate the DPI setting of your Razer Pro Click Mini with a touch of a button. Listed below are the Sensitivity options and their description:

- Sensitivity Clutch - Changes the sensitivity to a predefined DPI while the designated button is held down. Releasing the button will return it to the previous sensitivity.
- Sensitivity Stage Up - Increases the current sensitivity by one stage.
- Sensitivity Stage Down - Decreases the current sensitivity by one stage.

- On-The-Fly Sensitivity - Pressing the designated button and moving the scroll wheel either up or down will increase or decrease the current DPI respectively.
- Cycle Up Sensitivity Stages - Increases the current sensitivity stage by one. Once it reaches the highest sensitivity stage, it will return to stage 1 when the button is pressed again.
- Cycle Down Sensitivity Stages - Decreases the current sensitivity stage by one. Once it reaches stage 1, it will return to the highest sensitivity stage when the button is pressed again. [Learn more about Sensitivity Stages](#)

M Macro

A Macro is a prerecorded sequence of keystrokes and button presses that is executed with precise timing. By setting the button function to Macro, you can conveniently execute a chain of commands. This function will only be visible when the Macro module is installed.

↻ Inter-device

Inter-device allows you to change the functionality of other Razer Synapse-enabled devices. Some of these functionalities are device-specific such as using your Razer keyboard to change the Sensitivity Stage of your Razer mouse.

↔ Switch Profile

Switch Profile enables you to quickly change profiles and load a new set of button assignments. An on-screen notification will appear whenever you switch profiles.

↗ Razer Hypershift

Setting the button to Razer Hypershift will allow you to activate Hypershift mode as long as the button is held down.

🔗 Launch Program

Launch Program enables you to open an app or a website using the assigned button. When you select Launch Program, two choices will appear which requires you to search for a specific app you want to open, or write the address of the website you want to visit.

▶ Multimedia

This option allows you to assign multimedia controls to your Razer device. Listed below are the multimedia controls you can choose from:

- Volume Down - Decreases the audio output.

- Volume Up - Increases the audio output.
- Mute Volume - Mutes the audio.
- Mic Volume Up - Increases the microphone volume.
- Mic Volume Down - Decreases the microphone volume.
- Mute Mic - Mutes the microphone.
- Mute All - Mutes both microphone and audio output.
- Play / Pause - Play, pause, or resume playback of the current media.
- Previous Track - Play the previous media track.
- Next Track - Play the next media track.

Windows Shortcuts

This option allows you to assign your preferred button into a Windows Operating System shortcut command. For more information, please visit: support.microsoft.com/kb/126449

Text Function

Text Function enables you to type a prewritten text with a touch of a button. Simply write your desired text on the given field and your text will be typed whenever the assigned button is pressed. This function has full Unicode support and you can also insert special symbols from character maps.

Disable

This option renders the assigned button unusable. Use Disable if you do not want to use the selected button or if it interferes with your work.

Performance

The Performance subtab allows you to modify the sensitivity, acceleration, and polling rate.

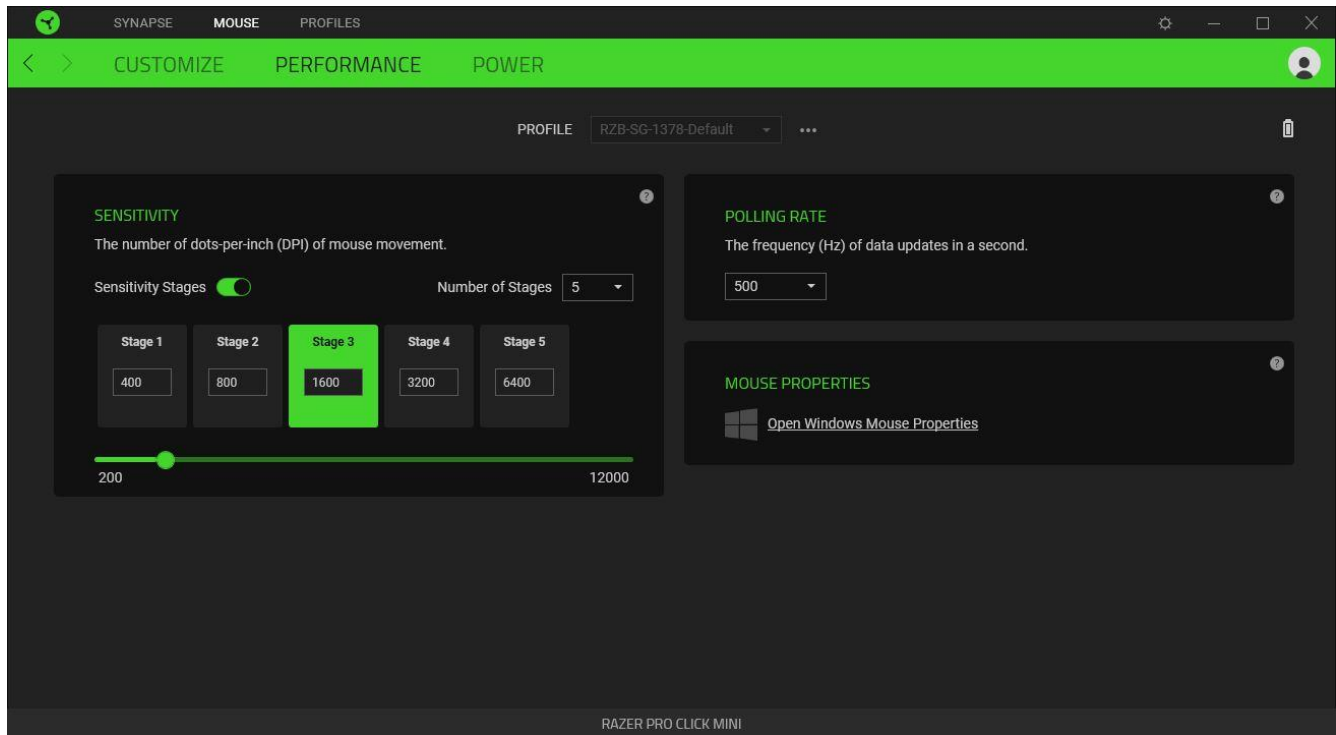

Sensitivity

Sensitivity refers to the distance the cursor will travel based on how far the mouse moved. The higher the DPI, the farther the cursor will travel given the same distance of mouse movement.

Sensitivity Stages

A sensitivity stage is a preset sensitivity value. You can create up to 5 different sensitivity stages which you can cycle through using the DPI cycle button.

Polling Rate

The higher the polling rate, the more often the computer receives information about the status of your mouse, thus increasing the mouse pointer's reaction time. You can switch between 125Hz (8ms), 500Hz (2ms) and 1000Hz (1ms) by selecting your desired polling rate on the dropdown menu.

Mouse Properties

From here, you can access the Windows Mouse Properties to modify operating system settings that can directly affect your Razer Pro Click Mini.

Power

The Power subtab allows you to set your mouse to enter sleep mode when it has been idle for a certain amount of time.

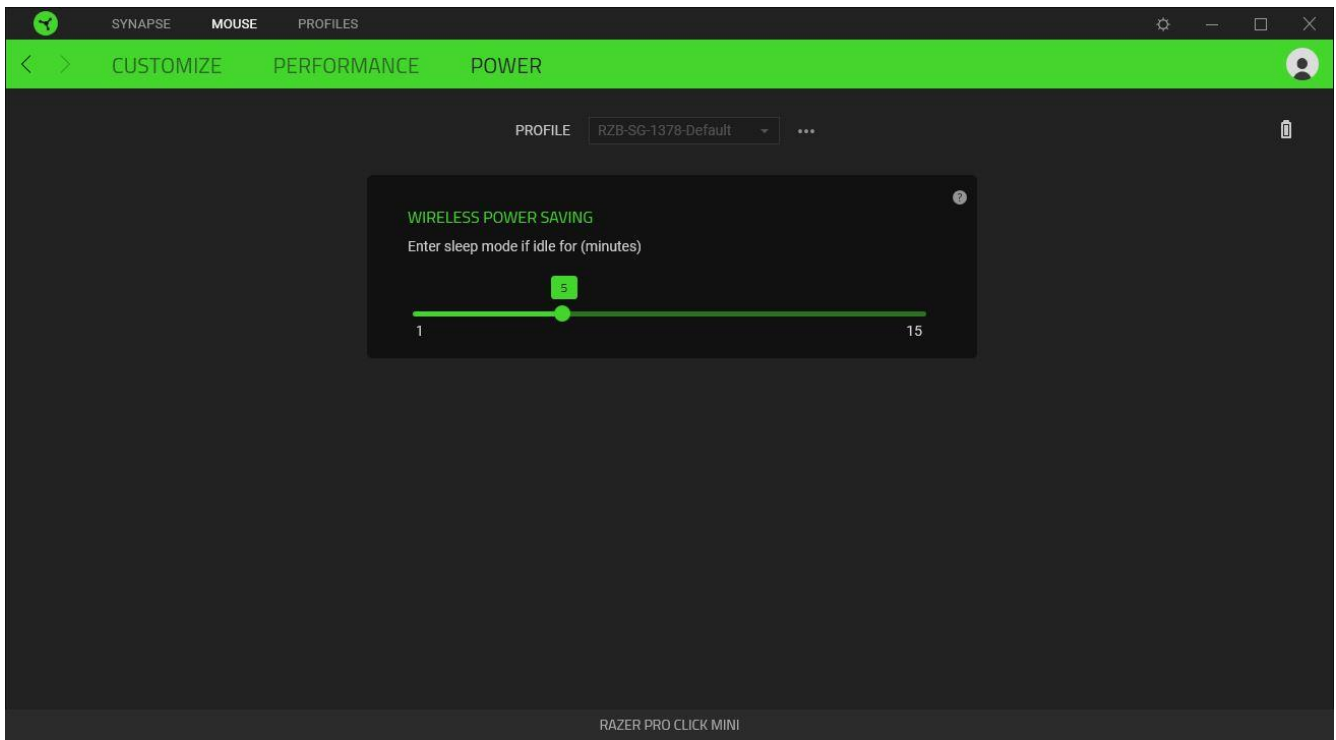





PROFILES TAB

The Profiles tab is a convenient way of managing all your profiles and linking them to your games and applications.

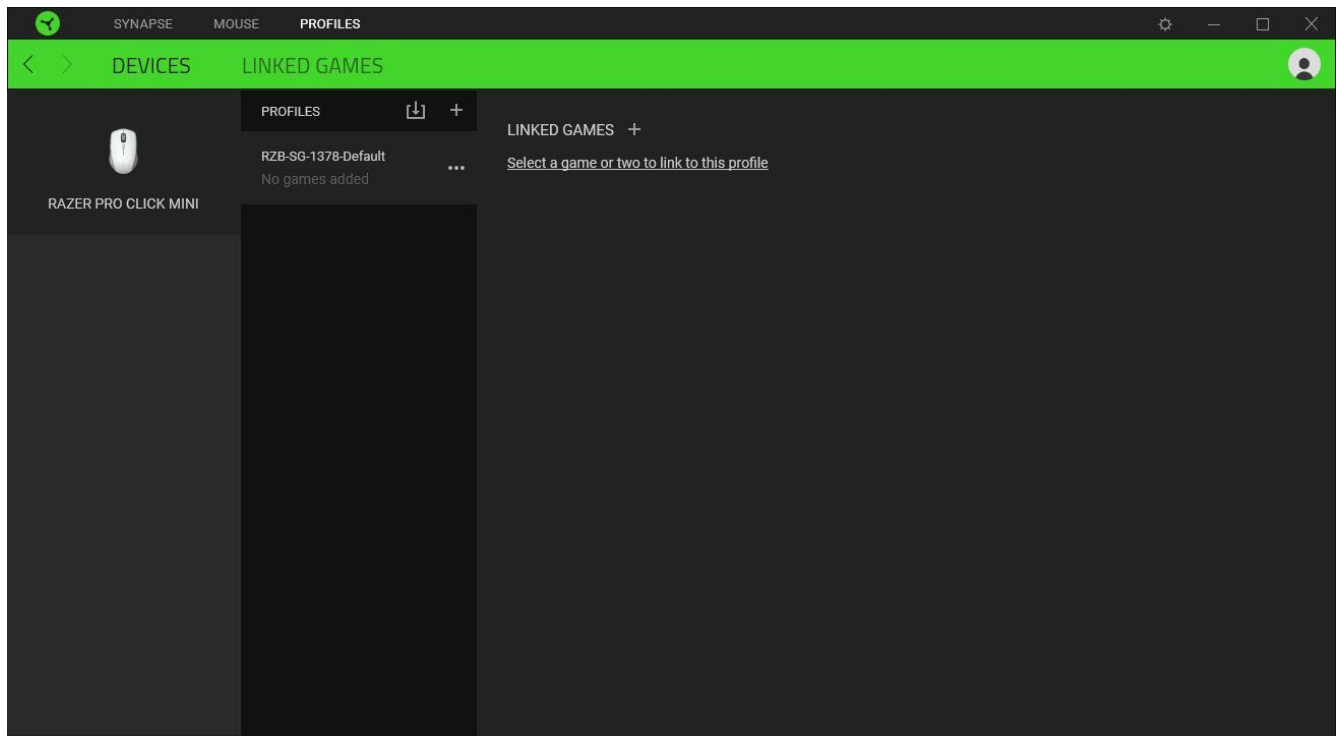
Devices

View which games are linked to each device's profiles or which Chroma Effect is linked to specific games using the Devices subtab.



You can import Profiles from your computer or from the cloud through the import button () or create new profiles within the selected device using the add button (). To rename, duplicate, export, or delete a profile, simply press the Miscellaneous button (). Each profile can be set to automatically activate when you run an application using the Linked Games option.

Linked Games

The Linked Games subtab gives you the flexibility to add games, view devices that are linked to games, or search for added games. You can also sort games based on alphabetical order, last played, or most played. Added games will still be listed here even if it is not linked to a Razer device.

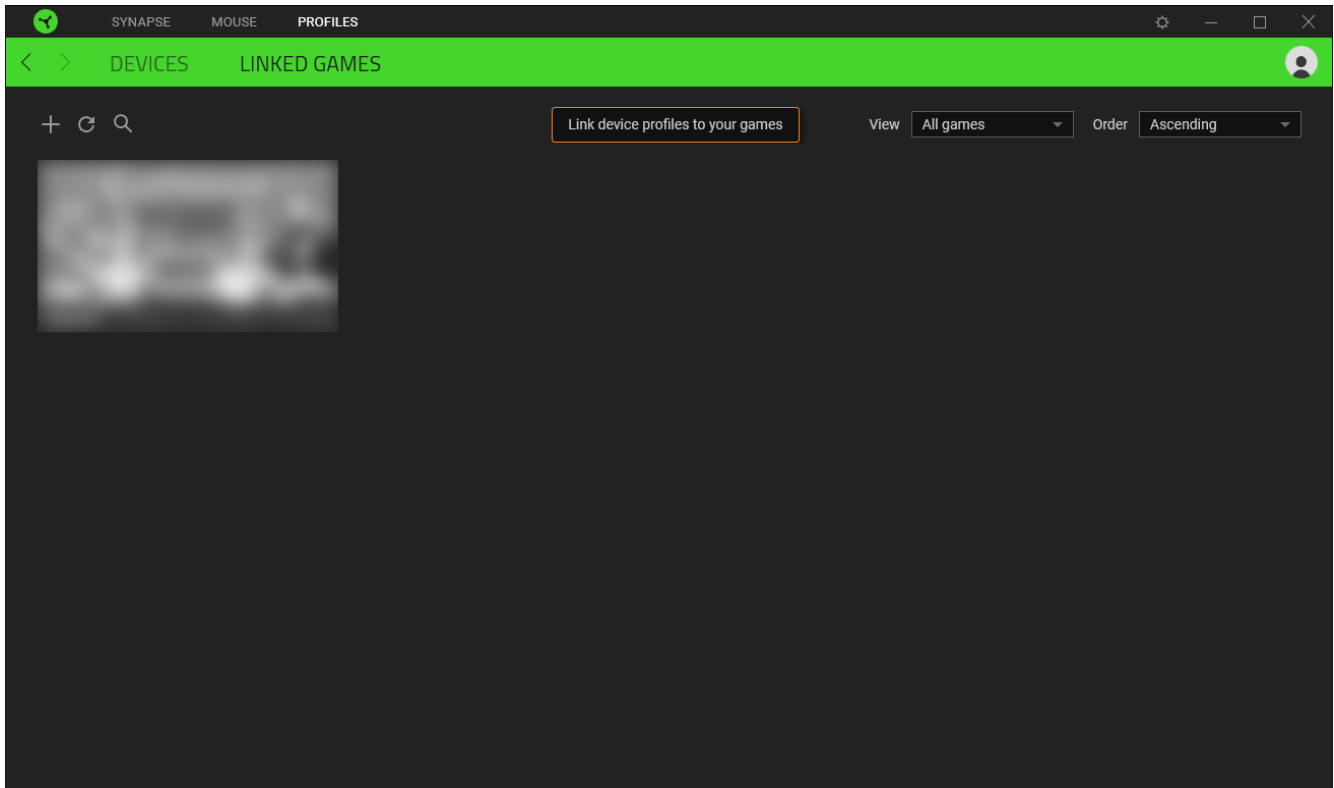

To link games to connected Razer devices or Chroma Effects, simply click on any game from the list, and then click **Select a device and its profile to launch automatically during gameplay** to select the Razer device or Chroma Effect it will link with. Once linked, you may click on the Miscellaneous button (●●●) of the corresponding Chroma Effect or device to select a specific Chroma Effect or profile.

SETTINGS WINDOW

The Settings window, accessible by clicking the (⚙️) button on Razer Synapse, enables you to configure the startup behavior and display language of Razer Synapse, view the master guides of each connected Razer device, or perform factory reset on any connected Razer device.

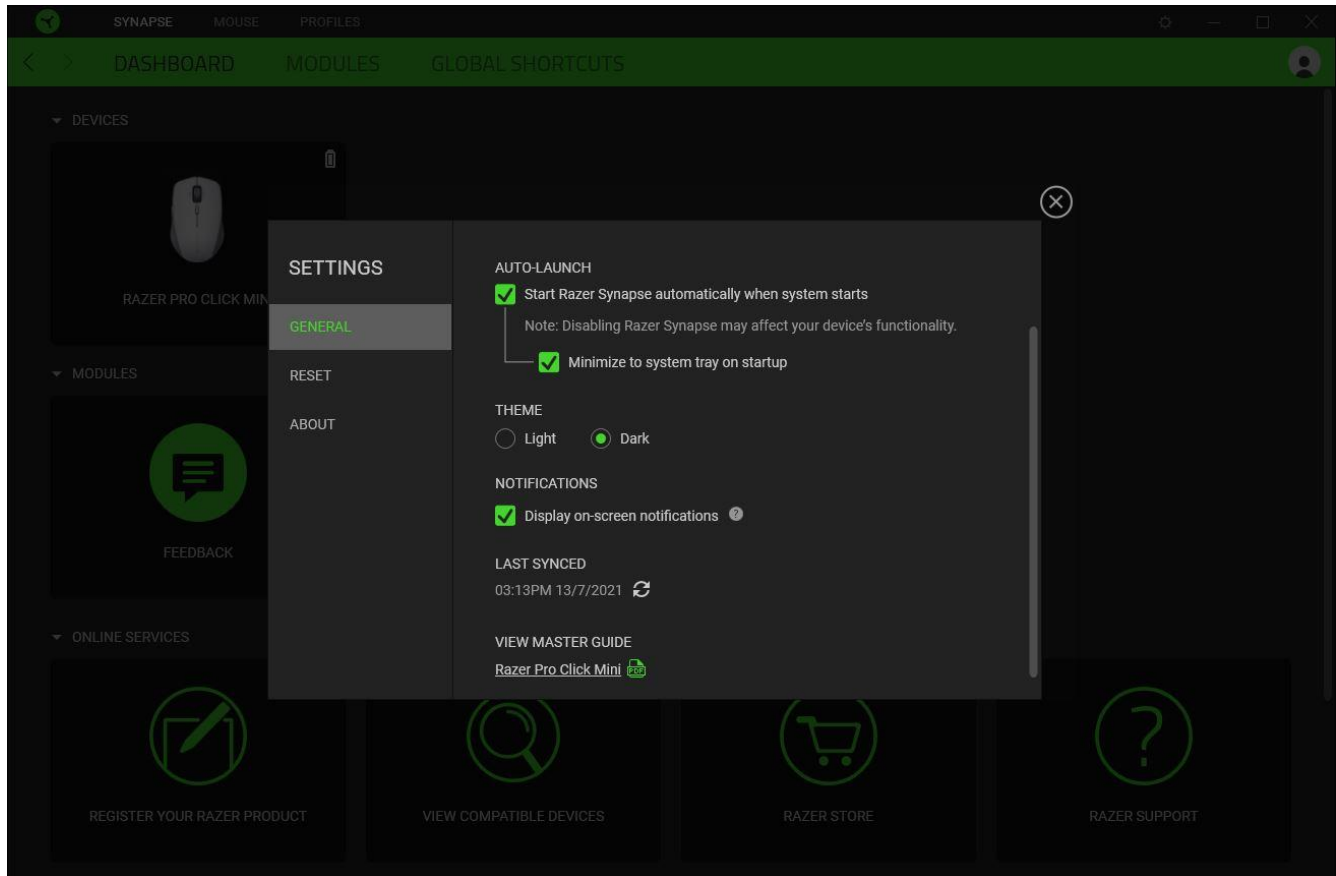

General tab

The default tab of the Settings window. The General tab enables you to change the software's display language, start-up behavior, display theme, and on-screen notifications display. You may also manually sync your profiles to the cloud (↻) or view the master guide of all connected Razer devices and installed modules.

Reset tab

The Reset tab allows you to perform a factory reset on all connected Razer devices with on-board memory and/or reset Razer Synapse tutorials to acquaint yourself again with Razer Synapse's new features on its next launch.

 *By resetting a Razer device, all profiles stored on the selected device's on-board memory will be erased.*

About tab

The About tab displays brief software information, copyright statement and provides relevant links for its terms of use. You may also use this tab to check for software updates, or as a quick access to Razer's social communities.

6. SAFETY AND MAINTENANCE

SAFETY GUIDELINES

In order to achieve maximum safety while using your Razer Pro Click Mini, we suggest that you adopt the following guidelines:

Should you have trouble operating the device properly and troubleshooting does not work, unplug the device and contact the Razer hotline or go to support.razer.com for support.

Do not take apart the device (doing so will void your warranty) and do not attempt to operate it under abnormal current loads.

Keep the device away from liquid, humidity or moisture. Operate the device only within the specific temperature range of 0°C (32°F) to 40°C (104°F). Should the temperature exceed this range, unplug and/or switch off the device in order to let the temperature stabilize to an optimal level.

Avoid looking directly at the tracking beam of your mouse or pointing the beam in anyone else's eye. Note that the tracking beam is NOT visible to the naked human eye and is set on an Always-On mode.

COMFORT

Research has shown that long periods of repetitive motion, improper positioning of your computer peripherals, incorrect body position, and poor habits may be associated with physical discomfort and injury to nerves, tendons, and muscles. Below are some guidelines to avoid injury and ensure optimum comfort while using your Razer Pro Click Mini.

- Position your keyboard and monitor directly in front of you with your mouse next to it. Place your elbows next to your side, not too far away and your keyboard within easy reach.
- Adjust the height of your chair and table so that the keyboard and mouse are at or below elbow-height.
- Keep your feet well supported, posture straight and your shoulders relaxed.
- During use, relax your wrist and keep it straight. If you do the same tasks with your hands repeatedly, try not to bend, extend or twist your hands for long periods.
- Do not rest your wrists on hard surfaces for long periods. Use a wrist rest to support your wrist while working.
- Do not sit in the same position all day. Get up, step away from your desk and do exercises to stretch your arms, shoulders, neck and legs.

If you should experience any physical discomfort while using your mouse, such as pain, numbness, or tingling in your hands, wrists, elbows, shoulders, neck or back, please consult a qualified medical doctor immediately.

MAINTENANCE AND USE

The Razer Pro Click Mini requires minimum maintenance to keep it in optimum condition. Once a month we recommend you unplug the device from the computer and clean it using a soft cloth or cotton swab to prevent dirt buildup. Do not use soap or harsh cleaning agents.

To get the ultimate experience in movement and control, we highly recommend a premium mouse mat from Razer. Some surfaces will cause undue wear on the feet requiring constant care and eventual replacement.

Do note that the sensor of the Razer Pro Click Mini is 'tuned' or optimized especially for the Razer mouse mats. This means that the sensor has been tested extensively to confirm that the Razer Pro Click Mini reads and tracks best on Razer mouse mats.

7. LEGALESE

COPYRIGHT AND INTELLECTUAL PROPERTY INFORMATION

©2021 Razer Inc. All rights reserved. Razer, the triple-headed snake logo, Razer logo, “For Gamers. By Gamers.” and “Razer Chroma” are trademarks or registered trademarks of Razer Inc. and/or affiliated companies in the United States and other countries. Actual product may differ from pictures. All other trademarks are the property of their respective owners. Warranty not valid outside of product’s intended region.

The Bluetooth® word mark and logos are registered trademarks owned by Bluetooth SIG, Inc., and any use of such marks by Razer is under license.

Windows and the Windows logo are trademarks of the Microsoft group of companies.

Razer Inc. (“Razer”) may have copyright, trademarks, trade secrets, patents, patent applications, or other intellectual property rights (whether registered or unregistered) concerning the product in this guide. Furnishing of this guide does not give you a license to any such copyright, trademark, patent or other intellectual property right. The Razer Pro Click Mini (the “Product”) may differ from pictures whether on packaging or otherwise. Razer assumes no responsibility for such differences or for any errors that may appear. Information contained herein is subject to change without notice.

LIMITED PRODUCT WARRANTY

For the latest and current terms of the Limited Product Warranty, please visit [razer.com/warranty](https://www.razer.com/warranty).

LIMITATION OF LIABILITY

Razer shall in no event be liable for any lost profits, loss of information or data, special, incidental, indirect, punitive or consequential or incidental damages, arising in any way out of distribution of, sale of, resale of, use of, or inability to use the Product. In no event shall Razer’s liability exceed the retail purchase price of the Product.

GENERAL

These terms shall be governed by and construed under the laws of the jurisdiction in which the Product was purchased. If any term herein is held to be invalid or unenforceable, then such term (in so far as it is invalid or unenforceable) shall be given no effect and deemed to be excluded without invalidating any of the remaining terms. Razer reserves the right to amend any term at any time without notice.