

NEC

Desktop Monitor

MultiSync EA245WMi-2

User's Manual

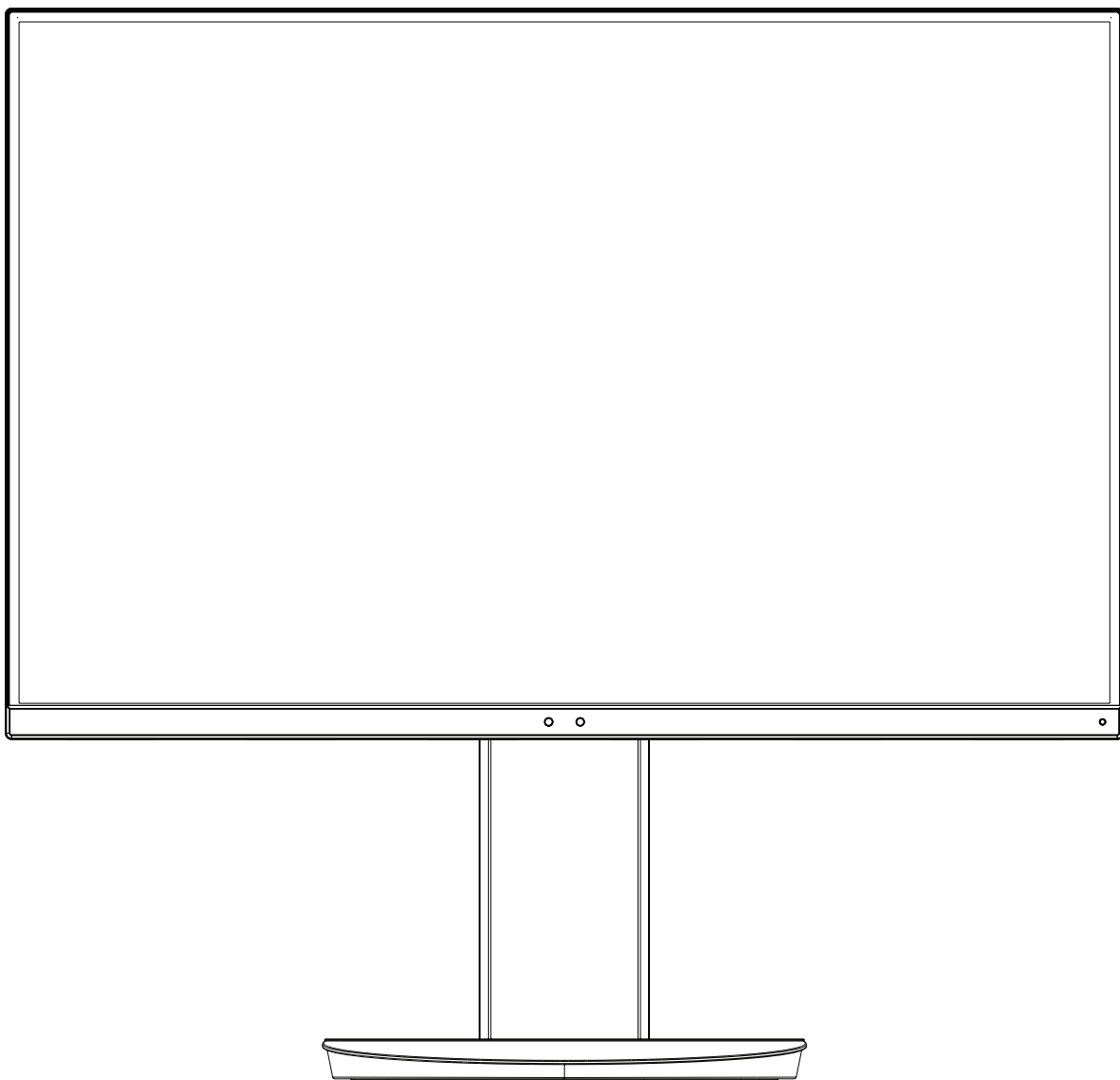

MODEL: EA245WMi, EA245WMi-BK

Please find your model name in the label on the backside of monitor.

Index

Warning, Caution.....	English-1
Registration Information	English-2
Recommended use	English-3
Safety Precautions and Maintenance	English-3
Ergonomics	English-4
Cleaning the LCD Panel.....	English-4
Cleaning the Cabinet.....	English-4
Quick Start.....	English-5
ControlSync.....	English-10
Multiple monitors connection using DisplayPort.....	English-11
Recovering from no image	English-12
Controls	English-13
Specifications	English-20
Features	English-21
Troubleshooting.....	English-22
Using the Zoom Function	English-24
Human sensing function.....	English-25
Using the Auto Brightness function	English-26
Manufacturer's Recycling and Energy Information.....	English-27

The model name is on the label.

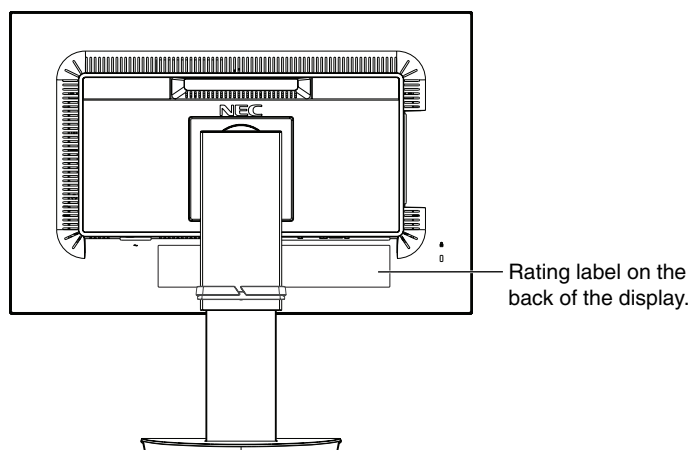

WARNING

⚡ TO PREVENT FIRE OR SHOCK HAZARDS, DO NOT EXPOSE THIS UNIT TO RAIN OR MOISTURE. ALSO, DO NOT USE THIS UNIT'S POLARIZED PLUG WITH AN EXTENSION CORD RECEPTACLE OR OTHER OUTLETS UNLESS THE PRONGS CAN BE FULLY INSERTED.

⚠ REFRAIN FROM OPENING THE CABINET AS THERE ARE HIGH VOLTAGE COMPONENTS INSIDE. REFER SERVICING TO QUALIFIED SERVICE PERSONNEL.

CAUTION

⚡ CAUTION: TO REDUCE THE RISK OF ELECTRIC SHOCK, MAKE SURE POWER CORD IS UNPLUGGED FROM WALL SOCKET. TO FULLY DISENGAGE THE POWER TO THE UNIT, PLEASE DISCONNECT THE POWER CORD FROM THE AC OUTLET. DO NOT REMOVE COVER (OR BACK). NO USER SERVICEABLE PARTS INSIDE. REFER SERVICING TO QUALIFIED SERVICE PERSONNEL.

⚡ This symbol warns user that uninsulated voltage within the unit may have sufficient magnitude to cause electric shock. Therefore, it is dangerous to make any kind of contact with any part inside this unit.

⚠ This symbol alerts the user that important literature concerning the operation and maintenance of this unit has been included. Therefore, it should be read carefully in order to avoid any problems.

CAUTION: Please use the power cord provided with this display in accordance with the table below. If a power cord is not supplied with this equipment, please contact your supplier. For all other cases, please use a power cord that matches the AC voltage of the power outlet and has been approved by and complies with the safety standard of your particular country.

This equipment is designed to be used in the condition of the power cord connected to earth. If the power cord is not connected to the earth, it may cause electric shock. Please make sure the power cord is earthed properly.

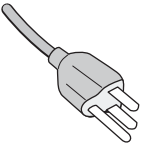
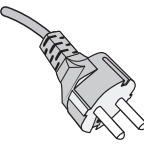
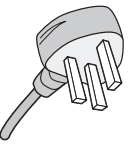
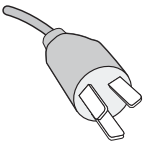
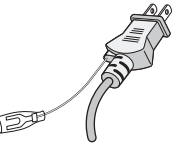
Plug Type	North America	European Continental	U.K.	Chinese	Japanese
Plug Shape					
Region	U.S.A./Canada	EU (except U.K.)	U.K.	China	Japan
Voltage	120*	230	230	220	100

*When operating the monitor with its AC 125-240V power supply, use a power supply cord that matches the power supply voltage of the AC power outlet being used.

NOTE: This product can only be serviced in the country where it was purchased.

Windows is a registered trademark of Microsoft Corporation. NEC is a registered trademark of NEC Corporation. ErgoDesign is a registered trademark of NEC Display Solutions, Ltd. in Austria, Benelux, Denmark, France, Germany, Italy, Norway, Spain, Sweden, U.K. All other brands and product names are trademarks or registered trademarks of their respective owners. DisplayPort and DisplayPort Compliance Logo are trademarks owned by Video Electronics Standards Association in the United States and other countries.



HDCP (High-bandwidth Digital Content Protection): HDCP is a system for preventing illegal copying of video data sent over a digital signal. If you are unable to view material via the digital signal input, this does not necessarily mean the display is not functioning properly. With the implementation of HDCP, there may be cases in which certain content is protected with HDCP and might not be displayed due to the decision/intention of the HDCP community (Digital Content Protection, LLC).

The terms HDMI and HDMI High-Definition Multimedia Interface, and the HDMI Logo are trademarks or registered trademarks of HDMI Licensing Administrator, Inc. in the United States and other countries.



- The intended primary use of this product is as an Information Technical Equipment in an office or domestic environment.
- The product is intended to be connected to a computer and is not intended for the display of television broadcast signals.



Registration Information

FCC Information

1. Use the attached specified cables with this monitor so as not to interfere with radio and television reception.
 - (1) The power supply cord you use must have been approved by and comply with the safety standards of U.S.A., and meet the following condition.

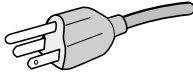
Power supply cord Plug shape	Non shield type, 3-conductor  U.S.A
---------------------------------	--

- (2) Please use the supplied shielded video signal cable.
Use of other cables and adapters may cause interference with radio and television reception.
2. This equipment has been tested and found to comply with the limits for a Class B digital device, pursuant to part 15 of the FCC Rules. These limits are designed to provide reasonable protection against harmful interference in a residential installation. This equipment generates, uses, and can radiate radio frequency energy, and, if not installed and used in accordance with the instructions, may cause harmful interference to radio communications. However, there is no guarantee that interference will not occur in a particular installation. If this equipment does cause harmful interference to radio or television reception, which can be determined by turning the equipment off and on, the user is encouraged to try to correct the interference by one or more of the following measures:
 - Reorient or relocate the receiving antenna.
 - Increase the separation between the equipment and receiver.
 - Connect the equipment into an outlet on a circuit different from that to which the receiver is connected.
 - Consult your dealer or an experienced radio/TV technician for help.

If necessary, the user should contact the dealer or an experienced radio/television technician for additional suggestions. The user may find the following booklet, prepared by the Federal Communications Commission, helpful: "How to Identify and Resolve Radio-TV Interference Problems." This booklet is available from the U.S. Government Printing Office, Washington, D.C., 20402, Stock No. 004-000-00345-4.

Declaration of Conformity

This device complies with Part 15 of FCC Rules. Operation is subject to the following two conditions. (1) This device may not cause harmful interference, and (2) this device must accept any interference received, including interference that may cause undesired operation.

U.S. Responsible Party:	NEC Display Solutions of America, Inc.
Address:	500 Park Boulevard, Suite 1100 Itasca, Illinois 60143
Tel. No.:	(630) 467-3000

Type of Product: Display Monitor
Equipment Classification: Class B Peripheral
Model: MultiSync EA245WMMi-2 (EA245WMMi, EA245WMMi-BK)



We hereby declare that the equipment specified above conforms to the technical standards as specified in the FCC Rules.

To see a list of our TCO certified monitors and their TCO Certification (in English only), visit our website at http://www.nec-display.com/global/about/legal_regulation/TCO_mn/index.html

Recommended use

Safety Precautions and Maintenance



FOR OPTIMUM PERFORMANCE, PLEASE NOTE
THE FOLLOWING WHEN SETTING UP AND
USING THE LCD COLOR MONITOR:



- **DO NOT OPEN THE MONITOR.** There are no user serviceable parts inside and opening or removing covers may expose you to dangerous shock hazards or other risks. Refer all servicing to qualified service personnel.
- Do not spill any liquids into the cabinet or use your monitor near water.
- Do not insert objects of any kind into the cabinet slots, as they may touch dangerous voltage points, which can be harmful or fatal or may cause electric shock, fire or equipment failure.
- Do not place any heavy objects on the power cord. Damage to the cord may cause shock or fire.
- Do not place this product on a sloping or unstable cart, stand or table, as the monitor may fall, causing serious damage to the monitor.
- The power supply cord you use must have been approved by and comply with the safety standards of your country. (Type H05VV-F 3G 0.75 mm² should be used in Europe).
- In UK, use a BS-approved power cord with molded plug having a black (5A) fuse installed for use with this monitor.
- Do not place any objects onto the monitor and do not use the monitor outdoors.
- Do not bend power cord.
- Do not use monitor in high temperature, humid, dusty, or oily areas.
- Do not cover vent on monitor.
- Vibration can damage the backlight. Do not install where the monitor will be exposed to continual vibration.
- If monitor or glass is broken, do not come in contact with the liquid crystal and handle with care.
- To prevent damage to the LCD monitor caused by tipping over due to earthquakes or other shocks, make sure to install the monitor in a stable location and take measures to prevent falling.

Immediately turn off the power, unplug your monitor from the wall outlet and move to a safe location then refer servicing to qualified service personnel under the following conditions. If the monitor is used in this condition, the monitor may cause fall, fire and electric shock:

- If the monitor stand has been cracked or peeled.
- If the monitor has been wobbled.
- If the monitor has an unusual odor.
- When the power supply cord or plug is damaged.
- If liquid has been spilled, or objects have fallen into the monitor.
- If the monitor has been exposed to rain or water.
- If the monitor has been dropped or the cabinet damaged.
- If the monitor does not operate normally by following operating instructions.



CAUTION

- Allow adequate ventilation around the monitor so that heat can properly dissipate. Do not block ventilated openings or place the monitor near a radiator or other heat sources. Do not put anything on top of monitor.
- The power cable connector is the primary means of detaching the system from the power supply. The monitor should be installed close to a power outlet which is easily accessible.
- Handle with care when transporting. Save packaging for transporting.
- Do not touch LCD panel surface while transporting, mounting and setting. Applying pressure on the LCD panel can cause serious damage.

Image Persistence: Image persistence is when a residual or “ghost” image of a previous image remains visible on the screen. Unlike CRT monitors, LCD monitors’ image persistence is not permanent, but constant images being displayed for a long period of time should be avoided.

To alleviate image persistence, turn off the monitor for as long as the previous image was displayed. For example, if an image was on the monitor for one hour and a residual image remains, the monitor should be turned off for one hour to erase the image.

NOTE: As with all personal display devices, NEC DISPLAY SOLUTIONS recommends using a moving screen saver at regular intervals whenever the screen is idle or turning off the monitor when not in use.



**CORRECT PLACEMENT AND ADJUSTMENT OF THE MONITOR CAN
REDUCE EYE, SHOULDER AND NECK FATIGUE. CHECK THE
FOLLOWING WHEN YOU POSITION THE MONITOR:**



- For optimum performance, allow 20 minutes for the display to warm up.
- Adjust the monitor height so that the top of the screen is at or slightly below eye level. Your eyes should look slightly downward when viewing the middle of the screen.
- Position your monitor no closer than 40 cm (15.75 inches) and no further away than 70 cm (27.56 inches) from your eyes. The optimal distance is 50 cm (19.69 inches).
- Rest your eyes periodically for 5 to 10 minutes for every 1 hour by focusing on an object at least 20 feet away.
- Position the monitor at a 90° angle to windows and other light sources to minimize glare and reflections. Adjust the monitor tilt so that ceiling lights do not reflect on your screen.
- If reflected light makes it hard for you to see your screen, use an anti-glare filter.
- Clean the LCD monitor surface with a lint-free, non-abrasive cloth. Avoid using any cleaning solution or glass cleaner!
- Adjust the monitor's brightness and contrast controls to enhance readability.
- Use a document holder placed close to the screen.
- Position whatever you are looking at most of the time (the screen or reference material) directly in front of you to minimize turning your head while you are typing.
- Avoid displaying fixed patterns on the monitor for long periods of time to avoid image persistence (after-image effects).
- Blink often. Eye exercise helps to reduce eye strain. Please contact your ophthalmologist. Get regular eye checkups.

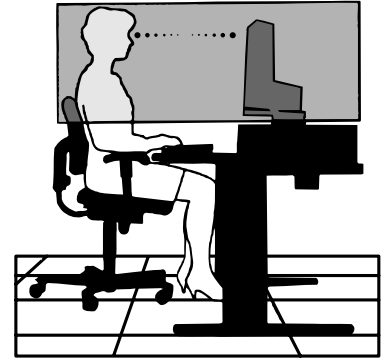

Ergonomics

To realize the maximum ergonomics benefits, we recommend the following:

- To avoid eye fatigue, adjust the brightness to a moderate setting. Place a sheet of white paper next to the LCD screen for luminance reference.
- Do not position the Contrast control to its maximum setting.
- Use the preset Size and Position controls with standard signals.
- Use the preset Color Setting.
- Use non-interlaced signals with a vertical refresh rate of 60 Hz.
- Do not use primary color blue on a dark background, as it is difficult to see and may produce eye fatigue due to insufficient contrast.
- Suitable for entertainment purposes at controlled luminous environments, to avoid disturbing reflections from the screen.

Cleaning the LCD Panel

- When the LCD is dusty, please gently wipe with a soft cloth.
- Please do not rub the LCD panel with hard or coarse material.
- Please do not apply pressure to the LCD surface.
- Please do not use OA cleaner as it will cause deterioration or discoloration on the LCD surface.

Cleaning the Cabinet

- Unplug the power supply
- Gently wipe the cabinet with a soft cloth
- To clean the cabinet, dampen the cloth with a neutral detergent and water, wipe the cabinet and follow with a dry cloth.

NOTE: Many plastics are used on the surface of the cabinet. DO NOT clean with benzene, thinner, alkaline detergent, alcoholic system detergent, glass cleaner, wax, polish cleaner, soap powder, or insecticide. Do not touch rubber or vinyl to the cabinet for a long time. These types of fluids and fabrics can cause the paint to deteriorate, crack or peel.

For more detailed information on setting up a healthy work environment, write to the American National Standard for Human Factors Engineering of Computer Workstations - ANSI/HFES 100-2007 - The Human Factors Society, Inc. P.O. Box 1369, Santa Monica, California 90406.

Quick Start

For contents, please refer to the contents sheet.

To attach the Base to the LCD stand:

1. Place monitor face down on a non-abrasive surface (**Figure 1**).
2. Please rotate the stand 90 degrees as shown in **Figure 1**.

NOTE: Handle with care when pulling the stand.

3. Attach the base to the stand and lock screw at the base's bottom (**Figure 2**).

NOTE: Reverse this procedure if you need to re-pack the monitor.

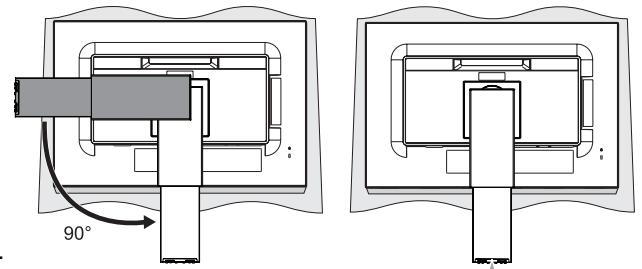

Figure 1

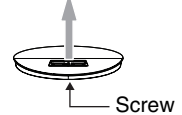

Figure 2

To connect the LCD monitor to your system, follow these instructions:

NOTE: Make sure to read "Recommended Use" (page 3) before installation.

The accessories included will depend on the where the LCD monitor is to be shipped.

1. Turn off the power of your computer.
2. **For a PC with DisplayPort output:** Connect the DisplayPort cable to the connector of the display card in your system (**Figure A.1**).

For a PC with HDMI output: Connect the HDMI cable to the connector of the display card in your system (**Figure A.2**).

For a PC with Analog output: Connect a 15-pin mini D-SUB signal cable to the connector of the display card in your system (**Figure A.3**).

For a MAC with Thunderbolt or Mini DisplayPort output: Connect a Mini DisplayPort to DisplayPort cable to a video connector in your system.

An alternative is to use an approved Mini DisplayPort to DisplayPort cable to connect the computer to the display (**Figure A.4**).

For a PC or MAC with DVI digital output: Connect the DVI signal cable to the connector of the display card in your system (**Figure A.5**). Tighten all screws.

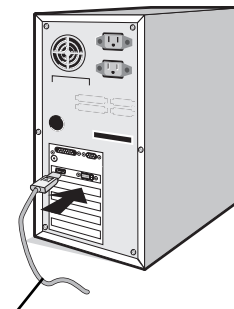

DisplayPort cable

Figure A.1

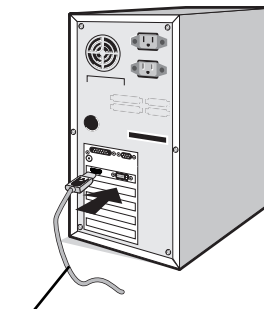

HDMI cable

Figure A.2

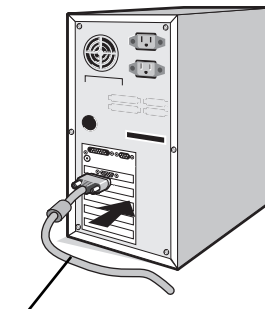

15-pin mini D-SUB signal cable

Figure A.3

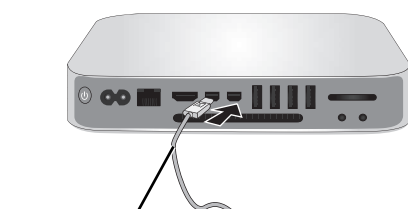

Mini DisplayPort to DisplayPort cable

Figure A.4

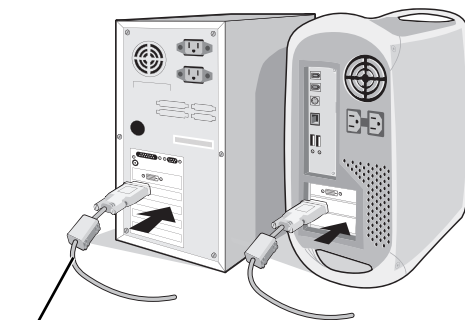

DVI cable

Figure A.5

- NOTE:**
1. When removing the DisplayPort cable, hold down the top button to release the lock.
 2. Please use a High Speed HDMI cable with HDMI logo.
 3. Please use a DisplayPort Certified DisplayPort cable.

- Place hands on each side of the monitor to tilt the LCD panel 35-degree angle and lift up to the highest position.
- Connect all cables to the appropriate connectors (**Figure C.1**). When using the USB cable, connect the B type connector to the USB upstream port on the right back side of the monitor and the A type connector to the downstream port on the computer (**Figure C.1a**). If using the cord from a USB device, plug into the downstream port of the monitor.

NOTE: Incorrect cable connections may cause abnormal operation, damage display quality/components of LCD module and/or shorten the module's life.

NOTE: Use an audio cable without a built-in resistor. Using an audio cable with a built-in resistor turns down the sound.

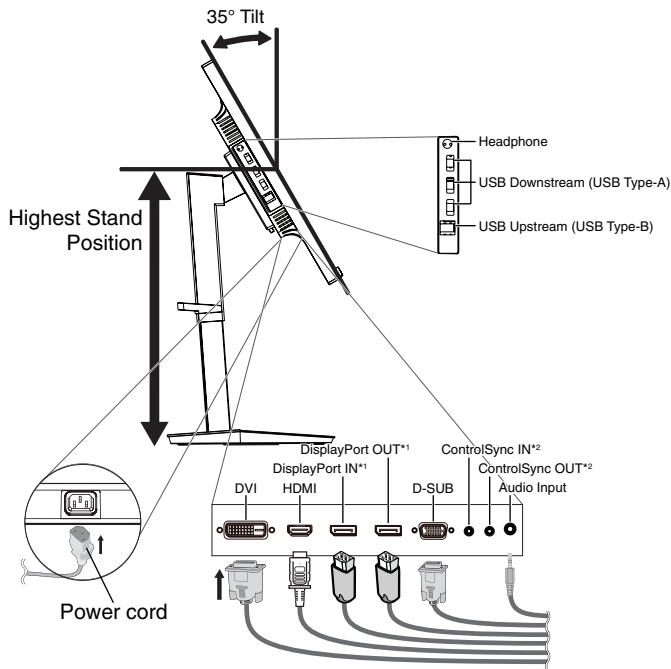

Figure C.1

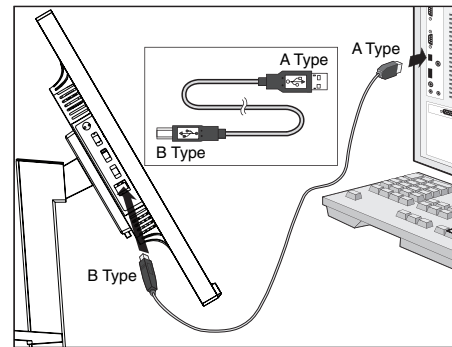

Figure C.1a

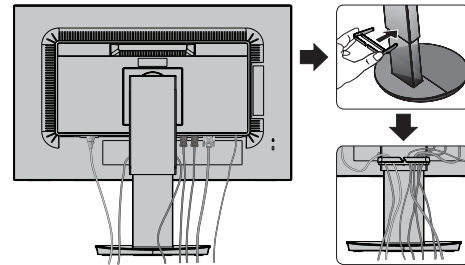

Figure C.2

*1: See page 10.

*2: See page 11.

NOTE: Adjustment of the volume control as well as the equalizer to other settings than the center position may increase the ear-/headphones output voltage and therefore the sound pressure level.

- Place the cable holder onto the stand (**Figure C.2**).
Place the cables in the cable holder firmly and evenly (**Figure C.3** and **Figure C.4**).
- Please check that you can still rotate, raise and lower the monitor screen after you have installed the cables.

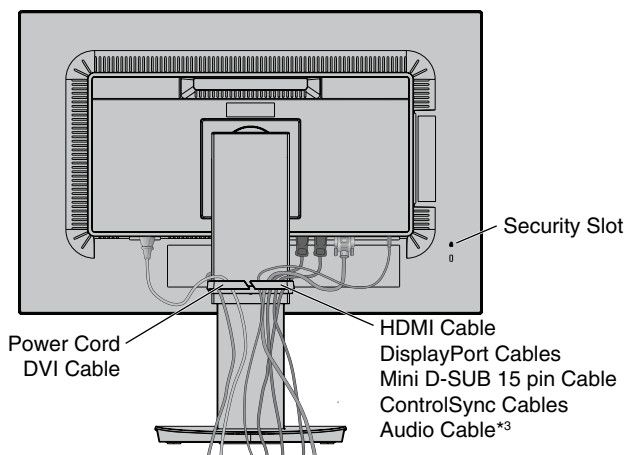

Figure C.3

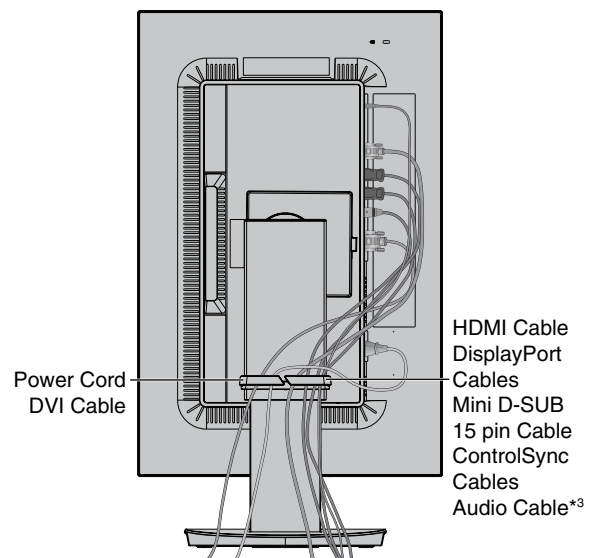

Figure C.4

*3: ø 3.5 stereo mini plug.

7. Connect one end of the power cord to the AC inlet on the back of the monitor and the other end to the power outlet.

NOTE: Please refer to Caution section of this manual for proper selection of AC power cord.

8. Turn on the computer and the monitor by touching the power key on the front bezel (**Figure E.1**).

9. No Touch Auto Adjust automatically adjusts the monitor to optimal settings upon initial setup. For further adjustments, use the following OSD controls:

- AUTO CONTRAST (Analog input only)
- AUTO ADJUST (Analog input only)

Refer to the **Controls** section of this User's Manual for a full description of these OSD controls.

NOTE: If you have any problems, please refer to the **Troubleshooting** section of this User's Manual.

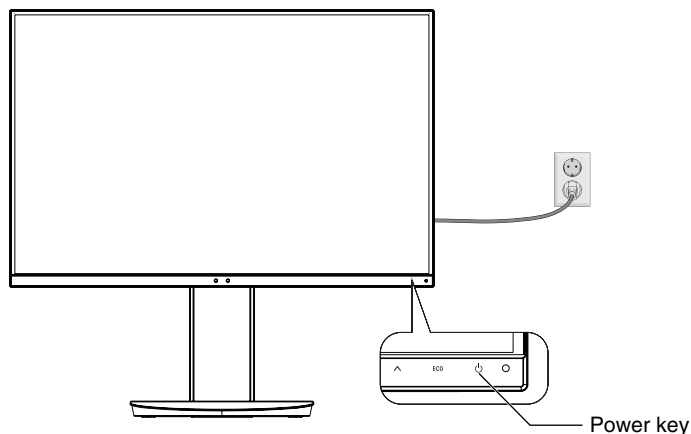

Figure E.1

Raise and Lower Monitor Screen

The monitor may be raised or lowered in either portrait or landscape mode.

To raise or lower screen, place a hand on each side of the monitor and lift or lower to the desired height (**Figure RL.1**).

NOTE: Handle with care when raising or lowering the monitor screen.

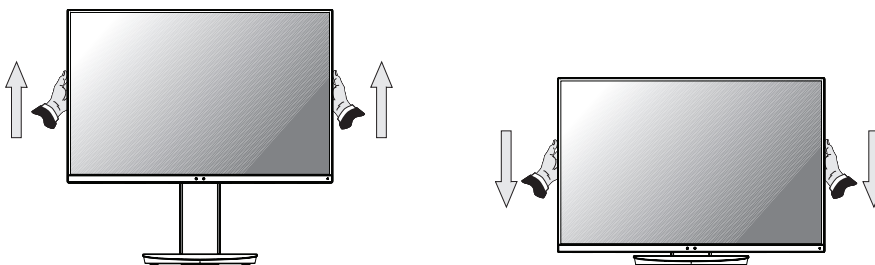

Figure RL.1

Screen Rotation

Before rotating, disconnect power cord and all cables, then the screen must be raised to the highest level and tilt to avoid knocking the screen on the desk or pinching your fingers.

To raise the screen, place a hand on each side of the monitor and lift up to the highest position (**Figure RL.1**).

To rotate screen, place a hand on each side of the monitor screen and turn it from landscape to portrait (**Figure R.1**).

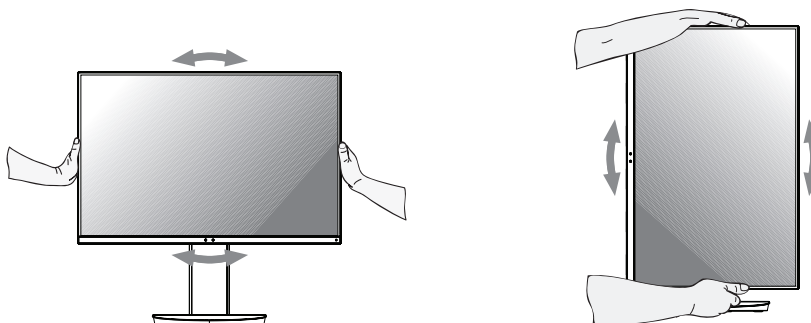

Figure R.1

Tilt and Swivel

Grasp the top and bottom sides of the monitor screen with your hands and adjust the tilt and swivel as desired (**Figure TS.1**).

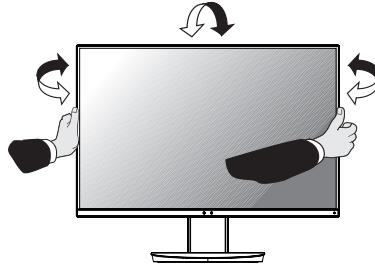

Figure TS.1

NOTE: Handle with care when tilting the monitor screen.

Flexible Arm Installation

This LCD monitor is designed for use with a flexible arm.

To prepare the monitor for alternate mounting purposes:

- Follow the instructions provided by the manufacturer of the display mount.
 - To meet the safety requirements, the mounting stand must be able to support the weight of the monitor and be UL-certified.
- * Contact your dealer for more information.

Remove Monitor Stand for Mounting

To prepare the monitor for alternate mounting purposes:

1. Disconnect all cables.
2. Place hands on each side of the monitor and lift up to the highest position.
3. Place monitor face down on a non-abrasive surface (**Figure S.1**).
4. Place one hand around the base and one hand on the Quick Release Lever. Push and hold the Quick Release Lever in the direction indicated by the arrows (**Figure S.1**).
5. Lift up the stand to unhook it from the monitor (**Figure S.1**).
The monitor can now be mounted using an alternate method.
Reverse the process to reattach stand.

NOTE: Handle with care when removing monitor stand.

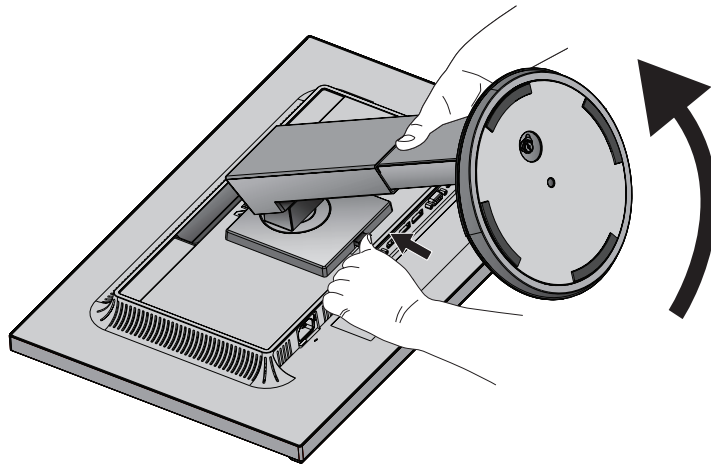

Figure S.1

Mount Flexible arm

This LCD monitor is designed for use with a flexible arm.

1. Follow the instructions on how to Remove Monitor Stand for Mounting.
2. Using the specified 4 screws, attach the arm to the monitor (**Figure F.1**).

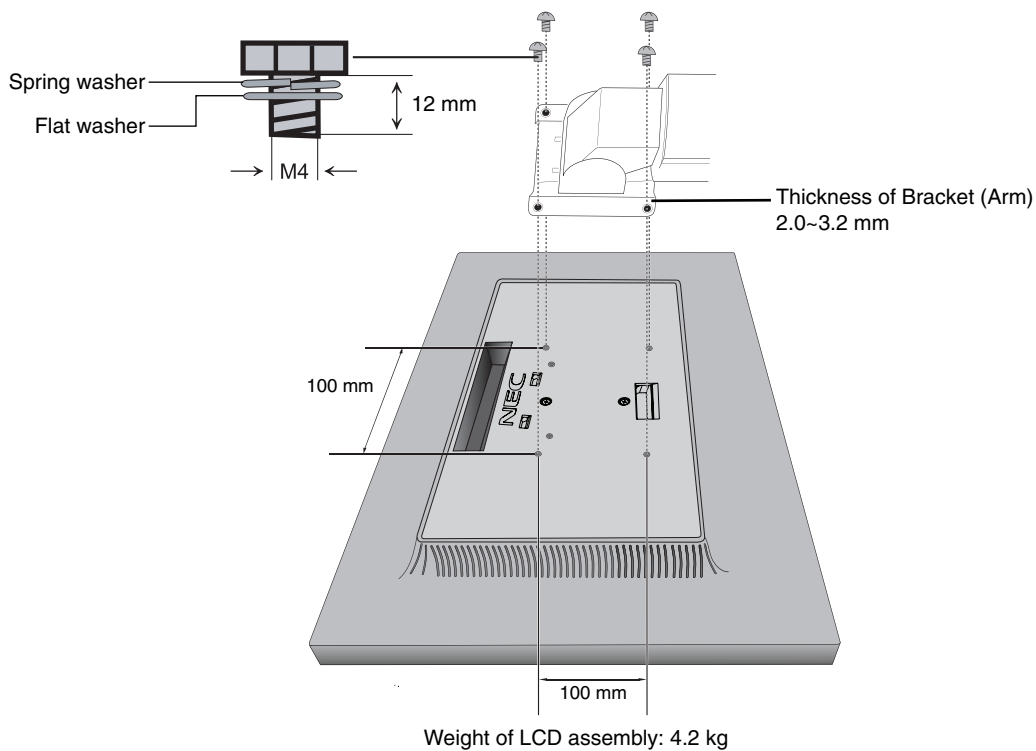

Figure F.1

Caution: Use ONLY 4 M4 sized screws when mounting to avoid damage to the monitor and stand. To fulfill the safety requirements the monitor must be mounted to an arm which guarantees the necessary stability under consideration of the weight of the monitor. The LCD monitor should only be used with an approved arm (e.g. TUEV GS mark).

NOTE: Tighten all screws (recommended Fasten Force: 98 - 137N•cm).

ControlSync

1. Connect the master monitor with a sub monitor via a ControlSync cable (ø 2.5) into ControlSync IN/OUT.
2. Follow the steps of DATA COPY. When the setting of the master monitor is adjusted, it will be copied and sent to the connected sub monitor(s) automatically.
3. Up to 24 sub monitors can be daisy-chained via ControlSync.

NOTE: Connect the master monitor via ControlSync OUT connector.
 The ControlSync icon will appear on the upper left of the OSD menu in the sub monitor.
 Do not connect IN-IN or OUT-OUT.
 Do not make "loop" connection.
 Once the monitors are connected, turn the master monitor's power key off and on to check if ControlSync operates correctly.
 If connecting monitors with DisplayPort cables, please make sure the monitor which is connected to a computer is the master monitor.

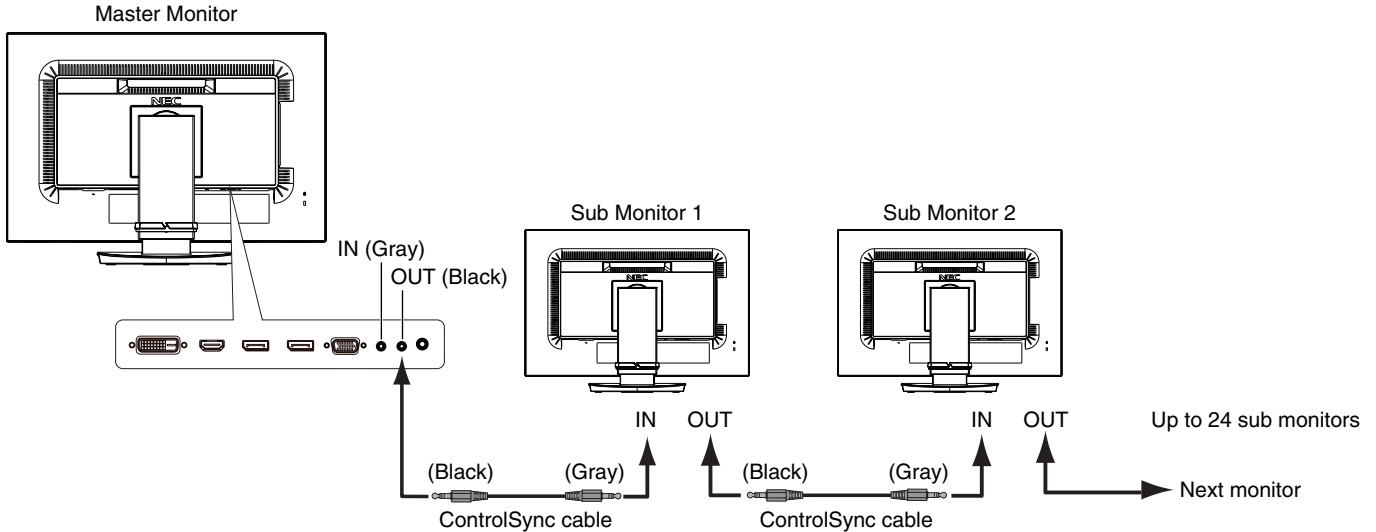
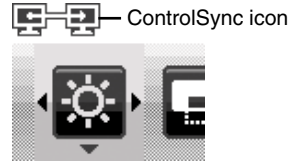

The following settings can be controlled by ControlSync:

ECO TOOLS	BRIGHTNESS*	Yes	TOOLS	VOLUME	Yes
	CONTRAST	No		SOUND INPUT	No
	ECO MODE	Yes		VIDEO DETECT	No
	AUTO BRIGHTNESS	Yes		DP OUT MULTISTREAM	No
	BLACK LEVEL	No		RESPONSE IMPROVE	No
	OFF MODE SETTING	Yes		OFF TIMER	Yes
	OFF MODE SENSOR SETTING	Yes		POWER SAVE TIMER	No
	OFF MODE START TIME	Yes		LED BRIGHTNESS	Yes
	HUMAN SENSING	Yes		DDC/CI	Yes
	HUMAN SENSOR SETTING	Yes		USB POWER	No
	HUMAN SENSOR START TIME	Yes		180° ROTATE	No
	DV MODE	Yes		FACTORY PRESET	No
	SCREEN	AUTO ADJUST		No	MENU TOOLS
AUTO CONTRAST		No	OSD TURN OFF	Yes	
LEFT/RIGHT		No	OSD LOCK OUT	Yes	
DOWN/UP		No	HOT KEY	Yes	
H.SIZE		No	SIGNAL INFORMATION	Yes	
FINE		No	SENSOR INFORMATION	Yes	
INPUT RESOLUTION		No	KEY GUIDE	Yes	
H.RESOLUTION		No	DATA COPY	No	
V.RESOLUTION		No	CUSTOMIZE SETTING	No	
VIDEO LEVEL		No	ECO INFORMATION	CARBON SAVINGS	No
OVER SCAN		No		CARBON USAGE	No
EXPANSION		Yes		COST SAVINGS	No
UNIFORMITY		No		CARBON CONVERT SETTING	Yes
COLOR	Color Control System	Yes		CURRENCY SETTING	Yes
	R, G, B, color gain	No		CURRENCY CONVERT SETTING	Yes

Other settings:

- Power Control (DC switch)
- Ambient Light Sensor
- Human Sensor Result
- Audio Mute

NOTE: Only the master monitor's human sensor and ambient light sensor are active. Please do not cover these sensors.
 Turn the monitor's power off before connecting/disconnecting the ControlSync cable.
 Do not use the ControlSync connectors for any purpose other than specified.

* This value is not a directly adjusted output value. This is adjusted relatively.

Multiple monitors connection using DisplayPort

You can connect multiple monitors by using DisplayPort daisy-chain connection.
 For using as multiple monitors in MST (multi-stream transport) mode, setting should be DP OUT MULTISTREAM "AUTO" at each connected monitor. Please change the monitor setting which is connected to a computer last in the connected monitors.
 If monitors have no image, turn off the monitor who is connected to a computer then turn it on.
 Some DisplayPort configuration may be required. Please refer below and set as required.

OSD (See page 17)	
DP OUT MULTISTREAM "CLONE"	Factory setting. DisplayPort 1.1a setting with: – SST (single-stream transport).
DP OUT MULTISTREAM "AUTO"	DisplayPort 1.2 setting with: – SST (single-stream transport) and MST (multi-stream transport).

Depending on the setting of computer operation system, image does not extend.
 Please check your computer setting.

NOTE: Monitors should be connected by the included DisplayPort cable.
 Using the same display model is strongly recommended for connecting multiple monitors.
 Please contact your display card supplier for detailed information.

	BIT RATE	Maximum number of connectable monitors
MST (multi-stream transport)	HBR2 (Default setting)	4 units (HDCP contents: 4 units)
	HBR	2 units (HDCP contents: 2 units)

NOTE: The number of monitors daisy-chained depends on display card and various factors.

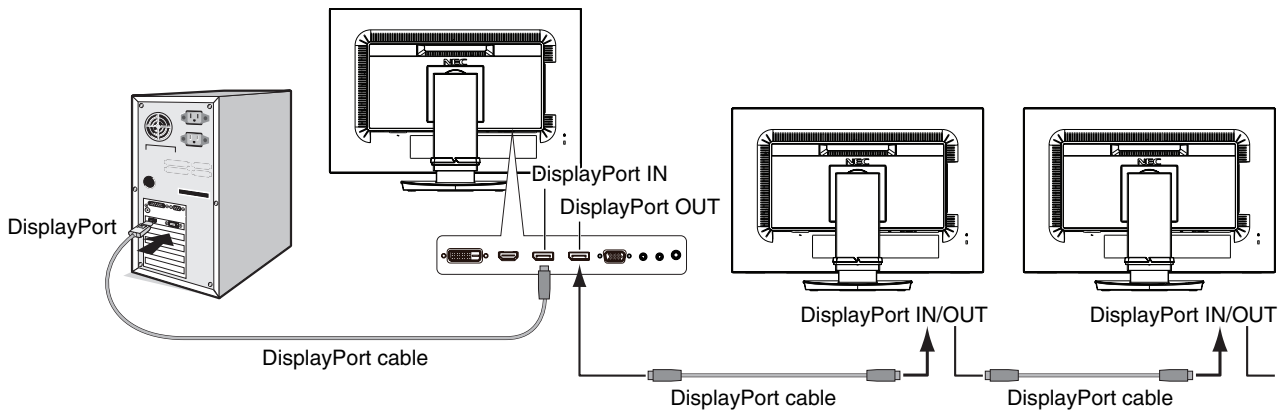

NOTE: When the monitor has no image, follow the troubleshooting step **Recovering from no image** and select DP VER "1.1" (see page 12). Then set from the first step.
 When this MST function is selected, the power management function according to the ErP directive doesn't work.

Recovering from no image

If monitors have no image after setting DP OUT MULTISTREAM, please set as follows:

1. Turn off the computer.
2. Touch the "MENU" key to show the No Signal OSD menu.
3. Touch the "∧" key to show VIDEO INPUT menu.
4. Touch "∧" or "∨" to show to set the DisplayPort switch menu.
5. Select DP VER "1.1" to switch the DisplayPort setting.
6. Touch MENU to close the OSD menu.
7. Turn on the computer.

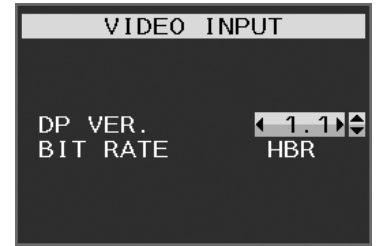

NOTE: MST (multi-stream transport) and SST (single-stream transport) requires the corresponding display card. Check to make sure that the display card supports MST (multi-stream transport). Contact your supplier for detailed information.

NOTE: Monitors should be connected by the included DisplayPort cable.

Controls

OSD (On-Screen Display) control keys on the front of the monitor function are as follows:

To access OSD menu, touch any of the control keys.

To change signal input, touch the SELECT key.

NOTE: Exit OSD in order to change signal input.

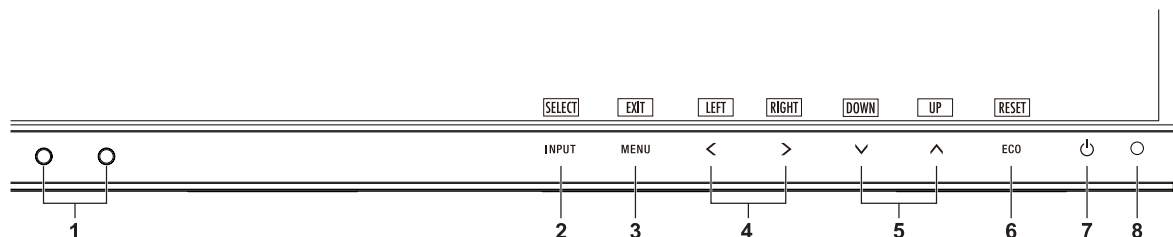

1 Ambient Light Sensor Human Sensor	Detects the level of ambient lighting and the presence of a user, allowing the monitor to make adjustments to various settings resulting in a more comfortable viewing experience. Do not cover this sensor.
2 INPUT/SELECT	Enters the OSD menu. Enters OSD sub menus. Changes the input source when not in the OSD menu. You can directly change to L/B (LOW BLUE LIGHT) mode by touching the INPUT key for 3 seconds or more.
3 MENU/EXIT	Accesses OSD menu. Exits the OSD sub menu. Exits OSD menu.
4 LEFT/RIGHT	Navigates to the left or right through the OSD menu.
5 UP/DOWN	Navigates up or down through the OSD menu. You can adjust the BRIGHTNESS directly by touching UP while the OSD menu is off.* ¹ You can adjust the VOLUME directly by touching DOWN while the OSD menu is off.* ¹
6 ECO/RESET	Resets the OSD controls back to factory settings. Switches among ECO MODE settings. Activates the Auto Adjust function if held for 3 seconds while the OSD menu is off (analog input only)* ¹ .
7 Power	Turns the monitor on and off.
8 Power LED	Indicates that the power is on or off.

*¹ When Hot Key function is OFF, this function is disabled.



ECO TOOLS

BRIGHTNESS

Adjusts the overall image and background screen brightness.

If ECO MODE is set to 1 or 2, a bar for CARBON FOOTPRINT will appear.

CONTRAST

Adjusts the overall image and background screen brightness by input signal level.

NOTE: CONTRAST and DV MODE can be adjusted when other than L/B is selected for COLOR CONTROL.

ECO MODE

Decreases the amount of power consumption by reducing the brightness level.

OFF: No function.

1: Sets brightness variable range from 0% to 60%.

This setting can adjust brightness to a range in which power is reduced by 20% compared to the maximum brightness setting.

2: Sets brightness variable range from 0% to 30%.

This setting can adjust brightness to a range in which power is reduced by 35% compared to the maximum brightness setting.

When this function is set to ON, a CARBON FOOTPRINT bar will appear alongside the brightness adjustment bar.

NOTE: This function is disabled when DV MODE is set to DYNAMIC.

This function is disabled when Color Control System is set to DICOM SIM.

To enter the ECO MODE, touch ECO.

If you touch ECO, the setting changes [1] → [2] → [OFF] → [1].

AUTO BRIGHTNESS

OFF: No function.

ON (AMBIENT LIGHT): Automatically adjusts the brightness to the optimal setting by detecting the brightness level of the environment*1.

*1: Please refer to page 26 for full "Auto Brightness" information.

NOTE: This function is disabled when DV MODE is set to DYNAMIC.

This function is disabled when Color Control System is set to DICOM SIM.

BLACK LEVEL

Adjusts the black level.

OFF MODE SETTING

The Intelligent Power Manager allows the monitor to enter into power saving mode after a period of inactivity.

The OFF MODE has two settings:

OFF: Monitor enters into power saving mode automatically when the input signal is lost.

ON: Monitor enters into power saving mode automatically when the amount of surrounding light goes below the level determined by you. The level can be adjusted in OFF MODE sensor setting.

When in power saving mode, the LED on the front of the monitor becomes dark blue. When in power saving mode, touch any of the front keys, except for POWER and INPUT, to return to normal.

When the amount of surrounding light returns to normal levels, the monitor will automatically return to normal mode.

SENSOR SETTING (OFF MODE SETTING)

Adjusts threshold level of ambient light sensor for detected dark condition and shows current sensor measurement result.

START TIME (OFF MODE SETTING)

Adjusts wait time to enter into to a lower power consumption level when ambient light sensor detects dark condition.

HUMAN SENSING

The sensor detects the movement of a person by using the HUMAN SENSING function. The HUMAN SENSING has three settings:

OFF: No human sensing.

1 (LIGHT): After it is detected that there is no person after a period of time, the monitor shifts to low brightness mode automatically to reduce the power consumption. When a person comes near the monitor again, the monitor will automatically return to normal mode. START TIME adjusts the wait time to react.

2 (DEEP): After it is detected that there is no person, the monitor shifts to power saving mode automatically to reduce the power consumption. When a person comes near the monitor again, it resumes from the power saving mode.

NOTE: Detects a person within about 1.5 m from the monitor.

SENSOR SETTING (HUMAN SENSING)

Adjusts the threshold level of human sensing.

When the human icon is located on the right side of the white color bar or vermilion color wave, a person is not detected.

NOTE: Once the OSD has been closed, Human sensor starts to work.

START TIME (HUMAN SENSING)

Adjusts the wait time of entering to low brightness mode or power saving mode when Human Sensor detects no person.

DV MODE

Dynamic Visual Mode allows you to select from the following settings:

STANDARD: Standard setting.

TEXT: Setting that makes letters and lines crisp; best suited for basic word processing and spreadsheets.

MOVIE: Setting that boosts dark tones; best suited for movies.

GAMING: Setting that boosts whole tones; best suited for games that use vivid and colorful images.

PHOTO: Setting that optimizes contrast; best suited for still images.

DYNAMIC: Setting that adjusts the brightness by detecting the screen's black areas and optimizes it.

NOTE: This function is disabled when Color Control System is set to L/B, PROGRAMMABLE or DICOM SIM. STANDARD is used for TCO Certificate compliance.



SCREEN

AUTO ADJUST (Analog input only)

Automatically adjusts the image position, H. Size and Fine settings.

AUTO CONTRAST (Analog input only)

Adjusts the image displayed for non-standard video inputs.

LEFT / RIGHT

Controls horizontal image position within the display area of the LCD.

DOWN / UP

Controls vertical image position within the display area of the LCD.

H.SIZE (Analog input only)

Adjusts the horizontal size by increasing or decreasing this setting.

If the "AUTO Adjust" function does not give you a satisfactory picture setting, a further tuning can be performed by using the "H.SIZE" function (dot clock). For this a Moiré test pattern could be used. This function may alter the width of the picture. Use LEFT/RIGHT key to center the image on the screen. If the H.SIZE is wrongly calibrated, the result would look like the left drawing. The image should be homogeneous.



FINE (Analog input only)

Improves focus, clarity and image stability by increasing or decreasing this setting.

If the "Auto Adjust" function and the "H.SIZE" function do not give you a satisfactory picture setting, a fine tuning can be performed by using the "FINE" function.

For this a Moiré test pattern could be used. If the Fine value is wrongly calibrated, the result would look like the left drawing. The image should be homogeneous.

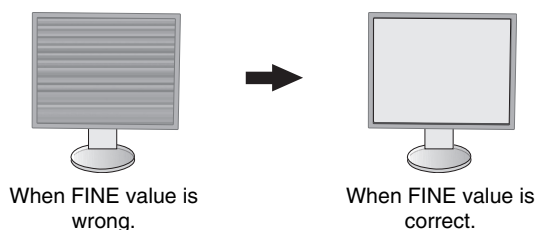

INPUT RESOLUTION (Analog input only)

Selects one of the following pair of resolutions as the input signal priority:

1360 x 768 or 1280 x 768 or 1024 x 768 (vertical resolution 768),

1600 x 900 or 1280 x 960 (horizontal frequency 60kHz),

1680 x 1050 or 1400 x 1050 (vertical resolution 1050).

H.RESOLUTION (Digital input only)

Adjusts the horizontal size by increasing or decreasing the resolution.

Touch the "RIGHT" key to reduce the width of the image on the screen.

Touch the "LEFT" key to expand the width of the image on the screen.

NOTE: When this function may not work, reduce the H.RESOLUTION level.

V.RESOLUTION (Digital input only)

Adjusts the vertical size by increasing or decreasing the resolution.

Touch the "RIGHT" key to reduce the height of the image on the screen.

Touch the "LEFT" key to expand the height of the image on the screen.

NOTE: When this function may not work, reduce the V.RESOLUTION level.

VIDEO LEVEL (HDMI input only)

NORMAL: For computer setting. Displays all input signals of 0-255 steps.

EXPAND: For audio-visual equipment setting. Expands input signals of 16-235 steps to 0-255 steps.

OVER SCAN (HDMI input only)

Some video formats may require different scanning modes in order to best display the image.

ON: Image size is larger than what can be displayed. The image edge will appear cropped. Approximately 95% of the image will be shown on the screen.

OFF: Image size stays within the display area. The whole image is displayed on the screen.

EXPANSION

Sets the Zoom method.

FULL: The image is expanded to full screen regardless of the resolution.

ASPECT: The image is expanded without changing the aspect ratio.

OFF: The image is not expanded.

UNIFORMITY

This function electronically compensates for the slight variations in the white uniformity level as well as for deviations in color that may occur throughout the display area of the screen. These variations are characteristic of LCD panel technology. This function improves the color and evens out the luminance uniformity of the display.

NOTE: Using the UNIFORMITY feature does reduce the overall peak luminance of the display. If greater luminance is desired over the uniform performance of the display, then UNIFORMITY should be turned off. "ON" produces a better effect, but may also reduce contrast ratio.



Color

Color Control System: Color presets are available for adjusting color settings. (sRGB and NATIVE color presets are standard and cannot be changed).

1, 2, 3, sRGB, 5: Increases or decreases Red, Green or Blue color depending upon which is selected. The change in color will appear on screen and the direction (increase or decrease) will be shown by the bars. sRGB mode dramatically improves the color fidelity in the desktop environment by a single standard RGB color space. With this color-supported environment, the operator could easily and confidently communicate color without further color management overhead in most common situations.

NATIVE: Original color presented by the LCD panel that is unadjustable.

L/B (LOW BLUE LIGHT): Reduces blue light emitted from monitor.

NOTE: You can directly change to L/B (LOW BLUE LIGHT) mode by touching the SELECT key for 3 seconds or more. For changing to other settings from L/B mode, touch the INPUT key to show OSD menu and enter COLOR control.

When L/B is selected in COLOR control, CONTRAST and DV MODE are disabled.

DICOM SIM.: The white point color temperature and the gamma curve are set to a DICOM simulation.

PROGRAMMABLE: The gamma curve is adjustable through application software.

NOTE: When MOVIE, GAMING, or PHOTO is selected as the DV MODE, NATIVE is selected automatically and cannot be changed.



Tools

VOLUME

Controls the volume of the speakers or headphones.

To mute the speaker output, touch the “ECO/RESET” key.

SOUND INPUT (HDMI, DisplayPort inputs only)

This function selects Audio Input, HDMI or DisplayPort.

VIDEO DETECT

Selects the method of video detection when more than one video inputs are connected.

FIRST: When current video input signal is not present, then the monitor searches for a video signal from the other video input ports. If the video signal is present in another port, then the monitor switches the video source input port to the new found video source automatically. The monitor will not look for other video signals while the current video source is present.

NONE: The monitor will not search the other video input port unless it is turned on.

DP OUT MULTISTREAM

Selects DisplayPort mode.

CLONE: Sets SST (single-stream transport). Default is “CLONE”.

If multiple monitors are set to MST (multi-stream transport), same image is displayed at each monitor.

AUTO: Displays in SST (single-stream transport) or MST (multi-stream transport) mode. “AUTO” should be selected when using MST (multi-stream transport).*

If multiple monitors are set to SST (single-stream transport), individual image is displayed at each monitor.

NOTE: When the monitor has no image, refer to **Multiple monitors connection using DisplayPort** (see page 11).

*: MST (multi-stream transport) and SST (single-stream transport) require the corresponding display card. Contact your dealer for limitations of this function.

RESPONSE IMPROVE

Turns the Response Improve function on or off. Response Improve may reduce blurring that occurs in some moving images.

OFF TIMER

Monitor will automatically power down when you have selected a pre-determined amount of time.

Before powering off, a message will appear on the screen asking if you want to delay the turn off time by 60 minutes.

Touch any OSD key to delay the power-down time.

POWER SAVE TIMER

POWER SAVE TIMER allows the monitor to turn off automatically after continuing power saving mode for 2 hours.

LED BRIGHTNESS

You can adjust the blue LED brightness.

DDC/CI

This function allows the DDC/CI function ON or OFF.

USB POWER

Selects a power relation of USB.

AUTO: Power is supplied to USB downstream port depending on related power condition.

ON: Power is always supplied to USB downstream port even when in power save mode or power OFF.

NOTE: Power consumption depends on connected USB even when a monitor's power is off.

180° ROTATE

Select to display the image for 0° or 180°.

FACTORY PRESET

Selecting Factory Preset allows you to reset all OSD control settings back to the factory settings except Language and OSD Lock Out. Individual settings can be reset by touching the "ECO/RESET" key.



MENU Tools

LANGUAGE

Selects the language used by the OSD.

OSD TURN OFF

The OSD menu will stay on as long as it is in use. You can select how long the monitor waits after the last key touch to shut off the OSD menu. The preset choices are 10-120 seconds by 5-second increments.

OSD LOCK OUT

This control completely locks out the access to all OSD control functions except for Brightness, Contrast and Volume.

To activate the OSD Lock Out function, enter the OSD menu, select OSD LOCK OUT, then touch "SELECT" and RIGHT simultaneously. To deactivate, touch "SELECT" and LEFT simultaneously.

HOT KEY

When this function is activated BRIGHTNESS and VOLUME can be adjusted without entering the OSD menu by using the front keys.

ON: The "ECO" touch key on the bezel is enabled and can toggle among ECO settings. The Up/Down key adjusts the VOLUME and the BRIGHTNESS level.

OFF: The HOT KEY function for "ECO" and "Up/Down" functions are disabled.

SIGNAL INFORMATION

If you select "ON", monitor displays "VIDEO INPUT MENU" after changing the input.

If you select "OFF", monitor doesn't display "VIDEO INPUT MENU" after changing the input.

SENSOR INFORMATION

If you select "ON", monitor displays "HUMAN SENSOR ON" message. If you select "OFF", monitor doesn't display "HUMAN SENSOR ON" message.

KEY GUIDE

If you select "ON", the Key Guide appears on screen when the OSD menu is accessed.

DATA COPY

To initiate data copy from the master monitor to the sub monitor(s), select "DATA COPY" and touch "SELECT". A "PROCEEDING..." indicator will appear on the screen.

NOTE: This function is only intended for the master monitor in ControlSync.

All of the settings specified in the ControlSync chart (see page 10) will be copied from the master monitor to the sub monitor(s).

CUSTOMIZE SETTING

Store the current settings for easy recovery.

To store current settings: Touch "SELECT". After a warning message appears, touch "RESET", current settings are stored.

To restore settings: Hold "MENU" for 3 seconds or more while the OSD menu is off.



ECO Information

CARBON SAVINGS: Displays the estimated carbon savings information in kg.

CARBON USAGE: Displays the estimated carbon usages information in kg. This is the arithmetic estimation, not actual measurement value.

COST SAVINGS: Displays the electricity cost savings in balance.

CARBON CONVERT SETTING: Adjusts the carbon footprint factor in the carbon saving calculation. This initial setting is based on the OECD (2008 Edition).

CURRENCY SETTING: Displays electricity pricing in 6 currency units.

CURRENCY CONVERT SETTING: Displays electricity savings in kW/hour (US Currency is default).

NOTE: This model's initial setting is "Currency = US\$" and its Currency Convert setting = \$0.11.

This setting can be changed by using the ECO information menu.

If you want to use the French setting, please refer to steps below:

1. Touch the Menu key and select the ECO information menu using the "LEFT" or "RIGHT" key.
2. Select CURRENCY SETTING item by touching the "UP" or "DOWN" key.
3. The French currency unit is Euro (€). You can adjust currency setting to Euro icon (€) from US dollar (\$) by touching the "LEFT" or "RIGHT" key in Current setting item.
4. Select CURRENCY CONVERT SETTING by touching the "UP" or "DOWN" key*.
5. Adjust CURRENCY CONVERT SETTING by touching the "LEFT" or "RIGHT" key.

* This initial Euro (€) setting is based on the OECD data for Germany (2007 Edition). Please check the receipt of electricity prices for France or OECD data for France. The French value according to the OECD data (2007 Edition) was €0.12.



Information

Provides information about the current resolution display and technical data including the preset timing being used and the horizontal and vertical frequencies. Indicates the model and serial numbers of your monitor.

OSD Warning

OSD warning menus disappear when EXIT is selected.

NO SIGNAL: This function gives a warning when there is no horizontal or vertical sync. After power is turned on or when there is a change of input signal, the **No Signal** window will appear.

OUT OF RANGE: This function gives a recommendation of the optimized resolution and refresh rate. After the power is turned on or there is a change of input signal or if the video signal doesn't have proper timing, the **Out Of Range** menu will appear.

Specifications

Monitor Specifications		MultiSync EA245WMI-2	Notes
LCD Module	Diagonal: Viewable Image Size: Native Resolution (Pixel Count):	61.13 cm/24 inches 61.13 cm/24 inches 1920 x 1200	Active matrix; thin film transistor (TFT) liquid crystal display (LCD); 0.270 mm dot pitch; 300 cd/m ² white luminance; 1000:1 contrast ratio (typical), (5000:1 Contrast ratio, Dynamic).
Input Signal			
DisplayPort:	DisplayPort Connector:	Digital RGB	DisplayPort V1.2 (HDCP 1.3)
DVI:	DVI-D 24pin:	Digital RGB	DVI (HDCP 1.4)
VGA:	15pin Mini D-sub:	Analog RGB Sync	0.7 Vp-p/75 ohm Separate sync.TTL level Positive/Negative Composite sync.TTL level Positive/Negative Sync on Green (Video 0.7 Vp-p and Sync Negative 0.3 Vp-p)
HDMI:	HDMI Connector:	Digital YUV Digital RGB	HDMI (HDCP 1.4)
Output Signal			
DisplayPort:	DisplayPort Connector:	Digital RGB	DisplayPort V1.2 (HDCP 1.3)
Display Colours		16,777,216	
Synchronization Range	Horizontal: Vertical:	31.5 kHz to 95.0 kHz 56 Hz to 75 Hz	Automatically Automatically
Viewing Angle	Left/Right: Up/Down:	±89° (CR > 10) ±89° (CR > 10)	
Image Formation Time		6 ms (Gray to gray Typ.)	
Resolutions Supported		720 x 400*1: VGA text 640 x 480*1 @ 60 Hz to 75 Hz 800 x 600*1 @ 56 Hz to 75 Hz 832 x 624*1 @ 75 Hz 1024 x 768*1 @ 60 Hz to 75 Hz 1152 x 870*1 @ 75 Hz 1280 x 1024*1 @ 60 Hz to 75 Hz 1400 x 1050*1 @ 60 Hz to 75 Hz 1440 x 900*1 @ 60 Hz 1600 x 1200*1 @ 60 Hz 1680 x 1050*1 @ 60 Hz 1920 x 1080*1 @ 60 Hz 1920 x 1200 @ 60 Hz.....NEC DISPLAY SOLUTIONS cites recommended.	Some systems may not support all modes listed.
Active Display Area	Landscape: Horiz.: Vert.: Portrait: Horiz.: Vert.:	518.4 mm/20.4 inches 324.0 mm/12.8 inches 324.0 mm/12.8 inches 518.4 mm/20.4 inches	
USB Hub	I/F: Port: Load Current:	USB Specification Revision 3.1 Gen 1 Upstream 1 USB 3.1 Gen 1 Downstream 3 Maximum 0.9 A per port for USB 3.1 Gen 1	USB 3.1 Gen 1 Upstream port applicable to USB monitor control.
AUDIO			
AUDIO Input:	STEREO Mini Jack: DisplayPort Connector: HDMI Connector:	Analog Audio Digital Audio Digital Audio	Stereo L/R 500mV rms 20 Kohm PCM 2ch 32, 44.1, 48 kHz (16/20/24bit) PCM 2ch 32, 44.1, 48 kHz (16/20/24bit)
Headphone Output:	STEREO Mini Jack:		Headphone Impedance 32 Ohm
Speakers	Practical Audio Output:	1.0 W + 1.0 W	
ControlSync (available up to 24 sub monitors)	IN: OUT:	Stereo Micro jack 2.5 φ Stereo Micro jack 2.5 φ	
Power Supply		AC 100-240 V ~ 50/60 Hz	
Current Rating		0.90 - 0.50 A	
Dimensions	Landscape: Portrait: Height Adjustment:	531.5 mm (W) x 365.4 - 515.4 mm (H) x 250.0 mm (D) 20.9 inches (W) x 14.4 - 20.3 inches (H) x 9.8 inches (D) 347.8 mm (W) x 549.5 - 613.2 mm (H) x 250.0 mm (D) 13.7 inches (W) x 21.6 - 24.1 inches (H) x 9.8 inches (D) 150 mm/5.9 inches (Landscape orientation) 63.7 mm/2.5 inches (Portrait orientation)	
Weight		6.7 kg (14.8 lbs)/Without stand: 4.2 kg (9.3 lbs)	
Environmental Considerations			
Operating Temperature:		5°C to 35°C/41°F to 95°F	
Humidity:		20% to 80%	
Altitude:		0 to 16,404 Feet/0 to 5,000 m	
Storage Temperature:		-10°C to 60°C/14°F to 140°F	
Humidity:		10% to 85%	
Altitude:		0 to 40,000 Feet/0 to 12,192 m	

*1 Interpolated Resolutions: When resolutions are shown that are lower than the pixel count of the LCD module, text may appear different. This is normal and necessary for all current flat panel technologies when displaying non-native resolutions full screen. In flat panel technologies, each dot on the screen is actually one pixel, so to expand resolutions to full screen, an interpolation of the resolution must be done.

NOTE: Technical specifications are subject to change without notice.

Features

Fully Ergonomic Stand: Provides viewing flexibility with 150mm height adjustment, -5 ~ 35-degree tilt, 170-degree swivel to both right/left directions with cable management function and small footprint. Monitor head (display part) can touch stand base for lower position requirement.

ErgoDesign Features: Enhanced human ergonomics to improve the working environment, protect the health of the user and save money. In addition to the fully ergonomic stand, examples include OSD controls for quick and easy image adjustment and lower emissions.

Various Signal Interfaces: This model has various interfaces like Analog D-SUB, DVI-D, DisplayPort and HDMI.

DisplayPort OUT: This monitor has a DisplayPort out connector for daisy-chain connection. Multiple monitors can be connected without complicated cable management.

UNIFORMITY: This feature compensates for slight variations in the white uniformity level that may occur on the screen and improves the color and evens out the luminance uniformity of the display.

Response Improve: Improved gray to gray response.

Color Control Systems: Allow you to adjust the colors on your screen and customize the color accuracy of your monitor to a variety of standards.

sRGB Color Control: A new optimized color management standard which allows for color matching on computer displays and other peripherals. The sRGB, which is based on the calibrated color space, allows for optimal color representation and backward compatibility with other common color standards.

Plug and Play: The Microsoft® solution with the Windows® operating system facilitates setup and installation by allowing the monitor to send its capabilities (such as screen size and resolutions supported) directly to your computer, automatically optimizing display performance.

Intelligent Power Manager System: Provides innovative power-saving methods that allow the monitor to shift to a lower power consumption level when on but not in use, saving two-thirds of your monitor energy costs, reducing emissions and lowering the air conditioning costs of the workplace.

VESA Standard Mounting Interface: Allows users to connect your MultiSync monitor to any VESA standard third party mounting arm or bracket.

USB 3.1 Gen 1: USB 3.1 Gen 1 hub for faster communication with the workstation, e.g. using a USB memory stick.

USB Monitor Control: Allow you to adjust each item through application software by connecting an USB cable.

Human/Ambient Sensors: Controls screen brightness according to user presence and ambient light status for less power consumption.

NaViSet Administrator 2 Software: Offers an expanded and intuitive graphical interface, allowing you to more easily adjust OSD display settings from network PC.

Environmental Impact: Annual typical maximum operating carbon footprint of this monitor (world-wide average) is approximately 45.5 kg (calculated by: rated wattage x 8 hours per day x 5 days a week x 45 weeks per year x Power-to-Carbon conversion factor - conversion factor is based on OECD publication of global CO2 emissions 2008 Edition). This monitor has a manufacturing carbon footprint of approximately 51.2 kg.

Note: The manufacturing and operating carbon footprints are calculated by a unique algorithm developed exclusively by NEC for its monitors.

ControlSync: Follow the steps of "DATA COPY" and copy the settings from the master monitor to the sub monitors by connecting the ControlSync cable. When the setting of the master monitor is adjusted, it is sent to the sub monitors automatically, providing easy setting controls in a multiple monitor environment.

Customize Setting: Allows to store the current settings and recover stored settings.

Low Blue Light: This monitor has a blue light reducing function. This means hazardous light from the monitor is substantially reduced and it allows to free from eyestrain (see page 17).

Flicker Free: Special backlight system reduces flicker for less eyestrain.

Troubleshooting

No picture

- The signal cable should be completely connected to the display card/computer.
- The display card should be completely seated in its slot.
- The monitor does not support DisplayPort converter adapter.
- When you use DisplayPort signal, check to make sure not to plug the input signal cable in DisplayPort out connector.
- Power Switch and computer power switch should be in the ON position.
- The monitor will automatically turn off by "POWER SAVE TIMER" function when "POWER SAVE TIMER" setting is "ON" and continuing power save mode for 2 hours. Please touch the power key.
- Check to make sure that a supported mode has been selected on the display card or system being used. (Please consult display card or system manual to change graphics mode.)
- Check the monitor and your display card with respect to compatibility and recommended settings.
- Check the signal cable connector for bent or pushed-in pins.
- Check the signal input.
- If the front LED is dark blue, check the status of the OFF MODE SETTING mode (see page 14) or Human sensor (see page 14).
- When using an HDMI input, please change "OVER SCAN".

Power Key does not respond

- Unplug the power cord of the monitor from the AC outlet to turn off and reset the monitor.
- When something is stuck on the bezel, key becomes unresponsive.

Image Persistence

- Image persistence is when a residual or "ghost" image of a previous image remains visible on the screen. Unlike CRT monitors, LCD monitors' image persistence is not permanent, but constant images being displayed for a long period of time should be avoided. To alleviate image persistence, turn off the monitor for as long as the previous image was displayed. For example, if an image was on the monitor for one hour and a residual image remains, the monitor should be turned off for one hour to erase the image.

NOTE: As with all personal display devices, NEC DISPLAY SOLUTIONS recommends using a moving screen saver at regular intervals whenever the screen is idle or turning off the monitor when not in use.

Message "OUT OF RANGE" is displayed (screen is either blank or shows rough images only)

- Image is displayed only roughly (pixels are missing) and OSD warning "OUT OF RANGE" is displayed: Either signal clock or resolution is too high. Choose one of the supported modes.
- OSD warning "OUT OF RANGE" is displayed on a blank screen: Signal frequency is out of range. Choose one of the supported modes.

Image is unstable, unfocused or swimming is apparent

- Signal cable should be completely attached to the computer.
- Use the OSD Image Adjust controls to focus and adjust display by increasing or decreasing the fine adjustment. When the display mode is changed, the OSD Image Adjust settings may need to be readjusted.
- Check the monitor and your display card with respect to compatibility and recommended signal timings.
- If your text is garbled, change the video mode to non-interlace and use 60Hz refresh rate.

LED on monitor is not lit (*no blue or amber color can be seen*)

- Power Switch should be in the ON position and power cord should be connected.
- Increase LED BRIGHTNESS adjustment.

Picture is not as bright

- Make sure ECO MODE and AUTO BRIGHTNESS are turned off.
- If the brightness fluctuates, make sure AUTO BRIGHTNESS is turned off.
- Signal cable should be completely attached.
- LCD brightness degradation occurs due to long-term usage or extreme cold conditions.
- When using an HDMI input, please change "VIDEO LEVEL".
- If the brightness fluctuates, make sure DV MODE is set to STANDARD.

Display image is not sized properly

- Use the OSD Image Adjust controls to increase or decrease the Coarse adjustment.
- Check to make sure that a supported mode has been selected on the display card or system being used. (Please consult display card or system manual to change graphics mode.)
- When using an HDMI input, please change "OVER SCAN".
- Check to make sure that the appropriate resolution has been selected in H.RESOLUTION and V.RESOLUTION.

No Video

- If no video is present on the screen, turn the Power key off and on again.
- Make certain the computer is not in a power-saving mode (touch the keyboard or mouse).
- Some display cards do not output video signal when monitor is turned OFF/ON or disconnect/connect from the AC power cord under low resolution with DisplayPort.
- When using an HDMI input, please change “OVER SCAN”.

No Sound

- Make sure the speaker cable is proper connected.
- Check to see if mute is activated.
- Check the volume in the OSD menu.
- Check selected OSD's Tools to “SOUND INPUT”, when DisplayPort or HDMI is in use.

Brightness variations over time

- Change AUTO BRIGHTNESS to OFF and adjust brightness.

NOTE: When AUTO BRIGHTNESS is set to ON, the monitor automatically adjusts brightness based on the environment. When the brightness of surrounding environment changes, the monitor will also change.

- Change DV MODE to STANDARD and adjust brightness.

NOTE: When DV MODE is set to DYNAMIC, the monitor automatically adjusts brightness.

USB Hub does not operate

- Check to make sure the USB cord is properly connected. Refer to your USB device User's Manual.
- Check if the USB upstream port on the monitor is connected to the USB downstream port on the computer. And make sure the computer is ON.

Human sensor does not work

- If human icon on SENSOR SETTING (HUMAN SENSING) is located on vermilion color, it is detected that there is person.
- Make sure there is no object in front of Human sensor.
- Make sure there is no equipment which radiating infrared rays in front of monitor.

ControlSync does not work

- Check to make sure that ControlSync cable is connected correctly.
- Check to make sure that ControlSync cable is not in “loop” connection.
- Master monitor should be connected OUT connector only.
- Please use provided ControlSync cable.
- You can use up to 24 sub monitors via ControlSync.

No picture in multiple monitor connection

- Check to make sure that the resolution has been lower than the recommended resolution setting.
- Check to make sure that the display card supports MST (multi-stream transport).
- The number of monitors daisy-chained through SST (single-stream transport) depends on HDCP contents limitation.
- Monitors should be connected by the included DisplayPort cable.
- Check to make sure that DP OUT MULTISTREAM is “AUTO” and BIT RATE setting is “HBR2” when using MST (multi-stream transport) (see page 17).

Reproduced text looks blurred

- Make sure that a supported resolution has been selected on the display card or system being used. If in doubt, please refer to the user's manual of the display card or system to change the resolution.

Using the Zoom Function

Allows you to use the entire screen area, significantly expanding the size.
Allows the picture displayed in the center to expand.

SETUP

1. Select FULL or ASPECT in EXPANSION to activate the Zoom function (see page 16).

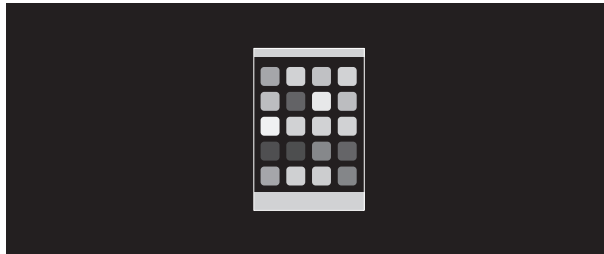

EXPANSION OFF

2. Set a resolution via H.RESOLUTION or V.RESOLUTION (see page 16).

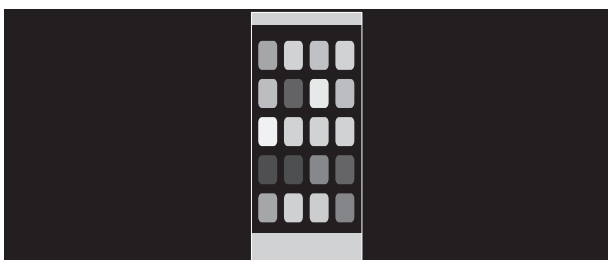

Vertical expansion



Horizontal expansion

3. The image position can be moved from the center to left or right by selecting LEFT/RIGHT and upward or downward by selecting UP/DOWN (see page 15).



Move to left or right



Move upward or downward

Human sensing function

Human sensing function reduces power consumption by detecting the movement of a person.

The HUMAN SENSING has following two settings:

MODE	HUMAN SENSING SETTING	No person in front of the monitor
LIGHT	1	BRIGHTNESS 0%
DEEP	2	Power saving mode

Image of human sensing operation

- A. When the sensor detects no person in front of the monitor, the monitor stays on for a period of time which is set at HUMAN SENSING > START TIME (see page 15).
- B. The monitor displays a notification on the screen after the period of time.
You can set notification screen at SENSOR INFORMATION (see page 18).

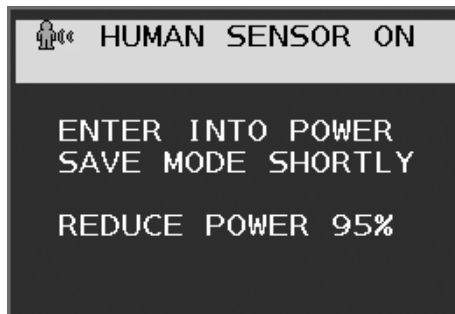

- C. After displaying a notification, If LIGHT is set at HUMAN SENSING, the monitor screen gets gradually darker then becomes 0% brightness in the end.
If DEEP is set at HUMAN SENSING, the monitor enters into power saving mode.
- D. When the sensor detects a person coming back, the monitor setting is automatically back from power saving mode to normal mode.

NOTE: When LIGHT is set at HUMAN SENSING, the monitor screen gets gradually brighter then back to original brightness.

- E. The monitor returns to normal mode.

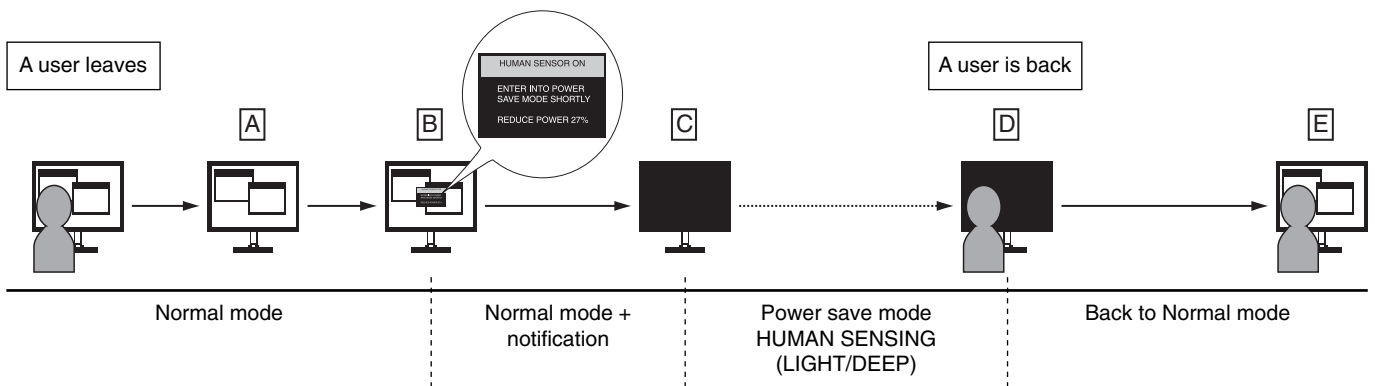

Using the Auto Brightness function

The brightness of the LCD screen can be set to increase or decrease depending on the amount of ambient lighting within the room. If the room is bright, the monitor becomes correspondingly bright. If the room is dim, then the monitor will dim accordingly. The purpose of this function is to make the viewing experience more comfortable to the eye in a variety of lighting conditions.

SETUP

Use the following procedures to select the Brightness Range that the monitor will use when the Auto Brightness function is activated.

1. Set the BRIGHTNESS level. This is the brightness level that the monitor will go up to when the ambient lighting level is highest. Select this setting when the room is at its brightest.

Select ON in the AUTO BRIGHTNESS menu (**Figure 1**). Then use the front Keys to move the cursor up to the BRIGHTNESS setting. Choose the desired brightness level (**Figure 2**).



Figure 1



Figure 2

2. Set the DARK level. This is the level of brightness that the monitor will go down to when the ambient lighting level is low. Make sure the room is at its darkest when setting this level.

Then use the front Keys to move the cursor up to the BRIGHTNESS setting. Choose the desired brightness level (**Figure 3**).



Figure 3

When the "Auto Brightness" function is enabled the Brightness level of the screen changes automatically according to the lighting conditions of the room (**Figure 4**).

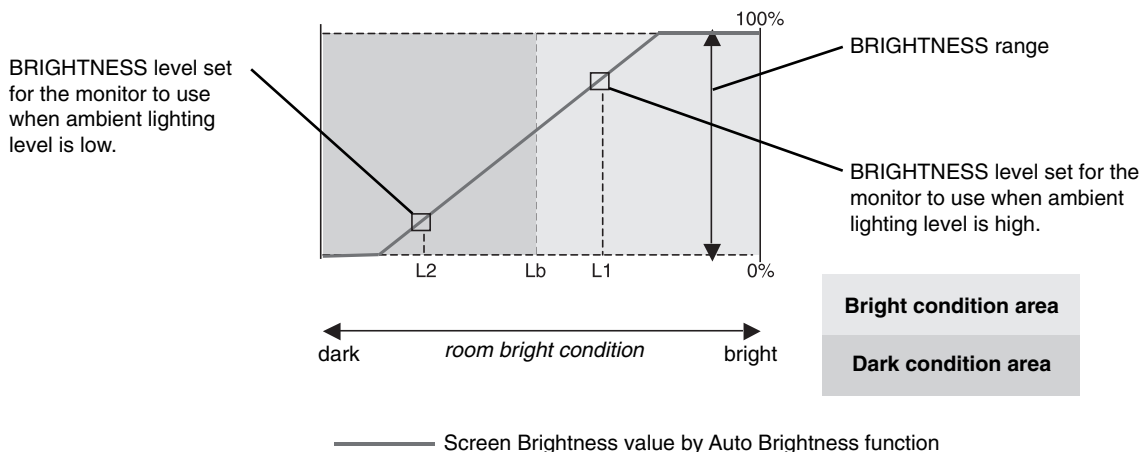

Figure 4

Lb: Border between bright and dim lighting conditions; set at factory
 L1: BRIGHTNESS level set for the monitor to use when ambient lighting level is high ($L1 > Lb$)
 L2: BRIGHTNESS level set for the monitor to use when ambient lighting level is low ($L2 < Lb$)

L1 and L2 are the brightness levels set by the user to compensate for changes in ambient lighting.

Manufacturer's Recycling and Energy Information

NEC DISPLAY SOLUTIONS is strongly committed to environmental protection and sees recycling as one of the company's top priorities in trying to minimize the burden placed on the environment. We are engaged in developing environmentally-friendly products, and always strive to help define and comply with the latest independent standards from agencies such as ISO (International Organisation for Standardization) and TCO (Swedish Trades Union).

Disposing of your old NEC product

The aim of recycling is to gain an environmental benefit by means of re-use, upgrading, reconditioning or reclamation of material. Dedicated recycling sites ensure that environmentally harmful components are properly handled and securely disposed. To ensure the best recycling of our products, **NEC DISPLAY SOLUTIONS offers a variety of recycling procedures** and gives advice on how to handle the product in an environmentally sensitive way, once it has reached the end of its life.

All required information concerning the disposal of the product and country-specific information on recycling facilities can be found on our following websites:

<http://www.nec-display-solutions.com/greencompany/> (in Europe),

<http://www.nec-display.com> (in Japan) or

<http://www.necdisplay.com> (in USA).

Energy Saving

This monitor features an advanced energy saving capability. When a Display Power Management signal is sent to the monitor, the Energy Saving mode is activated. The monitor enters a single Energy Saving mode.

Mode	Power consumption	LED colour
Maximum Operation	50 W	Blue
Normal Operation	22 W Default setting, USB/Audio sleeping	Blue
Energy Saving Mode	0.30 W*	Amber
Off Mode	0.25 W	Unlit

*: Factory settings.

For additional information visit:

<http://www.necdisplay.com/> (in USA)

<http://www.nec-display-solutions.com/> (in Europe)

<http://www.nec-display.com/global/index.html> (Global)

For Energy Saving information: [Default setting: DP OUT MULTISTREAM/CLONE]

For ErP requirement/For ErP (Network standby) requirement:

Setting: Tools → DP OUT MULTISTREAM → CLONE

Power consumption: 0.5 W or less.

Time for power management function: Approx. 1 min.

WEEE Mark (European Directive 2012/19/EU and amendments)



Disposing of your used product: In the European Union

EU-wide legislation as implemented in each Member State requires that used electrical and electronic products carrying the mark (left) must be disposed of separately from normal household waste. This includes monitors and electrical accessories, such as signal cables or power cords. When you dispose of such products, please follow the guidance of your local authority or ask the shop where you purchased the product, or if applicable, follow applicable legislation or agreement you may have. The mark on electrical and electronic products may only apply to the current European Union Member States.

Outside the European Union

If you wish to dispose of used electrical and electronic products outside the European Union, please contact your local authority and ask for the correct method of disposal.