

User's Guide

TP-M5000N

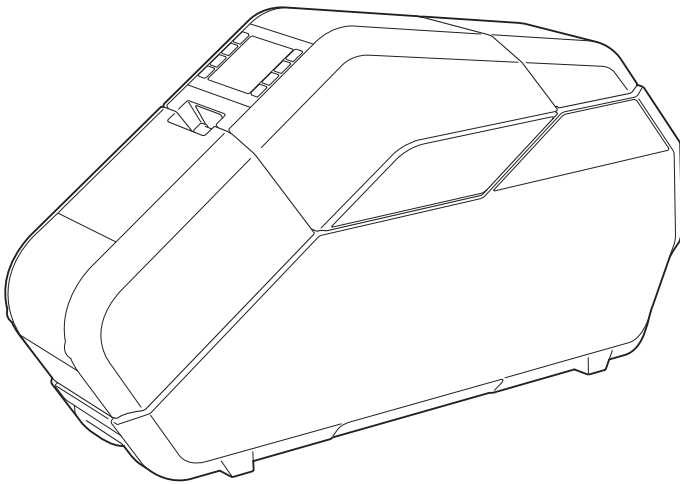

Before using this machine, be sure to read this User's Guide. We suggest that you keep this manual for future reference.

Introduction

Thank you for purchasing the Brother TP-M5000N (hereafter referred to as “the machine”). Be sure to read the User’s Guide (this manual) before using the machine. The latest version of the User’s Guide can be downloaded from the Brother Solutions Center website (<http://support.brother.com/>). We suggest that you keep this manual for future reference.

Important Information

- The contents of this document and specifications of the machine are subject to change without notice.
- The contents of this document may not be duplicated or reproduced, partially or in full, without permission.
- We assume no responsibility for damages arising from earthquakes, fire, other disasters, actions of third parties, the user's intentional or negligent operation, misuse or operation under other special conditions.
- We assume no responsibility for damage (such as losses, loss of income, lost profits, business disruptions, a lost means of communication or claims from third parties) that may result from the use or inability to use this machine.
- The actual windows and dialog boxes of the software as well as the machine screens may differ from those described in this manual, depending on your machine, or the operating system running on your computer.
- Before using this machine, be sure to read all included documentation for details on its safe and correct use.
- In the event that this machine is defective due to faulty manufacturing, we shall repair or replace it. We shall not be obligated to repair or replace the product under any other circumstances.
- We assume no responsibility for damages that may result from a malfunction of this machine from connecting incompatible equipment or using incompatible software.
- Brother Industries, Ltd. reserves the right to modify, without notice, materials and specifications published in this document. In addition, we assume no responsibility for damages (including consequential damages) resulting from the use of published materials, including typographical errors or any other error included in the publications.
- This machine is approved for use only within the country where it was purchased. Since regulations for electronics may differ by country, do not use this machine in any country other than where it was purchased.
- Windows Vista[®] is the general term in this manual for all editions of Windows Vista[®].
- Windows[®] 7 is the general term in this manual for all editions of Windows[®] 7.
- Windows[®] 8 is the general term in this manual for all editions of Windows[®] 8.
- Windows[®] 8.1 is the general term in this manual for all editions of Windows[®] 8.1.
- Windows Server[®] 2008 is the general term in this manual for all editions of Windows Server[®] 2008 and Windows Server[®] 2008 R2.
- Windows Server[®] 2012 is the general term in this manual for all editions of Windows Server[®] 2012 and Windows Server[®] 2012 R2.

Precautions for Creating Tape and Fabric Ribbon

Observe the following precautions when creating tape and fabric ribbon.

- Copyrighted material
Creating tape or fabric ribbons of copyrighted material is prohibited, except for personal use.

Table of Contents

1	Getting Started	1
	Product Safety	1
	Safety Precautions	2
	Operating Precautions	7
	Trademarks.....	8
	Open Source Licensing Remarks	8
	Regulation.....	9
	LAN Connection	9
	Disconnect device	10
	Included Items	11
	Consumables (Not Included).....	12
	General Description	13
	Operation Panel.....	13
	Setting Up the Machine	15
	Connecting the Power Supply	15
	Installing the Tape Cassette	15
	Installing the Ink Ribbon Cassette	16
	Installing the Paper Core Holder	16
	About the Tape Cassettes, Fabric Ribbon Cassettes and Ink Ribbon Cassettes	19
	Installing the Printer Driver and Software	20
	Connecting the Computer and Machine	21
	USB Cable Connection.....	21
	Wired Network Connection.....	22
2	Software	23
	About the Software	23
	Using P-touch Editor.....	23
	Operation Modes	24
	Creating/Printing Tapes or Fabric Ribbons in P-touch Editor.....	26
	Creating Multiple Tapes or Fabric Ribbons	30
	Image Files	31
	Using P-touch Library	31
	Registering Templates With P-touch Library	32
	Using P-touch Library	32
	Using the P-touch Update Software	34
	Updating P-touch Editor or the Firmware	34
3	Printer Setting Tool	36
	About the Printer Setting Tool.....	36
	Before Using the Printer Setting Tool	36
	Using the Printer Setting Tool.....	36
	Communication Settings	37
	Settings Dialog Box	37
	Menu Bar	38
	Applying Setting Changes to Multiple Tape Creators.....	40



Device settings	41
Menu Bar	41
4 Network Features	43
Specifying the IP Address, Subnet Mask and Gateway	43
Using the BRAdmin Light Utility	43
Other Management Utilities	44
Using Web-Based Management (Web Browser)	44
Using the BRAdmin Professional Utility	44
Managing With Web-Based Management (Web Browser)	45
Configuring Machine Settings Using Web-Based Management (Web Browser)	45
Network Specifications	47
5 Maintenance	48
Print Head Maintenance	48
Ink Ribbon Guide Roller Maintenance	49
Platen Roller Maintenance	49
Bottom Cover Maintenance	49
Paper Core Holder Maintenance	49
6 Troubleshooting	50
When Indicators are Lit or Blink	50
When Messages Appear	51
Problems and Solutions	52
Frequently Asked Questions	52
General	52
Network	56
7 Appendix	59
Product Specifications	59













Product Safety

If the machine malfunctions, immediately stop using it, and contact your reseller or Brother Customer Service for assistance.











In order to prevent injuries or damage to the machine, follow the safety information in this chapter.

The following symbols and conventions are used throughout the documentation.

 WARNING	This indicates a potentially hazardous situation which, if the product is handled without following the warnings and instructions, could result in death or serious injuries.
 CAUTION	This indicates a potentially hazardous situation which, if not avoided, may result in minor or moderate injuries.
IMPORTANT	This indicates a potentially hazardous situation which, if not avoided, may result in damage to property or loss of product functionality.

	Indicates risk of fire under certain circumstances
	Indicates risk of injury, such as electric shock, if the indicated part of the machine is disassembled
	Indicates risk of electric shock under certain circumstances
	Indicates risk of electric shock if the machine is exposed to water
	Indicates risk of burns under certain circumstances
	Indicates an action that must be performed
	Indicates an action that must not be performed
	Indicates that the power cord must be unplugged from the power outlet
	Indicates risk of combustion if fire is nearby
	Indicates that flammable sprays must not be used
	Indicates that organic solvents such as alcohol and liquids must not be used
	Indicates supplemental information or operations for the machine

























Safety Precautions

⚠ WARNING	
Machine	
	Do not use the machine if it is operating abnormally (for example, if it produces smoke or an unusual odor or noise), otherwise fire, electric shock or damage to the machine may result. Immediately turn off the machine, unplug the power cord from the power outlet, and then contact your reseller or Brother Customer Service for assistance.
	Keep out of the reach of children, particularly infants, otherwise injuries may result.
	Do not allow children to play with the plastic bag that contained the machine. Dispose of the bag or keep it away from infants and children. There is a risk of suffocation.
	Do not try to disassemble or alter the machine, otherwise fire, electric shock or damage may result. Contact your reseller or Brother Customer Service for machine servicing, adjustments or repairs. (The warranty does not cover damage resulting from disassembly or alterations performed by the user.)
	Do not use or store the machine in the following locations, otherwise fire, electric shock or damage may result. <ul style="list-style-type: none"> ■ Near water, such as in a kitchen or bathroom, near a water heater, or in an extremely humid location ■ In a location where it is exposed to rain or moisture ■ In an extremely dusty location ■ Near open flames, heaters or volatile combustible material ■ In an extremely hot location, such as in direct sunlight ■ In a location where condensation may form
	Do not touch the machine during a severe thunderstorm, as this may result in electric shock.
	Do not spill liquids of any type on the machine, otherwise fire, electric shock or damage may result.
	Do not use the machine near open flames, otherwise fire, electric shock or damage may result.
	Do not place the following objects on the machine. Fire, electric shock or damage may result if any of these objects come into contact with the internal electrical parts. If any of these objects enter the machine, unplug the power cord from the power outlet, and then contact your reseller or Brother Customer Service for assistance. <ul style="list-style-type: none"> ■ Metal objects such as necklaces or bracelets ■ Objects containing water or liquids, such as cups, flower vases or flower pots
	In order to assure proper ventilation, do not place the machine in a location where its vents would be blocked, otherwise heat will accumulate, which may result in fire.









⚠ WARNING

	<p>Do not use combustible sprays when cleaning the machine or near it, otherwise fire or electric shock may result.</p> <p>Clean the machine by wiping it with a soft, dry cloth.</p> <p>Examples of combustible sprays:</p> <ul style="list-style-type: none"> ■ Dust removing cleaners ■ Pesticides ■ Disinfectants and deodorizers that contain alcohol ■ Organic solvents or liquids such as alcohol
	<p>Do not allow organic solvents, such as benzene, thinner, polish remover or deodorizers, to come into contact with the plastic cover of the machine. These may cause the plastic cover to warp or dissolve, resulting in electric shock or fire.</p>
	<p>Do not insert foreign objects into the machine or its connectors and ports. Fire, electric shock or damage may result if metal objects, such as paper clips or staples, or liquids come into contact with internal machine parts. If foreign objects enter the machine, immediately turn it off, unplug the power cord from the power outlet, and then contact your reseller or Brother Customer Service for assistance.</p>
	<p>Before cleaning the machine, be sure to turn it off and unplug the power cord from the power outlet, otherwise fire, electric shock or damage may result.</p>
	<p>Do not touch any metal parts near the print head. The print head becomes very hot during use and remains very hot for some time after use. Do not touch it directly with your hands.</p> <div data-bbox="620 1211 1136 1518" style="text-align: center;"> </div>
Power cord	
	<p>Only use the included power cord and the specified power supply.</p> <p>Use under any other conditions may result in a fire, electric shock or damage.</p>
	<p>Do not touch the power cord or the power plug with wet hands, otherwise it may result in an electric shock.</p>
	<p>Do not spill liquids of any type on the machine, otherwise fire, electric shock or damage may result.</p>
	<p>Keep out of the reach of children, particularly infants, otherwise injuries may result.</p>
	<p>Do not use the machine near open flames, otherwise the covering of cables may melt, resulting in fire, electric shock or damage.</p>
	<p>Do not insert objects into the power cord jack, USB port or Ethernet network port, otherwise fire, burns, electric shock or damage may result.</p>

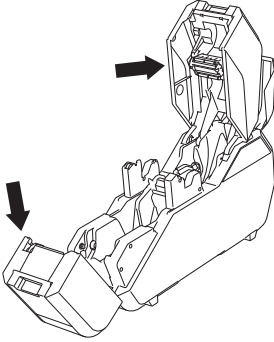



! WARNING

 	<p>Regularly remove the power plug from the power outlet, and clean the base of the prongs and between the prongs. If the power plug is left in the power outlet for an extended period of time, dust will accumulate at the base of the power plug prongs. This could cause a short circuit that may result in fire.</p>
  	<p>Do not allow organic solvents, such as benzene, thinner, polish remover or deodorizers, to come into contact with the cables. These may cause the cables to warp or dissolve, resulting in electric shock or fire.</p>
  	<p>Do not use damaged power plugs or a bent power outlet, otherwise fire, electric shock or damage may result.</p>
  	<p>Do not overload power outlets or plug multiple devices into the same power outlet, otherwise fire, electric shock or damage may result.</p>
  	<p>When unplugging the power cord from the power outlet, do not pull on the cord. Hold the power plug and pull it out of the power outlet, otherwise fire, electric shock or damage may result.</p>
  	<p>Use the cables correctly and observe the following precautions, otherwise fire or electric shock may result.</p> <ul style="list-style-type: none"> ■ Do not damage them. ■ Do not modify them. ■ Do not twist them. ■ Do not severely bend them. ■ Do not pull on them. ■ Do not place objects on them. ■ Do not subject them to heat. ■ Do not bind them. ■ Do not allow them to be pinched.
 	<p>Fully insert the power plug into the power outlet and power cord connector into the power cord jack, otherwise fire, electric shock or damage may result.</p>
  	<p>Brother strongly recommends that you DO NOT use any extension cord.</p> <p>However, if an extension cord is required, use it correctly and in compliance with the general guidelines for its use. If an extension cord is incorrectly used, fire, electric shock or damage may result.</p>
 	<p>When connecting cables and installing either tape or fabric ribbon cassettes and ink ribbon cassettes, be sure to connect and install them correctly and in the correct order.</p> <p>Only connect items that are designed specifically for this machine, otherwise fire or injury may result. Refer to the User's Guide when making connections.</p>

! CAUTION

Machine	
	Make sure that small children do not put their fingers between moving parts or in openings of the machine.
	Do not hold the machine with only one hand. The machine may slip out of your hand.
	Do not hold the machine by its cover. There is a risk of injury if the cover detaches and the machine falls.
	
	Do not place the machine on an unstable surface, such as an unsteady table or a high shelf. If the machine falls, injuries may result.
	Do not place heavy objects on top of this machine. If the objects fall, injuries may result.
Power cord	
	If the machine will not be used, unplug the power cord from the power outlet.
Tape cassette/fabric ribbon cassette/ink ribbon cassette	
	Do not place the tape cassette, fabric ribbon cassette or ink ribbon cassette on an unstable surface, such as an unsteady table or a high shelf. If the cassette falls, injuries may result.
Print head cleaning pen	
	Do not place the print head cleaning pen in your mouth or allow it to contact your eyes or skin. Do not put it into a fire.

IMPORTANT

Machine	
	The machine may malfunction if left near a television, radio, microwave oven, etc. Do not use the machine near any device that can cause electromagnetic interference.
	Do not drop, hit or otherwise damage the machine.
	Do not remove the labels affixed to the machine. These labels provide operational information and indicate the machine's model number.
 	Do not use paint thinner, benzene, alcohol or any other organic solvents to clean the machine, otherwise damage to the surface finish may result. Use a soft, dry cloth to clean the machine.

IMPORTANT

CD-ROM

- | | |
|---|--|
| ⊘ | Do not scratch the CD-ROM, expose it to extremely high or low temperatures, place heavy objects on top of it, or bend it. |
| ! | The software contained on the CD-ROM is meant for use with this machine only. See the License on the CD-ROM for details. This software may be installed on multiple computers for use in an office, etc. |

Warning label

- | | |
|---|--|
| ! | The following warning labels appear on the machine. Fully understand the contents of each warning label and perform operations while observing the precautions that are described. In addition, be very careful that the warning labels do not peel off and are not scratched. |
|---|--|

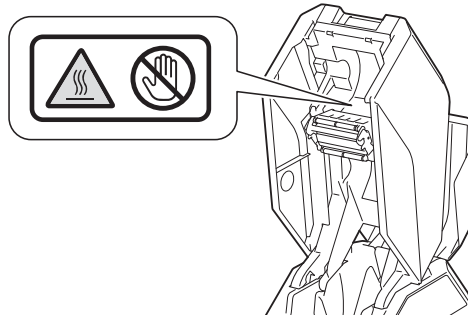

Other warnings/precautions

- | | |
|---|---|
| ⊘ | Make sure that the power cord is accessible so that it can be removed in an emergency.
Do not place objects on or near the power cord. |
| ! | Always keep the top cover and bottom cover closed when printing. |
| ! | If the machine will not be used for an extended period, remove the tape cassette before storing the machine. |
| ⊘ | Do not touch the machine with wet hands, otherwise a malfunction may result. |

Operating Precautions

- When transporting the machine, hold it with both hands at the areas indicated below. Do not hold the machine at any areas other than those indicated.

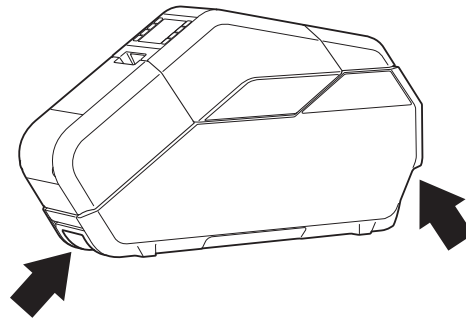

- Since the machine may become extremely hot if it is used for an extended period, do not touch any internal machine parts, other than to install the tape cassette, fabric ribbon cassette, ink ribbon cassette and paper core.
- Do not leave the machine for an extended period with its cover open, otherwise dust may accumulate on the internal machine parts.
- Do not touch sensors inside the machine.
- Do not leave rubber or vinyl on the machine for an extended period.
- If the machine will not be used for an extended period, unplug the power cord from the power outlet before storing the machine.
- When the machine is purchased, a protective film is attached to the LCD. Peel off the protective film before using the machine.
- Pausing and resuming printing will leave a gap in the printed tape or fabric ribbon. Take care when pausing prints.

Trademarks

BROTHER is either a trademark or a registered trademark of Brother Industries, Ltd.

© 2014 Brother Industries, Ltd. All rights reserved.

Microsoft, Windows, Windows Vista and Windows Server are either registered trademarks or trademarks of Microsoft Corp. in the United States and/or other countries.

Adobe and Reader are either registered trademarks of Adobe Systems Incorporated in the United States and/or other countries.

Each owner whose software title is mentioned in this document has a Software License Agreement specific to its proprietary programs.

Any trade names and product names appearing on Brother products, related documents and any other materials are all trademarks or registered trademarks of their respective companies.

Open Source Licensing Remarks

To see the open source licensing remarks, go to the manual download section on your model's web page of Brother Solutions Center at <http://support.brother.com/>

Regulation

Federal Communications Commission (FCC) Declaration of Conformity (For USA Only)

Responsible Party: Brother International Corporation
200 Crossing Boulevard
Bridgewater, NJ 08807-0911 USA
TEL : (908) 704-1700

declares, that the products

Product Name: Brother Tape Creator

Model Number: TP-M5000N

complies with Part 15 of the FCC Rules. Operation is subject to the following two conditions: (1) this device may not cause harmful interference, and (2) this device must accept any interference received, including interference that may cause undesired operation.

This equipment has been tested and found to comply with the limits for a Class B digital device, pursuant to Part 15 of the FCC Rules. These limits are designed to provide reasonable protection against harmful interference in a residential installation. This equipment generates, uses and can radiate radio frequency energy and, if not installed and used in accordance with the instructions, may cause harmful interference to radio communications. However, there is no guarantee that interference will not occur in a particular installation. If this equipment does cause harmful interference to radio or television reception, which can be determined by turning the equipment off and on, the user is encouraged to try to correct the interference by one or more of the following measures:

- Reorient or relocate the receiving antenna.
- Increase the separation between the equipment and receiver.
- Connect the equipment into an outlet on a circuit different from that to which the receiver is connected.
- Consult the dealer or an experienced radio/TV technician for help.

Important

- The enclosed interface cable should be used in order to ensure compliance with the limits for a Class B digital device.
- Changes or modifications not expressly approved by Brother Industries, Ltd. could void the user's authority to operate the equipment.

LAN Connection

Caution : Connect this product to a LAN connection which is not subject to overvoltages.

Disconnect device

This product must be installed near a power outlet that is easily accessible. In case of emergencies, you must disconnect the power cord from the power outlet in order to shut off power completely.

Included Items

Before using the machine, check that all of the following contents are included. If any item is missing or damaged, contact the retailer where it was purchased.

(The illustrations may differ from the original items.)

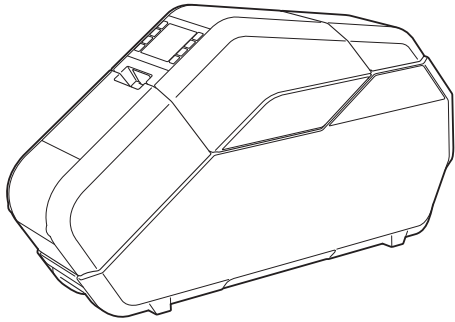
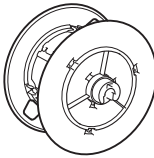
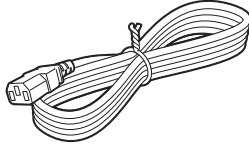
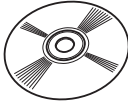
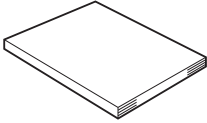
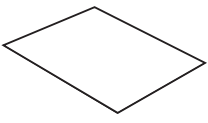
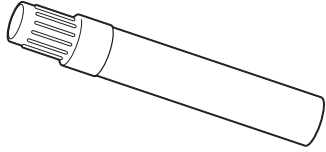
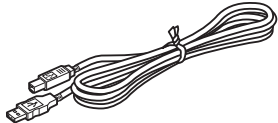
TP-M5000N		Paper core holder	
			
		Power cord	CD-ROM
			
User's Guide (this manual)	Quick Setup Guide	Print head cleaning pen	USB cable
			

Tape and fabric ribbon that can be printed with TP-M5000N

Material	Tape			Fabric ribbon	
	PET	OPP		Polyester satin	
Width	0.59" (15 mm)	1.49" (38 mm)	1.96" (50 mm)	0.59" (15 mm)	1.49" (38 mm)
Paper Core Inner Diameter 3" (76.2 mm)	✓	✓	✓	✓	✓
Maximum Wound Length	27 yds. (24.6 m)	72 yds. (65.8 m)	72 yds. (65.8 m)	27 yds. (24.6 m)	27 yds. (24.6 m)

Consumables (Not Included)

Tape cassette

*For printing tape

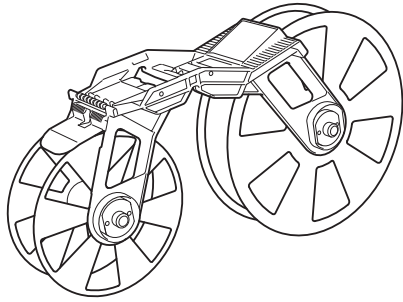

Fabric ribbon cassette

*For printing fabric ribbon

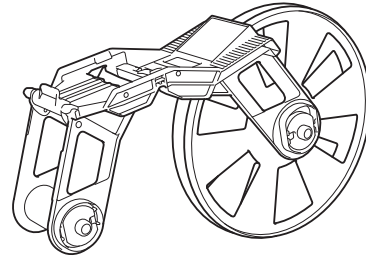

Ink ribbon cassette for printing tape

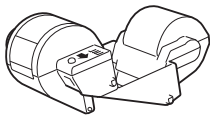

Fabric ink ribbon cassette for printing fabric ribbon

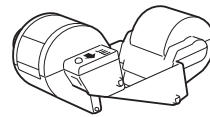

Paper core

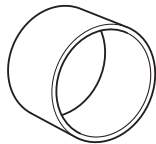

NOTE

- For Tape Creator information, visit our website - <http://brother-usa.com>.
 - In this manual, “ink ribbon cassettes for printing tape” and “ink ribbon cassettes for printing fabric ribbon” are simply referred to as “ink ribbon cassettes”.
-

General Description

Front

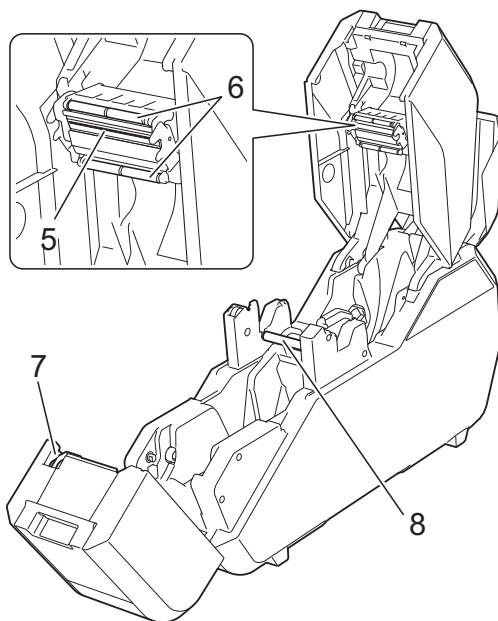
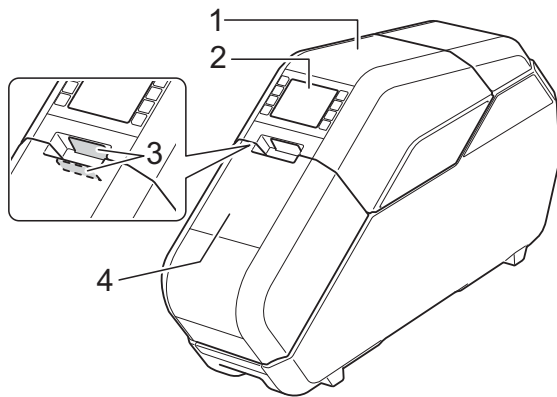

- 1 Top cover
- 2 Operation panel
- 3 Open button
- 4 Bottom cover
- 5 Print head
- 6 Ink ribbon guide rollers
- 7 Cutter
- 8 Platen roller

Back

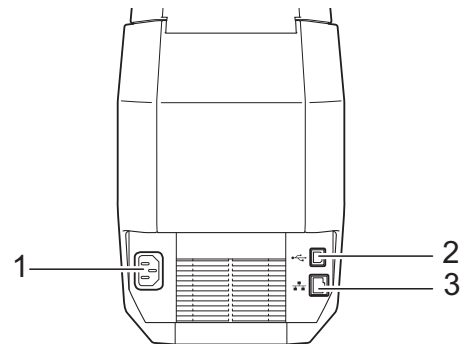

- 1 Power cord jack
- 2 USB port
- 3 Ethernet network port

Operation Panel

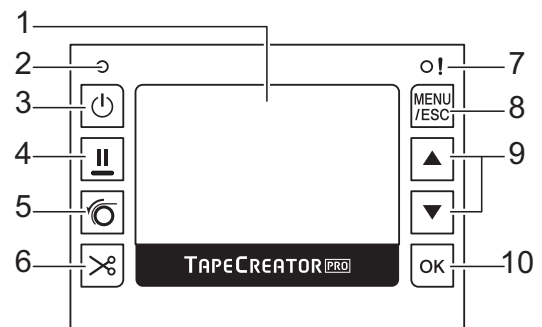

- 1 **LCD**
Shows the amounts of tape, ribbon and ink in the machine, as well as various menus and error messages.
- 2 **Power indicator**
- 3 **Power button (⏻)**
Press to turn power on/off.
- 4 **Pause button (⏸)**
While printing, hold down this button to pause printing. Then, you can select whether to resume or cancel printing.
- 5 **Set button (🔄)**
Press after attaching tape or fabric ribbon to the paper core in order to prepare for printing.
- 6 **Cut button (✂)**
Cuts the tape.

*Fabric ribbon cannot be cut by pressing this button. Use scissors to cut fabric ribbon.

7 Status indicator

8 MENU/ESC button

While the machine is in standby, press this button to display the parameters that can be specified from the machine.

While performing operations with the buttons, press this button once to return to the previous screen.

Settings for the following parameters can be specified from the machine.

■ **Display Setting**

Switches the main screen between the **Details Mode** and the **View Mode**.

• **Details Mode**

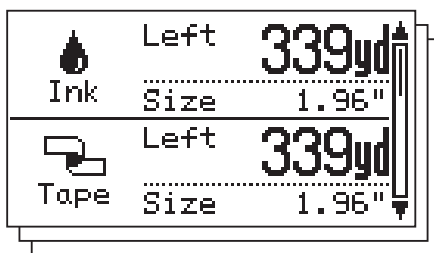

• **View Mode**

	Ink	Tape
Left	339yd	339yd
Size	1.96"	1.96"
Color	Black	White
Type	Polypro	Polypro
Core ϕ Size	3.00"	

NOTE

When the remaining quantity of tape, ribbon and ink is less than a set amount, "!" appears on the screen.

■ **Backlight**

■ **Unit**

■ **Language**

Set the language for the screens that appear.

■ **Auto Power Off**

■ **LCD Contrast**

■ **Cut Option**

■ **Check Size**

By default, a message will appear if the ink ribbon cassette is wider than the installed tape cassette. Printing will be possible after pressing the OK button.

To set the machine so no message appears when the installed ink ribbon cassette is wider than the tape cassette, select [**Off**].

■ **Printer Configuration**

■ **Network Configuration**

Displays the IP address, subnet mask and gateway address for the machine.

■ **Reset**

9 ▲/▼ buttons

Continues to the next screen, or returns to the previous screen.

10 OK button

Press to apply the selection.

Setting Up the Machine

Connecting the Power Supply

- 1 Plug the power cord into the power cord jack on the machine.
- 2 Plug the power cord into the power outlet.
- 3 Press the power button (⏻) on the machine to turn it on. The power indicator will illuminate green, and the machine is in standby.

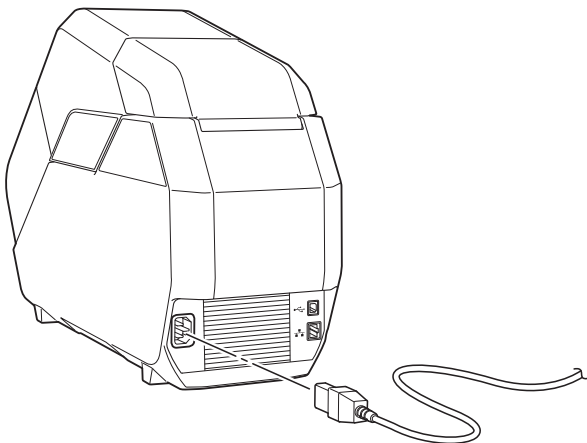

Unbundle the power cord before use.

Installing the Tape Cassette

Install the tape cassette in the machine. The tape cassette integrates a reel wound with tape and a reel wound with backing paper.

When printing on fabric ribbon, use the fabric ribbon cassette.

* The tape cassette is used in the procedures and illustrations.

- 1 Open the top cover and bottom cover of the machine. Press the open buttons (1) to open the covers.

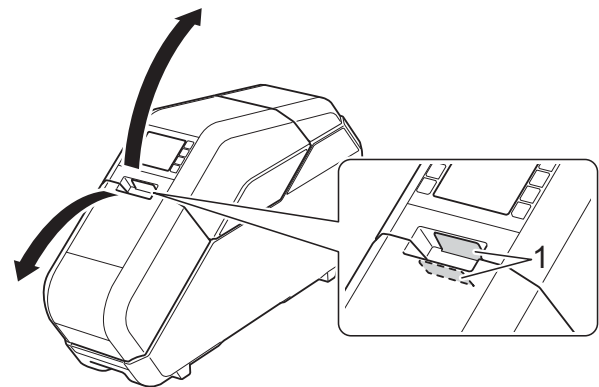

- 2 Make sure that there is no slack in the tape cassette.
 - If there is slack in the tape, turn the reel as shown to remove any slack.

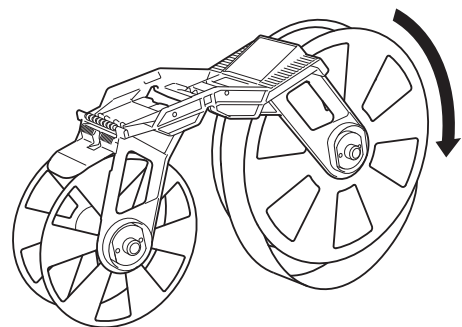

- If there is slack in the backing paper, turn the reel in the direction of the arrow to remove any slack.

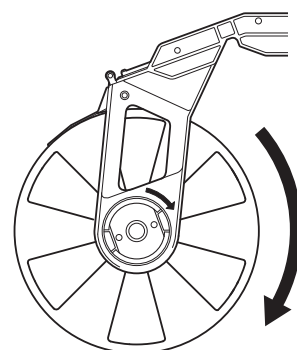

- 3 Make sure that the end of the tape (or fabric ribbon) extends from the tape cassette (or fabric ribbon cassette).

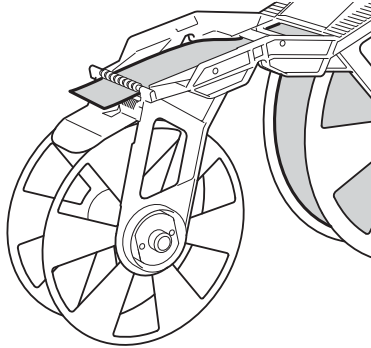

- 4 Hold the tape (or fabric ribbon) cassette with both hands, and then insert it into the machine with the tape (or fabric ribbon) reel toward the back of the machine.

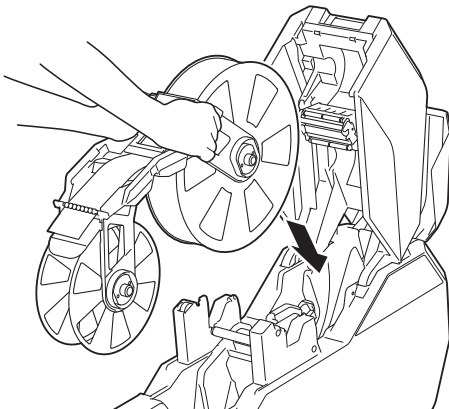

⊘ Do not directly touch the tape or fabric ribbon with your fingers.

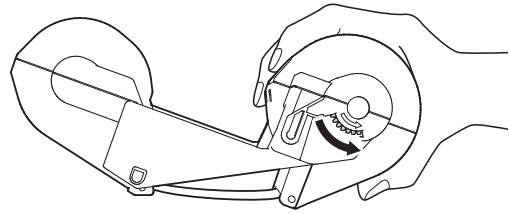

Installing the Ink Ribbon Cassette

- 1 Make sure that there is no slack in the ink ribbon cassette.
If there is slack in the ink ribbon, turn the gear in the direction of the arrow to remove any slack.



! Hold the ink ribbon cassette as shown.

⊘ Do not directly touch the ink ribbon with your fingers.

- 2 Install the ink ribbon cassette on top of the tape cassette.
Align  on the ink ribbon cassette with  on the machine.

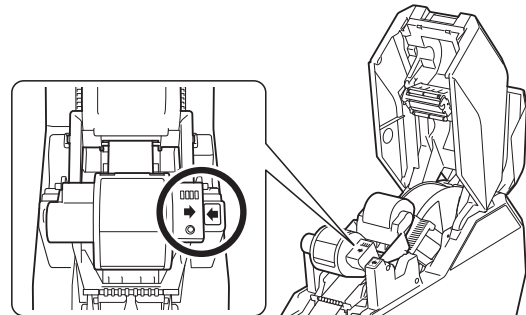

Installing the Paper Core Holder

Install, onto the paper core holder, the paper core to be wound with the printed tape.

* The paper core holder for tape is used in the procedures and illustrations.

- 1 Remove the rim of the paper core holder.

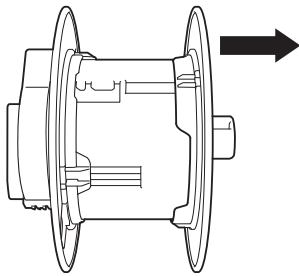

- 2 If the paper core holder is locked, rotate it in the direction of the arrow until it is unlocked.

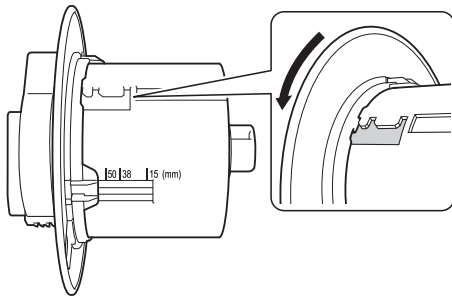

Adjust the paper core holder to the width of the paper core to be used. Use the marks on the paper core holder as a guide.

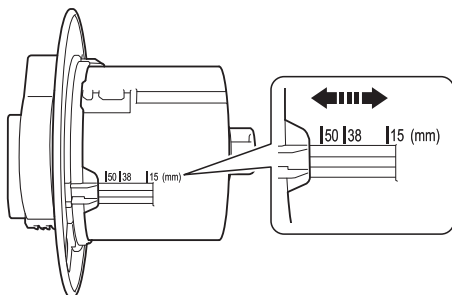

- 3 Rotate the rim of the paper core holder in the direction of the arrow until it locks into the slot of the paper core holder.

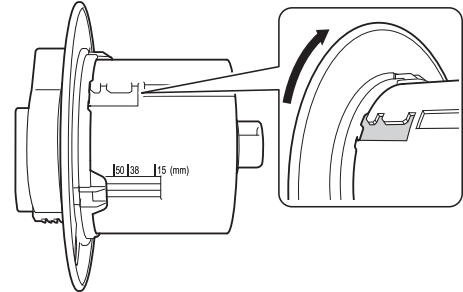

NOTE

There are multiple slots in the paper core holder. Make sure that all have been set for the correct width. If even one is incorrectly set, the machine will not operate correctly.

- 4 Slide the paper core onto the paper core holder.
- 5 Attach the rim of the paper core holder. Firmly attach the rim so that there is no gap between the paper core and the rims of the paper core holder.

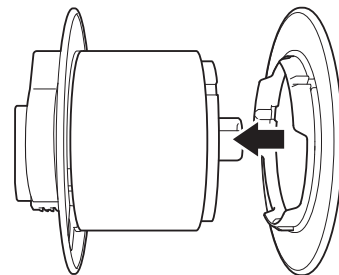

NOTE

If there is a gap between the paper core and the rims of the paper core holder, the tape will be incorrectly wound. Make sure that there are no gaps.

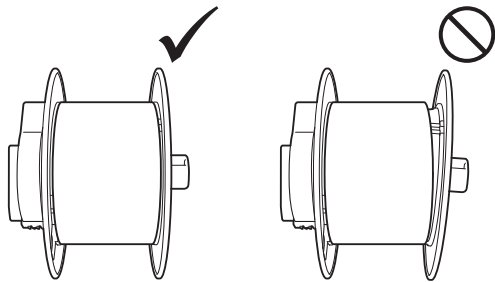

- 6 With the lock (1) of the paper core holder on the left, insert it into the machine.

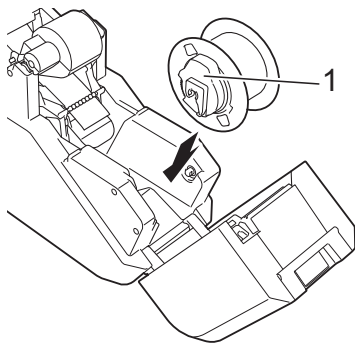

- 7 Pull the lock of the paper core holder toward you until it locks into place.

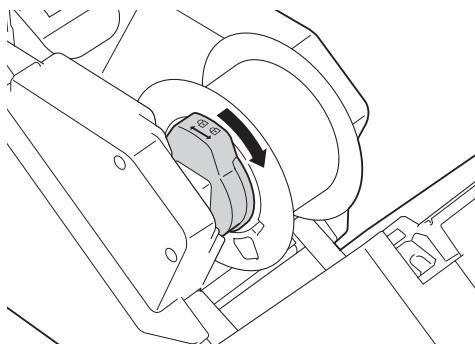

- 8 Pull the tape (or fabric ribbon) from the tape (or fabric ribbon) cassette, and then securely attach it to the paper core.

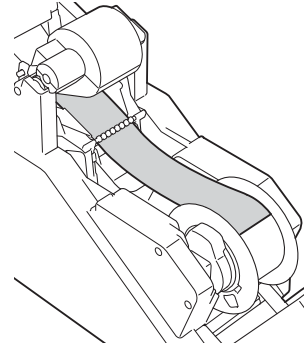

NOTE

- If the tape or fabric ribbon is not securely affixed, it may come off the paper core and be incorrectly wound.
- Correctly align the tape or fabric ribbon before affixing it. If the tape or fabric ribbon is affixed at an angle, it may wrinkle at the edge of the paper core holder and be incorrectly wound.

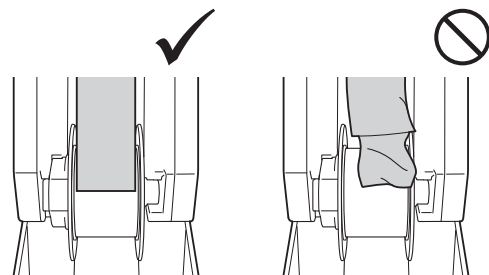

- When affixing the tape (or fabric ribbon) to the paper core, make sure that the tape (or fabric ribbon) does not attach to the guide (1) on the tape (or fabric ribbon) cassette. Otherwise, the tape (or fabric ribbon) will not wind on the paper core, resulting in a malfunction.

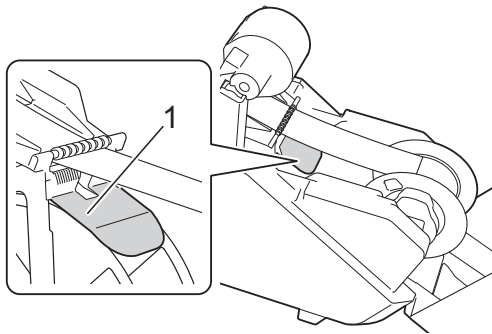

- 9 Close the top cover and bottom cover, and then press the set button (⊙). Press down on the covers until they click into place.

When the tape (or fabric ribbon) is installed, a test print is performed, and the tape (or fabric ribbon) is wound on the paper core.

NOTE

Look through the small window of the machine at the test-printed tape wound on the paper core to check the print condition and print position (left and right margins, etc.).

Good sample

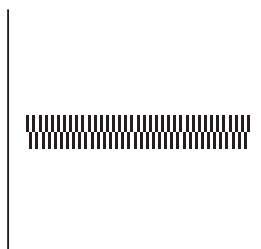

Bad sample

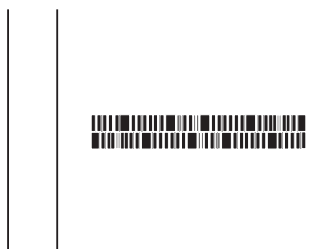

If the print position is shifted, adjust it by clicking [**Device settings**]-[**Print Position Adjustment**] (page 41) of the “**Printer Setting Tool**”.

This completes the machine setup.



- Do not open a cover during printing as it will not restart.
To pause printing, hold down the pause button (⏸). However, a space will be left in the printed tape when resuming printing after being paused. Take care when pausing printing.
- Do not open a cover while the tape is being cut, otherwise the tape cannot be cut correctly.
- Since fabric ribbon cannot be cut by pressing the cut button (✂), use scissors to cut the fabric ribbon after printing on it.

About the Tape Cassettes, Fabric Ribbon Cassettes and Ink Ribbon Cassettes

■ Storage

When the tape cassettes, fabric ribbon cassettes and ink ribbon cassettes are not being used, store them in their packaging. When the fabric ribbon cassettes are not being used, be sure to apply the lock to secure the ribbon after removing the cassette from the machine.

If the tape cassettes, fabric ribbon cassettes and ink ribbon cassettes are not stored in their packaging, they may become dusty, resulting in blurred printing.

■ Checking remaining quantities

The remaining quantities of the tape cassettes, fabric ribbon cassettes and ink ribbon cassettes are shown in the main screen on the LCD.

The remaining quantities can also be estimated by checking the markings on the tape cassettes, fabric ribbon cassettes and ink ribbon cassettes.

Installing the Printer Driver and Software

The printer driver and software can be installed using a USB cable connection or a wired network connection.



Before starting the installation, make sure that you are logged on to the computer with administrator rights.

- 1 Insert the installer CD-ROM into your CD-ROM drive. If the language screen appears, choose your language.

NOTE

If the installer screen does not automatically appear:

- Windows Vista®/Windows® 7:
Display the contents of the CD-ROM drive folder, and then double-click [**start.exe**].
- Windows® 8/Windows® 8.1:
Click [**Run start.exe**] in the [**Start**] screen, or display the contents of the CD-ROM drive folder from the desktop, and then double-click [**start.exe**].



1 Standard Installation

Installs P-touch Editor 5.1, the printer driver, P-touch Update Software and Printer Setting Tool.

2 Custom Installation

Allows P-touch Editor 5.1, the printer driver, P-touch Update Software and Printer Setting Tool to be individually selected for installation.

3 Advanced Applications

Installs the BRAdmin Light utility.

4 Brother Support

Displays the support website (Brother Solutions Center).

- 2 Click [**Standard Installation**]. Continue the installation according to the instructions that appear on the screen.

NOTE

If multiple TP-M5000N machines are to be connected to the network, check the IP address of the machine being connected, and then specify the appropriate settings. The IP address can be checked using any of the following methods.

- Press the MENU/ESC button, and then select “**Network Configuration**” in the menu that appeared. For details, see *Operation Panel* on page 13.
- Check with [**Communication settings**] of the “**Printer Setting Tool**”. For details, see *Communication Settings* on page 37.

Connecting the Computer and Machine

1

The machine can be connected to your computer using either of the following methods:

- USB cable connection
- Wired network connection

USB Cable Connection



Before connecting the machine to the computer, install the printer driver.

- 1 Before connecting the USB cable, make sure that the machine is turned off.
- 2 Plug the USB cable into the USB port on the back of the machine.
- 3 Plug the other end of the USB cable into the USB port on the computer.

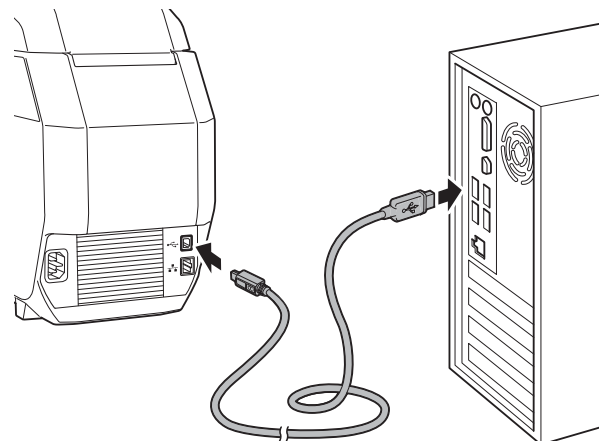

- 4 Turn on the machine.

Wired Network Connection



In order for the machine to use a static IP address to communicate through a wired network connection, the printer driver and the “**Printer Setting Tool**” must first be installed, and the wired network connection settings must be specified.

- 1 Before connecting the network cable, make sure that the machine is turned off.
- 2 Plug the network cable into the Ethernet network port on the back of the machine, and then turn on the machine.

NOTE

- The machine’s communication settings can be changed with [**Communication settings**] of the “**Printer Setting Tool**”. For details, see *Communication Settings* on page 37.
 - By using the “**Printer Setting Tool**”, the communication settings can be changed and easily applied to multiple machines. For details, see *Applying Setting Changes to Multiple Tape Creators* on page 40.
-

About the Software

The included software enables you to easily create your own tape and fabric ribbon designs, then save and manage them.

Before using the software, make sure you have installed the printer driver and the software from the included CD-ROM. Select **[Standard Installation]** from the CD-ROM **Top Menu** to install all required software.

To download the latest printer driver and software, visit the Brother Solutions Center at: <http://support.brother.com/>

Using P-touch Editor

P-touch Editor can be used to edit and create print designs.

The actual windows and dialog boxes of the software may differ from those shown in this manual depending on your computer's operating system.

1 Start P-touch Editor.

■ **Windows Vista®/Windows® 7:**

Click , **[All Programs]** - **[Brother P-touch]** - **[P-touch Editor 5.1]**.

■ **Windows® 8/Windows® 8.1:**

Click **[P-touch Editor 5.1]** on the **[Apps]** screen, or double-click **[P-touch Editor 5.1]** on the desktop.

When P-touch Editor starts, the startup window appears.

NOTE

- You can also start P-touch Editor using shortcuts if you selected to create shortcuts during installation.
 - Shortcut icon on the desktop: Double-click to start P-touch Editor.
 - Shortcut icon in the Quick Launch bar: Click to start P-touch Editor.
- To change how P-touch Editor functions when it is started, click **[Tool]** - **[Options]** in the P-touch Editor menu bar to display the **[Options]** dialog box. Click the **[General]** tab, and then select the desired setting in the **[Operations]** list box under **[Startup Settings]**. The default setting is **[Display New View]**.

- 2 In the startup window, select the data to be created.

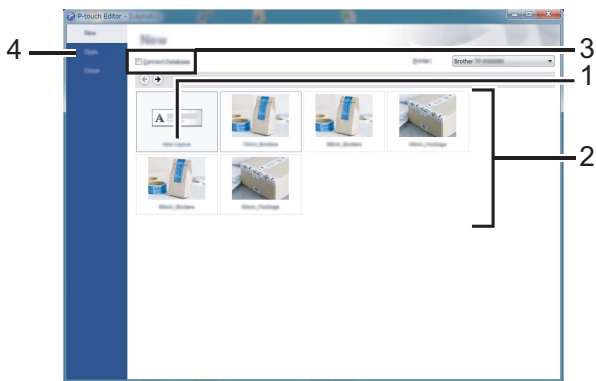

- 1 To create a new layout, click the **[New Layout]** button.
- 2 To create a new layout using a preset layout, double-click the desired tape or fabric ribbon width and category.
- 3 To connect a pre-set layout to a database, select the **[Connect Database]** check box.
- 4 To open an existing layout, click **[Open]**.

Operation Modes

P-touch Editor has three different operation modes: **[Express]** mode, **[Professional]** mode and **[Snap]** mode. You can easily switch between modes by using the mode selection buttons.

■ Express mode

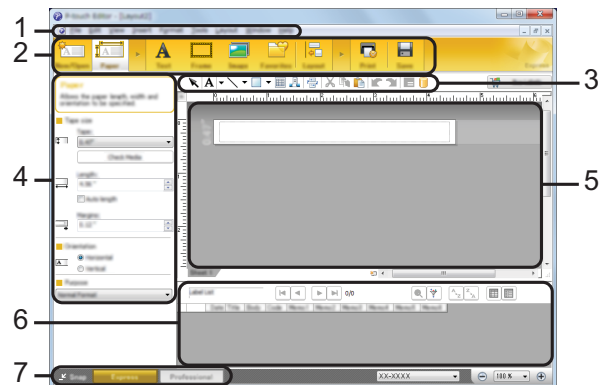

- 1 **Menu bar**
- 2 **Command bar**
- 3 **Draw/Edit toolbar**
- 4 **Property bar**
- 5 **Layout window**
- 6 **Database window**
- 7 **Mode selection buttons**

■ Professional mode

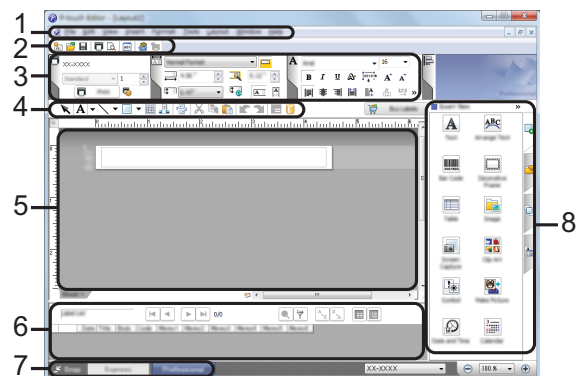

- 1 **Menu bar**
- 2 **Standard toolbar**
- 3 **Property palette**
- 4 **Draw/Edit toolbar**
- 5 **Layout window**

- 6 Database window
- 7 Mode selection buttons
- 8 Side bar

■ Snap mode

This mode allows you to capture all or a portion of your computer screen content, print it as an image, and save it for future use.

- 1 Click the **[Snap]** mode selection button. The **[Description of Snap mode]** dialog box appears.

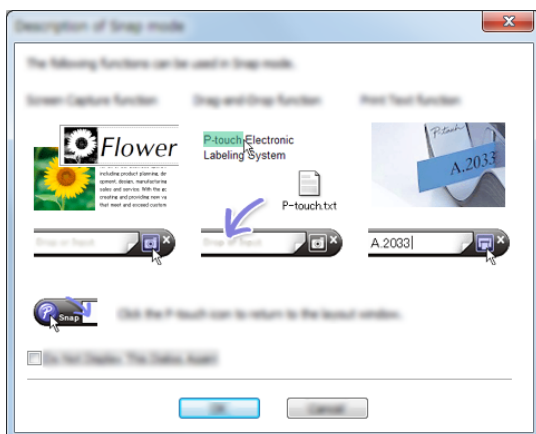

- 2 Click **[OK]**. The **Snap** mode palette appears.

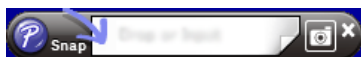

NOTE

- If you select the **[Do Not Display This Dialog Again]** check box in the **[Description of Snap mode]** dialog box, that dialog box will not appear the next time that you switch to **Snap** mode.
- **Windows Vista®/Windows® 7**
You can also start P-touch Editor in **[Snap]** mode by clicking  - **[All Programs]** - **[Brother P-touch]** - **[P-touch Editor 5.1 (Snap mode)]**.

- **Windows® 8/Windows® 8.1**
You can also start P-touch Editor in **[Snap]** mode by clicking **[P-touch Editor 5.1 (Snap mode)]** on the **[Apps]** screen.

Creating/Printing Tapes or Fabric Ribbons in P-touch Editor

Use P-touch Editor 5.1, which is included on the CD-ROM, to design and create tapes and fabric ribbons.

Using an Existing Design

P-touch Editor comes pre-installed with various designs. You can easily use an existing design as a template for creating your own tape or fabric ribbon designs.

In the following procedure, we will create the following tape design.

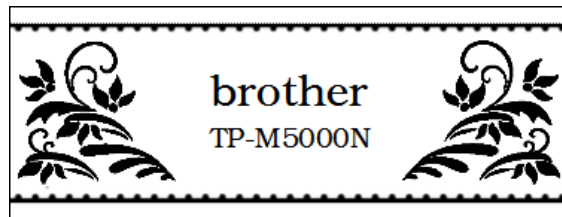

- P-touch Editor main window ([Express] mode)

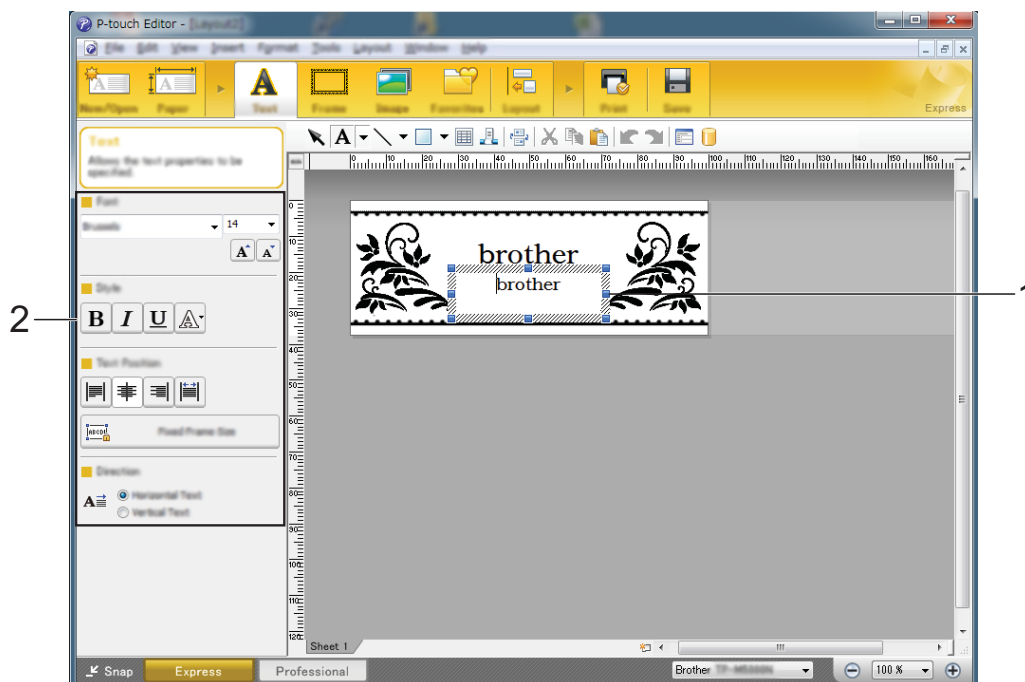

- 1 Start P-touch Editor 5.1.

- 2 Double-click the desired tape width and category.

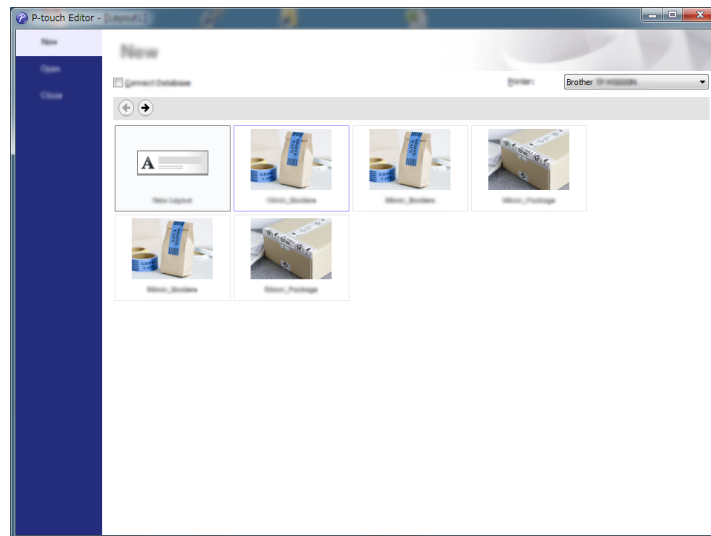

- 3 Double-click the desired design.
- 4 The text in the design can be changed.
Click the text to display the cursor, and then type in the text (1).
In this example, change “brother” to “TP-M5000N”.
- 5 Select the text object, and then change the font, character style, etc. (2).

NOTE

You can also change other format settings, such as the character size and text arrangement.

- 6 After creating the design, click [**Print**], and then click [**Print**] in the dialog box that appears.

NOTE

- To check and change the print settings, click [**Properties**].
- When printing starts, a line is printed to indicate the starting point.

Creating a New Design

P-touch Editor 5.1 can be used to create your own original tape or fabric ribbon designs. Logos and images can also be added to the design.



Very small text or images containing fine lines or detailed patterns may not be cleanly printed.

We recommend performing a test print and checking the print result.

Image lines and patterns of at least 1 point and a text size of at least 6 points (for tape) or 12 points (for fabric ribbon) are recommended.

In the following procedure, we will create the following tape design.



■ P-touch Editor main window ([Express] mode)

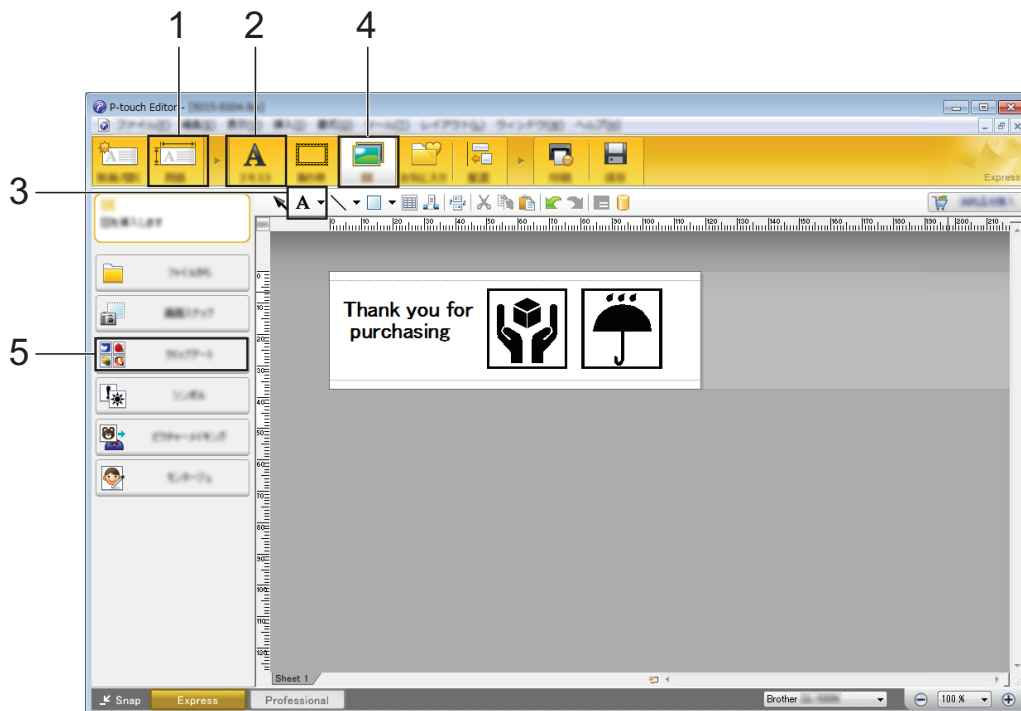

- 1 Start P-touch Editor 5.1.
- 2 Click [**New Layout**].
- 3 Specify the size of the tape to be created.
Click [**Paper**] (1), and then specify the tape size and length.
- 4 Type in the text.
Click [**Text**] (2), and then specify the font and character style.

- 5 Click **A** (3) to display the cursor so text can be typed in.
In this example, type “Thank you for purchasing”.

NOTE

After typing in the text, click the text box with the pointer in order to move it.

- 6 Arrange the image files.
Click **[Image]** (4), and then select **[Clip Art]** (5).
In this example, select **[Sings2]** from the **[Category]** list, and then select the desired image.
You can also adjust the size and position.
- 7 To replace an image; insert the new image, delete the unwanted image, and then move the new image to the location of the deleted image.

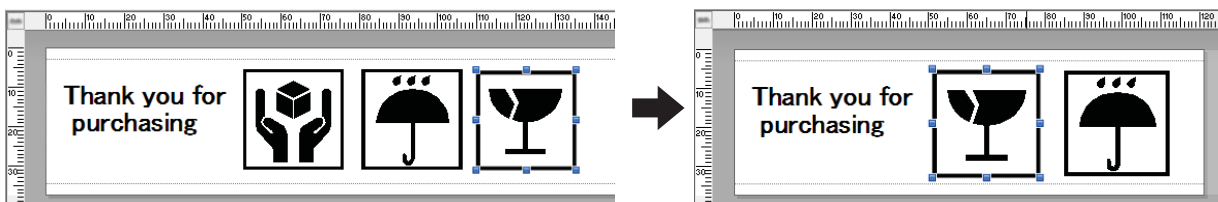

NOTE

To increase the spacing between the pattern repeating, drag the white end of the pattern to the right with your mouse.

- 8 Repeat these steps to complete the tape design.
- 9 After creating the design, click **[Print]**, and then click **[Print]** in the dialog box that appears.

NOTE

- To check and change the print settings, click **[Properties]**.
- When printing starts, a line is printed to indicate the starting point.

Creating Multiple Tapes or Fabric Ribbons

By using copy printing in P-touch Editor 5.1, you can create multiple copies of tapes or fabric ribbons with the same design.

■ In **Express** mode

- 1 After creating the tape or fabric ribbon design, click **[Print]**.
The **[Print]** dialog box appears.
- 2 After specifying the desired number of copies in **[Copies]**, click **[Print]** to begin printing.

■ In **Professional** mode

- 1 After creating the tape or fabric ribbon design, display the Print Properties (1).
- 2 In (2), specify the desired number of copies.
- 3 Click  (3) to begin printing.

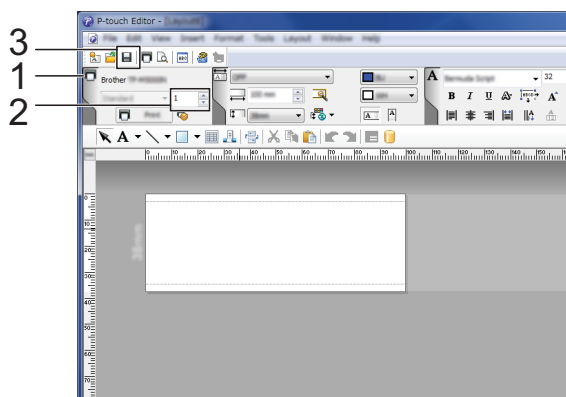

When a roll of tape has been printed with copy printing

- 1 When a roll of tape has been printed with copy printing, the machine will automatically stop.
The indicator blinks in green, and the machine is in setup standby.

- 2 Open the top cover and bottom cover of the machine, and then remove the printed tape or fabric ribbon.
After printing on fabric ribbon, use scissors to cut it, and then remove the printed fabric ribbon.
- 3 Install a new paper core.
For details, see *Installing the Paper Core Holder* on page 16.
- 4 Close the covers, and then press the set button ().
Printing continues.

Image Files

Pictures in the following formats can be inserted as image files into P-touch Editor.

- Bitmap File(*.bmp.*.dib)
- JPEG File(*.jpg.*.jpeg)
- GIF File(*.gif)
- TIFF File(*.tif)
- Icon File(*.ico)
- Windows Meta File(*.wmf.*.emf)
- PNG File(*.png)

Printing Data Created in Illustrator®

When creating original designs and logos in Illustrator® to insert into P-touch Editor, save the files as WMF format, not AI or EPS formats.

Images saved as AI or EPS formats must be converted to WMF format before use.

■ Creating WMF Format Files

- 1 In Illustrator®, open the image saved as AI or EPS format.
- 2 On the menu bar, click **[File] - [Export]**.
- 3 From the formats list, select **[Windows Metafile (*.WMF)]**, and then save the file at the desired location.

NOTE

To use WMF format images in P-touch Editor, click **[Insert] - [Image] - [From file]** on the menu bar.

Using P-touch Library

Using P-touch Library, you can manage P-touch templates and other data from your computer.

- 1 Start P-touch Library.

■ Windows Vista®/Windows® 7

Click , **[All Programs] - [Brother P-touch] - [P-touch Tools] - [P-touch Library 2.2]**.

■ Windows® 8/Windows® 8.1

Click **[P-touch Library 2.2]** on the **[Apps]** screen.

When P-touch Library starts, the main window appears.



1 Menu bar

Provides access to all available commands, which are grouped under each menu title (**[File]**, **[Edit]**, **[View]**, **[Tool]**, and **[Help]**) according to their functions.

2 Toolbar

Provides access to frequently used commands.

3 Folder list

Displays a list of folders. When you select a folder, the templates or other data in the selected folder is displayed in the templates list.





4 Templates list

Displays a list of the templates or other data in the selected folder.

5 Preview

Displays a preview of the template or other data selected in the templates list.

Explanations of Toolbar Icons

Icon/Button Name	Function
 Open	Opens the selected template.
 Print (Only for P-touch Library)	Prints the selected label template with the machine.
 Search	Allows you to search for templates or other data that are registered to P-touch Library.
 Display Style	Changes the file display style.

Registering Templates With P-touch Library

Templates or other data can be registered with P-touch Library using any of the following methods.

- Drag and drop the created template to the **[All contents]** folder or to the folder list.
- Follow the procedure below to automatically register created templates with P-touch Library.

- 1** On the P-touch Editor menu bar, click **[Tool]** - **[Options]**.
- 2** On the **[General]** tab of the **[Options]** dialog box, click **[Registration Settings]**.

- 3** Select the timing for registering templates created in P-touch Editor, and then click **[OK]**.

Using P-touch Library**Opening and Editing Templates**

Select the template to be opened or edited, and then click **[Open]**.

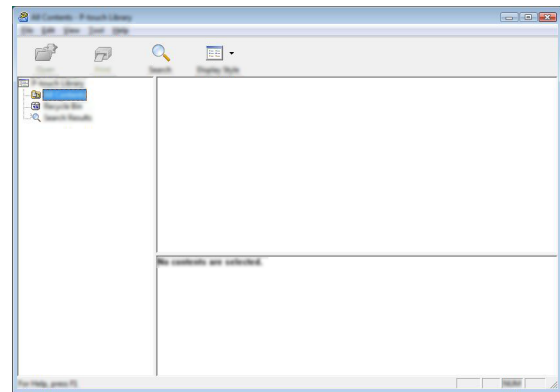

The program associated with the template will be started so that the template can be edited.

NOTE

The program that starts depends on the format of the file that was selected. For example, if you select a P-touch template, P-touch Editor starts.

Printing Templates

Select the template to be printed, and then click **[Print]**.

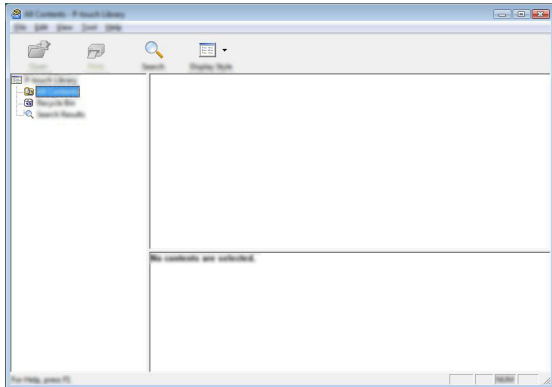

The template is printed with the connected Tape Creator.

Searching for Templates or Other Data

You can search for templates or other data registered with P-touch Library.

- 1 Click **[Search]**.
The **[Search]** dialog box appears.

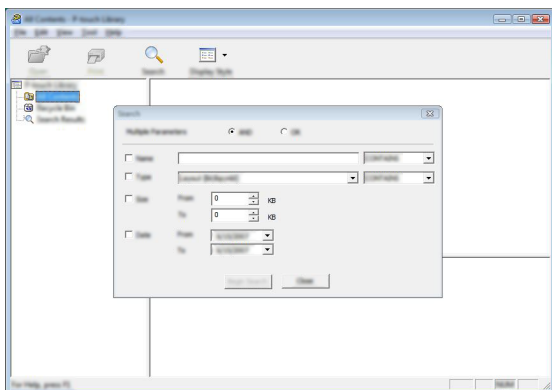

- 2 Specify the search criteria.
The following search criteria are available.

Criteria	Details
Multiple Parameters	Determines how the program searches when multiple criteria are specified. Select [AND] to search for files that satisfy all of the criteria. Select [OR] to search for files that satisfy any of the criteria.
Name	Allows you to search for a template or other data by specifying the file name.
Type	Allows you to search for a template or other data by specifying the file type.
Size	Allows you to search for a template or other data by specifying the file size.
Date	Allows you to search for a template or other data by specifying the file modification date.

- 3 Click **[Begin Search]**.
The search begins.

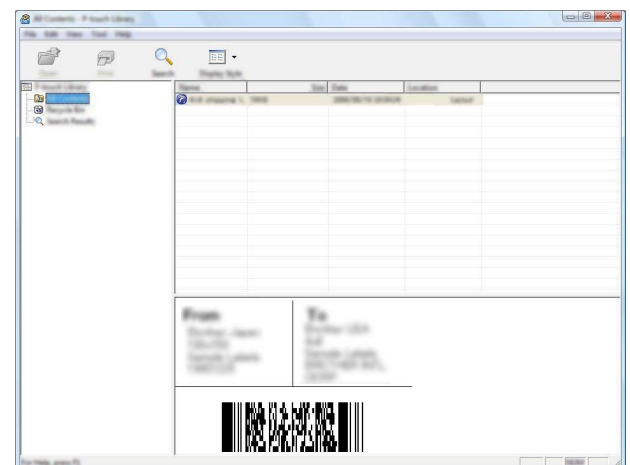

- 4 Close the **[Search]** dialog box.
The search results can be confirmed by clicking **[Search Results]** in the folder list.

Using the P-touch Update Software

By using the P-touch Update Software, P-touch Editor and the machine firmware can be updated to the newest versions.

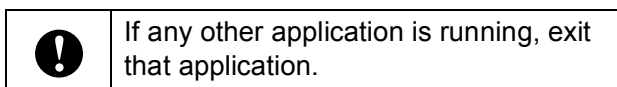
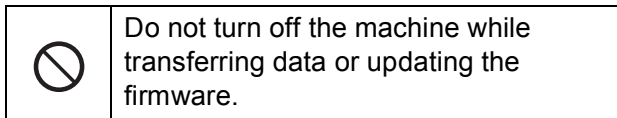

NOTE

- The P-touch Update Software must be used on a computer connected to the Internet.
- Your software may differ from the contents of this manual.
- When the P-touch Update Software is installed, an icon will appear on the desktop for your convenience.

Updating P-touch Editor or the Firmware

- 1 Connect the machine to the computer with a USB cable, and then turn on the machine.
- 2 The P-touch Update Software starts.
 - **Windows Vista®/Windows® 7:**
Double-click the [**P-touch Update Software**] icon.

NOTE

You can also start the P-touch Update Software using the following method.

Click , [**All Programs**] - [**Brother P-touch**] - [**P-touch Update Software**].

- **Windows® 8/Windows® 8.1:**

Click [**P-touch Update Software**] on the [**Apps**] screen, or double-click [**P-touch Update Software**] on the desktop.



- 3 Select the update function to be performed.
 - To update P-touch Editor:
Click the [**Computer software update**] icon, and then go to step 4.
 - To update the firmware:
Click the [**Machine update**] icon, and then go to step 5.

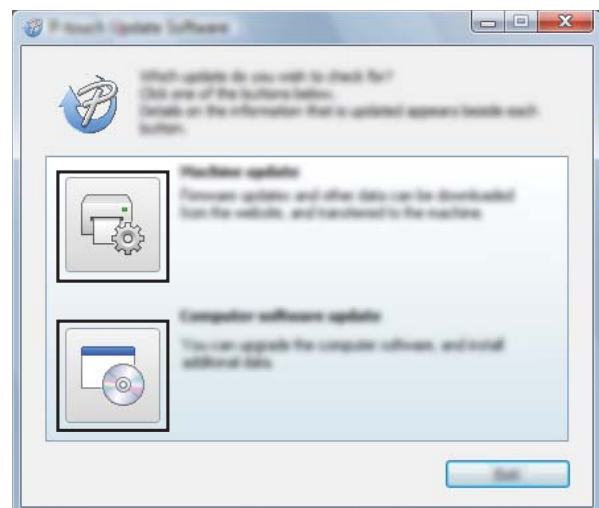

- 4 Select settings for **[Printer]** and **[Language]**, select the check box beside the P-touch Editor to be updated, and then click **[Install]**.

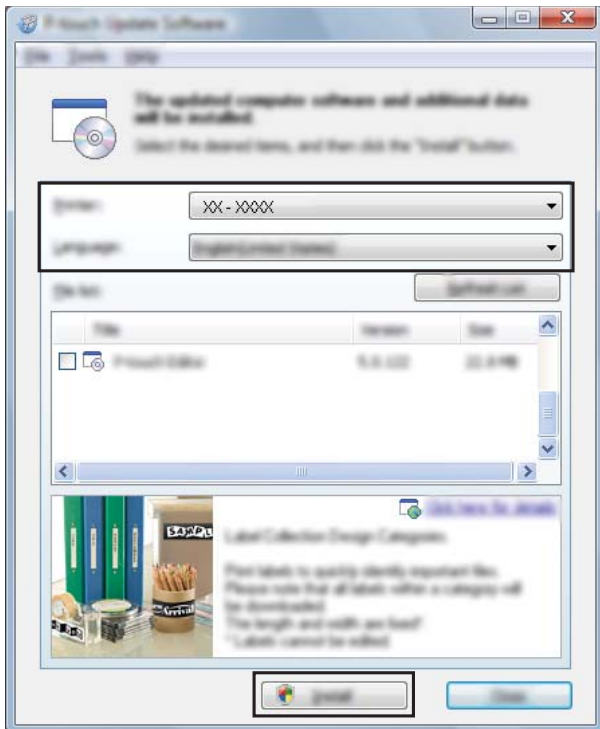

A message appears, indicating that the installation is finished. P-touch Editor has been updated.

- 5 Select a setting for **[Printer]**, check that **[The machine is connected correctly.]** appears, and then click **[OK]**.

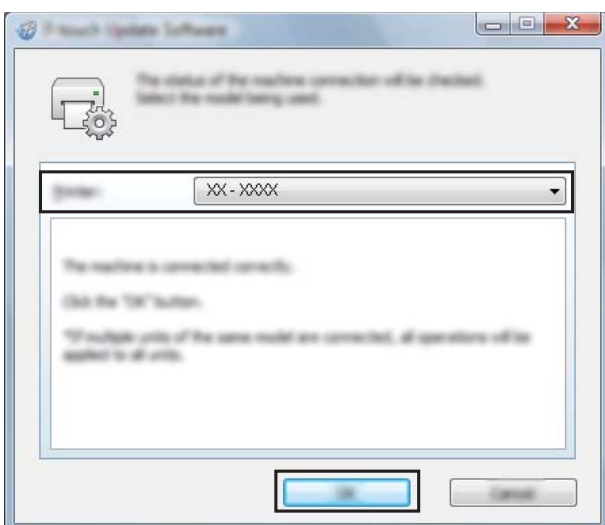

- 6 Select a setting for **[Language]**, select the check box beside the firmware to be updated, and then click **[Transfer]**. When a confirmation message appears, check the details of the data to be transferred, and then click **[Start]**.

 Do not turn off the machine or disconnect the cable while data is being transferred.

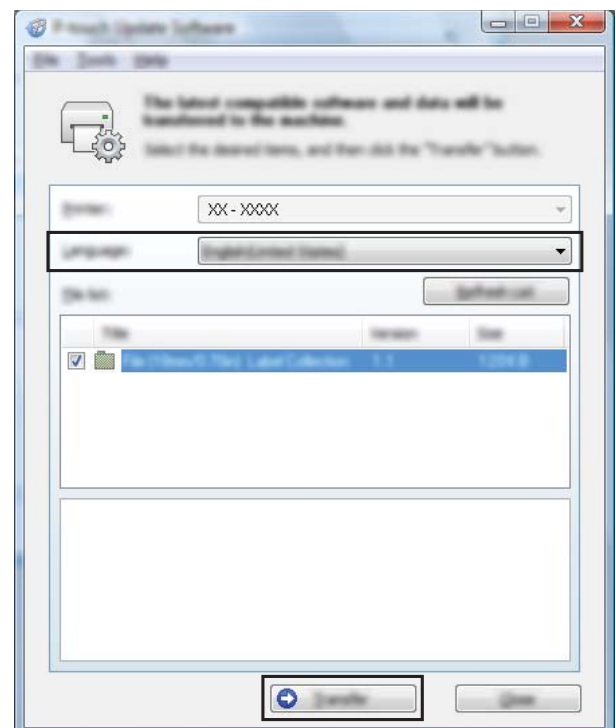

- 7 After the transfer is completed successfully, click **[OK]** to complete the operation.

3

Printer Setting Tool

About the Printer Setting Tool

By using the “**Printer Setting Tool**”, the machine’s communication settings and device settings can be specified from the computer.

NOTE

- The “**Printer Setting Tool**” is installed at the same time as other software such as the printer driver. For details, see *Installing the Printer Driver and Software* on page 20.
- The “**Printer Setting Tool**” is available only with Brother machines compatible with this tool.

Before Using the Printer Setting Tool

- Plug the machine into the power outlet with the power cord.
- Make sure that the printer driver has been installed and is functional.
- Connect this machine to a computer with a USB cable.

With this tool, settings cannot be specified using a wired network connection.

Using the Printer Setting Tool

- 1 Connect the Tape Creator to be configured to the computer.
- 2 Start “**Printer Setting Tool**”.



In order to open [Communication settings] and [Device settings], you must be logged on with administrator rights.

- Windows Vista®/Windows® 7:

Click , [All Programs] - [Brother] - [Label & Mobile Printer] - [Printer Setting Tool].

- Windows® 8/Windows® 8.1:

Click the [Printer Setting Tool] icon on the [Apps] screen.

The main window appears.

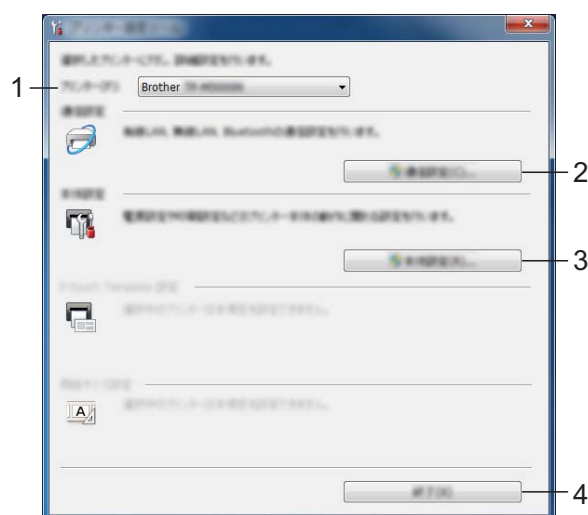

- 1 **Printer**
Select the Tape Creator to be configured.
- 2 **Communication settings**
Specify wired network communication settings.

- 3 **Device settings**
Specify Tape Creator device settings, such as power settings and print settings.

- 4 **Exit**
Closes the window.

- 3 Check that the Tape Creator to be configured appears beside **[Printer]**. If a different printer is displayed, select the desired Tape Creator from the drop-down list.

NOTE

If only one Tape Creator is connected, it is unnecessary to make a selection since only that machine will appear.

- 4 Click the button for the settings to be specified, and then specify or change the settings in the dialog box that appeared.
For more information about the settings dialog boxes, see *Communication Settings* on page 37 or *Device settings* on page 41.
- 5 After changing the settings, click **[Apply]** - **[Exit]** in the settings dialog box to apply the settings to the Tape Creator.
- 6 Click **[Exit]** in the main window to finish specifying settings.

	<p>Use the “Printer Setting Tool” to configure the machine only when the machine is in standby. The machine may malfunction if you attempt to configure it while it is handling a job.</p>
---	---

Communication Settings

Using **[Communication settings]** in the “**Printer Setting Tool**” when connected to the machine with a USB cable, you can set or change the network communication settings. Not only can you change the communication settings for one Tape Creator, but you can also easily apply the same settings to multiple Tape Creators.

3

Settings Dialog Box

Current Status Dialog Box

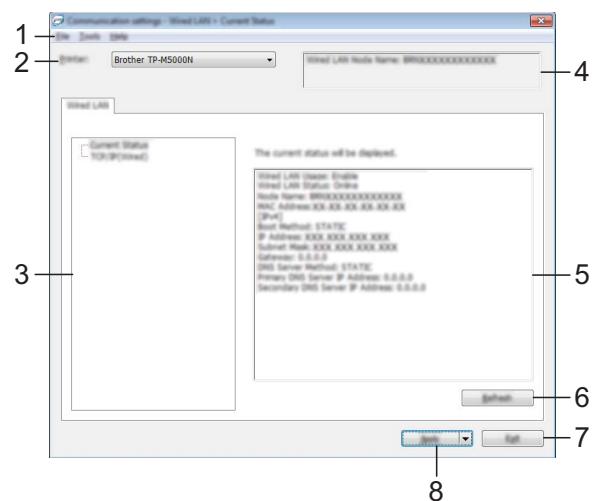

TCP/IP (Wired) Dialog Box

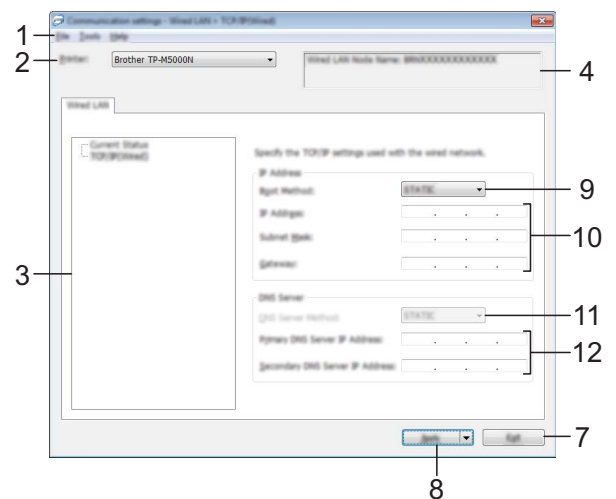

1 Menu bar

Select a command from a list contained in a menu. (See *Menu Bar* on page 38.)

2 Printer

Select the Tape Creator whose communication settings are to be specified.

If only one Tape Creator is connected, it is unnecessary to make a selection since only that machine will appear.

3 Items

When [**Current Status**] is selected, the current settings appear in the settings display/change area.

When [**TCP/IP (Wired)**] is selected, the settings can be changed.

4 Node Name

Displays the node name. The node name can also be changed. (See *Change Node Name/Bluetooth Device Name* on page 39.)

5 Settings Display/Change Area

Displays the current settings for the selected item. Change the settings as necessary using the drop-down menus, direct entry, or other appropriate methods.

6 Refresh

Click to update the displayed settings with the most recent information.

7 Exit

Exits [**Communication settings**], and returns to the main window of the “**Printer Setting Tool**”.

NOTE

Settings are not applied to machines if the [**Exit**] button is clicked, without clicking the [**Apply**] button after changing settings.

8 Apply

Click [**Apply**] to apply the settings to the machine.

To save the specified settings in a command file, select [**Save in Command File**] from the drop-down menu.

The saved command file can be used with the BRAdmin utility to apply the settings to a machine.

9 Boot Method

Select [**STATIC**], [**AUTO**], [**BOOTP**], [**DHCP**] or [**RARP**].

10 IP Address/Subnet Mask/Gateway

Specify the various values.

You can only enter settings when the IP address is set to [**STATIC**].

11 DNS Server Method

Select [**STATIC**] or [**AUTO**].

12 Primary DNS Server IP Address/Secondary DNS Server IP Address

You can only enter settings when the DNS server is set to [**STATIC**].

Menu Bar

Select a command from a list contained in a menu.

File Menu**■ Apply Settings to the Printer**

Applies the settings to the machine.

■ Save Settings in Command File

Saves the specified settings in a command file. The file extension is “.bin”.

The saved command file can be used with the BRAdmin utility to apply the settings to a machine.

NOTE

- The following information is not saved with the command file.
 - Node name
 - IP address, subnet mask and default gateway (when the IP address is set to [**STATIC**])
- The saved communication settings commands are only intended to be used for applying settings to a machine. The settings cannot be applied by importing this command file.



Do not send the command file to a Tape Creator whose model was not specified when the command file was exported.

■ Import

- **Select a Profile to import**

Imports the exported file and applies the settings to this tool.

Click [**Browse**] to display a dialog box to browse to the file. Select the file to be imported. The settings in the selected file appear in the settings display/change area.

NOTE

- All settings, such as TCP/IP settings, can be imported. However, node names cannot be imported.
- Only profiles that are compatible with the selected Tape Creator can be imported.
- If the imported profile's IP address is set to [**STATIC**], change the IP address of the imported profile, if necessary, so that it does not duplicate the IP address of an existing Tape Creator on the network whose settings have been completed.

■ Export

Saves the current settings in a file.

NOTE

Exported files are not encrypted.

Tool Menu

■ Option Settings

- **Automatically restart the printer after applying new settings**

If this check box is selected, the Tape Creator automatically restarts after communication settings are applied.

If this check box is cleared, the Tape Creator must be manually restarted.

NOTE

When configuring multiple Tape Creators, you can reduce the time required to change settings by clearing this check box. In this case, we recommend selecting this check box when configuring the first Tape Creator, so you can confirm each setting is operating as intended.

- **Automatically detects the connected printer, and retrieves the current settings.**

If this check box is selected when a Tape Creator is connected to the computer, the Tape Creator is automatically detected and its current settings are displayed in the [**Current Status**] pane.

NOTE

If a model other than a Tape Creator is shown in the [**Printer**] drop-down list, the settings available on all tabs change to match the connected printer.

■ Change Node Name/Bluetooth Device Name

The node name can be changed.

■ Reset to Default Communication Settings

Returns the communication settings to their factory defaults.

Help Menu

■ Display Help

Displays the Help.

■ About

Displays the version information.

Applying Setting Changes to Multiple Tape Creators

- 1 After applying settings to the first Tape Creator, disconnect the machine from the computer, and then connect the second Tape Creator to the computer.
- 2 Select the newly connected Tape Creator from the **[Printer]** drop-down box.

NOTE

If the **[Automatically detects the connected printer, and retrieves the current settings.]** check box in the **[Option Settings]** dialog box is selected, the Tape Creator connected with the USB cable is automatically selected.

For details, see *Automatically detects the connected printer, and retrieves the current settings.* on page 39.

- 3 Click **[Apply]**.
The same settings that were applied to the first Tape Creator are applied to the second Tape Creator.

NOTE

If the **[Automatically restart the printer after applying new settings]** check box is cleared, the Tape Creators will not be restarted after the settings are changed, reducing the time required to configure the machines. However, we recommend selecting the **[Automatically restart the printer after applying new settings]** check box when configuring the first Tape Creator so that you can confirm that a connection with the access point can be correctly established with the settings. For details, see *Automatically restart the printer after applying new settings* on page 39.

- 4 Repeat steps 1 – 3 for all the Tape Creators whose settings you wish to change.



If the IP address is set to **[STATIC]**, the Tape Creator's IP address will also be changed to the same address as the first machine.
Change the IP address if necessary.

NOTE

To save the current settings in a file, click **[File]** - **[Export]**.

The same settings can be applied to another Tape Creator by clicking **[File]** - **[Import]**, then selecting the exported settings file. (See *Import* on page 39.)

Device settings

Use the [Device settings] the “**Printer Setting Tool**”, to change the default Tape Creator settings.

When printing from a computer application, various printing settings can be specified from the printer driver; however, by using [Device settings] of the “**Printer Setting Tool**”, more advanced settings can be specified.

When [Device settings] is opened, the Tape Creator’s current settings are retrieved and displayed. If the current settings could not be retrieved, the previous settings are displayed. If the current settings could not be retrieved and previous settings have not been specified, this tool’s default settings are displayed.

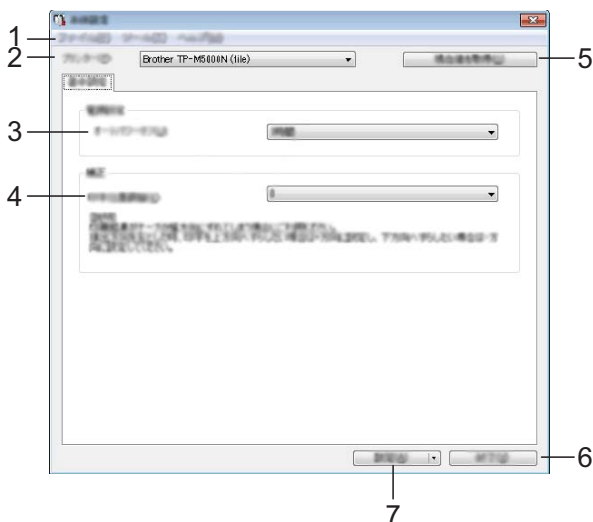

1 Menu bar

Select a command from a list contained in a menu. (See *Menu Bar* on page 41.)

2 Printer

Select the Tape Creator whose settings are to be specified.

If only one Tape Creator is connected, it is unnecessary to make a selection since only that machine will appear.

3 Auto Power Off

Specify the amount of time that passes before the machine turns off automatically.

4 Print Position Adjustment

Adjust the print position along the width of the tape or fabric ribbon.

When the tape or fabric ribbon is installed, a test print is performed, and the tape or fabric ribbon is wound on the paper core. Look through the small window of the machine at the tape or fabric ribbon wound on the paper core to check the print position.

5 Current Settings

Click this button to retrieve the settings from the currently connected Tape Creator and display them in the dialog box.

6 Exit

Exits [Device settings], and returns to the main window of the “**Printer Setting Tool**”.

7 Apply

Click [Apply] to apply the settings to the Tape Creator.

To save the specified settings in a command file, select [Save in Command File] from the drop-down menu.

Menu Bar

Select a command from a list contained in a menu.

File Menu

■ Apply Settings to the Printer

Applies the settings to the machine.

Performs the same operation as when the [Apply] button is clicked.

■ Save Settings in Command File

Saves the specified settings in a command file. The saved command file can be used with the BRAdmin utility to apply the settings to a machine. However, the setting for [Print Position Adjustment] is not saved.

Performs the same operation as when [Save in Command File] is selected from the [Apply] drop-down list.

■ Import

Imports the exported file and applies the settings to this tool.

■ Export

Saves the current settings in a file.

Tool Menu

■ Reset to Factory Defaults

Returns all Tape Creator settings, including the communication settings, to their factory defaults.

■ Option Settings

If the [**Do not display an error message if the current settings cannot be retrieved at startup.**] check box is selected, a message will not be displayed next time.

Help Menu

■ About

Displays the version information.

Specifying the IP Address, Subnet Mask and Gateway

Using the BRAdmin Light Utility

The BRAdmin Light utility is designed for the initial setup of this network-connected machine. It can also search for these machines in a TCP/IP environment, show the status and configure basic network settings, such as the IP address.

Installing BRAdmin Light

- 1 Make sure that the machine is turned on.
- 2 Turn on your computer. Before beginning installation, exit any applications that are running.
- 3 Insert the included CD-ROM into your CD-ROM drive. The opening screen appears.
- 4 The CD-ROM main menu appears. Click **[Advanced Applications]**.
- 5 Click **[BRAdmin Light]**, and then follow the on-screen instructions.

NOTE

- The newest version of BRAdmin Light can be downloaded from <http://support.brother.com/>.
- If more advanced management is required, use BRAdmin Professional after downloading the newest version from <http://support.brother.com/>.

- If a firewall, anti-spyware or antivirus software is being used, temporarily disable them. After checking that printing can be performed, enable them again.
- The node name appears in the BRAdmin Light window. The default node name for the machine is "BRNxxxxxxxxxxxx". ("xxxxxxxxxxxx" is based on your machine's MAC address/Ethernet address.)
- The default password for the machine is "access".

Setting the IP Address, Subnet Mask and Gateway With BRAdmin Light

- 1 Start BRAdmin Light.
 - Windows Vista®/Windows® 7:
 - Click , **[All Programs]** - **[Brother]** - **[BRAdmin Light]** - **[BRAdmin Light]**.
 - Windows® 8/Windows® 8.1:
 - Click **[BRAdmin Light]** on the **[Apps]** screen.
- 2 BRAdmin Light automatically searches for new devices.
- 3 Double-click the unconfigured device.

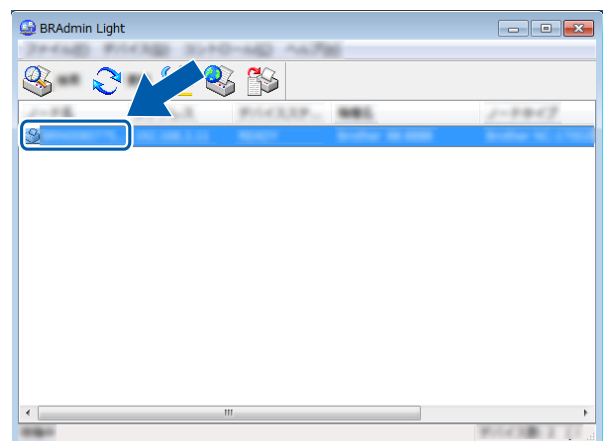

NOTE

If a DHCP, BOOTP or RARP server is not being used, the device will appear as **[Unconfigured]** in the BRAdmin Light utility screen.

- 4 Select **[STATIC]** for **[Boot Method]**. Specify settings for **[IP Address]**, **[Subnet Mask]** and **[Gateway]** of your machine, if necessary.

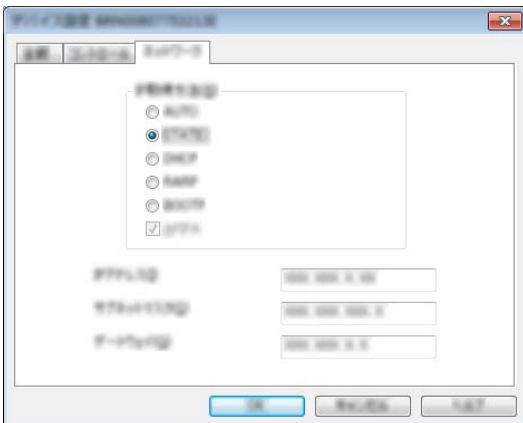

- 5 Click **[OK]**.
- 6 If the IP address has been correctly specified, the node and model name of the machine appears in the list.

Other Management Utilities

This machine can be used with the following management utilities in addition to the BRAdmin Light utility. You can change your network settings using these utilities.

Using Web-Based Management (Web Browser)

Using HTTP (Hypertext Transfer Protocol), a standard web browser can be used to change your print server settings. See *Configuring Machine Settings Using Web-Based Management (Web Browser)* on page 45.

Using the BRAdmin Professional Utility

BRAdmin Professional is a utility for more advanced management of network connected devices. This utility can search for Brother products on your network, and show the device status in an easy-to-read Explorer-style window with color changes indicating the status of each device. You can configure network and device settings as well as update device firmware from a Windows® computer on your local area network (LAN). BRAdmin Professional can also log activity of Brother devices on your network and export the log data in an HTML, CSV, TXT or SQL format.

For more information and download details, visit us at <http://support.brother.com/>.

NOTE

- The newest version of BRAdmin Professional can be downloaded from <http://support.brother.com/>.
- If a firewall, anti-spyware or antivirus software is being used, temporarily disable them. After checking that printing can be performed, enable them again.

- The node name appears in the BRAdmin Professional window. The default node name for the machine is “BRNxxxxxxxxxxxx”. (“xxxxxxxxxxxx” is based on your machine’s MAC address/Ethernet address.)
-

Managing With Web-Based Management (Web Browser)

Using HTTP (Hypertext Transfer Protocol), you can use a standard web browser to manage this machine on your network. When using web-based management, the following are possible:

- Display machine status information.
- Change network settings such as TCP/IP information.
- Display software version information of the machine and print server.
- Change network and machine configuration settings.

NOTE

Make sure that JavaScript and cookies are always enabled in whichever web browser you use.

In order to use web-based management, your network must use TCP/IP, and the machine and computer must have valid IP addresses.

Configuring Machine Settings Using Web-Based Management (Web Browser)

A standard web browser can be used to change print server settings by using HTTP (Hypertext Transfer Protocol).

- 1 Open your web browser.
- 2 Type “http://xxx.xxx.xxx.xxx” into the web browser’s address bar. (“xxx.xxx.xxx.xxx” is the IP address of the Brother machine.)
 - Example: If the IP address of the machine is 192.168.1.2
http://192.168.1.2/

NOTE

If you have edited the hosts file on your computer or are using a Domain Name System, enter the name assigned to this machine, instead of the IP address. Since the machine supports TCP/IP and NetBIOS, you can also enter the NetBIOS name of the machine. The NetBIOS name assigned is the first 15 characters of the node name and, by default, will appear as “BRNxxxxxxxxxxx” (where “xxxxxxxxxxx” is the Ethernet address).



If no password has been specified, you can specify one by clicking [**Please configure the password.**].

- 3 Change the print server settings.

Specifying a Password

We recommend specifying a password in order to prevent unauthorized access to web-based management. When a password is specified, unauthorized users will not be able to change settings except on the [**Basic**] tab.

- 1 Open your web browser.
- 2 Type “http://xxx.xxx.xxx.xxx/” into the web browser’s address bar.
“xxx.xxx.xxx.xxx” is the IP address of the Brother machine.
Example: If the IP address of the machine is 192.168.1.3
Type “http://192.168.1.3/” into the web browser’s address bar.
- 3 Click the [**Administrator**] tab.
- 4 Type in the password that you want to use (up to 32 characters).
- 5 Re-type the password in [**Confirm new password**].
- 6 Click [**OK**].

From next time you access to the Web Based Management, enter a password in the [**Login**] box, and then click . After configuring the settings, logout by clicking .

Network Specifications

The protocols and security features supported by the machine are listed below.

Interface	Ethernet	10BASE-T, 100BASE-TX
Network	Protocol (IPv4)	ARP, RARP, BOOTP, DHCP, APIPA (Auto IP), WINS/NetBIOS name resolution, DNS Resolver, mDNS, LLMNR responder, LPR/LPD, Custom Raw Port Port9100, FTP Server, TFTP server, SNTP client, SNMP v1/v2c, SNMP v3, ICMP

5

Maintenance

Perform machine maintenance as required. Some environments require that maintenance must be done more frequently (for example, if the machine is located in dusty conditions).



Before performing machine maintenance, turn off the machine, and then unplug the power cord from the power outlet.

Print Head Maintenance

CAUTION

Immediately after printing, the print head will be hot. Be careful not to be burned.



Do not directly touch the print head with your fingers.

- 1 Press the open button to open the top cover.
- 2 Lift up the protective cover (1), and then lightly wipe the print head (2) with the cleaning pen.

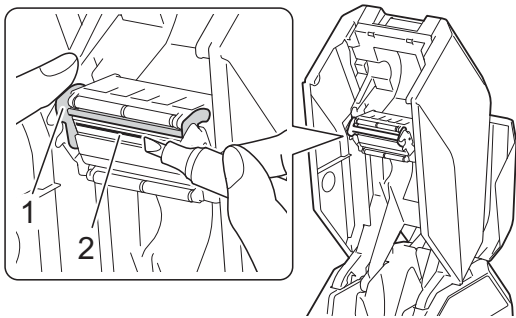

IMPORTANT

■ About cooling mode

If the print head becomes too hot, printing will stop so that the print head can cool down. At that time, an extra vertical line will be printed on the tape or fabric ribbon. After cooling, printing will resume.

This may occur when printing a high volume of text with a high print density.

To avoid or delay the onset of this condition, edit your design to reduce the detail.



When printing stops in cooling mode, do not open the top cover or bottom cover, otherwise printing will not resume.

Ink Ribbon Guide Roller Maintenance

- 1 Press the open button to open the top cover.
- 2 Clean the roller (1) with a cloth slightly moistened with ethanol or isopropyl alcohol.

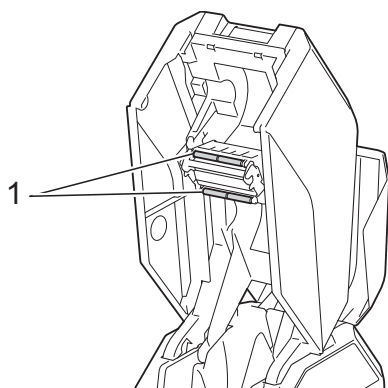

Do not use organic solvents such as benzene.

Platen Roller Maintenance

Use a piece of cellophane tape to remove dirt or dust from the surface of the platen roller (1).

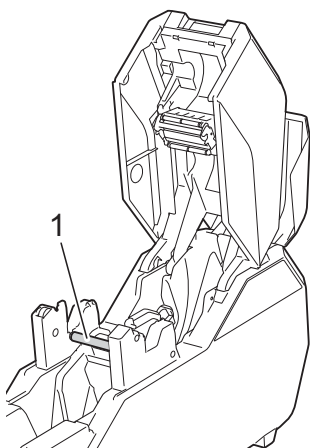

Bottom Cover Maintenance

- 1 Press the open button to open the bottom cover.
- 2 Clean the parts shown in gray in the illustration with a cloth slightly moistened with ethanol or isopropyl alcohol.

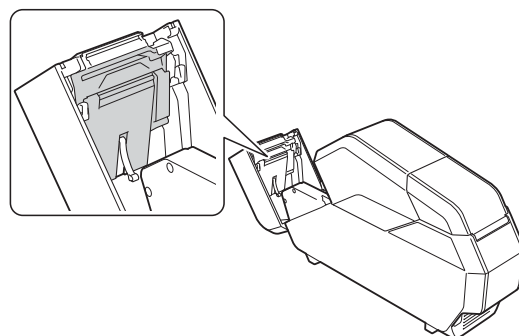

5

Paper Core Holder Maintenance

If tape adhesive accumulates on the inside (1) of the rims for the paper core holder, clean it off.

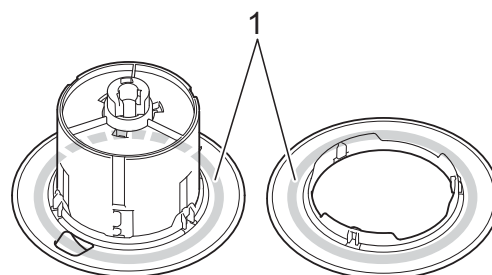

- 1 Remove the paper core holder from the machine, and then remove the paper core.
- 2 Clean with a cloth slightly moistened with ethanol or isopropyl alcohol.

6

Troubleshooting

When Indicators are Lit or Blink













The indicators light and blink to indicate the machine's status. The following symbols are used in this section to show the different indicator patterns. (G=Green, O=Orange and R=Red)

 : Indicator is lit

 : Indicator is blinking

(off) : Indicator is off

Example: G-=Indicator blinks in green

Power	Status	Description
G 	(off)	Machine is on Initializing
O 	(off)	Cover open
G- 	(off)	Preparing to print Transferring Setup standby during copy printing
O-  (once every second)	(off)	Cooling
O-  (once every 2 seconds)	(off)	Remaining tape/remaining fabric ribbon/remaining ink ribbon/size confirmation mode
G 	R-  (once every 1.8 seconds)	Tape incorrectly attached to the paper core Top cover open
G 	R-  (twice every 1.8 seconds)	Cutter error: Close the cover, and then turn the machine off, then on again. Power supply fan motor error: The power supply fan motor is not operating. Turn the machine off, then on again.
O-  (off)	R- 	System error
(off)	R 	Boot mode (operating system error)

When Messages Appear

Message	Solution
Cooling... Please Wait	Wait while the machine is cools down. Do not open the top cover or bottom cover, otherwise printing will not resume.
Head is Worn! Contact Customer Service	Contact your reseller or Brother Customer Service.

Problems and Solutions

Frequently Asked Questions

Problem	Solution
I want to correct a shift in the print position.	<p>Adjust the print position with the “Printer Setting Tool”.</p> <ol style="list-style-type: none"> Start “Printer Setting Tool”. <ul style="list-style-type: none"> Windows Vista® /Windows® 7: Click , [All Programs] - [Brother] - [Label & Mobile Printer] - [Printer Setting Tool]. Windows® 8/Windows® 8.1: Click the [Printer Setting Tool] icon on the [Apps] screen. After the main window appears, click [Device settings]. Change the setting for [Print Position Adjustment].

General

Problem	Solution
The machine does not turn on.	<ul style="list-style-type: none"> Is the power cord inserted correctly? Make sure that the power cord is inserted correctly. If it is, try plugging it into a different power outlet. Make sure you are using a genuine Brother power cord. If the power indicator still does not light up, contact your reseller or Brother Customer Service for assistance.
The indicators show that the machine is in boot mode (operating system error).	<ul style="list-style-type: none"> The power cord was unplugged while the firmware was being updated, and the machine started up in boot mode the next time it was started. This issue must be resolved. Contact your reseller or Brother Customer Service for assistance.
<p>The top cover or bottom cover was opened while the machine was cooling.</p> <p>The top cover or bottom cover was opened during printing.</p> <p>Media is jammed.</p>	<ul style="list-style-type: none"> Printing has stopped. Press the cut button () to cut the tape, and then remove the printed tape. After printing on fabric ribbon, use scissors to cut it, and then remove the printed fabric ribbon. Then, reinstall the paper core holder. For details, see <i>Installing the Paper Core Holder</i> on page 16.

Problem	Solution
<p>The pause button () was pressed.</p>	<ul style="list-style-type: none"> ■ Printing has paused. <p>While printing, hold down the pause button () to pause printing. Then, you can select whether to resume or cancel printing.</p> <ul style="list-style-type: none"> • If you selected to resume printing: A space will be left in the printed tape or fabric ribbon, and printing is restarted. • If you selected to cancel printing: To cancel printing and try again, press the cut button (✂) to cut the tape, and then remove the printed tape. After printing on fabric ribbon, use scissors to cut it, and then remove the printed fabric ribbon. Then, install a new paper core onto the paper core holder before installing it into the machine. For details, see <i>Installing the Paper Core Holder</i> on page 16.
<p>The indicators show that a system error has occurred.</p>	<p>If this condition occurs, turn off the machine, and then contact your reseller or Brother Customer Service for assistance.</p>

Problem	Solution
The machine does not print.	<ul style="list-style-type: none"> ■ Is a cable loose? Make sure that the cables are securely connected. ■ Is the status indicator blinking? An error occurred. Follow the instructions for the error message that appeared on the LCD. ■ Are the top cover and bottom cover firmly closed? Press down on the top cover and bottom cover until they click into place. ■ Are the tape cassette or fabric ribbon cassette and the ink ribbon cassette installed? Make sure that the tape cassette or fabric ribbon cassette and the ink ribbon cassette are installed. ■ Has the paper core holder been locked? Make sure that the paper core holder is locked. For details, see <i>Installing the Paper Core Holder</i> on page 16. ■ Check to see if there is any remaining ink, tape or fabric ribbon left on the cassette. Check to make sure there is enough remaining ink, tape or fabric ribbon to print your job. For details, see <i>Checking remaining quantities</i> on page 19. ■ Cancel the print job, and then turn off the machine. Turn the machine on, and then try printing again. ■ Check that the firmware has been updated to the newest version. The firmware version can be checked with the P-touch Update Software. For details, see <i>Using the P-touch Update Software</i> on page 34.
The tape or fabric ribbon is not fed correctly.	<ul style="list-style-type: none"> ■ Is the platen roller dirty? Use a piece of cellophane tape to clean the surface of the platen roller. For details, see <i>Platen Roller Maintenance</i> on page 49.
A data transmission error appears on your computer.	<ul style="list-style-type: none"> ■ Is the correct port selected? Make sure that the correct port is selected. ■ Is the machine in cooling mode (the power indicator is blinking in orange)? Wait until the indicator stops blinking, and then try printing again. ■ Is someone printing via the network? If you try to print while other users are printing large amounts of data, the machine will be unable to accept your print job until ongoing printing is finished. In such a situation, execute the print job again after the other jobs are completed.

Problem	Solution
<p>The tape or fabric ribbon is jammed.</p> <p>The tape or fabric ribbon is incorrectly wound.</p>	<ul style="list-style-type: none"> ■ Is there dust or dirt on the print head or ink ribbon guide rollers, preventing the rollers from turning freely? Clean the print head or ink ribbon guide rollers. For details, see <i>Print Head Maintenance</i> or <i>Ink Ribbon Guide Roller Maintenance</i> on page 49. ■ Is the inside of the rims for the paper core holder dirty, causing the tape or fabric ribbon to be incorrectly wound? Clean the paper core holder. For details, see <i>Paper Core Holder Maintenance</i> on page 49. ■ Remove the tape cassette or fabric ribbon cassette, and then reinstall it. Make sure there is no slack in the tape cassette or fabric ribbon cassette and the ink ribbon cassette. For details, see <i>Installing the Tape Cassette</i> on page 15. ■ Make sure that the covers are firmly closed. ■ Is the paper core holder correctly installed in the machine? Pull the lock of the paper core holder toward you to secure it firmly in the machine. Securely attach the tape or fabric ribbon to the paper core. If the tape or fabric ribbon is not securely affixed or is affixed at an angle, the tape or fabric ribbon will not be correctly wound.
<p>The tape, fabric ribbon or ink ribbon ran out during printing.</p>	<ul style="list-style-type: none"> ■ Replace the consumables with new ones. To restart printing after consumables are replaced, start printing again from the beginning of that roll. <ul style="list-style-type: none"> • With a USB cable connection To restart printing after replacing consumables, click [Resume] on the computer screen. To cancel printing, click [Cancel] on the computer screen. • With a wired network connection Printing is automatically restarted when the covers are closed after consumables have been replaced. To cancel printing, press the MENU/ESC button on the machine.
<p>The print quality is poor.</p> <p>Printed tape contains white streaks.</p> <p>Printed text is blurry.</p>	<ul style="list-style-type: none"> ■ Is the print head dirty? Clean the print head. For details, see <i>Print Head Maintenance</i> on page 48. ■ Is there dust or dirt on the ink ribbon guide rollers, preventing them from turning freely? Clean the ink ribbon guide rollers. For details, see <i>Ink Ribbon Guide Roller Maintenance</i> on page 49.

Problem	Solution
There are missing characters in the printed text.	<ul style="list-style-type: none"> ■ Is the print head dirty? Clean the print head. For details, see <i>Print Head Maintenance</i> on page 48. ■ Is there slack in the ink ribbon cassette? Make sure that there is no slack in the ink ribbon cassette, and then reinstall it. For details, see <i>Installing the Ink Ribbon Cassette</i> on page 16.
I want to reset the machine.	<p>To reset the machine, perform the following procedure.</p> <ol style="list-style-type: none"> 1 Press the power button (⏻) on the machine to turn it on. 2 Press the MENU/ESC button. 3 Press ▲ or ▼ to select [Reset], and then press the OK button. 4 Press ▲ or ▼ to select [Factory Reset], and then press the OK button. <p>All of the machine settings and transferred data from the computer will be deleted, and the machine will be reset to its factory settings.</p>
I want to stop the operation that is being performed.	Hold down the pause button (⏸).
I want to cancel the current print job.	While printing, hold down the pause button (⏸) to pause printing. Then, select to cancel printing.
Even though data is being sent to the machine, the power indicator is not blinking in green.	Make sure that the USB cable is firmly and correctly connected. Otherwise, try using a different USB cable.

Network



The machine is not found on the network during installation.

Checks	Solution
Is security software being used?	<ul style="list-style-type: none"> ■ Check the settings in the installer dialog box. ■ Grant permission if the security alert message appears while installing the printer driver and software.

The machine cannot print over the network.

The machine is not found on the network even after successful installation.

Checks	Solution
Is security software being used?	See <i>Security software is being used.</i> on page 57.

Checks	Solution
Is the machine assigned an available IP address?	<ul style="list-style-type: none"> ■ Check the IP addresses and the subnet masks. Make sure that both the IP addresses and subnet masks of your computer and the machine are correct and located on the same network. For information on how to check the IP address and subnet mask, ask the network administrator. ■ Use the [Communication settings] of the “Printer Setting Tool” to check the IP address, subnet mask and other network settings.
Did the previous print job fail?	<ul style="list-style-type: none"> ■ If the failed print job is still in your computer’s print queue, delete it. ■ Double-click the Tape Creator icon in the folder described below, and then click [Cancel All Documents] in the [Printer] menu. <ul style="list-style-type: none"> • Windows Vista® Click , [Control Panel] - [Hardware and Sound] - [Printers]. • Windows® 7 Click , [Devices and Printers] - [Printers and Faxes]. • Windows® 8/Windows® 8.1 On the [Apps] screen, click [Control Panel] - [Hardware and Sound] - [Devices and Printers] - [Printers and Faxes].
I have checked all the above, but the machine still does not print.	Uninstall the printer driver and software, and then reinstall them.

Security software is being used.

Checks	Solution
Did you grant permission when the security alert message appeared during a standard installation or BRAdmin Light installation or when using the printing features?	If you did not grant permission when the security alert message appeared, the firewall function of your security software may be preventing access. Some security software may block access without showing a security alert message. To allow access, see the instructions for the security software or contact the manufacturer.
Has the port number required for the Brother network features been specified?	<p>The following port number is used for Brother network features.</p> <ul style="list-style-type: none"> ■ BRAdmin Light → Port number 161 / Protocol UDP <p>For details on opening the port, see the instructions for the security software or contact the manufacturer.</p>

I want to check that my network devices are working correctly.

Checks	Solution
Are the machine, access point/router and network hub turned on?	<p>Check for the following.</p> <ul style="list-style-type: none"> ■ The power cord is correctly connected, and the machine is turned on. ■ All protective packaging has been removed from the machine. ■ The top cover and bottom cover are fully closed. ■ The tape cassette is correctly installed. ■ A network cable is securely connected to the machine and the router or hub.
Where can I find the machine's network settings, such as IP address?	<p>The IP address of the machine can be checked using any of the following methods.</p> <ul style="list-style-type: none"> ■ Press the MENU/ESC button, and then select "Network Configuration" in the menu that appeared. For details, see <i>Operation Panel</i> on page 13. ■ Use the [Communication settings] of the "Printer Setting Tool". For details, see <i>Communication Settings</i> on page 37.

Product Specifications

Item/Model Name		TP-M5000N		
■ Dimensions/Weight/Power Supply				
External Dimensions	Width/Depth/Height	Approximately 6.8" (W) × 25.4" (D) × 14.2" (H) (173 mm (W) × 647 mm (D) × 363 mm (H))		
Machine Weight		Approximately 19.84 lb (9.0 kg)		
Power Supply	AC Power Supply	AC 100 ~ 240 V, 50/60 Hz		
■ Printing/Feeding				
		Tape		Fabric ribbon
		0.59" (15mm)	1.49" (38 mm)/ 1.96" (50 mm)	0.59" (15 mm)/1.49" (38 mm)
Printing Specifications	Printing Technology	Thermal transfer		
	Maximum Print Height	1.73" (44 mm)		
	Printing Resolution	300 dpi		
	Print Speed ¹	6.89 in/s (175 mm/s)	8.86 in/s (225 mm/s)	6.89 in/s (175 mm/s)
	Maximum Wound Length	27 yds. (24.6 m)	72 yds. (65.8 m)	27 yds. (24.6 m)
	Minimum Wound Length	1 yd. (0.9 m)		
Tape/Fabric Specifications	Compatible Tape Width	0.59" (15 mm), 1.49" (38 mm), 1.96" (50 mm)		0.59" (15 mm), 1.49" (38 mm) ²
	Material	PET	OPP	Polyester satin
Paper Core Specifications	Compatible Paper Core Width	Same as compatible tape widths		
	Compatible Paper Core Inner Diameter	Φ3" (76.2 mm)		
¹ May differ depending on the media being used. ² Available consumables may differ by country.				

Item/Model Name		TP-M5000N	
■ Operating Environment			
		Tape	Fabric ribbon
Interface	USB	USB Ver. 2.0 (Full Speed) Device Class Printer Class	
	USB Connector	B type	
	Ethernet (Wired connection)	10/100 Base-TX RJ-45 connector	
Environment Temperature	Guaranteed Operating Temperature/ Humidity	41 – 95 °F (5 – 35 °C) 20 – 80% max. wet-bulb temperature: 80.6 °F (27 °C)	59 – 95 °F (15 – 35 °C) 20 – 80% max. wet-bulb temperature: 80.6 °F (27 °C)
■ System Requirements			
Compatible Operating System		Windows Vista® Windows® 7 Windows® 8 Windows® 8.1 Windows Server® 2008 Windows Server® 2008 R2 Windows Server® 2012 Windows Server® 2012 R2	
Hard disk		Disk space : 70 MB or more	
Memory		Windows Vista®/Windows Server® 2008/2008 R2/2012/2012 R2: 512 MB or more Windows® 7 : 1 GB or more (32-bit) or 2 GB or more (64-bit) Windows® 8/Windows® 8.1 : 1 GB or more (32-bit) or 2 GB or more (64-bit)	
Monitor		SVGA, high color or higher graphics card	

brother



Printed in China
LNA699001