

Layer 2 Fast Ethernet Switch

AT-FS708/POE

Installation Guide

Copyright © 2010, Allied Telesis, Inc.

All rights reserved. No part of this publication may be reproduced without prior written permission from Allied Telesis, Inc.

Allied Telesis and the Allied Telesis logo are trademarks of Allied Telesis, Incorporated. All other product names, company names, logos or other designations mentioned herein are trademarks or registered trademarks of their respective owners.

Allied Telesis, Inc. reserves the right to make changes in specifications and other information contained in this document without prior written notice. The information provided herein is subject to change without notice.

Electrical Safety and Emissions Standards

This product meets the following standards.

U.S. Federal Communications Commission

Radiated Energy

Note: This equipment has been tested and found to comply with the limits for a Class A digital device pursuant to Part 15 of FCC Rules. These limits are designed to provide reasonable protection against harmful interference when the equipment is operated in a commercial environment. This equipment generates, uses, and can radiate radio frequency energy and, if not installed and used in accordance with this instruction manual, may cause harmful interference to radio communications. Operation of this equipment in a residential area is likely to cause harmful interference in which case the user will be required to correct the interference at his own expense.

Note: Modifications or changes not expressly approved of by the manufacturer or the FCC, can void your right to operate this equipment.

Industry Canada

This Class A digital apparatus complies with Canadian ICES-003.

Cet appareil numérique de la classe A est conforme à la norme NMB-003 du Canada.

European Union Restriction of the Use of Certain Hazardous Substances (RoHS) in Electrical and Electronic Equipment

This Allied Telesis RoHS-compliant product conforms to the European Union Restriction of the Use of Certain Hazardous Substances (RoHS) in Electrical and Electronic Equipment. Allied Telesis ensures RoHS conformance by requiring supplier Declarations of Conformity, monitoring incoming materials, and maintaining manufacturing process controls.

RFI Emissions FCC Class A, EN55022 Class A, EN61000-3-2, EN61000-3-3, VCCI Class A, C-TICK, CE

Warning: In a domestic environment this product may cause radio interference in which case the user may be required to take adequate measures.

Immunity EN55024

Electrical Safety EN60950-1 (TUV), UL 60950-1 (CUL_{US})



Laser Safety EN60825

Translated Safety Statements

Important: The  symbol indicates that a translation of the safety statement is available in a PDF document titled “Translated Safety Statements” posted on the Allied Telesis website at <http://www.alliedtelesis.com/support/software/>. Refer to “Where to Find Web-based Guides” on page 13 to navigate to this document.

Contents

Preface	11
Safety Symbols Used in this Document.....	12
Where to Find Web-based Guides	13
Contacting Allied Telesis	14
Online Support	14
Email and Telephone Support.....	14
Returning Products.....	14
For Sales or Corporate Information.....	14
Warranty.....	14
Chapter 1: Overview	15
Features	16
Port Descriptions	17
Twisted Pair Ports	17
SFP Port.....	17
LEDs.....	19
eco-friendly Button.....	20
Power Supply	21
Power over Ethernet.....	22
Power Budgeting	23
Implementation.....	24
Ethernet Switching Basics	25
MAC Address Table	25
Duplex Mode	26
Auto-Negotiation.....	26
Store and Forward.....	27
Back Pressure and Flow Control.....	27
Chapter 2: Installation	29
Reviewing Safety Precautions.....	30
Selecting a Site for the Switch.....	33
Planning the Installation	34
Unpacking the Switch	35
Installing the Switch on a Table or Desktop.....	36
Mounting the Switch on a Wall	37
Installing the Switch in a Rack.....	39
Installing an Optional SFP Transceiver	41
Cabling and Powering on the Switch	43
Cabling the Twisted Pair Ports	43
Cabling an SFP Transceiver	44
Powering on the Switch.....	45
Chapter 3: Troubleshooting	47
Power Supply A/C LED is Off	47
LINK/ACT Port LED is Off.....	47

Appendix A: Technical Specifications	49
Physical Specifications	49
Environmental Specifications.....	49
Power Specifications.....	49
Power Cord Specifications.....	50
Safety and Electromagnetic Emissions Certifications.....	51
RJ-45 Twisted Pair Port Connectors and Pinouts.....	52

Figures

Figure 1. AT-FS708/POE Fast Ethernet Switch Front and Back Panels	16
Figure 2. SFP Transceiver	18
Figure 3. Front Panel eco-friendly Button	20
Figure 4. Attaching the Rubber Feet	36
Figure 5. Attaching Brackets for Wall Mounting.....	37
Figure 6. Mounting The Switch on the Wall	38
Figure 7. Attaching the Mounting Brackets.....	39
Figure 8. Mounting the Switch on the Rack.....	39
Figure 9. Inserting the SFP.....	42
Figure 10. Connecting the Twisted Pair Data Cables.....	43
Figure 11. Removing the Dust Cover from the SFP Transceiver	44
Figure 12. Connecting Fiber Optic Cables to the SFP Transceiver.....	44
Figure 13. Connecting the AC Power Cord	45
Figure 14. RJ-45 Connector and Port Pin Layout.....	52

Tables

Table 1. Safety Symbols	12
Table 2. Power LED	19
Table 3. Twisted Pair Port LEDs	19
Table 4. SFP Port LED	19
Table 5. IEEE 802.3af Class vs. Power Levels	23
Table 6. Twisted Pair Cabling and Distances	34
Table 7. MDI Pin Signals (10Base-T or 100Base-TX)	52
Table 8. MDI-X Pin Signals (10Base-T or 100Base-TX)	52

Preface



This guide provides the hardware installation instructions for your AT-FS708/POE Fast Ethernet switch. This preface contains the following sections:

- “Safety Symbols Used in this Document” on page 12
- “Where to Find Web-based Guides” on page 13
- “Contacting Allied Telesis” on page 14

Safety Symbols Used in this Document

This document uses the safety symbols defined in Table 1.

Table 1. Safety Symbols

Symbol	Meaning	Description
	Caution	Performing or omitting a specific action may result in equipment damage or loss of data.
	Warning	Performing or omitting a specific action may result in electrical shock.

Where to Find Web-based Guides

The product documentation for all Allied Telesis products are available in portable document format (PDF) on our web site at <http://www.alliedtelesis.com/support/software/>.

Once you access the web site, enter the hardware product model of your switch in the Search by Product Name field; for example, enter AT-FS708/POE. You can view the documents online or download them onto your local workstation or server.

Contacting Allied Telesis

This section provides Allied Telesis contact information for technical support as well as sales or corporate information.

Online Support

You can request technical support online by accessing the Allied Telesis Knowledge Base from the following web site:

www.alliedtelesis.com/support. You can use the Knowledge Base to submit questions to our technical support staff and review answers to previously asked questions.

Email and Telephone Support

For Technical Support via email or telephone, refer to the Allied Telesis web site: **www.alliedtelesis.com**. Select your country from the list displayed on the website. Then select the appropriate menu tab.

Returning Products

Products for return or repair must first be assigned a Return Materials Authorization (RMA) number. A product sent to Allied Telesis without a RMA number will be returned to the sender at the sender's expense.

To obtain an RMA number, contact the Allied Telesis Technical Support group at our web site: **www.alliedtelesis.com/support/rma**. Select your country from the list displayed on the website. Then select the appropriate menu tab.

For Sales or Corporate Information

You can contact Allied Telesis for sales or corporate information at our web site: **www.alliedtelesis.com**. Select your country from the list displayed on the website. Then select the appropriate menu tab.

Warranty

For warranty information on the AT-FS708/8POE, go to **www.alliedtelesis.com/warranty** for the specific terms and conditions of the warranty and for warranty registration.

Chapter 1

Overview

This chapter contains the follows sections:

- ❑ “Features” on page 16
- ❑ “Port Descriptions” on page 17
- ❑ “LEDs” on page 19
- ❑ “eco-friendly Button” on page 20
- ❑ “Power over Ethernet” on page 22
- ❑ “Ethernet Switching Basics” on page 25

Features

The AT-FS708/POE Fast Ethernet switch is an unmanaged switch with the following features:

- ❑ Eight 10/100Base-T twisted-pair ports with Power over Ethernet (PoE) capability
- ❑ Auto-Negotiation and Auto MDI/MDI-X on all twisted-pair ports
- ❑ One small form-factor pluggable (SFP) port to use as an uplink port with support for 1000Base-T copper or fiber SFP modules
- ❑ Up to 8K MAC address table
- ❑ Backpressure and IEEE802.3x flow control
- ❑ Low power eco-friendly operating mode
- ❑ Fanless design
- ❑ Power over Ethernet, IEEE 802.3af
- ❑ Desktop, wall-mount or rack-mount installation

Figure 1 illustrates the front/back panels of the AT-FS708/POE switch.

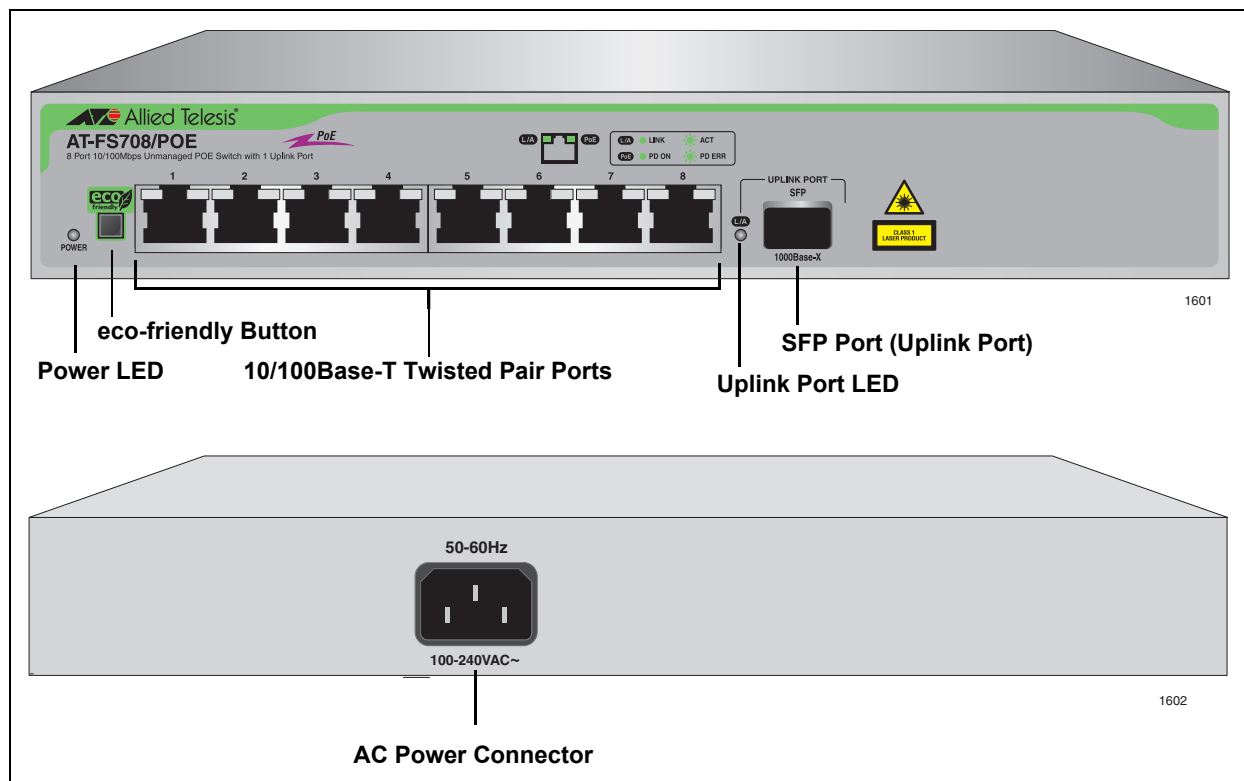

Figure 1. AT-FS708/POE Fast Ethernet Switch Front and Back Panels

Port Descriptions

The following sections describe the types of ports on the AT-FS708/POE Fast Ethernet switch:

- “Twisted Pair Ports,” next
- “SFP Port” on page 17

Twisted Pair Ports

The AT-FS708/POE Fast Ethernet switch features eight 10/100Base-T twisted-pair ports.

The twisted-pair ports feature 8-pin RJ-45 connectors. For the port pinouts, refer to “RJ-45 Twisted Pair Port Connectors and Pinouts” on page 52.

The ports are 10Base-T and 100Base-T compliant and are capable of 10 megabits per second (Mbps) and 100 Mbps speeds. The ports are IEEE 802.3u Auto-Negotiation and IEEE 802.3ab Auto-MDI/MDI-X compliant. The switch automatically matches the highest possible common speed between each switch port and each end node while sensing the correct polarity of the Ethernet cable. For example, if an end node is capable of only 10 Mbps, the switch sets the port connected to the end node to 10 Mbps.

Each twisted-pair port on the switch can operate in either half- or full duplex mode. The twisted-pair ports are IEEE 802.3u-compliant and will Auto-Negotiate the duplex mode setting.

Note

In order for the switch to set the duplex mode for each port correctly, the end nodes that you connect to the switch ports should also use Auto-Negotiation. Otherwise, a duplex mode mismatch can occur, affecting network performance.

Each twisted-pair port has a maximum operating distance of 100 m (328 feet).

For 10 Mbps operation, Category 3 or better 100 ohm shielded or unshielded twisted-pair cabling is required. For 100 Mbps operation, Category 5 and Enhanced Category 5 (5E) 100 ohm shielded or unshielded twisted-pair cabling is required.

The ports can operate as standard 10/100Base-T ports or as PoE ports.

SFP Port

The AT-FS708/POE switch has one SFP port that can accommodate an optional fiber or 1000Base-T copper Small Form-factor Pluggable (SFP) transceiver.

The SFP transceiver is a fast and easy way for you to add a 1000 Mbps fiber optic uplink port to your Fast Ethernet switch. You can use the SFP to extend the distance of your network, build a high-speed backbone network between switches, or connect additional end nodes to the network, such as high-speed servers.

Figure 2 shows an example of an SFP transceiver.

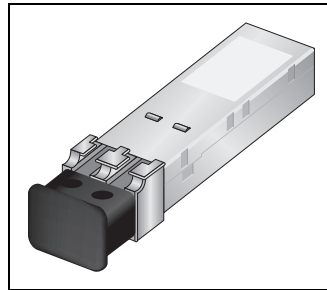

Figure 2. SFP Transceiver

Note

The SFP transceiver only supports Gigabit operation and works independently without taking any port priority.

Note

For a list of the SFP transceiver modules supported by the AT-FS708/POE Fast Ethernet switch, contact your Allied Telesis sales representative or refer to our web site at www.alliedtelesyn.com.

LEDs

The Power and port LEDs on the front panel of the AT-FS708/POE Fast Ethernet switch display the switch and its port status information.

Table 2 describes the Power LED.

Table 2. Power LED

LED	State	Description
PWR	Green	The switch is powered ON.
	OFF	The switch has no power.

Each twisted-pair port has two LEDs, as described in Table 3.

Table 3. Twisted Pair Port LEDs

LED	State	Description
L/A	Green	A valid link is established on the port.
	Blinking Green	Frames are being transmitted/received on the port at 10 or 100 Mbps.
	Off	No link is established on the port or the switch is operating in the eco-friendly mode.
PoE	Green	A PoE powered device is connected and is being powered by the port.
	Blinking Green	PoE is off because an error occurred on the powered device connected to the port.
	OFF	The port is not connecting to a valid powered device or the switch is operating in the eco-friendly mode.

Table 4 describes the SFP port LED.

Table 4. SFP Port LED

LED	State	Description
L/A	Green	A valid link is established on the SFP module in the SFP expansion slot.
	Blinking Green	Frames are being transmitted/received on the SFP module in the SFP expansion slot.
	OFF	No link is established on the SFP module in the SFP expansion slot or the switch is operating in the eco-friendly mode.

eco-friendly Button

The front panel eco-friendly button is illustrated in Figure 3 below. It enables the eco-friendly low power mode feature. This mode allows you to conserve power by turning off the port LEDs when they are not required. Press the eco-friendly button next to the Power LED and shown in Figure 3 to toggle the LEDs on or off. The eco-friendly mode does not affect the network traffic on the switch or the Power LED.

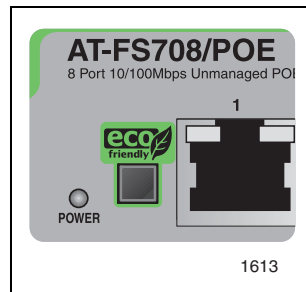

Figure 3. Front Panel eco-friendly Button

Power Supply

The AT-FS708/POE Fast Ethernet switch has an internal power supply with a single AC power supply socket on the back panel. To power the switch on or off, connect or disconnect the power cord provided with the switch.

Note

For the power requirements, refer to “Power Specifications” on page 49.

Power over Ethernet

The twisted-pair ports on the AT-FS708/POE Fast Ethernet switch feature Power over Ethernet (PoE). PoE is a mechanism for supplying power to network devices over the same twisted-pair cables used to carry network traffic. This feature can simplify network installation and maintenance by allowing you to use the switch as a central power source for other network devices.

A device that receives its power over an Ethernet cable is called a powered device (PD). Examples of such devices can be wireless access points, IP telephones, web cams, and even other Ethernet switches. A PD connected to a port on the switch will receive both network traffic and power over the same twisted-pair cable.

There are several advantages that the PoE feature of the AT-FS708/POE Fast Ethernet switch adds to the installation and maintenance of your network. First, because the switch acts as the central power source for your PDs, adding an uninterruptible power source (UPS) to the switch increases the protection not just to the switch itself from possible power source problems but also to all of the PDs connected to it. This can increase the reliability of your network by minimizing the impact to network operations from a power failure.

PoE can also simplify the installation of your network. A frequent issue in selecting a location for a network device is whether there is a power source nearby. This often limits equipment placement or requires the added cost and time of having additional electrical sources installed. With PoE, you can install PoE-compatible network equipment wherever they are needed without having to worry about whether they are near a power source.

The switch automatically determines whether or not a device connected to a port is a PD. A PD has a signature resistor or signature capacitor that the switch can detect over the Ethernet cabling. If the resistor or capacitor is present, the switch assumes that the device is a PD.

Power Budgeting

The AT-FS708/POE Fast Ethernet switch provides a maximum power of 15.4 W per port on four of the eight ports for a total power consumption of 65 W, while at the same time furnishing standard 10/100 Mbps Ethernet functionality. The AT-FS708/POE smart power management functionality also supports any combination of Ethernet ports (1-8) that supply power for IEEE 802.3af Class 0, 1, 2, or 3 powered devices up to a maximum of 65 watts, as described in Table 5.

Note

Power is supplied to the powered devices in the order that the ports are connected or on a first-come-first-served basis until the 65 watt limit is reached. If the switch is power cycled after the PoE devices are connected to the switch ports, the power is supplied to ports 1 through 8 in that order.

Table 5. IEEE 802.3af Class vs. Power Levels

Class	Usage	Maximum Power Levels Output at the PoE Port	Range of Power Levels Available at the PD Input
0	Default	15.4W	0.44W to 12.95W
1	Optional	4.0W	0.44W to 3.84W
2	Optional	7.0W	3.84W to 6.49W
3	Optional	15.4W	6.49W to 12.95W

Note

The Range of Power Levels Available at the PD Input reflect the loss introduced by a 100 meter Ethernet cable between the Power Source Equipment (PSE) and the Power Device (PD).

A port connected to a network node that is not a powered device (that is, a device that receives its power from another power source) functions as a regular Ethernet port, without PoE. The PoE feature remains enabled on the port but no power is delivered to the device.

Implementation

A standard Ethernet twisted-pair cable contains four pairs of strands for a total of eight strands. 10/100 Mbps network traffic requires only four strands (1, 2, 3, and 6), leaving four strands in the cable unused (4, 5, 7, and 8).

The PoE standard, IEEE 802.3af, describes two alternative ways for delivering power to a powered device (PD) over twisted-pair cabling. Alternative A uses the same strands that carry the network traffic. Alternative B uses the spare strands. The PoE implementation on the AT-FS708/POE Fast Ethernet switch is Alternative A, where power is transmitted over strands 1, 2, 3, and 6.

IEEE 802.3af compliant PD's typically support both power delivery methods. So long as a PD conforms with the standard, it should be able to receive its power from the switch with either a straight or cross-over cable. The PoE feature on the AT-FS708/POE Fast Ethernet switch will work with legacy PD's as long as the device can be powered on pins 1, 2, 3, and 6. A legacy device is a node that was manufactured before the IEEE 802.3af standard was completed and may not be compliant. If this is the case, a straight (MDI) cable may be needed to insure that the DC polarity is correct.

Ethernet Switching Basics

An Ethernet switch interconnects network devices, such as workstations, printers, routers, and other Ethernet switches, so that they can communicate with each other by sending and receiving Ethernet frames.

MAC Address Table

Every hardware device on your network has a unique MAC address. This address is assigned to the device by the device's manufacturer. For example, when you install a Network Interface Card (NIC) in a computer so that you can connect it to the network, the NIC already has a MAC address assigned to it by its manufacturer.

The MAC address table in the AT-FS708/POE Fast Ethernet switch can store up to 8K MAC addresses. The switch uses the table to store the MAC addresses of the network end nodes connected to the ports, along with the port number on which each address was learned.

A switch learns the MAC addresses of the end nodes by examining the source address of each packet received on a port. It will add the address and port to the MAC table where the packet was received if the address had not already been entered in the table. The result is a table that contains all the MAC addresses of the devices that are connected to the switch's ports, and the port number where each address was learned.

When the switch receives a packet, it also examines the destination address and, by referring to its MAC address table, determines the port on which the destination end node is connected. It then forwards the packet to the appropriate port and on to the end node. This increases network bandwidth by limiting each frame to the appropriate port when the intended end node is located, freeing the other switch ports for receiving and transmitting data.

If the switch receives a packet with a destination address that is not in the MAC address table, it floods the packet to all the ports on the switch. If the ports have been grouped into virtual LANs, the switch floods the packet only to those ports which belong to the same VLAN as the port on which the packet was received. This prevents packets from being forwarded into inappropriate LAN segments thereby increasing network security. When the destination end node responds, the switch adds its MAC address and port number to the table.

If the switch receives a packet with a destination address that is on the same port on which the packet was received, it discards the packet without forwarding it on to any port. Since both the source end node and the destination end node for the packet are located on the same port on the switch, there is no reason for the switch to forward the packet.

Duplex Mode

Duplex mode refers to how an end node receives and transmits data. If an end node can receive or transmit data, but not both simultaneously, the end node is operating in what is referred to as half-duplex mode. If an end node can both receive and transmit data simultaneously, the end node is said to be operating in full-duplex mode. Naturally, an end node capable of operating in full-duplex can handle data much faster than an end node that can only operate in half-duplex mode.

The twisted-pair ports on the AT-FS708/POE Fast Ethernet switch can operate in either half-or full-duplex mode. They are IEEE 802.3u-compliant and use Auto-Negotiation to set the duplex mode setting for you automatically.

Auto-Negotiation

For Auto-Negotiation to operate properly on a switch, the end nodes connected to the switch should also use Auto-Negotiation. If an end node does not have this feature and has a fixed duplex mode of full-duplex, the result will be a duplex mode mismatch between the end node and a switch port. An AT-FS708/POE port connected to an end node that is configured with a fixed duplex mode of full-duplex will operate at only half-duplex. This results in the end node using full-duplex and the switch port using half-duplex. This can produce network performance problems. If you encounter this situation, you must configure the port on the end node to use Auto-Negotiation or, if it lacks that feature, to half-duplex.

Note

Because the ports on the AT-FS708/POE Fast Ethernet switch operate in Auto-Negotiate mode only, the end nodes connected to the switch must also be configured to operate in the Auto-Negotiate mode. If an end node is configured to a specific duplex setting in a manual mode, it will not respond to the Auto-Negotiate protocol from the AT-FS708/POE Fast Ethernet switch. (The speed is determined from the link pulses, however, so the speed is always detected correctly.) As a result, the port setting on the switch will end up at half-duplex. If the end node is manually configured to full-duplex, there will be a duplex mismatch and data will be lost. If the end node is manually configured to half-duplex, both ports will have the speed and duplex match up correctly.

All of the twisted-pair ports on the switch are auto-MDI/MDI-X and IEEE 802.3ab-compatible. When a port's speed and duplex mode are set through Auto-Negotiation, the port uses the auto-MDI/MDI-X feature to automatically configure itself as MDI or MDI-X when connected to an end node. Consequently, you can use either a straight-through or crossover twisted-pair cable when connecting any network device to a port.

Store and Forward

The AT-FS708/POE Fast Ethernet switch uses store and forward as the method for receiving and transmitting frames. When a Ethernet frame is received on a switch port, the switch does not retransmit the frame out the destination port until it has received the entire frame and stored the frame in a port buffer. It then examines the frame to determine if it is a valid frame. Invalid frames, such as fragments or runts, are discarded by the switch. This insures that only valid frames are transmitted out the switch ports and that damaged frames are not propagated on your network.

Back Pressure and Flow Control

To maintain the orderly movement of data between the end nodes, an Ethernet switch may periodically need to signal an end node to stop sending data. This can occur under several circumstances. For example, if two end nodes are operating at different speeds, the switch, while transferring data between the end nodes, might need to instruct the faster end node to stop transmitting data to allow the slower end node to catch up. An example of this would be when a server operating at 100 Mbps is sending data to a workstation operating at only 10 Mbps.

How a switch signals an end node to stop transmitting data differs depending on the speed and duplex mode of the end node and switch port. A twisted-pair port operating at 100 Mbps and half-duplex mode will stop an end node from transmitting data by forcing a collision. A collision on an Ethernet network occurs when two end nodes attempt to transmit data using the same data link at the same time. A collision causes end nodes to stop sending data. When the switch needs to stop a 100 Mbps, half-duplex end node from transmitting data, it forces a collision on the data link, which stops the end node. When the switch is ready to receive data again, the switch stops forcing collisions. This is referred to as back pressure.

A port operating at 100 Mbps and full-duplex mode uses PAUSE frames, as specified in the IEEE 802.3x standard, to stop the transmission of data from an end node. Whenever the switch wants an end node to stop transmitting data, it issues this frame. The frame instructs the end node to cease transmission. The switch continues to issue PAUSE frames until it is ready again to receive data from the end node. This is referred to as flow control.

The AT-FS708/POE Fast Ethernet switch supports back pressure flow control in half duplex mode and pause frame flow control in full duplex mode.

Chapter 2

Installation

This chapter contains the following sections:

- ❑ “Reviewing Safety Precautions” on page 30
- ❑ “Selecting a Site for the Switch” on page 33
- ❑ “Planning the Installation” on page 34
- ❑ “Unpacking the Switch” on page 35
- ❑ “Installing the Switch on a Table or Desktop” on page 36
- ❑ “Mounting the Switch on a Wall” on page 37
- ❑ “Installing the Switch in a Rack” on page 39
- ❑ “Installing an Optional SFP Transceiver” on page 41
- ❑ “Cabling and Powering on the Switch” on page 43
- ❑ “Powering on the Switch” on page 45

Reviewing Safety Precautions

Please review the following safety precautions before you begin to install the switch or any of its components. The  indicates that a translation of the safety statements is available in a PDF document titled “Translated Safety Statements”. This other product documentation is posted on the Allied Telesis website at <http://www.alliedtelesis.com/support/software/>.

Note

Enter your hardware product model in the **Search by Product Name** field; for example, enter AT-FS708/POE. You can view the documents online or download them onto your local workstation or server.



Warning: Class 1 Laser product.  L1



Warning: Do not stare into the laser beam.  L2



Warning: To prevent electric shock, do not remove the cover. No user-serviceable parts inside. This unit contains hazardous voltages and should only be opened by a trained and qualified technician. To avoid the possibility of electric shock, disconnect electric power to the product before connecting or disconnecting the LAN cables.  E1





Warning: Do not work on equipment or cables during periods of lightning activity.  E2



Warning: Power cord is used as a disconnection device. To de-energize equipment, disconnect the power cord.  E3



Warning: Class I Equipment. This equipment must be earthed. The power plug must be connected to a properly wired earth ground socket outlet. An improperly wired socket outlet could place hazardous voltages on accessible metal parts.  E4

Pluggable Equipment. The socket outlet shall be installed near the equipment and shall be easily accessible.  E5



Caution: Air vents must not be blocked and must have free access to the room ambient air for cooling. *↪* E6

Warning: Operating Temperature. This product is designed for a maximum ambient temperature of 40° C. *↪* E7

All Countries: Install product in accordance with local and National Electrical Codes. *↪* E8



Caution: The attached mounting brackets must be used to securely mount the device on the wall. *↪* E15

Circuit Overloading: Consideration should be given to the connection of the equipment to the supply circuit and the effect that overloading of circuits might have on overcurrent protection and supply wiring. Appropriate consideration of equipment nameplate ratings should be used when addressing this concern. *↪* E21



Warning: Mounting of the equipment in the rack should be such that a hazardous condition is not created due to uneven mechanical loading. *↪* E25

If installed in a closed or multi-unit rack assembly, the operating ambient temperature of the rack environment may be greater than the room ambient temperature. Therefore, consideration should be given to installing the equipment in an environment compatible with the manufacturer's maximum rated ambient temperature (T_{mra}). *↪* E35

Caution: Installation of the equipment in a rack should be such that the amount of air flow required for safe operation of the equipment is not compromised. *↪* E36



Warning: Reliable earthing of rack-mounted equipment should be maintained. Particular attention should be given to supply connections other than direct connections to the branch circuits (e.g., use of power strips). *↪* E37



Warning: To reduce the risk of electric shock, the PoE ports on this product must not connect to cabling that is routed outside the building where this device is located. *↪* E40



Caution: The unit does not contain field serviceable components. Please return damaged units for servicing. *↪* E42



Caution: When you remove an SFP module from this product, the case temperature of the SFP may exceed 70° C (158° F). Exercise caution when handling with unprotected hands. *↪* E43

Selecting a Site for the Switch

Observe the following requirements when choosing a site for the AT-FS708/POE Fast Ethernet switch:

- ❑ If you plan to install the switch in an equipment rack, be sure that the rack is safely secured and that it will not tip over. Devices in a rack should be installed starting at the bottom, with the heavier devices near the bottom of the rack.
- ❑ If you are installing the switch on a table, be sure that the table is level and secure.
- ❑ The power outlet for the switch should be located near the unit and should be easily accessible.
- ❑ The site should provide for easy access to the ports on the front of the switch. This will make it easy for you to connect and disconnect cables, as well as view the switch's LEDs.
- ❑ To allow proper cooling of the switch, air flow around the unit and through its vents on the side and rear should not be restricted.
- ❑ Do not place objects on top of the switch.
- ❑ Do not expose the switch to moisture or water.
- ❑ Ensure that the site is a dust-free environment.
- ❑ You should use dedicated power circuits or power conditioners to supply reliable electrical power to the network devices.

Planning the Installation

Table 6 contains the cabling specifications for the twisted-pair ports.

Table 6. Twisted Pair Cabling and Distances

Speed	Type of Cable	Maximum Operating Distance
10 Mbps	Standard TIA/EIA 568-B-compliant Category 3 or better shielded or unshielded cabling with 100 ohm impedance and a frequency range extending up to 16 MHz.	100 m (328 ft.)
100 Mbps	Standard TIA/EIA 568-A-compliant Category 5 or TIA/EIA 568-B-compliant Enhanced Category 5 (Cat 5e) shielded or unshielded cabling with 100 ohm impedance and a frequency range extending up to 100 MHz.	100 m (328 ft.)

Note

The twisted-pair ports on the switch feature auto-MDI/MDI-X when operating at 10 or 100 Mbps. Each port is individually configured as MDI or MDI-X during the auto-negotiation process with an end node. Therefore, you can use either a straight-through or crossover twisted-pair cable when connecting any network device to a twisted-pair port on the switch.

Unpacking the Switch

To unpack an AT-FS708/POE Fast Ethernet switch, perform the following procedure:

1. Remove all components from the shipping package.

Note

Store the packaging material in a safe location. You must use the original shipping material if you need to return the unit to Allied Telesis.

2. Place the switch on a level, secure surface.
3. Ensure the following hardware components are included in your switch package. If any item is missing or damaged, contact your Allied Telesis sales representative for assistance.
 - Two wall mounting brackets
 - Four plastic anchors
 - Four self-tapping phillips-head screws
 - Two rack mounting brackets
 - Six mounting bracket screws
 - Four rack mount screws
 - Four self-adhesive rubber feet (for desktop use)
 - One AC power cord

Installing the Switch on a Table or Desktop

To install the switch on a table or desktop, perform the following procedure:

1. Remove all the items from the packaging and store the packaging material in a safe place. In the event a problem occurs and you need to return the unit, please use as much of the original shipping material as possible.
2. Attach the four self-adhesive rubber feet to the bottom of the switch, as shown in Figure 4.

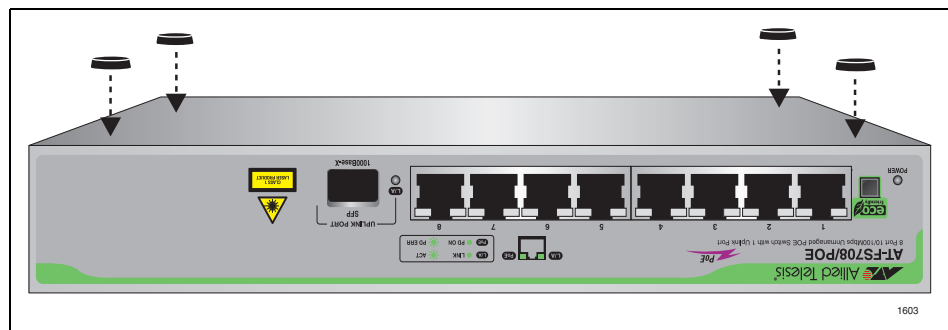

Figure 4. Attaching the Rubber Feet

3. Place the switch on a flat and secure surface, leaving ample space around the switch for ventilation.

Refer to “Cabling and Powering on the Switch” on page 43 to complete the installation.

Mounting the Switch on a Wall

You can mount the AT-FS708/POE Fast Ethernet switch on the wall in a vertical position using the mounting brackets and plastic anchors that are shipped with the switch.

Note

The plastic anchors used for wall mounting the switch are intended for installation in walls made of sheet rock or concrete materials.

To mount the switch on a wall, perform the following procedure:

1. If attached, remove the rubber feet using a flat-head screwdriver.
2. Select a wall location for the switch.
3. Turn the switch over and attach a mounting bracket to each side of the switch using the bracket mounting screws, as shown Figure 5.

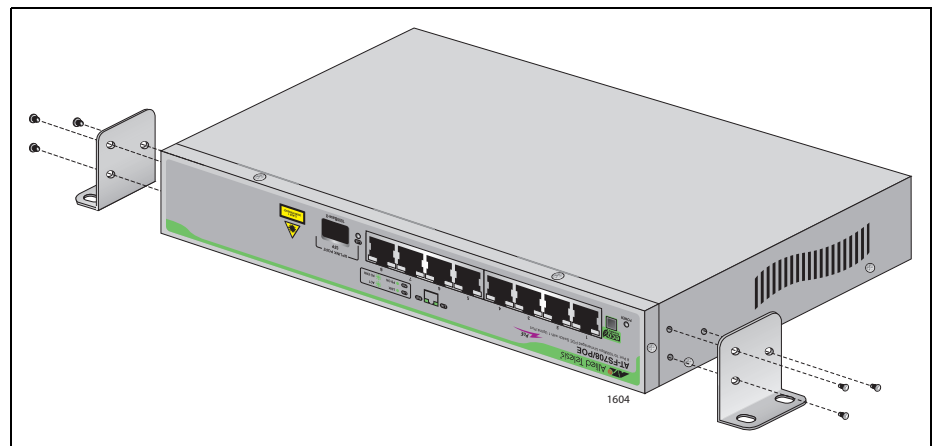

Figure 5. Attaching Brackets for Wall Mounting

4. Position the switch on the wall with the top of the switch against the wall and the ports facing up. Make sure the switch is in a level position.
5. Mark the hole positions of the wall mounting bracket holes on the wall.
6. Drill four 0.635 cm (0.25 in) holes in the wall centered on the marks made in step 5.
7. Insert the four plastic anchors into the holes.
8. Mount the switch on the wall using the self-tapping phillips-head screws, as shown in Figure 6.

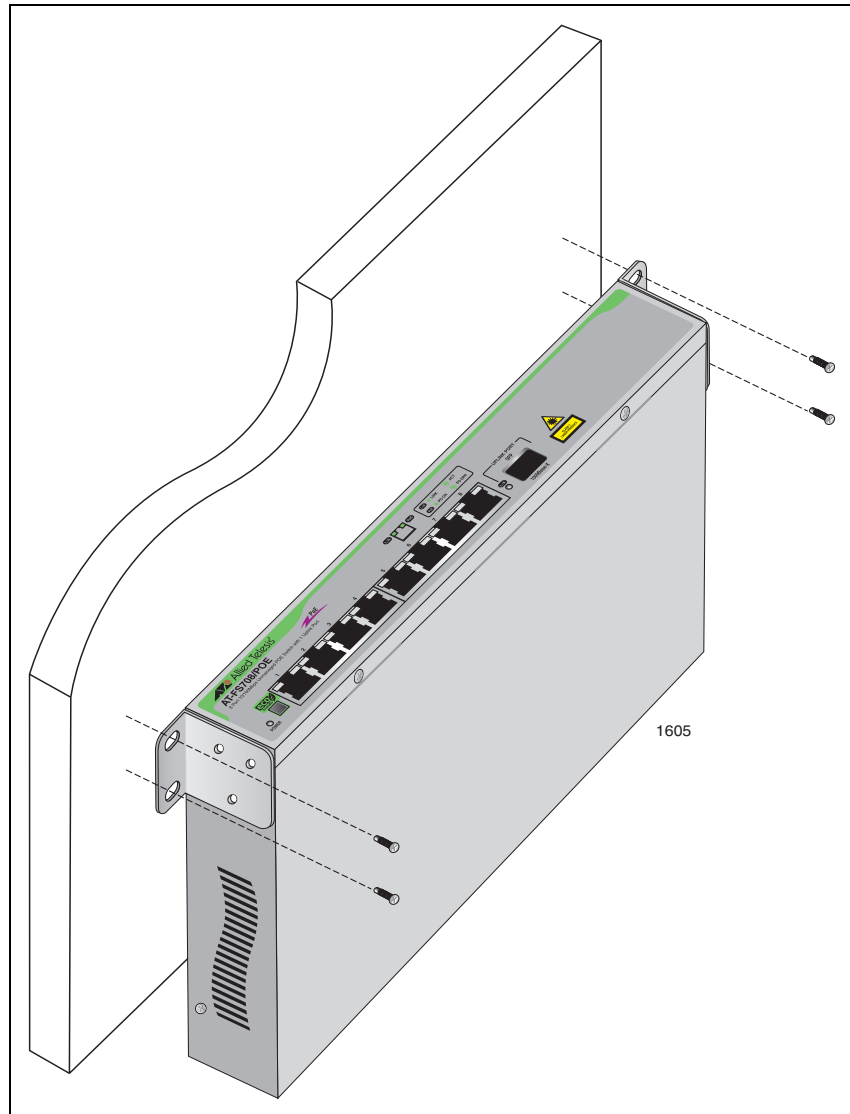

Figure 6. Mounting The Switch on the Wall

9. Refer to “Cabling and Powering on the Switch” on page 43 to attach Ethernet cables and power cable.
10. To prevent accidental disconnection of the AC power cord, we recommend that you fasten the power cord to the wall with the appropriate cable fastener hardware (not provided) within six inches of the AT-FS708/POE Fast Ethernet switch back panel.

Installing the Switch in a Rack

To install the switch in a rack, perform the following procedure:

1. If attached, remove the rubber feet using a flat-head screwdriver.
2. Attach a mounting bracket to each side of the switch using the six bracket mounting screws as shown Figure 7.

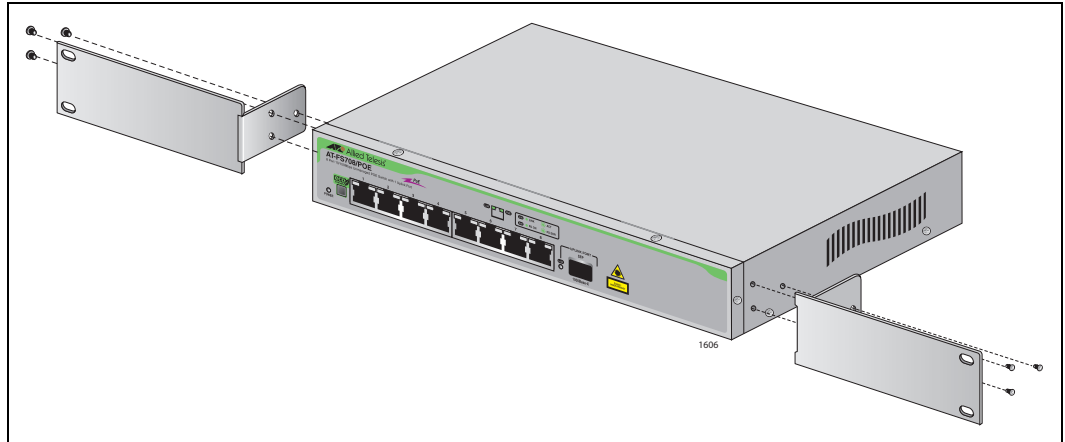

Figure 7. Attaching the Mounting Brackets

3. Mount the switch on a 19-inch rack using the four rack-mount screws, as shown in Figure 8.

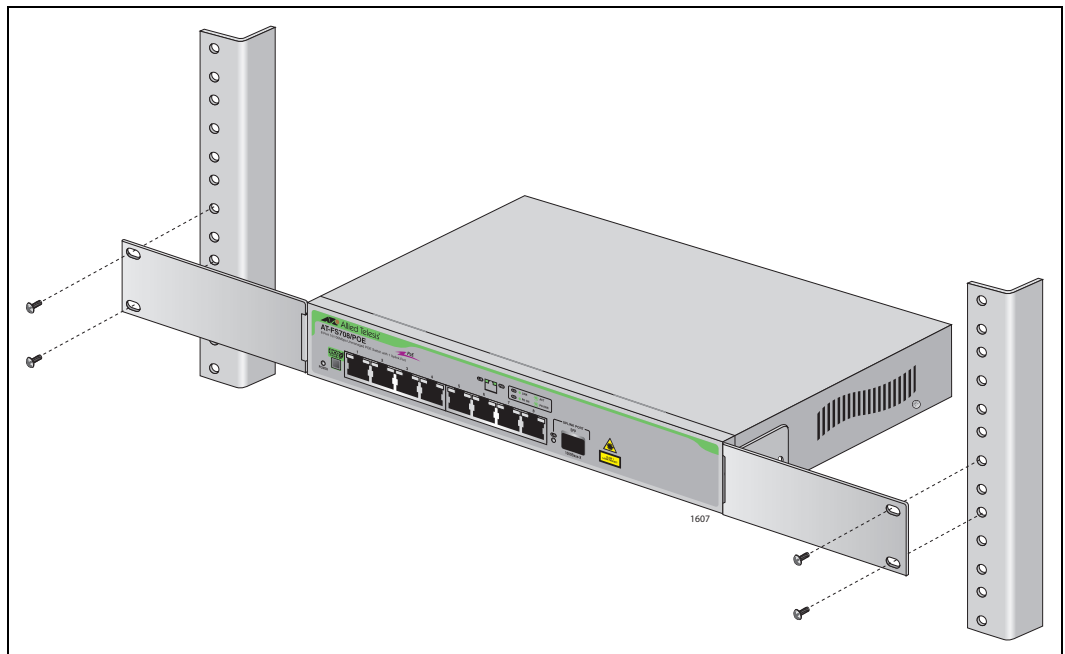

Figure 8. Mounting the Switch on the Rack

Refer to “Cabling and Powering on the Switch” on page 43 to complete the installation.

Installing an Optional SFP Transceiver

To install an SFP transceiver in an AT-FS708/POE switch, perform the following procedure:

Note

The transceiver can be hot-swapped; you do not need to power off the switch to install a transceiver. However, always remove the cables before removing the transceiver.

Note

You must install the transceiver before you connect cables to it.

1. Remove the transceiver from its shipping container and store the packaging material in a safe location.

Note

You must use the original shipping material if you need to return the module to Allied Telesis.

Warning: An SFP transceiver can be damaged by static electricity. Be sure to observe all standard electrostatic discharge (ESD) precautions, such as wearing an antistatic wrist strap, to avoid damaging the transceiver.

2. Remove the dust plug from the SFP slot.

Note

Unnecessary removal and insertion of a SFP module can lead to premature failure.

3. Locate the label on the transceiver and turn it so that the label is on top and the alignment groove is on the bottom.

- Slide the SFP transceiver into the SFP slot on the switch, as shown in Figure 9.

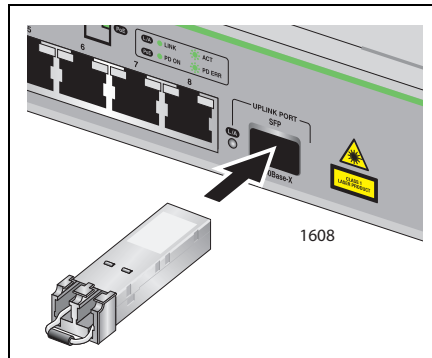

Figure 9. Inserting the SFP

Note

SFP transceivers are dust sensitive. When a fiber optic cable is not installed, or when you store the SFP, always keep the plug in the slot. When you do remove the plug, keep it for future use.

Note

Unnecessary removal and insertion of an SFP can lead to premature failure.

For information about cabling for the SFP, refer to “Cabling an SFP Transceiver” on page 44.

Cabling and Powering on the Switch

This section contains the following procedures:

- ❑ “Cabling the Twisted Pair Ports”, next
- ❑ “Cabling an SFP Transceiver” on page 44
- ❑ “Powering on the Switch” on page 45

Cabling the Twisted Pair Ports

To connect to the 10/100Base-T twisted pair ports on the AT-FS708/POE switch, perform the following procedure:

1. Connect the twisted-pair data cables to the RJ-45 ports on the switch, as shown in Figure 10.

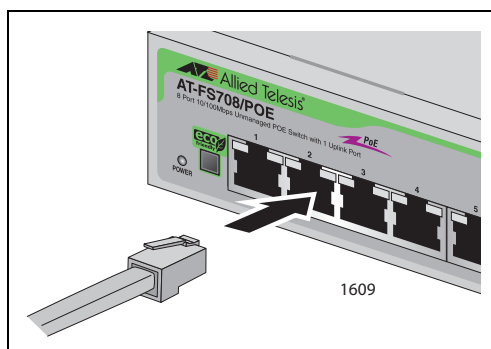

Figure 10. Connecting the Twisted Pair Data Cables

2. Power on the end nodes. For more information, refer to “Powering on the Switch” on page 45.

When connecting a twisted-pair cable to a port, observe the following guidelines:

- ❑ An RJ-45 connector should fit snugly into the port on the switch. The tab on the connector should lock the connector into place.
- ❑ The ports on the switch are auto-MDI/MDI-X. You can use either a straight-through or crossover twisted-pair cable to connect any type of network device to a port on the switch.
- ❑ The network should not contain data loops, which can adversely affect network performance. A data loop exists when two or more network devices can communicate with each other over more than one data path.

Cabling an SFP Transceiver

To cable an SFP transceiver, perform the following procedure:

Note

For information about the proper cable type, refer to the documentation that accompanied the SFP transceiver.

Note

Before you install the cable in the SFP transceiver, verify that the optical power input to the transceiver is within its dynamic range.

1. Remove the dust cover from the SFP transceiver, as shown in Figure 11.

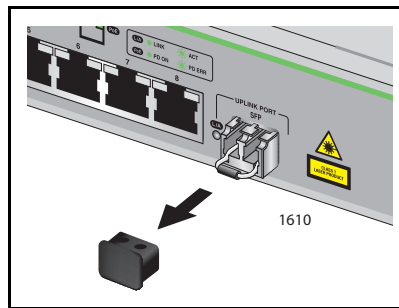

Figure 11. Removing the Dust Cover from the SFP Transceiver

2. Connect the fiber optic cable to the SFP transceiver, as shown in Figure 12.

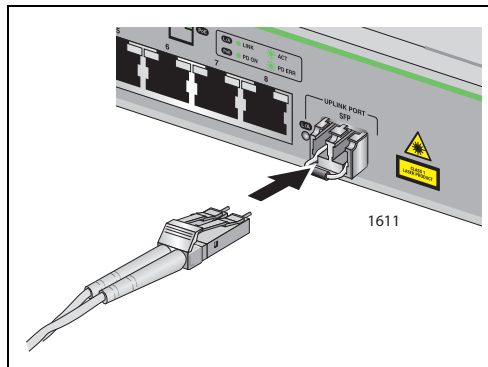

Figure 12. Connecting Fiber Optic Cables to the SFP Transceiver

3. Power on the end nodes.

Powering on the Switch

To power on the AT-FS708/POE Fast Ethernet switch, perform the following procedure:

1. Plug the power cord into the AC power connector on the back panel of the switch, as shown in Figure 13.

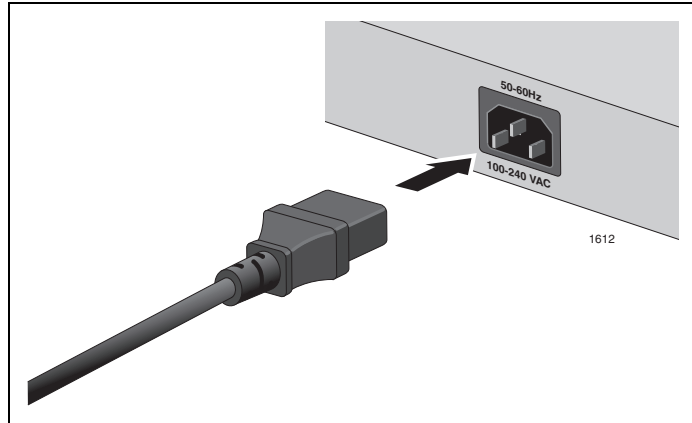

Figure 13. Connecting the AC Power Cord

2. Plug the other end of the power cord into a wall outlet.
3. Verify that the PWR LED is green.

If the PWR LED is OFF, refer to Chapter 3, “Troubleshooting” on page 47.

The switch is ready for network operations.

Chapter 3

Troubleshooting

This chapter contains information on how to troubleshoot the switch in the event that a problem occurs.

Note

If after following the instructions in this chapter you are unable to resolve the problem, contact Allied Telesis Technical Support for assistance. Refer to “Contacting Allied Telesis” on page 14 for contact information.

Power Supply A/C LED is Off

If the A/C LED on a power supply is OFF, indicating that the unit is not receiving power, do the following:

- Ensure that the power cord is securely connected to the power source and to the AC connector on the back panel of the switch.
- Verify that the power outlet has power by connecting another device to it.
- Try connecting the unit to another power source.
- Try using a different power cord.
- Verify that the voltage from the power source is within the required levels for your region.

LINK/ACT Port LED is Off

The LINK/ACT LED may be found next to the following ports and line cards:

- Network Management port on the AT-SBx31CFC Line Card.
- Ports 0 - 23 on the AT-SBx31GP24 PoE Line Card
- Ports 0 - 3 on the AT-SBx31XZ4 Line Card

If a LNK/ACT LED is OFF, do the following:

- ❑ Verify that the end node connected to the port is powered ON and is operating properly.
- ❑ Verify that the twisted-pair cable is securely connected to the port on the switch and to the port on the end node.
- ❑ Ensure that the twisted-pair cable does not exceed 100 meters (328 feet).
- ❑ Verify that you are using the appropriate category of twisted-pair cable: Category 3 or better for 10 Mbps operation and Category 5 and Category 5E for 100 Mbps operation.

Appendix A

Technical Specifications

Physical Specifications

Dimensions:	(W x D x H) 265 mm x 162 mm x 43mm (10.4 in x 6.4 in x 1.7 in)
Weight:	1.61 kg (3.5 lbs)

Environmental Specifications

Operating Temperature:	0° C to 40° C (32° F to 104° F)
Storage Temperature:	-25° C to 70° C (-13° F to 158° F)
Operating Humidity:	5% to 90% non-condensing
Storage Humidity:	5% to 95% non-condensing
Operating Altitude Range:	Up to 10,000 feet (3,048 meters)

Power Specifications

AC Voltage/Frequency Requirements:	100 - 240 VAC, 50/60 Hz
AC Input Power Consumption:	
ECO-Friendly mode enabled with no POE power	6.3 W maximum
ECO-Friendly mode enabled with max POE power	78.0 W maximum
Power efficiency with max POE power	85% minimum

POE Power

Available Power over Ethernet:	65 W @ 48 VDC
IEEE 802.3af Class 3 (15.4 W):	Max 4 ports
IEEE 802.3af Class 2 (7.0 W):	Max 8 ports
IEEE 802.3af Mode:	Alternative A (MDI)

Power Cord Specifications

Cable Type:	H05VV-F, 3G, 0.75mm ²
Maximum Current:	6 Amps
Voltage Rating:	AC 250 VAC minimum

Safety and Electromagnetic Emissions Certifications

EMI	FCC Class A, CISPR 22 Class A, EN55022 Class A, C-TICK, CE
Immunity	EN55024
Electrical Safety	UL 60950-1 (cUL _{US}), EN60950-1 (TUV) or VDE
Laser Safety	EN60825

RJ-45 Twisted Pair Port Connectors and Pinouts

This section lists the connectors and connector pinouts for the AT-FS708/POE Fast Ethernet switch and its components.

Figure 14 illustrates the pin layout to an RJ-45 connector and port.

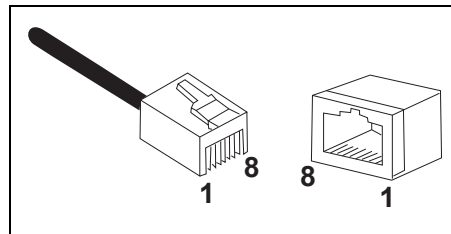

Figure 14. RJ-45 Connector and Port Pin Layout

Table 7 lists the RJ-45 pin signals when a twisted-pair port is operating in the MDI configuration.

Table 7. MDI Pin Signals (10Base-T or 100Base-TX)

Pin	Signal
1	TX+
2	TX-
3	RX+
6	RX-

Table 8 lists the RJ-45 port pin signals when a twisted-pair port is operating in the MDI-X configuration.

Table 8. MDI-X Pin Signals (10Base-T or 100Base-TX)

Pin	Signal
1	RX+
2	RX-
3	TX+
6	TX-