

Dell EMC PowerEdge R6525

Installation and Service Manual

Notes, cautions, and warnings

 **NOTE:** A NOTE indicates important information that helps you make better use of your product.

 **CAUTION:** A CAUTION indicates either potential damage to hardware or loss of data and tells you how to avoid the problem.

 **WARNING:** A WARNING indicates a potential for property damage, personal injury, or death.

Chapter 1: About this document	7
Chapter 2: System overview	8
Front view of the system.....	8
Left control panel view.....	11
Right control panel view.....	12
Rear view of the system.....	13
Inside the system	17
Locating the Express Service Code and Service Tag.....	17
System information label.....	18
Rail sizing and rack compatibility matrix.....	21
Chapter 3: Initial system setup and configuration	22
Setting up the system.....	22
iDRAC configuration.....	22
Options to set up iDRAC IP address.....	22
Options to log in to iDRAC.....	23
Resources to install operating system.....	24
Options to download firmware	24
Options to download and install OS drivers	24
Downloading drivers and firmware.....	25
Chapter 4: Installing and removing system components	26
Safety instructions.....	26
Before working inside your system.....	27
After working inside your system.....	27
Recommended tools.....	27
Optional front bezel.....	28
Removing the front bezel.....	28
Installing the front bezel.....	29
System cover.....	29
Removing the system cover.....	29
Installing the system cover.....	30
Drive backplane cover.....	31
Removing the drive backplane cover.....	31
Installing the drive backplane cover.....	32
Control panel.....	33
Removing the right control panel.....	33
Installing the right control panel.....	34
Removing the left control panel.....	34
Installing the left control panel.....	35
VGA module.....	36
Removing the VGA module.....	36
Installing the VGA module.....	37

Air shroud.....	39
Removing the air shroud.....	39
Installing the air shroud.....	40
Cooling fan.....	42
Removing a cooling fan module.....	42
Installing a cooling fan module.....	42
Drives.....	43
Removing a drive blank.....	43
Installing a drive blank.....	44
Removing the drive carrier.....	44
Installing the drive carrier.....	45
Removing the drive from the drive carrier.....	46
Installing the drive into the drive carrier.....	47
Drive backplane.....	48
Drive backplane.....	48
Removing the drive backplane	49
Installing the drive backplane.....	50
Cable routing.....	52
Rear drive module.....	58
Removing the rear drive module.....	58
Installing the rear drive module.....	60
Front PERC module.....	62
Removing the front mounting front PERC module.....	62
Installing the front mounting front PERC module.....	63
Removing the rear mounting front PERC module.....	64
Installing the rear mounting front PERC module.....	65
System memory.....	66
System memory guidelines.....	66
General memory module installation guidelines.....	68
Removing a memory module.....	71
Installing a memory module.....	72
Processor and heat sink.....	73
Removing a heat sink.....	73
Removing the liquid cooling heat sink modules.....	74
Removing the processor.....	75
Installing the processor.....	77
Installing the heat sink.....	79
Installing the liquid cooling heat sink modules.....	81
Expansion cards and expansion card risers.....	82
Expansion card installation guidelines.....	83
Removing the expansion card risers.....	93
Installing the expansion card risers.....	96
Removing expansion card from the expansion card riser.....	100
Installing an expansion card into the expansion card riser.....	102
Optional serial COM port.....	104
Removing the serial COM port.....	104
Installing the serial COM port.....	105
Optional IDSDM module.....	106
Removing the IDSDM module.....	106
Installing the IDSDM module.....	107

MicroSD card.....	108
Removing the MicroSD card.....	108
Installing the MicroSD card.....	109
M.2 SSD module on BOSS-S1 adapter card.....	110
Removing the M.2 SSD module.....	110
Installing the M.2 SSD module.....	111
BOSS S2 card (optional).....	112
Removing the BOSS card filler.....	112
Installing the BOSS card filler.....	113
Removing the BOSS S2 controller card module.....	114
Installing the BOSS S2 controller card.....	117
System battery	120
Replacing the system battery.....	120
Optional internal USB card.....	122
Removing the internal USB card.....	122
Installing the internal USB card.....	122
Intrusion switch module.....	123
Removing the intrusion switch module.....	123
Installing the intrusion switch module.....	124
Optional OCP card.....	125
Removing the OCP card.....	125
Installing the OCP card.....	126
Power supply unit.....	127
Hot spare feature.....	127
Removing a power supply unit blank.....	128
Installing a power supply unit blank.....	128
Removing a power supply unit.....	128
Installing a power supply unit.....	129
Trusted Platform Module.....	130
Upgrading the Trusted Platform Module.....	130
Initializing TPM for users.....	131
Initializing the TPM 1.2 for users.....	131
Initializing the TPM 2.0 for users.....	131
System board.....	132
Removing the system board.....	132
Installing the system board.....	133
LOM card and rear I/O board.....	135
Removing the LOM card and rear I/O board.....	135
Installing the LOM card and rear I/O board.....	136
RIO card.....	137
Removing the Rear Input Output (RIO) card.....	137
Installing the RIO card.....	138
Tube clip.....	139
Removing the tube clip.....	139
Installing the tube clip.....	140
Chapter 5: Upgrade Kits.....	142
BOSS S2 kit.....	142
PCIe Gen 4 NVMe enablement Kit.....	144
IDSMD kit.....	146

Internal USB card kit.....	147
Serial COM port kit.....	147
Chapter 6: Jumpers and connectors.....	148
System board connectors.....	148
System board jumper settings.....	150
Disabling a forgotten password.....	150
Chapter 7: System diagnostics and indicator codes.....	152
Status LED indicators.....	152
System health and system ID indicator codes.....	153
iDRAC Quick Sync 2 indicator codes.....	154
iDRAC Direct LED indicator codes.....	154
LCD panel.....	155
Viewing Home screen.....	155
Setup menu.....	156
View menu.....	156
NIC indicator codes.....	157
Power supply unit indicator codes.....	157
Drive indicator codes.....	159
Using system diagnostics.....	159
Dell Embedded System Diagnostics.....	160
Chapter 8: Getting help.....	161
Recycling or End-of-Life service information.....	161
Contacting Dell.....	161
Accessing system information by using QRL.....	161
Quick Resource Locator for PowerEdge R6525 system.....	162
Receiving automated support with SupportAssist	162
Chapter 9: Documentation resources.....	163

About this document

This document provides an overview about the system, information about installing and replacing components, diagnostic tools, and guidelines to be followed while installing certain components.

System overview

The PowerEdge R6525 system is a 1U rack server that supports:

- Two AMD EPYC™ 7002 or 7003 series processors
- 32 DIMM slots
- Two redundant AC or DC power supply units
- Up to 4 x 3.5-inch, 8 x 2.5-inch, or 10 x 2.5-inch SAS, SATA, or NVMe drives.

NOTE: For more information about how to hot swap NVMe PCIe SSD U.2 device, see the *Dell Express Flash NVMe PCIe SSD User's Guide* at <https://www.dell.com/support> **Browse all Products > Data Center Infrastructure > Storage Adapters & Controllers > Dell PowerEdge Express Flash NVMe PCIe SSD > Documentation > Manuals and Documents.**

NOTE: All instances of SAS, SATA drives, PCIe SSDs, and NVMe are referred to as drives in this document, unless specified otherwise.

WARNING: Consumer-Grade GPU should not be installed or used in the Enterprise Server products.

For more information about supported drives, see the www.dell.com/poweredgemanuals section.

For more information, see the Dell EMC PowerEdge R6525 Technical Specifications on the product documentation page.

Topics:

- [Front view of the system](#)
- [Rear view of the system](#)
- [Inside the system](#)
- [Locating the Express Service Code and Service Tag](#)
- [System information label](#)
- [Rail sizing and rack compatibility matrix](#)

Front view of the system

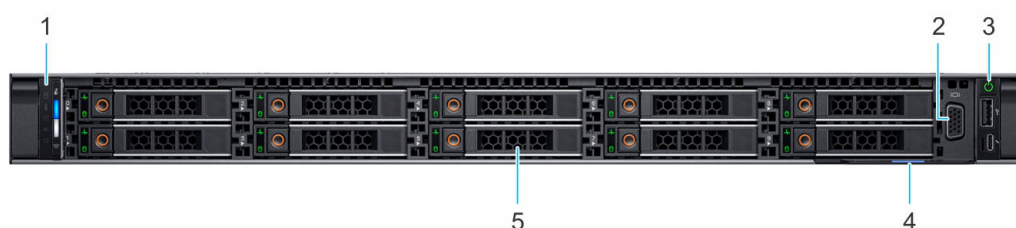

Figure 1. Front view of the 10 x 2.5-inch drive system

Table 1. Features available on the front of the system

Item	Ports, panels, and slots	Icon	Description
1	Left control panel	N/A	<p>Contains the system health, system ID, status LED, and the iDRAC Quick Sync 2 (wireless) indicator.</p> <p>NOTE: The iDRAC Quick Sync 2 indicator is available only on certain configurations.</p> <ul style="list-style-type: none"> • Status LED: Enables you to identify any failed hardware components. There are up to five status LEDs and an overall

Table 1. Features available on the front of the system (continued)

Item	Ports, panels, and slots	Icon	Description
			<p>system health LED (Chassis health and system ID) bar. For more information, see the Status LED indicators section.</p> <ul style="list-style-type: none"> Quick Sync 2 (wireless): Indicates a Quick Sync enabled system. The Quick Sync feature is optional. This feature allows management of the system by using mobile devices that are called as OpenManage Mobile (OMM) feature. Using iDRAC Quick Sync 2 with OpenManage Mobile (OMM) aggregates hardware or firmware inventory and various system level diagnostic and error information that can be used in troubleshooting the system. For more information, see the <i>Integrated Dell Remote Access Controller User's Guide</i> available at https://www.dell.com/idracmanuals
2	VGA port		Enables you to connect a display device to the system. For more information, see the www.dell.com/poweredge manuals section.
3	Right control panel	N/A	Contains the power button, USB port, iDRAC Direct micro port, and the iDRAC Direct status LED.
4	Information tag		The Information tag is a slide-out label panel that contains system information such as Service Tag, NIC, MAC address, and so on. If you have opted for the secure default access to iDRAC, the Information tag also contains the iDRAC secure default password.
5	Drive (10)	N/A	Enables you to install drives that are supported on your system. For more information about drives, see the www.dell.com/poweredge manuals section.



Figure 2. Front view of the 8 x 2.5-inch drive system

Table 2. Features available on the front of the system

Item	Ports, panels, and slots	Icon	Description
1	Left control panel	N/A	<p>Contains the system health, system ID, status LED, and the iDRAC Quick Sync 2 (wireless) indicator.</p> <p>NOTE: The iDRAC Quick Sync 2 indicator is available only on certain configurations.</p> <ul style="list-style-type: none"> Status LED: Enables you to identify any failed hardware components. There are up to five status LEDs and an overall system health LED (Chassis health and system ID) bar. For more information, see the Status LED indicators section. Quick Sync 2 (wireless): Indicates a Quick Sync enabled system. The Quick Sync feature is optional. This feature allows management of the system by using mobile devices that are called as OpenManage Mobile (OMM) feature. Using iDRAC Quick Sync 2 with OpenManage Mobile (OMM) aggregates hardware or firmware inventory and various

Table 2. Features available on the front of the system (continued)

Item	Ports, panels, and slots	Icon	Description
2	Drive (8)	N/A	system level diagnostic and error information that can be used in troubleshooting the system. For more information, see the <i>Integrated Dell Remote Access Controller User's Guide</i> available at https://www.dell.com/idracmanuals
3	Right control panel	N/A	Enables you to install drives that are supported on your system. For more information about drives, see the www.dell.com/poweredgemanuals section.
4	VGA port		Contains the power button, USB port, iDRAC Direct micro port, and the iDRAC Direct status LED.
5	Information tag		Enables you to connect a display device to the system. For more information, see the www.dell.com/poweredgemanuals section.
			The Information tag is a slide-out label panel that contains system information such as Service Tag, NIC, MAC address, and so on. If you have opted for the secure default access to iDRAC, the Information tag also contains the iDRAC secure default password.

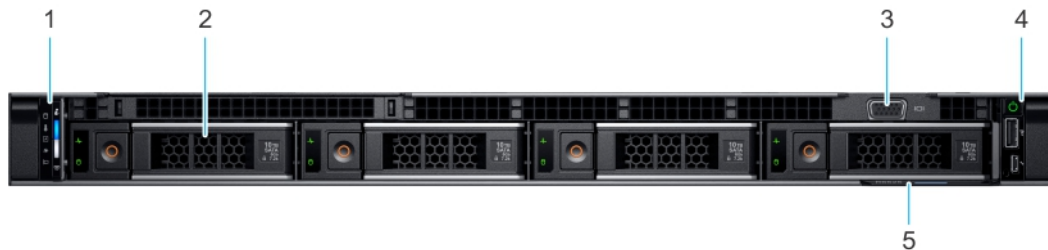



Figure 3. Front view of the 4 x 3.5-inch drive system

Table 3. Features available on the front of the system

Item	Ports, panels, and slots	Icon	Description
1	Left control panel	N/A	Contains the system health, system ID, status LED, and the iDRAC Quick Sync 2 (wireless) indicator. NOTE: The iDRAC Quick Sync 2 indicator is available only on certain configurations. <ul style="list-style-type: none"> • Status LED: Enables you to identify any failed hardware components. There are up to five status LEDs and an overall system health LED (Chassis health and system ID) bar. For more information, see the Status LED indicators section. • Quick Sync 2 (wireless): Indicates a Quick Sync enabled system. The Quick Sync feature is optional. This feature allows management of the system by using mobile devices that are called as OpenManage Mobile (OMM) feature. Using iDRAC Quick Sync 2 with OpenManage Mobile (OMM) aggregates hardware or firmware inventory and various system level diagnostic and error information that can be used in troubleshooting the system. For more information, see the <i>Integrated Dell Remote Access Controller User's Guide</i> available at https://www.dell.com/idracmanuals
2	Drive (4)	N/A	Enables you to install drives that are supported on your system. For more information about drives, see the www.dell.com/poweredgemanuals section.

Table 3. Features available on the front of the system (continued)

Item	Ports, panels, and slots	Icon	Description
3	VGA port		Enables you to connect a display device to the system. For more information, see the www.dell.com/poweredgemanuals section.
4	Right control panel	N/A	Contains the power button, USB port, iDRAC Direct micro port, and the iDRAC Direct status LED.
5	Information tag		The Information tag is a slide-out label panel that contains system information such as Service Tag, NIC, MAC address, and so on. If you have opted for the secure default access to iDRAC, the Information tag also contains the iDRAC secure default password.

For more information about the ports, see the www.dell.com/poweredgemanuals section.

For more information, see the Dell EMC PowerEdge R6525 Technical Specifications on the product documentation page.

Left control panel view

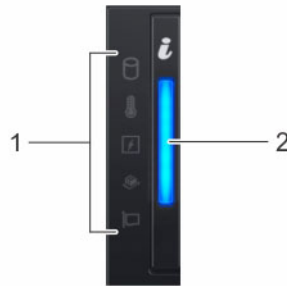

Figure 4. Left control panel without optional iDRAC Quick Sync 2 indicator

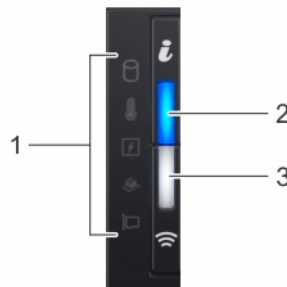

Figure 5. Left control panel with optional iDRAC Quick Sync 2 indicator

Table 4. Left control panel



Item	Indicator, button, or connector	Icon	Description
1	Status LED indicators	N/A	Indicates the status of the system. For more information, see the Status LED indicators section.
2	System health and system ID indicator		Indicates the system health. For more information, see the System health and system ID indicator codes section.
3	iDRAC Quick Sync 2 wireless indicator (optional)		Indicates if the iDRAC Quick Sync 2 wireless option is activated. The Quick Sync 2 feature allows management of the system using mobile devices. This feature aggregates hardware/

Table 4. Left control panel (continued)

Item	Indicator, button, or connector	Icon	Description
			firmware inventory and various system level diagnostic/error information that can be used in troubleshooting the system. You can access system inventory, Dell Lifecycle Controller logs or system logs, system health status, and also configure iDRAC, BIOS, and networking parameters. You can also launch the virtual Keyboard, Video, and Mouse (KVM) viewer and virtual Kernel-based Virtual Machine (KVM), on a supported mobile device. For more information, see the Integrated Dell Remote Access Controller User's Guide at www.dell.com/poweredgemanuals

NOTE: For more information about the indicator codes, see the [System diagnostics and indicator codes](#) section.

Right control panel view

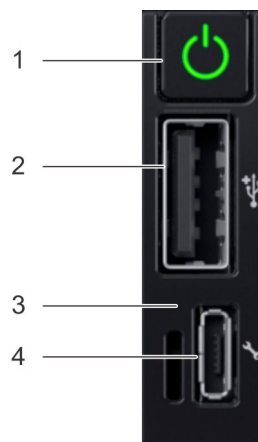

Figure 6. Right control panel view

Table 5. Right control panel

Item	Indicator or button	Icon	Description
1	Power button		Indicates if the system is powered on or off. Press the power button to manually power on or off the system. NOTE: Press the power button to gracefully shut down an ACPI-compliant operating system.
2	USB 2.0-compliant port		The USB port is a 4-pin connector and 2.0-compliant. This port enables you to connect USB devices to the system.
3	iDRAC Direct LED indicator	N/A	The iDRAC Direct LED indicator lights up to indicate that the iDRAC Direct port is actively connected to a device.
4	iDRAC Direct port (Micro-AB USB)		The iDRAC Direct port (Micro-AB USB) enables you to access the iDRAC Direct Micro-AB features. For more information, see the <i>Integrated Dell Remote Access Controller User's Guide</i> available at https://www.dell.com/idracmanuals . NOTE: You can configure iDRAC Direct by using a USB to micro USB (type AB) cable, which you

Table 5. Right control panel (continued)

Item	Indicator or button	Icon	Description
			can connect to your laptop or tablet. Cable length should not exceed 3 ft (0.91 meters). Quality of the cable might affect performance.

NOTE: For more information about the ports, see the www.dell.com/poweredge manuals section.

Rear view of the system

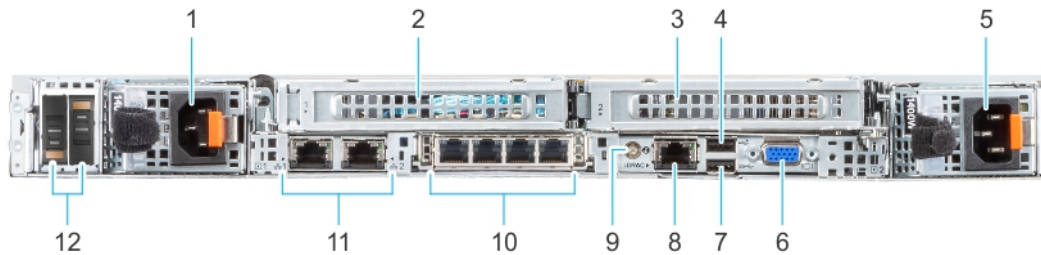



Figure 7. Rear view of the 10 x 2.5-inch drive system

Table 6. Rear view of the system

Item	Ports, panels, or slots	Icon	Description
1	Power supply unit (PSU 1)		For more information about the PSU configurations, see the www.dell.com/poweredge manuals section.
2	PCIe expansion card riser (slot 1)	N/A	The expansion card riser enables you to connect PCI Express expansion cards. For more information about the expansion cards that are supported on your system, see www.dell.com/poweredge manuals section.
3	PCIe expansion card riser (slot 2)	N/A	The expansion card riser enables you to connect PCI Express expansion cards. For more information about the expansion cards that are supported on your system, see www.dell.com/poweredge manuals section.
4	USB 2.0 port (1)		This port is USB 2.0-compliant.
5	Power supply unit (PSU 2)		For more information about the PSU configurations, see the www.dell.com/poweredge manuals section.
6	VGA port		Enables you to connect a display device to the system. For more information, see the www.dell.com/poweredge manuals section.
7	USB 3.0 port (1)		This port is USB 3.0-compliant.
8	iDRAC dedicated port	iDRAC	Enables you to remotely access iDRAC. For more information, see the iDRAC User's Guide at www.dell.com/poweredge manuals .
9	System identification button		Press the system ID button: <ul style="list-style-type: none"> To locate a particular system within a rack. To turn the system ID on or off. To reset iDRAC, press and hold the button for more than 16 seconds.

NOTE:

Table 6. Rear view of the system (continued)

Item	Ports, panels, or slots	Icon	Description
			<ul style="list-style-type: none"> To reset iDRAC using system ID, ensure that the system ID button is enabled in the iDRAC setup. If the system stops responding during POST, press and hold the system ID button (for more than 5 seconds) to enter the BIOS progress mode.
10	OCP NIC port (optional)	N/A	This port supports OCP 3.0. The NIC ports are integrated on the OCP card which is connected to the system board.
11	NIC port (2)		The NIC ports are embedded on the LOM card that is connected to the system board.
12	BOSS S2 card (optional)	N/A	This slot supports the BOSS S2 module

For more information about the ports, see the [Technical Specifications](#) section.

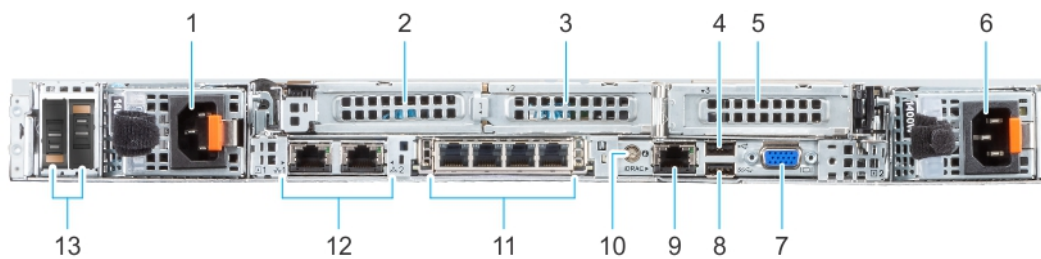

Figure 8. Rear view of the 8 x 2.5-inch drive system.

Table 7. Rear view of the system







Item	Ports, panels, or slots	Icon	Description
1	Power supply unit (PSU 1)		For more information about the PSU configurations, see the www.dell.com/poweredge/manuals section.
2	PCIe expansion card riser (slot 1)	N/A	The expansion card riser enables you to connect PCI Express expansion cards. For more information about the expansion cards that are supported on your system, see www.dell.com/poweredge/manuals section.
3	PCIe expansion card riser (slot 2)	N/A	The expansion card riser enables you to connect PCI Express expansion cards. For more information about the expansion cards that are supported on your system, see www.dell.com/poweredge/manuals section.
4	USB 2.0 port (1)		This port is USB 2.0-compliant.
5	PCIe expansion card riser (slot 3)	N/A	The expansion card riser enables you to connect PCI Express expansion cards. For more information about the expansion cards that are supported on your system, see www.dell.com/poweredge/manuals section.
6	Power supply unit (PSU 2)		For more information about the PSU configurations, see the Technical Specifications section.
7	VGA port		Enables you to connect a display device to the system. For more information, see the www.dell.com/poweredge/manuals section.
8	USB 3.0 port (1)		This port is USB 3.0-compliant.

Table 7. Rear view of the system (continued)

Item	Ports, panels, or slots	Icon	Description
9	iDRAC dedicated port	iDRAC	Enables you to remotely access iDRAC. For more information, see the iDRAC User's Guide at www.dell.com/poweredgemanuals .
10	System identification button		<p>Press the system ID button:</p> <ul style="list-style-type: none"> To locate a particular system within a rack. To turn the system ID on or off. <p>To reset iDRAC, press and hold the button for more than 16 seconds.</p> <p>NOTE:</p> <ul style="list-style-type: none"> To reset iDRAC using system ID, ensure that the system ID button is enabled in the iDRAC setup. If the system stops responding during POST, press and hold the system ID button (for more than 5 seconds) to enter the BIOS progress mode.
11	OCP NIC port (optional)	N/A	This port supports OCP 3.0. The NIC ports are integrated on the OCP card which is connected to the system board.
12	NIC port (2)		The NIC ports are embedded on the LOM card that is connected to the system board.
13	BOSS S2 card (optional)	N/A	This slot supports the BOSS S2 module

For more information about the ports, see the [Technical Specifications](#) section.

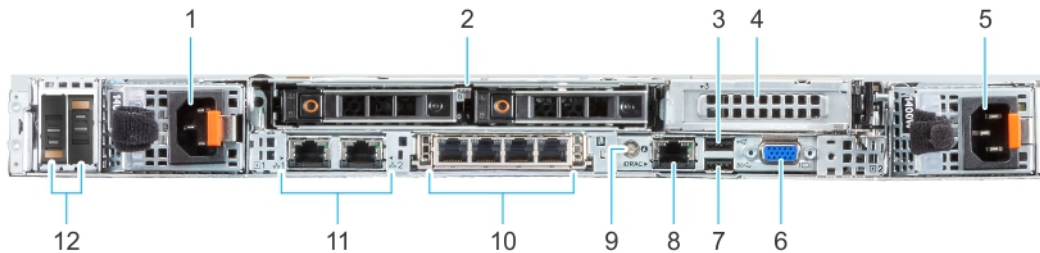

Figure 9. Rear view of the 4 x 3.5-inch drive system with 2 x 2.5-inch rear drive module

Table 8. Rear view of the system







Item	Ports, panels, or slots	Icon	Description
1	Power supply unit (PSU 1)		For more information about the PSU configurations, see the www.dell.com/poweredgemanuals section.
2	Rear drive module	N/A	Enables you to install drives that are supported on your system. For more information about drives, see the www.dell.com/poweredgemanuals section.
3	USB 2.0 port (1)		This port is USB 2.0-compliant.
4	PCIe expansion card riser (slot 3)	N/A	The expansion card riser enables you to connect PCI Express expansion cards. For more information about the expansion cards that are supported on your system, see www.dell.com/poweredgemanuals section.
5	Power supply unit (PSU 2)		For more information about the PSU configurations, see the www.dell.com/poweredgemanuals section.
6	VGA port		Enables you to connect a display device to the system. For more information, see the www.dell.com/poweredgemanuals section.

Table 8. Rear view of the system (continued)

Item	Ports, panels, or slots	Icon	Description
7	USB 3.0 port (1)		This port is USB 3.0-compliant.
8	iDRAC dedicated port	iDRAC	Enables you to remotely access iDRAC. For more information, see the iDRAC User's Guide at www.dell.com/poweredgemanuals .
9	System identification button		<p>Press the system ID button:</p> <ul style="list-style-type: none"> • To locate a particular system within a rack. • To turn the system ID on or off. <p>To reset iDRAC, press and hold the button for more than 16 seconds.</p> <p>NOTE:</p> <ul style="list-style-type: none"> • To reset iDRAC using system ID, ensure that the system ID button is enabled in the iDRAC setup. • If the system stops responding during POST, press and hold the system ID button (for more than 5 seconds) to enter the BIOS progress mode.
10	OCP NIC port (optional)	N/A	This port supports OCP 3.0. The NIC ports are integrated on the OCP card which is connected to the system board.
11	NIC port (2)		The NIC ports are embedded on the LOM card that is connected to the system board.
12	BOSS S2 card (optional)	N/A	This slot supports the BOSS S2 module

For more information about the ports, see the www.dell.com/poweredgemanuals section.

For more information, see the Dell EMC PowerEdge R6525 Technical Specifications on the product documentation page.

Inside the system

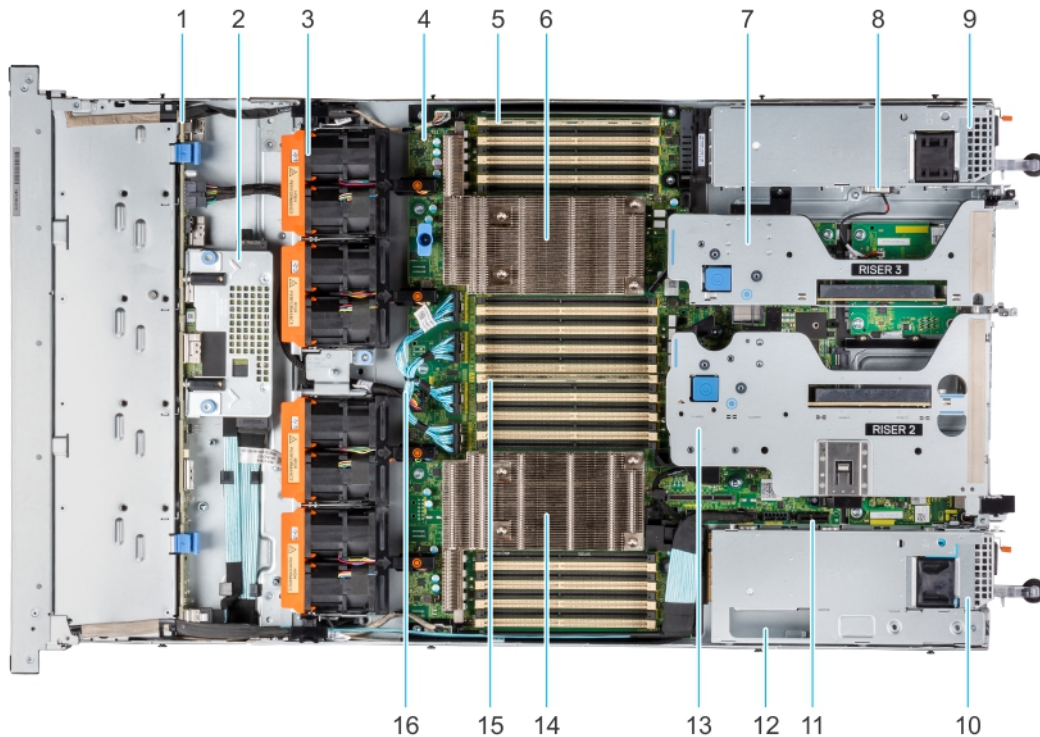

Figure 10. Inside the system

- | | |
|---|------------------------------------|
| 1. Drive backplane | 2. Rear mounting front PERC module |
| 3. Dual fan module (4) | 4. System board |
| 5. Memory DIMM socket for processor 2 (B1) | 6. Heat sink for processor 2 |
| 7. Riser 3 | 8. Intrusion switch |
| 9. Power supply unit (PSU 2) | 10. Power supply unit (PSU 1) |
| 11. IDSDM/Internal USB card port | 12. BOSS slot |
| 13. Riser 2 | 14. Heat sink for processor 1 |
| 15. Memory DIMM socket for processor 1 (A1) | 16. xGMI cables |

Locating the Express Service Code and Service Tag

The unique Express Service Code and Service Tag are used to identify the system.

The information tag is located on the front of the system that includes system information such as Service Tag, Express Service Code, Manufacture date, NIC, MAC address, QRL label, and so on. If you have opted for the secure default access to iDRAC, the Information tag also contains the iDRAC secure default password. If you have opted for iDRAC Quick Sync 2, the Information tag also contains the OpenManage Mobile (OMM) label, where administrators can configure, monitor, and troubleshoot the PowerEdge servers.

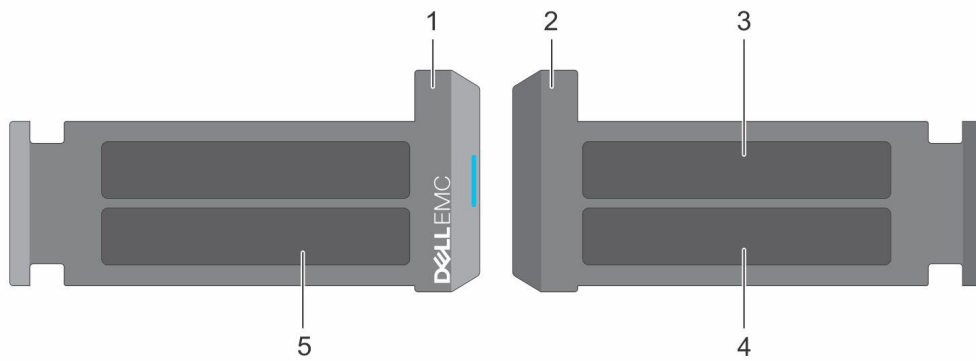

Figure 11. Locating the Express Service Code and Service tag

1. Information tag (front view)
2. Information tag (back view)
3. OpenManage Mobile (OMM) label
4. iDRAC MAC address and iDRAC secure password label
5. Service Tag, Express Service Code, QRL label

The Mini Enterprise Service Tag (MEST) label is located on the rear of the system that includes Service Tag (ST), Express Service Code (Exp Svc Code), and Manufacture Date (Mfg. Date). The Exp Svc Code is used by Dell EMC to route support calls to the appropriate personnel.

Alternatively, the Service Tag information is located on a label on left wall of the chassis.

System information label

The system information label is located on the back side of the system cover.

Service Information

System Touchpoints

■ Hot swap touchpoints: Components with terracotta touchpoints can be serviced while the system is running.

■ Cold swap touchpoints: Components with blue touchpoints require a full system shutdown before servicing.

Mechanical Overview

Top View

Front of system

Rear View Configurations

Hot Swap

Boot Optimized M.2 Drives

Fan Installation

System Tasks

Front PERC (rear loading)

System Tasks

Front PERC (front loading)

Caution: Many repairs may only be done by a certified service technician. You should only perform troubleshooting and simple repairs as authorized in your product documentation, or as directed by the online or telephone service and support team. Damage due to servicing that is not authorized by Dell is not covered by your warranty. Read and follow the safety instructions that came with the product.

To learn more about this Dell product or to order additional or replacement parts, go to Dell.com/support

Copyright © 2019 Dell Inc. or its subsidiaries. All Rights Reserved. Rev A00. Label Part No. 7DP10

Figure 12. Service information

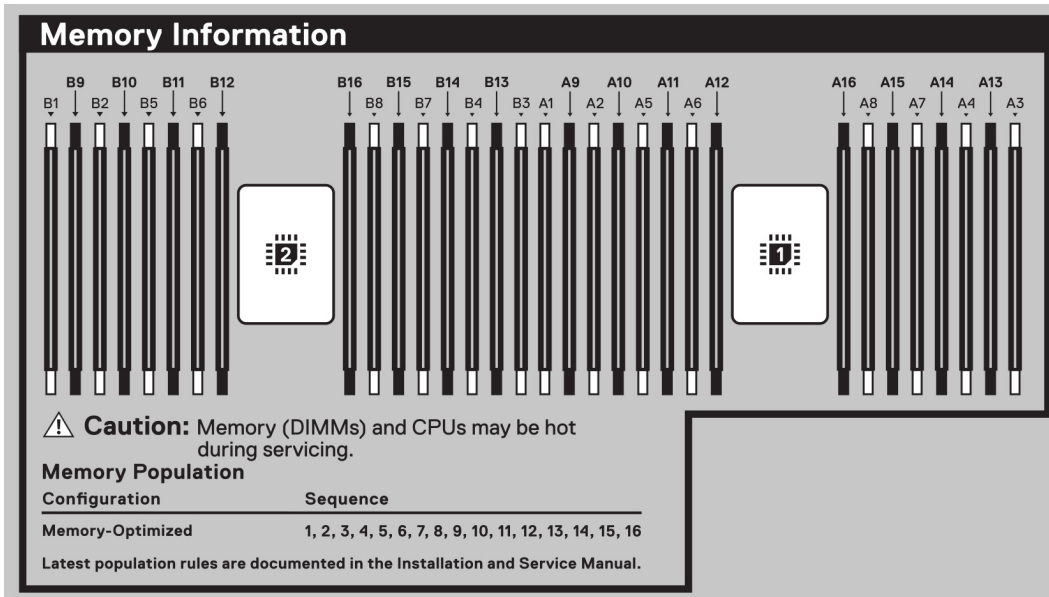

Scan to see hardware servicing and software setup videos, how-to's, and documentation.

Quick Resource Locator
Dell.com/QRL/Server/PER6525

Jumper Settings

Jumper	Setting	Description
NVRAM_CLR	(default)	BIOS configuration settings retained at system boot.
		BIOS configuration settings cleared at system boot.
	(default)	BIOS password is enabled.
PWRD_EN		BIOS password is disabled. iDRAC local access unlocked at next AC power cycle. iDRAC password reset is enabled in F2 iDRAC setting menu.

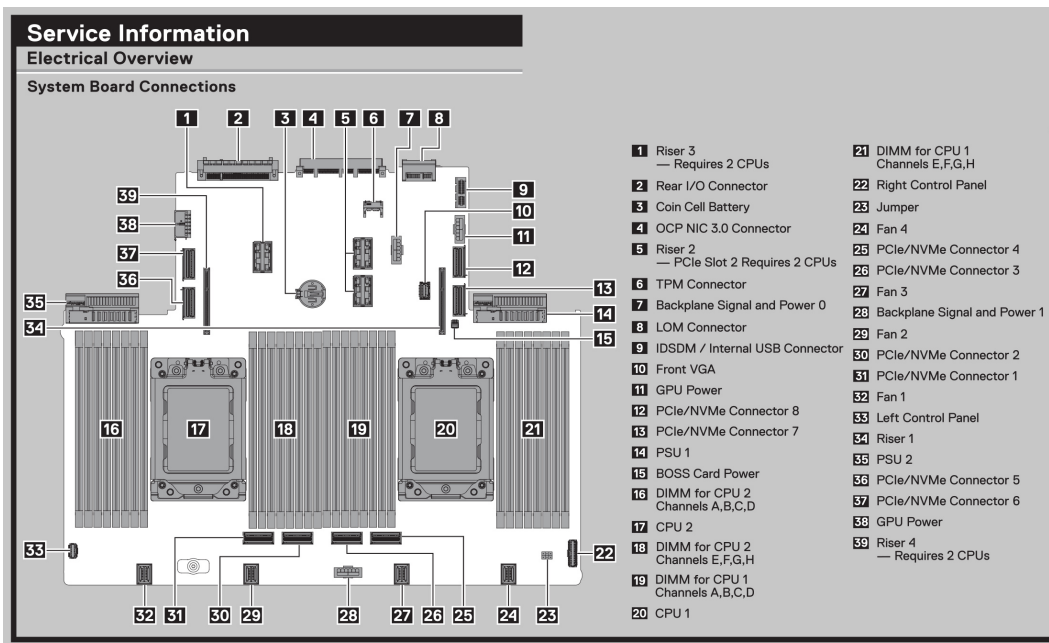

Figure 13. Memory information and system board connectors

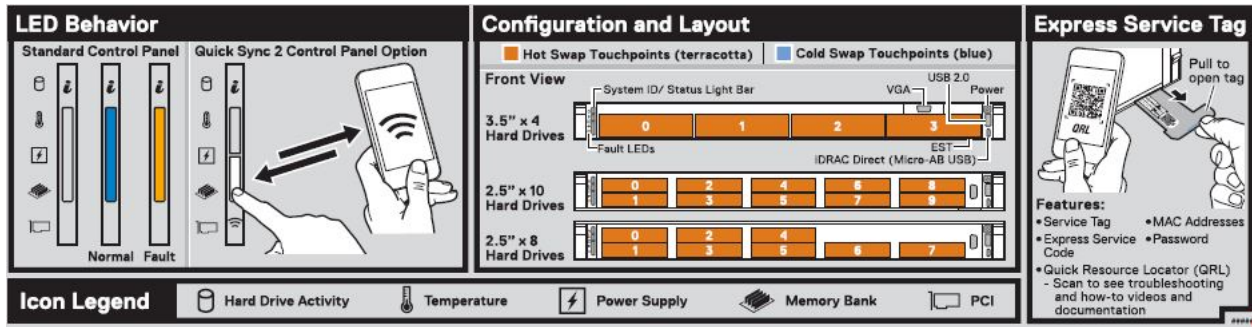

Figure 14. LED behavior, configuration and layout, express service tag

Rail sizing and rack compatibility matrix

For specific information about the rail solutions compatible with your system, see the *Dell EMC Enterprise Systems Rail Sizing and Rack Compatibility Matrix* available at https://i.dell.com/sites/csdocuments/Business_solutions_engineering-Docs_Documents/en/rail-rack-matrix.pdf.

The document provides the information that is listed below:

- Specific details about rail types and their functionalities
- Rail adjustability ranges for various rack mounting flange types
- Rail depth with and without cable management accessories
- Rack types that are supported for various rack mounting flange types

Initial system setup and configuration

This section describes the tasks for initial setup and configuration of the Dell EMC system. The sections provide general steps that you must complete to set up the system and the reference guides for detailed information.

Topics:

- [Setting up the system](#)
- [iDRAC configuration](#)
- [Resources to install operating system](#)

Setting up the system

Perform the following steps to set up the system:

Steps

1. Unpack the system.
2. Install the system into the rack. For more information, see the rail installation and cable management accessory guides relevant to your rail and cable management solution at www.dell.com/poweredgemanuals.
3. Connect the peripherals to the system and the system to the electrical outlet.
4. Power on the system by pressing the power button.

For more information about setting up the system, see the *Getting Started Guide* that is shipped with your system.

For information on how to manage basic settings and features of the system, see the Dell EMC PowerEdge R6525 BIOS and UEFI Reference Guide on the product documentation page.

iDRAC configuration

The Integrated Dell Remote Access Controller (iDRAC) is designed to make you more productive as a system administrator and improve the overall availability of Dell EMC servers. iDRAC alerts you to system issues, helps you to perform remote management, and reduces the need for physical access to the system.

Options to set up iDRAC IP address

To enable communication between your system and iDRAC, you must first configure the network settings based on your network infrastructure. The network settings option is set to **DHCP**, by default.

 **NOTE:** For static IP configuration, you must request for the setting at the time of purchase.

You can set up the iDRAC IP address using one of the following interfaces. For information about how to set up iDRAC IP address, see the documentation links provided in the table.

Table 9. Interfaces to set up iDRAC IP address

Interface	Documentation links
iDRAC Settings utility	<p><i>Integrated Dell Remote Access Controller User's Guide</i> at https://www.dell.com/idracmanuals or for system specific <i>Integrated Dell Remote Access Controller User's Guide</i>, go to https://www.dell.com/poweredgemanuals > Product Support page of your system > Manuals & documents.</p> <p> NOTE: To determine the most recent iDRAC release for your platform and for latest documentation version,</p>

Table 9. Interfaces to set up iDRAC IP address (continued)

Interface	Documentation links
	see KB article https://www.dell.com/support/article/sln308699 .
OpenManage Deployment Toolkit	<i>Dell EMC OpenManage Deployment Toolkit User's Guide</i> available at https://www.dell.com/openmanagemanuals > Open Manage Deployment Toolkit.
Lifecycle Controller	<i>Lifecycle Controller User's Guide</i> at https://www.dell.com/idracmanuals or for system specific <i>Lifecycle Controller User's Guide</i> , go to https://www.dell.com/poweredgemanuals > Product Support page of your system > Manuals & documents . <i>NOTE:</i> To determine the most recent iDRAC release for your platform and for latest documentation version, see KB article https://www.dell.com/support/article/sln308699 .
Server LCD panel	LCD panel section.
iDRAC Direct and Quick Sync 2 (optional)	<i>Integrated Dell Remote Access Controller User's Guide</i> at https://www.dell.com/idracmanuals or for system specific <i>Integrated Dell Remote Access Controller User's Guide</i> , go to https://www.dell.com/poweredgemanuals > Product Support page of your system > Manuals & documents . <i>NOTE:</i> To determine the most recent iDRAC release for your platform and for latest documentation version, see KB article https://www.dell.com/support/article/sln308699 .

NOTE: To access iDRAC, ensure that you connect the ethernet cable to the iDRAC9 dedicated network port or use iDRAC Direct port by using the USB cable. You can also access iDRAC through the shared LOM mode, if you have opted for a system that has the shared LOM mode enabled.

Options to log in to iDRAC

To log in to the iDRAC Web User Interface, open a browser and enter the IP address.

You can log in to iDRAC as:

- iDRAC user
- Microsoft Active Directory user
- Lightweight Directory Access Protocol (LDAP) user

In the log in screen displayed, if you have opted for secure default access to iDRAC, enter the iDRAC secure default password available on back side of the Information Tag. If you have not opted for secure default access to iDRAC, enter the default user name and password – `root` and `calvin`. You can also log in by using your Single Sign-On or Smart Card.

NOTE: Ensure that you change the default username and password after setting up the iDRAC IP address.

For more information about logging in to the iDRAC and iDRAC licenses, see the latest *Integrated Dell Remote Access Controller User's Guide* at www.dell.com/idracmanuals.

NOTE: To determine the most recent iDRAC release for your platform and for latest documentation version, see KB article <https://www.dell.com/support/article/sln308699>.

You can also access iDRAC using command-line protocol - RACADM. For more information, see the *iDRAC with Lifecycle Controller RACADM CLI Guide* available at www.dell.com/idracmanuals.

You can also access iDRAC using automation tool - Redfish API. For more information, see the *iDRAC9 with Lifecycle Controller Redfish API Guide* available at <https://www.dell.com/idracmanuals>.

Resources to install operating system

If the system is shipped without an operating system, you can install a supported operating system by using one of the resources provided in the table. For information about how to install the operating system, see the documentation links provided in the table.

Table 10. Resources to install the operating system

Resource	Documentation links
iDRAC	<i>Integrated Dell Remote Access Controller User's Guide</i> at https://www.dell.com/idracmanuals or for system specific <i>Integrated Dell Remote Access Controller User's Guide</i> , go to https://www.dell.com/poweredgemanuals > Product Support page of your system > Manuals & documents . <i>NOTE:</i> To determine the most recent iDRAC release for your platform and for latest documentation version, see KB article at https://www.dell.com/support/article/sln308699 .
Lifecycle Controller	<i>Lifecycle Controller User's Guide</i> at https://www.dell.com/idracmanuals or for system specific <i>Lifecycle Controller User's Guide</i> , go to https://www.dell.com/poweredgemanuals > Product Support page of your system > Manuals & documents . Dell recommends using Lifecycle Controller to install the OS, since all required drivers are installed to the system. <i>NOTE:</i> To determine the most recent iDRAC release for your platform and for latest documentation version, see KB article at https://www.dell.com/support/article/sln308699 .
OpenManage Deployment Toolkit	www.dell.com/openmanagemanuals > OpenManage Deployment Toolkit
Dell certified VMware ESXi	www.dell.com/virtualizationsolutions

NOTE: For more information about Installation and How-to videos for supported operating systems on PowerEdge system see, [Supported Operating Systems for Dell EMC PowerEdge systems](#).

Options to download firmware

You can download firmware from the Dell support site. For information, see the [Downloading drivers and firmware](#) section.

You can also choose any one of the following options to download the firmware. For information about how to download the firmware, see the documentation links provided in the table.

Table 11. Options to download firmware

Option	Documentation link
Using Dell Remote Access Controller Lifecycle Controller (iDRAC with LC)	www.dell.com/idracmanuals
Using Dell Repository Manager (DRM)	www.dell.com/openmanagemanuals > Repository Manager
Using Dell Server Update Utility (SUU)	www.dell.com/openmanagemanuals > Server Update Utility
Using Dell OpenManage Deployment Toolkit (DTK)	www.dell.com/openmanagemanuals > OpenManage Deployment Toolkit
Using iDRAC virtual media	www.dell.com/idracmanuals

Options to download and install OS drivers

You can choose any one of the following options to download and install OS drivers. For information about how to download or install OS drivers, see the documentation links provided in the table.

Table 12. Options to download and install OS drivers

Option	Documentation
Dell EMC support site	Downloading drivers and firmware section.
iDRAC virtual media	<p><i>Integrated Dell Remote Access Controller User's Guide</i> at https://www.dell.com/idracmanuals or for system specific <i>Integrated Dell Remote Access Controller User's Guide</i>, go to https://www.dell.com/poweredgemanuals > Product Support page of your system > Manuals & documents.</p> <p>NOTE: To determine the most recent iDRAC release for your platform and for latest documentation version, see https://www.dell.com/support/article/sln308699.</p>

Downloading drivers and firmware

It is recommended that you download and install the latest BIOS, drivers, and systems management firmware on the system.

Prerequisites

Ensure that you clear the web browser cache before downloading the drivers and firmware.

Steps

1. Go to www.dell.com/support/drivers.
2. Enter the Service Tag of the system in the **Enter a Dell Service Tag, Dell EMC Product ID or Model** field, and then press Enter.

NOTE: If you do not have the Service Tag, select **Detect PC** to automatically detect the Service Tag, or click **Browse all products**, and navigate to your product.
3. On the displayed product page, click **Drivers & Downloads**.
On the **Drivers & Downloads** page, all drivers that are applicable to the system are displayed.
4. Download the drivers to a USB drive, CD, DVD or local machine.

Installing and removing system components

Topics:

- Safety instructions
- Before working inside your system
- After working inside your system
- Recommended tools
- Optional front bezel
- System cover
- Drive backplane cover
- Control panel
- VGA module
- Air shroud
- Cooling fan
- Drives
- Drive backplane
- Cable routing
- Rear drive module
- Front PERC module
- System memory
- Processor and heat sink
- Expansion cards and expansion card risers
- Optional serial COM port
- Optional IDSDM module
- MicroSD card
- M.2 SSD module on BOSS-S1 adapter card
- BOSS S2 card (optional)
- System battery
- Optional internal USB card
- Intrusion switch module
- Optional OCP card
- Power supply unit
- Trusted Platform Module
- System board
- LOM card and rear I/O board
- RIO card
- Tube clip

Safety instructions

 **NOTE:** To avoid injury, do not lift the system on your own. Get others to assist you.

 **WARNING:** Opening or removing the system cover while the system is turned on may expose you to a risk of electric shock..

 **CAUTION:** Many repairs may only be done by a certified service technician. You should only perform troubleshooting and simple repairs as authorized in your product documentation, or as directed by the online or telephone service and support team. Damage due to servicing that is not authorized by Dell is not covered by your warranty. Read and follow the safety instructions that are shipped with your product.

CAUTION: To ensure proper operation and cooling, all system bays and fans must be always populated with a component or a blank.

- NOTE:** It is recommended that you always use an antistatic mat and antistatic strap while working on components inside the system.
- NOTE:** While replacing the hot swappable PSU, after next server boot; the new PSU automatically updates to the same firmware and configuration of the replaced one. For more information about the Part replacement configuration, see the *Lifecycle Controller User's Guide* at <https://www.dell.com/idracmanuals>
- NOTE:** While replacing faulty storage controller/FC/NIC card with the same type of card, after you power on the system; the new card automatically updates to the same firmware and configuration of the faulty one. For more information about the Part replacement configuration, see the *Lifecycle Controller User's Guide* at <https://www.dell.com/idracmanuals>
- NOTE:** Ensure to install the latest iDRAC 4.4x version or any later versions to support the 1100 W Titanium Mixed Mode AC/HVDC PSU and (-48V) 1100 W DC PSU.
- NOTE:** For detailed information on cabling the PERC 11 cards, see the system-specific owner's manual at Installation and Service Manual available at <https://www.dell.com/poweredgemanuals>

Before working inside your system

Prerequisites

Follow the safety guidelines listed in [Safety instructions](#).

Steps

1. Power off the system and all attached peripherals.
2. Disconnect the system from the electrical outlet, and disconnect the peripherals.
3. If applicable, remove the system from the rack.
For more information, see the *Rail Installation Guide* relevant to your rail solutions at www.dell.com/poweredgemanuals.
4. Remove the system cover.

After working inside your system

Prerequisites

Follow the safety guidelines listed in [Safety instructions](#).

Steps

1. Replace the system cover.
2. If applicable, install the system into the rack.
For more information, see the *Rail Installation Guide* relevant to your rail solutions at www.dell.com/poweredgemanuals.
3. Reconnect the peripherals and connect the system to the electrical outlet, and then power on the system.

Recommended tools

You need the following tools to perform the removal and installation procedures:

- Key to the bezel lock. The key is required only if your system includes a bezel.
- Phillips #1 screwdriver
- Phillips #2 screwdriver
- Torx #T20 screwdriver
- 5mm hex nut screwdriver
- Plastic scribe

- 1/4 inch flat blade screwdriver
- Wrist grounding strap connected to the ground
- ESD mat

You need the following tools to assemble the cables for a DC power supply unit:

- AMP 90871-1 hand-crimping tool or equivalent
- Tyco Electronics 58433-3 or equivalent
- Wire-stripper pliers to remove insulation from size 10 AWG solid or stranded, insulated copper wire

NOTE: Use alpha wire part number 3080 or equivalent (65/30 stranding).

Optional front bezel

Removing the front bezel

The procedure to remove the front bezel with and without the LCD panel is the same.

Prerequisites

1. Follow the safety guidelines listed in the [Safety instructions](#).
2. Keep the bezel key handy.

NOTE: The bezel key is part of the LCD bezel package.

Steps

1. Unlock the bezel.
2. Press the release button, and disengage the left end of the bezel.
3. Unhook the right end, and remove the bezel.



Figure 15. Removing the front bezel

Next steps

1. [Replace the front bezel.](#)

Installing the front bezel

The procedure to install the front bezel with and without the LCD panel is the same.

Prerequisites

1. Follow the safety guidelines listed in the [Safety instructions](#).
2. Locate and remove the bezel key.

NOTE: The bezel key is part of the LCD bezel package.

Steps

1. Align and insert the tabs on the bezel into the slots on the system.
2. Press the bezel until the release button clicks in place.
3. Lock the bezel.



Figure 16. Installing the front bezel

System cover

Removing the system cover

Prerequisites

1. Follow the safety guidelines listed in the [Safety instructions](#).
2. Power off the system, and any attached peripherals.
3. Disconnect the system from the electrical outlet and peripherals.

Steps

1. Using a 1/4-inch flat head or a Phillips #2 screwdriver rotate the lock counterclockwise to the unlock position.
2. Lift the release latch until the system cover slides back.
3. Lift the cover from the system.

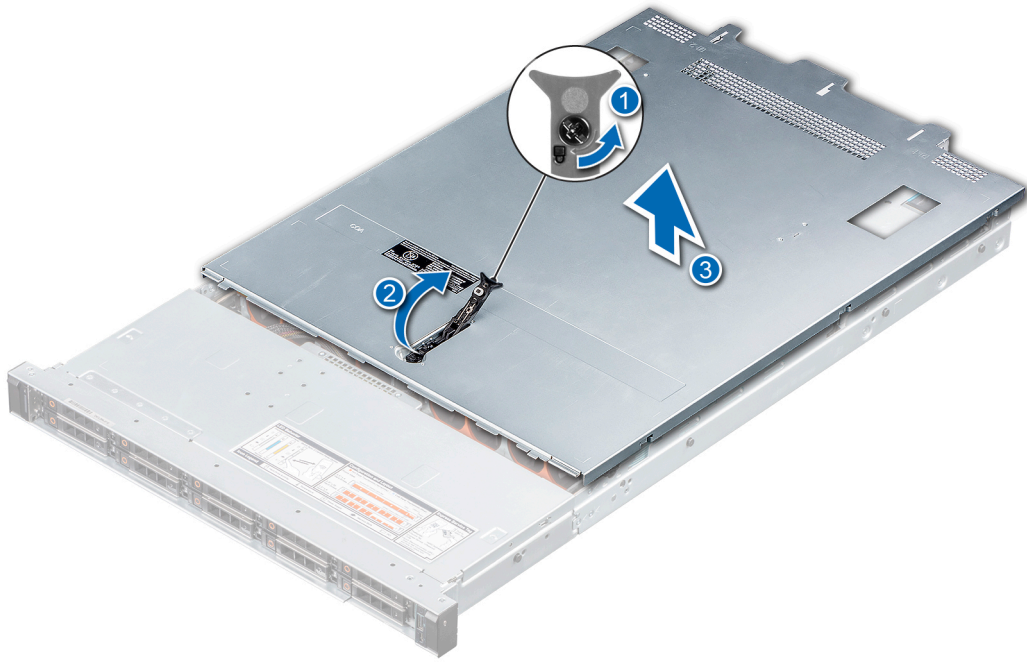

Figure 17. Removing the system cover

Next steps

1. [Replace the system cover.](#)

Installing the system cover

Prerequisites

1. Follow the safety guidelines listed in the [Safety instructions](#).
2. Follow the procedure listed in [Before working inside your system](#).
3. Ensure that all internal cables are connected and routed properly, and no tools or extra parts are left inside the system.

Steps

1. Align the tabs on the system cover with the guide slots on the system and slide the system cover.
2. Close the system cover release latch.
3. Using a 1/4-inch flat head or Phillips #2 screwdriver, rotate the lock clockwise to the lock position.

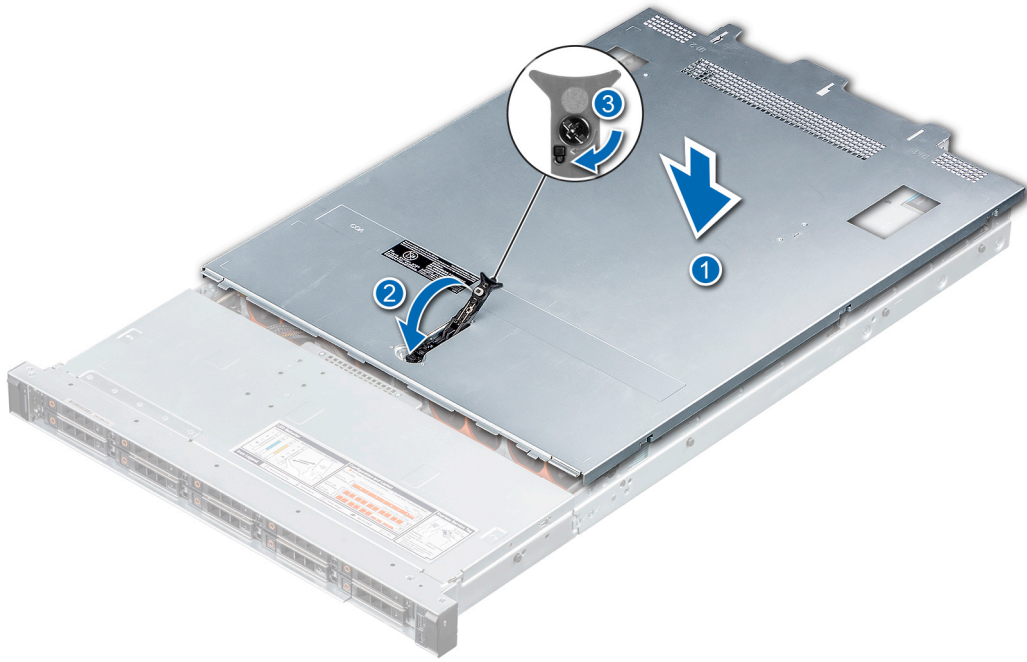

Figure 18. Installing the system cover

Next steps

1. Follow the procedure listed in [After working inside your system.](#)

Drive backplane cover

Removing the drive backplane cover

Prerequisites

1. Follow the safety guidelines listed in the [Safety instructions.](#)
2. Follow the procedure listed in [Before working inside your system.](#)

Steps

1. Slide the backplane cover in the direction of the arrows marked on the drive backplane cover.
2. Lift the backplane cover from the system.

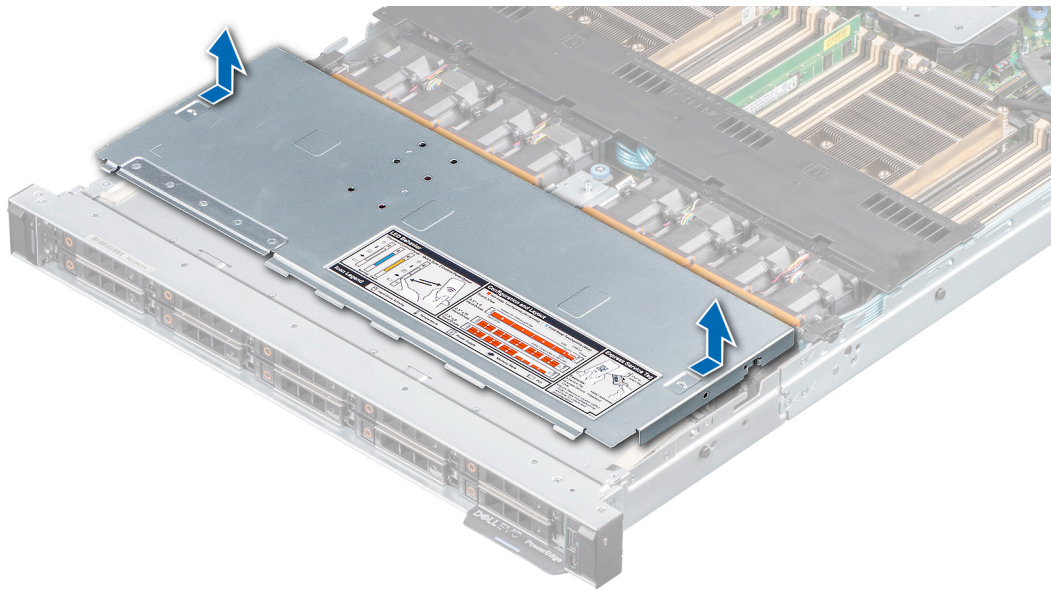

Figure 19. Removing the drive backplane cover

Next steps

1. [Replace the drive backplane cover.](#)

Installing the drive backplane cover

Prerequisites

1. Follow the safety guidelines listed in the [Safety instructions](#).

Steps

1. Align the drive backplane cover with the guide slots on the system.
2. Slide the drive backplane cover to the front of the system until the drive backplane cover fits into place.

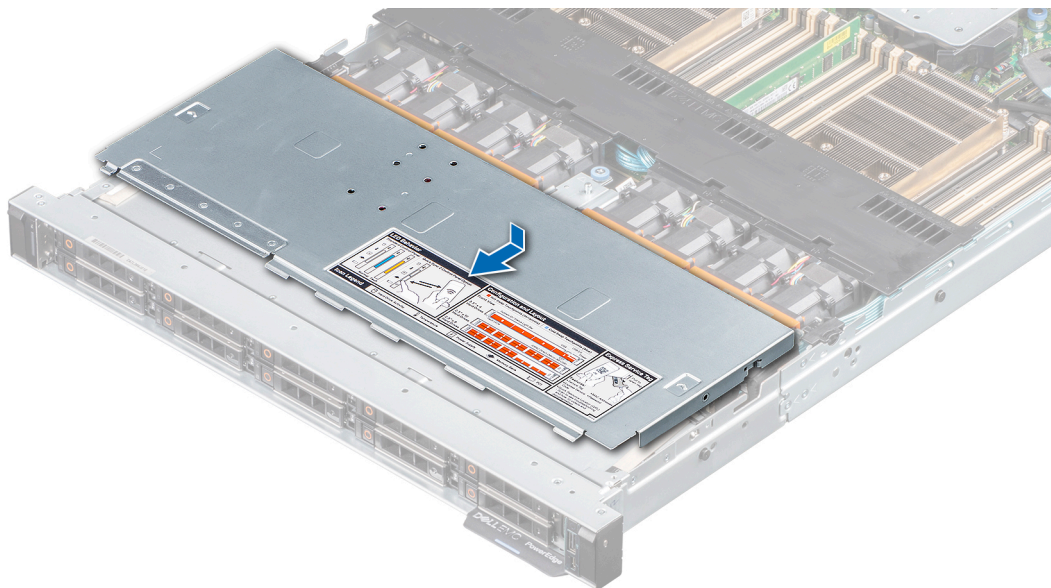

Figure 20. Installing the drive backplane cover

Next steps

1. Follow the procedure listed in [After working inside your system](#).

Control panel

Removing the right control panel

Prerequisites

1. Follow the safety guidelines listed in the [Safety instructions](#).
2. Follow the procedure listed in the [Before working inside your system](#).
3. [Remove the drive backplane cover](#).
4. If installed, [remove the air shroud](#).

Steps

1. Disconnect the right control panel cable from the connector on the system board.
2. Lift the latch, and slide the cable out of the clip.

NOTE: Observe the routing of the cable as you remove the right control panel from the system.

3. Using the Phillips #1 screwdriver, remove the screws that secure the right control panel to the system.
4. Holding the cable, slide the right control panel out of the system.

NOTE: The numbers on the image do not depict the exact steps. The numbers are for representation of sequence.

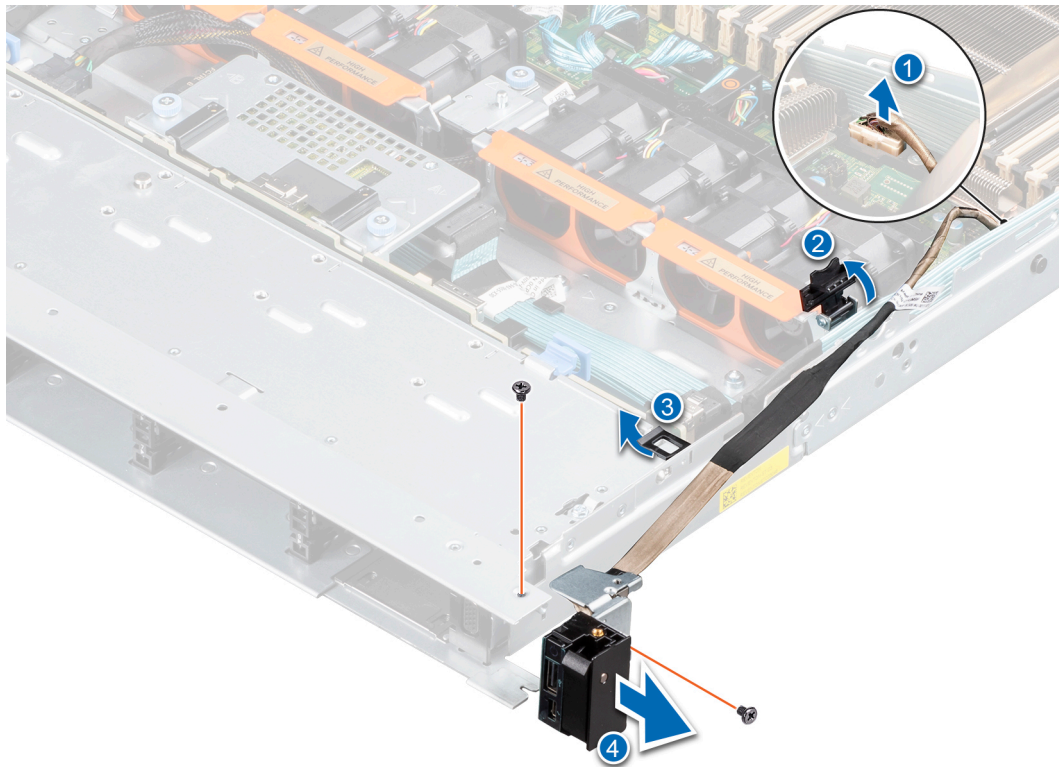

Figure 21. Removing the right control panel

Next steps

1. [Replace the right control panel](#).

Installing the right control panel

Prerequisites

1. Follow the safety guidelines listed in the [Safety instructions](#).
2. Follow the procedure listed in [Before working inside your system](#).

Steps

1. Align and slide the right control panel in the slot on the system.
2. Connect the right control panel cable to the connector on the system board.
3. Route the right control panel cable through the side wall of the system. Close the cable latch and slide the cable into the clip.

NOTE: Route the cable properly to prevent the cable from being pinched or crimped.

4. Using the Phillips #1 screwdriver, tighten the screws that secure the right control panel to the system.

NOTE: The numbers on the image do not depict the exact steps. The numbers are for representation of sequence.

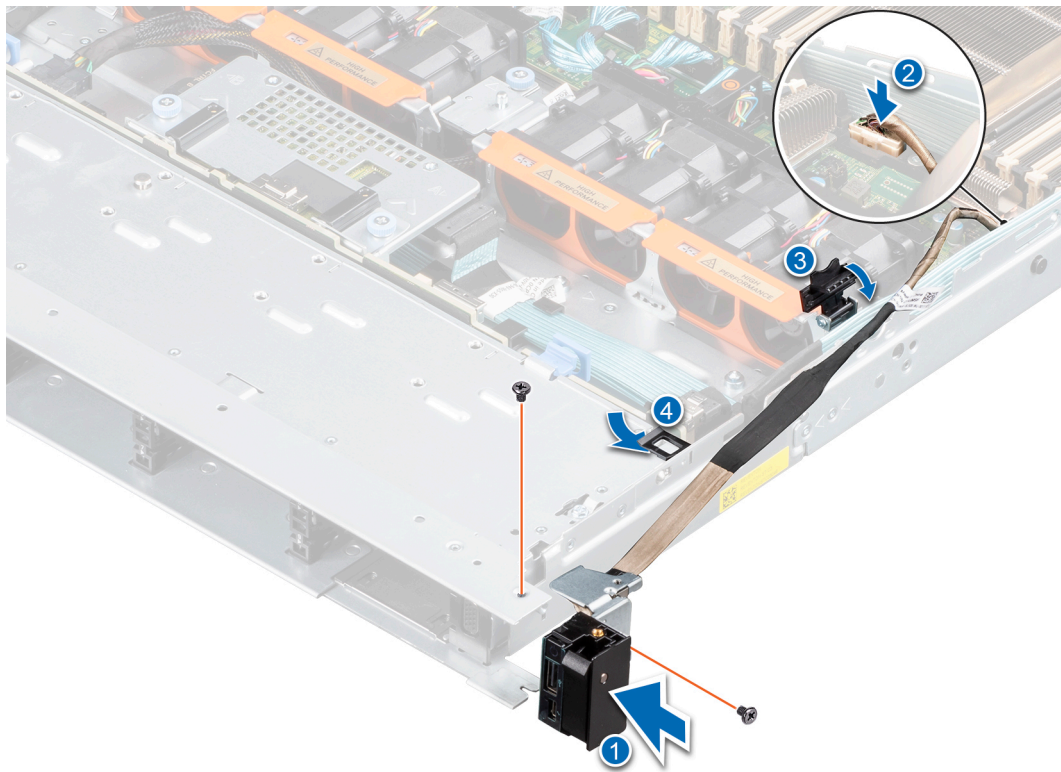

Figure 22. Installing the right control panel

Next steps

1. [Install the drive backplane cover](#).
2. If removed, [install the air shroud](#).
3. Follow the procedure listed in [After working inside your system](#).

Removing the left control panel

Prerequisites

1. Follow the safety guidelines listed in the [Safety instructions](#).
2. Follow the procedure listed in the [Before working inside your system](#).

3. If installed, [remove the air shroud](#).

Steps

1. Disconnect the control panel cable from the connector on the system board.
2. Lift the latch to release the control panel cable and slide the cable from the clip.

NOTE: Observe the routing of the cable as you remove it from the system.

3. Using the Phillips #1 screwdriver, remove the screws that secure the left control panel to the system.
4. Hold the left control panel cable, and slide the left control panel out of the system.

NOTE: The numbers on the image do not depict the exact steps. The numbers are for representation of sequence.

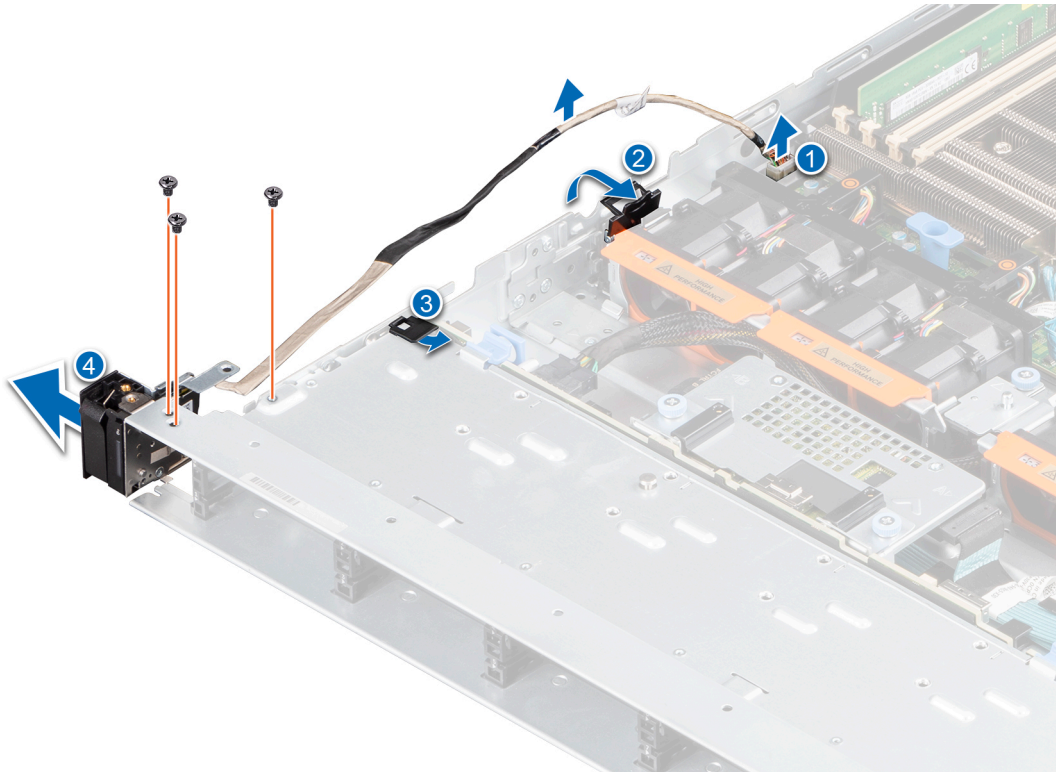

Figure 23. Removing the left control panel

Next steps

1. [Replace the left control panel](#).

Installing the left control panel

Prerequisites

1. Follow the safety guidelines listed in the [Safety instructions](#).
2. Follow the procedure listed in [Before working inside your system](#).

Steps

1. Align and slide the left control panel in the slot on the system.
2. Connect the left control panel cable to the connector on the system board and secure it using cable latch.
3. Route the left control panel cable through the side wall of the system and slide the cable into the clip.

NOTE: Route the cable properly to prevent the cable from being pinched or crimped.

- Using the Phillips #1 screwdriver, tighten the screws to secure the left control panel to the system.

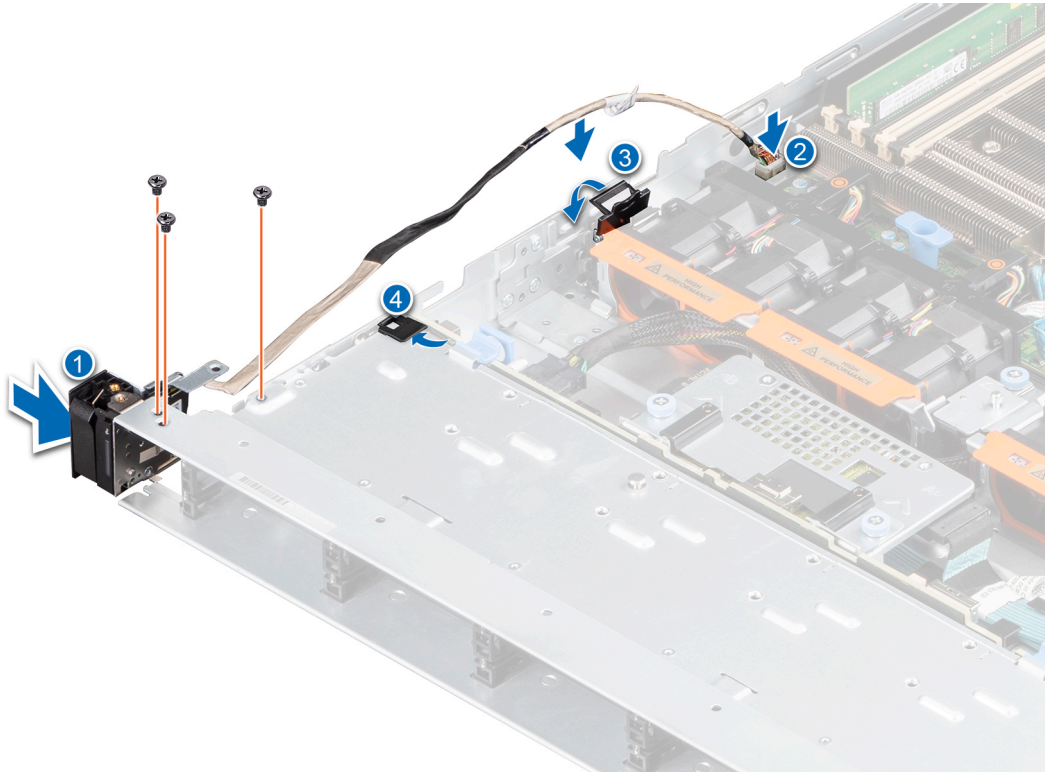

Figure 24. Installing the left control panel

Next steps

- Install the drive backplane cover.
- If removed, install the air shroud.
- Follow the procedure listed in [After working inside your system](#).

VGA module

Removing the VGA module

Prerequisites

- Follow the safety guidelines listed in the [Safety instructions](#).
- Follow the procedure listed in the [Before working inside your system](#).
- If installed, [remove the front bezel](#).
- [Remove the backplane cover](#).
- If installed, [remove the air shroud](#).
- Disconnect the VGA cable from the connector on the system board and open the cable latch.
- Disconnect the right control panel cable from the system board and move it away to see the VGA module screw on the system.

i **NOTE:** Ensure that you note the routing of the cables as you remove them from the system board. Route the cable properly when you replace it to prevent the cable from being pinched or crimped

Steps

- Using Phillips #2 screwdriver, remove the screw on the VGA module.
- Slide the VGA module out of the system.

NOTE: The numbers on the image do not depict the exact steps. The numbers are for representation of sequence.

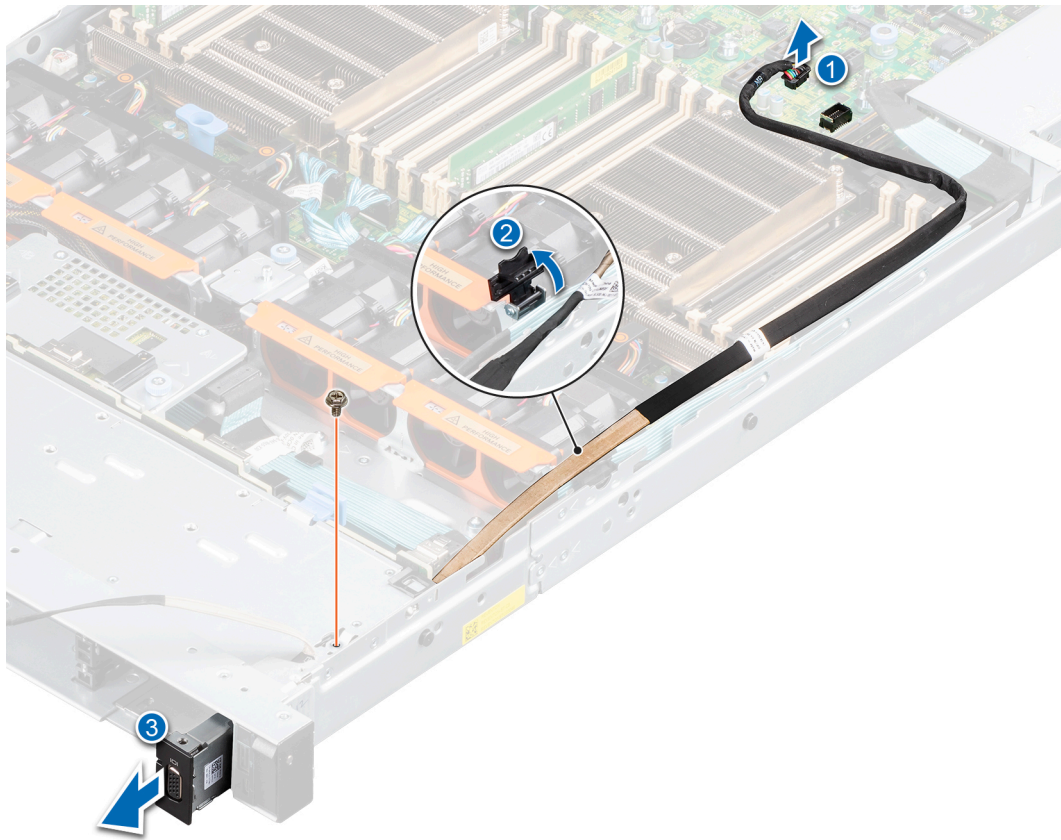

Figure 25. Removing the VGA module

Next steps

1. [Replace the VGA module.](#)

Installing the VGA module

Prerequisites

1. Follow the safety guidelines listed in the [Safety instructions](#).
2. Follow the procedure listed in the [Before working inside your system](#).
3. If installed, [remove the front bezel](#).
4. [Remove the backplane cover](#).
5. If installed, [remove the air shroud](#).
6. Disconnect the VGA cable from the connector on the system board.
7. Pull the right control panel cable from the clip and move it to clear the path of the see the VGA module screw.

NOTE: Ensure that you note the routing of the cables as you remove them from the system board. Route the cable properly when you replace it to prevent the cable from being pinched or crimped

Steps

1. Route the VGA cable through the slot on the front of the system and slide the VGA module into the slot.
2. Align the hole on the module with the screw hole on the system.
3. Using the Phillips #2 screwdriver, secure the VGA module to the system with the screw.

NOTE: The numbers on the image do not depict the exact steps. The numbers are for representation of sequence.

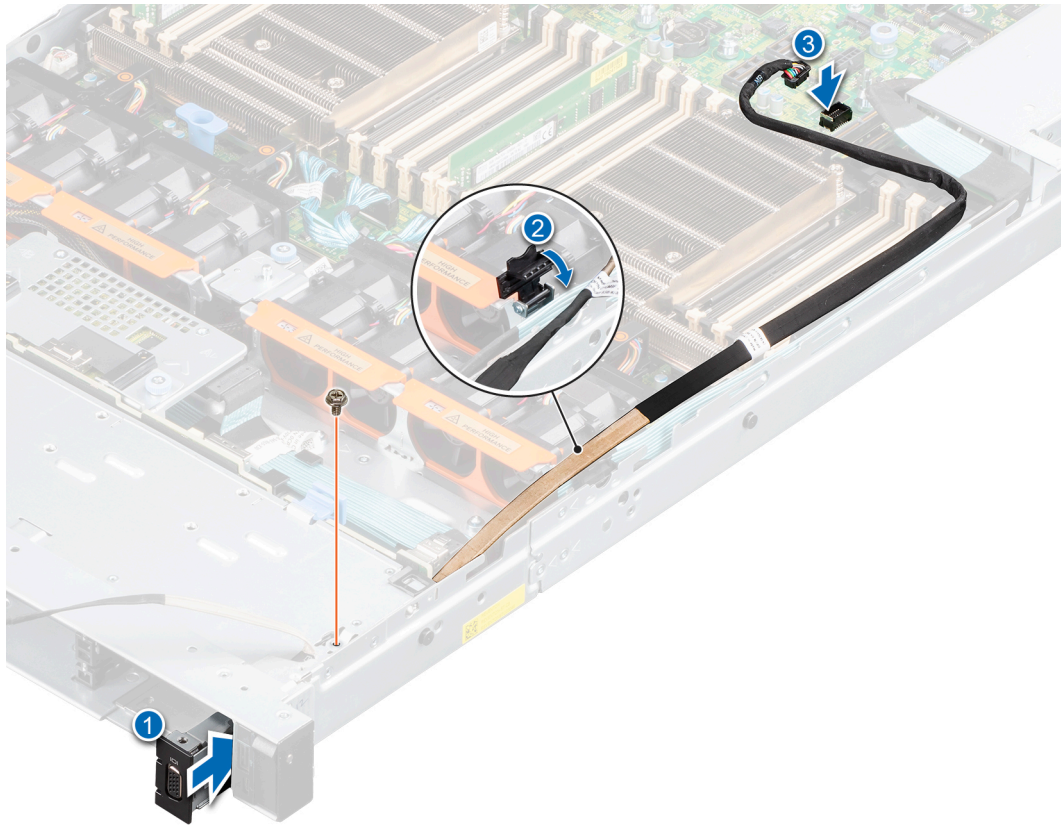

Figure 26. Installing the VGA module

Next steps

1. Route the VGA cable, close the cable latch, and connect the VGA cable to the connector on the system board.
2. Route and connect the right control panel cable.
3. If removed, [install the air shroud](#).
4. [Install the backplane cover](#).
5. If installed, [install the front bezel](#).
6. Follow the procedure listed in the [After working inside your system](#).

Air shroud

Removing the air shroud

Prerequisites

CAUTION: Never operate your system with the air shroud removed. The system may get overheated quickly, resulting in shutdown of the system and loss of data.

1. Follow the safety guidelines listed in the [Safety instructions](#).
2. Follow the procedure listed in [Before working inside your system](#).

Steps

1. Hold the edges of the air shroud, and lift the air shroud out of the system.
NOTE: The air shroud is required for the standard heat sink configuration. For the L-type heat sink configuration, air shroud is not supported.

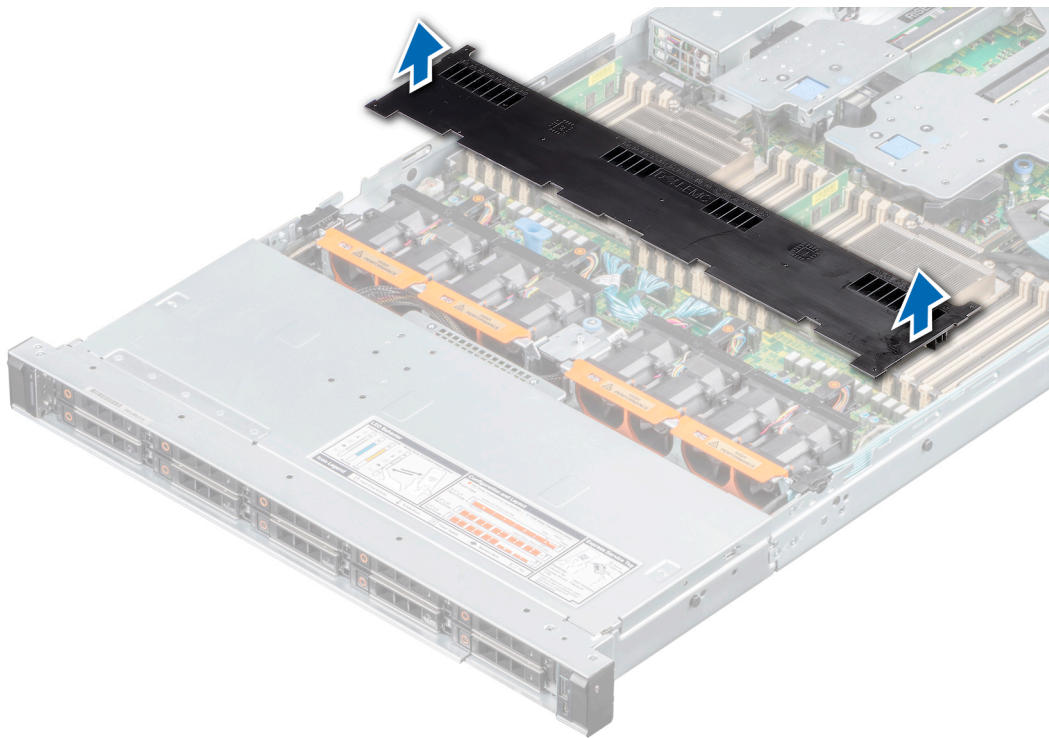

Figure 27. Removing the air shroud

2. For the air shroud on the rear drive module, hold the edges of the air shroud, and lift the air shroud out of the rear drive module.

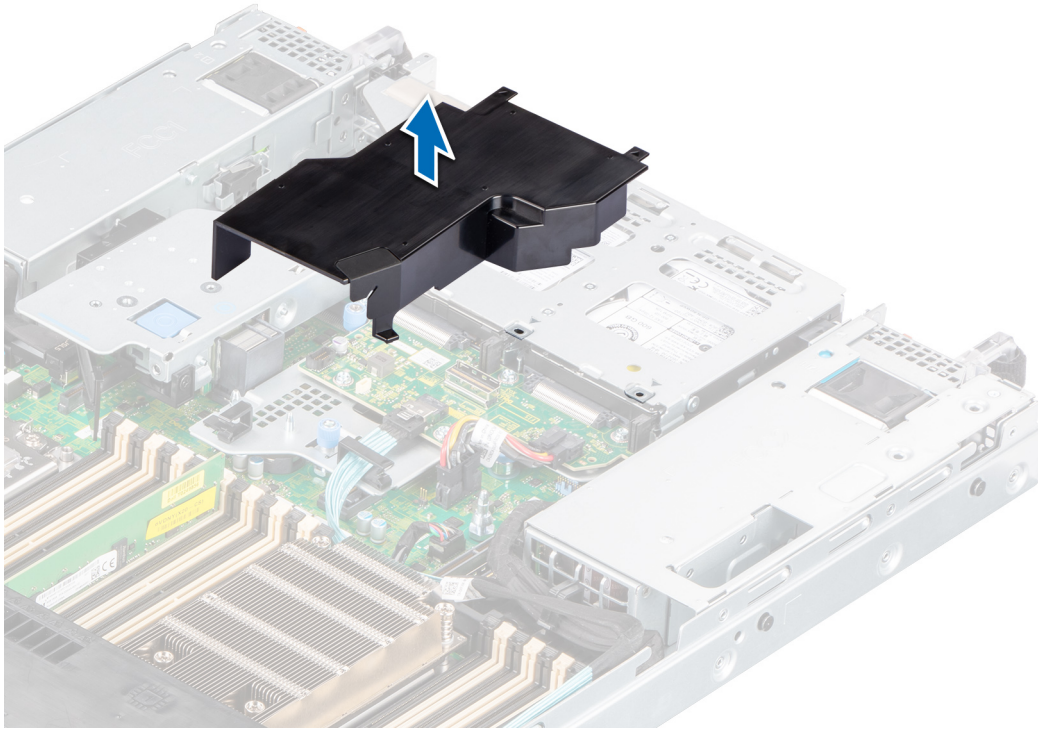

Figure 28. Removing the air shroud from the rear drive module

Next steps

1. [Replace the air shroud.](#)

Installing the air shroud

Prerequisites

1. Follow the safety guidelines listed in the [Safety instructions](#).
2. Follow the procedure listed in [Before working inside your system](#).

Steps

1. Align the slot on the air shroud with the standoff on the system.
2. Lower the air shroud into the system until it is firmly seated.

i **NOTE:** The air shroud is required for the standard heat sink configuration. For the L-type heat sink configuration, air shroud is not supported.

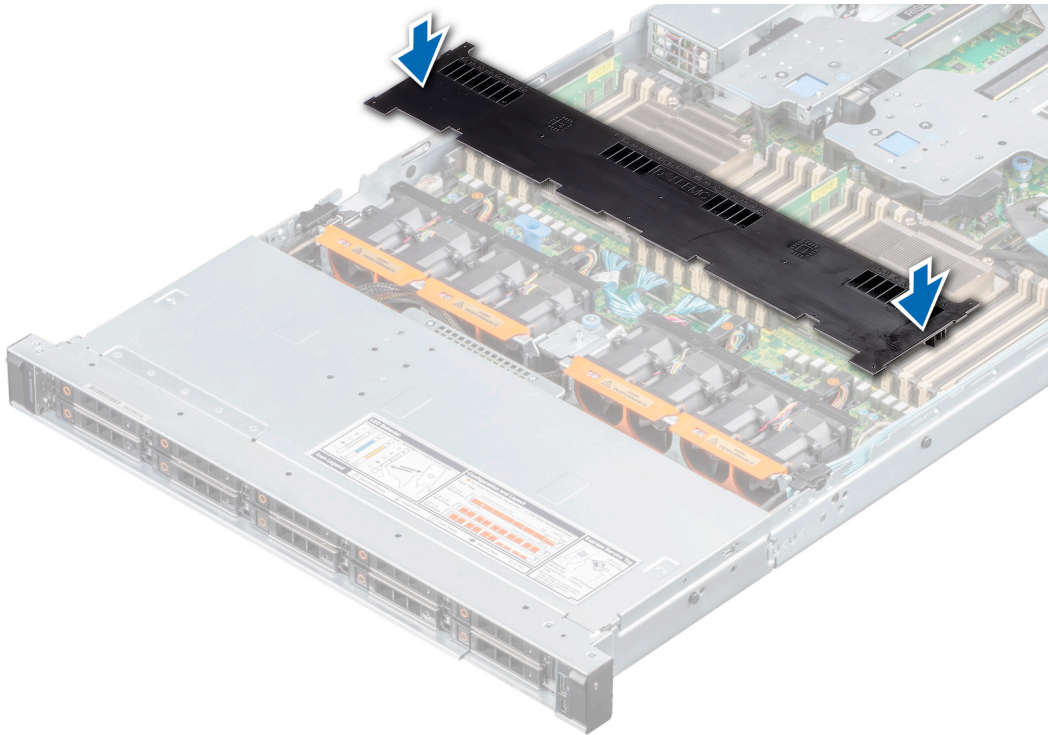

Figure 29. Installing the air shroud

3. For the air shroud on the rear drive module, lower the air shroud into the rear drive module until it is firmly seated.

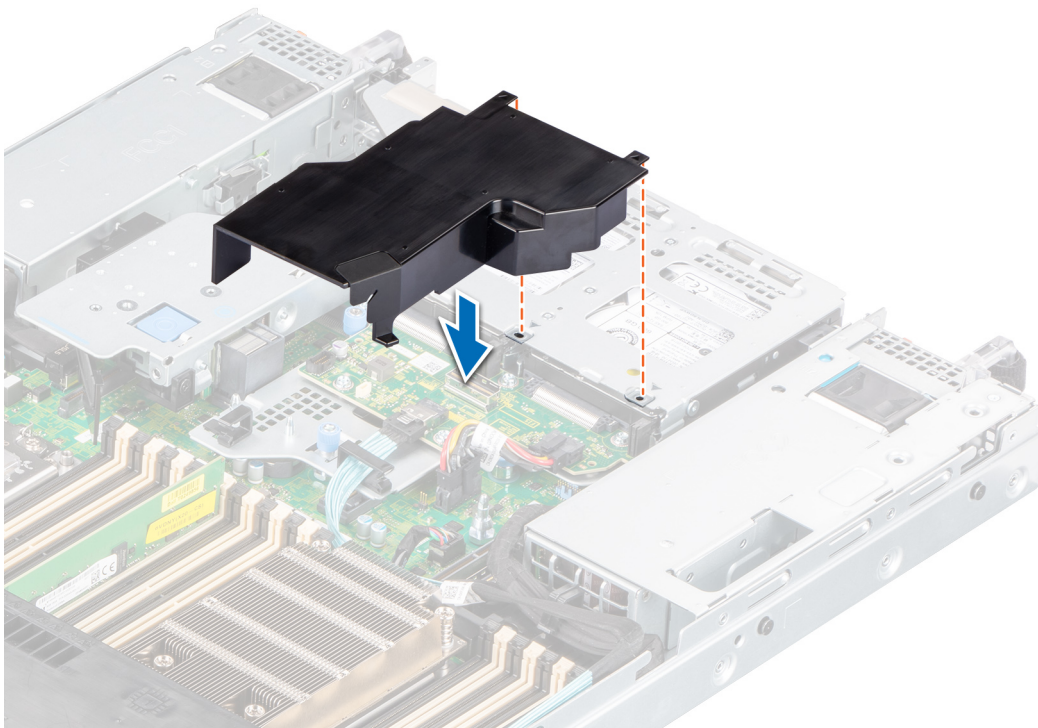

Figure 30. Installing the air shroud on the rear drive module

Next steps

1. Follow the procedure listed in [After working inside your system.](#)

Cooling fan

Removing a cooling fan module

Prerequisites

1. Follow the safety guidelines listed in the [Safety instructions](#).
2. Follow the procedure listed in [Before working inside your system](#).
3. If installed, [remove the air shroud](#).

Steps

Holding the orange and black edges on the fan module, lift the cooling fan module horizontally to disconnect from the connector on the system board.

NOTE: The procedure to remove standard, high performance (silver grade), or high performance (gold grade) fan module is same.

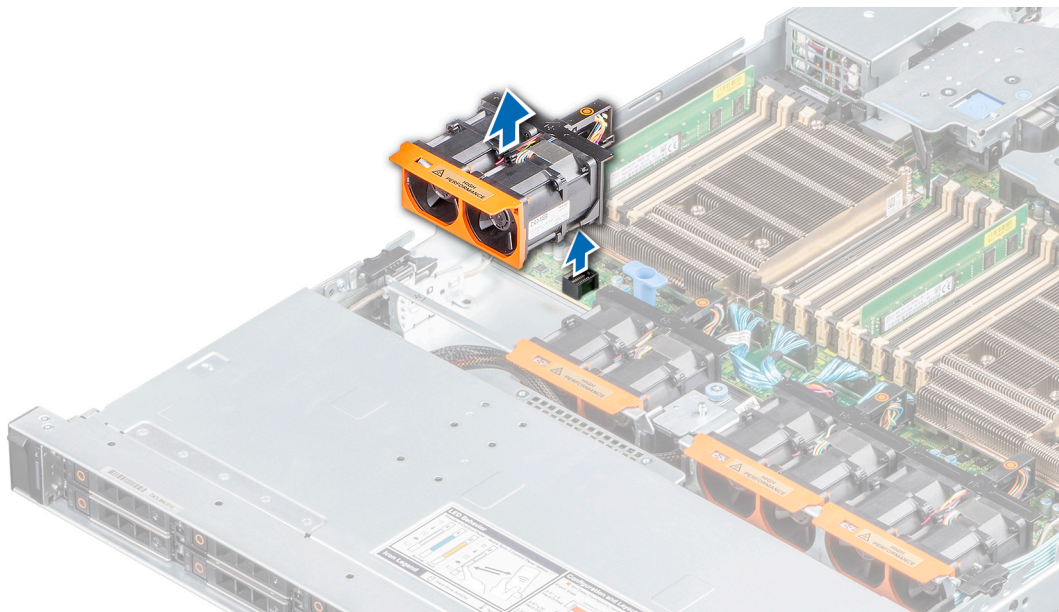

Figure 31. Removing a cooling fan module

WARNING: Ensure not to tilt or rotate the cooling fan module while removing from the system.

Next steps

1. [Replace a cooling fan module](#).

Installing a cooling fan module

Prerequisites

1. Follow the safety guidelines listed in the [Safety instructions](#).
2. Follow the procedure listed in [Before working inside your system](#).
3. If installed, [remove the air shroud](#).

Steps

1. Align and place the fan module connector horizontally with the connector on the system board.

NOTE: The procedure to install standard, high performance (silver grade), or high performance (gold grade) fan module is same.

2. Press the touch point on the cooling fan module until firmly connected.

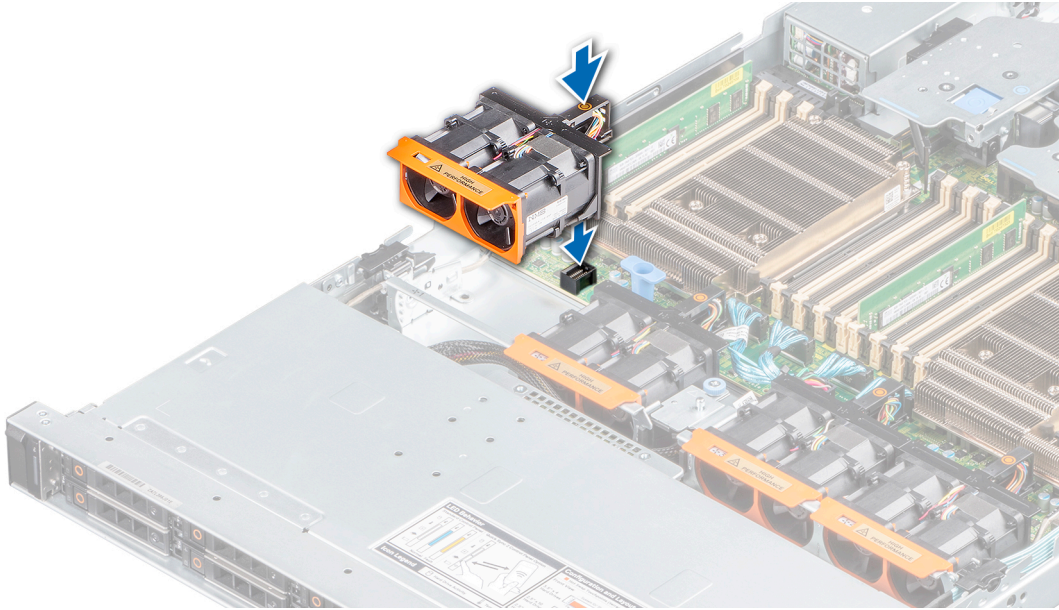

Figure 32. Installing a cooling fan module

Next steps

1. If removed, [install the air shroud](#).
2. Follow the procedure listed in [After working inside your system](#).

Drives

Removing a drive blank

Prerequisites

1. Follow the safety guidelines listed in the [Safety instructions](#).
2. If installed, [remove the front bezel](#).

CAUTION: To maintain proper system cooling, drive blanks must be installed in all empty drive slots.

Steps

Press the release button, and slide the drive blank out of the drive slot.

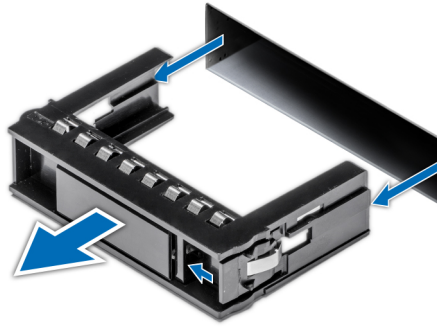

Figure 33. Removing a drive blank

Next steps

1. Installing a drive or replace the drive blank.

Installing a drive blank

Prerequisites

1. Follow the safety guidelines listed in the [Safety instructions](#).
2. If installed, [remove the front bezel](#).

Steps

Insert the drive blank into the drive slot until the release button clicks into place.

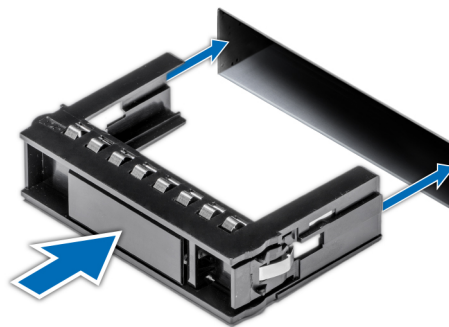

Figure 34. Installing a drive blank

Next steps

1. If removed, [install the front bezel](#).

Removing the drive carrier

Prerequisites

1. Follow the safety guidelines listed in the [Safety instructions](#).
2. If installed, [remove the front bezel](#).
3. Using the management software, prepare the drive for removal.

If the drive is online, the green activity or fault indicator blinks while the drive is powering off. When the drive indicators are off, the drive is ready for removal. For more information, see the documentation for the storage controller.

CAUTION: Before attempting to remove or install a drive while the system is running, see the documentation for the storage controller card to ensure that the host adapter is configured correctly to support drive removal and insertion.

CAUTION: To prevent data loss, ensure that your operating system supports drive installation. For more information about the drives installation or uninstallation requirements, see the operating system's user guide.

Steps

1. Press the release button to open the drive carrier release handle.
2. Holding the drive carrier release handle, slide the drive carrier out of the drive slot.



Figure 35. Removing a drive carrier

Next steps

1. Install a drive carrier or drive blank.

Installing the drive carrier

Prerequisites

CAUTION: Before removing or installing a drive while the system is running, see the documentation for the storage controller card to ensure that the host adapter is configured correctly to support drive removal and insertion.

CAUTION: Combining SAS and SATA drives in the same RAID volume is not supported.

CAUTION: When installing a drive, ensure that the adjacent drives are fully installed. Inserting a drive carrier and attempting to lock its handle next to a partially installed carrier can damage the partially installed carrier's shield spring and make it unusable.

CAUTION: To prevent data loss, ensure that your operating system supports hot-swap drive installation. See the documentation supplied with your operating system.

NOTE: When a replacement hot swappable drive is installed while the system is powered on, the drive automatically begins to rebuild. Ensure that the replacement drive is blank. Any data on the replacement drive is immediately lost once the drive is installed.

NOTE: Ensure that the drive carrier's release handle is in the open position before inserting the carrier into the slot.

1. Follow the safety guidelines listed in the [Safety instructions](#).
2. If installed, [remove the front bezel](#).
3. Remove the drive carrier or remove the drive blank when you want to assemble the drives in to the system.

Steps

1. Slide the drive carrier into the drive slot.
2. Close the drive carrier release handle to lock the drive in place.



Figure 36. Installing a drive carrier

Next steps

If removed, [install the front bezel](#).

Removing the drive from the drive carrier

Prerequisites

1. Follow the safety guidelines listed in the [Safety instructions](#).
2. If installed, [remove the front bezel](#).

Steps

1. Using a Phillips #1 screwdriver, remove the screws from the slide rails on the drive carrier.

NOTE: If the hard drive or SSD carrier has Torx screw, use Torx 6 (for 2.5-inch drive) or Torx 8 (for 3.5-inch drive) screwdriver to remove the drive.

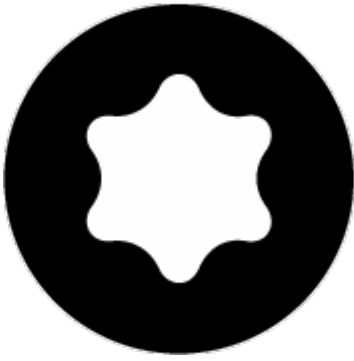

2. Lift the drive out of the drive carrier.



Figure 37. Removing the drive from the drive carrier

Next steps

Install the drive into the drive carrier.

Installing the drive into the drive carrier

Prerequisites

1. Follow the safety guidelines listed in the [Safety instructions](#).
2. If installed, [remove the front bezel](#).
3. [Remove the drive blank](#).

Steps

1. Insert the drive into the drive carrier with the drive connector facing towards the rear of the carrier.
2. Align the screw holes on the drive with the screws holes on the drive carrier.
3. Using a Phillips #1 screwdriver, secure the drive to the drive carrier with the screws.

NOTE: When installing a drive into the drive carrier, ensure that the screws are torqued to 4 lbf-in.

NOTE: If the hard drive or SSD carrier has Torx screw, use Torx 6 (for 2.5-inch drive) or Torx 8 (for 3.5-inch drive) screwdriver to install the drive.



Figure 38. Installing a drive into the drive carrier

Next steps

1. [Install the drive carrier.](#)
2. If removed, [install the front bezel.](#)

Drive backplane

Drive backplane

Depending on your system configuration, the drive backplanes supported are listed here:

Table 13. Supported backplane options

System	Supported hard drives options
PowerEdge R6525	3.5-inch (x4) SAS, SATA backplane
	2.5-inch (x8) SAS or SATA backplane
	2.5-inch (x10) SAS, SATA or NVMe backplane
	2.5-inch (x2) SAS/SATA/NVME rear backplane

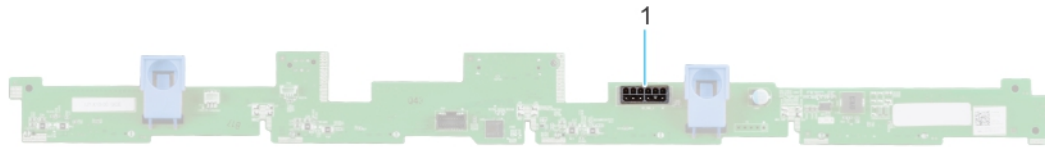

Figure 39. 4 x 3.5-inch drive backplane

1. BP_PWR_1 (backplane power and signal cable to system board)



Figure 40. 8 x 2.5-inch drive backplane

1. BP_PWR_1 (backplane power and signal cable to system board)

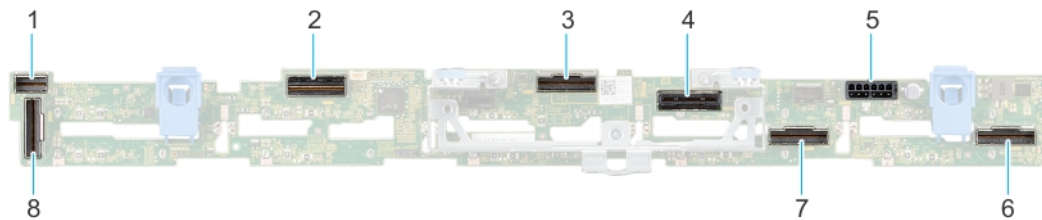

Figure 41. 10 x 2.5-inch drive backplane

- | | |
|--|----------------------------------|
| 1. DST_SA2 (backplane to front PERC) | 2. DST_PB2 (PCIe/NVMe connector) |
| 3. DST_PA2 (PCIe/NVMe connector) | 4. DST_SA1 (PERC to backplane) |
| 5. BP_PWR_1 (backplane power and signal cable to system board) | 6. DST_PA1 (PCIe/NVMe connector) |
| 7. DST_PB1 (PCIe/NVMe connector) | 8. DST_PA3 (PCIe/NVMe connector) |

Removing the drive backplane

Prerequisites

CAUTION: To prevent damage to the drives and backplane, remove the drives from the system before removing the backplane.

CAUTION: Note the number of each drive and temporarily label them before you remove the drive so that you can reinstall them in the same location.

NOTE: The procedure to remove the backplane is similar for all backplane configurations.

1. Follow the safety guidelines listed in the [Safety instructions](#).
2. Follow the procedure listed in the [Before working inside your system](#).
3. If installed, [remove the air shroud](#).
4. [Remove the drive backplane cover](#).
5. [Remove all the drives](#).

Steps

1. Loosen the captive screw on the cable guiding latch and lift the latch to remove the cables.
2. Disconnect the drive backplane cable from the connector on the system board.
3. Press the blue release tabs to disengage the drive backplane from the hooks on the system.
4. Lift and pull the drive backplane out of the system.

i **NOTE:** To avoid damaging the backplane, ensure that you move the control panel cables from the cable routing clips before removing the backplane.

i **NOTE:** The numbers on the image do not depict the exact steps. The numbers are for representation of sequence.



Figure 42. Removing the drive backplane

Next steps

1. [Replace the drive backplane.](#)

Installing the drive backplane

Prerequisites

1. Follow the safety guidelines listed in the [Safety instructions](#).
2. Follow the procedure listed in the [Before working inside your system](#).
3. [Remove the drive backplane cover.](#)
4. [Remove the air shroud.](#)
5. [Remove all the drives.](#)

NOTE: To avoid damaging the backplane, ensure to move the control panel cables from the cable routing clips before removing the backplane.

NOTE: Route the cable properly when you replace it to prevent the cable from being pinched or crimped.

Steps

1. Use the guides on the system as guides to align the slots on the backplane.
2. Insert the backplane into the guides and lower the backplane until the blue release tabs clicks into place.

NOTE: The numbers on the image do not depict the exact steps. The numbers are for representation of sequence.

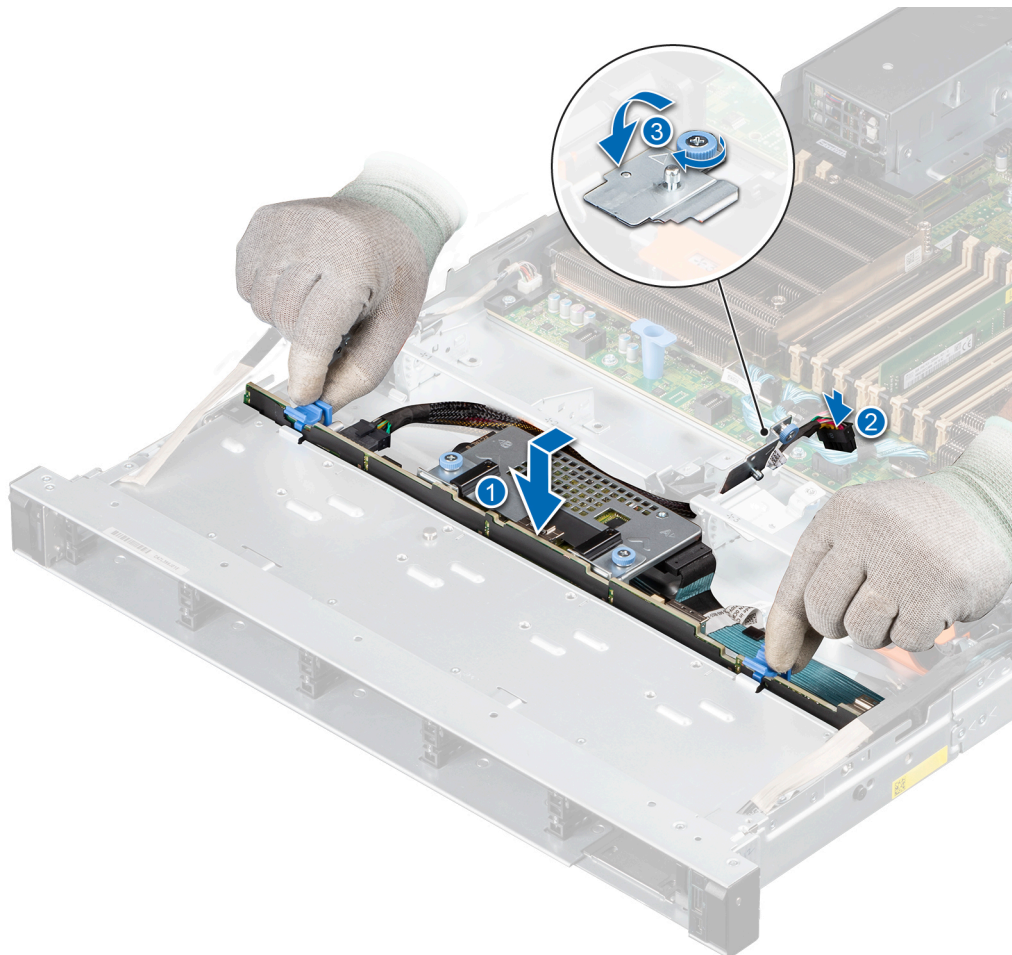

Figure 43. Installing the drive backplane

3. Route the cables properly through the cable guide and connect the cables to the connector on the system board. Tighten the captive screw on the cable guiding latch.

Next steps

1. [Install all the drives.](#)
2. If removed, [install the air shroud.](#)
3. [Install the drive backplane cover.](#)
4. Follow the procedure listed in [After working inside your system.](#)

Cable routing

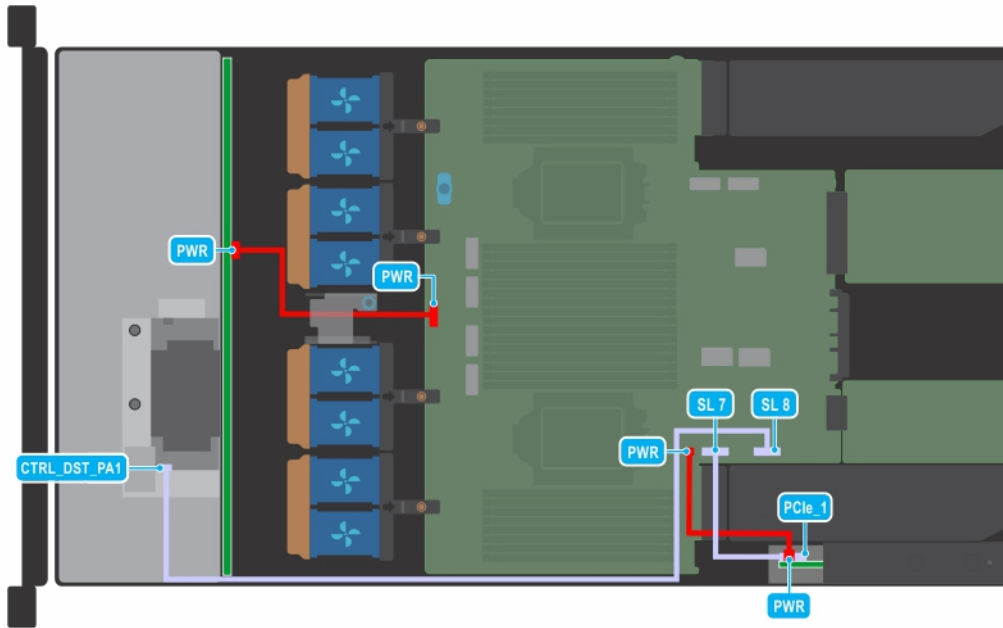

Figure 44. 4 x 3.5-inch SAS with one processor and front PERC module

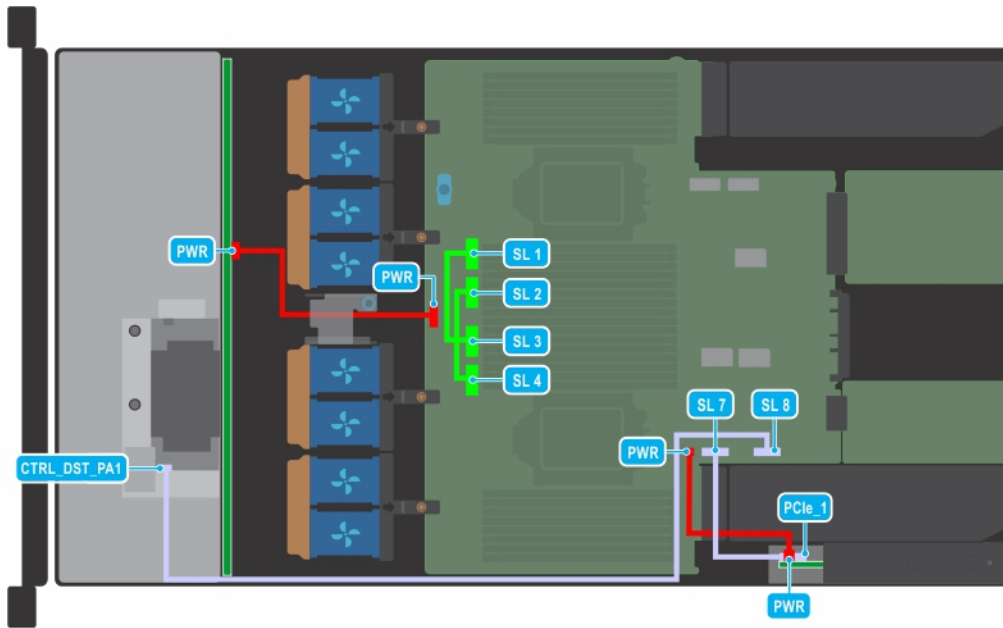

Figure 45. 4 x 3.5-inch SAS with dual processor and front PERC module

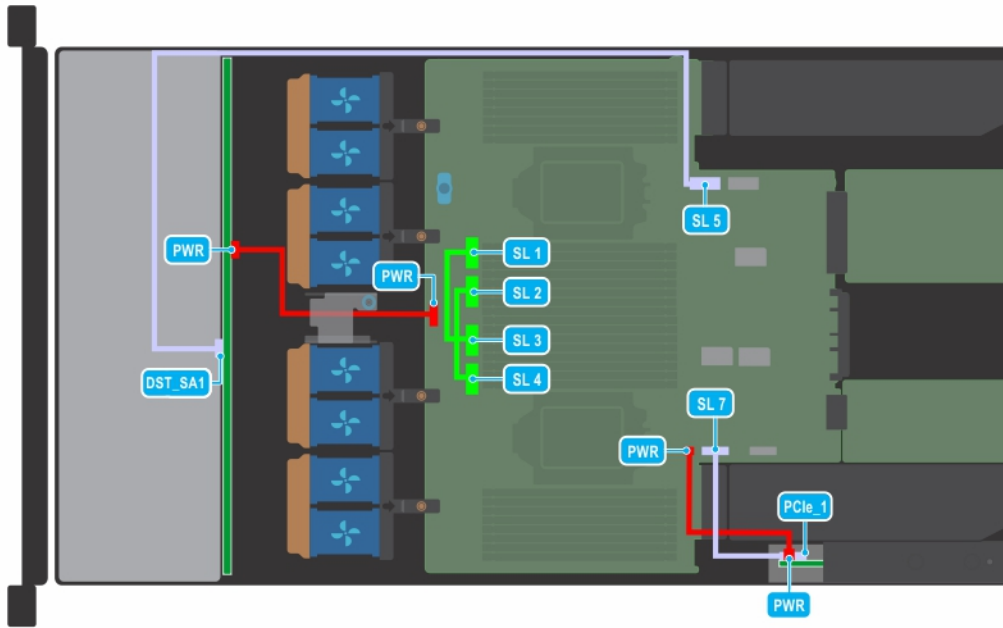

Figure 46. 4 x 3.5-inch SATA with no PERC module

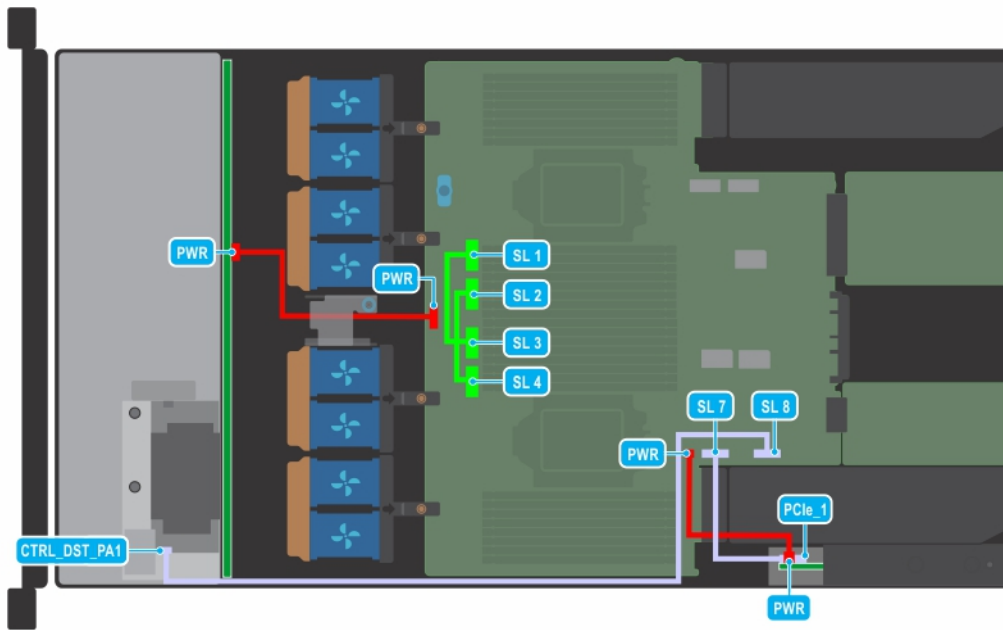

Figure 47. 8 x 2.5-inch SAS with front PERC module

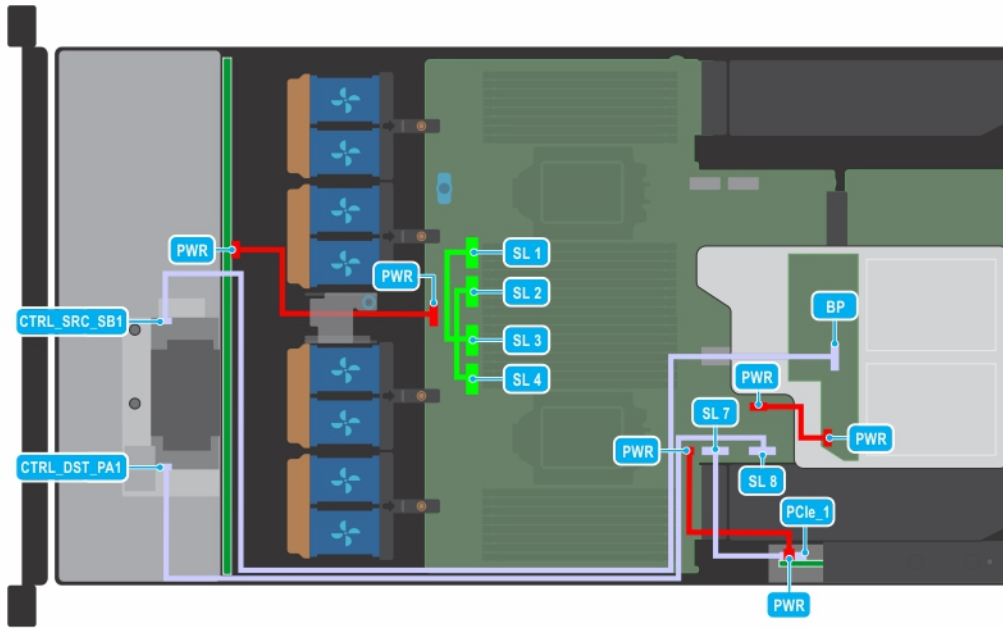

Figure 48. 4 x 3.5-inch SAS with 2 x 2.5-inch SAS rear drives

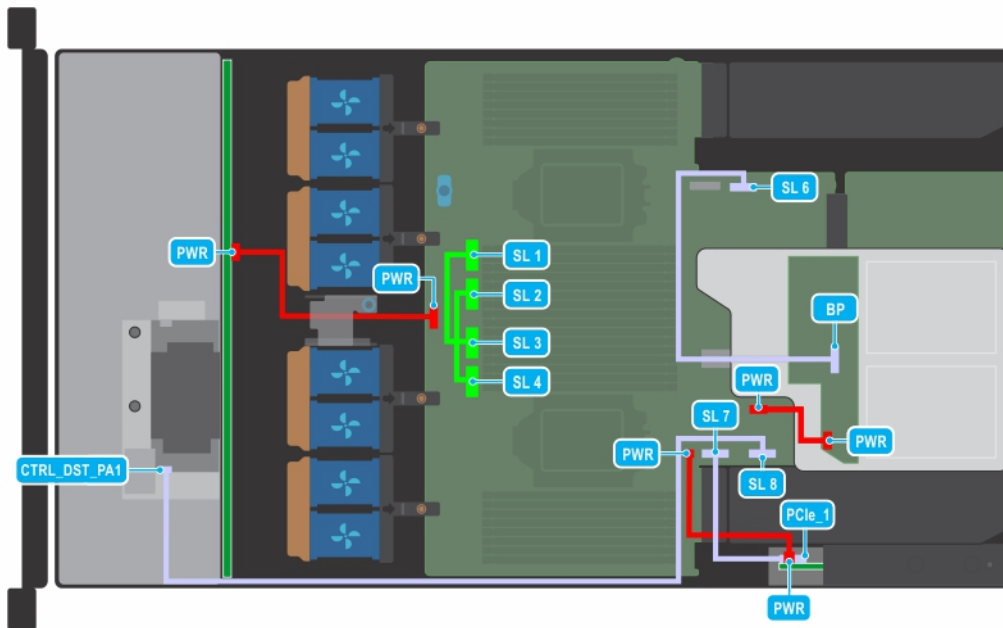

Figure 49. 4 x 3.5-inch SAS with 2 x 2.5-inch rear NVMe

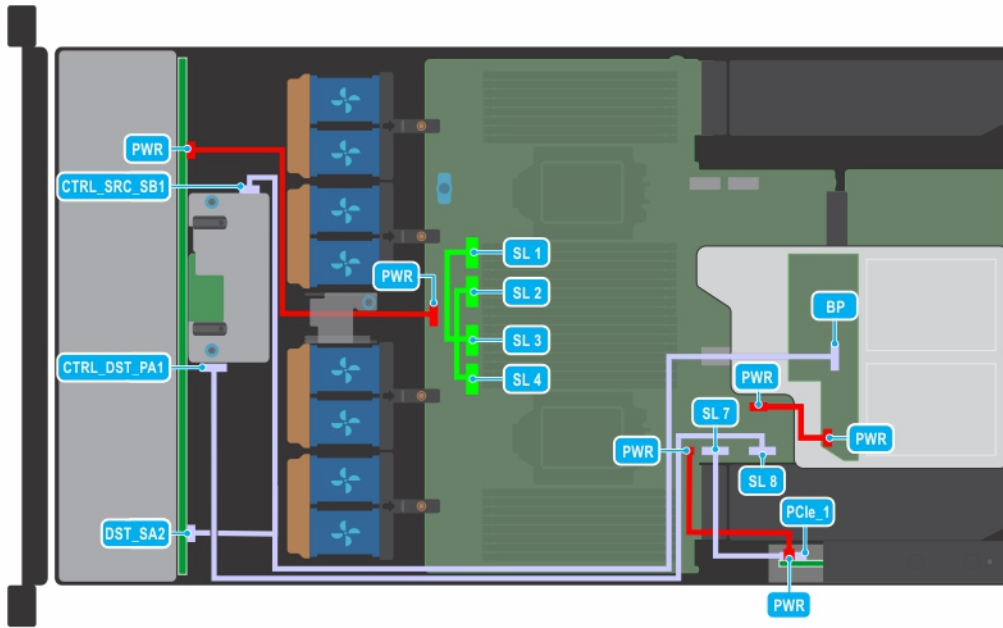

Figure 50. 10 x 2.5-inch SAS with 2 x 2.5-inch SAS rear drives

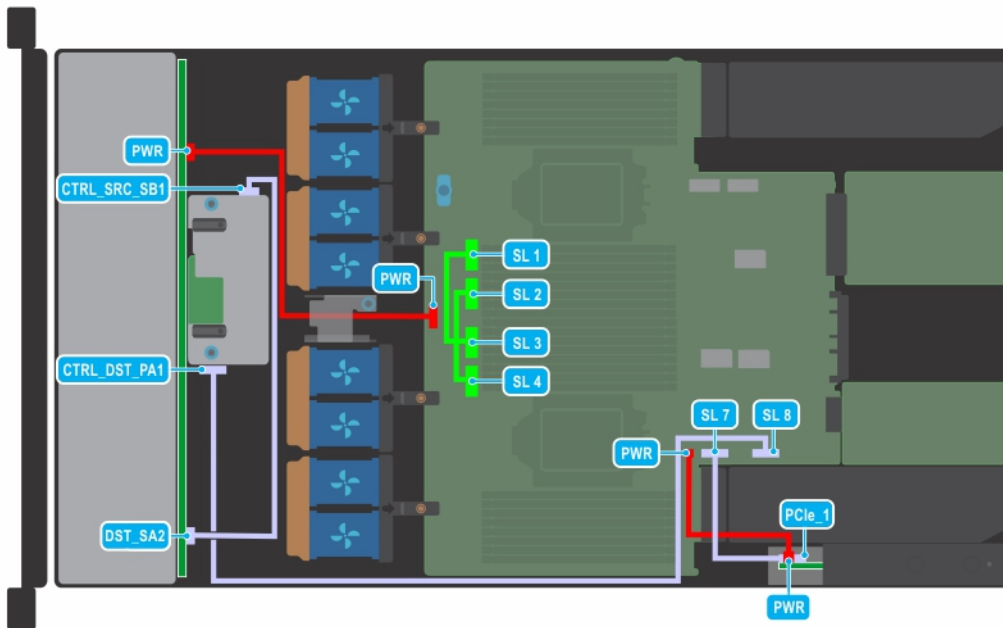

Figure 51. 10 x 2.5-inch SAS XGMI

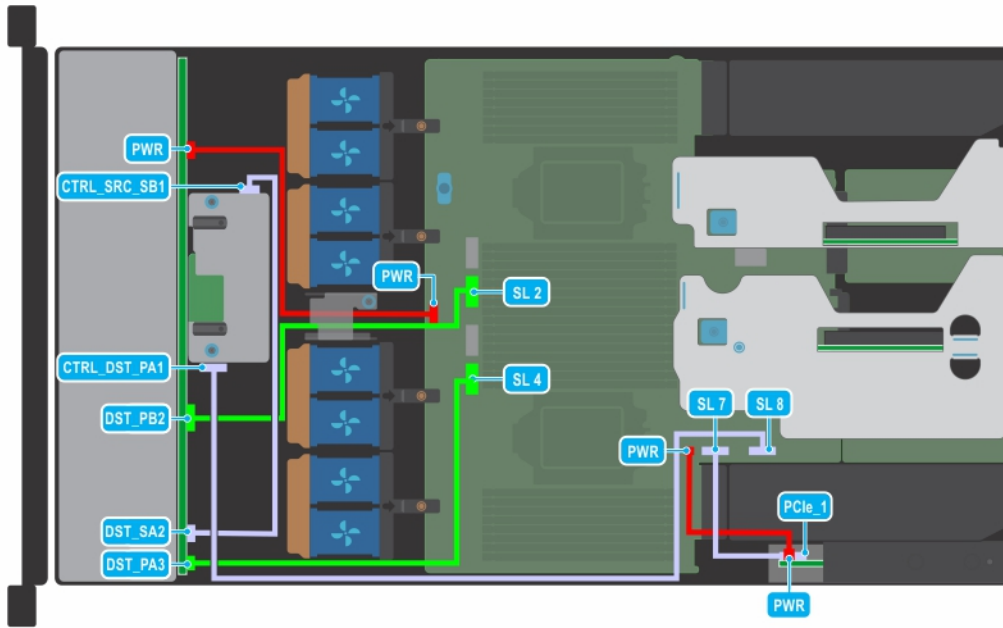

Figure 52. 10 x 2.5-inch Universal backplane

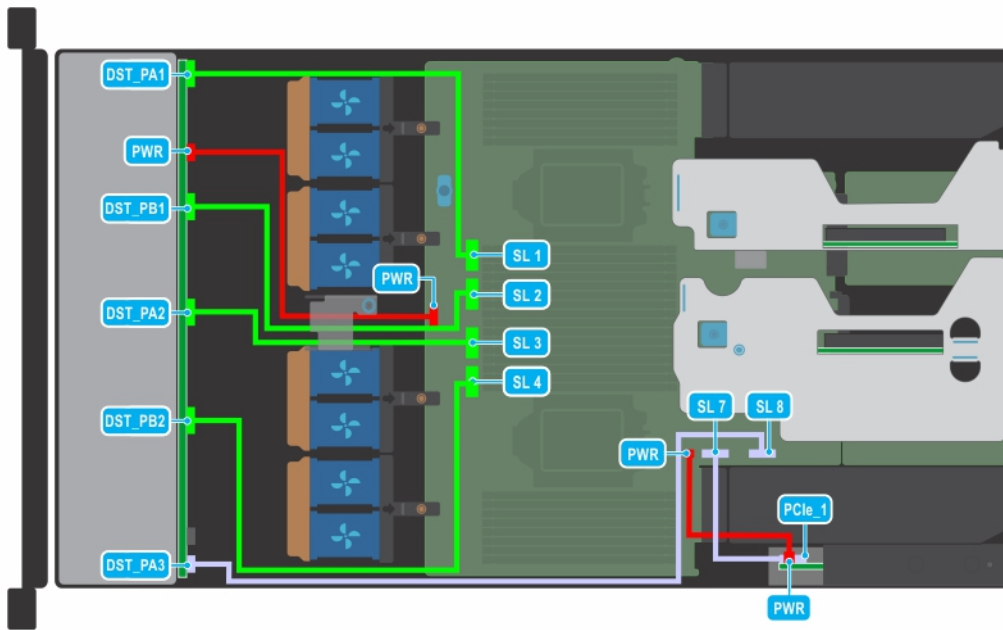

Figure 53. 10 x 2.5-inch NVMe backplane (48 mode)

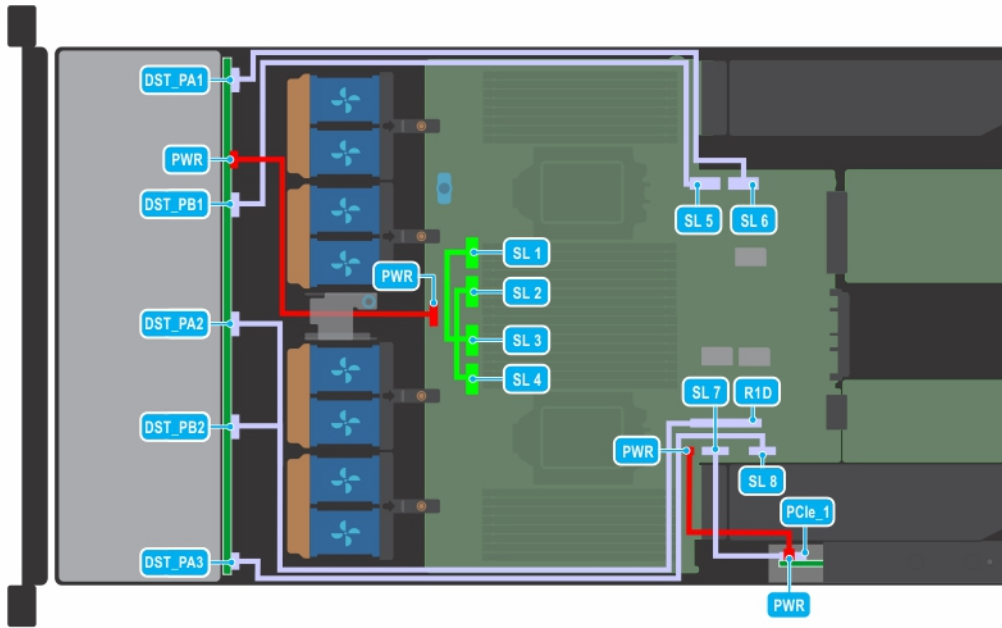

Figure 54. 10 X 2.5-inch NVMe (64 mode)

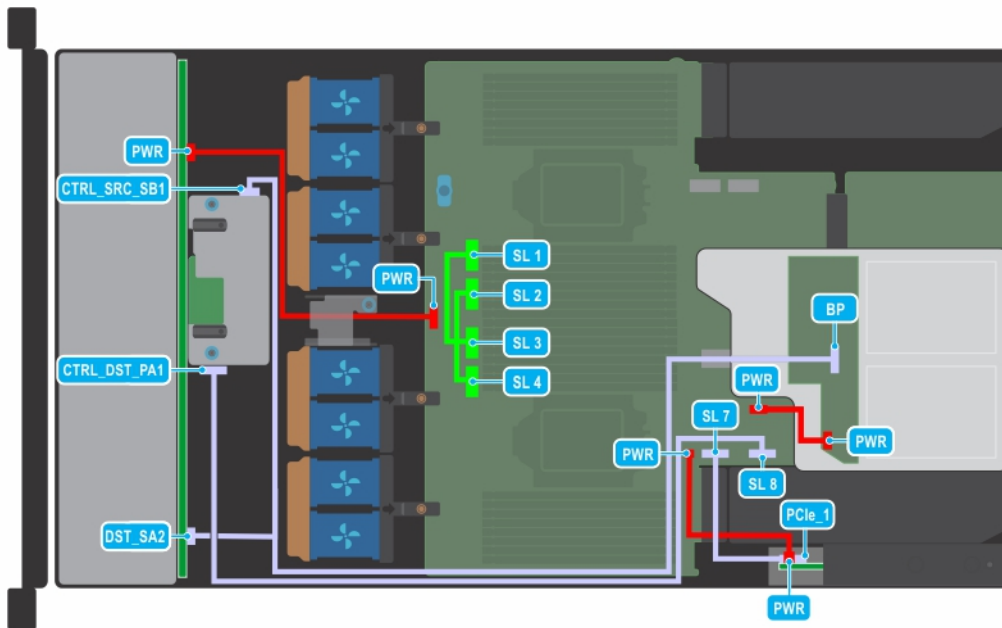

Figure 55. 10 X 2.5-inch SAS with 2 x 2.5-inch SAS rear drive

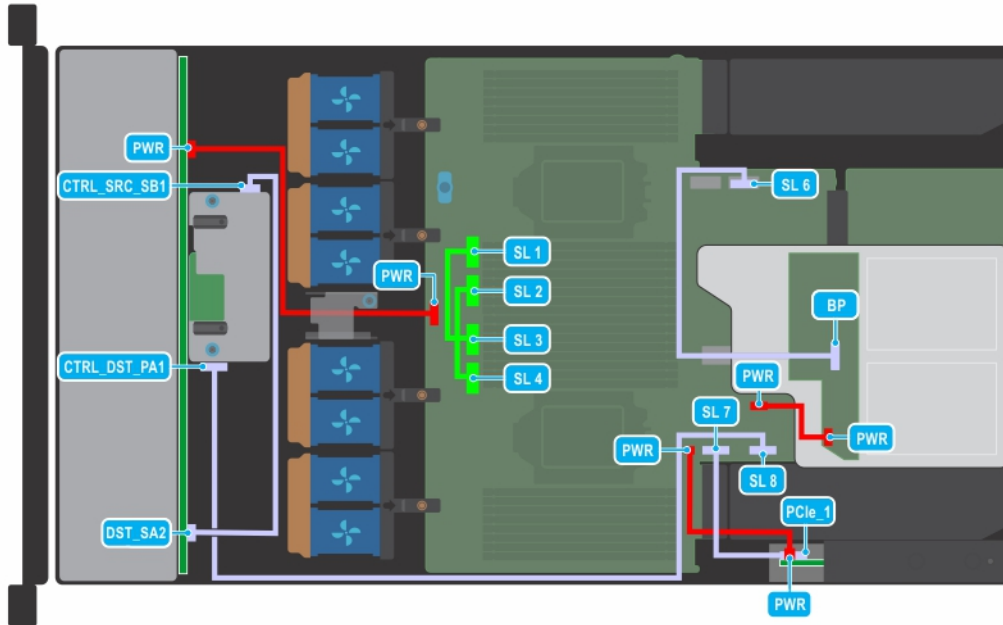

Figure 56. 10 x 2.5-inch SAS with 2 x 2.5-inch NVMe drive

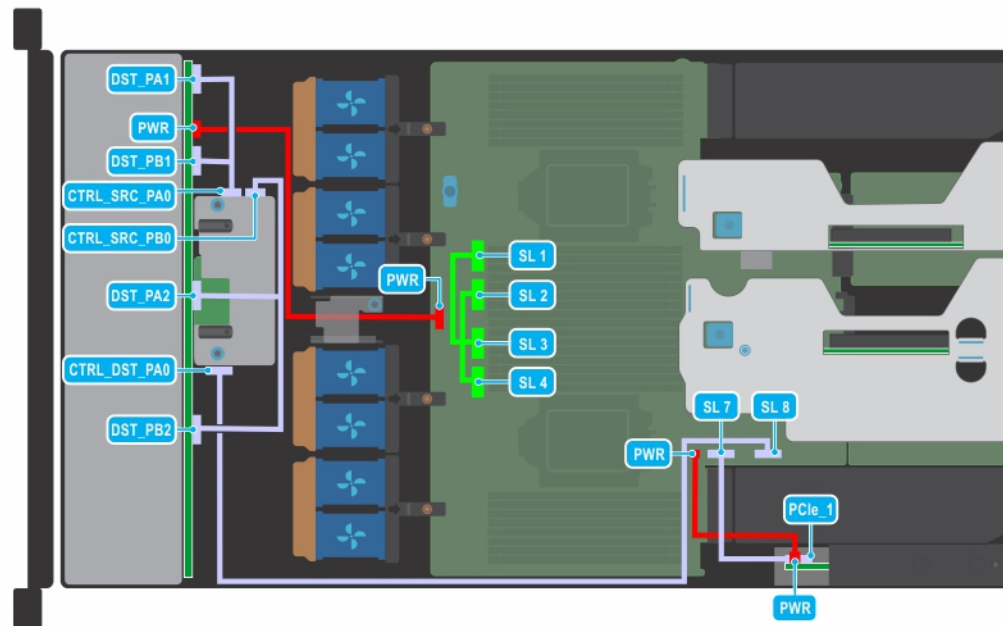

Figure 57. 8 x 2.5- inch NVMe RAID

Rear drive module

Removing the rear drive module

Prerequisites

1. Follow the safety guidelines listed in [Safety instructions](#).
2. Follow the procedure listed in [Before working inside your system](#).

3. Remove the air shroud.
4. Remove the rear drives.
5. Disconnect all the cables from the rear drive module.
6. If installed, remove the expansion card riser 3.

Steps

1. Using a Phillips #1 screwdriver, loosen the captive screws on the rear drive module or the liquid cooling rear drive module.
2. Slide the rear drive module and lift it away from the system.

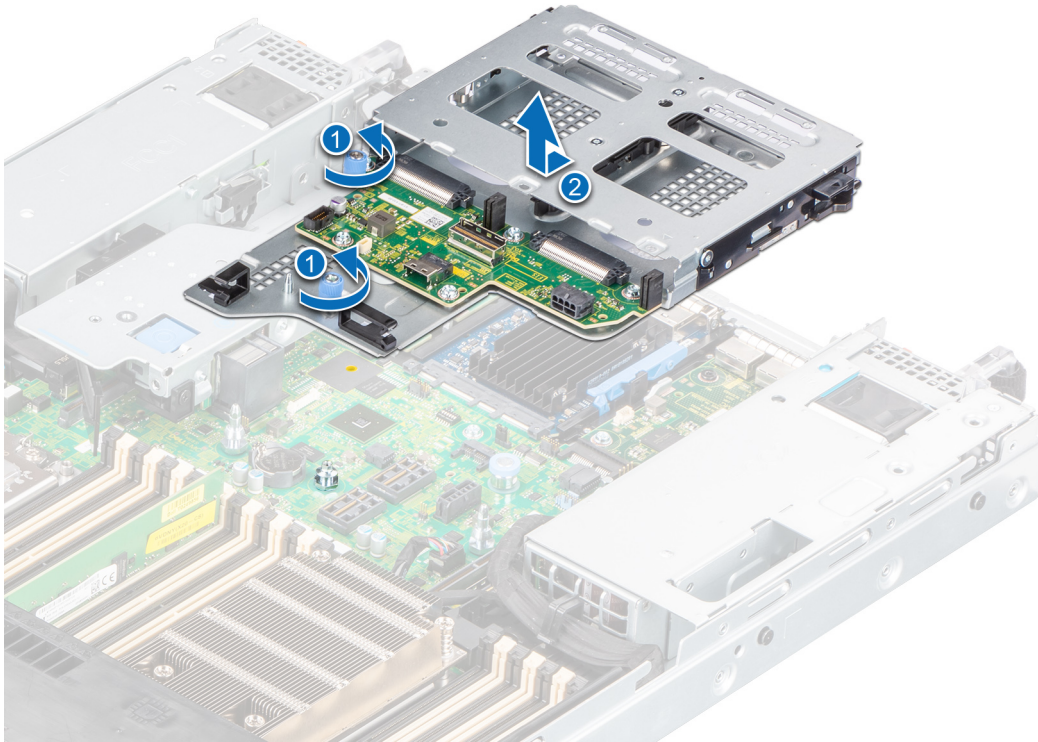

Figure 58. Removing the rear drive module

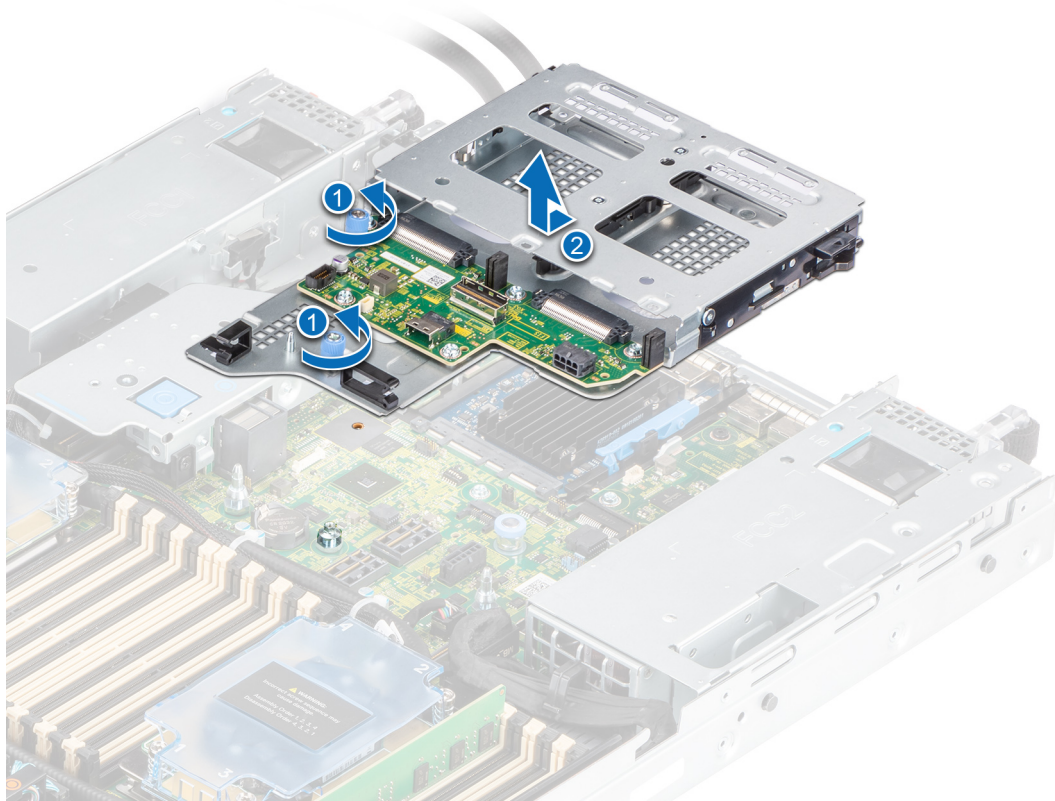

Figure 59. Removing the liquid cooling rear drive module

Next steps

1. [Replace the rear drive module.](#)

Installing the rear drive module

Prerequisites

1. Follow the safety guidelines listed in [Safety instructions](#).
2. Follow the procedure listed in [Before working inside your system](#).
3. [Remove the air shroud.](#)

Steps

1. Align the rear drive module with the guide on the system board.
2. Lower the rear drive module and slide till it clicks.
3. Using a Phillips #1 screwdriver, tighten the captive screws on the rear drive module.

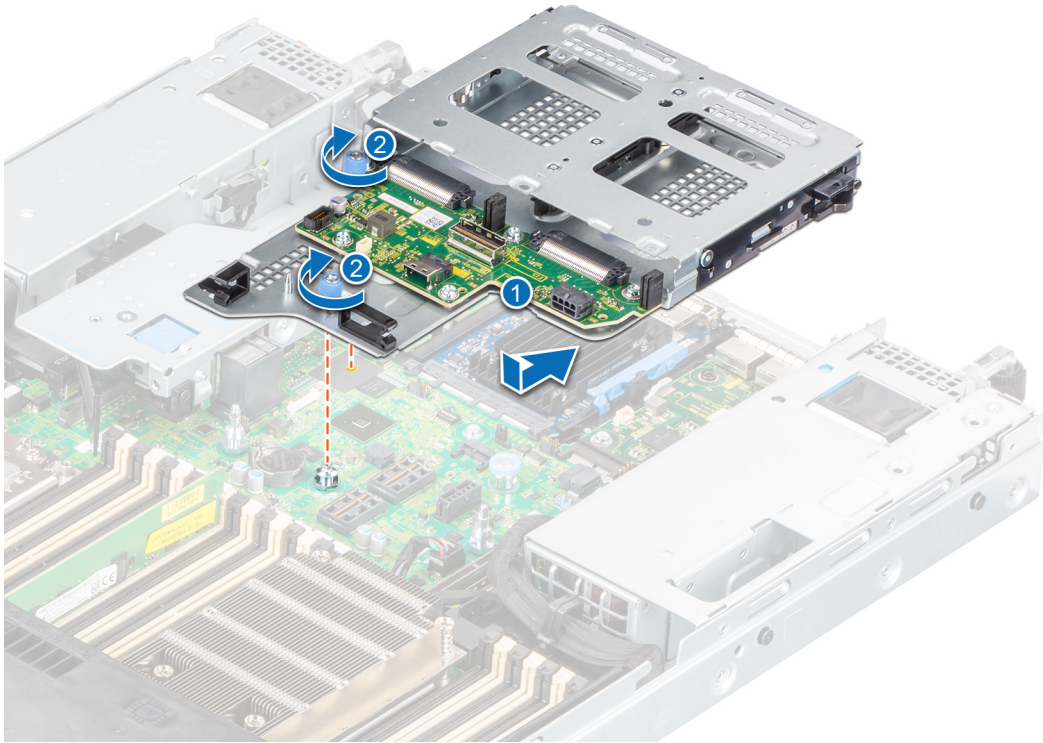

Figure 60. Installing the rear drive module

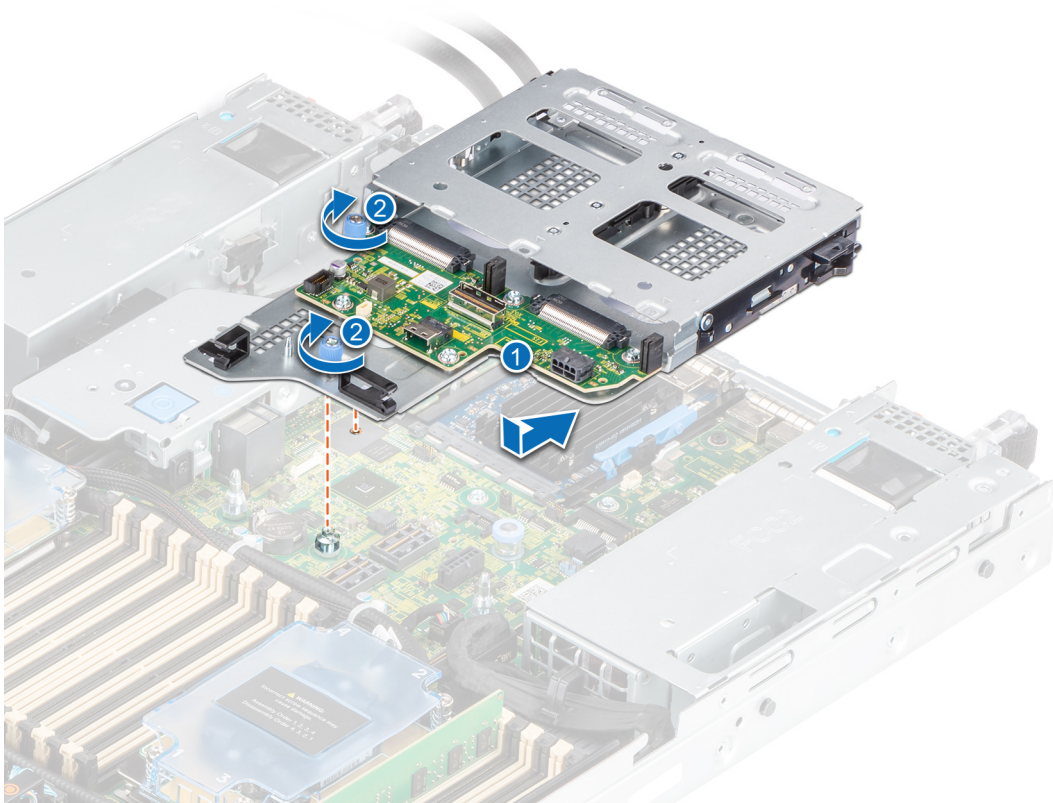

Figure 61. Installing the liquid cooling rear drive module

Next steps

1. If removed, [install the expansion card riser 3](#).
2. Connect all the cables to the rear drive module.
3. [Install the rear drives](#).
4. [Install the air shroud](#).
5. Follow the procedure listed in [After working inside your system](#).

Front PERC module

Removing the front mounting front PERC module

Prerequisites

1. Follow the safety guidelines listed in the [Safety instructions](#).
2. Follow the procedure listed in the [Before working inside your system](#).
3. [Remove the drive backplane cover](#).
4. If installed, [remove the air shroud](#).
5. Disconnect all the cables, observe the cable routing.

Steps

1. Using a Phillips #2 screwdriver, loosen the captive screws on the front PERC module.
2. Pull the front PERC module to disengage from the connector on the drive backplane.
3. Tilt and lift the front PERC module out of the system.

 **NOTE:** The numbers on the image do not depict the exact steps. The numbers are for representation of sequence.

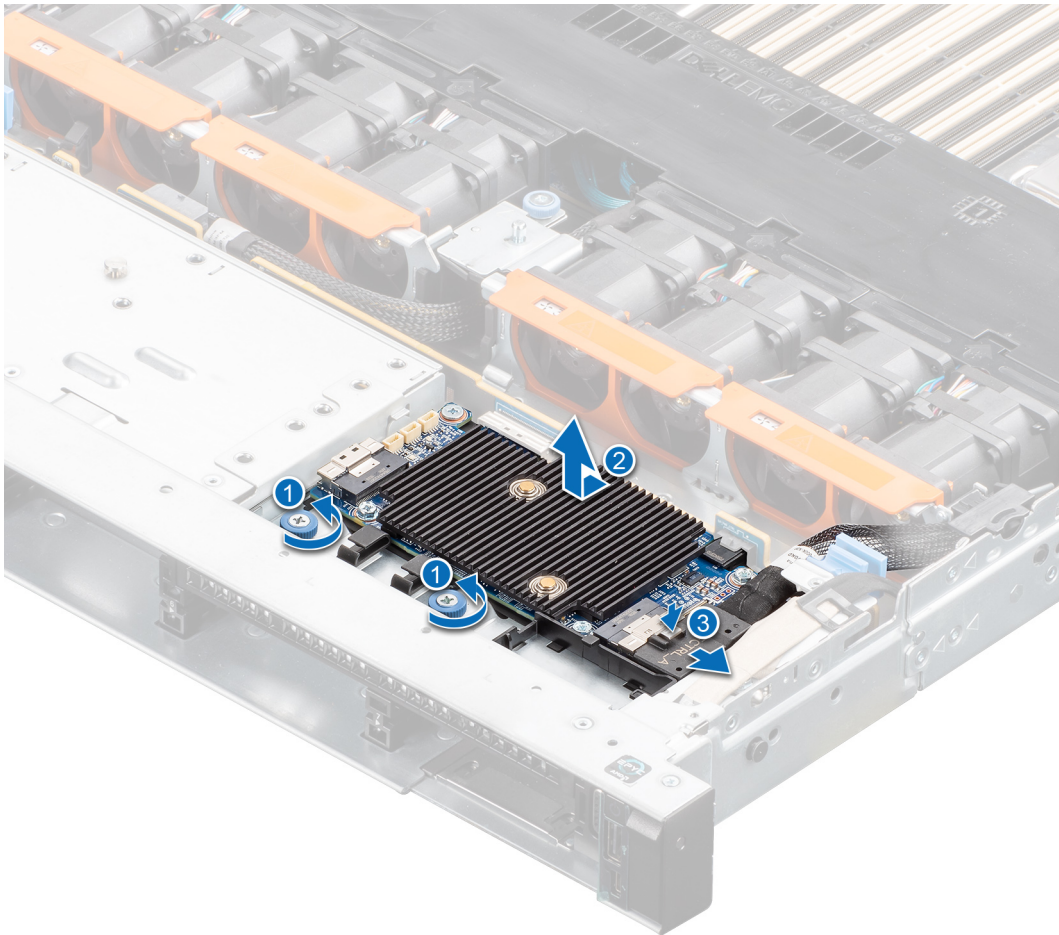

Figure 62. Removing the front mounting front PERC module

Next steps

1. [Replace the front mounting front PERC module.](#)

Installing the front mounting front PERC module

Prerequisites

1. Follow the safety guidelines listed in the [Safety instructions](#).
2. Follow the procedure listed in [Before working inside your system](#).
3. [Remove the drive backplane cover](#).
4. If installed, [remove the air shroud](#).
5. Route the cable properly to prevent the cable from being pinched or crimped.

Steps

1. Connect the PERC cable to the front PERC module.
2. Align the front PERC module at an angle until the tray touches the slot in the system.
3. Press the front PERC module connector with the connector on the drive backplane until firmly seated.
4. Using a Phillips #2 screwdriver, tighten the captive screws on the front PERC module.

NOTE: The numbers on the image do not depict the exact steps. The numbers are for representation of sequence.

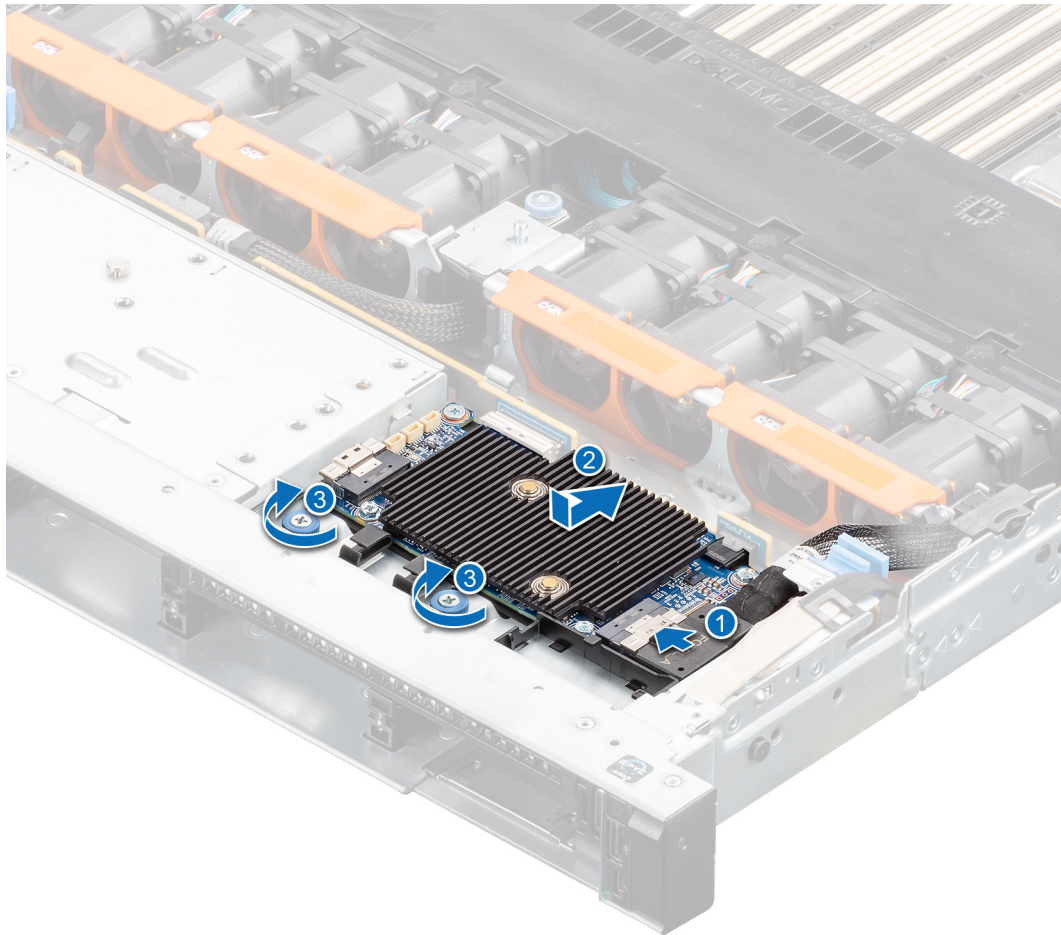

Figure 63. Installing the front mounting front PERC module

Next steps

1. Reconnect all the required cables.
2. If removed, [install the air shroud](#).
3. [Install the drive backplane cover](#).
4. Follow the procedure listed in [After working inside your system](#).

Removing the rear mounting front PERC module

Prerequisites

1. Follow the safety guidelines listed in the [Safety instructions](#).
2. Follow the procedure listed in the [Before working inside your system](#).
3. [Remove the drive backplane cover](#).
4. If installed, [remove the air shroud](#).
5. [Remove the drive backplane](#).
6. Disconnect all the cables, observe the cable routing.

Steps

1. Using a Phillips #2 screwdriver, loosen the captive screws on the front PERC module.
2. Slide the front PERC module to disengage from the connector on the drive backplane.

NOTE: The numbers on the image do not depict the exact steps. The numbers are for representation of sequence.

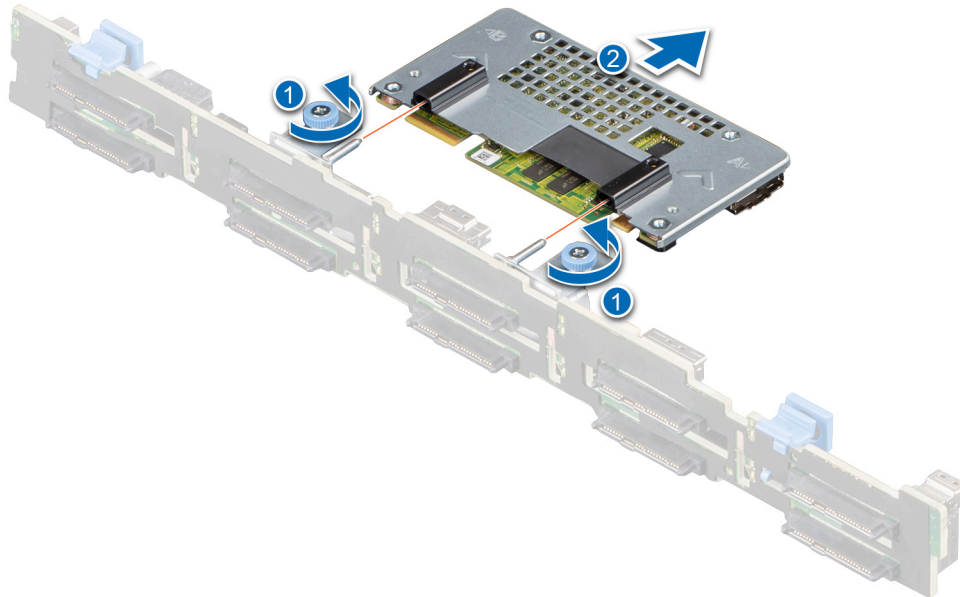

Figure 64. Removing the rear mounting front PERC module

Next steps

1. [Replace the rear mounting front PERC module.](#)

Installing the rear mounting front PERC module

Prerequisites

1. Follow the safety guidelines listed in the [Safety instructions](#).
2. Follow the procedure listed in [Before working inside your system](#).
3. [Remove the drive backplane cover](#).
4. If installed, [remove the air shroud](#).
5. [Remove the drive backplane](#).
6. Route the cable properly to prevent the cable from being pinched or crimped.

Steps

1. Align the connectors on the front PERC module with the connectors on the drive backplane.
2. Slide the front PERC module until the module is connected to the drive backplane.
3. Using a Phillips #2 screwdriver, tighten the captive screws on the front PERC module.

NOTE: The numbers on the image do not depict the exact steps. The numbers are for representation of sequence.

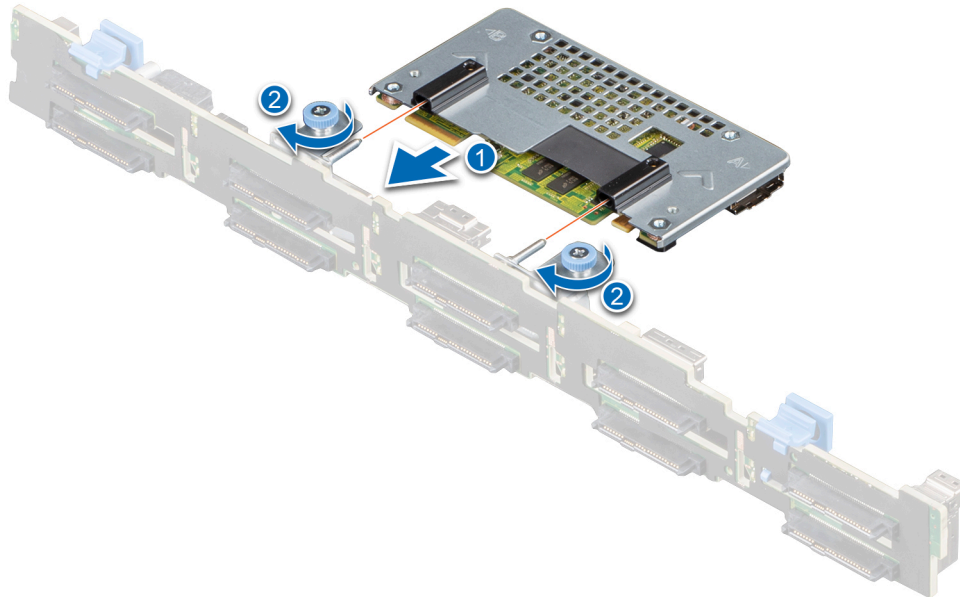

Figure 65. Installing the rear mounting front PERC module

Next steps

1. [Install the drive backplane.](#)
2. If removed, [install the air shroud.](#)
3. [Install the drive backplane cover.](#)
4. Follow the procedure listed in [After working inside your system.](#)

System memory

System memory guidelines

The PowerEdge R6525 system supports DDR4 registered DIMMs (RDIMMs) and Load Reduced DIMM (LRDIMMs). System memory holds the instructions that are started by the processor.

Your system memory is organized into eight channels per processor (two memory sockets per channel), 16 memory sockets per processor and 32 memory sockets per system.

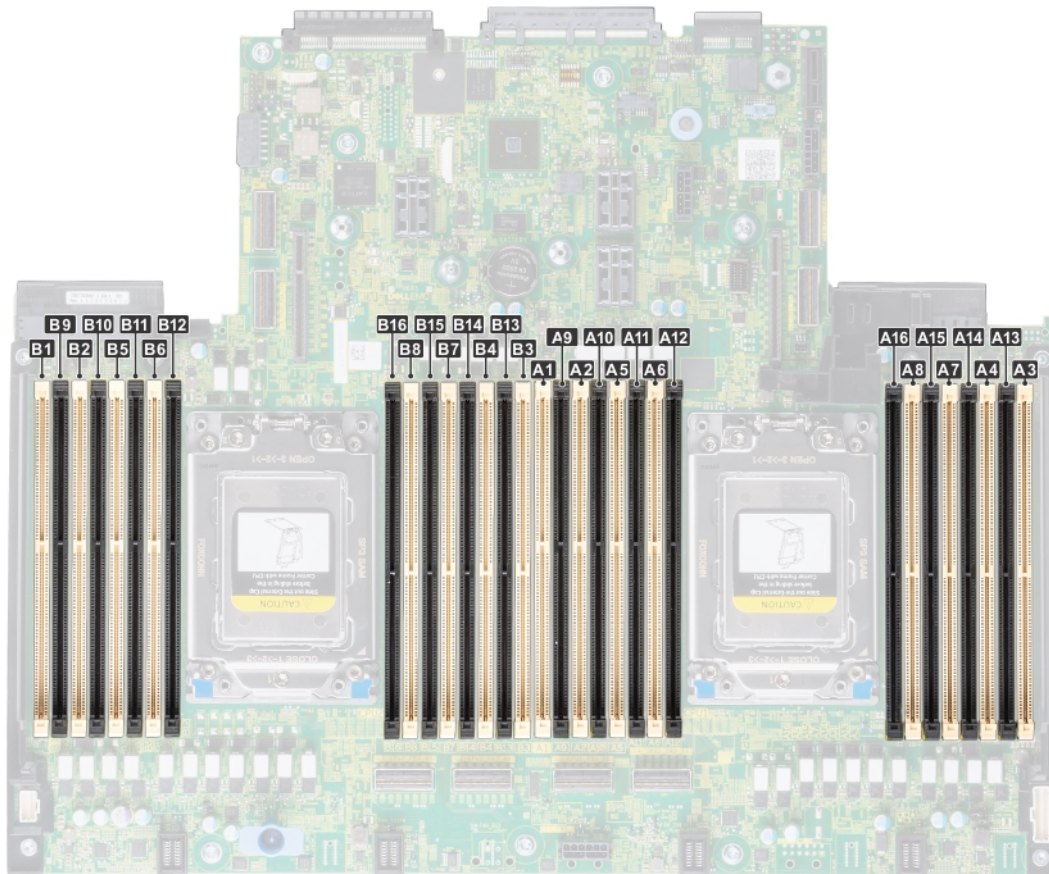

Figure 66. Memory channels

Memory channels are organized as follows:

Table 14. Memory channels

Processor	Channel A	Channel B	Channel C	Channel D	Channel E	Channel F	Channel G	Channel H
Processor 1	Slots A6 and A12	Slots A5 and A11	Slots A2 and A10	Slots A1 and A9	Slots A8 and A16	Slots A7 and A15	Slots A4 and A14	Slots A3 and A13
Processor 2	Slots B6 and B12	Slots B5 and B11	Slots B2 and B10	Slots B1 and B9	Slots B8 and B16	Slots B7 and B15	Slots B4 and B14	Slots B3 and B13

Table 15. Supported memory matrix

DIMM type	Rank	Capacity	DIMM rated voltage and speed	Operating Speed	
				1 DIMM per channel (DPC)	2 DIMMs per channel (DPC)
RDIMM	1 R	8 GB	DDR4 (1.2 V), 3200 MT/s	3200 MT/s	2933 MT/s
	2 R	16 GB, 32 GB, 64 GB	DDR4 (1.2 V), 3200 MT/s	3200 MT/s	2933 MT/s
LRDIMM	4 R	128 GB	DDR4 (1.2 V), 3200 MT/s	3200 MT/s	2933 MT/s
	8 R	128 GB	DDR4 (1.2 V), 2666 MT/s	2666 MT/s	2666 MT/s

Table 15. Supported memory matrix (continued)

DIMM type	Rank	Capacity	DIMM rated voltage and speed	Operating Speed	
				1 DIMM per channel (DPC)	2 DIMMs per channel (DPC)
	8 R	128 GB	DDR4 (1.2 V), 3200 MT/s	3200 MT/s	2933 MT/s

NOTE: The older 32 GB capacity RDIMM memory with x4 data width and 8Gb DRAM density cannot be mixed with the newer 32 GB capacity RDIMM memory with x8 data width and 16Gb DRAM density in the same AMD EPYC™ processor unit.

NOTE: The older 128 GB capacity LRDIMM memory at 2666 MT/s speed cannot be mixed with the new 128 GB capacity LRDIMM memory at 3200 MT/s speed.

General memory module installation guidelines

To ensure optimal performance of your system, observe the following general guidelines when configuring your system memory. If your system's memory configurations fail to observe these guidelines, your system might not boot, stop responding during memory configuration, or operate with reduced memory. This section provides information on the memory population rules and about the non-uniform memory access (NUMA) for single or dual processor system.

The memory bus may operate at speeds of 3200 MT/s, 2933 MT/s, or 2666 MT/s depending on the following factors:

- System profile selected (for example, Performance Optimized, or Custom [can be run at high speed or lower])
- Maximum supported DIMM speed of the processors
- Maximum supported speed of the DIMMs

NOTE: MT/s indicates DIMM speed in MegaTransfers per second.

The system supports Flexible Memory Configuration, enabling the system to be configured and run in any valid chipset architectural configuration. The following are the recommended guidelines for installing memory modules:

- All DIMMs must be DDR4.
- Mixing of memory module capacities in a system is not supported.
- If memory modules with different speeds are installed, they operate at the speed of the slowest installed memory module(s).
- Populate memory module sockets only if a processor is installed.
 - For single-processor systems, sockets A1 to A16 are available.
 - For dual-processor systems, sockets A1 to A16 and sockets B1 to B16 are available.
 - In Optimizer Mode, the DRAM controllers operate independently in the 64-bit mode and provide optimized memory performance.

Table 16. Memory population rules

Processor	Configuration	Memory population	Memory population information
Single processor	Optimizer (Independent channel) population order	A{1}, A{2}, A{3}, A{4}, A{5}, A{6}, A{7}, A{8}, A{9}, A{10}, A{11}, A{12}, A{13}, A{14}, A{15}, A{16}	Odd amount of DIMMs per processor allowed.
Dual processor (Start with processor1. Processor 1 and processor 2 population should match)	Optimizer (Independent channel) population order	A{1}, B{1}, A{2}, B{2}, A{3}, B{3}, A{4}, B{4}, A{5}, B{5}, A{6}, B{6}, A{7}, B{7}, A{8}, B{8}	Odd amount of DIMMs per processor is allowed. DIMMs must be populated identically per processor.

- Populate all the sockets with white release tabs first, followed by the black release tabs.
- In a dual-processor configuration, the memory configuration for each processor must be identical. For example, if you populate socket A1 for processor 1, then populate socket B1 for processor 2, and so on.
- Unbalanced or odd memory configuration results in a performance loss and system may not identify the memory modules being installed, so always populate memory channels identically with equal DIMMs for best performance.

- Minimum recommended configuration is to populate four equal memory modules per processor. AMD recommends limiting processors in that system to 32 cores or less.
 - Populate eight equal memory modules per processor (one DIMM per channel) at a time to maximize performance.
- NOTE:** Equal memory modules refer to DIMMs with identical electrical specification and capacity that may be from different vendors.

Memory interleaving with Non-uniform memory access (NUMA)

Non-uniform memory access (NUMA) is a memory design used in multi-processing, where the memory access time depends on the memory location relative to the processor. In NUMA, a processor can access its own local memory faster than the non-local memory.

NUMA nodes per socket (NPS) is a new feature added that allows you to configure the memory NUMA domains per socket. The configuration can consist of one whole domain (NPS1), two domains (NPS2), or four domains (NPS4). In the case of a two-socket platform, an additional NPS profile is available to have whole system memory to be mapped as single NUMA domain (NPS0). For more information on the memory interleaving for NPSx, see the Memory interleaving population rules section in this topic.

BIOS implementation for NPSx

- The BIOS Setup menu presents the applicable NPSx options based on the underlying model number. A change to the current NPSx is communicated to pre-BIOS firmware to take effect on the next boot. The default NPS setting is 1.
- During boot, if the selected NPSx option is not allowed for the model number (for example, if the processor model number changes between reboot), system will halt at the end of POST with UEFI0388 message displayed. On the next reboot, the system will fall back to NPS1 default setting.
- During boot, if the preferred interleaving for the current NPSx is not possible due to memory configuration (for example, the memory population is inconsistent with the preferred interleaving), BIOS shows a warning message UEFI0391.

NOTE: System is functional when UEFI0391 message is displayed. However, the system may not be configured for optimal performance.

NPS system optimization

Optimal system configuration is dependent on the processor model, memory configuration, and NPS settings. Match the memory configuration with the NPS settings available for the processor.

Table 17. Supported NPS modes by Processors

Model Number	NPS modes supported
75F3	4, 2, 1, 0
7713P	4, 2, 1
7663	4, 2, 1, 0
7513	4, 2, 1, 0
7543P	4, 2, 1
74F3	4, 2, 1, 0
7443	4, 2, 1, 0
7443P	4, 2, 1
7313P	4, 2, 1
7643	4, 2, 1, 0
72F3	4, 2, 1, 0
7742	4, 2, 1, 0
7702	4, 2, 1, 0
7662	4, 2, 1, 0
7642	4, 2, 1, 0
7552	2, 1, 0
7542	4, 2, 1, 0
7532	4, 2, 1, 0

Table 17. Supported NPS modes by Processors (continued)

Model Number	NPS modes supported
7502	4, 2, 1, 0
7452	4, 2, 1, 0
7402	4, 2, 1, 0
7352	4, 2, 1, 0
7302	4, 2, 1, 0
7282	1, 0
7272	1, 0
7262	4, 2, 1, 0
7252	1, 0
7F72	2, 1, 0
7F52	4, 2, 1, 0
7F32	4, 2, 1, 0
7H12	4, 2, 1, 0
7713	4, 2, 1, 0
7543	4, 2, 1, 0
7763	4, 2, 1, 0

Table 18. Optimal NPS configuration

Number of DIMMs per processor	NPS			
	0	1	2	4
1				X
2				X
3				X
4		X		
5				X
6				X
7				X
8	X	X		
9				X
10				X
11				X
12			X	
13				X
14				X
15				X
16	X	X		

- Recommended NPS setting is marked by X that indicate optimal performance.
- NPS0 is only available for dual processor systems and is the preferred setting.

- The NPS setting that are blank are functional. However, indicate non-optimal performance.
- BIOS default NPS setting is 1.
- UEFI0391 message may be displayed during boot if DIMMs are configured in the blank spaces of the table.
- If the processor does not support the desired NPS setting for a given number of DIMMs, then use default setting (NPS1) and the UEFI0391 message is displayed.

Memory interleaving population rules

- NPS4: Two channel interleaving
 - This interleaves channel [A and B], [C and D], etc.
 - Each channel within the pair requires at least one equal memory modules populated.
 - Works with three memory modules per channel pair, non-symmetrical module is stacked on top (odd configurations).
 - Any memory channel where one of the two channels is not populated is not interleaved.
 - There is no alternate, as all configurations can be mapped into this mode.
- NPS2: Four channel interleaving
 - This interleaves the four channels on the left or right half of a processor which are channels [A, B, C, D] and [E, F, G, H].
 - All four channels require equal memory modules populated.
 - Each half or interleave set may have different total memory capacity with respect to each other.
- NPS1: Eight channel interleaving
 - This interleaves all channels in a processor [A, B, C, D, E, F, G, H].
 - All channels in a processor require equal memory modules populated.
 - Single processor system creates a single NUMA node for the system.
 -  **NOTE:** An exception is allowed when system has 4-channels populated [C, D, G, H] with equal memory allowing the system to enter NPS1 mode even though all the 8 channels are not populated.
- NPS0: Sixteen channel interleaving (dual processor)
 - This interleaves all 16 channels in a dual processor system.
 - All channels in a system require equal memory modules populated.
 - Dual processor systems create a single NUMA node for the system.

Removing a memory module

Prerequisites

1. Follow the safety guidelines listed in the [Safety instructions](#).
2. Follow the procedure listed in the [Before working inside your system](#).
3. If installed, [remove the air shroud](#).

 **WARNING:** The memory modules are hot to touch for some time after the system has been powered off. Allow the memory modules to cool before handling them. Handle the memory modules by the card edges and avoid touching the components or metallic contacts on the memory module.

Steps

1. Locate the appropriate memory module socket.
2. To release the memory module from the socket, simultaneously press the ejectors on both ends of the memory module socket.

 **CAUTION:** Handle each memory module only by the card edges, ensuring not to touch the middle of the memory module or metallic contacts.

3. Lift the memory module away from the system.

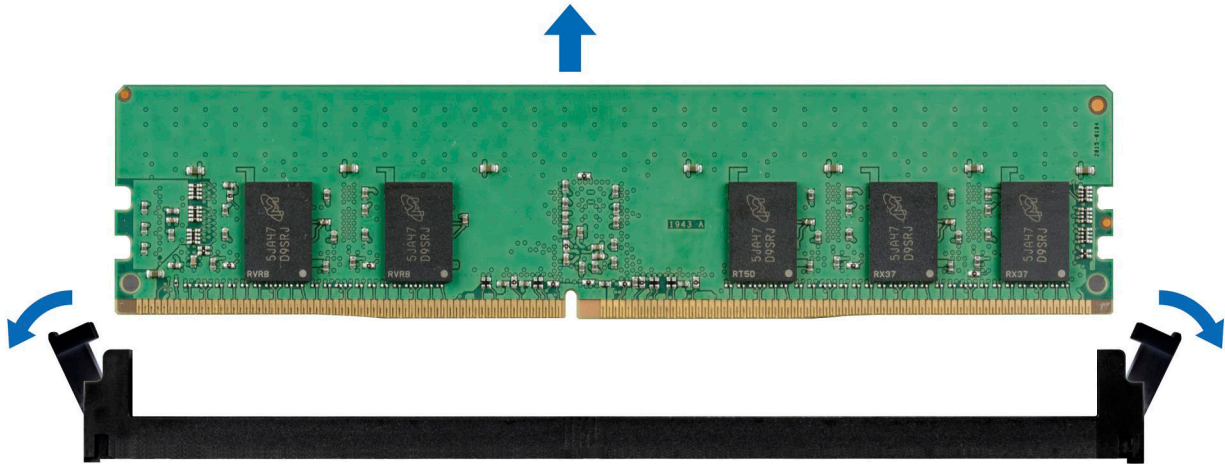

Figure 67. Removing a memory module

Next steps

1. [Replace the memory module.](#)

Installing a memory module

Prerequisites

1. Follow the safety guidelines listed in the [Safety instructions](#).
2. Follow the procedure listed in [Before working inside your system](#).
3. If installed, [remove the air shroud](#).

⚠ WARNING: The memory modules are hot to touch for some time after the system has been powered down. Allow the memory modules to cool before handling them. Handle the memory modules by the card edges and avoid touching the components or metallic contacts on the memory module.

Steps

1. Locate the appropriate memory module socket.

⚠ CAUTION: Handle each memory module only by the card edges, ensuring not to touch the middle of the memory module or metallic contacts.

2. If a memory module is installed in the socket, remove it.
3. Align the edge connector of the memory module with the alignment key of the memory module socket, and insert the memory module in the socket.

i NOTE: Ensure the memory socket ejectors are fully open.

i NOTE: The memory module socket has an alignment key that enables you to install the memory module in the socket in only one orientation.

⚠ CAUTION: Do not apply pressure at the center of the memory module; apply pressure at both ends of the memory module evenly.

⚠ CAUTION: To prevent damage to the memory module or the memory module socket during installation, do not bend or flex the memory module; insert both ends of the memory module simultaneously.

4. Press the memory module with your thumbs until the ejectors firmly click into place. When the memory module is properly seated in the socket, the levers on the memory module socket align with the levers on the other sockets that have memory modules installed.

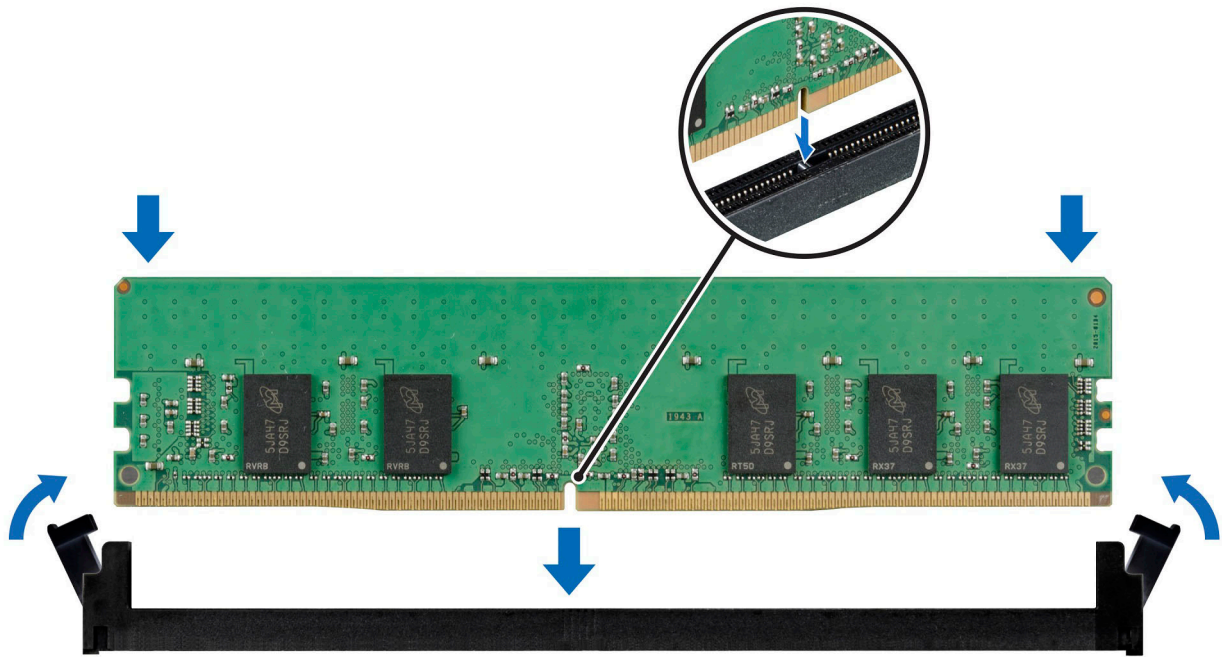

Figure 68. Installing a memory module

Next steps

1. If removed, [install the air shroud](#).
2. Follow the procedure listed in [After working inside your system](#).
3. To verify if the memory module has been installed properly, press F2 and navigate to **System Setup Main Menu > System BIOS > Memory Settings**. In the **Memory Settings** screen, the System Memory Size must reflect the updated capacity of the installed memory.
4. If the System Memory Size is incorrect, one or more of the memory modules may not be installed properly. Ensure that the memory modules are firmly seated in their sockets.
5. Run the system memory test in system diagnostics.

Processor and heat sink

Removing a heat sink

Prerequisites

1. Follow the safety guidelines listed in the [Safety instructions](#).
2. Follow the procedure listed in the [Before working inside your system](#).
3. If installed, [remove the air shroud](#).

⚠ WARNING: The heat sink and processor are too hot to touch for some time after the system has been powered off. Allow the heat sink and processor to cool down before handling them.

i NOTE: The procedure to uninstall standard and L-type heat sink is similar. The image shows L-type heat sink configuration system.

Steps

1. Using a Torx #T20 screwdriver, loosen the captive screws in the order that is mentioned on the heat sink:
 - a. Partially loosen the captive screws 1 and 2 (approximately 3 turns).
 - b. Partially loosen the captive screws 3 and 4 (approximately 3 turns).

- c. Loosen the captive screws 1 and 2 completely.
- d. Loosen the captive screws 3 and 4 completely.

i **NOTE:** The captive screw numbers are marked on the heat sink.

- 2. Lift the heat sink from the system.

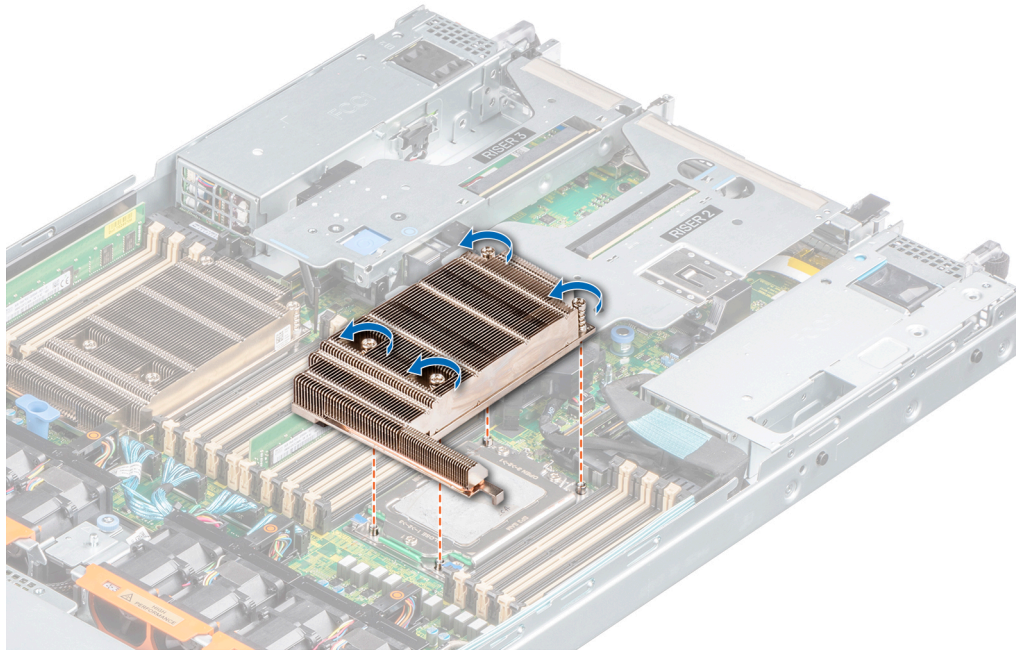

Figure 69. Removing a heat sink

Next steps

- 1. If you are uninstalling a faulty heat sink, [replace the heat sink](#), else [remove the processor](#).

Removing the liquid cooling heat sink modules

Prerequisites

- 1. Follow the safety guidelines listed in the [Safety instructions](#).
- 2. Follow the procedure listed in the [Before working inside your system](#).
- 3. Remove the [system cover](#).
- 4. Remove the [air shroud](#).

⚠ WARNING: The heat sink and processor are too hot to touch for some time after the system has been powered off. Allow the heat sink and processor to cool down before handling them.

Steps

- 1. Using a Phillips #1 screw driver, loosen the captive screw on the liquid cooling ring holder.
- 2. Lift up the liquid cooling ring holder to loosen the liquid cooling tubes.
- 3. Disconnect the liquid cooling detection cable from the RIO card connector.

i **NOTE:** The numbers on the image do not depict the exact steps. The numbers are for representation of sequence.

- 4. Unlatch the tube clip to loosen the liquid cooling tubes.
- 5. Remove the liquid cooling tubes end point from the rear exit of the I/O function panel.
- 6. Slightly lift up the liquid cooling tubes surrounding the DIMM slots.
- 7. Using a Torx #T20 screwdriver, loosen the captive screws in the order that is mentioned on the liquid cooling heat sink modules.

- a. Partially loosen the captive screws 1 and 2 (approximately 3 turns).
- b. Partially loosen the captive screws 3 and 4 (approximately 3 turns).
- c. Loosen the captive screws 1 and 2 completely.
- d. Loosen the captive screws 3 and 4 completely.

i **NOTE:** The captive screw numbers are marked on the liquid cooling heat sink modules.

8. Lift the liquid cooling heat sink modules from the system.

Figure 70. Removing the liquid cooling heat sink

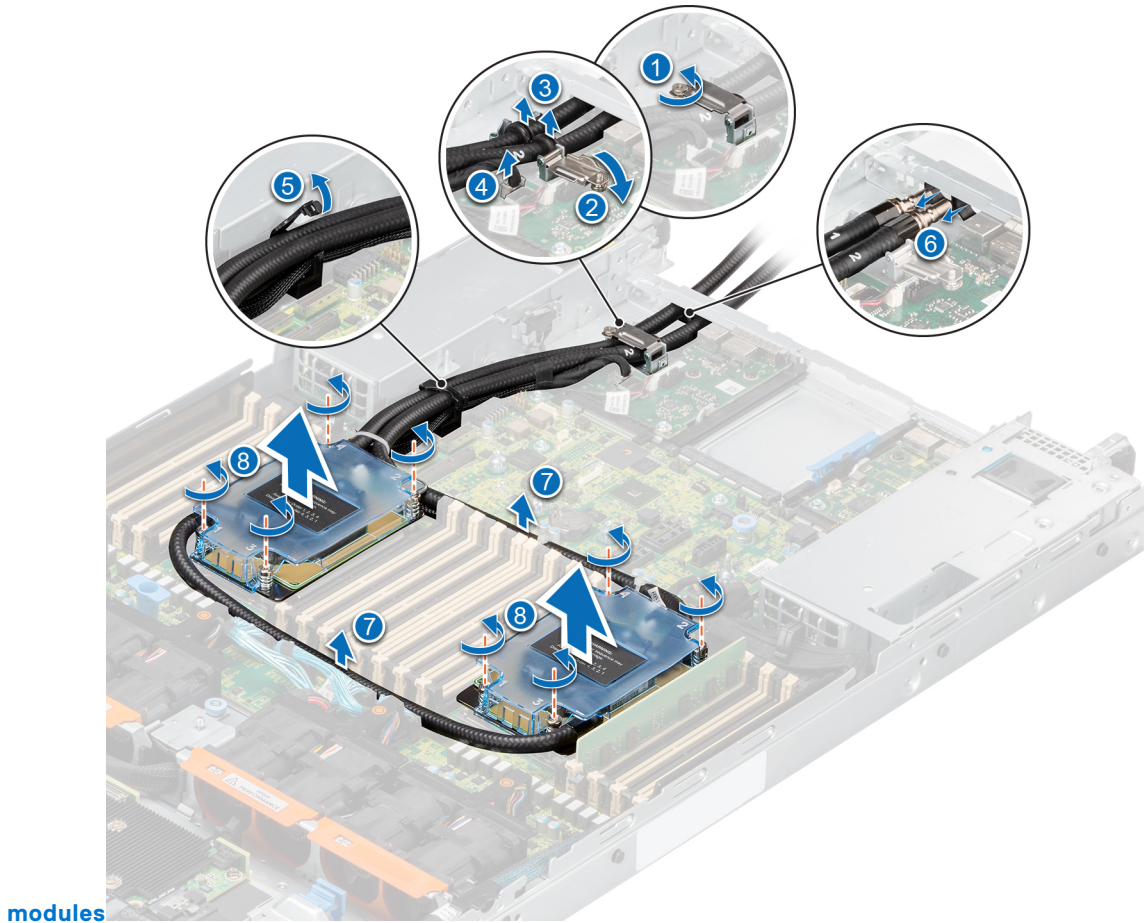

Next steps

1. If you are uninstalling a faulty liquid cooling heat sink module, [replace the liquid cooling heat sink modules](#), else [remove the processor](#).

Removing the processor

Prerequisites

⚠ WARNING: The heat sink may be hot to touch for some time after the system has been powered off. Allow the heat sink to cool before removing it.

1. Follow the safety guidelines listed in the [Safety instructions](#).
2. Follow the procedure listed in the [Before working inside your system](#).
3. [Remove the heat sink](#).

⚠ CAUTION: You may find the CMOS battery loss or CMOS checksum error is displayed during the first instance of powering on the system after the processor or system board replacement which is expected. To fix, go to set up option to configure the system settings.

Steps

1. Using a Torx #T20 screwdriver, loosen the screws to release the force plate. The sequence to loosen the screws is 3, 2, and 1.

NOTE: The screw numbers are marked on the force plate.

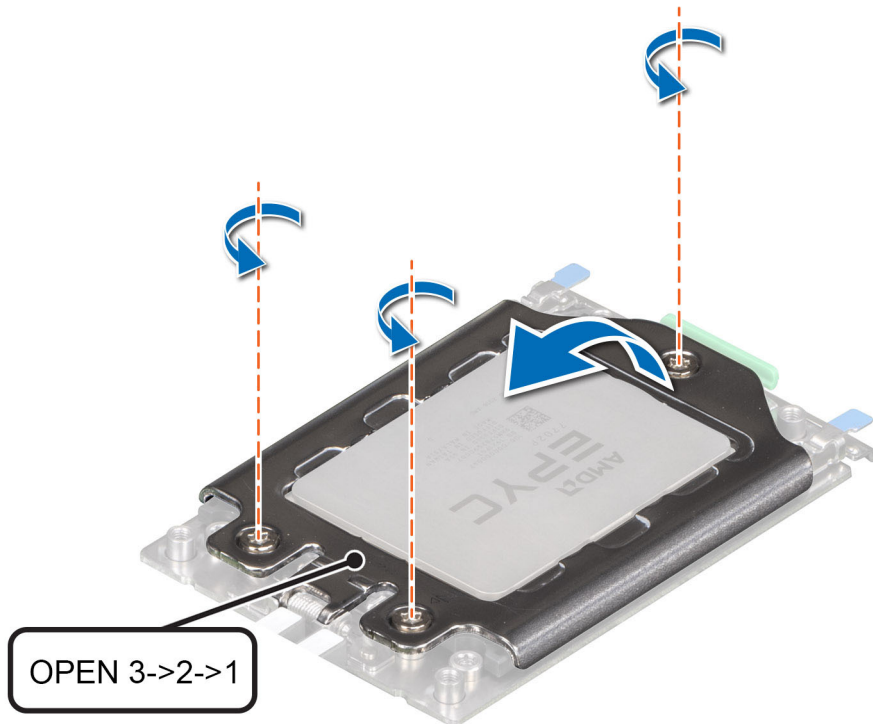

Figure 71. Removing screws on the force plate

2. Release the processor socket rail frame by lifting the blue latches.

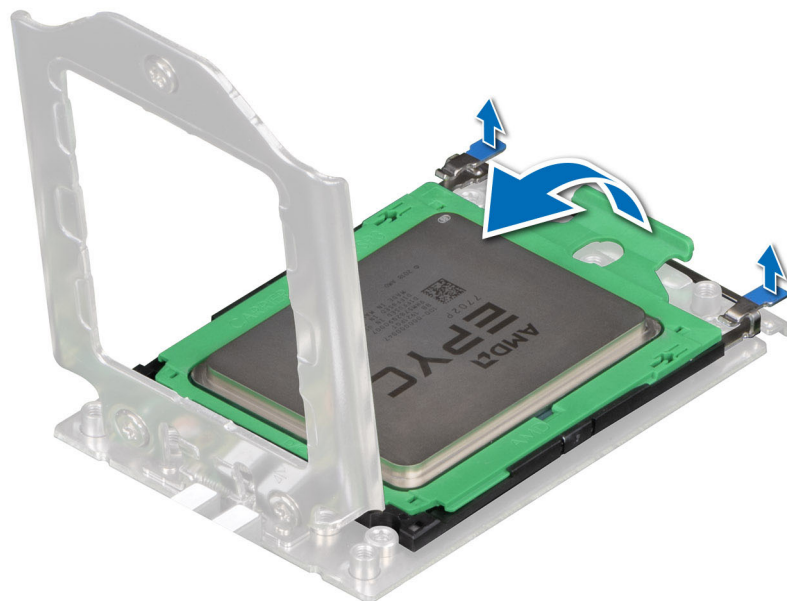

Figure 72. Lifting the rail frame

3. Holding the blue tab on the processor tray, slide the tray out of the rail frame.

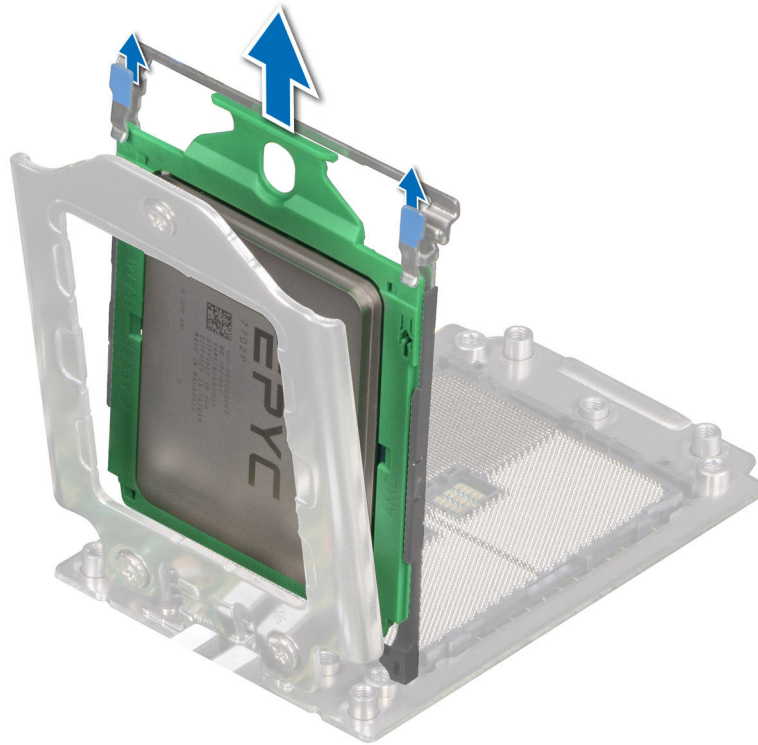

Figure 73. Removing the processor tray

Next steps

1. [Replace the processor.](#)

Installing the processor

Prerequisites

1. Follow the safety guidelines listed in the [Safety instructions](#).
2. Follow the procedure listed in [Before working inside your system](#).
3. [Remove the heat sink](#).

Steps

1. Holding the blue tab on the processor tray, slide the tray into the processor socket rail frame until firmly seated.

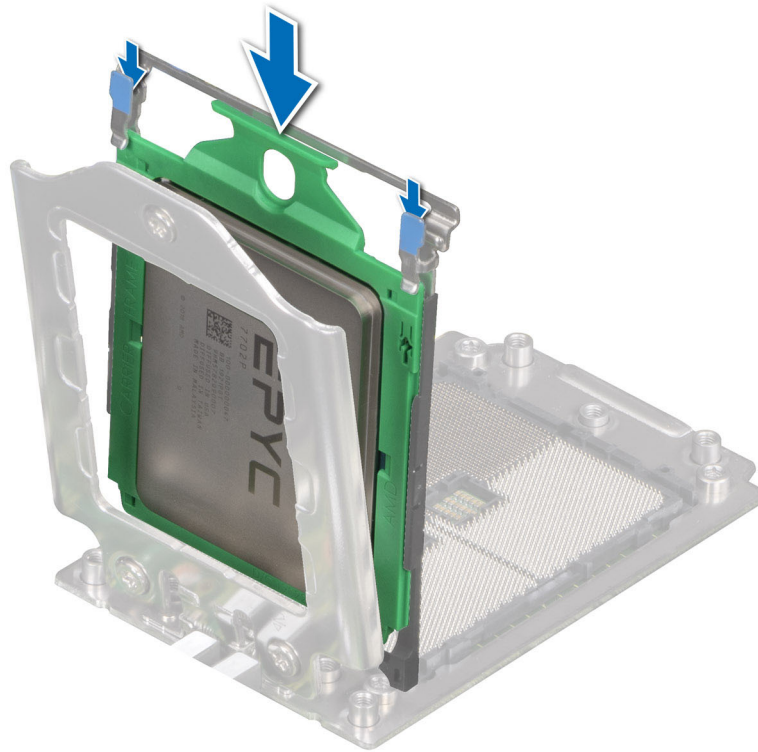

Figure 74. Placing the processor tray into the rail frame

2. Push the rail frame down until the blue latches lock into place.

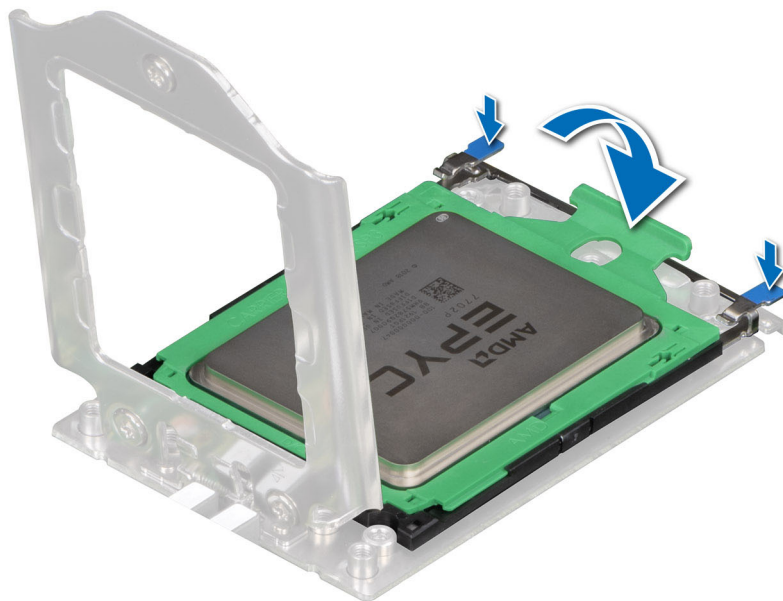

Figure 75. Closing the rail frame

3. Secure the force plate to the processor socket base by tightening the screws in the sequence 1, 2, and 3. When all three screws are fully threaded, the socket is then actuated. The three screws are tightened to a torque value of 12.0 ± 1.2 lbf-in.

i **NOTE:** The screw numbers are marked on the force plate.

i **NOTE:** Press the force plate while tightening the screws to avoid tilting of the processor cover out of the processor socket.

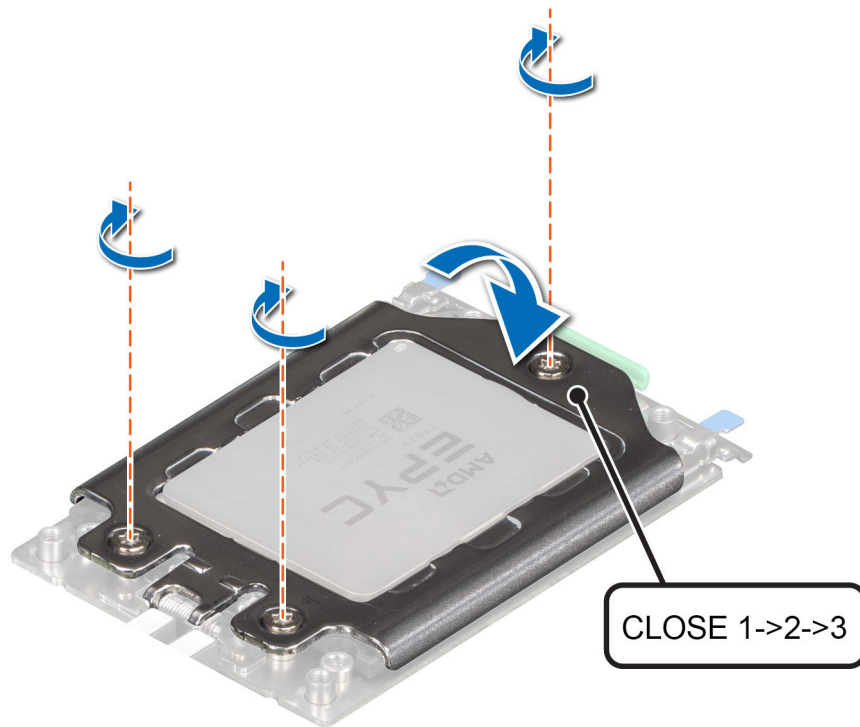

Figure 76. Securing the force plate

Next steps

1. [Install the heat sink.](#)
2. Follow the procedure listed in [After working inside your system.](#)

Installing the heat sink

Prerequisites

Never uninstall the heat sink from a processor unless you intend to replace the processor or system board. The heat sink is necessary to maintain proper thermal conditions.

1. Follow the safety guidelines listed in the [Safety instructions.](#)
2. Follow the procedure listed in the [Before working inside your system.](#)
3. If installed, [remove the air shroud.](#)
4. If installed, remove the processor dust cover.

i **NOTE:** The procedure to install standard and L-type heat sink is similar. The image shows L-type heat sink configuration system.

Steps

1. If you are using an existing heat sink, remove the thermal grease on the heat sink by using a clean lint-free cloth.

i **NOTE:** For a new heat sink, the thermal paste is preapplied to the heat sink. Remove the protective cover, and install the heat sink.

2. Use the thermal grease syringe included with your processor kit to apply the grease in a thin spiral on the top of the processor.

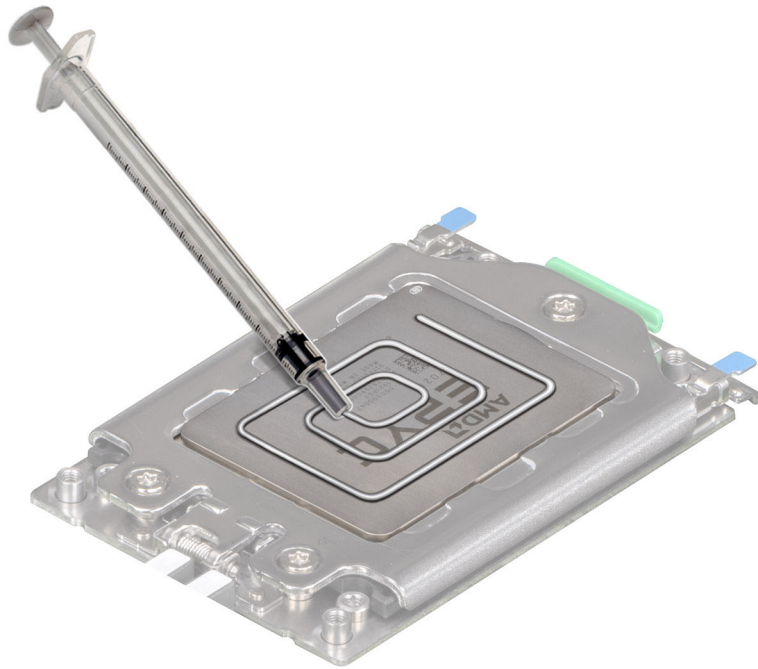

Figure 77. Applying thermal grease

CAUTION: Applying too much thermal grease can result in excess grease coming in contact with and contaminating the processor socket.

NOTE: The thermal grease syringe is intended for single use only. Dispose of the syringe after you use it.

3. Align the screws on the heat sink with the standoff screws on the system board.

NOTE: The A1 extrusion on the L-type heat sink should face towards the system side.

4. Using a Torx #T20 screwdriver, tighten the captive screws in the order that is mentioned below:

NOTE: The captive screw numbers are marked on the heat sink and are tightened to a torque value of 12.0 ± 1.2 lbf-in.

- a. Partially tighten the captive screws 1 and 2 (approximately 3 turns).
- b. Partially tighten the captive screws 3 and 4 (approximately 3 turns).
- c. Tighten the captive screws 1 and 2 completely.
- d. Tighten the captive screws 3 and 4 completely.

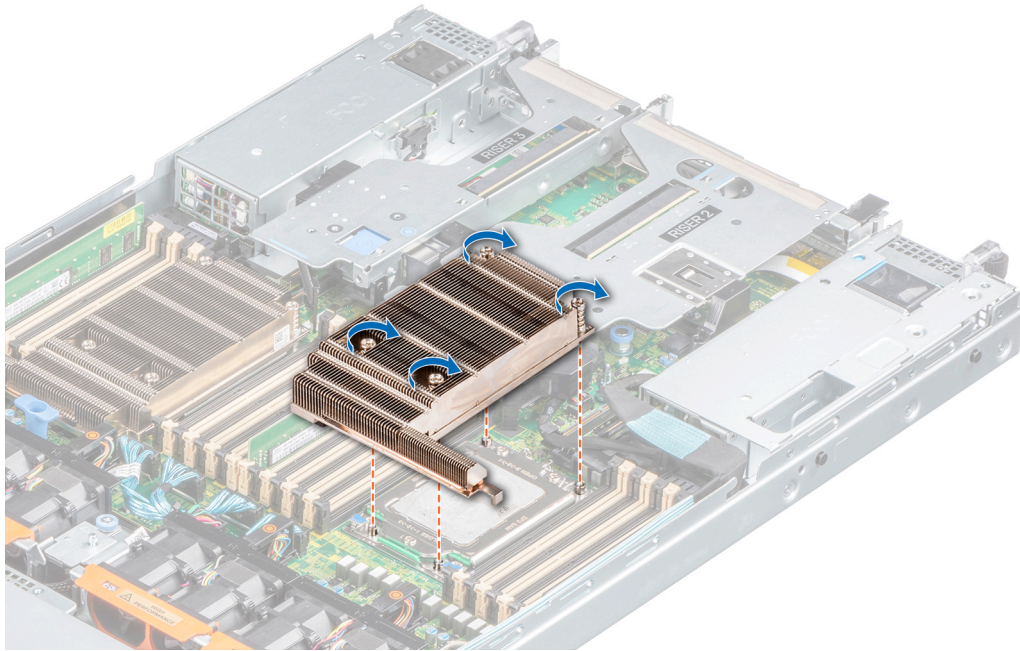

Figure 78. Installing a heat sink

Next steps

1. If removed, [install the air shroud](#).
2. Follow the procedure listed in the [After working inside your system](#).

Installing the liquid cooling heat sink modules

Prerequisites

Never uninstall the heat sink from a processor unless you intend to replace the processor or system board. The heat sink is necessary to maintain proper thermal conditions.

1. Follow the safety guidelines listed in the [Safety instructions](#).
2. Follow the procedure listed in the [Before working inside your system](#).
3. Remove the [system cover](#).
4. Remove the [air shroud](#).
5. Remove [riser 3](#) or [liquid cooling riser 3](#).
6. If installed, remove the processor dust cover.
7. For new heat sinks, refer to [Installing the heat sink](#) step 1 and 2 for applying the thermal grease.

Steps

1. Align the screws on the liquid cooling heat sink modules with the standoff screws on the system board. Ensure that the liquid cooling tubes and liquid detection cable are placed towards the rear of the chassis. Using a Torx #T20 screwdriver, tighten the captive screws in the order that is mentioned below:

NOTE: The A1 extrusion on the L-type heat sink should face towards the system side.

- a. Partially tighten the captive screws 1 and 2 (approximately 3 turns).
 - b. Partially tighten the captive screws 3 and 4 (approximately 3 turns).
 - c. Tighten the captive screws 1 and 2 completely.
 - d. Tighten the captive screws 3 and 4 completely.
2. Ensure that the liquid cooling tubes leading towards the front of the chassis is placed between the DIMM slots and the J_SL connectors. And the tubes leading towards the rear of the chassis are placed in between the DIMM slots and the relay components.

NOTE: Liquid detection cable must be placed underneath the cooling tubes to ensure it does not interfere with the PCIe risers

3. Route the liquid cooling tubes through the rear exit point next to the I/O function panel. Ensure the routing follows the numbered labels on the tube and liquid cooling ring holder (1, 2).
4. Connect the liquid cooling detection cable to the RIO connector.
5. Insert the rubber rings on the tubes on to the rubber holder.

NOTE: The numbers on the image do not depict the exact steps. The numbers are for representation of sequence.

6. Using a Phillips #1 screwdriver, tighten the captive screw on the liquid cooling ring holder to secure it in place.
7. Route the liquid cooling tubes and liquid cooling detection cable along side PSU 2 and secure them with the tube clip.

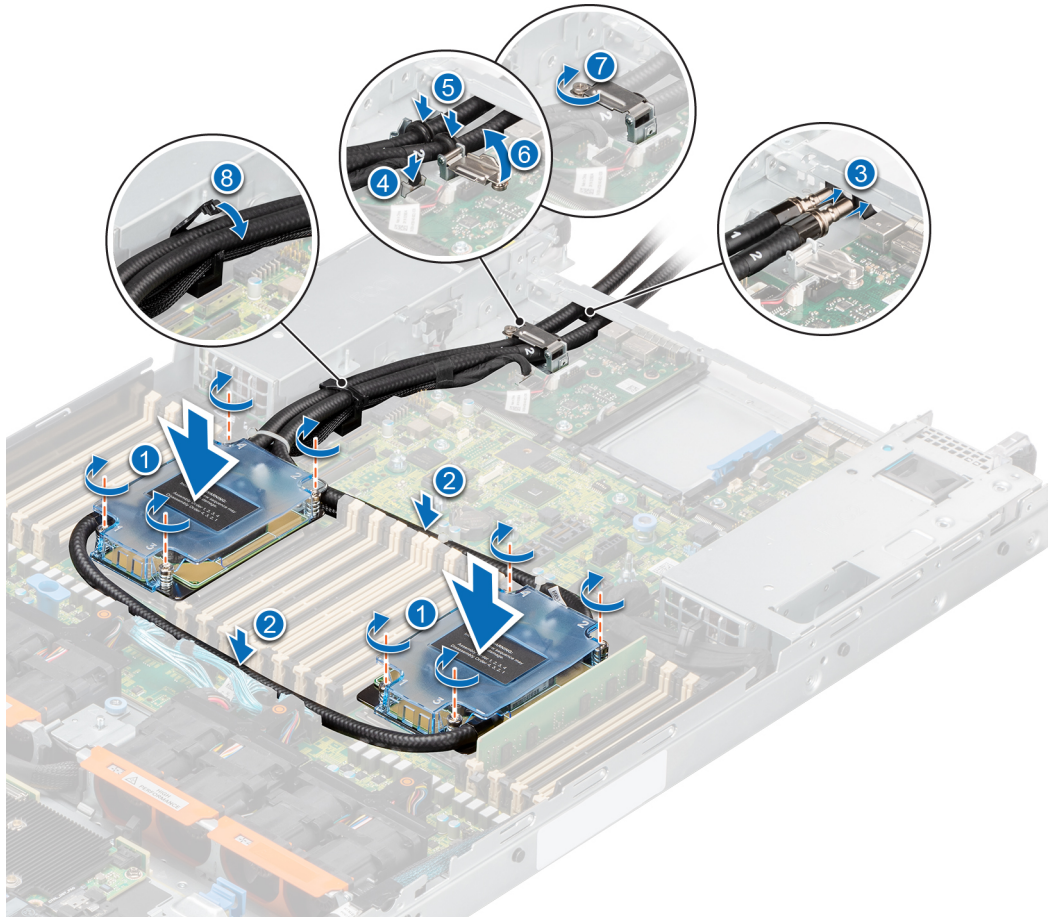

Figure 79. Installing the liquid cooling heat sink modules

Next steps

1. Remove liquid cooling riser 3.
2. Install the air shroud.
3. Install the system cover.
4. Follow the procedure listed in the [After working inside your system](#).

Expansion cards and expansion card risers

NOTE: A system event entry is logged in the iDRAC Lifecycle Controller if an expansion card riser is not supported or missing. It does not prevent your system from turning on. However, if a F1/F2 pause occurs with an error message,

see *Troubleshooting expansion cards* section in the *Dell EMC PowerEdge Servers Troubleshooting Guide* at www.dell.com/poweredgemanuals.

Expansion card installation guidelines

The following table describes the supported expansion cards:

Table 19. Expansion card riser configurations

Expansion card riser	PCIe slots on the riser	Processor connection	Height	Length	Slot width
R1a (Riser 1)	Slot 1	Processor 1	Full Height	3/4th Length	x16
R2a (Riser 2)	Slot 1	Processor 1	Low Profile	Half Length	x16
	Slot 2	Processor 2	Low Profile	Half Length	x16
R3a (Riser 3)	Slot 3	Processor 2	Low Profile	Half Length	x16
R4c + R4d (Riser 4)	Slot 2	Processor 2	Full Height	3/4th Length	x16

NOTE: The expansion-card slots are not hot-swappable.

The following table provides guidelines for installing expansion cards to ensure proper cooling and mechanical fit. The expansion cards with the highest priority should be installed first using the slot priority indicated. All the other expansion cards should be installed in the card priority and slot priority order.

Table 20. Configuration 0 - No riser

Card type	Slot priority	Maximum number of cards
Broadcom (OCP: 25 Gb)	Internal Slot	1
QLogic (OCP: 25 Gb)	Internal Slot	1
Mellanox (OCP: 25 Gb)	Internal Slot	1
Intel (OCP: 10 Gb)	Internal Slot	1
Broadcom (OCP: 10 Gb)	Internal Slot	1
QLogic (OCP: 10 Gb)	Internal Slot	1
Inventec (ASSY,CRD,CTL,BOSS,ADPT,S2V2,15G)	Internal Slot	1
Broadcom (OCP: 1 Gb)	Internal Slot	1
Intel (OCP: 1 Gb)	Internal Slot	1
SolarFlare (OCP: 25 Gb)	Internal Slot	1
FOXCONN (Front PERC)	Internal Slot	1
ASSY,CRD,CTL,H755,FRONT	Internal Slot	1

Table 21. Configuration 1: R1a

Card type	Slot priority	Maximum number of cards
Mellanox (NIC: 100 Gb)	1	1
Intel (NIC: 25 Gb)	1	1
Mellanox (NIC: 25 Gb)	1	1
QLogic (NIC: 25 Gb)	1	1
Emulex (HBA: FC32)	1	1
QLogic (HBA: FC32)	1	1

Table 21. Configuration 1: R1a (continued)

Card type	Slot priority	Maximum number of cards
Emulex (HBA: FC64, FH)	1	1
Emulex (HBA: FC16)	1	1
QLogic (HBA: FC16)	1	1
FOXCONN (HBA355E)	1	1
Intel (NIC: 10 Gb)	1	1
Broadcom (NIC: 10 Gb)	1	1
QLogic (NIC: 10 Gb)	1	1
Intel (NIC: 1 Gb)	1	1
Broadcom (NIC: 1 Gb)	1	1
Mellanox (NIC: HDR100 VPI)	1	1
Dell PERC Adapter	1	1
Dell BOSS Adapter	1	1
Samsung (PCIE SSD)	1	1
Intel (PCIE SSD)	1	1
Broadcom (NIC: 10Gb)	1	1
Intel (NIC: 25Gb)	1	1
Intel (NIC: 100Gb)	1	1
Emulex (CRD,CTL,EMLX,FH,FC32,1P,S28)	1	1
Intel (CRD,NTWK,INTL,FH,25G,2P,S28,F1)	1	1
Intel (CRD,NTWK,INTL,LP,25G,2P,S28,F10)	Not supported	0
Inventec (ASSY,CRD,CTL,BOSS,ADPT,S2V2,15G)	Internal Slot	1
FOXCONN (Front PERC)	Internal Slot	1
Dell Front PERC	Internal Slot	1
Broadcom (OCP: 25 Gb)	Internal Slot	1
QLogic (OCP: 25 Gb)	Internal Slot	1
Mellanox (OCP: 25 Gb)	Internal Slot	1
Intel (OCP: 10 Gb)	Internal Slot	1
Broadcom (OCP: 10 Gb)	Internal Slot	1
QLogic (OCP: 10 Gb)	Internal Slot	1
Broadcom (OCP: 1 Gb)	Internal Slot	1
Intel (OCP: 1 Gb)	Internal Slot	1
SolarFlare (OCP: 25 Gb)	Internal Slot	1
Intel (OCP: 25 Gb)	Internal Slot	1
FOXCONN (Front PERC, ASSY,CRD,CTL,H755,FRONT)	Internal Slot	1

Table 21. Configuration 1: R1a (continued)

Card type	Slot priority	Maximum number of cards
Emulex (HBA FC 32, FH,FC32,2P,V1.1)	1	1

Table 22. Configuration 2: R2a + R3a

Card type	Slot priority	Maximum number of cards
Inventec (BOSS)	1	1
GPU: NVIDIA T4 16 GB (Low Profile)	2, 1, 3	3
GPU: NVIDIA A2 16GB (Low Profile)	2, 1, 3	3
Mellanox (NIC: 100 Gb)	2, 1, 3	3
Mellanox (NIC: 50 Gb)	2, 1, 3	3
Intel (NIC: 25 Gb)	2, 1, 3	3
Mellanox (NIC: 25 Gb)	2, 1, 3	3
SolarFlare (NIC: 25 Gb)	2, 1, 3	3
Broadcom (NIC: 25 Gb)	2, 1, 3	3
QLogic (NIC: 25 Gb)	2, 1, 3	3
Emulex (HBA: FC64 LP)	2, 1, 3	3
Emulex (HBA: FC32)	2, 1, 3	3
QLogic (HBA: FC32)	2, 1, 3	3
Emulex (HBA: FC16)	2, 1, 3	3
QLogic (HBA: FC16)	2, 1, 3	3
FOXCONN (HBA355E)	2, 1, 3	2
Intel (NIC: 10 Gb)	2, 1, 3	3
Broadcom (NIC: 10 Gb)	2, 1, 3	3
QLogic (NIC: 10 Gb)	2, 1, 3	3
Intel (NIC: 1 Gb)	2, 1, 3	3
Broadcom (NIC: 1 Gb)	2, 1, 3	3
Mellanox (NIC: HDR100 VPI)	2, 1, 3	3
Mellanox (NIC: HDR VPI)	2, 1, 3	3
Foxconn (External adapter)	2, 1, 3	3
Samsung (PCIe SSD)	2, 1, 3	3
Intel (PCIe SSD)	2, 1, 3	3
Intel (NIC: 100Gb)	2, 1, 3	3
Broadcom (NIC: 10Gb)	2, 1, 3	3
Emulex (CRD,CTL,EMLX,LP,FC32,1P,S28)	2, 1, 3	3
Intel (CRD,NTWK,INTL,LP,25G,2P,S28,F1)	2, 1, 3	3
Inventec (ASSY,CRD,CTL,BOSS,ADPT,S2V2,15G)	Internal Slot	1
Inventec (Front PERC)	Internal Slot	1

Table 22. Configuration 2: R2a + R3a (continued)

Card type	Slot priority	Maximum number of cards
Foxconn (Front PERC)	Internal Slot	1
Mellanox (OCP: 100 Gb)	Internal Slot	1
Mellanox (OCP: 50 Gb)	Internal Slot	1
Broadcom (OCP: 25 Gb)	Internal Slot	1
QLogic (OCP: 25 Gb)	Internal Slot	1
Mellanox (OCP: 25 Gb)	Internal Slot	1
SolarFlare (OCP: 25 Gb)	Internal Slot	1
Intel (OCP: 25 Gb)	Internal Slot	1
Intel (OCP: 10 Gb)	Internal Slot	1
Broadcom (OCP: 10 Gb)	Internal Slot	1
QLogic (OCP: 10 Gb)	Internal Slot	1
QLogic (CRD,CTL,MRVL,LP,FC32,1P,S28,F1)	2, 1, 3	3
Broadcom (OCP: 1 Gb)	Internal Slot	1
Intel (OCP: 1 Gb)	Internal Slot	1
Intel (OCP: 25Gb)	Internal Slot	1
Foxconn (Front PERC, ASSY,CRD,CTL,H755,FRONT)	Internal Slot	1
Emulex (HBA FC 32, LP,FC32,2P,V1.1)	2,1,3	3

Table 23. Configuration 4: R1a + R4c +R4d

Card type	Slot priority	Maximum number of cards
Dell BOSS Adapter	2, 1	1
GPU: NVIDIA T4 16 GB (Full Height)	2, 1	2
GPU: NVIDIA A2 16GB (Full Height)	2, 1	2
Mellanox (NIC: 100 Gb)	2, 1	2
Intel (NIC: 25 Gb)	2, 1	2
Mellanox (NIC: 25 Gb)	2, 1	2
Broadcom (NIC: 25 Gb)	2, 1	2
QLogic (NIC: 25 Gb)	2, 1	2
Emulex (HBA: FC64 FH)	2, 1	2
Emulex (HBA: FC32)	2, 1	2
QLogic (HBA: FC32)	2, 1	2
Emulex (HBA: FC16)	2, 1	2
QLogic (HBA: FC16)	2, 1	2
FOXCONN (HBA355E)	2, 1	2
Intel (NIC: 10 Gb)	2, 1	2
Broadcom (NIC: 10 Gb)	2, 1	2
QLogic (NIC: 10 Gb)	2, 1	2

Table 23. Configuration 4: R1a + R4c +R4d (continued)

Card type	Slot priority	Maximum number of cards
Intel (NIC: 1 Gb)	2, 1	2
Broadcom (NIC: 1 Gb)	2, 1	2
Dell PERC Adapter	2, 1	2
Samsung (PCIe SSD)	2, 1	2
Intel (PCIe SSD)	2, 1	2
Intel (NIC: 25Gb)	2, 1	2
Intel (NIC: 100Gb)	2, 1	2
Broadcom (NIC: 10Gb)	2,1	2
Emulex (CRD,CTL,EMLX,FH,FC32,1P,S28)	2, 1	2
CRD,NTWK,INTL,FH,25G,2P,S28,F1	2, 1	2
Inventec (ASSY,CRD,CTL,BOSS,ADPT,S2V2,15G)	Internal Slot	1
FOXCONN (Front PERC)	Internal Slot	1
Dell Front PERC	Internal Slot	1
Broadcom (OCP: 25 Gb)	Internal Slot	1
QLogic (OCP: 25 Gb)	Internal Slot	1
Mellanox (OCP: 25 Gb)	Internal Slot	1
Intel (OCP: 10 Gb)	Internal Slot	1
Broadcom (OCP: 10 Gb)	Internal Slot	1
QLogic (OCP: 10 Gb)	Internal Slot	1
Broadcom (OCP: 1 Gb)	Internal Slot	1
Intel (OCP: 1 Gb)	Internal Slot	1
SolarFlare (OCP: 25 Gb)	Internal Slot	1
Intel (OCP: 25Gb)	Internal Slot	1
ASSY,CRD,CTL,H755,FRONT	Internal Slot	1
Emulex (HBA FC 32, FH,FC32,2P,V1.1)	2,1	2

Table 24. Configuration 5: R3a

Card type	Slot priority	Maximum number of cards
Mellanox (NIC: 100 Gb)	3	1
Mellanox (NIC: 50 Gb)	3	1
Intel (NIC: 25 Gb)	3	1
Mellanox (NIC: 25 Gb)	3	1
SolarFlare (NIC: 25 Gb)	3	1
Broadcom (NIC: 25 Gb)	3	1
QLogic (NIC: 25 Gb)	3	1
Emulex (HBA: FC64 LP)	3	1
Emulex (HBA: FC32)	3	1

Table 24. Configuration 5: R3a (continued)

Card type	Slot priority	Maximum number of cards
QLogic (HBA: FC32)	3	1
Emulex (HBA: FC16)	3	1
QLogic (HBA: FC16)	3	1
FOXCONN (HBA355E)	3	1
Intel (NIC: 10 Gb)	3	1
Broadcom (NIC: 10 Gb)	3	1
QLogic (NIC: 10 Gb)	3	1
Intel (NIC: 1 Gb)	3	1
Broadcom (NIC: 1 Gb)	3	1
Foxconn (External adapter)	3	1
Inventec (BOSS)	3	1
Samsung (PCIe SSD)	3	1
Intel (PCIe SSD)	3	1
Intel (NIC: 100Gb, LP)	3	1
Broadcom (NIC: 10Gb)	3	1
QLogic (CRD,CTL,MRVL,LP,FC32,1P,S28,F1)	3	1
Emulex (CRD,CTL,EMLX,LP,FC32,1P,S28)	3	1
Intel (CRD,NTWK,INTL,LP,25G,2P,S28,F1)	3	1
Inventec (ASSY,CRD,CTL,BOSS,ADPT,S2V2,15G)	Internal Slot	1
Inventec (Front PERC)	Internal Slot	1
Foxconn (Front PERC)	Internal Slot	1
Mellanox (OCP: 100 Gb)	Internal Slot	1
Mellanox (OCP: 50 Gb)	Internal Slot	1
Broadcom (OCP: 25 Gb)	Internal Slot	1
QLogic (OCP: 25 Gb)	Internal Slot	1
Mellanox (OCP: 25 Gb)	Internal Slot	1
SolarFlare (OCP: 25 Gb)	Internal Slot	1
Intel (OCP: 25 Gb)	Internal Slot	1
Intel (OCP: 10 Gb)	Internal Slot	1
Broadcom (OCP: 10 Gb)	Internal Slot	1
QLogic (OCP: 10 Gb)	Internal Slot	1
Broadcom (OCP: 1 Gb)	Internal Slot	1
Intel (OCP: 1 Gb)	Internal Slot	1
Intel (OCP: 25 Gb)	Internal Slot	1

Table 24. Configuration 5: R3a (continued)

Card type	Slot priority	Maximum number of cards
FOXCONN (Front OERC, ASSY,CRD,CTL,H755,FRONT)	Internal Slot	1
Emulex (HBA FC 32, LP,FC32,2P,V1.1)	3	1

Table 25. Configuration 6: R1D+R2A+R3A

Card type	Slot priority	Maximum number of cards
Inventec (Serial)	3	1
GPU: NVIDIA T4 16 GB (Low Profile)	2, 1, 3	3
GPU: NVIDIA A2 16GB (Low Profile)	2, 1, 3	3
Mellanox (NIC: 100Gb)	2, 1, 3	3
Broadcom (NIC: 100Gb)	2, 1, 3	3
Intel (NIC: 100Gb)	2, 1, 3	3
Mellanox (NIC: 50Gb)	2, 1, 3	3
QLogic (NIC: 25Gb)	2, 1, 3	3
Intel (NIC: 25Gb)	2, 1, 3	3
Mellanox (NIC: 25Gb)	2, 1, 3	3
Broadcom (NIC: 25Gb)	2, 1, 3	3
Mellanox (NIC: 25Gb)	2, 1, 3	3
Emulex (HBA: FC64 LP)	2, 1, 3	3
Emulex (HBA: FC32)	2, 1, 3	3
QLogic (HBA: FC32)	2, 1, 3	3
Emulex (HBA: FC16)	2, 1, 3	3
Emulex (HBA: FC16)	2, 1, 3	3
QLogic (HBA: FC16)	2, 1, 3	3
QLogic (NIC: 10Gb)	2, 1, 3	3
Intel (NIC: 10Gb)	2, 1, 3	3
Broadcom (NIC: 10Gb)	2, 1, 3	3
Intel (NIC: 1Gb)	2, 1, 3	3
Broadcom (NIC: 1Gb)	2, 1, 3	3
Mellanox (NIC: HDR100 VPI)	2, 1, 3	3
Mellanox (NIC:HDR VPI)	2, 1, 3	3
Broadcom (OCP: 100Gb)	Internal Slot	1
Broadcom (OCP: 25Gb)	Internal Slot	1
QLogic (OCP: 25Gb)	Internal Slot	1
Mellanox (OCP: 25Gb)	Internal Slot	1
SolarFlare (OCP: 25Gb)	Internal Slot	1
Intel (OCP: 25Gb)	Internal Slot	1
Intel (OCP: 10Gb)	Internal Slot	1

Table 25. Configuration 6: R1D+R2A+R3A (continued)

Card type	Slot priority	Maximum number of cards
Broadcom (OCP: 10Gb)	Internal Slot	1
QLogic (OCP: 10Gb)	Internal Slot	1
Broadcom (OCP: 10Gb)	Internal Slot	1
Intel (OCP: 1Gb)	Internal Slot	1
FOXCONN H840 (External Adapter)	2, 1, 3	2
FOXCONN HBA355E (External Adapter)	2, 1, 3	2
FOXCONN 12GB SAS HBA (External Adapter)	2, 1, 3	2
Inventec (BOSS-S2)	Internal Slot	1
Inventec (BOSS-S1)	2, 1, 3	1
SAMSUNG (PCIE SSD)	2, 1, 3	3
INTEL (PCIE SSD)	2, 1, 3	3
Inventec (Serial IO)	3	1

Table 26. Configuration 8: R1A

Card type	Slot priority	Maximum number of cards
FOXCONN H755 (Front PERC)	Internal Slot	1
INVENTEC H745 (Front PERC)	Internal Slot	1
FOXCONN H345 (Front PERC)	Internal Slot	1
FOXCONN H355 (Front PERC)	Internal Slot	1
FOXCONN H355I (Front PERC)	Internal Slot	1
Mellanox (NIC: 100Gb)	1	1
Intel (NIC: 100Gb)	1	1
Broadcom (NIC: 100Gb)	1	1
QLogic (NIC: 25Gb)	1	1
Broadcom (NIC: 25Gb)	1	1
Intel (NIC: 25Gb)	1	1
Mellanox (NIC: 25Gb)	1	1
Emulex (HBA: FC64 FH)	1	1
Emulex (HBA: FC32)	1	1
QLogic (HBA: FC32)	1	1
Emulex (HBA: FC16)	1	1
QLogic (HBA: FC16)	1	1
QLogic (NIC: 10Gb)	1	1
QLogic (NIC: 10Gb)	1	1
QLogic (NIC: 10Gb)	1	1
Intel (NIC: 10Gb)	1	1
Broadcom (NIC: 10Gb)	1	1

Table 26. Configuration 8: R1A (continued)

Card type	Slot priority	Maximum number of cards
QLogic (NIC: 10Gb)	1	1
Intel (NIC: 1Gb)	1	1
Broadcom (NIC: 1Gb)	1	1
Mellanox (NIC: HDR100 VPI)	1	1
Mellanox (NIC:HDR VPI)	1	1
Broadcom (OCP: 100Gb)	Internal Slot	1
Broadcom (OCP: 25Gb)	Internal Slot	1
QLogic (OCP: 25Gb)	Internal Slot	1
Mellanox (OCP: 25Gb)	Internal Slot	1
SolarFlare (OCP: 25Gb)	Internal Slot	1
Intel (OCP: 25Gb)	Internal Slot	1
Intel (OCP: 10Gb)	Internal Slot	1
Broadcom (OCP: 10Gb)	Internal Slot	1
QLogic (OCP: 10Gb)	Internal Slot	1
Broadcom (OCP: 1Gb)	Internal Slot	1
Intel (OCP: 1Gb)	Internal Slot	1
FOXCONN HBA355E (External Adapter)	1	1
FOXCONN 12GB SAS HBA (External Adapter)	1	1
Inventec (BOSS-S2)	Internal Slot	1
Inventec (BOSS-S1)	1	1
SAMSUNG (PCIE SSD)	1	1
SAMSUNG (PCIE SSD)	1	1
INTEL (PCIE SSD)	1	1

Table 27. Configuration 9: R1A+R4C+R4D

Card type	Slot priority	Maximum number of cards
GPU NVIDIA T4 16 GB (Full Height)	2, 1	2
GPU: NVIDIA A2 16GB (Full Height)	2, 1	2
FOXCONN H755 (Front PERC)	Internal Slot	1
INVENTEC H745 (Front PERC)	Internal Slot	1
FOXCONN H345 (Front PERC)	Internal Slot	1
FOXCONN H355 (Front PERC)	Internal Slot	1
FOXCONN H355I (Front PERC)	Internal Slot	1
FOXCONN H345 (Front PERC)	Internal Slot	1
Mellanox (NIC: 100Gb)	2, 1	2
Intel (NIC: 100Gb)	2, 1	2
Broadcom (NIC: 100Gb)	2, 1	2

Table 27. Configuration 9: R1A+R4C+R4D (continued)

Card type	Slot priority	Maximum number of cards
QLogic (NIC: 25Gb)	2, 1	2
Broadcom (NIC: 25Gb)	2, 1	2
Intel (NIC: 25Gb)	2, 1	2
Mellanox (NIC: 25Gb)	2, 1	2
Emulex (HBA: FC64 FH)	2, 1	2
Emulex (HBA: FC32)	2, 1	2
QLogic (HBA: FC32)	2, 1	2
Emulex (HBA: FC16)	2, 1	2
QLogic (HBA: FC16)	2, 1	2
QLogic (NIC: 10Gb)	2, 1	2
Intel (NIC: 10Gb)	2, 1	2
Broadcom (NIC: 10Gb)	2, 1	2
QLogic (NIC: 10Gb)	2, 1	2
Intel (NIC: 1Gb)	2, 1	2
Broadcom (NIC: 1Gb)	2, 1	2
Mellanox (NIC: HDR100 VPI)	2, 1	2
Mellanox (NIC:HDR VPI)	2, 1	2
Broadcom (OCP: 100Gb)	Internal Slot	1
Broadcom (OCP: 25Gb)	Internal Slot	1
QLogic (OCP: 25Gb)	Internal Slot	1
Mellanox (OCP: 25Gb)	Internal Slot	1
SolarFlare (OCP: 25Gb)	Internal Slot	1
Intel (OCP: 25Gb)	Internal Slot	1
Intel (OCP: 10Gb)	Internal Slot	1
Broadcom (OCP: 10Gb)	Internal Slot	1
QLogic (OCP: 10Gb)	Internal Slot	1
Broadcom (OCP: 1Gb)	Internal Slot	1
Intel (OCP: 1Gb)	Internal Slot	1
FOXCONN H840 (External Adapter)	2, 1	2
FOXCONN HBA355E (External Adapter)	2, 1	2
FOXCONN 12GB SAS HBA (External Adapter)	2, 1	2
Inventec (BOSS -S2)	Internal Slot	1
Inventec (BOSS-S1)	2, 1	1
SAMSUNG (PCIE SSD)	2, 1	2
SAMSUNG (PCIE SSD)	2, 1	2
INTEL (PCIE SSD)	2, 1	2

Removing the expansion card risers

Prerequisites

1. Follow the safety guidelines listed in the [Safety instructions](#).
2. Follow the procedure listed in the [Before working inside your system](#).
3. Disconnect any cables that are connected to the expansion card.

Steps

1. For Riser 1, press the blue tab and holding the edges lift the expansion card riser from the riser connector on the system board.

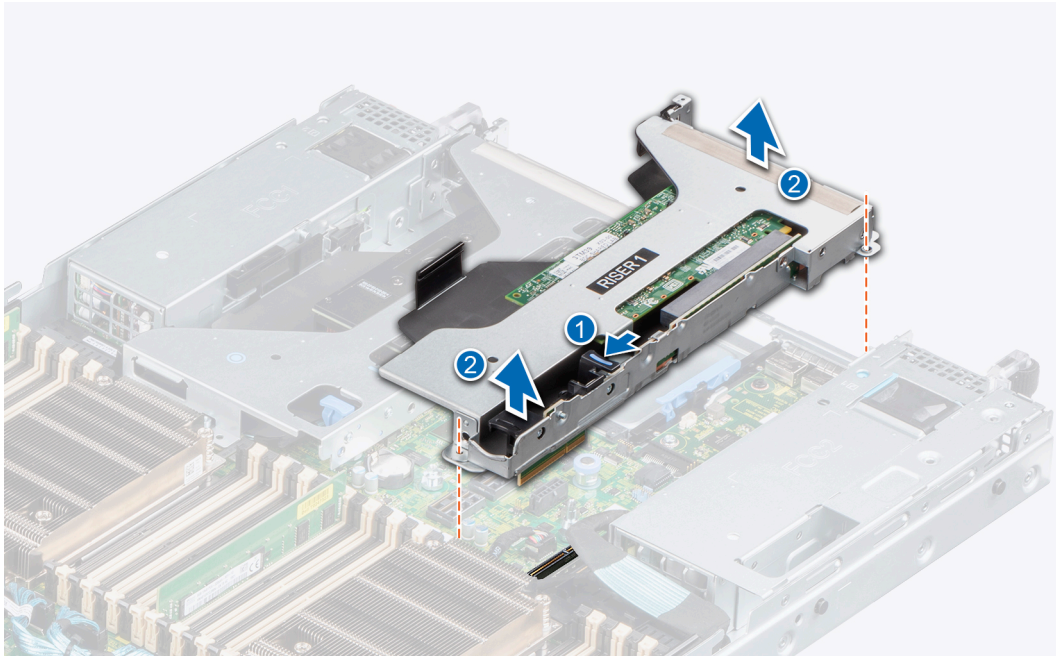

Figure 80. Removing the expansion card riser (Riser 1)

2. For Riser 2 and liquid cooling Riser 2, press the blue button on the riser, and holding the touch points lift the expansion card riser from the riser connector on the system board.

NOTE: The numbers on the image do not depict the exact steps. The numbers are for representation of sequence.

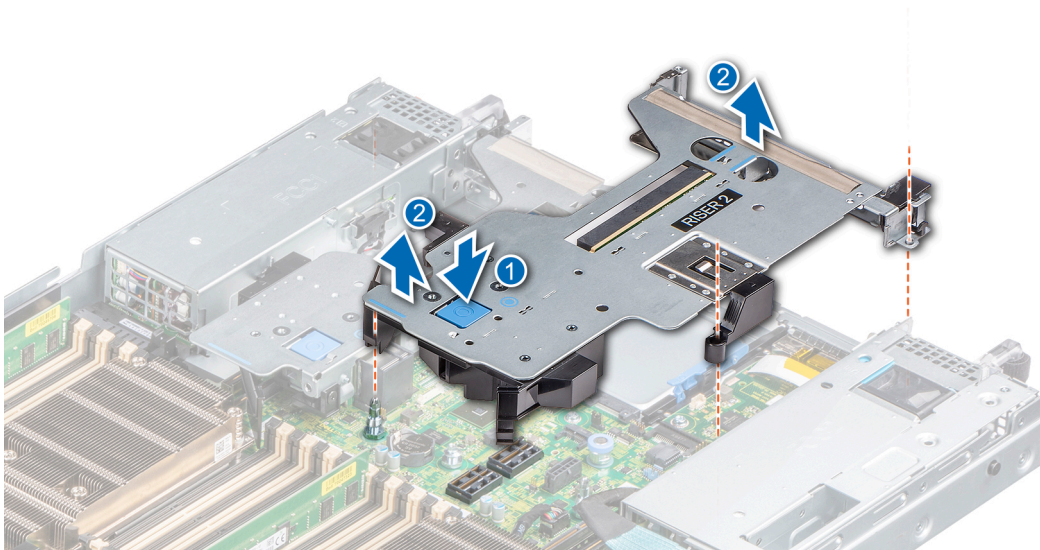

Figure 81. Removing the expansion card riser (Riser 2)

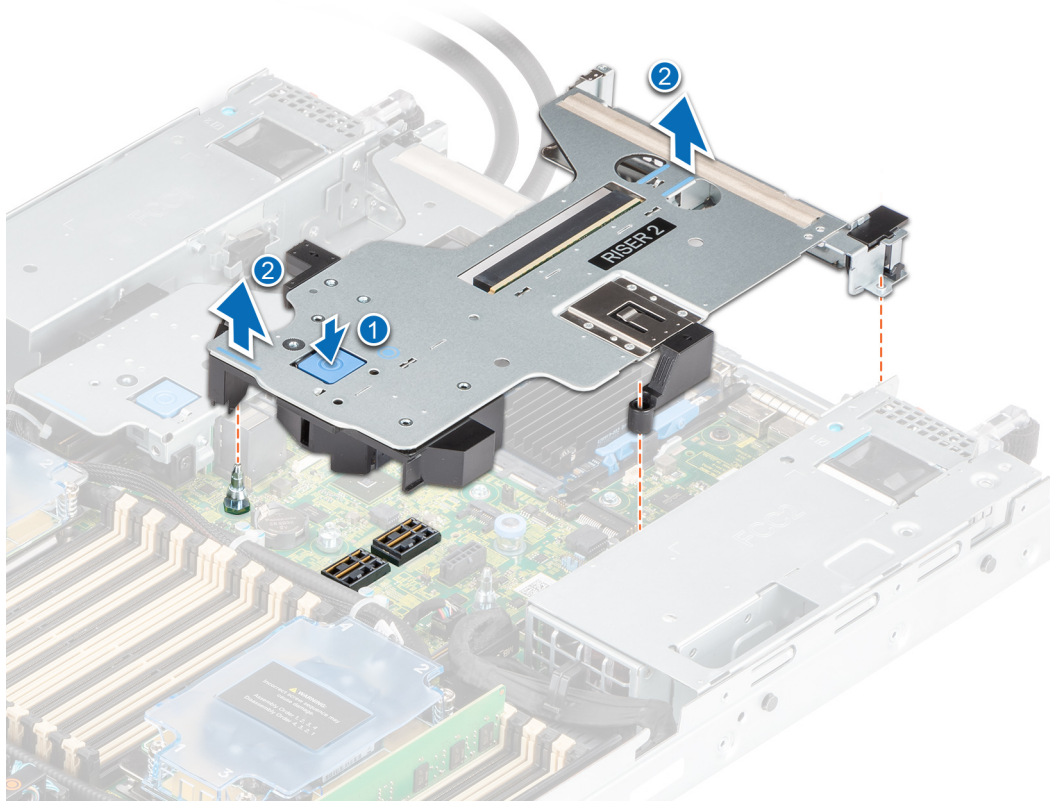

Figure 82. Removing the liquid cooling expansion card riser (liquid cooling Riser 2)

3. For Riser 3 and liquid cooling Riser 3, press the blue button on the riser, and lift the expansion card riser from the riser connector on the system board.

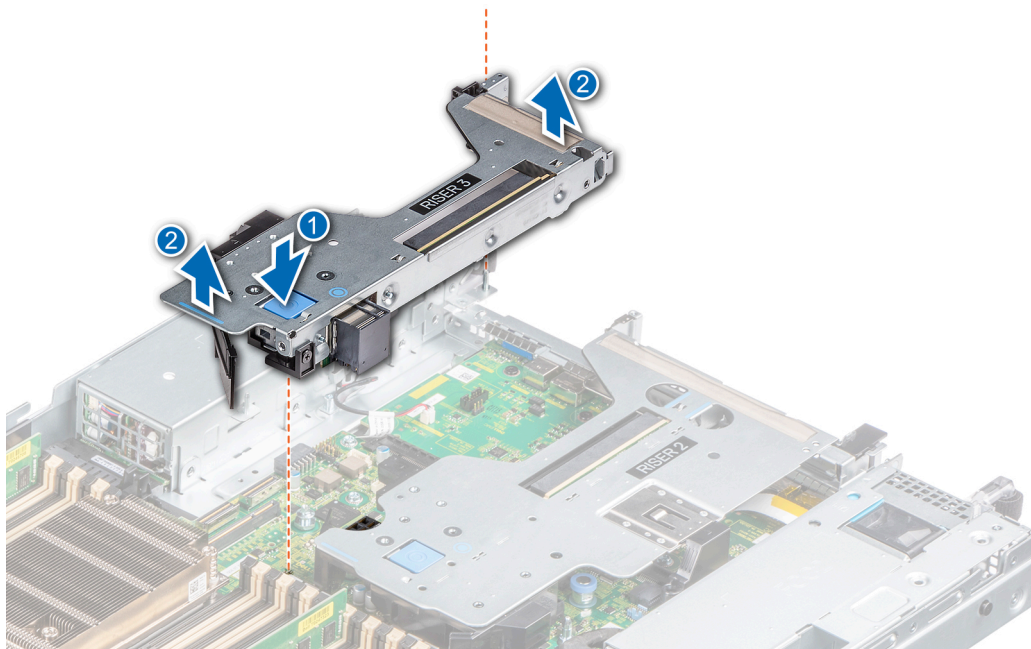

Figure 83. Removing the expansion card riser (Riser 3)

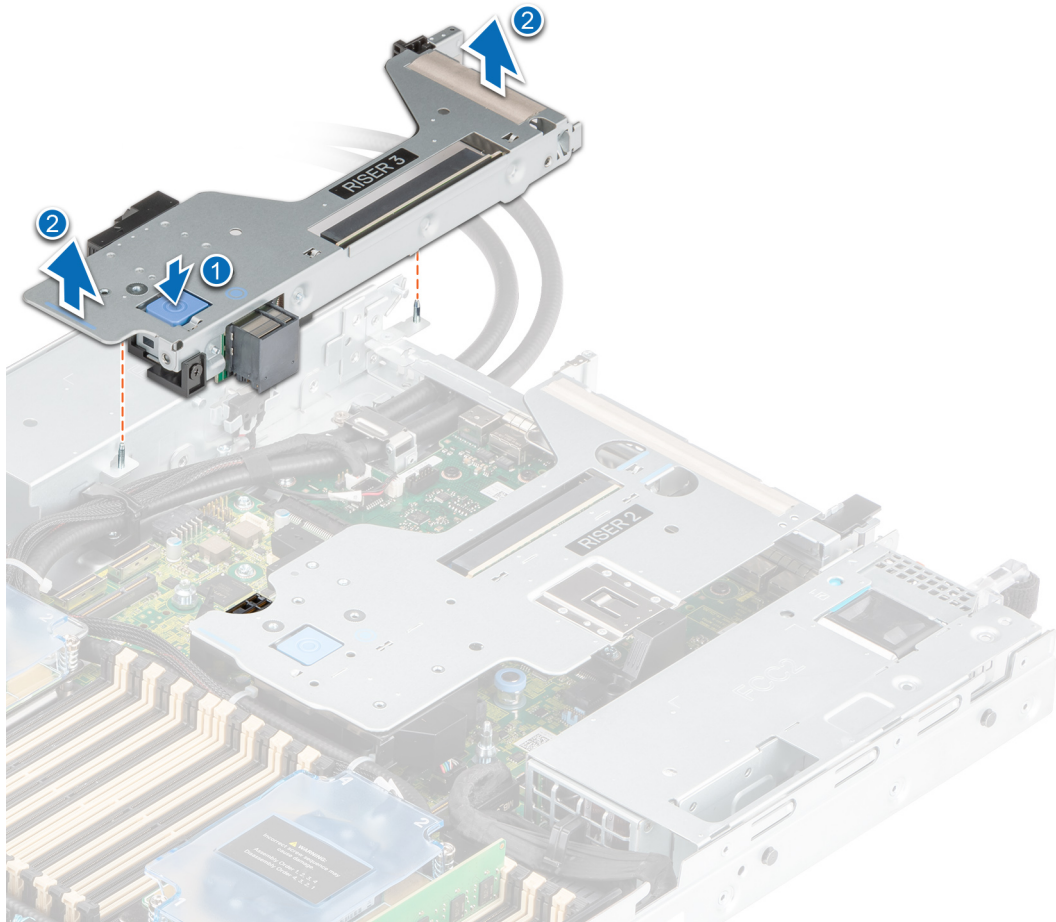

Figure 84. Removing the liquid cooling expansion card riser (liquid cooling Riser 3)

4. For Riser 4, press the blue tab on the riser, and holding the touch point lift the expansion card riser from the riser connector on the system board.

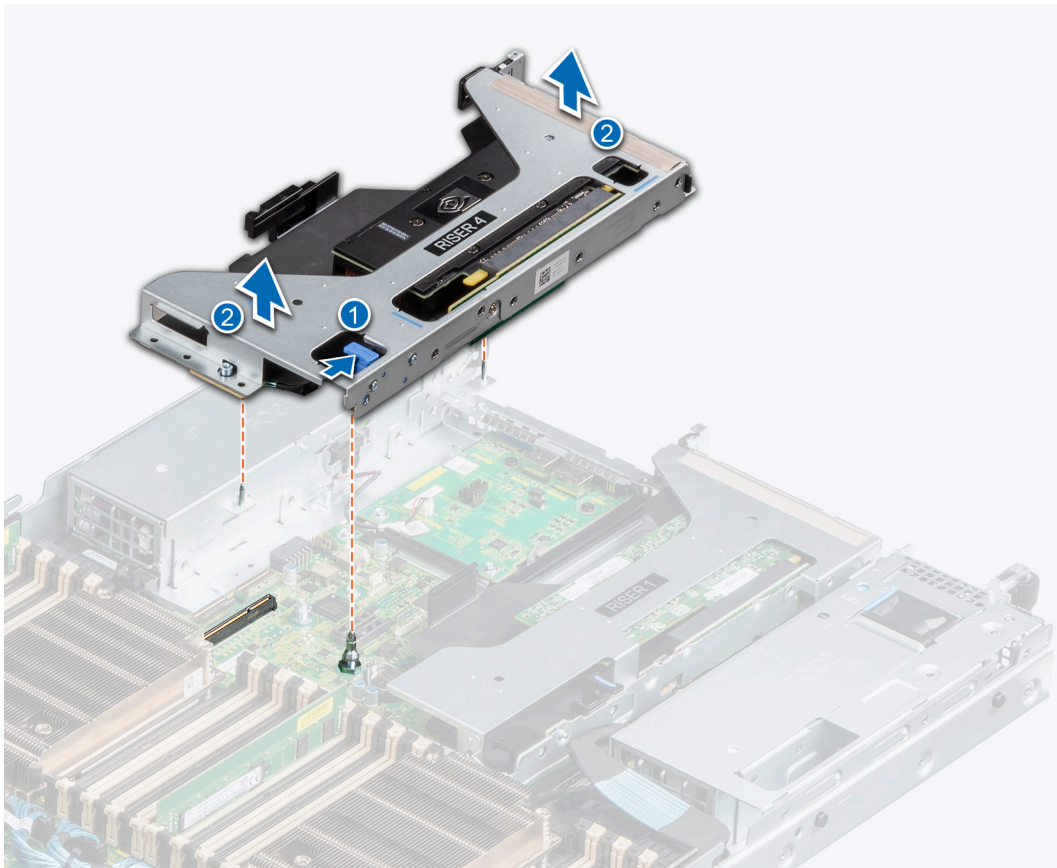

Figure 85. Removing the expansion card riser (Riser 4)

Next steps

1. [Replace the expansion card riser.](#)

Installing the expansion card risers

Prerequisites

1. Follow the safety guidelines listed in the [Safety instructions](#).
2. Follow the procedure listed in [Before working inside your system](#).
3. If removed, [install the expansion cards into the expansion card risers](#).

Steps

1. Holding the edges or the touch points, align the holes on the expansion card riser with the guides on the system board.
2. Lower the expansion card riser into place and press the touch points until the expansion card riser connector is fully seated on the system board connector.

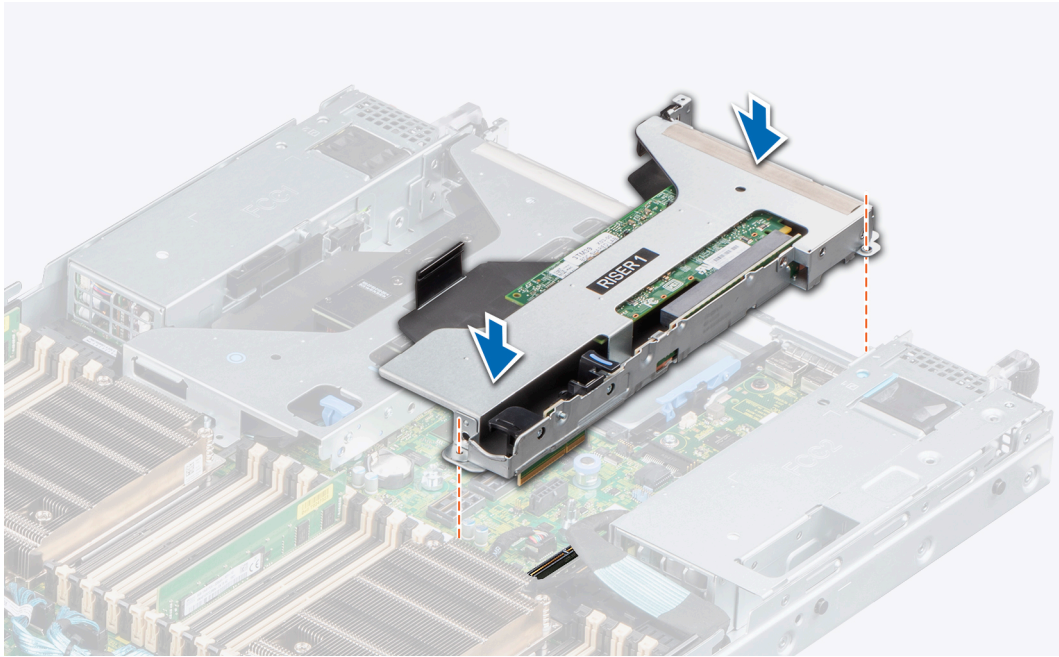

Figure 86. Installing the expansion card riser (Riser 1)

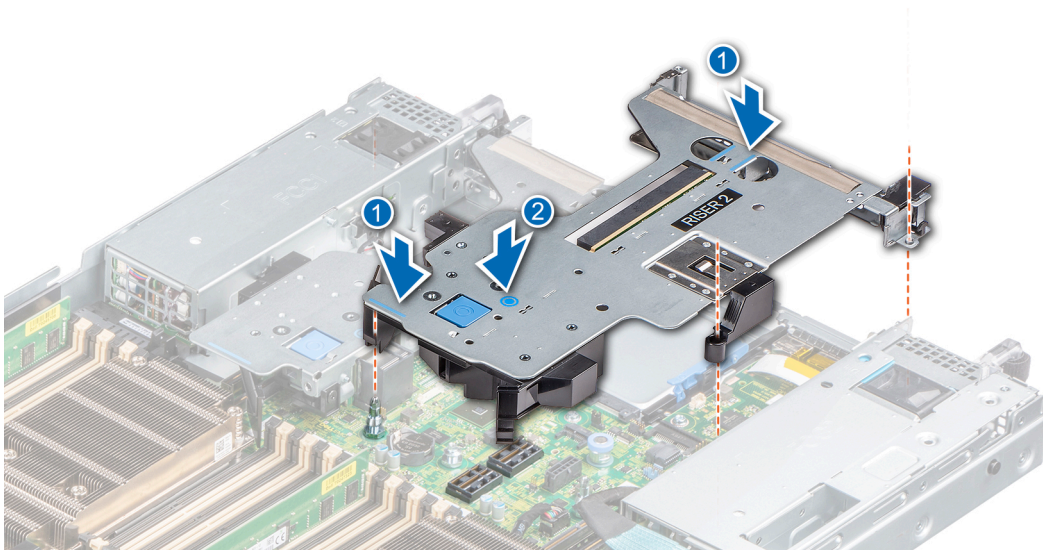

Figure 87. Installing the expansion card riser (Riser 2)

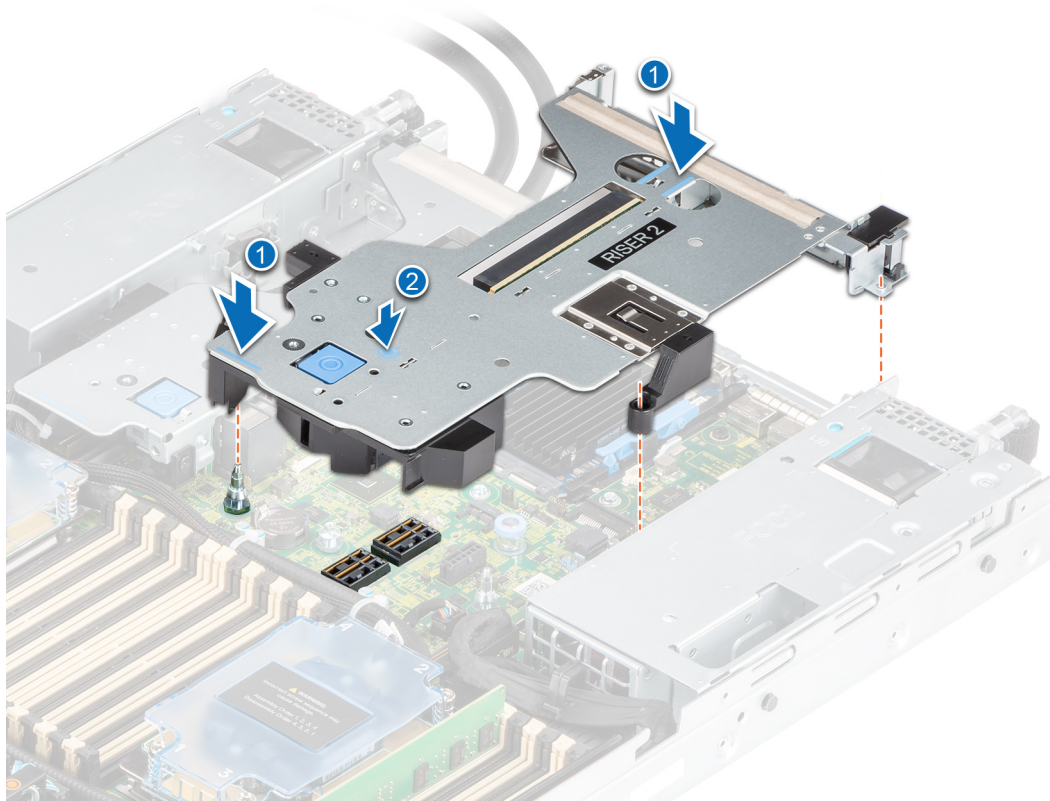

Figure 88. Installing the liquid cooling expansion card riser (liquid cooling Riser 2)

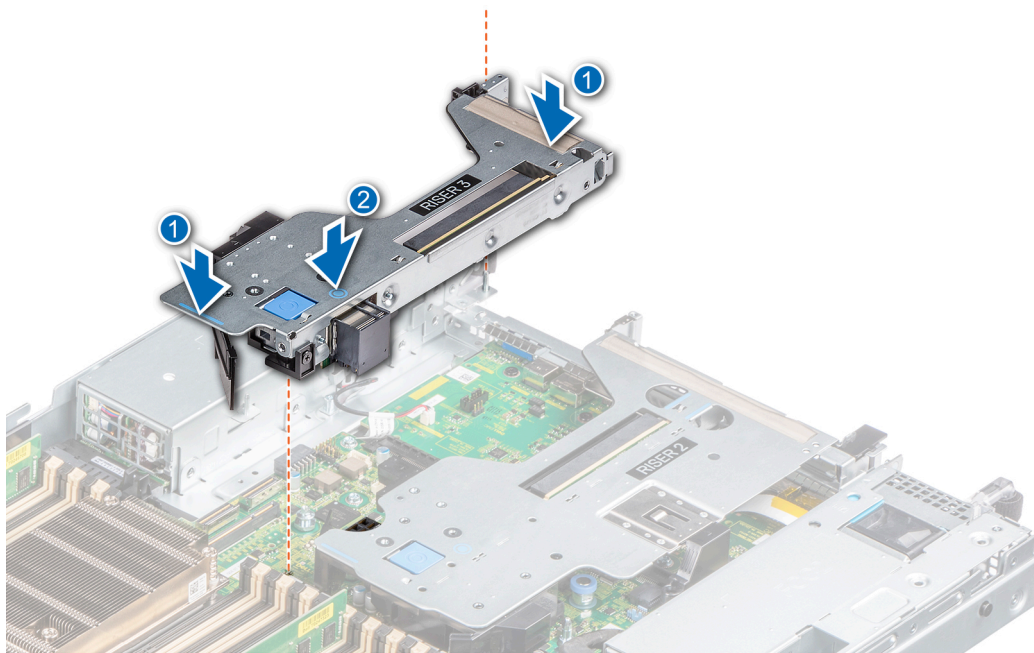

Figure 89. Installing the expansion card riser (Riser 3)

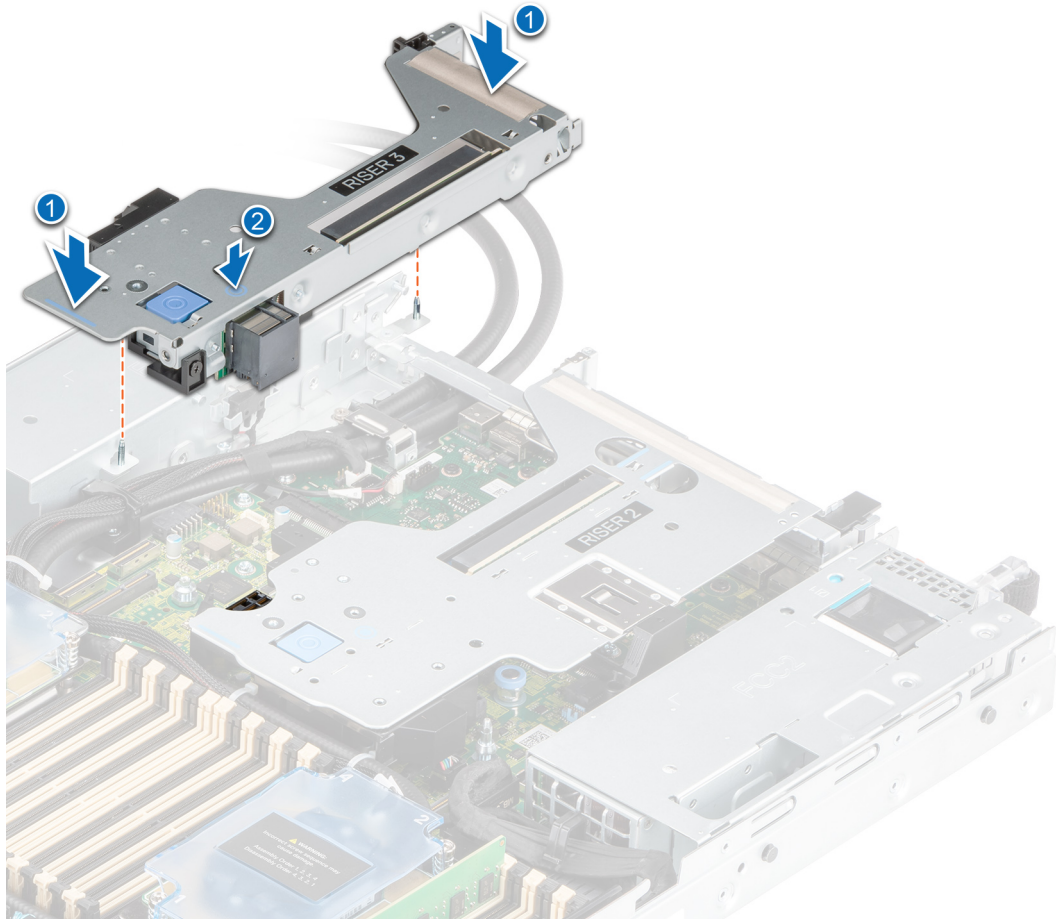

Figure 90. Installing the liquid cooling expansion card riser (liquid cooling Riser 3)

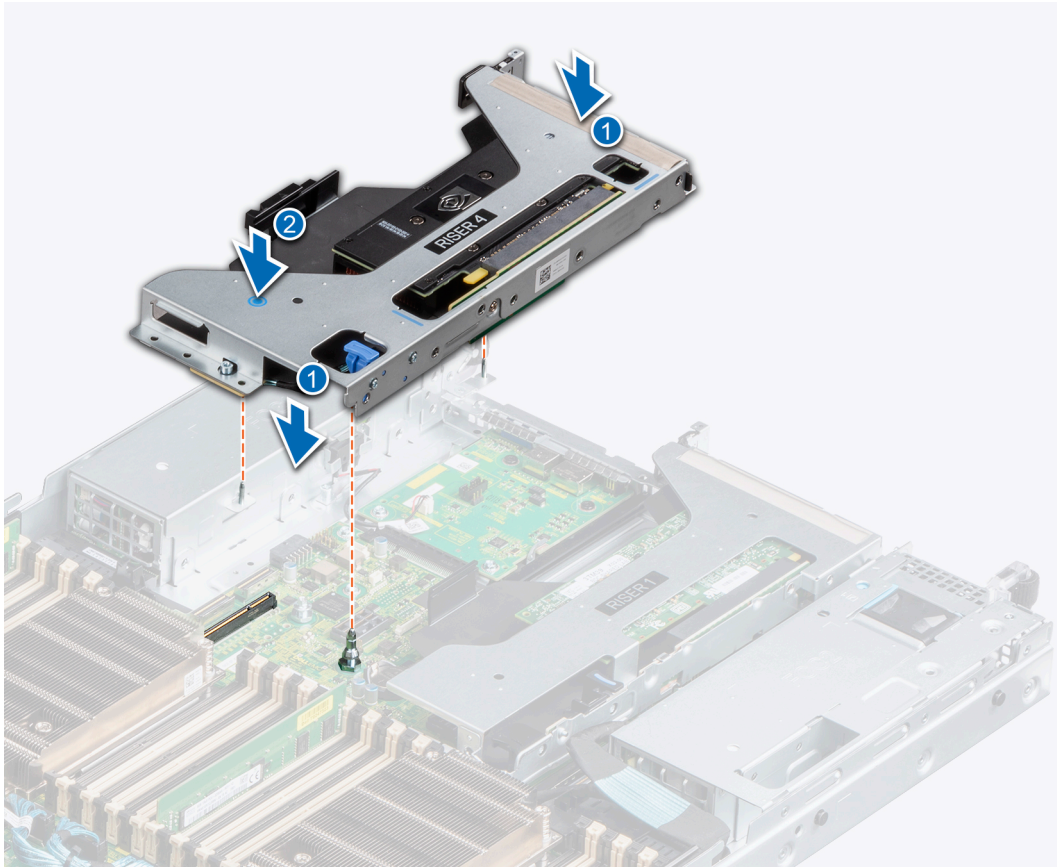

Figure 91. Installing the expansion card riser (Riser 4)

Next steps

1. If required, re-connect the cables to the expansion card.
2. Follow the procedure listed in [After working inside your system](#).
3. Install any device drivers required for the card as described in the documentation for the card.

Removing expansion card from the expansion card riser

Prerequisites

1. Follow the safety guidelines listed in the [Safety instructions](#).
2. Follow the procedure listed in the [Before working inside your system](#).
3. If applicable, disconnect the cables from the expansion card.

Steps

1. Pull and lift the expansion card retention latch lock to open.

NOTE: Pull the black card holder before removing the card from the riser.

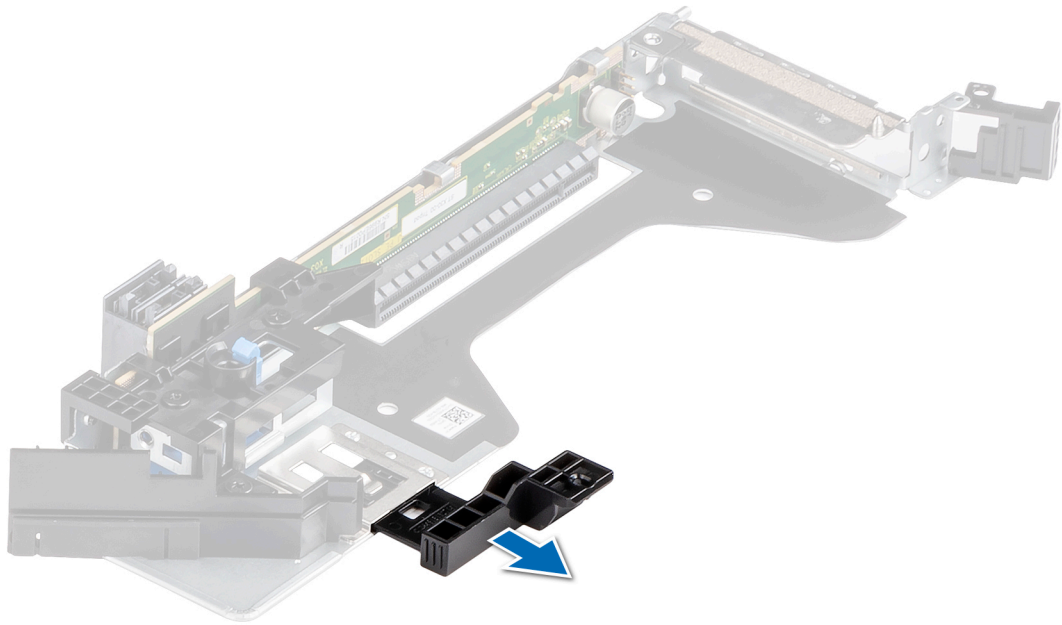

Figure 92. Opening the card holder on the expansion card riser

2. Hold the expansion card by the edges and pull the card until the card edge connector disengages from the expansion card connector on the riser.

NOTE: The numbers on the image do not depict the exact steps. The numbers are for representation of sequence.

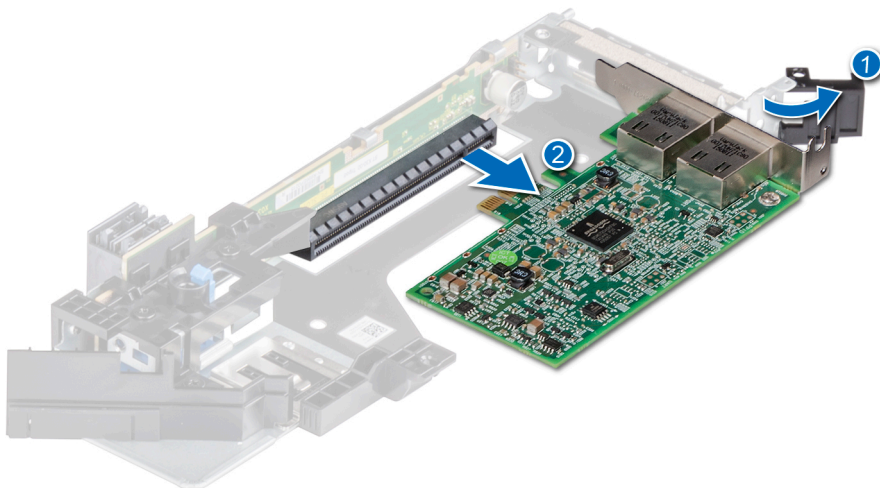

Figure 93. Removing expansion card from the expansion card riser

3. If the expansion card is not going to be replaced, install a filler bracket and close the card retention latch.

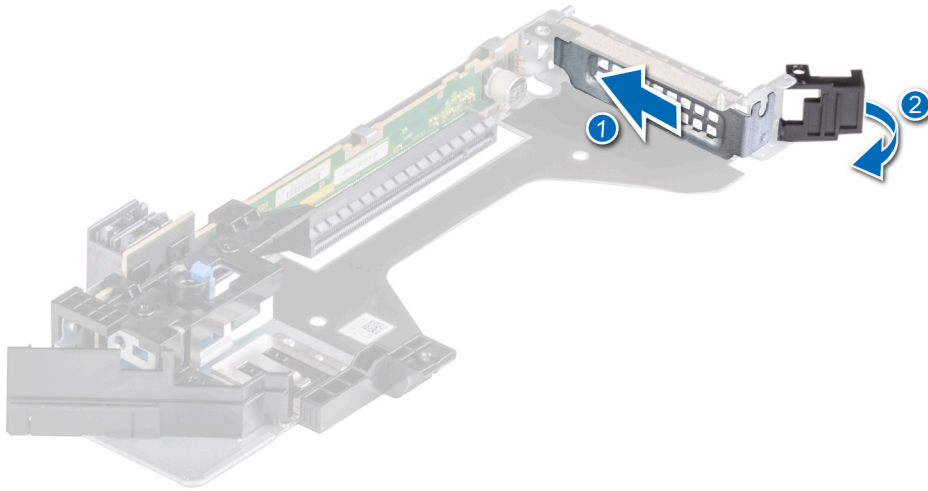

Figure 94. Installing the filler bracket

Next steps

1. If applicable, [install an expansion card into the expansion card riser](#).

Installing an expansion card into the expansion card riser

Prerequisites

⚠ WARNING: Consumer-Grade GPU should not be installed or used in the Enterprise Server products.

1. Follow the safety guidelines listed in the [Safety instructions](#).
2. Follow the procedure listed in [Before working inside your system](#).
3. If installing a new expansion card, unpack it and prepare the card for installation.

i NOTE: For instructions, see the documentation accompanying the card.

Steps

1. Pull and lift up the expansion card retention latch lock to open.
2. If installed, remove the filler bracket.

i NOTE: Store the filler bracket for future use. Filler brackets must be installed in empty expansion card slots to maintain Federal Communications Commission (FCC) certification of the system. The brackets also keep dust and dirt out of the system and aid in proper cooling and airflow inside the system.

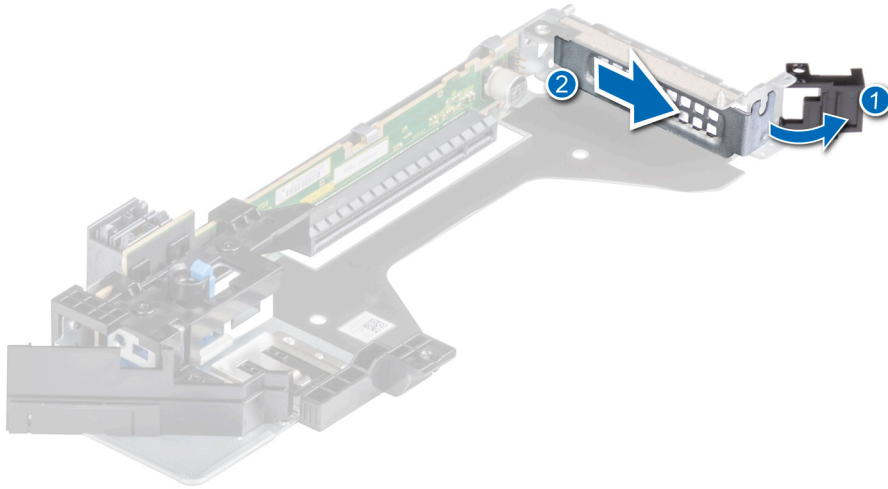

Figure 95. Removing the filler bracket

3. Hold the card by its edges, and align the card edge connector with the expansion card connector on the riser.
4. Insert the card edge connector firmly into the expansion card connector until the card is fully seated.
5. Close the expansion card retention latch.

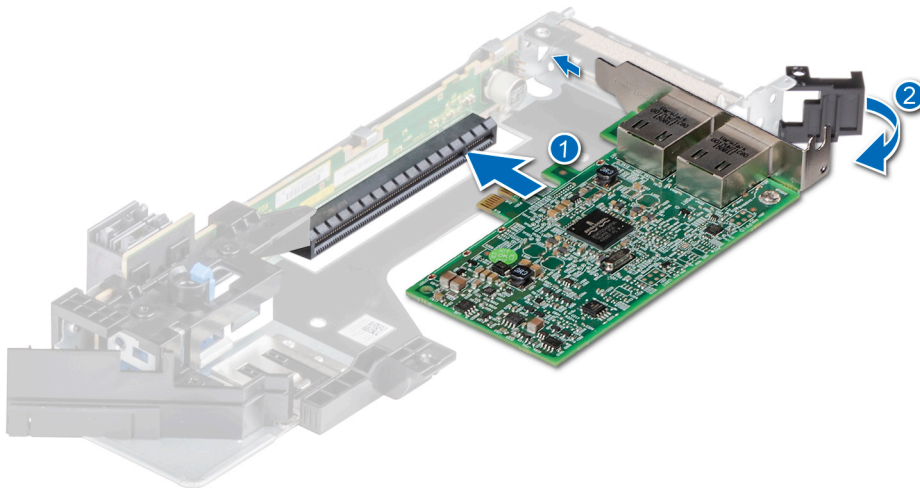

Figure 96. Installing expansion card into the expansion card riser

i **NOTE:** Push the black card holder to hold the card in the riser.

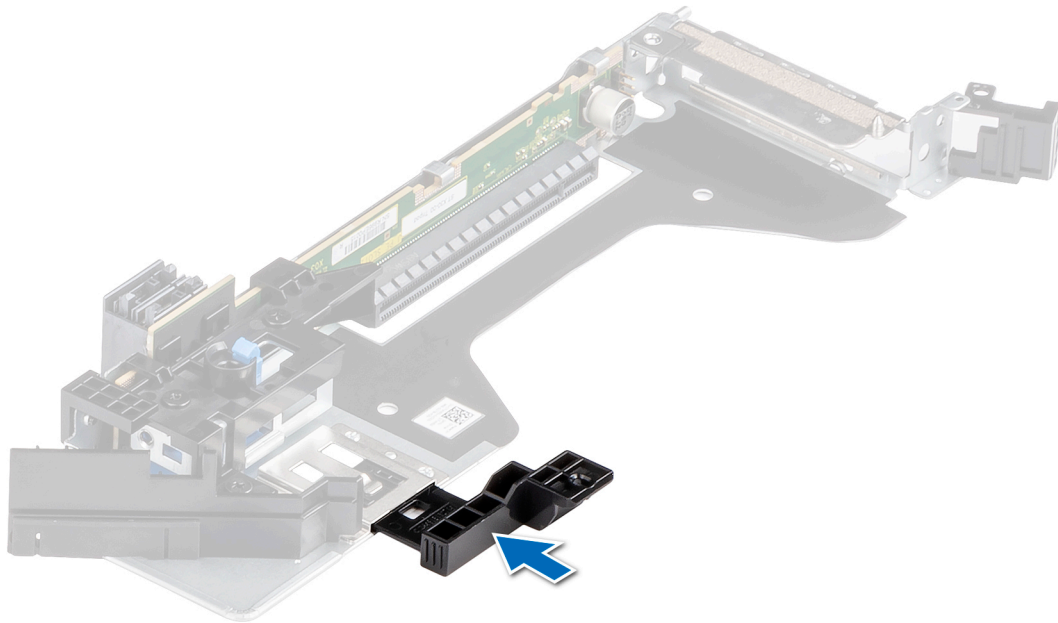

Figure 97. Closing the card holder on the expansion card riser

Next steps

1. If applicable, connect the cables to the expansion card.
2. Follow the procedure listed in [After working inside your system](#).
3. Install any device drivers required for the card as described in the documentation for the card.

Optional serial COM port

Removing the serial COM port

Prerequisites

1. Follow the safety guidelines listed in the [Safety instructions](#).
2. Follow the procedure listed in the [Before working inside your system](#).

Steps

1. [Lift the expansion card riser](#) and disconnect the serial COM port cable from the connector on the rear I/O board.
2. Open the latch on the expansion card riser and slide the serial COM port out of the expansion card riser.

i **NOTE:** The numbers on the image do not depict the exact steps. The numbers are for representation of sequence.

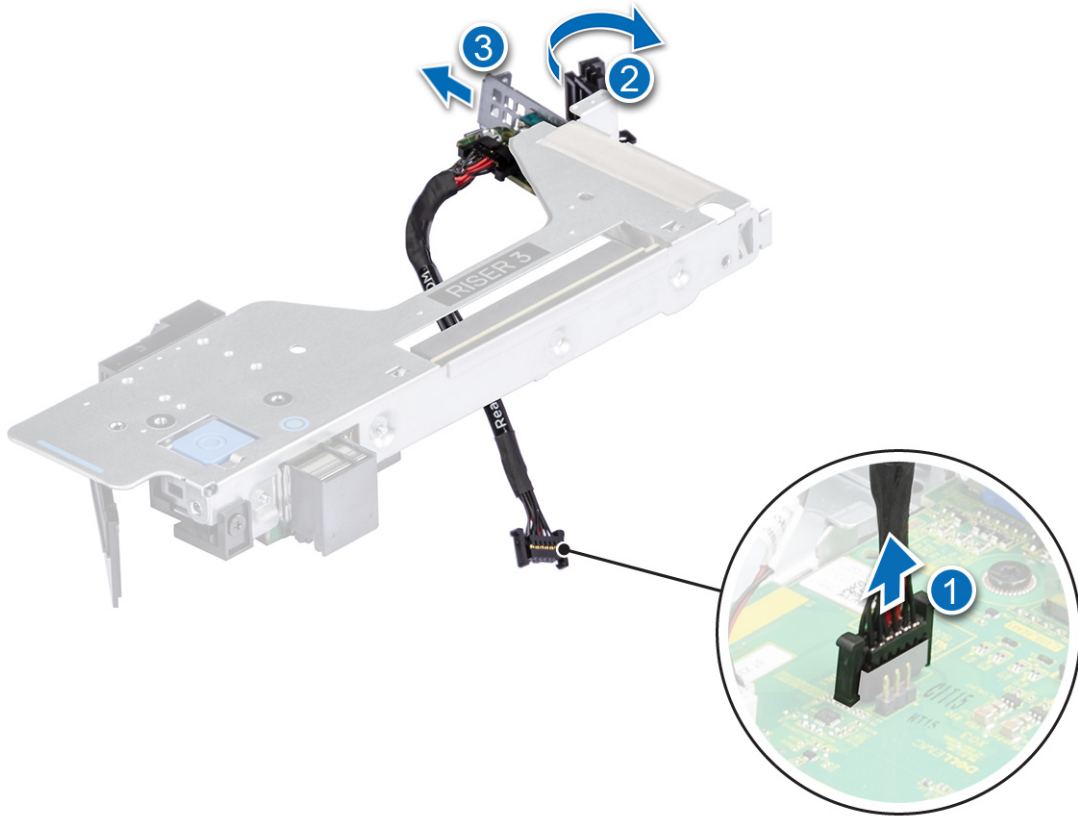

Figure 98. Removing the serial COM port

Next steps

1. [Replace the serial COM port.](#)

Installing the serial COM port

Prerequisites

1. Follow the safety guidelines listed in the [Safety instructions](#).
2. Follow the procedure listed in [Before working inside your system](#).
3. [Lift the expansion card riser](#) and disconnect the serial COM port cable from the connector on the rear I/O board.

Steps

1. Open the latch on the expansion card riser and remove the filler bracket from the expansion card riser (Riser 3).

NOTE: For more information about how to remove the filler bracket, see the [Removing the expansion card from the expansion card riser](#) topic.

2. Slide the serial COM port into the expansion card riser.
3. Connect the serial COM port cable to the serial port.
4. Connect the serial COM port cable to the connector on the rear I/O board.

NOTE: The numbers on the image do not depict the exact steps. The numbers are for representation of sequence.

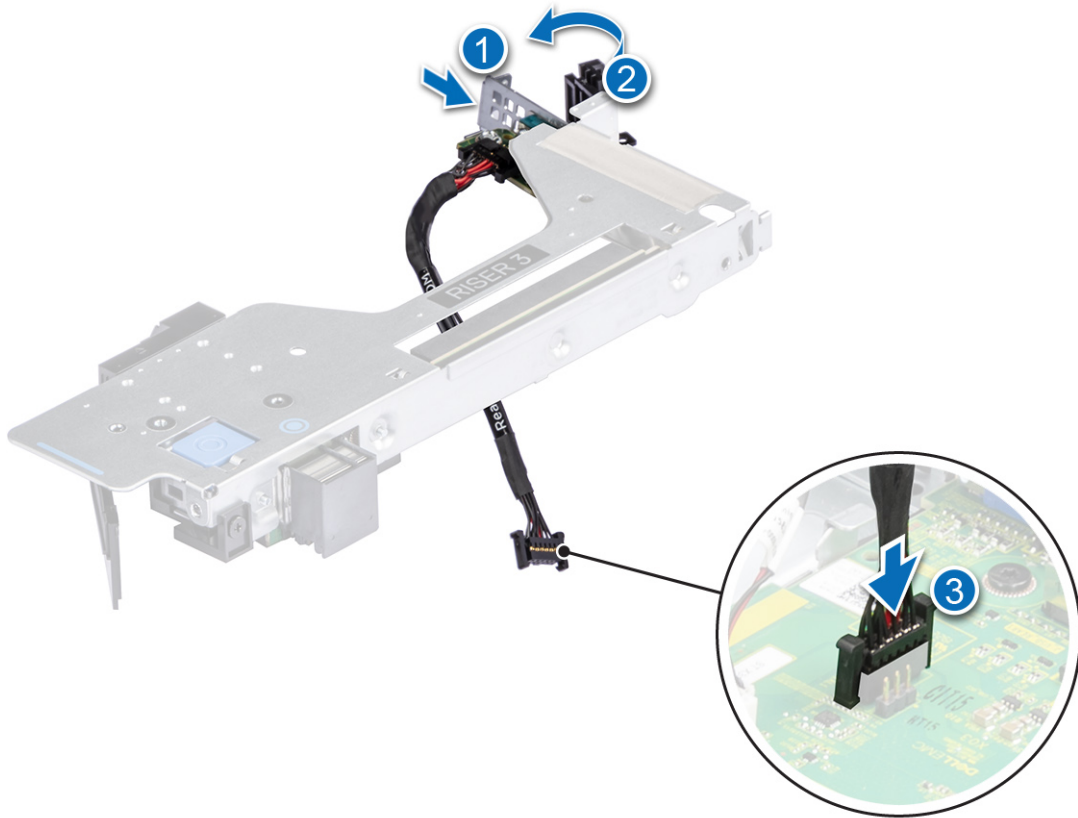

Figure 99. Installing the serial COM port

Next steps

1. [Install the expansion card riser.](#)
2. Follow the procedure listed in [After working inside your system.](#)

Optional IDSDM module

Removing the IDSDM module

Prerequisites

1. Follow the safety guidelines listed in the [Safety instructions.](#)
2. Follow the procedure listed in the [Before working inside your system.](#)
3. If you are replacing the IDSDM module, [remove the MicroSD cards.](#)

i **NOTE:** Temporarily label each SD card with its corresponding slot number before removal. Reinstall the SD cards into the corresponding slots.

Steps

Holding the blue pull tab, lift the IDSDM module out of the system.

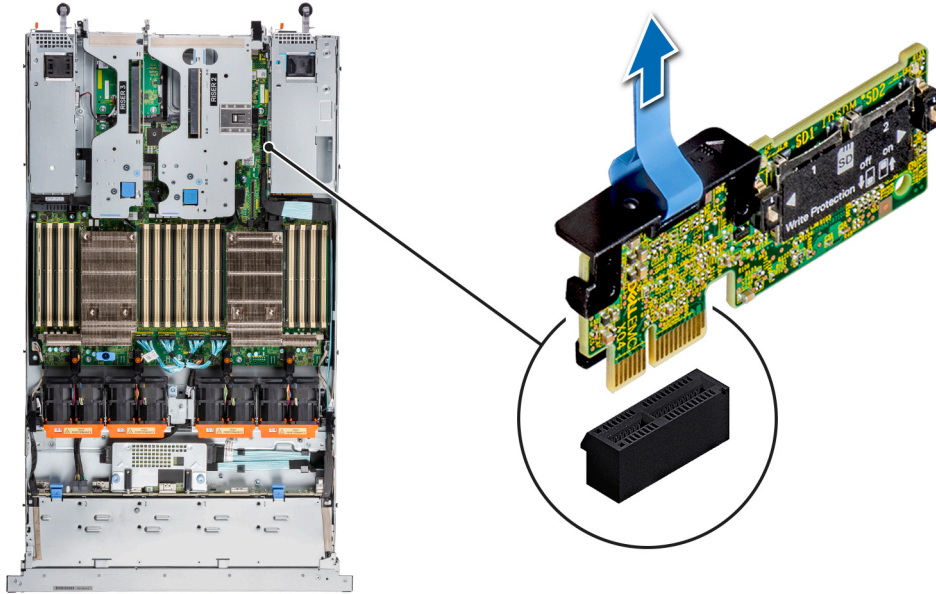

Figure 100. Removing the IDSDM module

Next steps

1. [Replace the IDSDM module.](#)

Installing the IDSDM module

Prerequisites

1. Follow the safety guidelines listed in the [Safety instructions](#).
2. Follow the procedure listed in [Before working inside your system](#).

Steps

1. Locate the IDSDM connector on the system board.
To locate IDSDM module, see the [System board jumpers and connectors](#) section.
2. Align IDSDM module with the connector on the system board.
3. Press the IDSDM module until it is firmly seated in the connector on the system board.

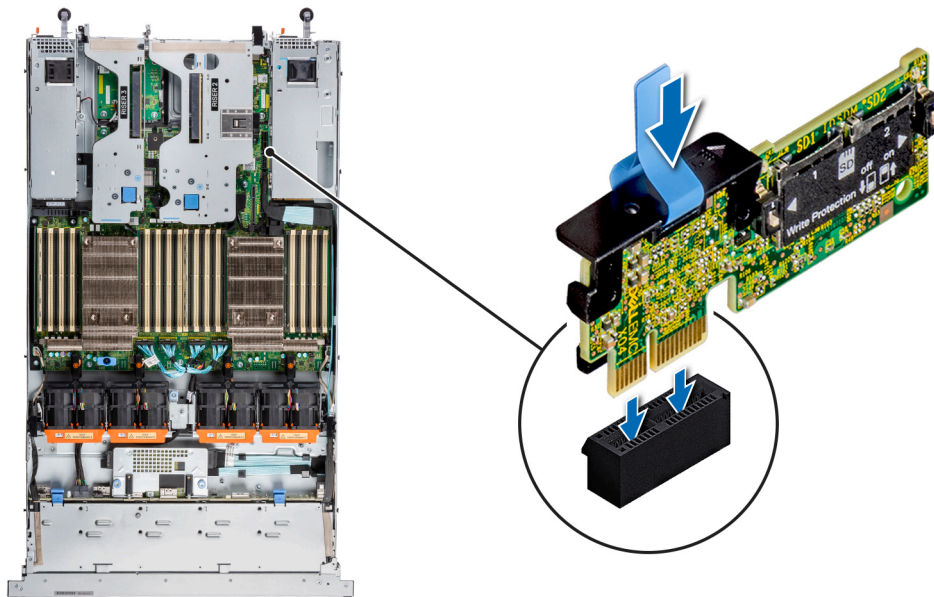

Figure 101. Installing the IDSDM module

Next steps

1. [Install the MicroSD cards.](#)

NOTE: Reinstall the MicroSD cards into the same slots based on the labels you had marked on the cards during removal.

2. Follow the procedure listed in [After working inside your system.](#)

MicroSD card

Removing the MicroSD card

Prerequisites

1. Follow the safety guidelines listed in the [Safety instructions.](#)
2. Follow the procedure listed in the [Before working inside your system.](#)
3. [Remove the IDSDM module.](#)

Steps

1. Locate the MicroSD card slot on the IDSDM module, and press the card to partially release it from the slot. For more information about the slot location, see [System board jumpers and connectors](#) section.
2. Hold the MicroSD card, and remove it from the slot.

NOTE: Temporarily label each MicroSD card with the corresponding slot number after removal.

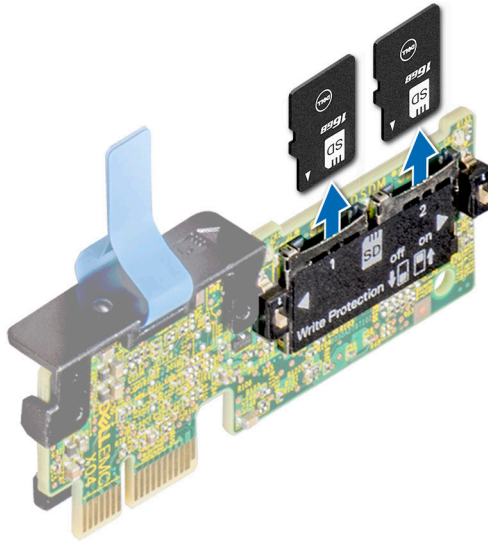

Figure 102. Removing the MicroSD card

Next steps

1. [Replace the MicroSD cards.](#)

Installing the MicroSD card

Prerequisites

1. Follow the safety guidelines listed in the [Safety instructions](#).
2. Follow the procedure listed in [Before working inside your system](#).

NOTE: To use an MicroSD card with your system, ensure that the **Internal SD Card Port** is enabled in System Setup.

NOTE: Ensure that you install the MicroSD cards into the same slots based on the labels you had marked on the cards during removal.

Steps

1. Locate the MicroSD card slot on the IDSDM module. Orient the MicroSD card appropriately and insert the contact-pin end of the card into the slot. To locate IDSDM, see the [System board jumpers and connectors](#) section.

NOTE: The slot is keyed to ensure correct insertion of the card.

2. Press the card into the slot to lock it into place.

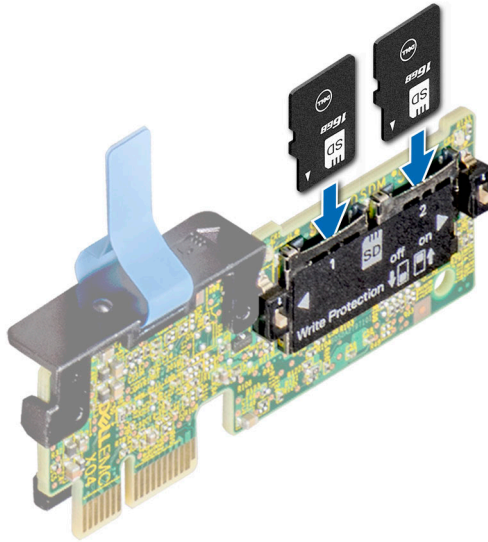

Figure 103. Installing the MicroSD card

Next steps

1. [Install the IDSDM module.](#)
2. Follow the procedure listed in [After working inside your system.](#)

M.2 SSD module on BOSS-S1 adapter card

Removing the M.2 SSD module

Prerequisites

1. Follow the safety guidelines listed in the [Safety instructions.](#)
2. Follow the procedure listed in the [Before working inside your system.](#)
3. Remove the BOSS card. The BOSS card removal is similar to [removing expansion card from the expansion card riser.](#)

Steps

1. Using the Phillips #1 screwdriver, remove the screws securing the M.2 SSD module to the BOSS card.
2. Pull the M.2 SSD module to disconnect from the BOSS card connector.

NOTE: The numbers on the image do not depict the exact steps. The numbers are for representation of sequence.

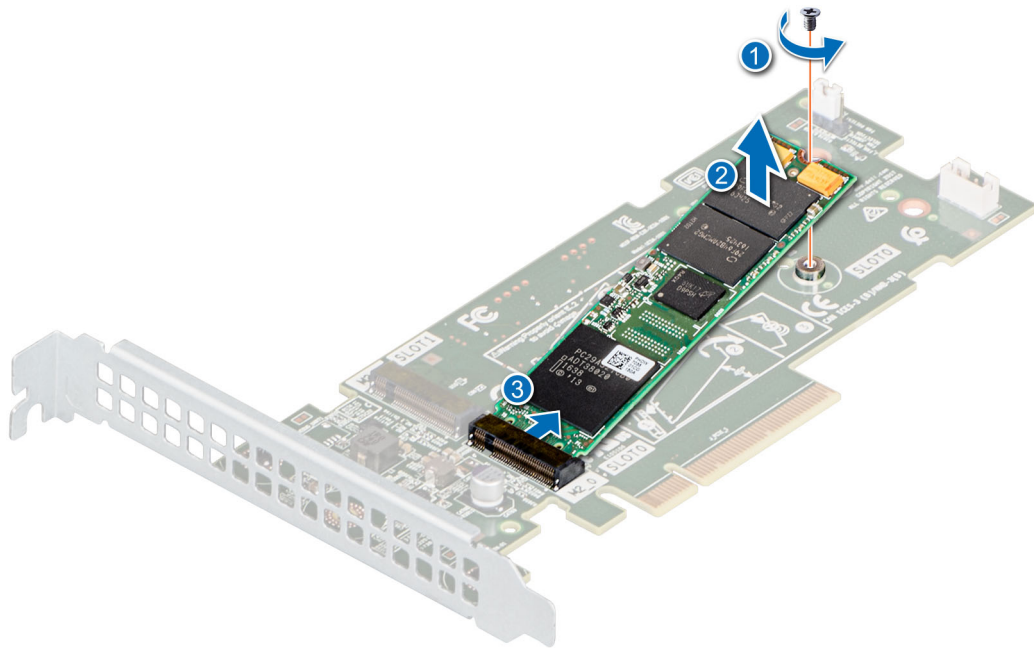

Figure 104. Removing the M.2 SSD module

Next steps

1. [Replace the M.2 SSD module.](#)

Installing the M.2 SSD module

Prerequisites

1. Follow the safety guidelines listed in the [Safety instructions](#).
2. Follow the procedure listed in the [Before working inside your system](#).
3. Remove the BOSS card. Removing BOSS card is similar to [removing expansion card from the expansion card riser](#).

Steps

1. Align the M.2 SSD module at an angle with the BOSS card connector.
2. Insert the M.2 SSD module until it is firmly seated in the BOSS card connector.
3. Using the Phillips #1 screwdriver, secure the M.2 SSD module on the BOSS card with the screw.

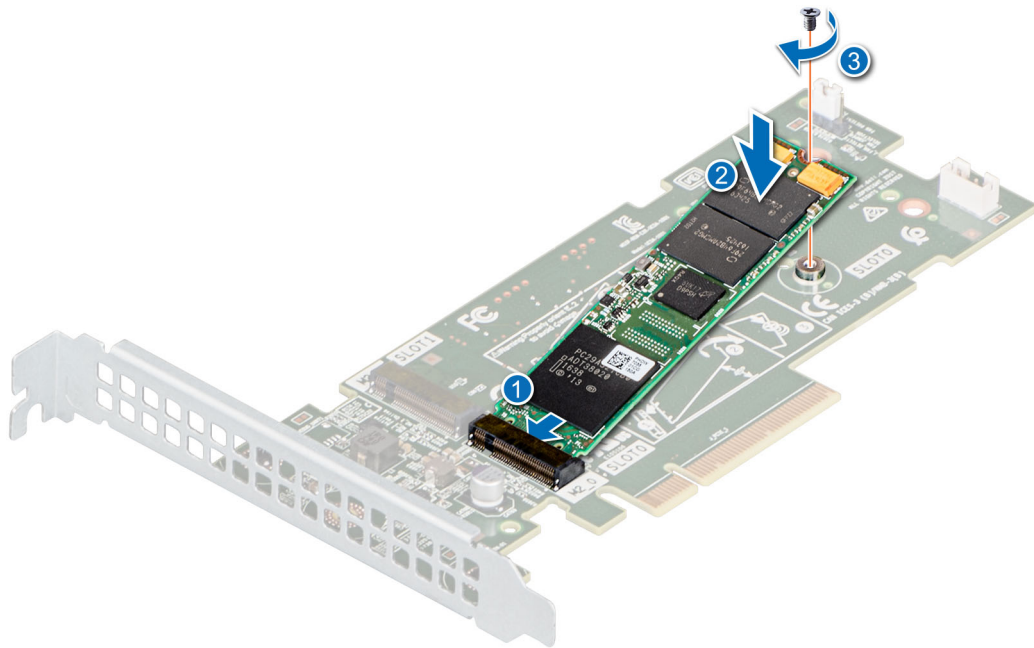

Figure 105. Installing the M.2 SSD module

Next steps

1. Install the BOSS card. Installing the BOSS is similar to [installing expansion card into the expansion card riser](#).
2. Follow the procedure listed in the [After working inside your system](#).

BOSS S2 card (optional)

Removing the BOSS card filler

Prerequisites

Follow the safety guidelines listed in the [Safety instructions](#).

Steps

Press and pull the BOSS card filler out from the BOSS module bay.

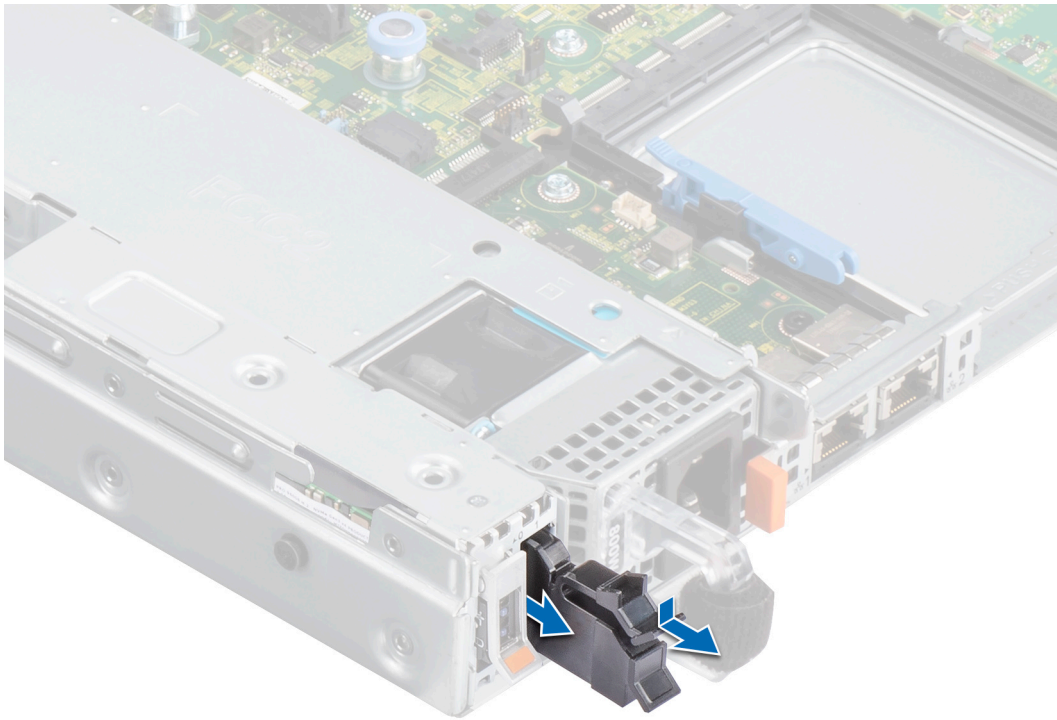

Figure 106. Removing the BOSS card filler

Next steps

1. [Replace the BOSS S2 controller card module](#) or [install the BOSS card filler](#).

Installing the BOSS card filler

Prerequisites

1. Follow the safety guidelines listed in the [Safety instructions](#).

Steps

Align the BOSS card filler with the BOSS module bay and push it into the bay until it clicks into place.

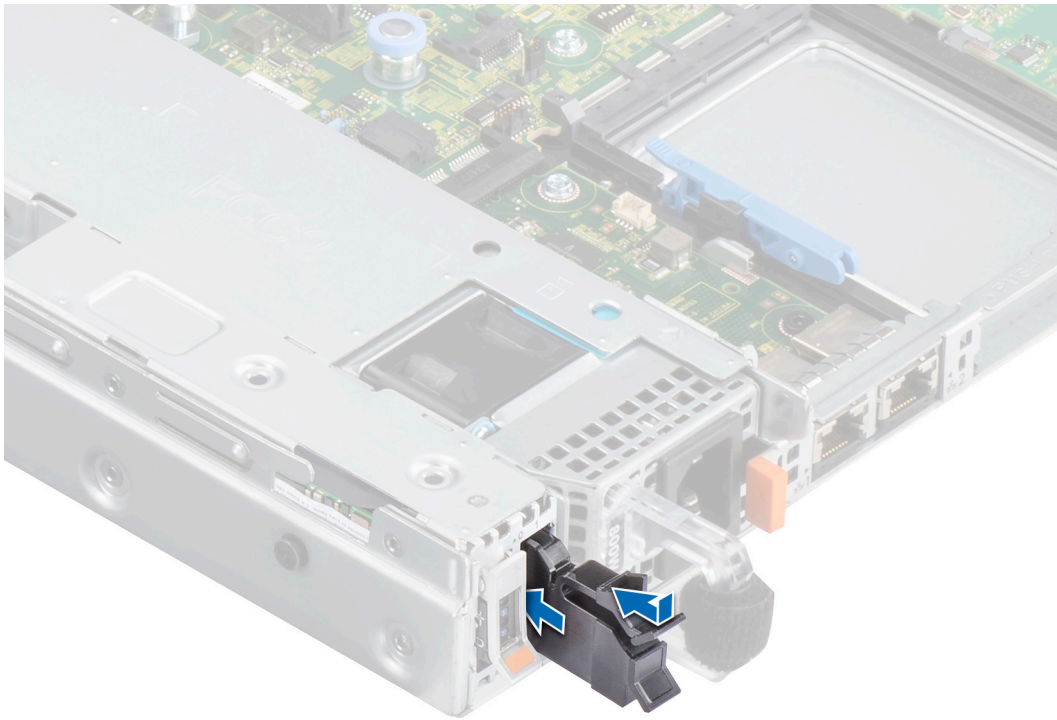

Figure 107. Installing the BOSS card filler

Removing the BOSS S2 controller card module

Prerequisites

1. Follow the safety guidelines listed in the [Safety instructions](#).
2. Follow the procedure listed in the [Before working inside your system](#).

Steps

1. Lift the retention latch to release the BOSS S2 card carrier.
2. Slide the BOSS S2 card carrier out from the BOSS S2 controller card module.

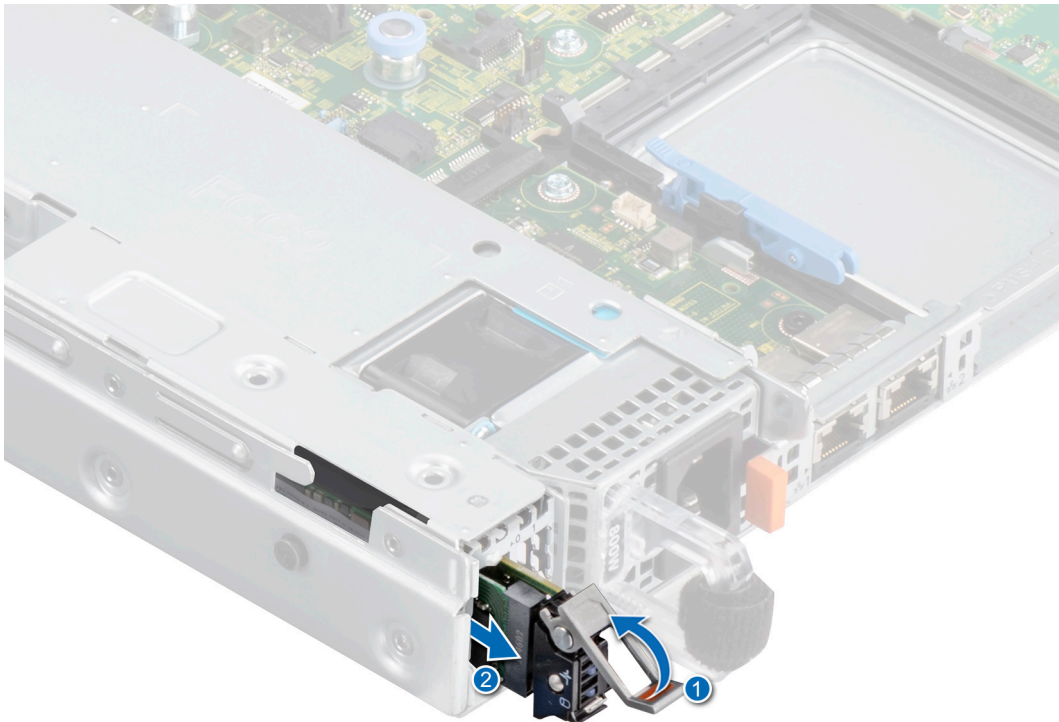

Figure 108. Removing the BOSS S2 card carrier

3. Using the Phillips #1 screwdriver remove the M3 x 0.5 x 4.5 mm screw that secures the M.2 SSD to the BOSS S2 card carrier.
4. Slide the M.2 SSD out and up from the BOSS S2 card carrier.

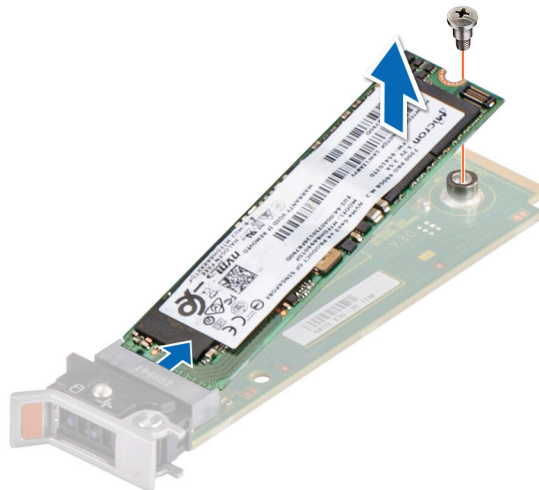

Figure 109. Removing the M.2 SSD

5. Disconnect the BOSS power cable and BOSS signal cable from the system board. Using the Phillips #1 screwdriver remove the two M3 x 0.5 x 4.5 mm screws that secure the BOSS S2 controller card module on the BOSS module bay. Slide the BOSS S2 controller card module out from the BOSS module bay.

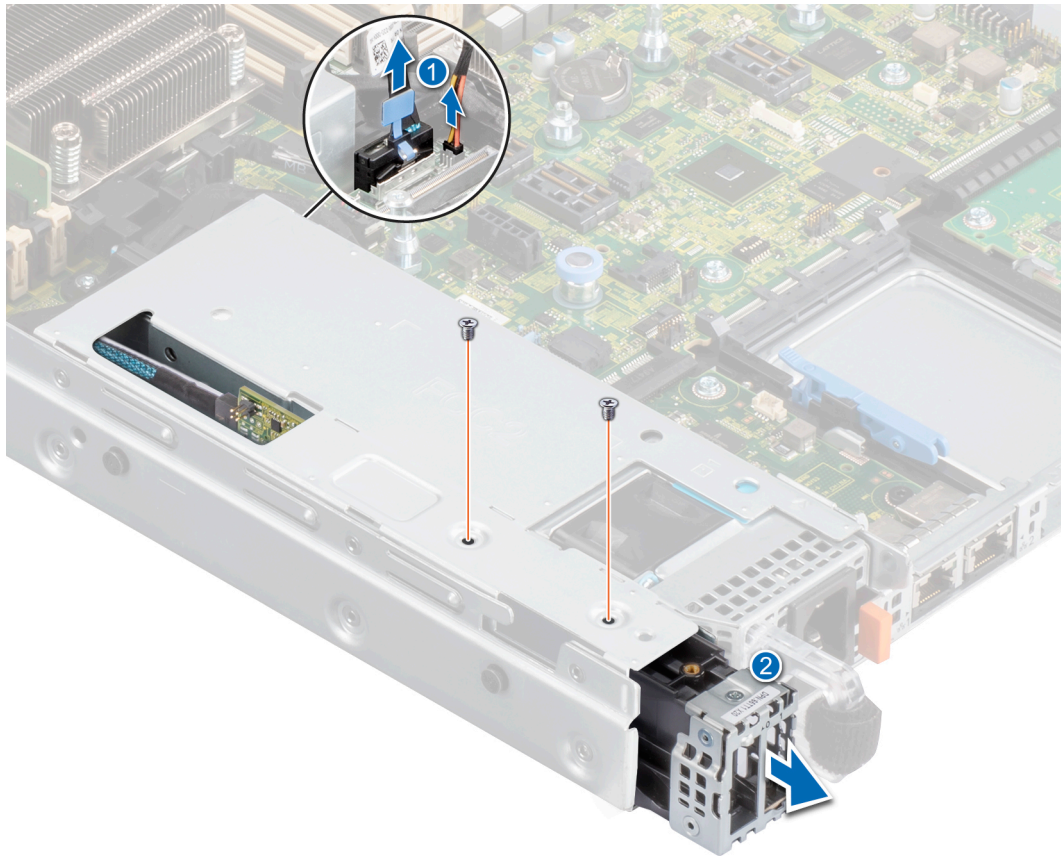

Figure 110. Removing the BOSS S2 controller card module

6. Remove the BOSS power cable and BOSS signal cable from the BOSS S2 controller card module.

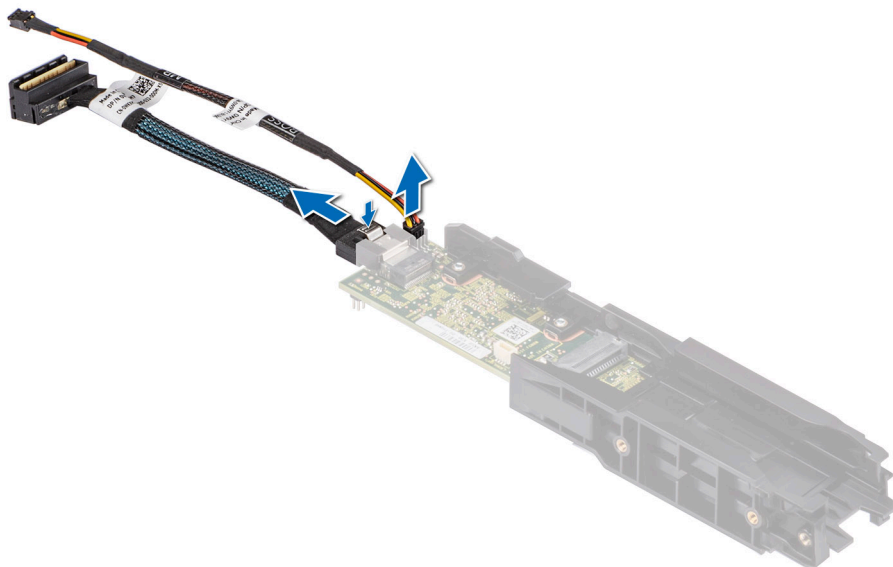

Figure 111. Removing the BOSS power cable and BOSS signal cable from the BOSS S2 controller card module

7. Using the Phillips #1 screwdriver, remove the M3 x 0.5 x 4.5 mm screw that secures the BOSS cover on the BOSS S2 controller card module. Slide the BOSS cover out from the BOSS S2 controller card module.

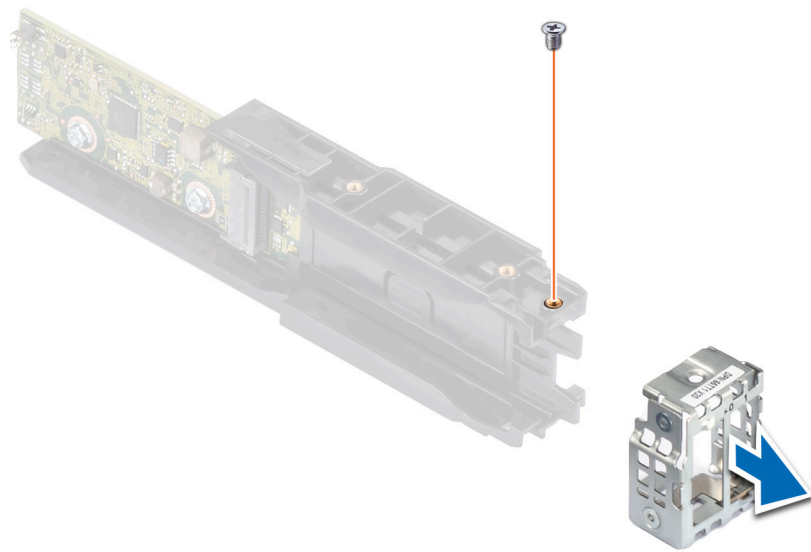

Figure 112. Removing the BOSS cover

Next steps

1. [Replace the BOSS S2 controller card module.](#)

Installing the BOSS S2 controller card

Prerequisites

1. Follow the safety guidelines listed in the [Safety instructions](#).
2. Follow the procedure listed in the [Before working inside your system](#).

Steps

1. Slide the BOSS cover on the BOSS S2 controller card module. Using the Phillips #1 screwdriver, secure the BOSS cover on the BOSS S2 controller card module with the M3 x 0.5 x 4.5 mm screw.

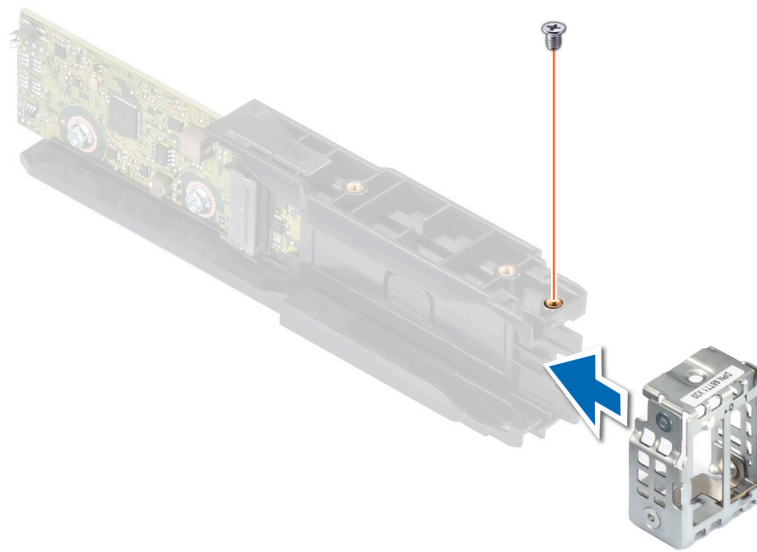

Figure 113. Installing the BOSS cover

2. Connect the BOSS power cable and BOSS signal cable to the BOSS S2 controller card module.

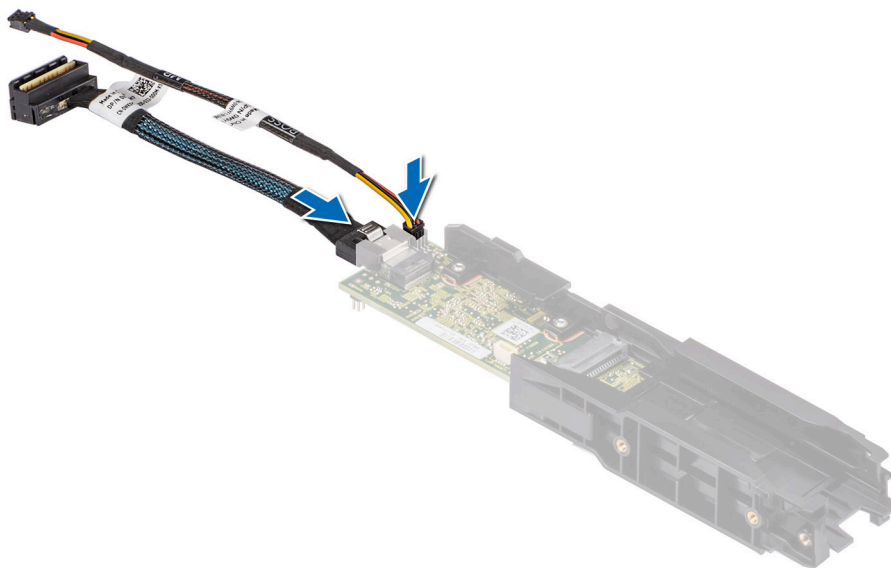

Figure 114. Connecting the BOSS power cable and BOSS Signal cable to the BOSS S2 controller card module

3. Slide the BOSS S2 controller card module into the BOSS module bay until it is firmly seated.
4. Using the Phillips #1 screwdriver, secure the BOSS S2 controller card module on the BOSS module bay with the two M3 x 0.5 x 4.5 mm screws. Connect the BOSS power cable and the BOSS signal cable to the system board.

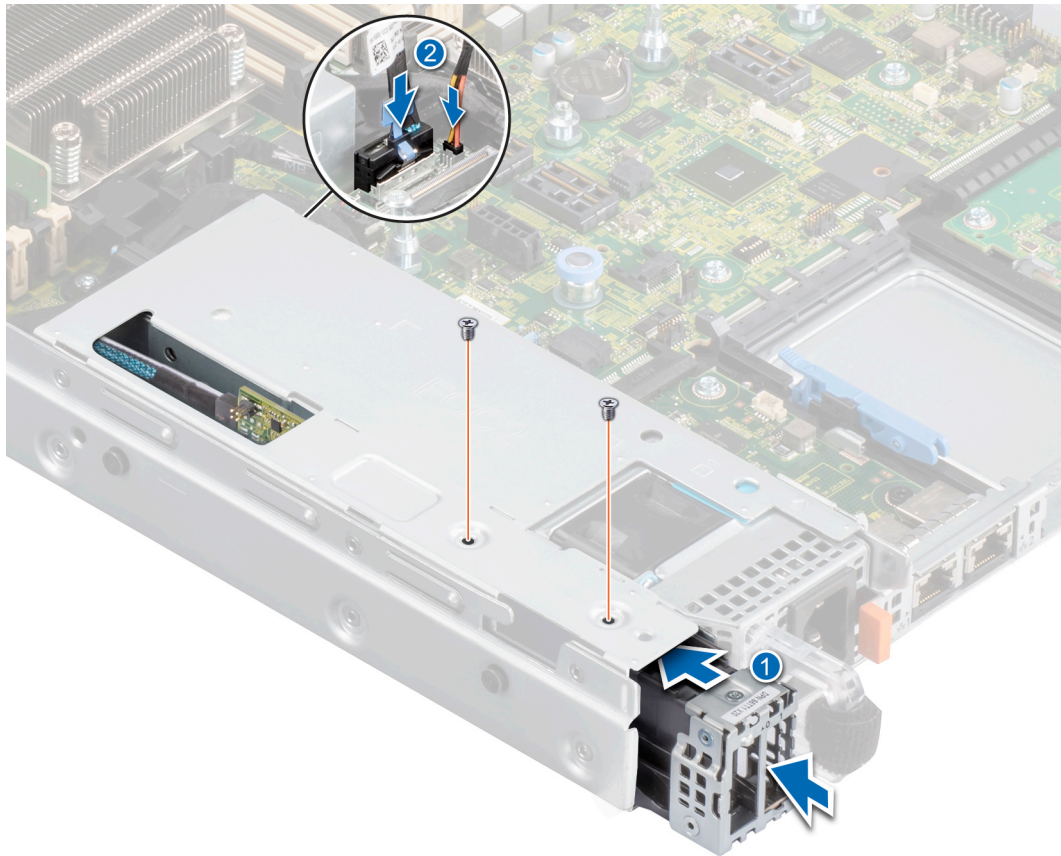

Figure 115. Installing the BOSS S2 controller card module

5. Align the M.2 SSD at an angle with the BOSS S2 card carrier.
6. Insert the M.2 SSD until it is firmly seated in the BOSS S2 card carrier.
7. Using the Phillips #1 screwdriver, secure the M.2 SSD on the BOSS S2 card carrier with the M3 x 0.5 x 4.5 mm screw.

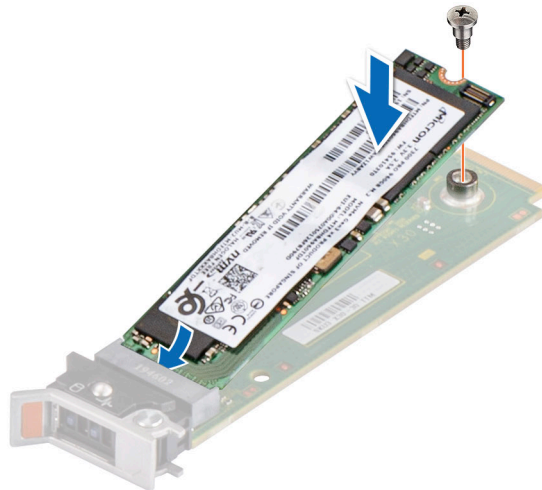

Figure 116. Installing the M.2 SSD

8. Slide the BOSS S2 card carrier into the BOSS S2 controller card module slot.
9. Close the BOSS S2 card carrier release latch to lock the carrier in place.

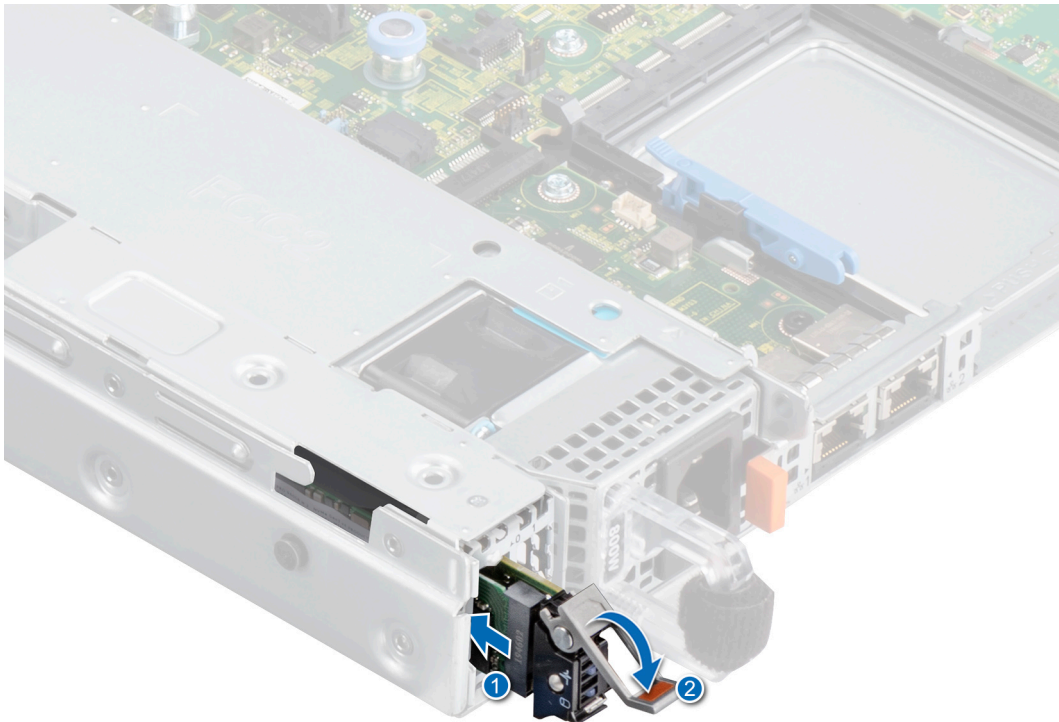

Figure 117. Installing the BOSS S2 card carrier

Next steps

1. Follow the procedure listed in the [After working inside your system](#).

System battery

Replacing the system battery

Prerequisites

⚠ WARNING: There is a danger of a new battery exploding if it is incorrectly installed. Replace the battery only with the same or equivalent type That is recommended by the manufacturer. Discard used batteries according to the manufacturer's instructions. See the Safety instructions. that came with your system for more information.

1. Follow the safety guidelines listed in the [Safety instructions](#).
2. Follow the procedure listed in the [Before working inside your system](#).
3. If applicable, disconnect the power or data cables from the expansion cards.
4. [Remove the expansion card risers](#).

Steps

1. To remove the battery:
 - a. Use a plastic scribe to pry out the system battery.

⚠ CAUTION: To avoid damage to the battery connector, you must firmly support the connector while installing or removing a battery.

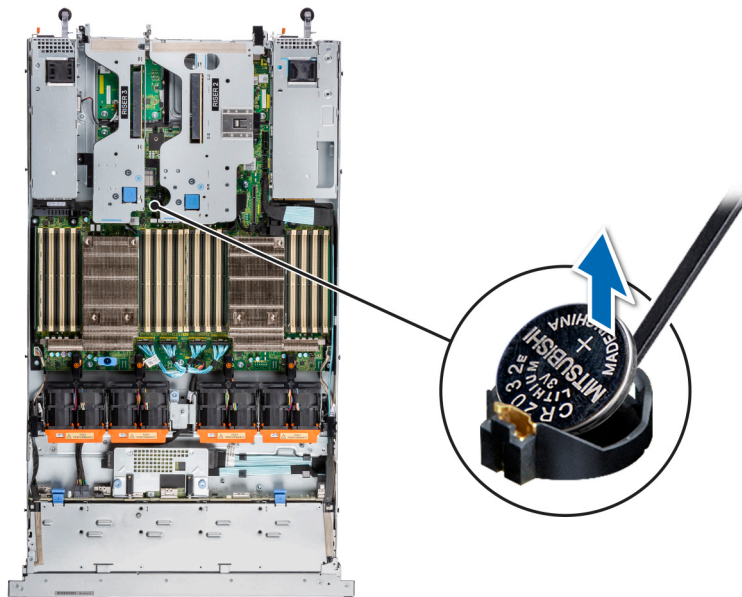

Figure 118. Removing the system battery

2. To install a new system battery:
 - a. Hold the battery with the positive side facing up and slide it under the securing tabs.
 - b. Press the battery into the connector until it snaps into place.

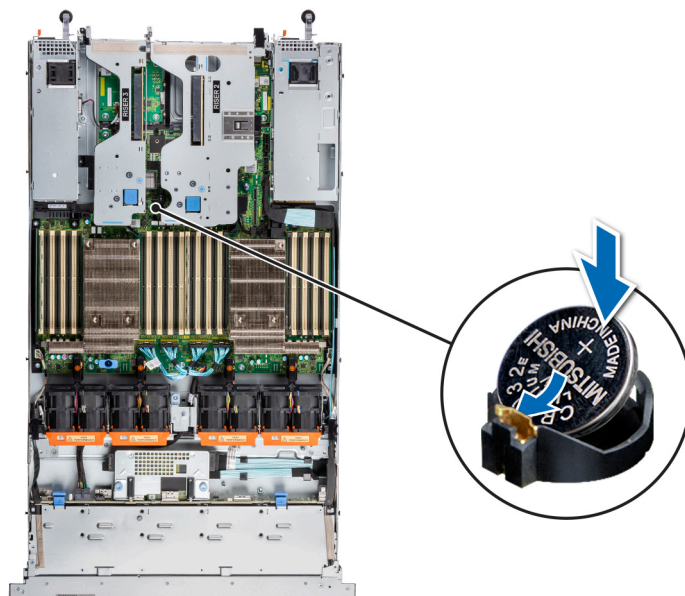

Figure 119. Installing the system battery

Next steps

1. [Install the expansion card risers.](#)
2. If applicable, connect the cables to one or more expansion cards.
3. Follow the procedure listed in [After working inside your system.](#)
4. Confirm that the battery is operating properly, by performing the following steps:
 - a. Enter the System Setup, while booting, by pressing F2.
 - b. Enter the correct time and date in the System Setup **Time** and **Date** fields.
 - c. **Exit** the System Setup.

- d. To test the newly installed battery, remove the system from the enclosure for at least an hour.
- e. Reinstall the system into the enclosure after an hour.
- f. Enter the System Setup and if the time and date are still incorrect, see Getting help section.

Optional internal USB card

NOTE: To locate the internal USB port on the system board, see the [System board jumpers and connectors](#) section.

Removing the internal USB card

Prerequisites

CAUTION: To avoid interference with other components in the server, the maximum permissible dimensions of the USB memory key are 15.9 mm wide x 57.15 mm long x 7.9 mm high.

1. Follow the safety guidelines listed in the [Safety instructions](#).
2. Follow the procedure listed in the [Before working inside your system](#).
3. [Remove the expansion card risers](#).

Steps

1. Holding the blue tag, lift the internal USB card to disconnect from the connector on the system board.
2. Remove the USB memory key from the internal USB card.

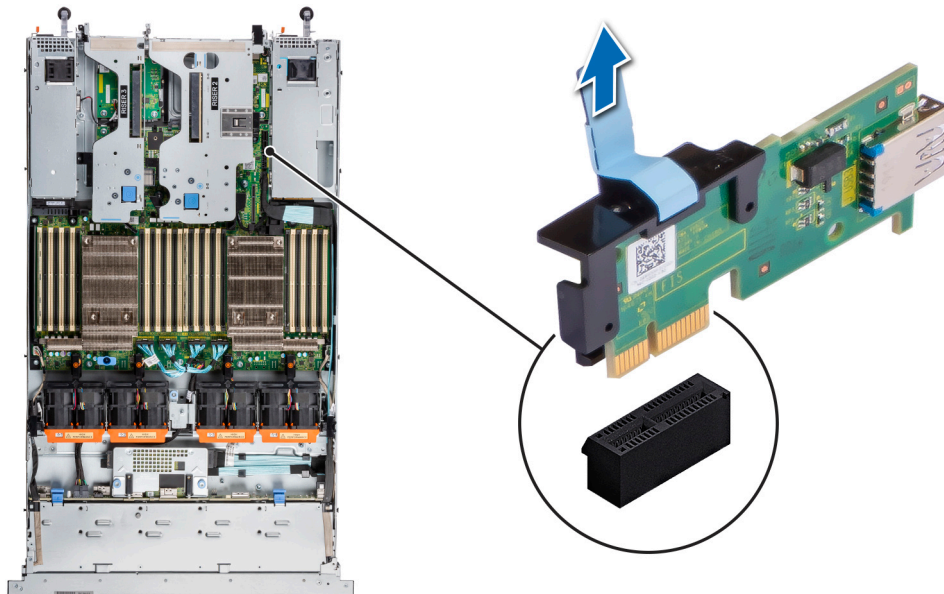

Figure 120. Removing the internal USB card

Next steps

1. [Replace the internal USB card](#).

Installing the internal USB card

Prerequisites

1. Follow the safety guidelines listed in the [Safety instructions](#).
2. Follow the procedure listed in [Before working inside your system](#).

3. [Remove the expansion card risers.](#)

Steps

1. Connect the USB key to the internal USB card.
2. Align the internal USB card with the connector on the system board and press firmly until the internal USB card is seated.

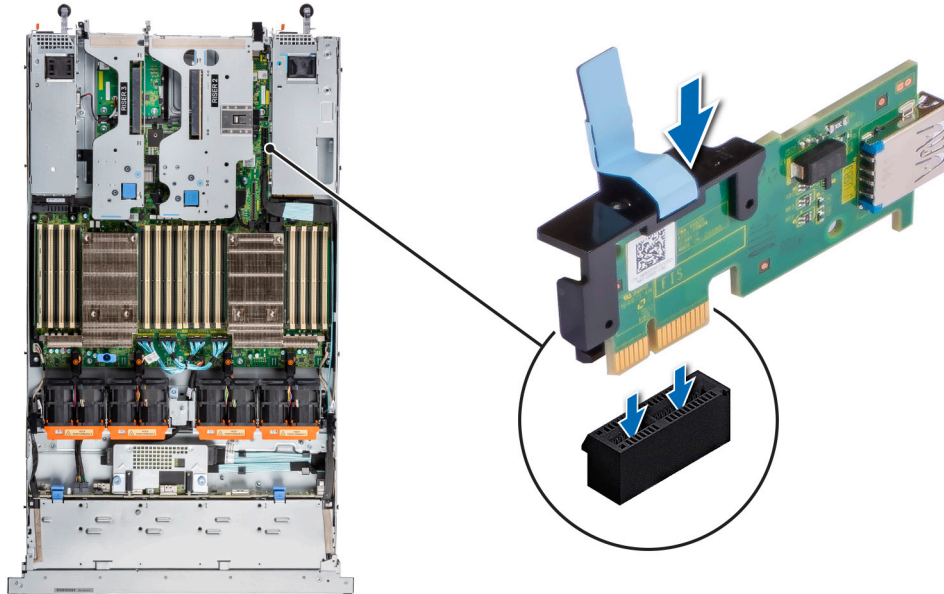

Figure 121. Installing the internal USB card

Next steps

1. [Install the expansion card risers.](#)
2. Follow the procedure listed in [After working inside your system.](#)
3. While booting, press F2 to enter **System Setup** and verify that the system detects the USB memory key.

Intrusion switch module

Removing the intrusion switch module

Prerequisites

1. Follow the safety guidelines listed in the [Safety instructions.](#)
2. Follow the procedure listed in the [Before working inside your system.](#)
3. [Remove the expansion card riser.](#)

i **NOTE:** Ensure that you note the routing of the cables as you remove them from the system board. Route the cable properly when you replace it to prevent the cable from being pinched or crimped

Steps

1. Disconnect the intrusion switch cable from the connector on the rear I/O board.
2. Using a Phillips #2 screwdriver, loosen the screw on the intrusion switch module.
3. Slide the intrusion switch module out of the slot on the system.

i **NOTE:** The numbers on the image do not depict the exact steps. The numbers are for representation of sequence.

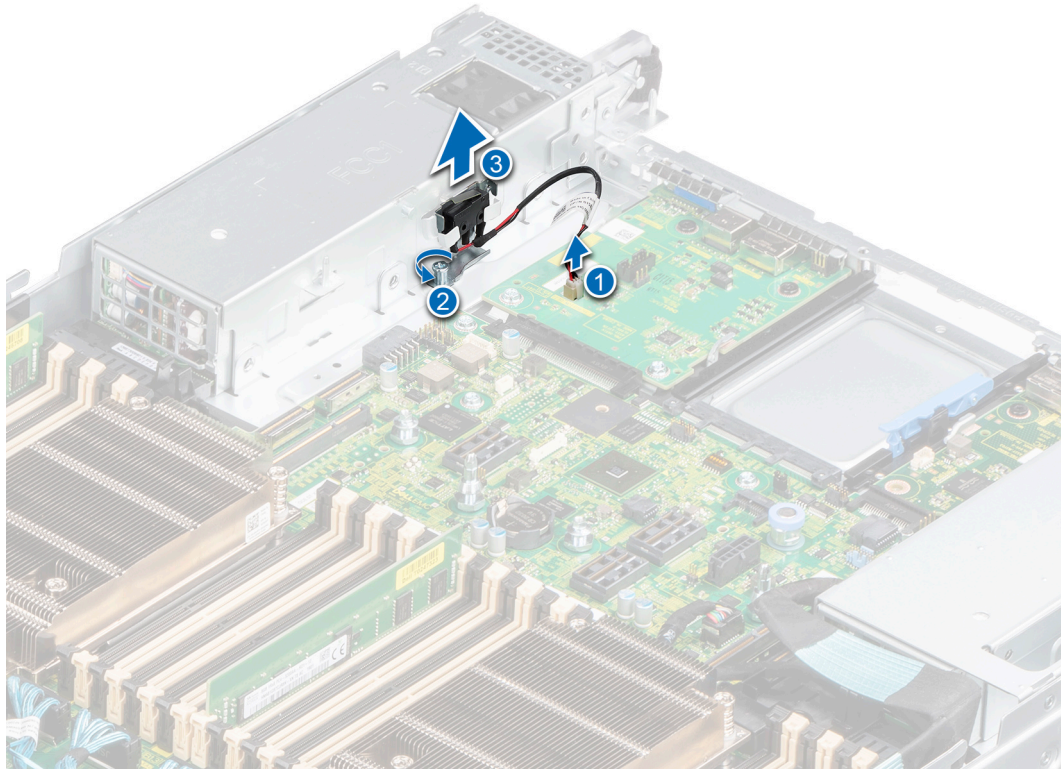

Figure 122. Removing the intrusion switch module

Next steps

1. [Replace the intrusion switch module.](#)

Installing the intrusion switch module

Prerequisites

1. Follow the safety guidelines listed in the [Safety instructions](#).
2. Follow the procedure listed in [Before working inside your system](#).
3. [Remove the expansion card riser](#).

i **NOTE:** Ensure that you note the routing of the cables as you remove them from the system board. Route the cable properly when you replace it to prevent the cable from being pinched or crimped

Steps

1. Align the guides on the intrusion switch module with the standoffs on the system.
2. Slide the intrusion switch module into the slot in the system until firmly seated.
3. Using a Phillips #2 screwdriver, tighten the screw on the intrusion switch module.
4. Connect the intrusion switch cable to the connector on the rear I/O board.

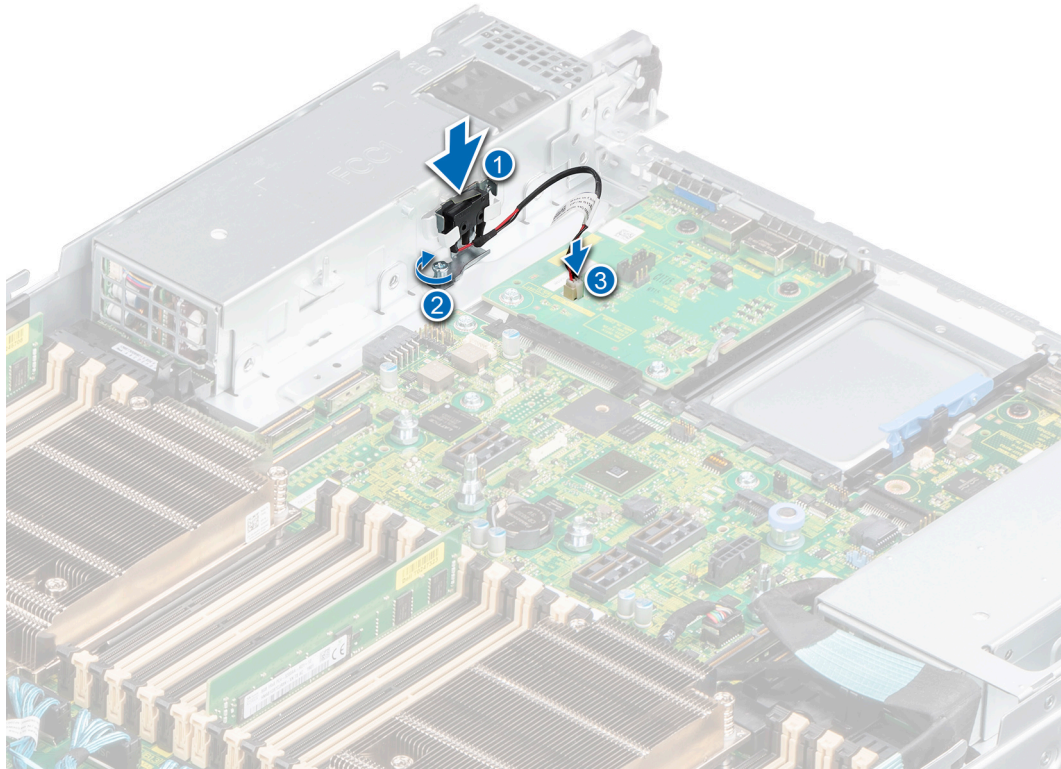

Figure 123. Installing the intrusion switch module

Next steps

1. [Install the expansion card riser.](#)
2. Follow the procedure listed in [After working inside your system.](#)

Optional OCP card

Removing the OCP card

Prerequisites

1. Follow the safety guidelines listed in the [Safety instructions.](#)
2. Follow the procedure listed in the [Before working inside your system.](#)
3. [Remove the expansion card riser.](#)

Steps

1. Open the blue latch to unlock the OCP card.
2. Push the OCP card towards the rear end of the system to disconnect from the connector on the system board.
3. Slide the OCP card out of the slot on the system.

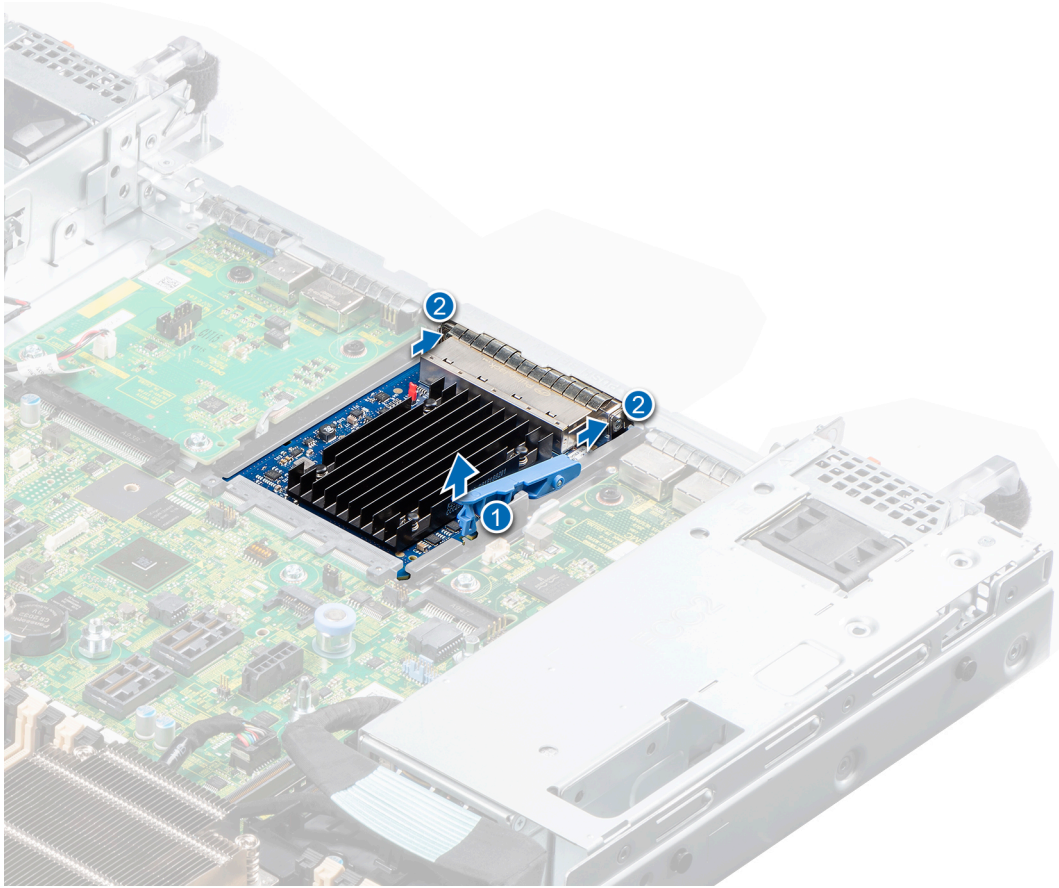

Figure 124. Removing the OCP card

Next steps

1. [Replace the OCP card.](#)

Installing the OCP card

Prerequisites

1. Follow the safety guidelines listed in the [Safety instructions](#).
2. Follow the procedure listed in the [Before working inside your system](#).
3. [Remove the expansion card riser.](#)

Steps

1. Open the blue latch on the system board.
2. Slide the OCP card into the slot in the system.
3. Push until the OCP card is connected to the connector on the system board.
4. Close the latch to lock the OCP card to the system.

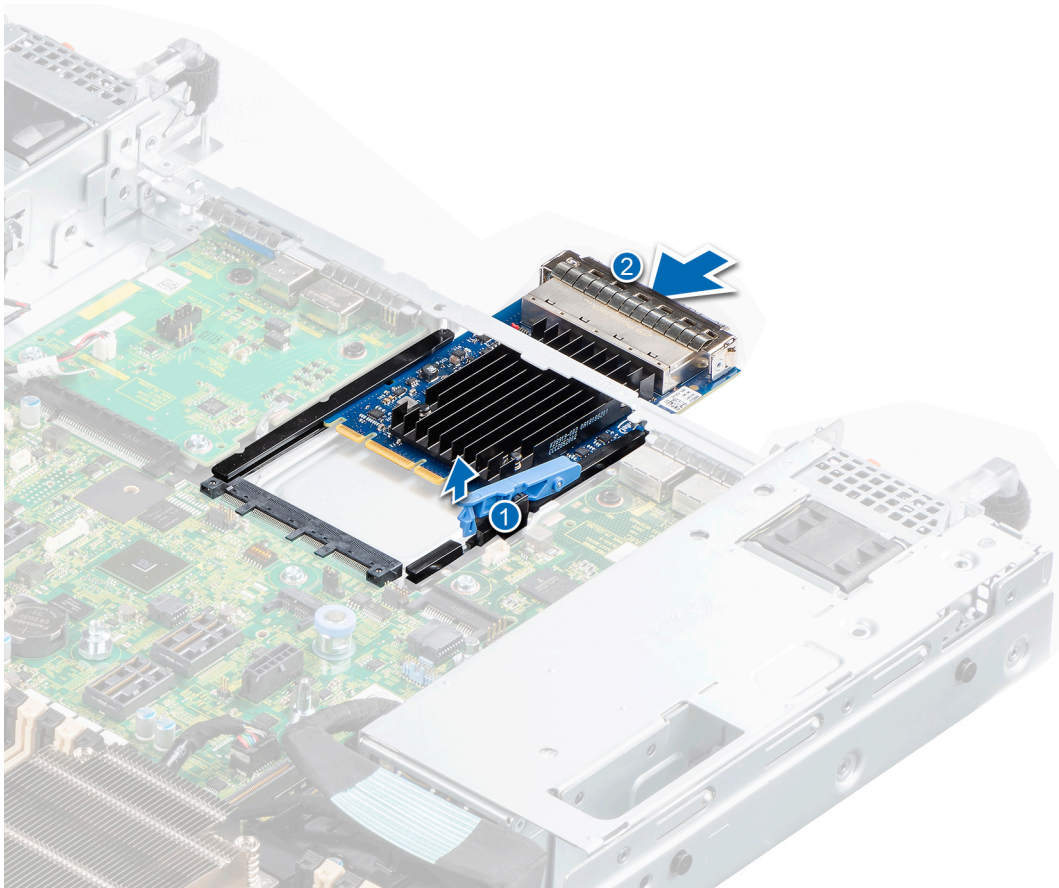

Figure 125. Installing the OCP card

Next steps

1. [Install the expansion card riser](#)
2. Follow the procedure listed in [After working inside your system](#).

Power supply unit

NOTE: While replacing the hot swappable PSU, after next server boot; the new PSU automatically updates to the same firmware and configuration of the replaced one. For more information about the Part replacement configuration, see the *Lifecycle Controller User's Guide* at <https://www.dell.com/idracmanuals>

NOTE: Ensure to install the latest iDRAC 4.4x version or any later versions to support the 1100 W Titanium Mixed Mode AC/HVDC PSU and (-48V) 1100 W DC PSU.

Hot spare feature

Your system supports the hot spare feature that significantly reduces the power overhead associated with power supply unit (PSU) redundancy.

When the hot spare feature is enabled, one of the redundant PSUs is switched to the sleep state. The active PSU supports 100 percent of the system load, thus operating at higher efficiency. The PSU in the sleep state monitors output voltage of the active PSU. If the output voltage of the active PSU drops, the PSU in the sleep state returns to an active output state.

If having both PSUs active is more efficient than having one PSU in the sleep state, the active PSU can also activate the sleeping PSU.

The default PSU settings are as follows:

- If the load on the active PSU is more than 50 percent of PSU rated power wattage, then the redundant PSU is switched to the active state.
- If the load on the active PSU falls below 20 percent of PSU rated power wattage, then the redundant PSU is switched to the sleep state.

You can configure the hot spare feature by using the iDRAC settings. For more information, see the *iDRAC User's Guide* available at www.dell.com/poweredge/manuals.

Removing a power supply unit blank

Prerequisites

Follow the safety guidelines listed in the [Safety instructions](#).

Steps

Pull the blank out of the system.

 **CAUTION:** To ensure proper system cooling, the PSU blank must be installed in the second PSU bay in a non-redundant configuration. Remove the PSU blank only if you are installing a second PSU.

Next steps

1. [Replace the PSU blank](#) or [PSU](#).

Installing a power supply unit blank

Prerequisites

1. Follow the safety guidelines listed in the [Safety instructions](#).
-  **NOTE:** Install the power supply unit (PSU) blank only in the second PSU bay.
2. [Remove the PSU](#).

Steps

Align the PSU blank with the PSU bay and push it into the PSU bay until it clicks into place.

Removing a power supply unit

Prerequisites

 **CAUTION:** The system requires one power supply unit (PSU) for normal operation. On power-redundant systems, remove and replace only one PSU at a time in a system that is powered on.

1. Follow the safety guidelines listed in the [Safety instructions](#).
2. Disconnect the power cable from the power outlet and from the PSU you intend to remove.
3. Remove the cable from the strap on the PSU handle.
4. Unlatch and lift or remove the optional cable management accessory if it interferes with the PSU removal.

For information about the cable management when the PSU is removed or installed while the system is in a rack, see the system's cable management arm documentation at <https://www.dell.com/poweredge/manuals>.

Steps

Press the release latch, and holding the PSU handle slide the PSU out of the PSU bay.

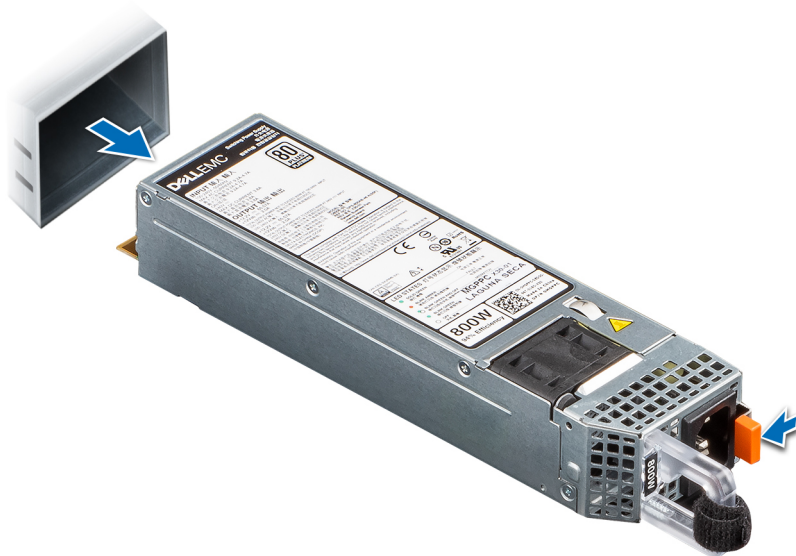

Figure 126. Removing a power supply unit

Next steps

1. Replace the PSU or install the PSU blank.

Installing a power supply unit

Prerequisites

1. Follow the safety guidelines listed in the [Safety instructions](#).
2. For systems that support redundant PSU, ensure that both the PSUs are of the same type and have the same maximum output power.

NOTE: The maximum output power (shown in watts) is listed on the PSU label.

3. Remove the PSU blank.

Steps

Slide the PSU into the PSU bay until the release latch snaps into place.



Figure 127. Installing a power supply unit

Next steps

1. If you have unlatched or removed the cable management accessory, re-install or relatch it. For information about the cable management when the PSU is removed or installed while the system is in the rack, see the system's cable management accessory documentation at <https://www.dell.com/poweredgemanuals>.
2. Connect the power cable to the PSU, and plug the cable into a power outlet.

CAUTION: When connecting the power cable to the PSU, secure the cable to the PSU with the strap.

NOTE: When installing, hot swapping, or hot adding a new PSU, wait for 15 seconds for the system to recognize the PSU and determine its status. The PSU redundancy may not occur until discovery is complete. The PSU status indicator turns green to indicate that the PSU is functioning properly.

Trusted Platform Module

Upgrading the Trusted Platform Module

Prerequisites

NOTE:

- Ensure that your operating system supports the version of the TPM module being installed.
- Ensure that you download and install the latest BIOS firmware on your system.
- Ensure that the BIOS is configured to enable UEFI boot mode.

About this task

CAUTION: Once the TPM plug-in module is installed, it is cryptographically bound to that specific system board. Any attempt to remove an installed TPM plug-in module breaks the cryptographic binding, the removed TPM cannot be reinstalled or installed on another system board.

Removing the TPM

Steps

1. Locate the TPM connector on the system board.

2. Press to hold the module down and remove the screw using the security Torx 8-bit shipped with the TPM module.
3. Slide the TPM module out from its connector.
4. Push the plastic rivet away from the TPM connector and rotate it 90° counterclockwise to release it from the system board.
5. Pull the plastic rivet out of its slot on the system board.

Installing the TPM

Steps

1. To install the TPM, align the edge connectors on the TPM with the slot on the TPM connector.
2. Insert the TPM into the TPM connector such that the plastic rivet aligns with the slot on the system board.
3. Press the plastic rivet until the rivet snaps into place.
4. Replace the screw that secures the TPM to the system board.

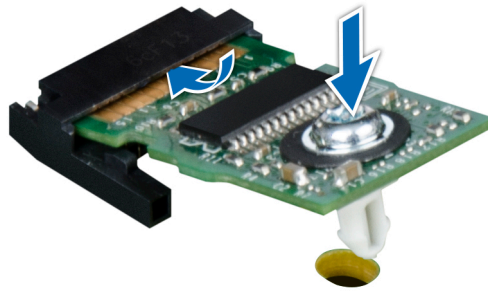

Figure 128. Installing the TPM

Initializing TPM for users

Steps

1. Initialize the TPM.
For more information, see [Initializing the TPM for users](#).
2. The **TPM Status** changes to **Enabled, Activated**.

Initializing the TPM 1.2 for users

Steps

1. While booting your system, press F2 to enter System Setup.
2. On the **System Setup Main Menu** screen, click **System BIOS > System Security Settings**.
3. From the **TPM Security** option, select **On with Preboot Measurements**.
4. From the **TPM Command** option, select **Activate**.
5. Save the settings.
6. Restart your system.

Initializing the TPM 2.0 for users

Steps

1. While booting your system, press F2 to enter System Setup.
2. On the **System Setup Main Menu** screen, click **System BIOS > System Security Settings**.

3. From the **TPM Security** option, select **On**.
4. Save the settings.
5. Restart your system.

System board

Removing the system board

Prerequisites

 **CAUTION:** If you are using the Trusted Platform Module (TPM) with an encryption key, you may be prompted to create a recovery key during program or System Setup. Be sure to create and safely store this recovery key. If you replace this system board, you must supply the recovery key when you restart your system or program before you can access the encrypted data on your drives.

1. Follow the safety guidelines listed in the [Safety instructions](#).
2. Follow the procedure listed in the [Before working inside your system](#).
3. Remove the following components:
 - a. [Air shroud \(if installed\)](#)
 - b. [Cooling fan modules](#)
 - c. [Heat sink](#)
 - d. [Processor](#)
 - e. [Memory modules](#)
 - f. [Expansion card risers](#)
 - g. [IDSDM module \(if installed\)](#)
 - h. [Internal USB card \(if installed\)](#)
 - i. [OCP card \(if installed\)](#)
 - j. [Power supply units \(PSU\)](#)
 - k. Disconnect all cables from the system board.

 **CAUTION:** Take care not to damage the system identification button while removing the system board from the system.

Steps

1. Using the system board holder and plunger, slide the system board towards the front of the system.
2. Lift the system board out of the chassis.

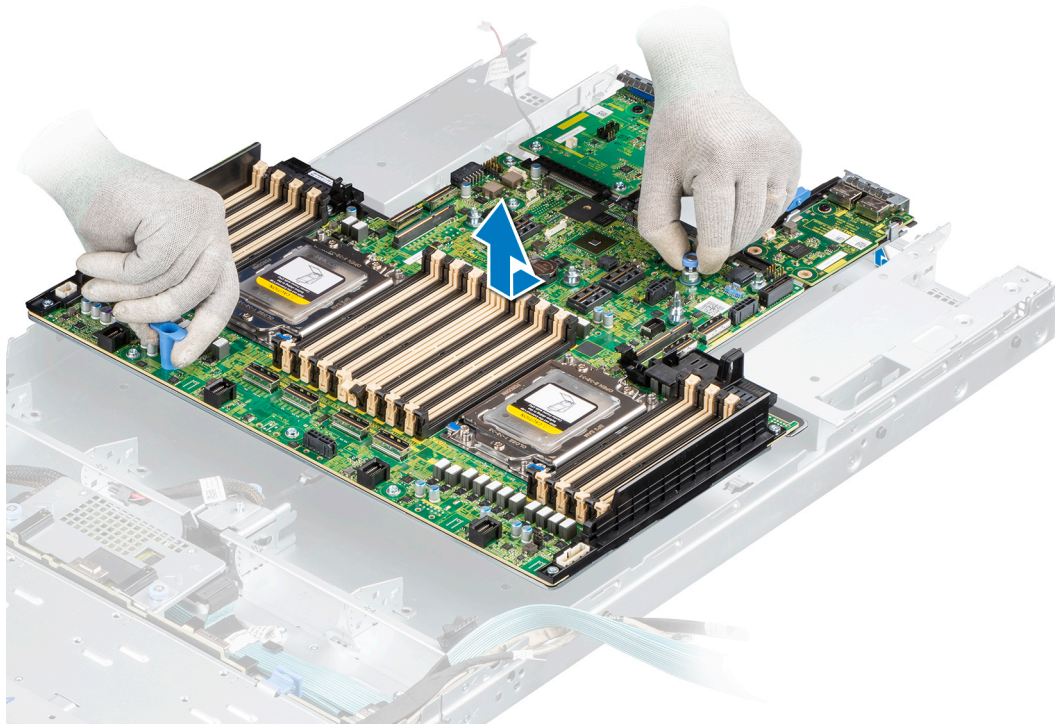

Figure 129. Removing the system board

Next steps

1. [Install the system board.](#)

Installing the system board

Prerequisites

NOTE: Before replacing the system board, replace the old iDRAC MAC address label in the Information tag with the iDRAC MAC address label of the replacement system board

1. Follow the safety guidelines listed in the [Safety instructions](#).
2. Follow the procedure listed in [Before working inside your system](#).
3. If you are replacing the system board, remove all the components that are listed in the removing the system board section.

Steps

1. Unpack the new system board assembly.

CAUTION: Do not lift the system board by holding a memory module, processor, or other components.

CAUTION: Take care not to damage the system identification button while placing the system board into the chassis.

2. Holding the system board holder and plunger, lower the system board into the system.
3. Slide the system board towards the rear of the chassis until the connectors are firmly seated in the slots.

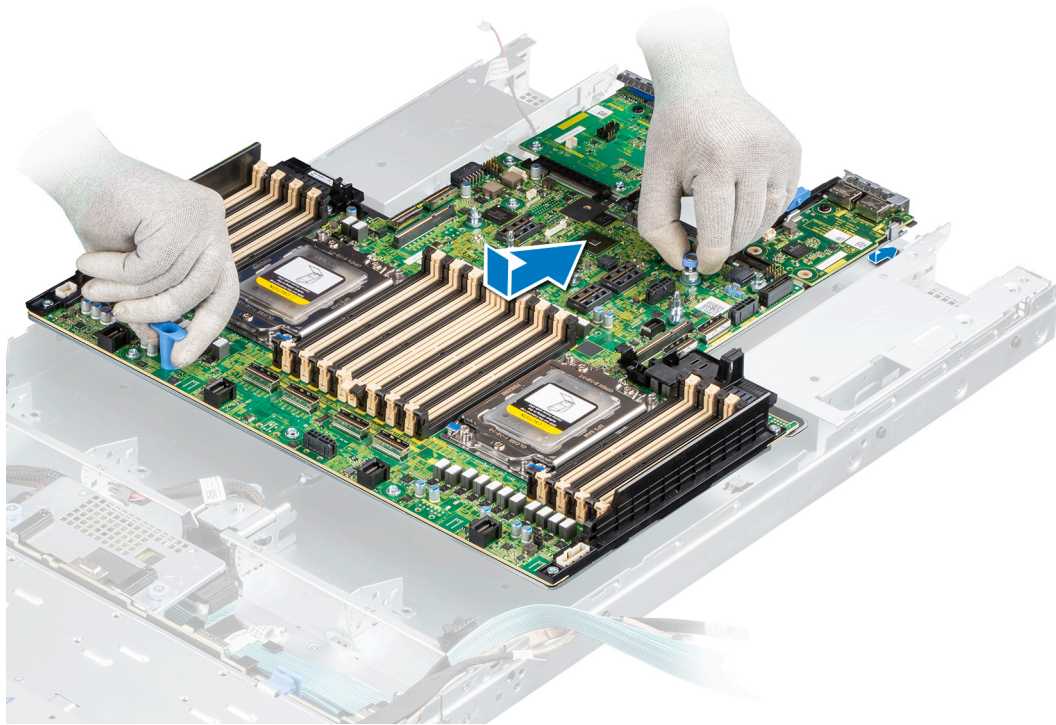

Figure 130. Installing the system board

Next steps

1. Replace the following components:
 - a. [Trusted Platform Module \(TPM\)](#)
i **NOTE:** The TPM Module must be replaced only while installing new system board.
 - b. [IDSDM module \(if installed\)](#)
 - c. [Internal USB card \(if installed\)](#)
 - d. [Power supply units \(PSU\)](#)
 - e. [OCP card \(if installed\)](#)
 - f. [Processor](#)
 - g. [Heat sink](#)
 - h. [Memory modules](#)
 - i. [Cooling fan modules](#)
 - j. [Air shroud \(if installed\)](#)
2. Reconnect all cables to the system board.
i **NOTE:** Ensure that the cables inside the system are routed along the chassis wall and secured using the cable securing bracket.
3. Ensure that you perform the following steps:
 - a. Use the Easy Restore feature to restore the Service Tag. See the [Restoring the system by using the Easy Restore feature](#) section.
 - b. If the service tag is not backed up in the backup flash device, enter the system service tag manually. See the [Manually update the Service Tag by using System Setup](#) section.
 - c. Update the BIOS and iDRAC versions.
Reenable the Trusted Platform Module (TPM). See the [Upgrading the Trusted Platform Module](#) section.
4. If you are not using Easy restore, import your new or existing iDRAC Enterprise license. For more information, see the [Integrated Dell Remote Access Controller User's Guide](#) available at <https://www.dell.com/idracmanuals>.
5. Follow the procedure listed in [After working inside your system](#).

Restoring Service Tag using Easy Restore

The Easy Restore feature allows you to restore your Service Tag, iDRAC license, UEFI configuration, and the system configuration data after replacing the system board. All data is backed up in a backup Flash drive device automatically. If BIOS detects a new system board, and the Service Tag in the backup Flash drive device is different, BIOS prompts the user to restore the backup information.

About this task

Below is a list of options available:

1. Restore the Service Tag, license, and diagnostics information, press **Y**.
 2. Go to the Lifecycle Controller based restore options, press **N**.
 3. Restore data from a previously created **Hardware Server Profile**, press **F10**.
NOTE: When the restore process is complete, BIOS prompts to restore the system configuration data.
 4. To restore the system configuration data, press **Y**
 5. To use the default configuration settings, press **N**
NOTE: After the restore process is complete, system reboots.
- NOTE:** If restoring the Service Tag is successful, you can check the Service Tag information in the **System Information** screen and compare it with the Service Tag on the system.

Manually updating Service Tag

After replacing a system board, if Easy Restore fails, follow this process to manually enter the Service Tag, using **System Setup**.

About this task

If you know the system Service Tag, use the **System Setup** menu to enter the Service Tag.

Steps

1. Turn on the system.
2. To enter the **System Setup**, press **F2**.
3. Click **Service Tag Settings**.
4. Enter the Service Tag.
NOTE: You can enter the Service Tag only when the **Service Tag** field is empty. Ensure that you enter the correct Service Tag. After the Service Tag is entered, it cannot be updated or changed.
5. Click **OK**.

LOM card and rear I/O board

Removing the LOM card and rear I/O board

Prerequisites

1. Follow the safety guidelines listed in the [Safety instructions](#).
2. Follow the procedure listed in the [Before working inside your system](#).
3. [Remove the system board](#).

Steps

1. Using a Phillips #2 screwdriver, remove the screws that secure the LAN on Motherboard (LOM) card and rear I/O board to the system board.
2. Holding the edges, pull the LOM card or rear I/O board to disconnect from the connector on the system board.

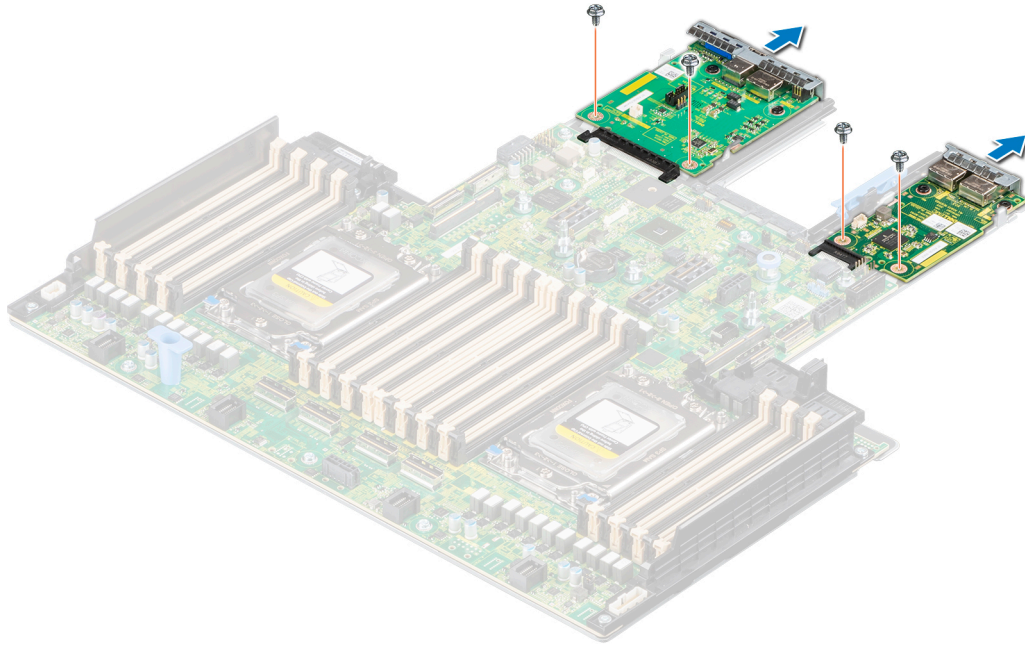

Figure 131. Removing the LOM card and rear I/O board

Next steps

1. [Replace the LOM card and rear I/O board.](#)

Installing the LOM card and rear I/O board

Prerequisites

1. Follow the safety guidelines listed in the [Safety instructions](#).
2. Follow the procedure listed in the [Before working inside your system](#).
3. [Remove the system board.](#)

Steps

1. Align the connectors and slots on the LOM card or rear I/O board with the connector and standoffs on the system board.
2. Press the LOM card or rear I/O board until firmly seated on the system board connector.
3. Using a Phillips #2 screwdriver, secure the LOM card or rear I/O board to the system board with screws.

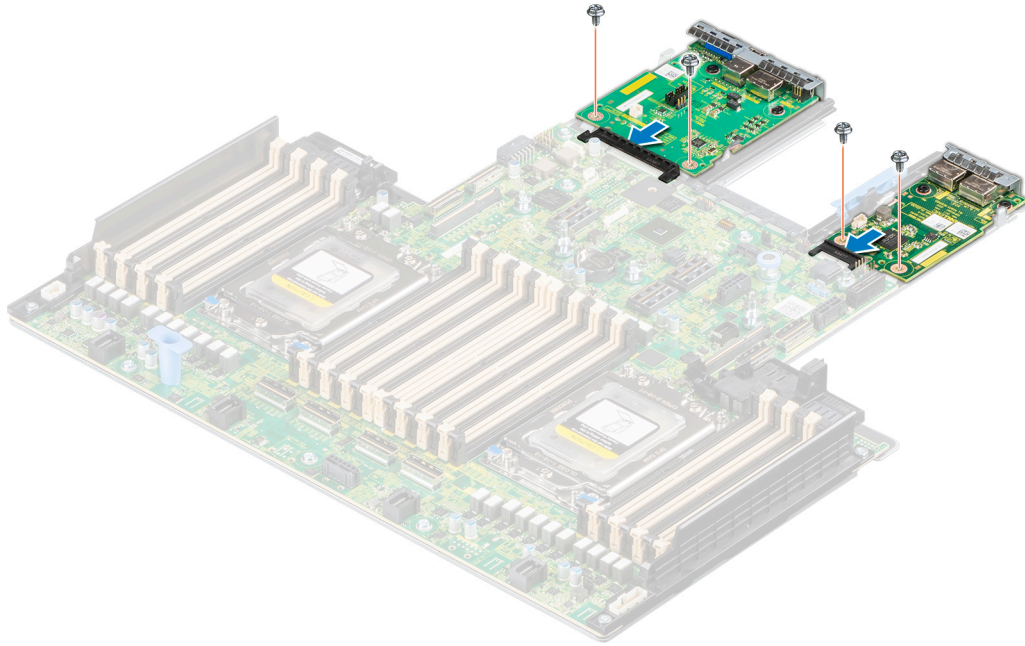

Figure 132. Installing the LOM card and rear I/O board

Next steps

1. [Install the system board.](#)
2. Follow the procedure listed in [After working inside your system.](#)

RIO card

Removing the Rear Input Output (RIO) card

Prerequisites

1. Follow the safety guidelines listed in the [Safety instructions.](#)
2. Follow the procedure listed in the [Before working inside your system.](#)
3. [Remove the system board.](#)

Steps

1. Using a Phillips #2 screwdriver, remove the screws that secure the RIO card to the system board.
2. Holding the edges, pull the RIO card to disconnect from the connector on the system board.

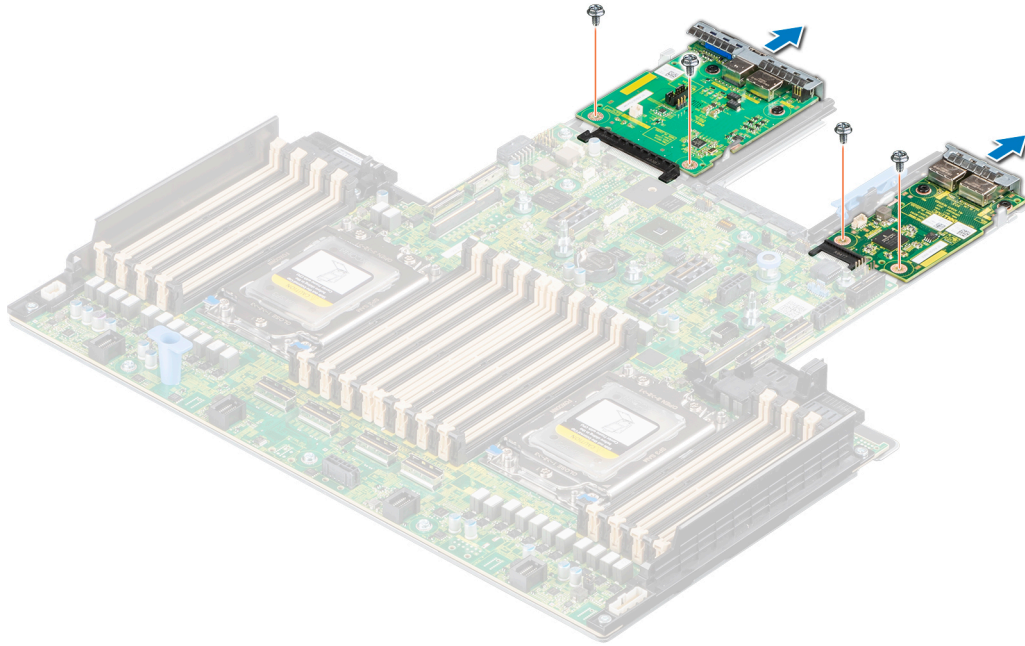

Figure 133. Removing the RIO card

Next steps

1. [Replace the RIO card.](#)

Installing the RIO card

Prerequisites

1. Follow the safety guidelines listed in the [Safety instructions](#).
2. Follow the procedure listed in the [Before working inside your system](#).
3. [Remove the system board](#).
4. If required, [remove the LOM card](#).

i **NOTE:** Upgrading the system board with the liquid cooling solution requires the LOM card to be replaced with the RIO card.

Steps

1. Align the connectors and slots on RIO card with the connector and standoffs on the system board.
2. Press the RIO card until firmly seated on the system board connector.
3. Using a Phillips #2 screwdriver, secure the RIO card to the system board with the two screws.

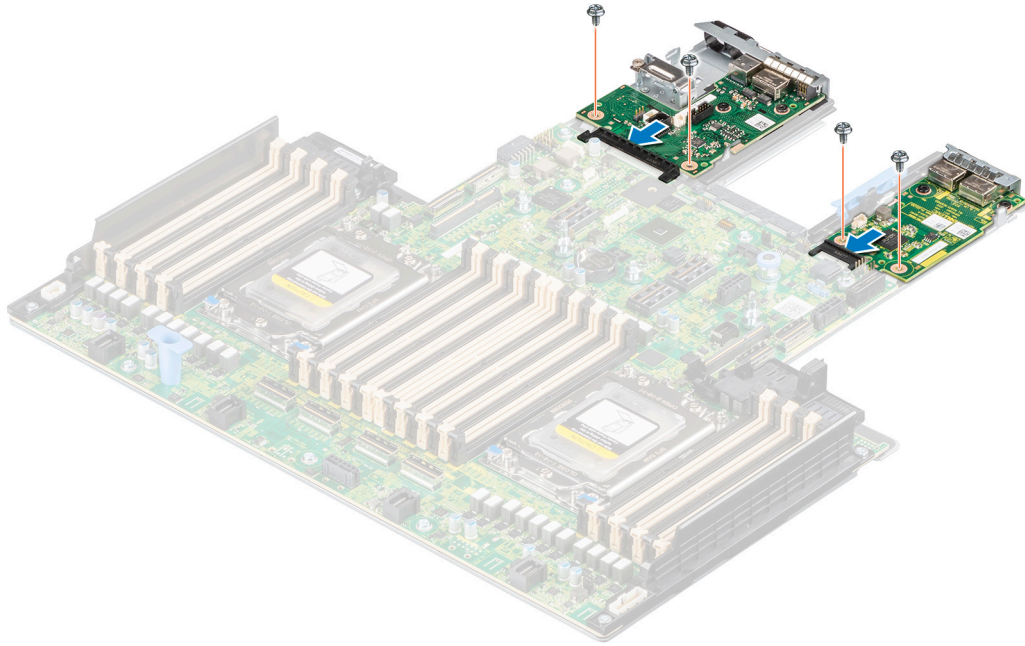

Figure 134. Installing the RIO card

Next steps

1. [Install the system board.](#)
2. Follow the procedure listed in [After working inside your system.](#)

Tube clip

Removing the tube clip

Prerequisites

1. Follow the safety guidelines listed in the [Safety instructions.](#)
2. Follow the procedure listed in the [Before working inside your system.](#)
3. [Remove the system cover.](#)

Steps

Using a Phillips #2 screwdriver, loosen the screw that is securing the tube clip and remove it from the chassis.

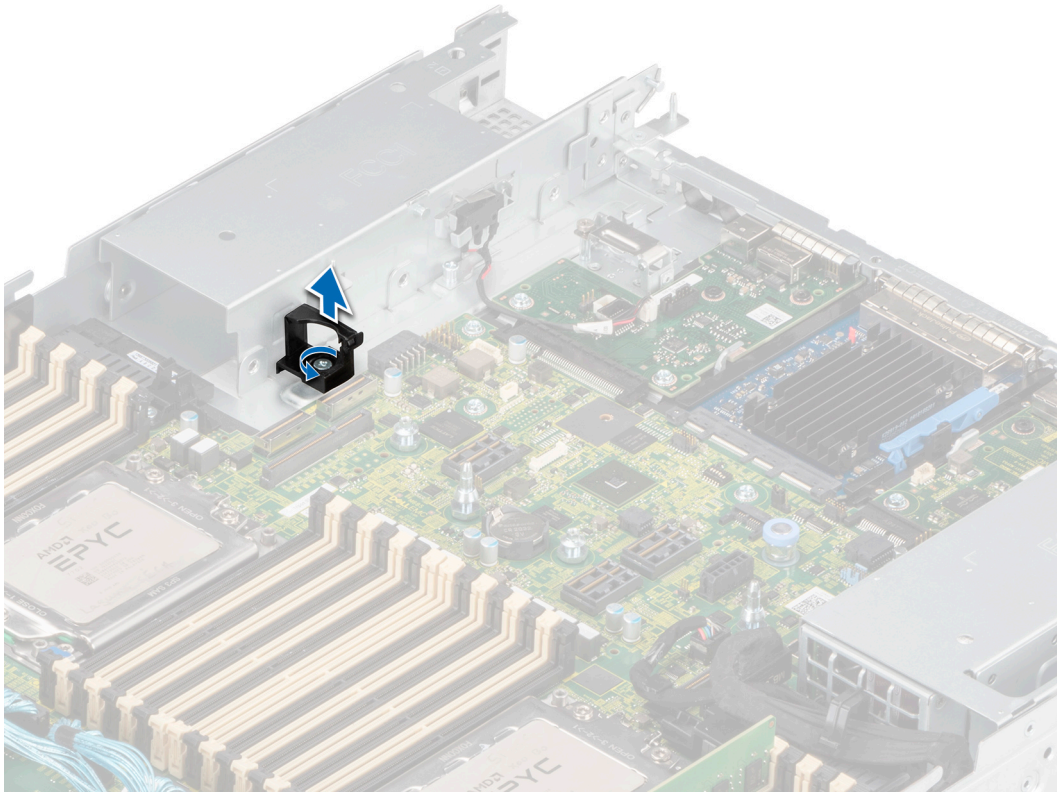

Figure 135. Removing the tube clip

Next steps

1. [Replace the tube clip.](#)

Installing the tube clip

Prerequisites

1. Follow the safety guidelines listed in the [Safety instructions](#).
2. Follow the procedure listed in the [Before working inside your system](#).
3. [Remove the system cover.](#)

Steps

1. Place the tube clip onto the chassis according to the guide pins.
2. Using a Phillips #2 screwdriver, secure the tube clip to the chassis with the screw.

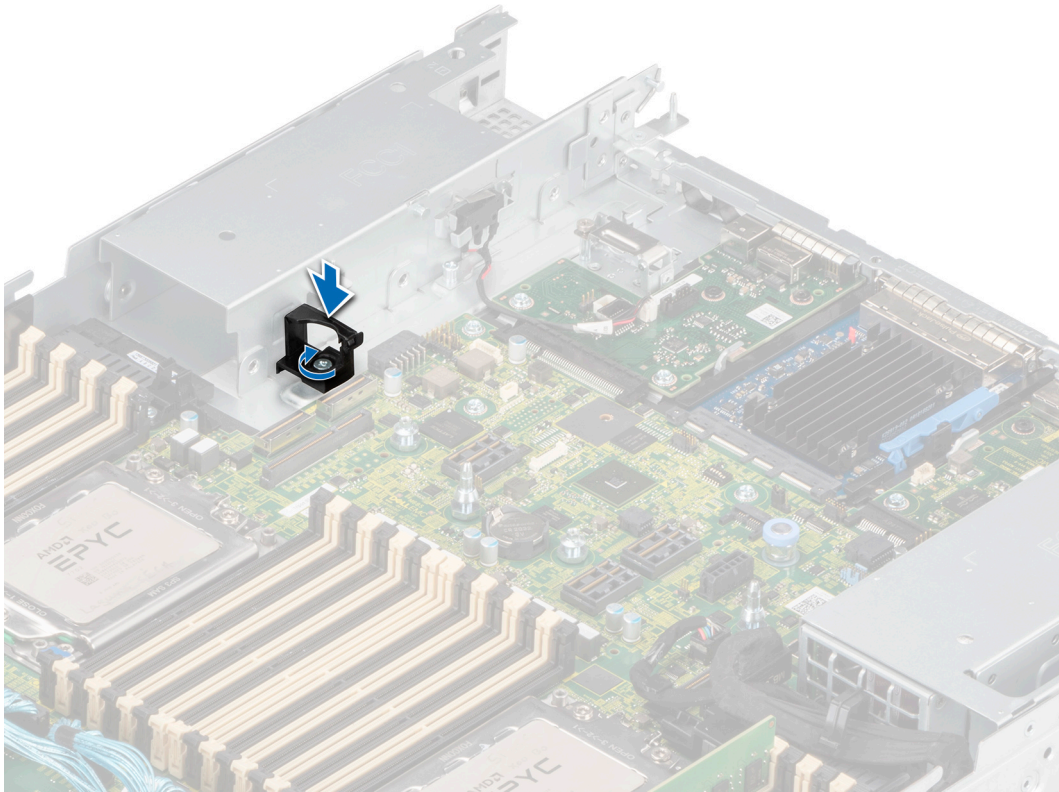

Figure 136. Installing the tube clip

Next steps

1. [Install the system cover.](#)
2. Follow the procedure listed in [After working inside your system.](#)

Upgrade Kits

The table lists the available After Point Of Sale [APOS] kits.

Table 28. Upgrade kits

Kits	Part number	Related links to service instructions
Bezel	JYPW8/MPW3H (LCD)	See Installing the front bezel
BOSS		See Installing the M.2 SSD module
BOSS S2		See Installing the BOSS S2 controller card module
Embedded management (IDSDM)	C2KCJ	See IDSDM kit
Hard drives		See Installing the drive
Hard drives SSD		See Installing the drive into the carrier
Network cards (Standard PCIe adapter LP/FH)		See Installing the LOM card and rear I/O board
Network cards (OCP)		See Installing the OCP card
PCIe SSD card		See Installing an expansion card into the expansion card riser
Power cords		
Power supplies		See Installing a power supply unit
Quick sync	C70VC (PE) / 8XK5Y (OEM)	
SD cards		See Installing the MicroSD card
TPM		See Upgrading the Trusted Platform Module
Processor enablement thermal kits		See Installing the processor
Internal USB 3.0 card	C19XC	See Internal USB card kit
Serial COM port daughter card	626YT	See Installing the serial COM port

Topics:

- [BOSS S2 kit](#)
- [PCIe Gen 4 NVMe enablement Kit](#)
- [IDSDM kit](#)
- [Internal USB card kit](#)
- [Serial COM port kit](#)

BOSS S2 kit

The BOSS S2 supports up to two M.2 SSDs.

 **NOTE:** To enable the BOSS S2 in the system, ensure that the BIOS firmware version is 1.5.5 and iDRAC firmware version is 4.30.30.30 or later.

Before you begin the installation or removal process, follow the [safety guidelines](#) and [before working inside the system](#) instructions.

Table 29. BOSS S2 kit components

R6525 (quantity)	Components in kit
1	BOSS cover
3	M3 x 0.05 x 4.5 mm screws
1	BOSS signal cable
1	BOSS power cable
1	BOSS-S2 controller card module
1 or 2*	BOSS-S2 card carrier
1 or 2*	M.2 SSD
2	M.2 240 GB information label
2	M.2 480 GB information label
1	BOSS card filler
1	Tech sheet

To remove the BOSS blank :

1. Power off the system and [remove the system cover](#).
2. Using the Phillips #1 screwdriver, remove the M3 x 0.05 x 4.5 mm screw that secures the BOSS blank to the PSU Bay. Slide the BOSS blank away from the PSU Bay.

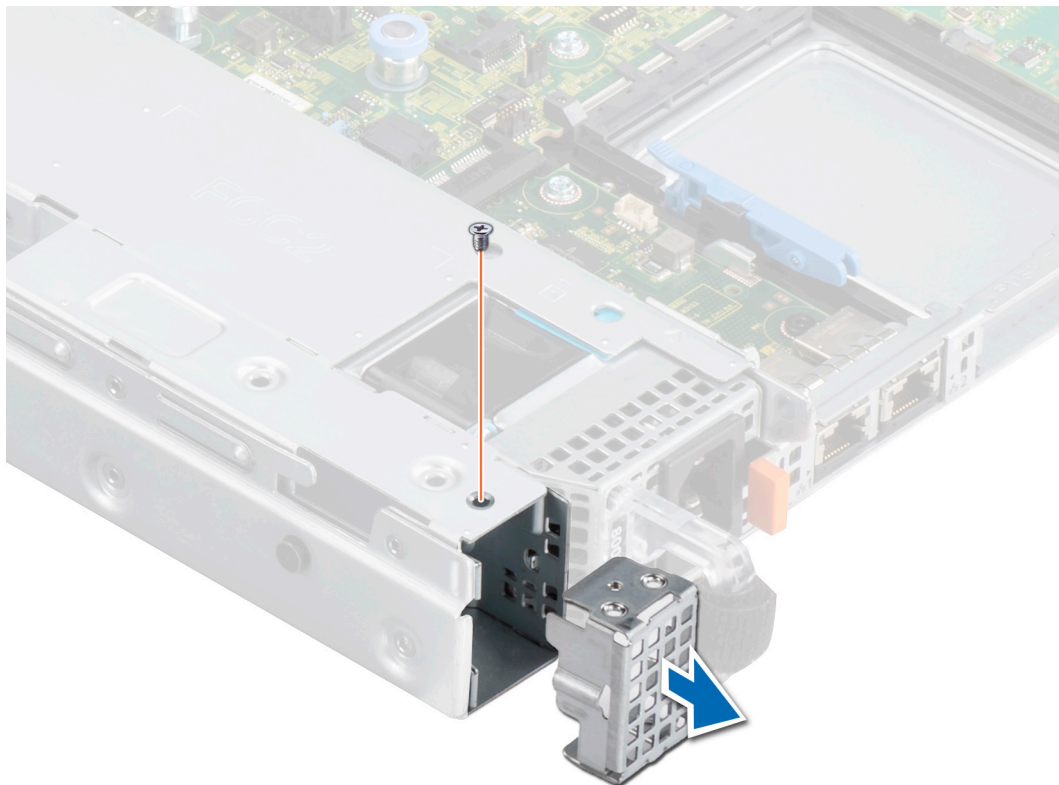

Figure 137. Removing the BOSS blank

To install the BOSS blank:

1. Power off the system and [remove the system cover](#).
2. Slide the BOSS blank on to the PSU bay until it is firmly seated. Using the Phillips #1 screwdriver, secure the BOSS blank with the M3 x 0.05 x 4.5 mm screw.

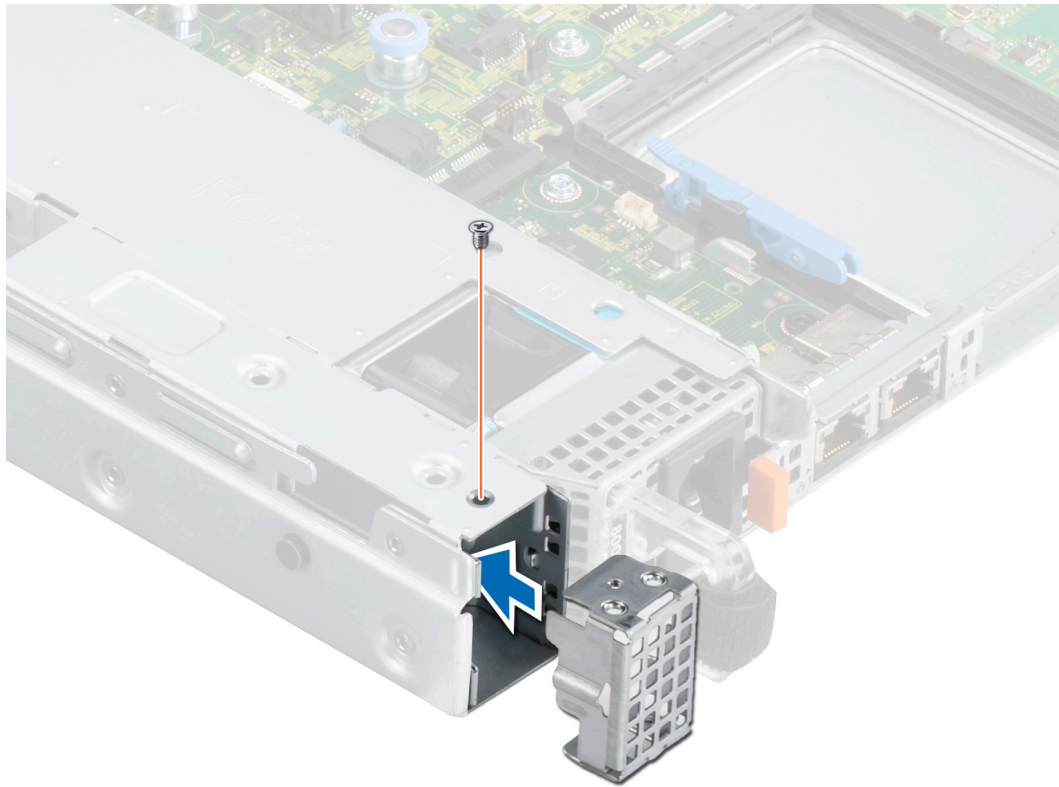

Figure 138. Installing the BOSS blank

To install the BOSS S2 controller card module:

1. Install the BOSS S2 controller card module. To install the BOSS S2 controller card module, see [installing the BOSS S2 controller card module](#) steps 1 to 3.
2. Install the M.2 SSD. To install the M.2 SSD, see [installing the BOSS S2 controller card module](#) steps 4 to 8.

i **NOTE:** Installing the BOSS S2 card carrier does not require the system to be powered off. System shutdown is only required when installing the BOSS S2 controller card module.

i **NOTE:** Connect the BOSS signal cable and BOSS power cable after inserting the BOSS S2 controller card module into the system.

To remove the BOSS S2 controller card module:

1. Remove the M.2 SSD. To remove the M.2 SSD, see [removing the BOSS S2 controller card module](#) step 1 to 4.
2. Remove the BOSS S2 controller card module. To remove the BOSS S2 controller card module, see [removing the BOSS S2 controller card module](#) step 5 to 6.
3. Install the BOSS blank.

i **NOTE:** Removal of the BOSS S2 card carrier does not require the system to be powered off. System shutdown is only required when removing the BOSS S2 controller card module.

i **NOTE:** Disconnect the BOSS signal cable and the BOSS power cable before lifting the controller card module from the system.

PCIe Gen 4 NVMe enablement Kit

i **NOTE:** To enable the PCIe Gen4 NVMe feature, **update the BIOS** version to **1.2.11** or greater and **backplane firmware** version to be **greater than 2.84**. For latest firmware, refer to the System's Drivers and Downloads page at www.dell.com/support/drivers and search for PowerEdge R6525.

NOTE: The backplane firmware (greater than 2.84) with GEN4 enabled feature is not available now and is expected only later half of FY21.

The PCIe Gen 4 NVMe enablement kit contains the components listed in the table.

Table 30. PCIe Gen 4 NVMe enablement kit components

Components	Quantity
10 x 2.5-inch SAS/SATA to 6 x 2.5-inch SAS/SATA + 4 NVMe	One backplane and three slimline cables
10 x 2.5-inch SAS/SATA to 10 x 2.5-inch NVMe	One backplane and five slimline cables

Replacing 10 x 2.5-inch SAS/SATA backplane to 10 x 2.5-inch four universal backplane

Before you begin, follow the [safety guidelines](#) and [before working inside the system](#) instructions.

1. [Remove the drive backplane cover](#) from the system.
2. [Remove the air shroud](#) out of the system.
3. Remove the cables connected the PERC module and the system board.
4. Remove the Power cable connected to the backplane and system board.
5. [Remove the drive backplane along with the front PERC module](#) and disconnect the cable connected to the rear mounting front PERC module and backplane.
6. [Remove the front PERC module](#) from the backplane.
7. Disconnect the cable connected to rear mounting front PERC module and backplane.
8. [Install the rear mounting front PERC module](#) on the backplane from the kit.
9. [Install the drive backplane](#) to the system.
10. Connect the power cable connected to the backplane and system board.
11. Connect all the cables from backplane to the system board.

For more information on cable connectors, sockets and how to route the cables on the system board, refer to the figure **10 x 2.5-inch four universal backplane** and **10 x 2.5-inch SAS/SATA NVMe backplane** in the [cable routing](#).

12. [Install the air shroud](#).
13. [Install the drive backplane cover](#).

After installing, follow the [after working inside the system](#) instructions.

Replacing 10 x 2.5-inch SAS/SATA backplane to 10 x 2.5-inch SAS/SATA NVMe backplane

Before you begin, follow the [safety guidelines](#) and [before working inside the system](#) instructions.

1. [Remove the drive backplane cover](#) from the system.
2. [Remove the air shroud](#) out of the system.
3. Remove the cables connected the PERC module and the system board.
4. Remove the power cable connected to the backplane and system board.
5. [Remove the drive backplane along with the front PERC module](#) and disconnect the cable connected to the rear mounting front PERC module and backplane.
6. Install the NVMe backplane from the kit.
7. Connect the power cable to the backplane and system board.
8. Connect all the cables from backplane to the system board.

For more information on cable connectors, sockets and how to route the cables on the system board, refer to the figure **10 x 2.5-inch four universal backplane** and **10 x 2.5-inch SAS/SATA NVMe backplane** in the [cable routing](#).

9. [Install the air shroud](#).
10. [Install the drive backplane cover](#).

After installing, follow the [after working inside the system](#) instructions.

IDSDM kit

The IDSDM kit contains one IDSDM card. For installation procedure of IDSDM, see [installing the IDSDM module](#) section.

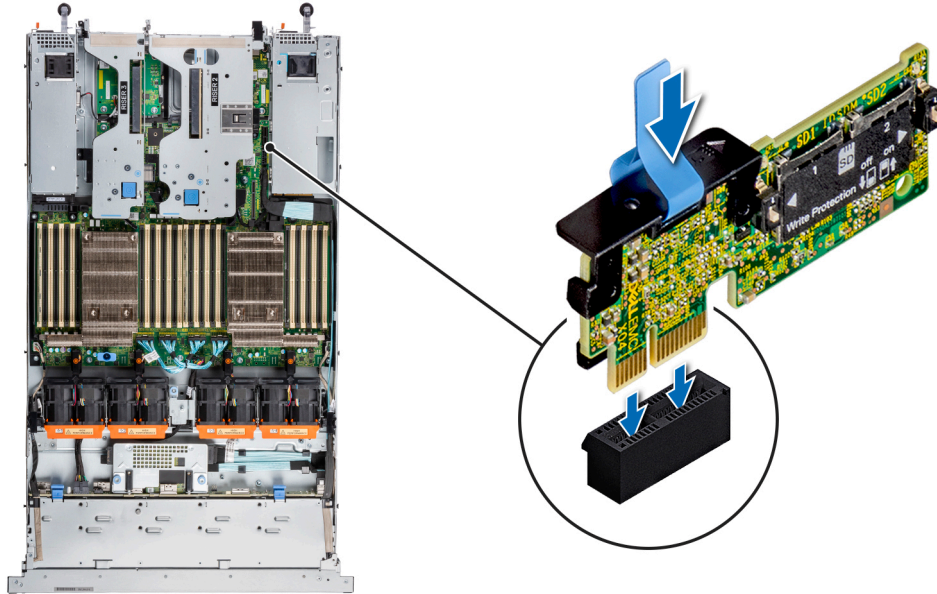

Figure 139. IDSDM port information

Internal USB card kit

The internal USB card kit contains one internal USB card. For installation of internal USB card, see [installing the internal USB card](#) section.

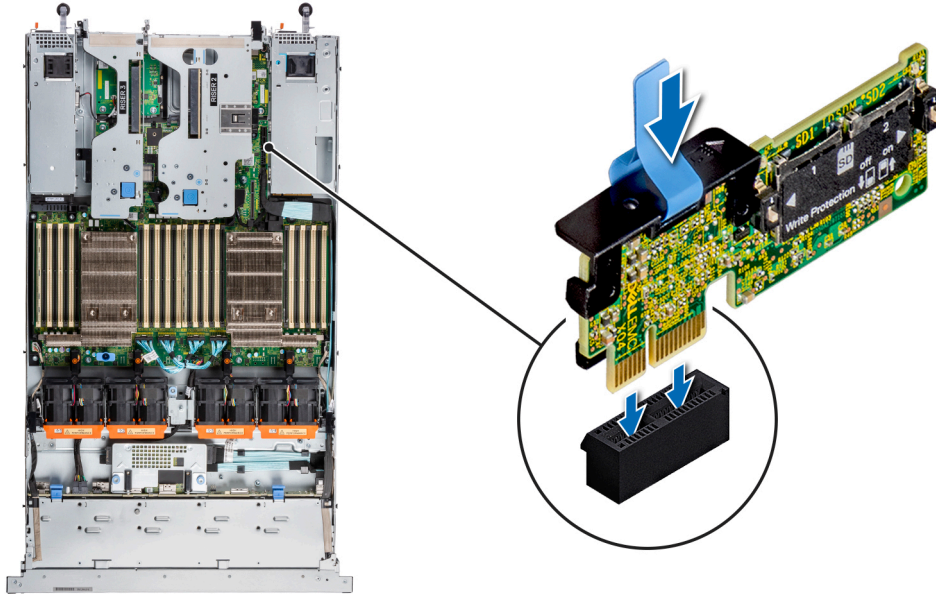

Figure 140. Internal USB card port information

Serial COM port kit

The serial COM port kit contains the components listed in the table.

Table 31. Serial COM port kit

Components	Quantity
Serial COM port card	1
Cable	1

For installation procedure of the serial COM port, see www.dell.com/poweredge/manuals in the serial COM port section.

Jumpers and connectors

This section provides essential and specific information about jumpers and switches. It also describes the connectors on the various boards in the system. Jumpers on the system board help to disable the system and reset the passwords. To install components and cables correctly, you must be able to identify the connectors on the system board.

Topics:

- System board connectors
- System board jumper settings
- Disabling a forgotten password

System board connectors

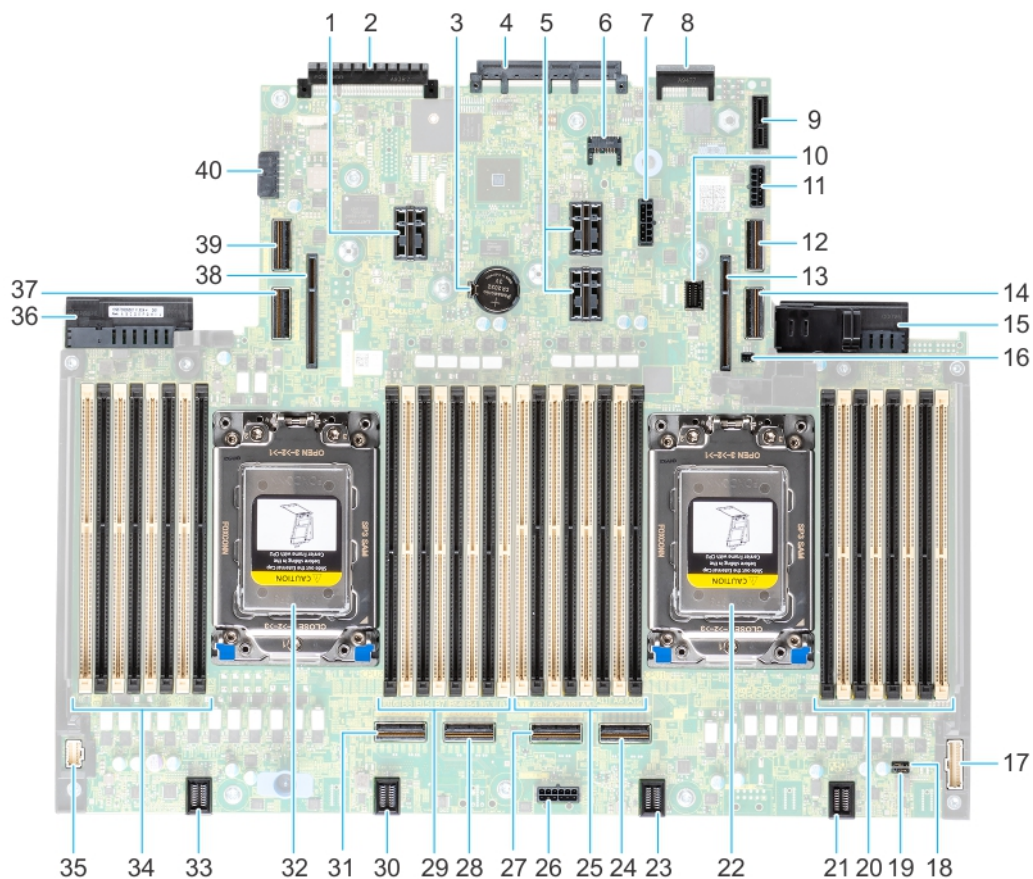

Figure 141. System board jumpers and connectors

Table 32. System board jumpers and connectors

Item	Connector	Description
1.	IO_RISER3 (CPU2)	Riser 3
2.	Rear I/O connector	Rear I/O connector

Table 32. System board jumpers and connectors (continued)

Item	Connector	Description
3.	Coin cell battery	Coin cell battery
4.	OCP NIC 3.0 connector	OCP NIC 3.0 connector
5.	IO_RISER2_A (CPU1) IO_RISER2_B (CPU2)	Riser 2
6.	J_TPM	TPM
7.	SIG_PWR_0 (Rear BP)	Backplane signal and power 0
8.	LOM connector	LOM connector
9.	IDSDM/Internal USB connector	IDSDM/Internal USB connector
10.	MB_FRONT_VIDEO	Front VGA
11.	SIG_PWR_4	GPU power
12.	SL8_CPU1_PA2	PCIe/NVMe connector 8
13.	IO_RISER1 (CPU1)	Riser 1
14.	SL7_CPU1_PB2	PCIe/NVMe connector 7
15.	J_PS1_1U	PSU1
16.	BOSS_CARD_PWR	BOSS card power
17.	RGT_CP	Right control panel
18.	PWRD_EN	PWRD_EN(Jumpers)
19.	NVRAM_CLR	NVRAM_CLR(Jumpers)
20.	A16, A8, A15, A7, A14, A4, A13, A3	DIMMs for processor 1 channels E, F, G, H
21.	FAN_1U7/8	Fan 4
22.	CPU1	Processor 1
23.	FAN_2U4_1U5/6	Fan 3
24.	SL4_CPU1_PA1_XA1	XGMI/NVMe connector 4
25.	A1, A9, A2, A10, A5, A11, A6, A12	DIMMs for processor 1 channels A, B, C, D
26.	SIG_PWR_1	Backplane signal and power 1
27.	SL3_CPU1_PB1_XB1	XGMI/NVMe connector 3
28.	SL2_CPU2_PA3_XA2	XGMI/NVMe connector 2
29.	B16, B8, B15, B7, B14, B4, B13, B3	DIMMs for processor 2 channels E, F, G, H
30.	FAN_1U3/4	Fan 2
31.	SL1_CPU2_PB3_XB2	XGMI/NVMe connector 1
32.	CPU2	Processor 2
33.	FAN_2U1_1U1/2	Fan 1
34.	B1, B9, B2, B10, B5, B11, B6, B12	DIMMs for processor 2 channels A, B, C, D
35.	LFT_CP	Left control panel
36.	J_PS2_1U	PSU 2





Table 32. System board jumpers and connectors (continued)

Item	Connector	Description
37.	SL5_CPU2_PA4_SA1	PCIe/NVMe/SATA connector 5
38.	IO_RISER4 (CPU2)	Riser 4
39.	SL6_CPU2_PB4	PCIe/NVMe connector 6
40.	SIG_PWR_3	GPU power

System board jumper settings

For information about resetting the password jumper to disable a password, see the [Disabling a forgotten password](#) section.

Table 33. System board jumper settings

Jumper	Setting	Description
PWRD_EN	 2 4 6 (default)	The BIOS password feature is enabled.
		The BIOS password feature is disabled. The BIOS password is now disabled and you are not allowed to set a new password.
NVRAM_CLR	 1 3 5 (default)	The BIOS configuration settings are retained at system boot.
		The BIOS configuration settings are cleared at system boot.

CAUTION: Be careful when changing the BIOS settings. The BIOS interface is designed for advanced users. Any change in the setting could prevent your system from starting correctly and you might have potential loss of data.

Disabling a forgotten password

The software security features of the system include a system password and a setup password. The password jumper enables or disables password features and clears any password(s) currently in use.

Prerequisites

CAUTION: Many repairs may only be done by a certified service technician. You should only perform troubleshooting and simple repairs as authorized in your product documentation, or as directed by the online or telephone service and support team. Damage due to servicing that is not authorized by Dell is not covered by your warranty. Read and follow the safety instructions that are shipped with your product.

Steps

1. Power off the system, and all the attached peripherals, and disconnect the system from the electrical outlet.
2. Remove the system cover.
3. Move the jumper on the system board from pins 2 and 4 to pins 4 and 6.
4. Replace the system cover.

NOTE: The existing passwords are not disabled (erased) until the system boots with the jumper on pins 4 and 6. However, before you assign a new system and/or setup password, you must move the jumper back to pins 2 and 4.

NOTE: If you assign a new system and/or setup password with the jumper on pins 4 and 6, the system disables the new password(s) the next time it boots.

5. Reconnect the system and all the attached peripherals.

6. Power off the system.
7. Remove the system cover.
8. Move the jumper on the system board from pins 4 and 6 to pins 2 and 4.
9. Replace the system cover.
10. Reconnect the system to the electrical outlet and power on the system, and all the attached peripherals.
11. Assign a new system and/or setup password.

System diagnostics and indicator codes

This section describes the diagnostic indicators on the system front panel that displays the system status during system startup.

Topics:

- Status LED indicators
- System health and system ID indicator codes
- iDRAC Quick Sync 2 indicator codes
- iDRAC Direct LED indicator codes
- LCD panel
- NIC indicator codes
- Power supply unit indicator codes
- Drive indicator codes
- Using system diagnostics

Status LED indicators

 **NOTE:** The indicators display solid amber if any error occurs.



Figure 142. Status LED indicators

Table 34. Status LED indicators and descriptions





Icon	Description	Condition	Corrective action
	Drive indicator	The indicator turns solid amber if there is a drive error.	<ul style="list-style-type: none"> • Check the System Event Log to determine if the drive has an error. • Run the appropriate Online Diagnostics test. Restart the system and run embedded diagnostics (ePSA). • If the drives are configured in a RAID array, restart the system, and enter the host adapter configuration utility program.
	Temperature indicator	The indicator turns solid amber if the system experiences a thermal error (for example, the ambient temperature is out of range or there is a fan failure).	<p>Ensure that none of the following conditions exist:</p> <ul style="list-style-type: none"> • A cooling fan has been removed or has failed. • System cover, air shroud, or back filler bracket is removed. • Ambient temperature is too high. • External airflow is obstructed. <p>If the problem persists, see the Getting help section.</p>

Table 34. Status LED indicators and descriptions (continued)

Icon	Description	Condition	Corrective action
	Electrical indicator	The indicator turns solid amber if the system experiences an electrical error (for example, voltage out of range, or a failed power supply unit (PSU) or voltage regulator).	Check the System Event Log or system messages for the specific issue. If it is due to a problem with the PSU, check the LED on the PSU. Reseat the PSU. If the problem persists, see the Getting help section.
	Memory indicator	The indicator turns solid amber if a memory error occurs.	Check the System Event Log or system messages for the location of the failed memory. Reseat the memory module. If the problem persists, see the Getting help section.
	PCIe indicator	The indicator turns solid amber if a PCIe card experiences an error.	Restart the system. Update any required drivers for the PCIe card. Reinstall the card. If the problem persists, see the Getting help section. NOTE: For more information about the supported PCIe cards, see the Expansion card installation guidelines section.

System health and system ID indicator codes

The system health and system ID indicator is located on the left control panel of the system.



Figure 143. System health and system ID indicator

Table 35. System health and system ID indicator codes

System health and system ID indicator code	Condition
Solid blue	Indicates that the system is powered on, is healthy, and system ID mode is not active. Press the system health and system ID button to switch to system ID mode.
Blinking blue	Indicates that the system ID mode is active. Press the system health and system ID button to switch to system health mode.
Solid amber	Indicates that the system is in fail-safe mode. If the problem persists, see the Getting help section.
Blinking amber	Indicates that the system is experiencing a fault. Check the System Event Log for specific error messages. For information about the event and error messages generated by the system firmware and agents that monitor system components, go to qrl.dell.com > Look Up > Error Code , type the error code, and then click Look it up .

iDRAC Quick Sync 2 indicator codes

iDRAC Quick Sync 2 module (optional) is located on the left control panel of the system.



Table 36. iDRAC Quick Sync 2 indicators and descriptions

iDRAC Quick Sync 2 indicator code	Condition	Corrective action
Off (default state)	Indicates that the iDRAC Quick Sync 2 feature is powered off. Press the iDRAC Quick Sync 2 button to power on the iDRAC Quick Sync 2 feature.	If the LED fails to power on, reseal the left control panel flex cable and check. If the problem persists, see the Getting help section.
Solid white	Indicates that iDRAC Quick Sync 2 is ready to communicate. Press the iDRAC Quick Sync 2 button to power off.	If the LED fails to power off, restart the system. If the problem persists, see the Getting help section.
Blinks white rapidly	Indicates data transfer activity.	If the indicator continues to blink indefinitely, see the Getting help section.
Blinks white slowly	Indicates that firmware update is in progress.	If the indicator continues to blink indefinitely, see the Getting help section.
Blinks white five times rapidly and then powers off	Indicates that the iDRAC Quick Sync 2 feature is disabled.	Check if iDRAC Quick Sync 2 feature is configured to be disabled by iDRAC. If the problem persists, see the Getting help section. www.dell.com/poweredgemanuals or <i>Dell OpenManage Server Administrator User's Guide</i> at https://www.dell.com/openmanagemanuals .
Solid amber	Indicates that the system is in fail-safe mode.	Restart the system. If the problem persists, see the Getting help section.
Blinking amber	Indicates that the iDRAC Quick Sync 2 hardware is not responding properly.	Restart the system. If the problem persists, see the Getting help section.

iDRAC Direct LED indicator codes

The iDRAC Direct LED indicator lights up to indicate that the port is connected and is being used as a part of the iDRAC subsystem.

You can configure iDRAC Direct by using a USB to micro USB (type AB) cable, which you can connect to your laptop or tablet. Cable length should not exceed 3 feet (0.91 meters). Performance could be affected by cable quality. The following table describes iDRAC Direct activity when the iDRAC Direct port is active:

Table 37. iDRAC Direct LED indicator codes

iDRAC Direct LED indicator code	Condition
Solid green for two seconds	Indicates that the laptop or tablet is connected.
Blinking green (on for two seconds and off for two seconds)	Indicates that the laptop or tablet connected is recognized.
Powers off	Indicates that the laptop or tablet is unplugged.

LCD panel

The LCD panel provides system information, status, and error messages to indicate if the system is functioning correctly or requires attention. The LCD panel is used to configure or view the iDRAC IP address of the system. For information about the event and error messages generated by the system firmware and agents that monitor system components, go to qrl.dell.com > **Look Up** > **Error Code**, type the error code, and then click **Look it up**.

The LCD panel is available only on the optional front bezel. The optional front bezel is hot pluggable.

The status and conditions of the LCD panel are outlined here:

- The LCD backlight is white during normal operating conditions.
- If there is an issue, the LCD backlight turns amber and displays an error code followed by descriptive text.
 - ⓘ **NOTE:** If the system is connected to a power source and an error is detected, the LCD turns amber regardless of whether the system is powered on or off.
- When the system powers off and there are no errors, the LCD enters the standby mode after five minutes of inactivity. Press any button on the LCD to power it on.
- If the LCD panel stops responding, remove the bezel and reinstall it.
 - If the problem persists, see [Getting help](#).
- The LCD backlight remains off if LCD messaging is powered off using the iDRAC utility, the LCD panel, or other tools.

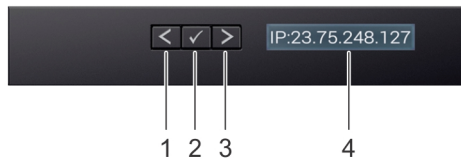

Figure 144. LCD panel features



Table 38. LCD panel features

Item	Button or display	Description
1	Left	Moves the cursor back in one-step increments.
2	Select	Selects the menu item highlighted by the cursor.
3	Right	Moves the cursor forward in one-step increments. During message scrolling: <ul style="list-style-type: none"> • Press and hold the right button to increase scrolling speed. • Release the button to stop. ⓘ NOTE: The display stops scrolling when the button is released. After 45 seconds of inactivity, the display starts scrolling.
4	LCD display	Displays the system information, status, and error messages or iDRAC IP address.

Viewing Home screen

The **Home** screen displays user-configurable information about the system. This screen is displayed during normal system operation when there are no status messages or errors. When the system turns off and there are no errors, LCD enters the standby mode after five minutes of inactivity. Press any button on the LCD to turn it on.

Steps

1. To view the **Home** screen, press one of the three navigation buttons (Select, Left, or Right).
2. To navigate to the **Home** screen from another menu, complete the following steps:
 - a. Press and hold the navigation button till the up arrow  is displayed.
 - b. Navigate to the **Home** icon  using the up arrow .

- c. Select the **Home** icon.
- d. On the **Home** screen, press the **Select** button to enter the main menu.

Setup menu

NOTE: When you select an option in the Setup menu, you must confirm the option before proceeding to the next action.

Table 39. Setup menu

Option	Description
iDRAC	Select DHCP or Static IP to configure the network mode. If Static IP is selected, the available fields are IP , Subnet (Sub) , and Gateway (Gtw) . Select Setup DNS to enable DNS and to view domain addresses. Two separate DNS entries are available.
Set error	Select SEL to view LCD error messages in a format that matches the IPMI description in the SEL. This enables you to match an LCD message with an SEL entry. Select Simple to view LCD error messages in a simplified user-friendly description. For information about the event and error messages generated by the system firmware and agents that monitor system components, go to qrl.dell.com > Look Up > Error Code , type the error code, and then click Look it up..
Set home	Select the default information to be displayed on the Home screen. See View menu section for the options and option items that can be set as the default on the Home screen.

View menu

NOTE: When you select an option in the View menu, you must confirm the option before proceeding to the next action.

Table 40. View menu

Option	Description
iDRAC IP	Displays the IPv4 or IPv6 addresses for iDRAC9. Addresses include DNS (Primary and Secondary) , Gateway , IP , and Subnet (IPv6 does not have Subnet).
MAC	Displays the MAC addresses for iDRAC , iSCSI , or Network devices.
Name	Displays the name of the Host , Model , or User String for the system.
Number	Displays the Asset tag or the Service tag for the system.
Power	Displays the power output of the system in BTU/hr or Watts. The display format can be configured in the Set home submenu of the Setup menu.
Temperature	Displays the temperature of the system in Celsius or Fahrenheit. The display format can be configured in the Set home submenu of the Setup menu.

NIC indicator codes

Each NIC on the back of the system has indicators that provide information about the activity and link status. The activity LED indicator indicates if data is flowing through the NIC, and the link LED indicator indicates the speed of the connected network.

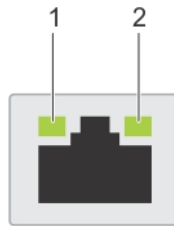

Figure 145. NIC indicator codes

1. Link LED indicator
2. Activity LED indicator

Table 41. NIC indicator codes

NIC indicator codes	Condition
Link and activity indicators are off.	Indicates that the NIC is not connected to the network.
Link indicator is green, and activity indicator is blinking green.	Indicates that the NIC is connected to a valid network at its maximum port speed, and data is being sent or received.
Link indicator is amber, and activity indicator is blinking green.	Indicates that the NIC is connected to a valid network at less than its maximum port speed, and data is being sent or received.
Link indicator is green, and activity indicator is off.	Indicates that the NIC is connected to a valid network at its maximum port speed, and data is not being sent or received.
Link indicator is amber, and activity indicator is off.	Indicates that the NIC is connected to a valid network at less than its maximum port speed, and data is not being sent or received.
Link indicator is blinking green, and activity is off.	Indicates that the NIC identify is enabled through the NIC configuration utility.

Power supply unit indicator codes

AC power supply units (PSUs) have an illuminated translucent handle that serves as an indicator. The indicator shows if power is present or if a power fault has occurred.

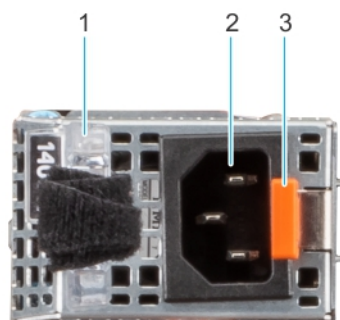

Figure 146. AC PSU status indicator

1. AC PSU handle
2. Socket
3. Release latch

Table 42. AC PSU status indicator codes

Power indicator codes	Condition
Green	Indicates that a valid power source is connected to the PSU and the PSU is operational.
Blinking amber	Indicates an issue with the PSU.
Not powered on	Indicates that the power is not connected to the PSU.
Blinking green	Indicates that the firmware of the PSU is being updated. ⚠ CAUTION: Do not disconnect the power cord or unplug the PSU when updating firmware. If firmware update is interrupted, the PSUs do not function.
Blinking green and powers off	When hot-plugging a PSU, it blinks green five times at a rate of 4 Hz and powers off. This indicates a PSU mismatch due to efficiency, feature set, health status, or supported voltage. ⚠ CAUTION: If two PSUs are installed, both the PSUs must have the same type of label; for example, Extended Power Performance (EPP) label. Mixing PSUs from previous generations of PowerEdge servers is not supported, even if the PSUs have the same power rating. This results in a PSU mismatch condition or failure to power on the system. ⚠ CAUTION: If two PSUs are used, they must be of the same type and have the same maximum output power. ⚠ CAUTION: When correcting a PSU mismatch, replace the PSU with the blinking indicator. Swapping the PSU to make a matched pair can result in an error condition and an unexpected system shutdown. To change from a high output configuration to a low output configuration or vice versa, you must power off the system. ⚠ CAUTION: AC PSUs support both 240 V and 120 V input voltages with the exception of Titanium PSUs, which support only 240 V. When two identical PSUs receive different input voltages, they can output different wattages, and trigger a mismatch.

Table 43. DC PSU status indicator codes

Power indicator codes	Condition
Green	Indicates that a valid power source is connected to the PSU, and the PSU is operational.
Blinking amber	Indicates an issue with the PSU.
Not powered on	Indicates that the power is not connected to the PSU.
Blinking green	When hot-plugging a PSU, it blinks green five times at a rate of 4 Hz and powers off. This indicates a PSU mismatch due to efficiency, feature set, health status, or supported voltage. ⚠ CAUTION: If two PSUs are installed, both the PSUs must have the same type of label; for example, Extended Power Performance (EPP) label. Mixing PSUs from previous generations of PowerEdge servers is not supported, even if the PSUs have the same power rating. This results in a PSU mismatch condition, or failure to power on the system. ⚠ CAUTION: If two PSUs are used, they must be of the same type and have the same maximum output power. ⚠ CAUTION: When correcting a PSU mismatch, replace the PSU with the blinking indicator. Swapping the PSU to make a matched pair can result in an error condition and an unexpected system shutdown. To change from a High Output configuration to a Low

Table 43. DC PSU status indicator codes (continued)

Power indicator codes	Condition
	<p>Output configuration or conversely, you must power off the system.</p> <p>CAUTION: Combining AC and DC PSUs is not supported.</p>

Drive indicator codes

The LEDs on the drive carrier indicates the state of each drive. Each drive carrier has two LEDs: an activity LED (green) and a status LED (bicolor, green/amber). The activity LED blinks whenever the drive is accessed.



Figure 147. Drive indicators

1. Drive activity LED indicator
2. Drive status LED indicator
3. Drive capacity label

NOTE: If the drive is in the Advanced Host Controller Interface (AHCI) mode, the status LED indicator does not power on.

NOTE: Drive status indicator behavior is managed by Storage Spaces Direct. Not all drive status indicators may be used.

Table 44. Drive indicator codes

Drive status indicator code	Condition
Blinks green twice per second	Indicates that the drive is being identified or preparing for removal.
Off	Indicates that the drive is ready for removal. NOTE: The drive status indicator remains off until all drives are initialized after the system is powered on. Drives are not ready for removal during this time.
Blinks green, amber, and then powers off	Indicates that there is an expected drive failure.
Blinks amber four times per second	Indicates that the drive has failed.
Blinks green slowly	Indicates that the drive is rebuilding.
Solid green	Indicates that the drive is online.
Blinks green for three seconds, amber for three seconds, and then powers off after six seconds	Indicates that the rebuild has stopped.

Using system diagnostics

If you experience an issue with the system, run the system diagnostics before contacting Dell for technical assistance. The purpose of running system diagnostics is to test the system hardware without using additional equipment or risking data loss. If you are unable to fix the issue yourself, service and support personnel can use the diagnostics results to help you solve the issue.

Dell Embedded System Diagnostics

NOTE: The Dell Embedded System Diagnostics is also known as Enhanced Pre-boot System Assessment (ePSA) diagnostics.

The Embedded System Diagnostics provide a set of options for particular device groups or devices allowing you to:

- Run tests automatically or in an interactive mode
- Repeat tests
- Display or save test results
- Run thorough tests to introduce additional test options to provide extra information about the failed device(s)
- View status messages that inform you if tests are completed successfully
- View error messages that inform you of issues encountered during testing

Running the Embedded System Diagnostics from the Dell Lifecycle Controller

Steps

1. As the system boots, press F10.
2. Select **Hardware Diagnostics** → **Run Hardware Diagnostics**.
The **ePSA Pre-boot System Assessment** window is displayed, listing all devices detected in the system. The diagnostics starts executing the tests on all the detected devices.

Running the Embedded System Diagnostics from Boot Manager

Run the Embedded System Diagnostics (ePSA) if your system does not boot.

Steps

1. When the system is booting, press F11.
2. Use the up arrow and down arrow keys to select **System Utilities** > **Launch Diagnostics**.
3. Alternatively, when the system is booting, press F10, select **Hardware Diagnostics** > **Run Hardware Diagnostics**.
The **ePSA Pre-boot System Assessment** window is displayed, listing all devices detected in the system. The diagnostics starts executing the tests on all the detected devices.

Results

System diagnostic controls

Table 45. System diagnostic controls

Menu	Description
Configuration	Displays the configuration and status information of all detected devices.
Results	Displays the results of all tests that are run.
System health	Provides the current overview of the system performance.
Event log	Displays a time-stamped log of the results of all tests run on the system. This is displayed if at least one event description is recorded.

Getting help

Topics:

- [Recycling or End-of-Life service information](#)
- [Contacting Dell](#)
- [Accessing system information by using QRL](#)
- [Receiving automated support with SupportAssist](#)

Recycling or End-of-Life service information

Take back and recycling services are offered for this product in certain countries. If you want to dispose of system components, visit www.dell.com/recyclingworldwide and select the relevant country.

Contacting Dell

Dell provides online and telephone based support and service options. If you do not have an active internet connection, you can find Dell contact information on your purchase invoice, packing slip, bill or Dell product catalog. The availability of services varies depending on the country and product, and some services may not be available in your area. To contact Dell for sales, technical assistance, or customer service issues:

Steps

1. Go to www.dell.com/support/home.
2. Select your country from the drop-down menu on the lower right corner of the page.
3. For customized support:
 - a. Enter the system Service Tag in the **Enter a Service Tag, Serial Number, Service Request, Model, or Keyword** field.
 - b. Click **Submit**.
The support page that lists the various support categories is displayed.
4. For general support:
 - a. Select your product category.
 - b. Select your product segment.
 - c. Select your product.
The support page that lists the various support categories is displayed.
5. For contact details of Dell Global Technical Support:
 - a. Click [Contact Technical Support](#).
 - b. The **Contact Technical Support** page is displayed with details to call, chat, or e-mail the Dell Global Technical Support team.

Accessing system information by using QRL

You can use the Quick Resource Locator (QRL) located on the information tag in the front of the R6525 system, to access information about Dell EMC PowerEdge R6525. There is also another QRL for accessing product information located on the top of the system cover.

Prerequisites

Ensure that your smartphone or tablet has the QR code scanner installed.

The QRL includes the following information about your system:

- How-to videos
- Reference materials, including the Installation and Service Manual, LCD diagnostics, and mechanical overview
- The system service tag to quickly access the specific hardware configuration and warranty information
- A direct link to Dell to contact technical assistance and sales teams

Steps

1. Go to www.dell.com/qrl, and navigate to your specific product or
2. Use your smart phone or tablet to scan the model-specific Quick Resource (QR) code on your system or in the Quick Resource Locator section.

Quick Resource Locator for PowerEdge R6525 system



Figure 148. Quick Resource Locator for PowerEdge R6525 system

Receiving automated support with SupportAssist

Dell EMC SupportAssist is an optional Dell EMC Services offering that automates technical support for your Dell EMC server, storage, and networking devices. By installing and setting up a SupportAssist application in your IT environment, you can receive the following benefits:

- Automated issue detection — SupportAssist monitors your Dell EMC devices and automatically detects hardware issues, both proactively and predictively.
- Automated case creation — When an issue is detected, SupportAssist automatically opens a support case with Dell EMC Technical Support.
- Automated diagnostic collection — SupportAssist automatically collects system state information from your devices and uploads it securely to Dell EMC. This information is used by Dell EMC Technical Support to troubleshoot the issue.
- Proactive contact — A Dell EMC Technical Support agent contacts you about the support case and helps you resolve the issue.

The available benefits vary depending on the Dell EMC Service entitlement purchased for your device. For more information about SupportAssist, go to www.dell.com/supportassist.

Documentation resources

This section provides information about the documentation resources for your system.

To view the document that is listed in the documentation resources table:

- From the Dell EMC support site:
 1. Click the documentation link that is provided in the Location column in the table.
 2. Click the required product or product version.
-  **NOTE:** To locate the product name and model, see the front of your system.
- On the Product Support page, click **Manuals & documents**.
- Using search engines:
 - Type the name and version of the document in the search box.

Table 46. Additional documentation resources for your system

Task	Document	Location
Setting up your system	<p>For more information about installing and securing the system into a rack, see the Rail Installation Guide included with your rail solution.</p> <p>For information about setting up your system, see the <i>Getting Started Guide</i> document that is shipped with your system.</p>	www.dell.com/poweredgemanuals
Configuring your system	<p>For information about the iDRAC features, configuring and logging in to iDRAC, and managing your system remotely, see the Integrated Dell Remote Access Controller User's Guide.</p> <p>For information about understanding Remote Access Controller Admin (RACADM) subcommands and supported RACADM interfaces, see the RACADM CLI Guide for iDRAC.</p> <p>For information about Redfish and its protocol, supported schema, and Redfish Eventing implemented in iDRAC, see the Redfish API Guide.</p> <p>For information about iDRAC property database group and object descriptions, see the Attribute Registry Guide.</p> <p>For information about Intel QuickAssist Technology, see the Integrated Dell Remote Access Controller User's Guide.</p>	www.dell.com/poweredgemanuals

Table 46. Additional documentation resources for your system (continued)

Task	Document	Location
	<p>For information about earlier versions of the iDRAC documents.</p> <p>To identify the version of iDRAC available on your system, on the iDRAC web interface, click ? > About.</p>	<p>www.dell.com/idracmanuals</p>
	<p>For information about installing the operating system, see the operating system documentation.</p>	<p>www.dell.com/operatingsystemmanuals</p>
	<p>For information about updating drivers and firmware, see the Methods to download firmware and drivers section in this document.</p>	<p>www.dell.com/support/drivers</p>
<p>Managing your system</p>	<p>For information about systems management software offered by Dell, see the Dell OpenManage Systems Management Overview Guide.</p>	<p>www.dell.com/poweredgemanuals</p>
	<p>For information about setting up, using, and troubleshooting OpenManage, see the Dell OpenManage Server Administrator User's Guide.</p>	<p>www.dell.com/openmanagemanuals > OpenManage Server Administrator</p>
	<p>For information about installing and using Dell SupportAssist, see the Dell EMC SupportAssist Enterprise User's Guide.</p>	<p>https://www.dell.com/serviceabilitytools</p>
	<p>For information about partner programs enterprise systems management, see the OpenManage Connections Enterprise Systems Management documents.</p>	<p>www.dell.com/openmanagemanuals</p>
	<p>Understanding event and error messages</p>	<p>For information about the event and error messages generated by the system firmware and agents that monitor system components, go to qrl.dell.com > Look Up > Error Code, type the error code, and then click Look it up.</p>
<p>Troubleshooting your system</p>	<p>For information about identifying and troubleshooting the PowerEdge server issues, see the Server Troubleshooting Guide.</p>	<p>www.dell.com/poweredgemanuals</p>

www.dell.com/qrl