

LED Display Installation Manual

IER / IFR Series

LH0****IER***LS

LH0****IER***FS

LH0****IFR***LS

LH0****IFR***FS

Revision History

Version	Date (Y/M/D)	Description
2.0	2020/03/20	New Release

Dehumidification guidance – during installation Samsung Electronics

- **When humidity get into LED package because of high humidity, it is possible to cause 'Line defect' by electrical short in side of LED Package.**
- **For keeping quality of products during installation, please refer below cautions.**
 - If one of below case meet before installation, MUST do dehumidification process.
 - Case when vacuum packaging is broken before unpacking.
 - Case when environment condition is exceed Samsung recommended operation condition. (Please refer Operation condition from User manual)
 - Case when period between unpacking and turning on the power of products is spent more than 7days, even though it is under Samsung recommended storage condition.
 - Case when production date on the label is exceed more than 6 months, even though vacuum packaging is no problem.
 - When Volatile chemicals such as oil paint, solvent are used or operation condition is exceed around of products installed place, MUST play video more than 2 hours everyday.
 - If it is not meet with upper cases, it is helpful to play video more than 2 hours everyday for protection for humidity getting into LED Package.

- **Electrical short in package is possible to happen during products are working.**
- **For keeping quality of products during installation, please refer below cautions.**
 - If one of below case meet during operation, MUST do dehumidification process.
 - Case when environment condition is exceed operation condition.
 - Case when products are not working more than 1 month, even though environment condition is under operation condition.
 - When environment condition is exceed operation condition, products are out of warranty. Please check environment condition.
 - Even products are operating, if the installed place have extra construction such as interior modification, MUST do dehumidification following installation condition.
 - It is possible to happen dew condensation on surface of products, even though working on operating condition. When happening dew condensation, MUST operate after cleaning the dew condensation & dehumidification.

- **Even though meet with Samsung recommended operation condition, dew condensation is possible to happen when surface of products is colder than environment temperature or hot & humid air blow to cooled surface of products.**
(cf : Principle of happening dew on surface of glass which have ice)
- **Case when dew condensation is happen on products, it is possible to be the root of defect. In this case, it is possible to be out of warranty.**

▪ When install products, please update latest firmware on online

- You can download latest firmware from SLM site.
 - URL of SLM Page : <https://www.secslm.com>
 - After login → Help → Download Center에서 Download
 - Before you download firmware, you MUST check same firmware of model (marked red letter in below) & upper number of version (marked blue in below).

Cabinet : Main - **L-xxxMWWAC-nnnn.n** → xxx = Pan name, nnnn.n = version
FPGA - **aabbb_ddddd** → aa = pixel pitch, bbb = LED package type, ddddd= version

Example : IER P2.5 → Cabinet : **L-IERMWWAC-1003.1**, FPGA : **25252-31046**

S-box : **TB-KTM2SBMDWWC_100x.x**

- You can update firmware through LSM.
 - Please refer '7-1 PC control program' for the way to update firmware.

1. Product Information and Installation Precautions (P.2)

2. Preparation for Cabinet Installation (P.12)

3. Frame Kit (P.16)

4. Frame Installation (P.17)

5. Cabinet + Frame Installation (P.25)

6. S-Box Connection (P.29)

7. Settings / How to Use (P.47)





8. Power and Cable Connection (P.63)

9. Seam Adjustment (P.72)

Appendix. IER-F/IFR-F series Installation Manual (72 page)

◇ Model Line-up

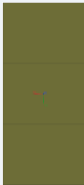
- This Manual is an Installation Manual for IER/IFR(Appendix. IER-F/IFR-F), which contains information of models below (Installation process is same for each pitch model)

Cabinet Size	IER (P2.0, P2.5, P4.0)	IFR (P2.5, P4.0)	
  960x540 (module 4x3)	LH020IER*LS LH025IER*LS LH040IER*LS	LH025IFR*LS LH040IFR*LS	Refer to Manual (P2~P72)
  240x540 (module 1x3)	IER-F (P2.0, P2.5, P4.0) LH020IER*FS LH025IER*FS LH040IER*FS	IFR-F (P2.5, P4.0) LH025IFR*FS LH040IFR*FS	Refer to Appendix (P73~P96)

- **IER** : Models for Mid-brightness(500~1000nit) with Copper wire LED
- **IFR** : Models for High-brightness(1000nit ↑) with Gold wire LED

※ **IER-F, IFR-F series** : Models for Non-Standard Screen (ex. Extend, L-shaped screen). Installation with IER/IFR of same pitch is recommended.

1. Product Information and Installation Precautions

Samsung Electronics

◇ Model specification

	Spec		IER / IFR			IER-F / IFR-F		
			P2.0	P2.5	P4.0	P2.0	P2.5	P4.0
Cabinet	Size	Width	960			240		
		Height	540			540		
	Resolution	Vertical	480	384	240	120	96	60
		Horizontal	270	216	135	270	216	135
	LED / Cabinet (Pixel)		64,800	82,944	32,400	16,200	20,736	8,100
	Module / Cabinet		12	12	12	3	3	3
	Weight(Cabinet)		IER : 12.4kg IFR : 12.4kg	IER : 10.8kg IFR : 12.4kg	IER : 10.8kg IFR : 12.4kg	3.2kg		
	Power consumption (W)		IER : 180W IFR : TBD	IER : 150W IFR : 260W	IER : 150W IFR : 260W	IER : 60W IFR : TBD	IER : 50W IFR : 80W	IER : 50W IFR : 80W
	Max number of connection (Set)	110V	IER : 3 IFR : TBD	IER : 4 IFR : 2	IER : 4 IFR : 2	IER : 10 IFR : TBD	IER : 10 IFR : 7	IER : 10 IFR : 7
		220V	IER : 6 IFR : TBD	IER : 7 IFR : 4	IER : 7 IFR : 4	IER : 20 IFR : TBD	IER : 20 IFR : 15	IER : 20 IFR : 15
FHD Screen	FHD		4x4, 16EA	5x5, 25EA	8x8, 64EA	16x4, 64EA	20x5, 100EA	32x8, 256EA
	UHD		8x8, 64EA	10x10, 100EA	16x16, 256EA	32x8, 256EA	40x10, 400EA	64x16, 1024EA

※ Installation with IER/IFR of same pitch is recommended. 8

1. Product Information and Installation Precautions

◇ Frame Kits configuration (See page 14.)

※ Please refer to Appendix for information of IER-F / IFR-F Frame Kit

Frame kit	Configuration for installation	Remarks
VG-LFR84FWL	8*4 (32 sets)	
VG-LFR53FWL	5*3 (15 sets)	
VG-LFR52SWL	5*2 (10 sets)	
VG-LFR51PWL	5*1 P (15 sets)	PIVOT installation
VG-LFR11SWL	1*1 (1 set)	Narrow

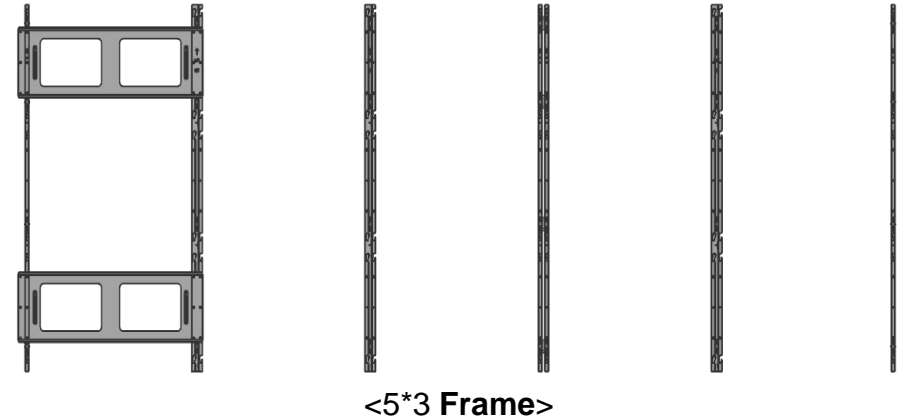

◇ Cabinet information

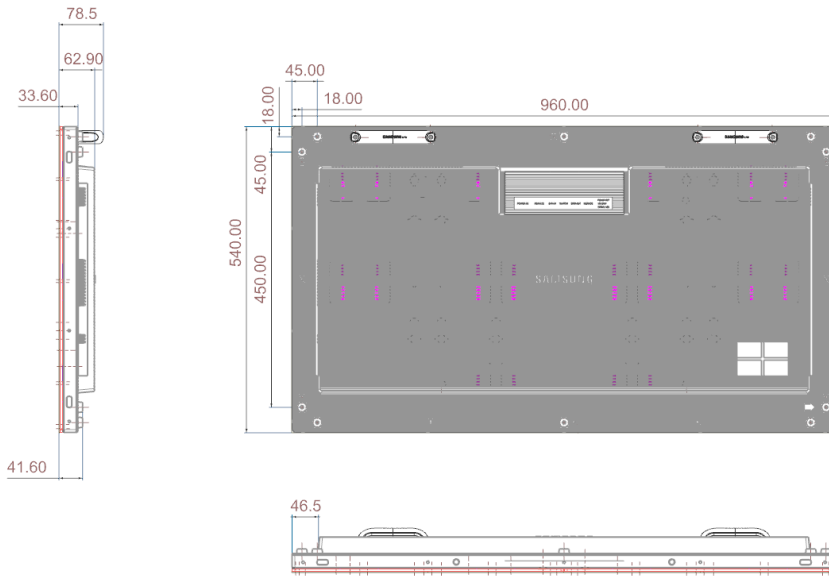

◇ SNOW-1810U (S-Box, I/G)

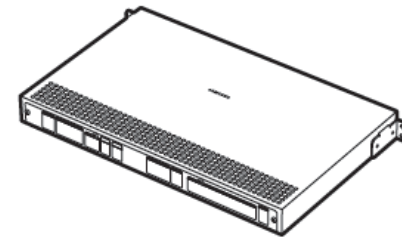



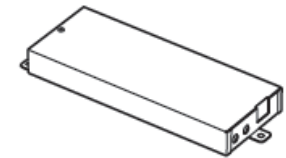



<S-Box>

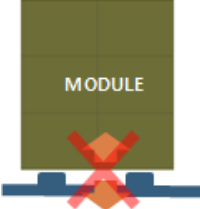
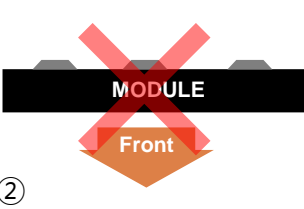

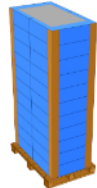
<I/G>
(Interface Gender)

◇ Installation precautions (LED damage)

Precautions	Images
<p>[Be careful of external impact or dropping]</p> <ol style="list-style-type: none"> ① After removing the Cover-Corner from the product prior to installation, exercise caution to ensure that the LED surface is not exposed to physical impact and the product is not dropped onto the floor. ② Do not place the product on a vibrating object. Make sure the LED surface does not face down onto the floor. ③ Exercise caution to ensure that the corners of the LED module are not damaged due to contact with external factors. ④ Make sure the number of loaded rows does not exceed 12. 	   
<p>[Be careful of LED damage due to static electricity]</p> <ul style="list-style-type: none"> ▶ Do not touch the LED surface with bare hands without anti-static gloves. 	 
<p>[Be careful of LED damage due to metallic foreign material]</p> <ul style="list-style-type: none"> ▶ Exercise caution to ensure that metallic foreign material is not attached to the LED front. ▶ If metallic foreign material is attached, remove the module and use a magnet to remove the foreign material. 	

◇ Heat protection guide

※ This page is written based on the Full white, 650 nit (back light 7) version

▪ Requirements for indoor installation

※ ADA: Americans with Disabilities Act

- Applicable to use of SAMSUNG wall mount (compliant with ADA)
 - Gap between the product front and the wall: 99.5 mm
 - Gap between the product rear and the wall: 35.5 mm
- Entry of sunlight
 - If sunlight enters through glass windows or outer walls of the building, contact Company HQ for assistance.
- Cold/warm air from HVAC system
 - Make sure cold or warm air (especially warm air) from an HVAC system does not reach the product.
- Outdoor temperature measurement position
 - Center of the product or the inlet area

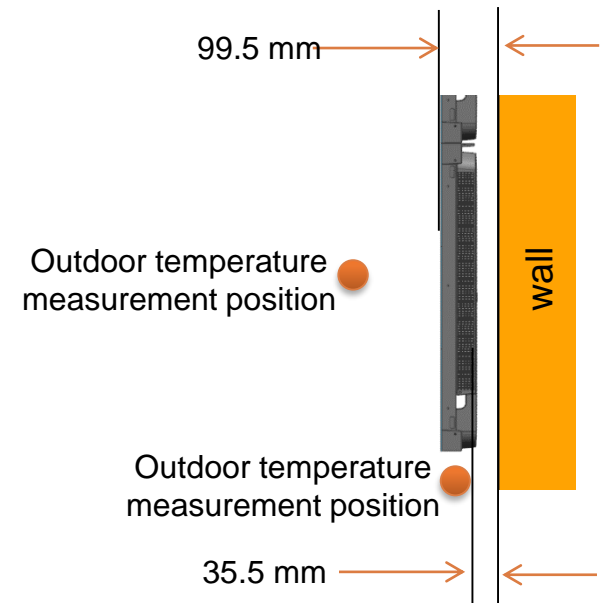

▪ Fan flow rate depending on the number of installed cabinet rows

※ CFM = cubic feet per minute

※ Measurement based on one column

No. of rows \ Outdoor air temp.	1 to 3 Rows	4 Rows	5 Rows	6 Rows	7 Rows	8 Rows	9 Rows	10 Rows
Below 25°C	Fan is not necessary	Fan is not necessary			70	80	90	100
25°C to 30°C		70	80	100	110	130	145	160

※ Example) If outdoor air temperature is 30°C and cabinets are arranged in a 5x4 (horizontal x vertical) configuration, what is the total CFM ?

→ 70 [CFM/column] x 5 [column]=**350 [CFM]**

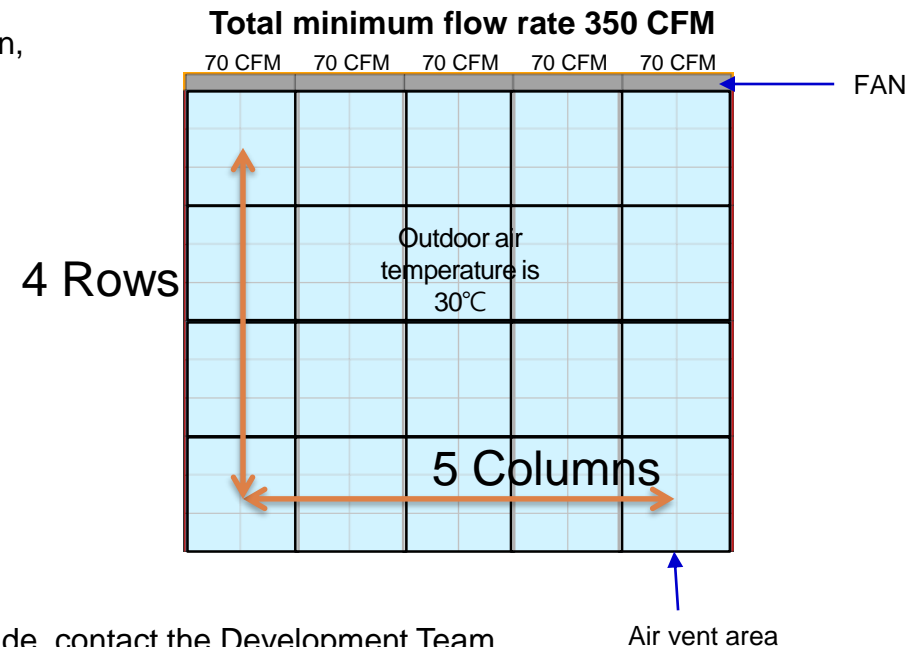

※ For installation under other conditions not covered in this guide, contact the Development Team.

■ Requirements for using FAN

- Air vent: Should only be installed on the bottom
- Upper portion: Seal the entirety, except the fan outlets

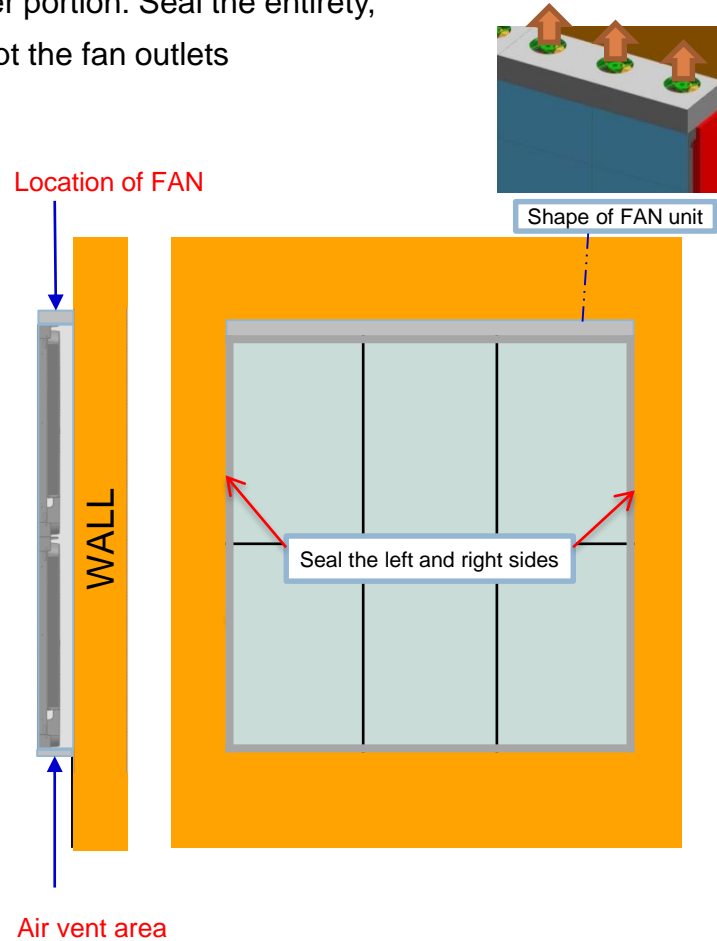

■ Vent requirements

- Use vents with an opening rate of at least 70%

- Opening rate (%) = $\frac{(c \times d) \times \text{No. of vent hole}}{A \times B}$

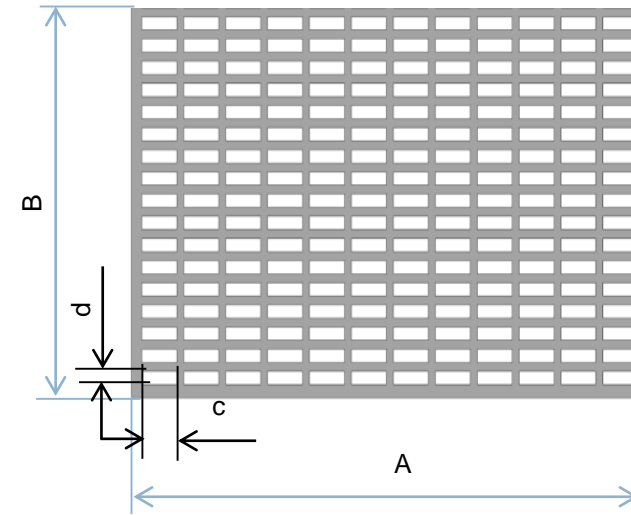

■ Minimum gap for embedded installation (Applicable when a fan is not used)

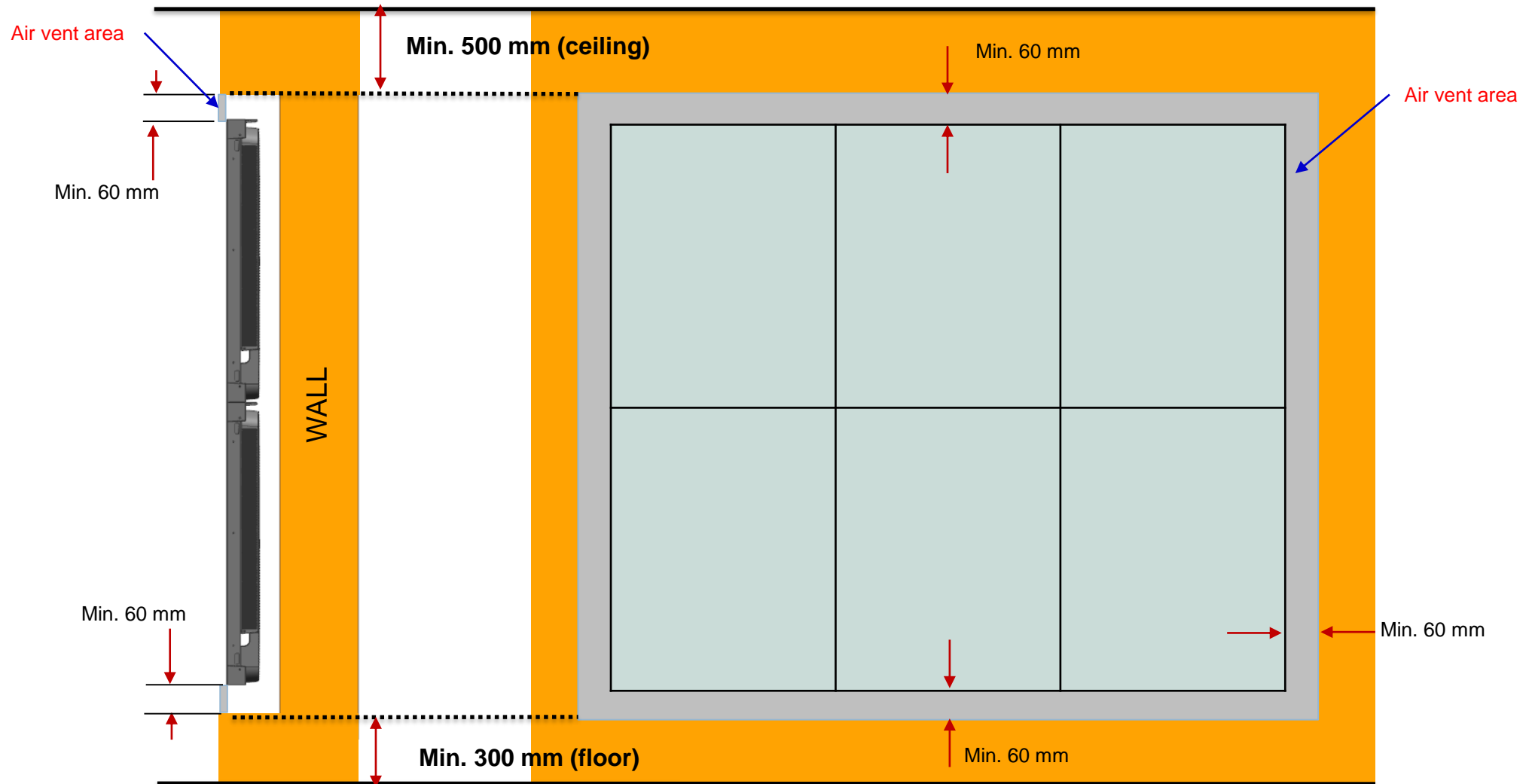

■ Minimum gap for installation on wall (Applicable when a fan is not used)

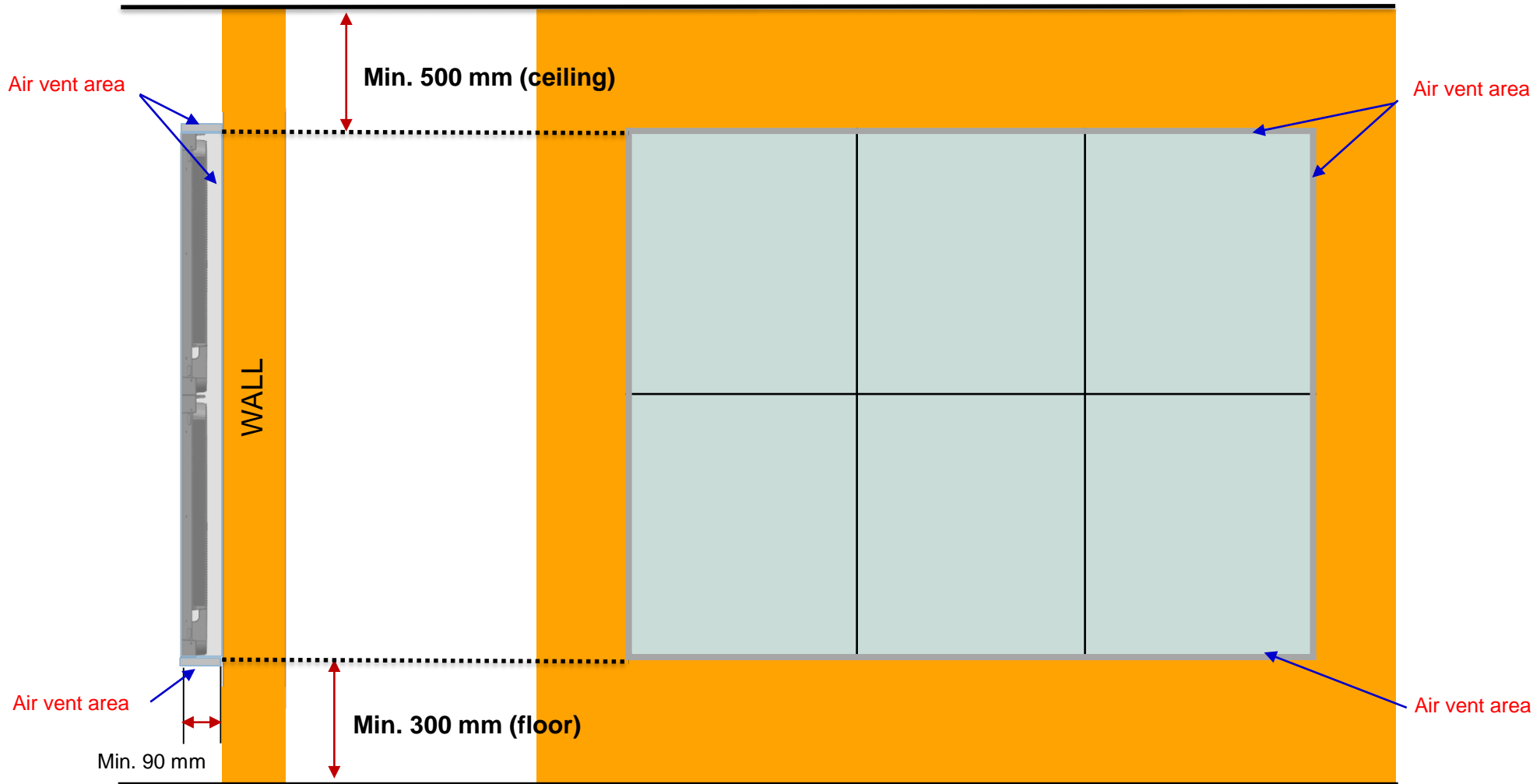

◇ Preparation for installation



Electric screwdriver



Phillips (+)
screwdriver

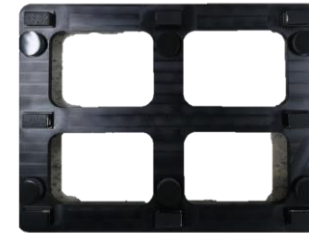

LED MODULE JIG
(model name: CY-LJRNL5)



Service JIG
(BH81-00001A)



Holder Magnet Tool



Pliers



Anti-static
gloves

2. Preparation for Cabinet Installation

◇ Preparation prior to installation

- ① Remove the tape on top of the package box and open the box. (See Fig.1.)
- ② Remove the Top-Cushion and open the shielding bag. Hold the handles inside, take out the set, and then remove the PE bag. (See Fig.2.)
- ③ Check that the sliding bolts are properly fastened. (See Fig.3.)

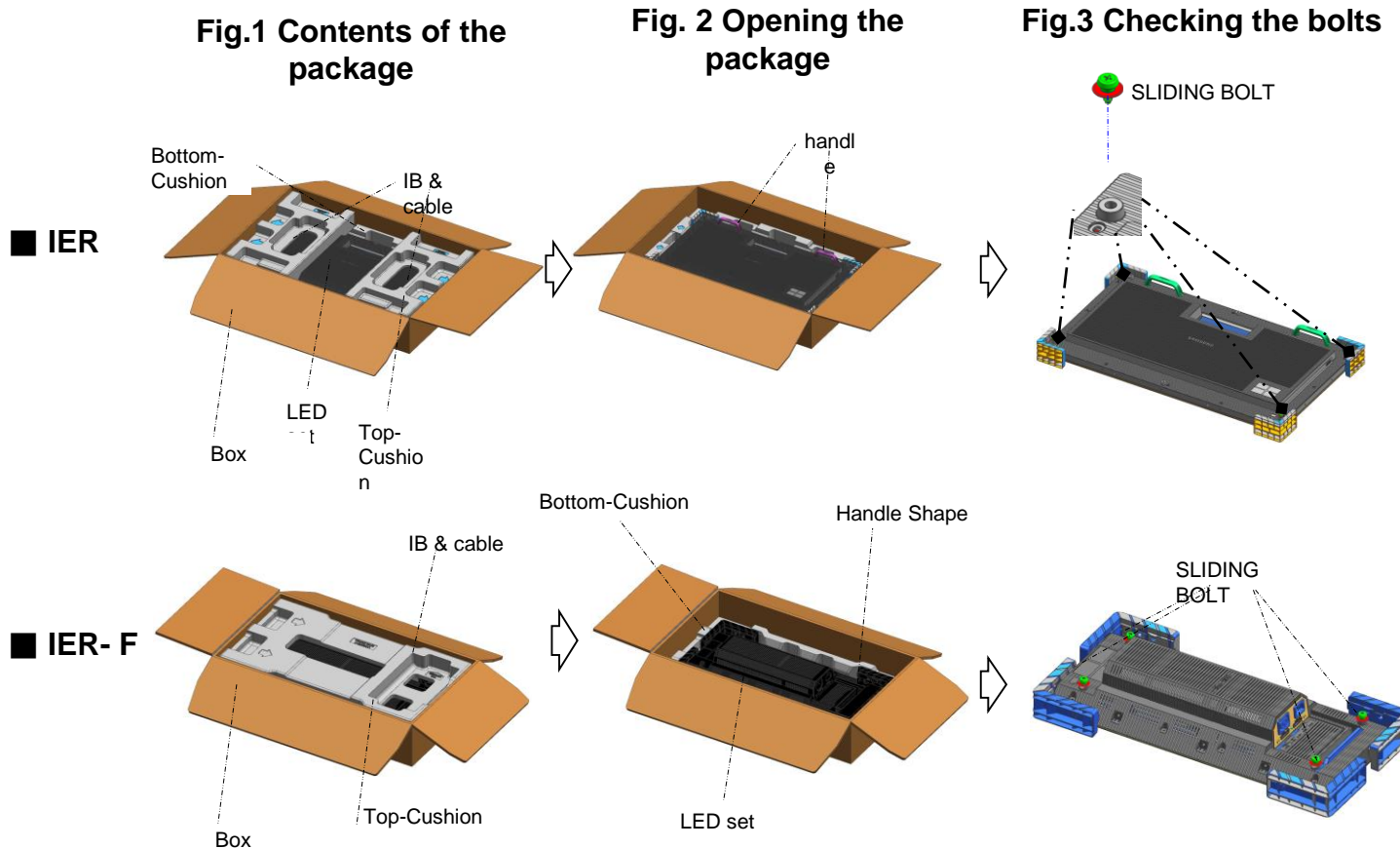

2. Preparation for Cabinet Installation

- ④ Connect the power and check for a problem with the screen. (See Fig.4.)
※ See page 12 for details on how to check for a screen problem.
- ⑤ Unfasten the screws (four screws in total) and remove the corner covers. (See Fig.5.)

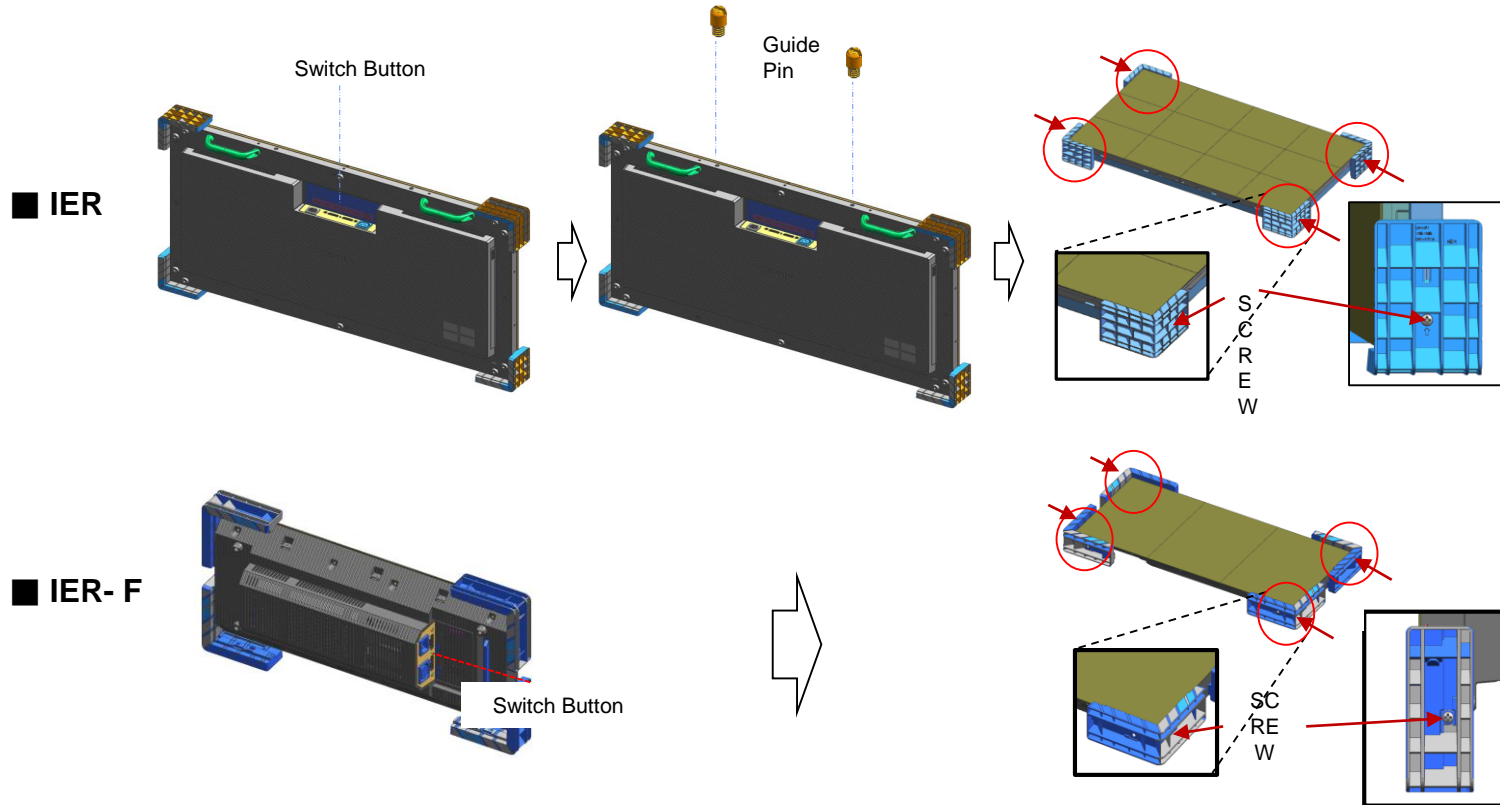
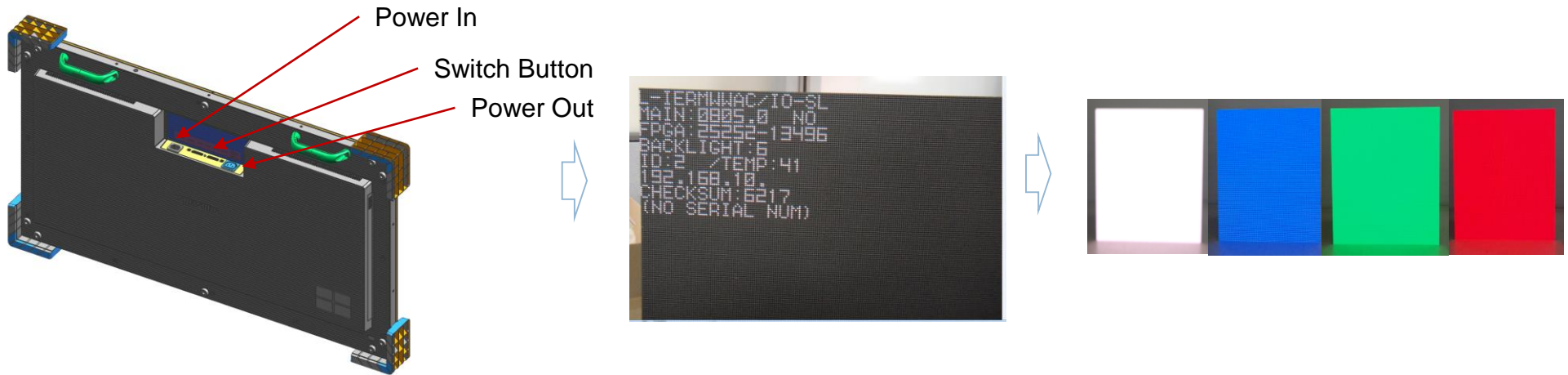

Fig.4 Checking the screen

Fig.5 Removing the corner covers

2. Preparation for Cabinet Installation

◆ Note: Checking for a screen problem



- ◇ Connect the power cord that came with the product and turn on the product.
Check that there is no LED damage and no problem is found on the screen.

※ Steps to perform in the event of White Pattern

- Apply power and press and hold the Switch for 5 seconds.
- When the factory info window appears, press the Switch once again.
- When the color screen appears, press the Switch repeatedly to check for malfunctioning LEDs.
(Each time the Switch is pressed, the LED color is switched in the following order:
white → blue → red → green.)
- To turn off the mode, press and hold the Switch for 5 seconds again.



IER

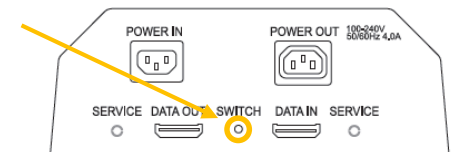

IER-F

2. Preparation for Cabinet Installation

⑧ For cabinets placed on the edge, attach PET sheet before attaching PCB covers.

※ Attach PET sheet to all borders of the LED module (Fig.1), and attach PCB covers to the same outer sides where the PET sheet has been attached (horizontally 5 points and vertically 4 points, **as shown by the blue borders in Fig.2**).

※ Attach PET sheet as shown in Fig.3. Make sure the area with no tape guides the LED module.

※ Attach PCB covers as shown in Fig.4.

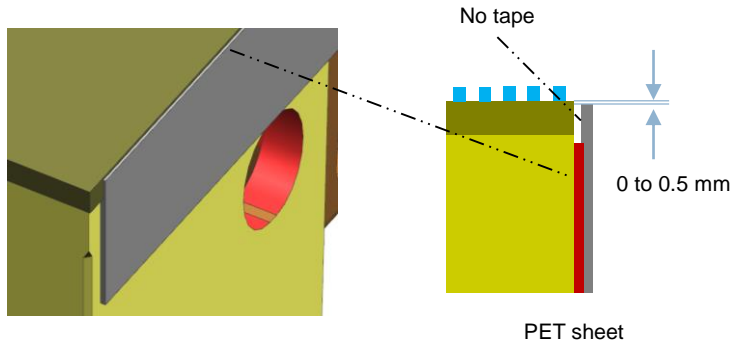

Fig.3

PET sheet
5x5 (5X3 + 5X2)

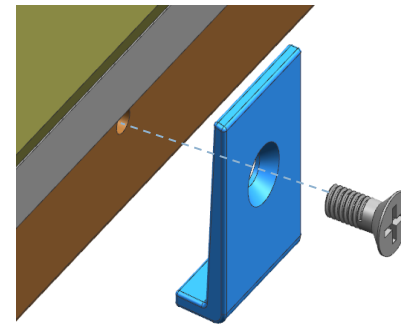

Fig.4

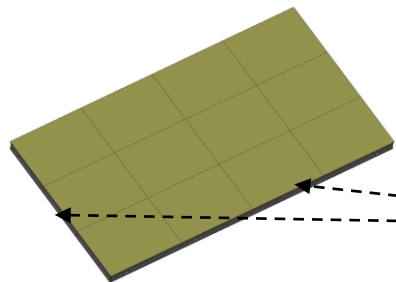

Fig.1 Attach PET sheet here

5	3	3	3	5
3				3
3				3
3				3
5	3	3	3	5

Fig.2 Borders requiring PET sheet and PCB covers

* Numeric figure: Quantity of PCB covers to attach

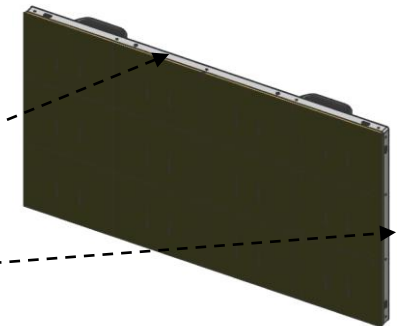

Fig.1 Attach PET sheet here

3. Frame Installation

① Make sure none of the following Frame Kit contents are missing.

※ Refer to attachment at last page for IER-F installation

No.	Item	VG-LFR84FWL	VG-LFR53FWL	VG-LFR52SWL	VG-LFR11SWL	VG-LFR51PWL
		Qty (+spares)				
		8X4	5X3	5X2	1X1	PIVOT
Ⓐ	ASSY BRACKET SIDE	2	2	2	2	2
Ⓑ	ASSY BRACKET MIDDLE	6	3	3	-	3
Ⓒ	ASSY BRACKET CENTER	1 (+1)	1 (+1)	1 (+1)	-	1 (+1)
Ⓓ	ASSY BRACKET JIG	2	2	2	-	1
Ⓔ	JOINT V	10	7	7	2	7
Ⓕ	ASSY ANCHOR SCREW	50	28	21	4	14
Ⓖ	QUICK INSTALL GUIDE	1	1	1	1	1
Ⓗ	Service JIG	1	1	1	-	-
Ⓘ	Wrench	1	1	1	1	1
Ⓝ	WASHER (SLIDING BOLT)	10	5	5	-	-
Ⓚ	BOLT – ETC	-	-	-	-	12
①	SCREW (M4)	20	14	14	4	14
Screen size for installation (mm)		7680X2160	4800X1620	4800X1080	960X540	2700X2880

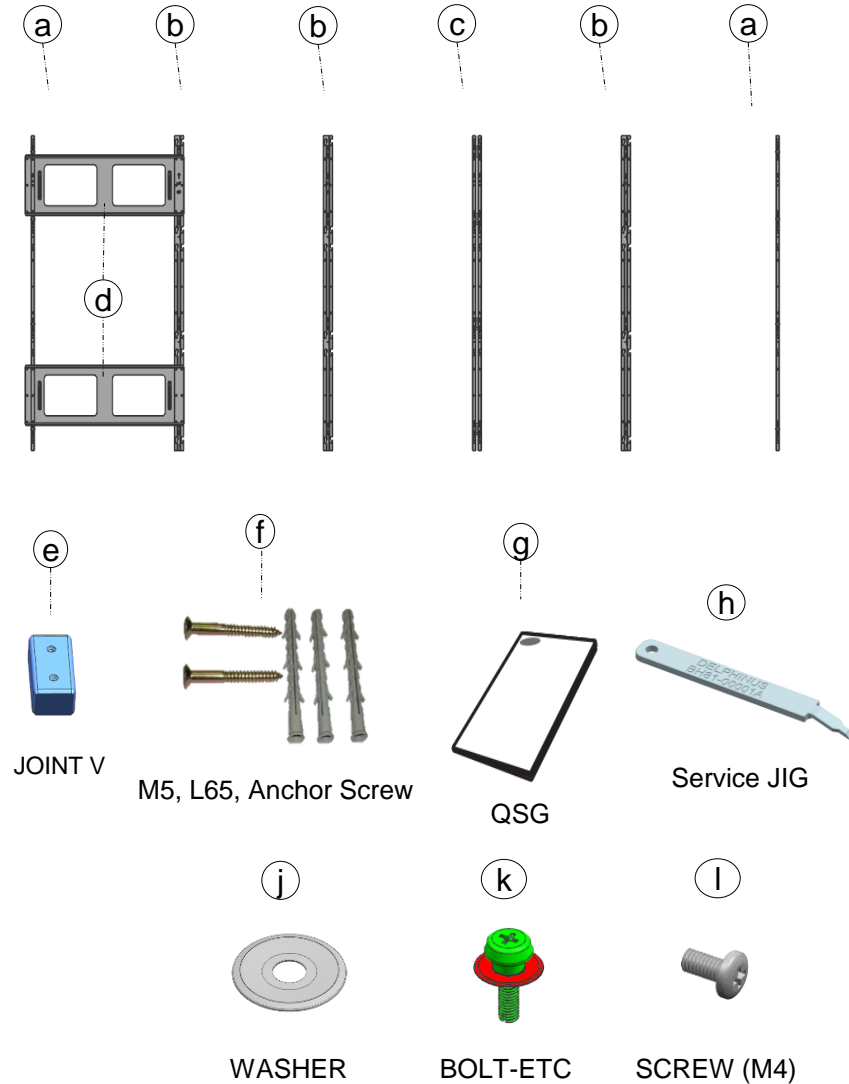

3. Frame Installation

② On the left end, place the ① Bracket Side and fasten the screws to install the Bracket (Fig.3).

※ Fasten one screw first, and use a clinometer to vertically align the right edges and fasten screws into the other holes.
 (See the next page for precautions when fastening screws.)

Fasten the screws in the order of screw 1 → screw 2 → screw 3. Fig.1

① Fix the Bracket Side, following the measurements shown in Fig.4.

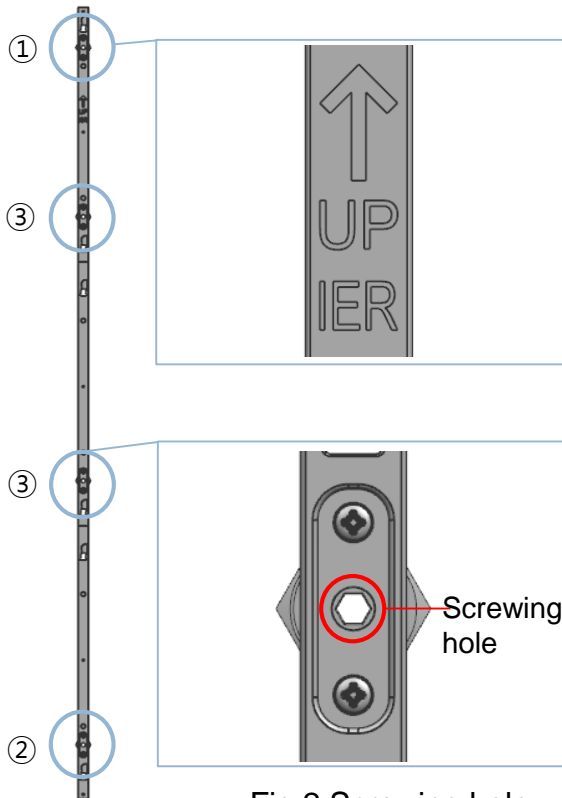

Fig.2 Screwing hole

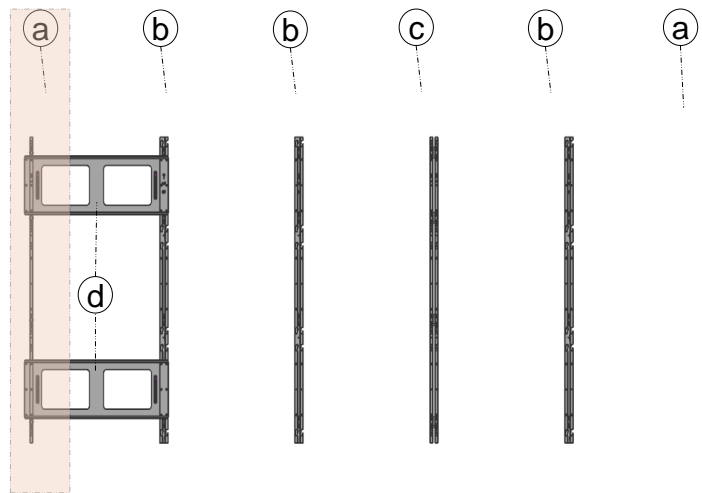

Fig.3 Positions of components to attach

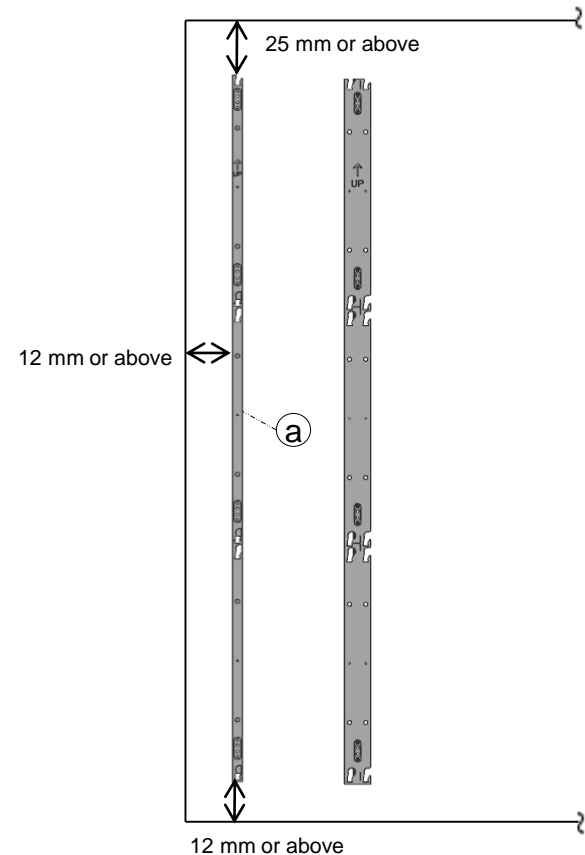

Fig.4 Screw fastening position based on screen

Fig.1 Order of fastening the screws

3. Frame Installation

⚠ Precautions when tightening screws

Standard installation requirements by wall type

⚠ Check the wall type before installation.

- Frames can be installed on a sufficiently thick concrete or interior wall. Refer to the following figures.

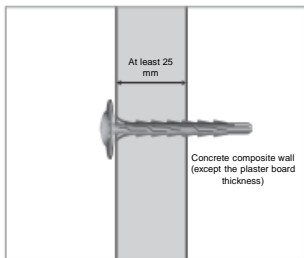
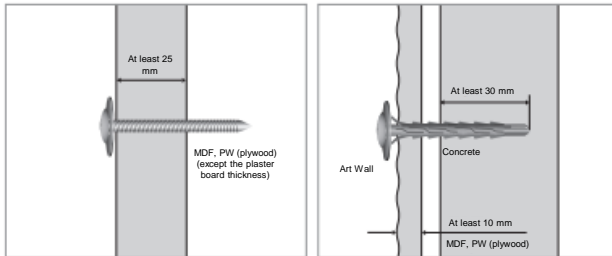
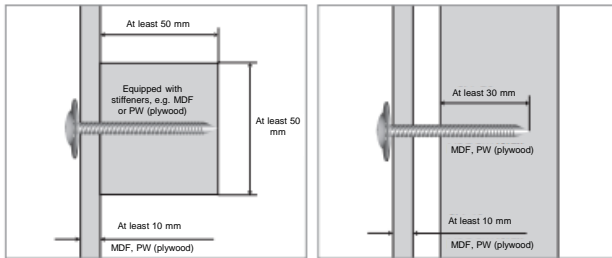

- **Note**
MDF = Medium Density Fiberboard
PW = Plywood

- First check the wall specifications (e.g. type, thickness, floor plan).

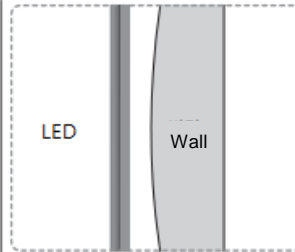

If installing frames on a wall that is not flat, irregular openings may develop and affect the exterior appearance.

① Sufficiently thick concrete or design wall

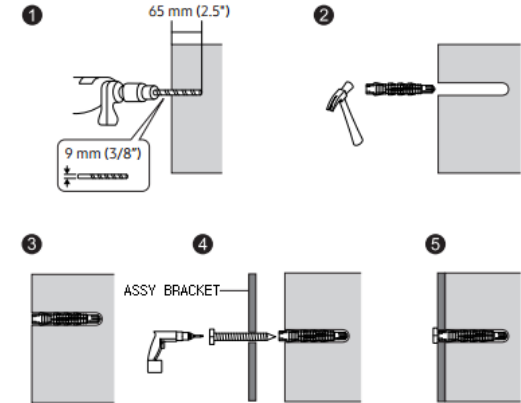
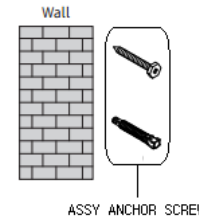

② Wood stud inside a plaster board, or MDF wall

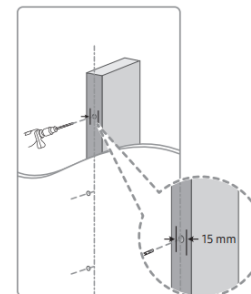
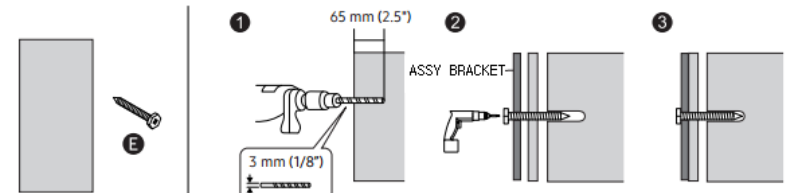

Installation requirements

- Make sure you check the location of the wood stud inside the wall before screwing screws into the wall.
- Minimum wood stud size: 51 x 102 mm (2 x 4 inches)
Drill holes (3 mm) before screwing screws into the wall.
- Make sure you drill screw holes in the middle of the wood stud.
- If you screw a screw directly into the wood stud without drilling a hole, the wood may crack.
- Standard wood stud interval of 16" is supported. (24" is not supported.)

⚠ Samsung Electronics is not responsible for problems caused as a result of failure to follow the requirements specified in the installation guide.

3. Frame Installation

③ Install the ⑥ Bracket Middle.

- ※ First, check the holes into which to fix the ④ JIGs. (See Fig.1.)
- ※ Next, align the ④ JIG with the bracket holes and fasten the four screws. (See Fig.2.)
- ※ Lastly, fasten the screws to fix the ⑥ Bracket Middle to the wall. (See Fig.3.)
- ※ Caution: The surface ④ should be attached to ① and ②. The three surfaces (the wall, ① and ②, and ④) should be in parallel. (See Fig.4.)

④ Use the same steps above to install all ⑥ Bracket Middle, in the left-to-right order.

- ※ Install the Bracket Center in the middle of the Frame Kit.

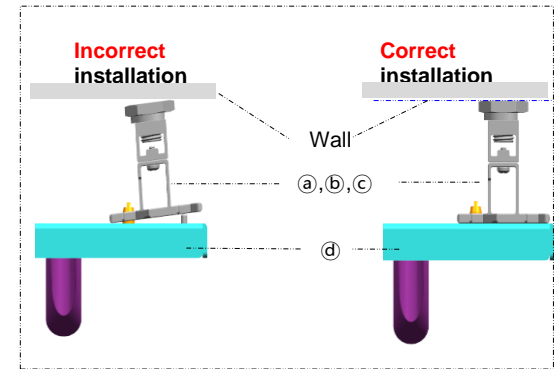

Fig4. Keeping frames parallel

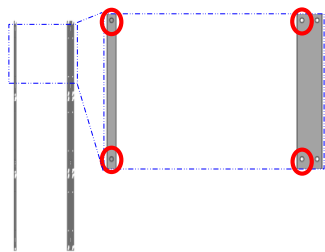

Fig1. Checking the holes

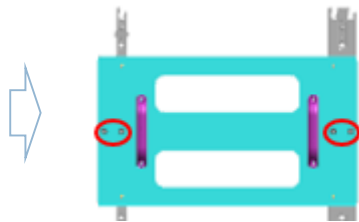

Fig2. Fixing the Jigs (with screws)

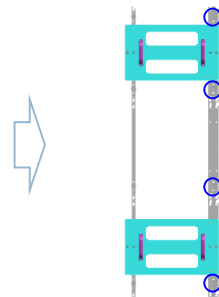

Fig3. Fastening the screws

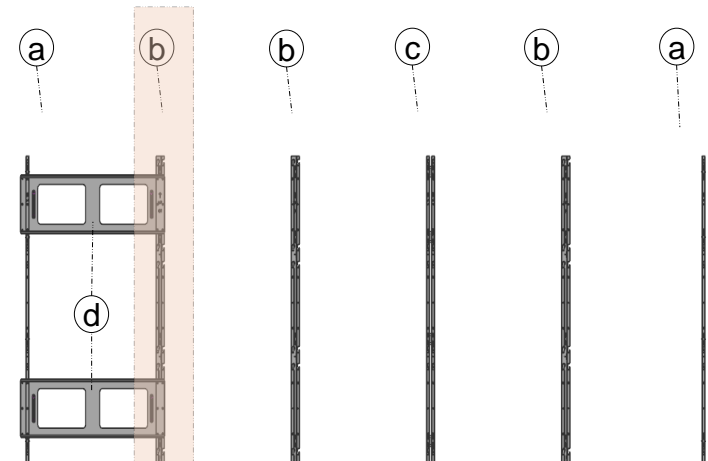

Fig.5 Positions of components to attach

3. Frame Installation

- ⑤ After installing the Bracket Center, install the lowest row cabinets. (See Fig.6.)
- ⑥ After installing the cabinets, push the LED modules toward the middle and check the height difference between the cabinets on both ends and the LED modules. (See Fig.7.)
- ⑦ Roughly adjust the height difference between the left and right sides, and make fine adjustment as shown below. (See Fig.8.)
 - If the height difference is greater than 0.5 mm, move the frame outwardly.
 - If the height difference is smaller than 0.0 mm, move the frame inwardly.
 - Adjust height difference each time an additional cabinet is installed.
It is not necessary to adjust a height difference in the 0.0 to 0.5 mm range.
- ⑧ After adjustment is completed, install the ② Bracket Middle.
(See step ② for details on how to install.)
- ⑨ Lastly, install the ① Bracket Side.

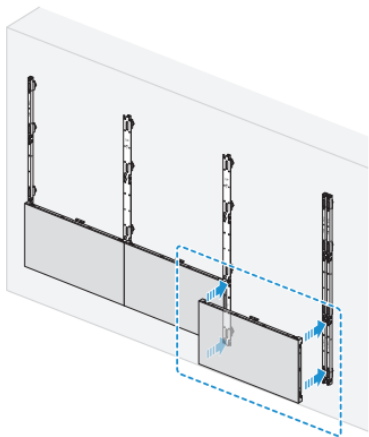

Fig.6 Installing cabinets

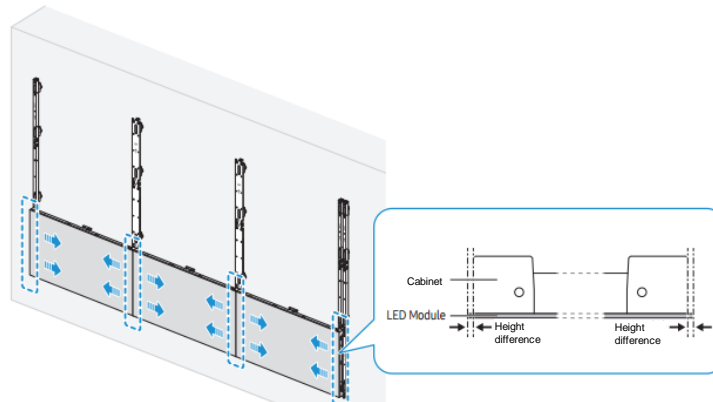

Fig.7 Checking height difference

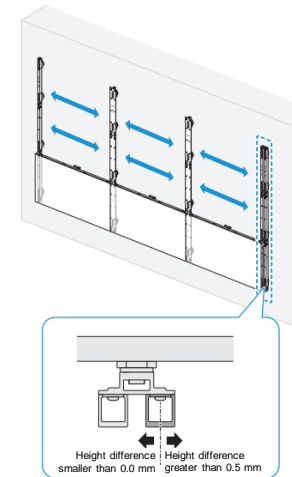

Fig.8 Adjusting height difference

4. Frame Installation – Adjusting the Frame Center (Important)

- Install the Frame Center after a Frame Side and two Frame Middles are installed based on the VG-LFR53FWL.
- Before installing **Frame Middle** next to the Frame Center, **be sure to** hang the IER Cabinet on the bottom line.
- Push the modules to the center and check the Frame Center so that there is no gap between cabinets and between modules.
- When the module's end is protruded more than 0.5 mm to the right based on the Frame Center, adjust the right side of Frame Center outward.
- When the module's end is protruded within 0.0 mm to the right based on the Frame Center, adjust the right side of Frame Center inward.
- When installed long left to right, repeat the above procedure whenever a Frame Center is installed.

✘ Otherwise, it may cause maintenance issues due to difficulty in attachment and detachment of a module.

Excessive attachment may cause the module's dislocation. (see page 26)

- ◆ Bracket Center's usable section,
VG-LFR53FWL: Every 3 rows
VG-LFR52SWL: Every 3 rows
VG-LFR84FWL: Every 4 rows

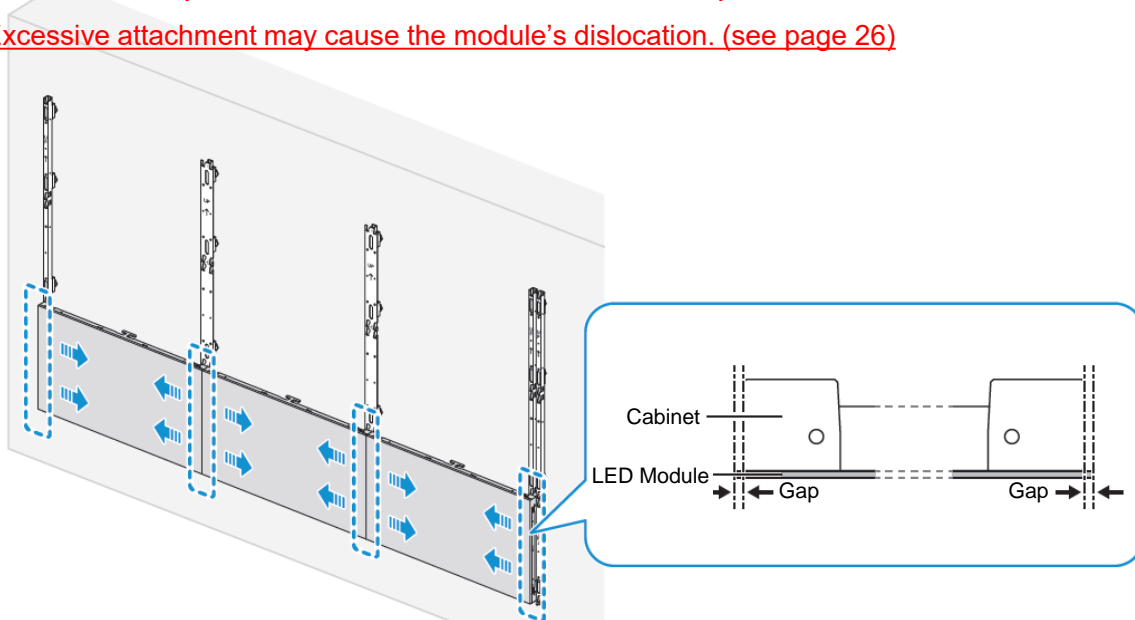

Fig.7 (check the gap)

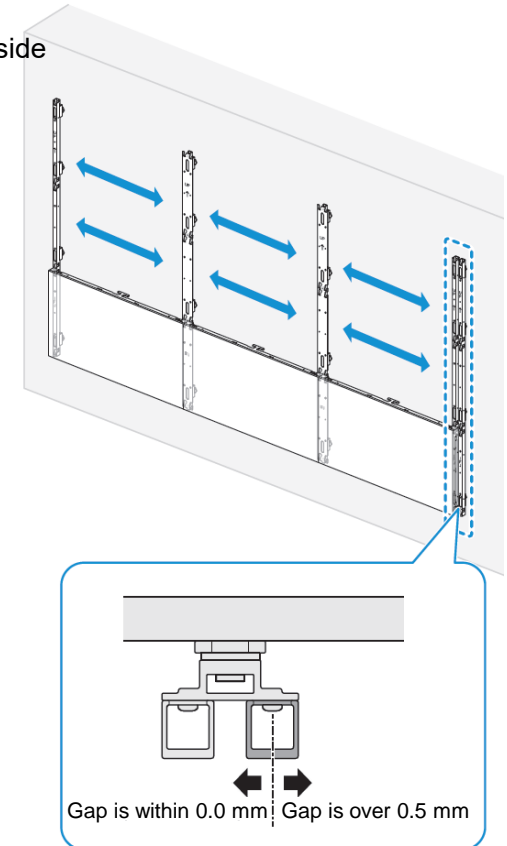

Fig.8 (adjust the gap)

3. Frame Installation

※ If installing three or more ASSY BRACKETs, adjust the flatness, because the wall or a structure may cause warping.

- After installing three or more ASSY BRACKETs, put a spare ASSY BRACKET horizontally and measure the height difference. If a height difference is found, adjust the Z-Bolts of the ASSY BRACKETs to adjust the flatness.

- How to adjust height

1. To adjust the height of a Z-Bolt of a frame, first remove the washer.
2. Use a 28 mm wrench to adjust the Z-Bolt height.

Flatness measurement positions:
Around areas where screws are fastened

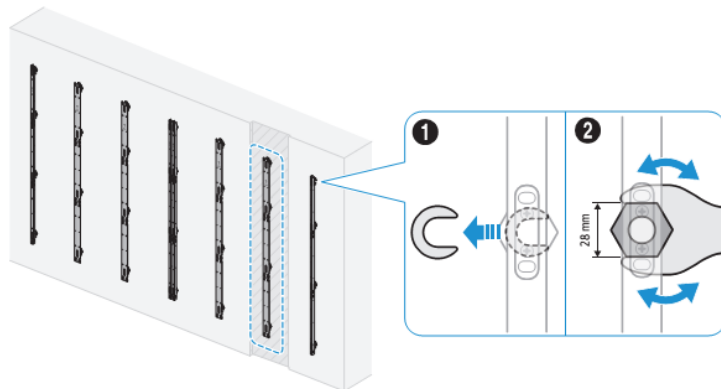
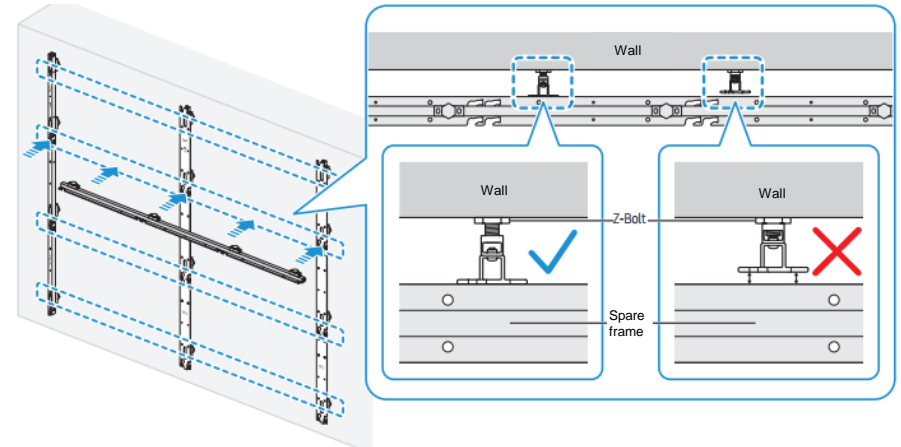

3. Frame Installation

※ The Frame Kit product can be installed by extending the size as required.

- Components can be extended horizontally or vertically for installation.
- When installing ASSY BRACKET JIGs for fixing the joints between ASSY BRACKETs, make sure two persons work together so that the ASSY BRACKET JIGs can be fixed properly.
(While one person holds an ASSY BRACKET JIG on the position to fix the JIG, the other person can fasten screws on the ASSY BRACKET JIG.)
- When performing extended installation, an ASSY BRACKET CENTER should be installed between the ASSY BRACKET MIDDLEs.
(It is recommended that one ASSY BRACKET CENTER be installed for three to four ASSY BRACKET MIDDLEs.)

3. Frame Installation

※ Vertical frame extension

- Attach the Joint V (vertical) to the target frame for extension
- Insert the joints of the additional frame into the existing frame. Insert jigs to place the frames into position.
- After attaching the jigs, fasten screws between the frames.

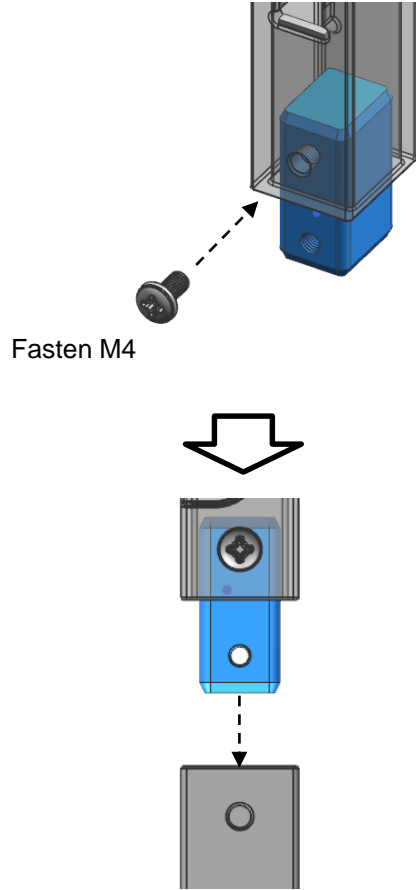

Fasten M4

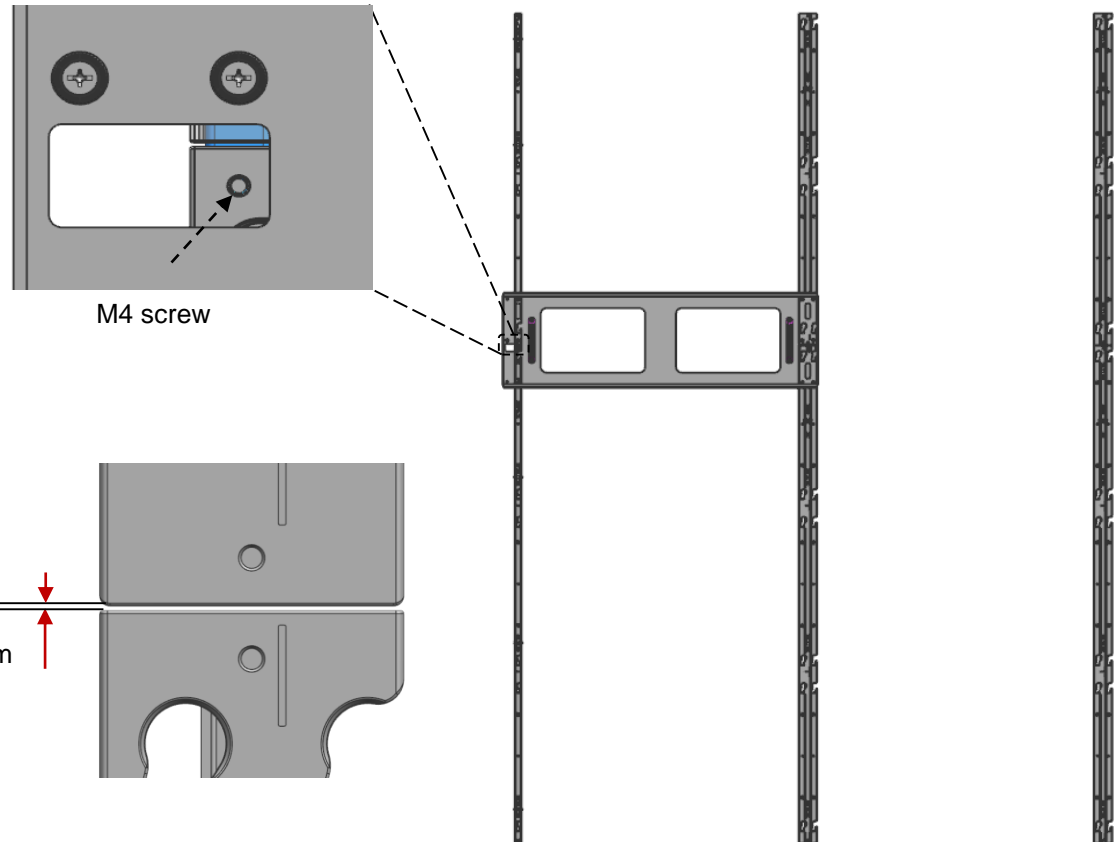

M4 screw

1 mm

<Vertical extension>

- Distance between connected frames for extension is 1 mm.

* FRAME 연장시 수직, 수평이 틀어지기 쉽다. 연장하면서 수평 수직 CHECK 를 반드시 해야한다. (레이저 수평계 / 실 등)

4. Cabinet + Frame Installation

◇ Fixing of I/G position

① Attach the I/G on the rear of each cabinet by type, first. (See Fig.1.)

※ Installation position: Place the I/G at a spot 35–40 mm below the engraving on the right-side frame, and fasten the screws (Fig.2).

5x5 (5X3 + 5X2)

21	22	23	24	25
16	17	18	19	20
11	12	13	14	15
I/G 6	7	8	9	10
1	2	3	4	5

Fig1. I/G attachment position / order of installing cabinets

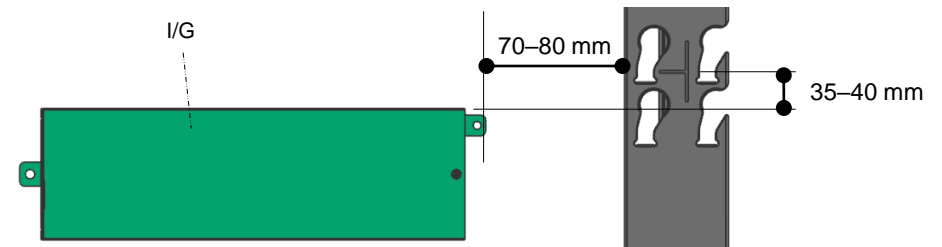
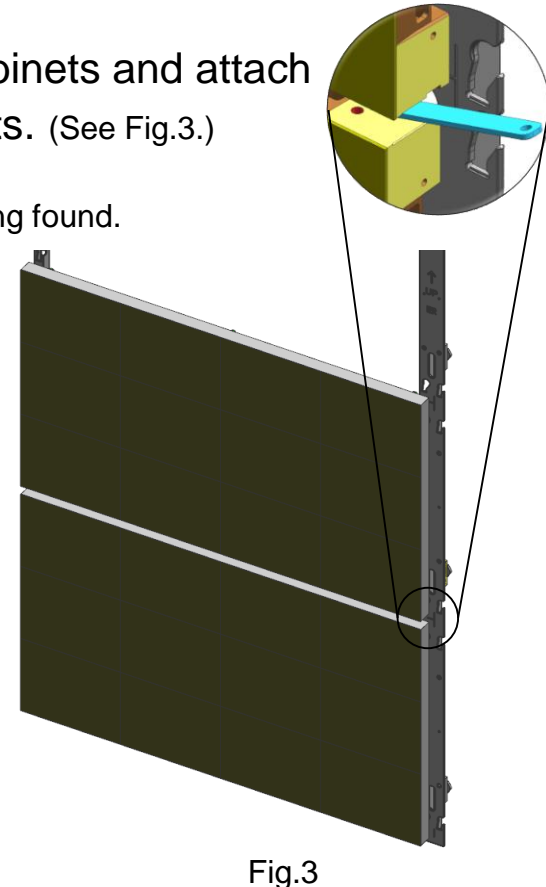
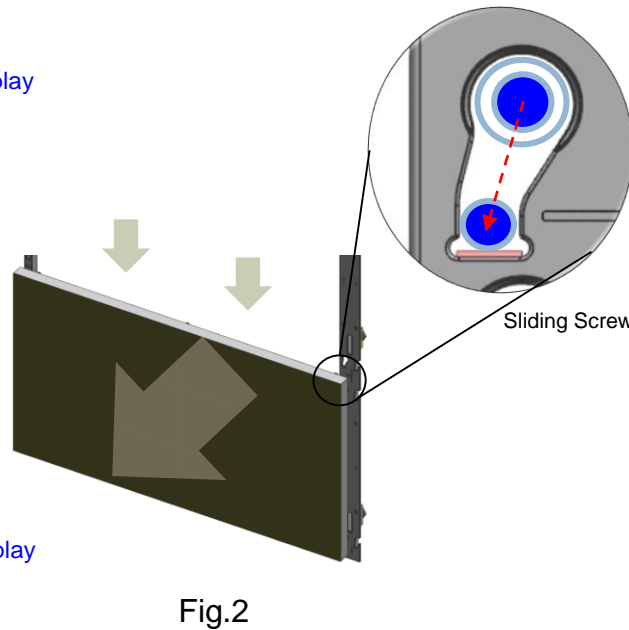
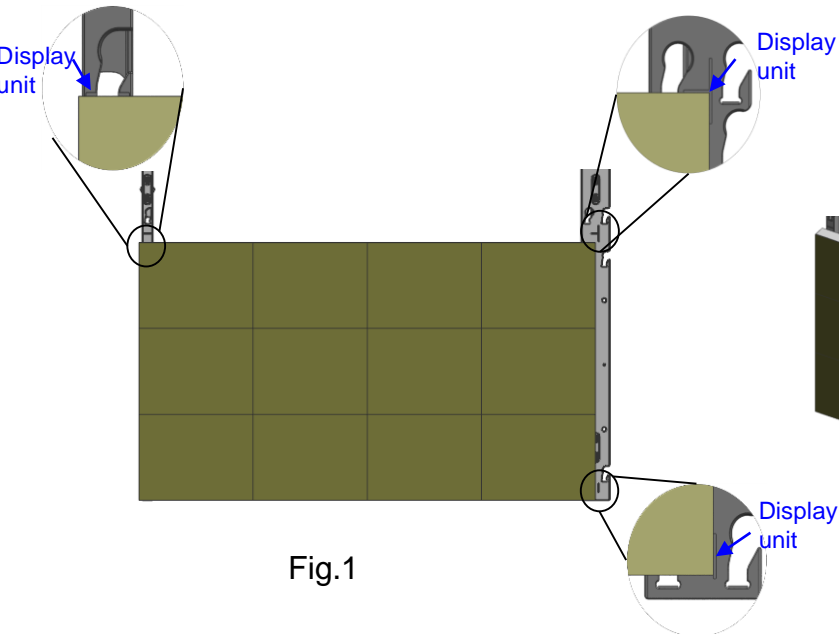

Fig2. I/G attachment position

4. Cabinet + Frame Installation

- ② Draw the cabinet right up against the frames by aligning the cabinet corners with the engravings on the frames.
 - ※ For the order of installing cabinets, see Fig. 1 on page 22 .
 - ※ Check that the four bolts are all inserted into the frames. (See Fig.1.)
- ③ Push the top surface of the cabinet corners down so that the cabinet slides down diagonally. (See Fig.2.)
- ④ From the second row and above, insert the Service Jig between the cabinets and attach the cabinets. Next, remove the Service Jig and slowly lower the cabinets. (See Fig.3.)
 - ※ Exercise caution to ensure that the Service Jig does not touch an LED module.
 - ※ Each time a cabinet is installed, check that there is no inter-module gap or pitch interval warning found.



5. Cabinet + Frame Installation

- ⑤ When modules are tightly coupled, it becomes difficult in detaching a module. Accordingly, sample some modules during installation to check whether module detachment is possible. ★Important

※ Otherwise, it may cause maintenance issues due to difficulty in attachment and detachment of a module. Excessive action may cause damage to the module. Sampling is recommended for every 2- to 3-row cabinets.

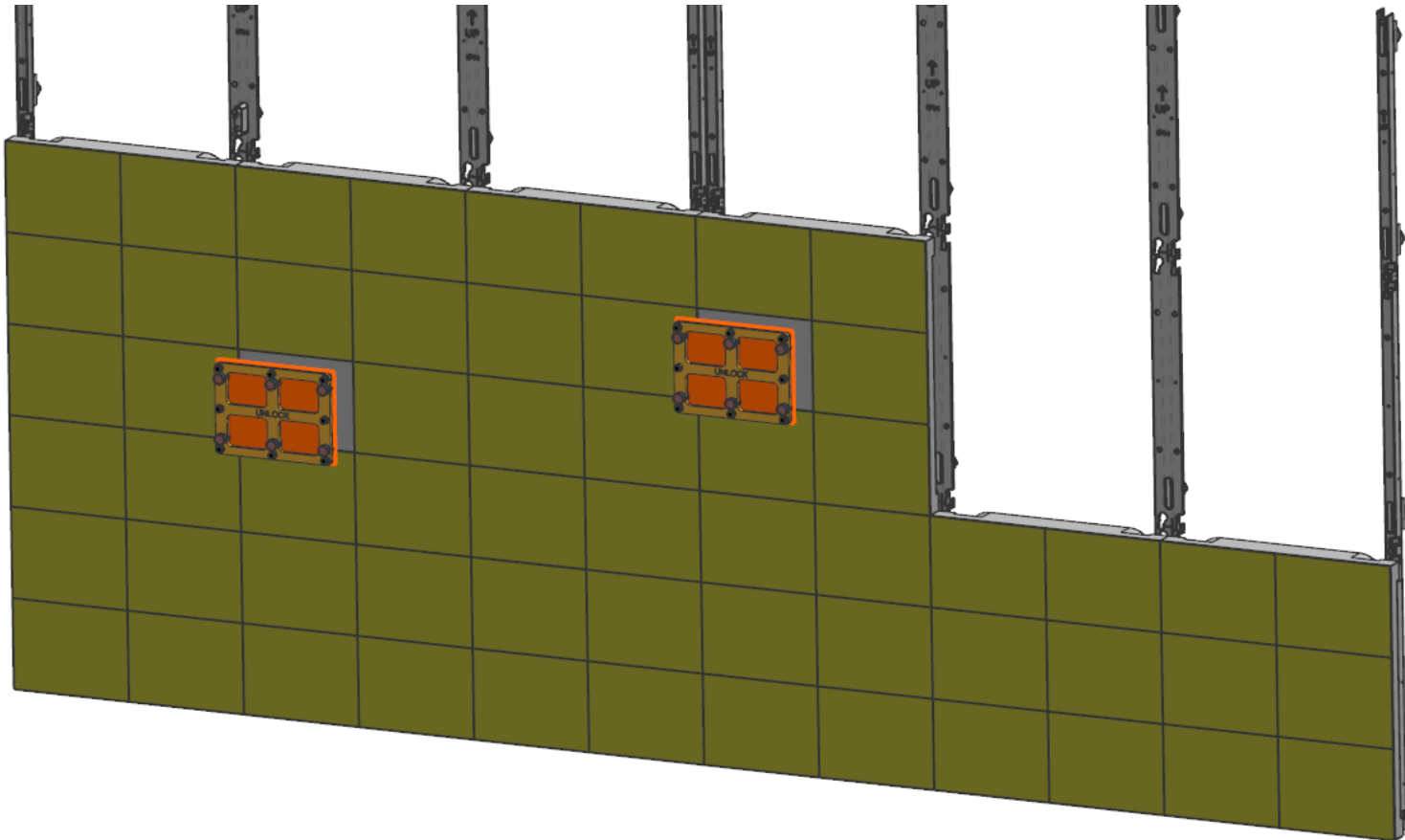

4. Cabinet + Frame Installation

◇ PIVOT installation

When installing the PIVOT, use the PIVOT-specific Frame Kit.
(**VG-LFR51PWL** / the same installation steps apply)

- ① Check that the BOLT ETCs are fastened. **(Fig.1)**
- ② Fasten the BOLT ETCs again appropriately for PIVOT installation. Fasten two additional bolts and remove the COVER HANDLES. **(Fig.2)**
- ③ Install with the arrow pointing up, by referring to the engraving indicating the direction.

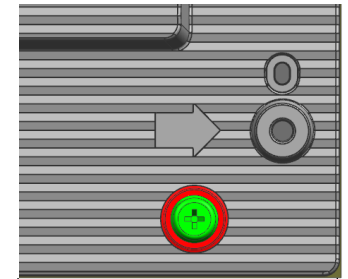

Engraving indicating the PIVOT direction

Remove the COVER HANDLES

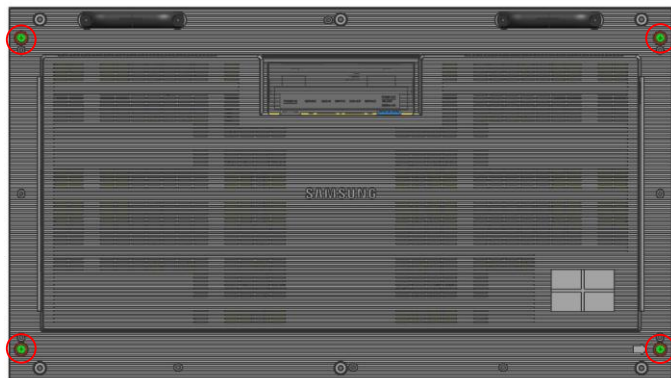

Fig1. Positions of BOLT ETCs fastened in delivered product

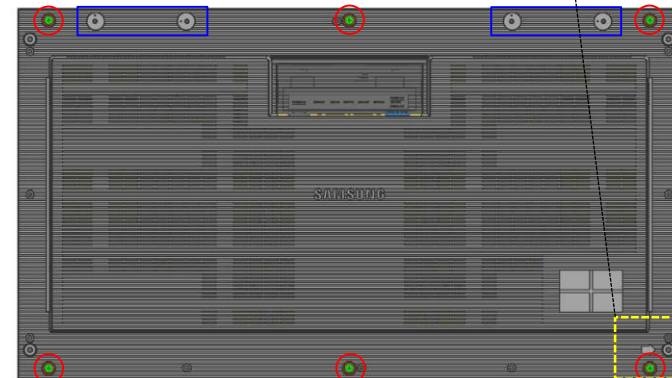
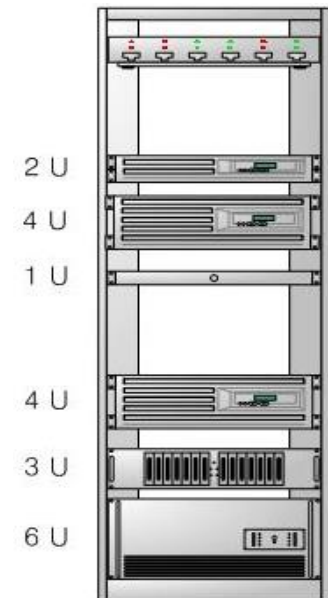
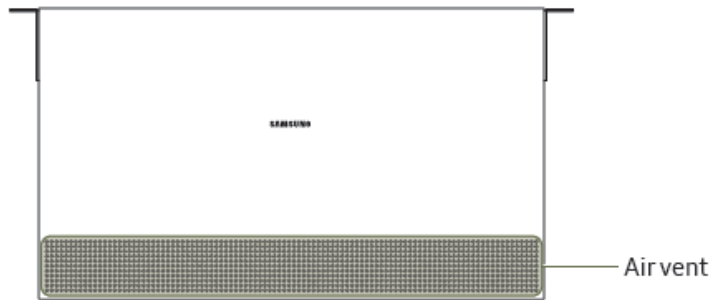

Fig2. Positions to fasten BOLT ETCs when installing the PIVOT

5. S-Box Installation and Connection

• Precautions for installing S-Box

- ① Installing it in a 19-inch server rack is recommended.
※ When connecting two or more sets for Multi-link HDR, install them in the six-sided shield rack. (Only SBB-SNOWJMU)
- ② Make sure the air vent is open and not overturned or turned sideways.
- ③ Exercise caution to ensure that the air vent is not covered by an object. Covered air vent may cause overheating of the product.
- ④ If installing multiple S-Boxes, make sure there is a gap of at least 1U (44.45 mm) from the product at the top.
- ⑤ If installing an S-Box onto a wall, make sure there is a gap of at least 10 mm between the wall and the top, bottom and sides of the product. Make sure there is a gap of at least 50 mm between the cable ports and the wall to ensure proper cable connection.
- ⑥ Maintain the residual heat inside the rack at a temperature below 35°C.
- ⑦ Exercise caution to ensure that no liquid enters the air vent of the product.



5. S-Box Installation and Connection

• S-Box connection

- ① Send visual signal input into the S-Box (input ports: HDMI, DP).
- ② Use the SOURCE STATUS to check the signal input (Red: HDMI1, Green: HDMI2, Blue: DISPLAY PORT).
- ③ Use the LAN cable to connect the HDBT OUT port on the S-Box to the HDBT IN port on the Interface Gender.
- ④ Use the OCM cable to connect the DATA OUT port on the Interface Gender to the DATA IN port on the first cabinet.
- ⑤ Please add input signal with “Input signal Plus” menu for UHD resolution

※ Menu – Picture – Advanced Settings – Input signal plus : add input signal

(The default setting is OFF. If this setting is changed, the S-Box is rebooted.)

- ⑥ The screen is displayed based on the cabinet in the top left.
To view the screen, connect to the HDBT OUT1 port on the S-Box.
- ⑦ For each S-Box, the same type pitch cabinet can only be supported simultaneously. When installing the product, only connect compatible cabinets to the product.

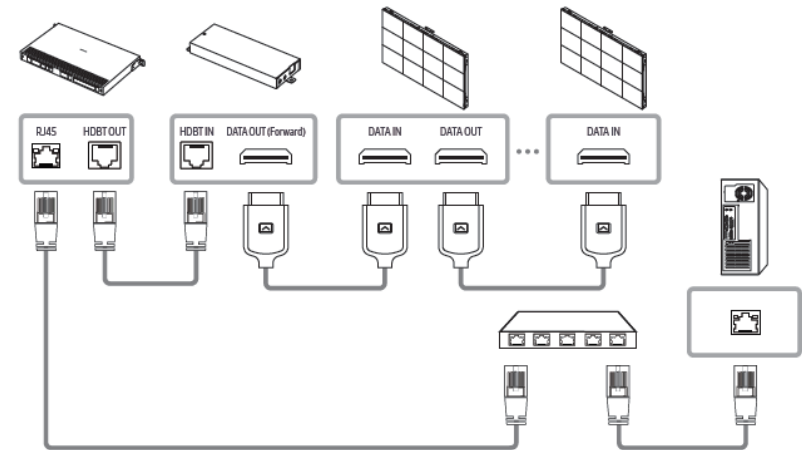

- Use *STP and *FTP level cables better than 15–100 m long CAT 6 to ensure HDBT signal stability.
- Do not use CAT 6 UTP cables.
- Do not bend cables excessively.
- Do not bind multiple cables together.

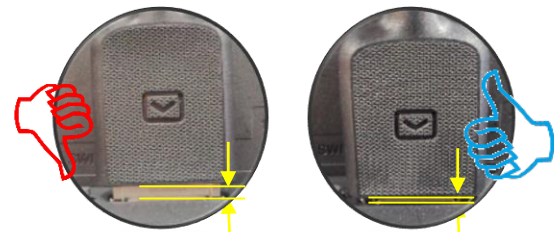

5. S-Box Installation and Connection

⑧ Cable recommendations for HDBaseT

- Do not use “comb” or “pinstripe” type cables.

- Use HDBaseT cables that are 15 m to 100 m long.

- Use HDBaseT Cables recommended at the following Alliance website.

HDBaseT Alliance website: <https://hdbaset.org/hdbaset-recommended-cables/>

- Do not bend HDBaseT cables to ensure signal consistency.

- When organizing HDBaseT cables, make sure the cables are not tied too tight.

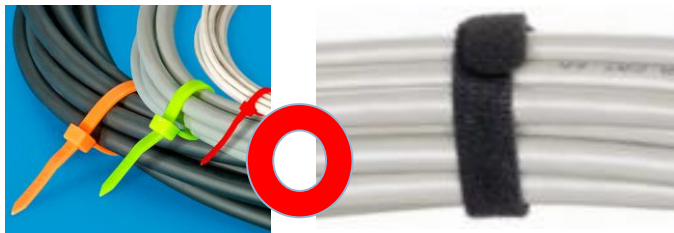

- Do not bind HDBaseT cables and AC power cables together.

★ Orderly Rolled (Recommend)



★ Random Rolled (Not Recommend)



5. S-Box Installation and Connection

⑧ HDBaseT cable

- EMI sources: Ensure that the product is placed away from the electromagnetic environment (e.g. high-voltage wires, electric motor-based equipment such as an elevator or refrigerator, fluorescent lights, lighting fixture).
- Keep a distance of at least **12" (=30.48cm)** between HDBaseT cables and AC power cables.
- **A maximum of four cables** connected to a single S-Box can be bounded together.

5. S-Box Installation and Connection

⑨ Finishing the HDBaseT cable after installation

- **Using shielded STP RJ45:** Use a shielded RJ45 connector, and a CAT 6 or CAT 7 connector using a plastic load bar.



- **Insertion of conductors (conducting wires) into plastic loader:** Insert conducting wires into the RJ45 connector, as shown by the conducting wire structure (T-568B) in the following figure. **Plastic load** bar is required. (The reason is that the thickness of a CAT 6 cable prevents the cable from being placed flatly in an RJ-45 connector, unlike general CAT 5 cables.)

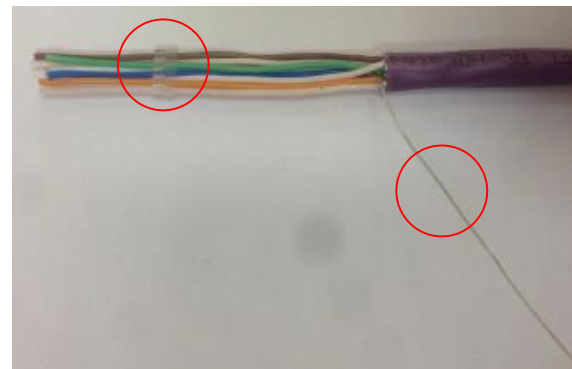
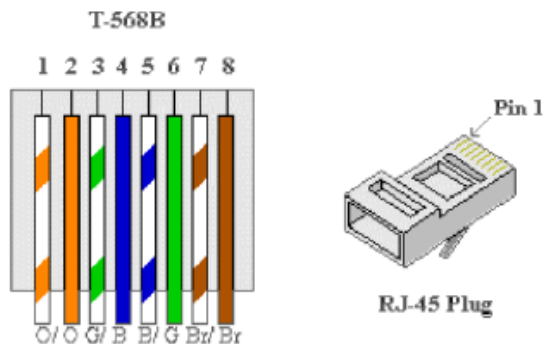

Load bar and drain wires



Wires aligned with load bar

5. S-Box Installation and Connection

⑩ Finishing the HDBaseT cable after installation

- **Pushing in of plastic loader to fullest extent: Push the plastic load bar as close as possible to the cable.**



- **Use a wire stripper to cut all conductors (conducting wires) down to a length of about 0.5 inches.**

Case 1) With drain wire: Refer to the next page.

Case 2) Without drain wire: Use copper foil to contact the connector shell part, as shown below.

Fold aluminum foil or braid back and wrap it with copper foil.

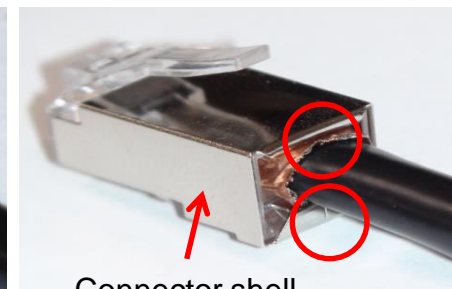
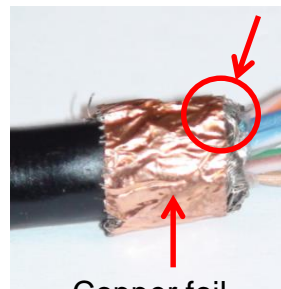

5. S-Box Installation and Connection

⑩ Finishing the HDBaseT cable after installation

- Fold and raise the **drain** wire above the RJ-45 connector. **Use pliers to attach the deformation prevention parts together, as shown below.**

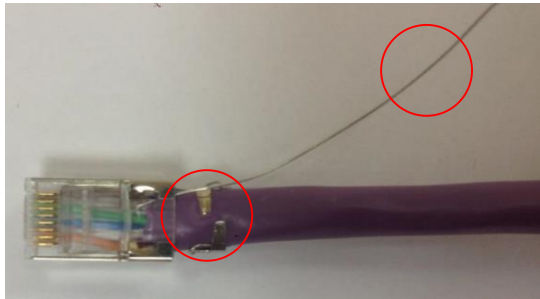

- **Soldering of drain wire to metallic part of RJ45 connector: Solder the drain wire to the metallic part of the RJ45 connector and cut unnecessary parts out.** Use a cable tester to the conductors and shield **status (continuity).**



Recommendation) Drain wire soldering + copper foil

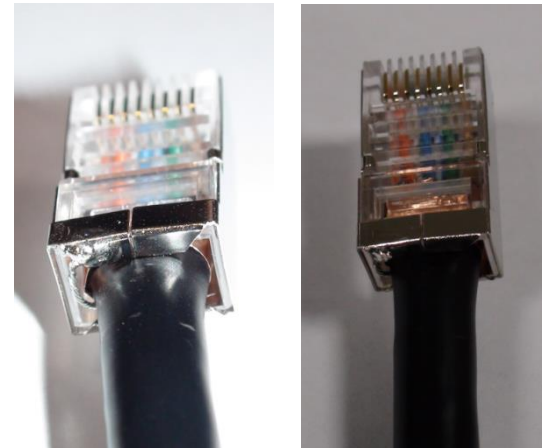

5. S-Box Installation and Connection

• S-Box Connection (Redundancy)

① If a redundancy feature is required

Use the OCM cable to connect the DATA IN port on the Interface Gender to the DATA OUT port on the last cabinet.

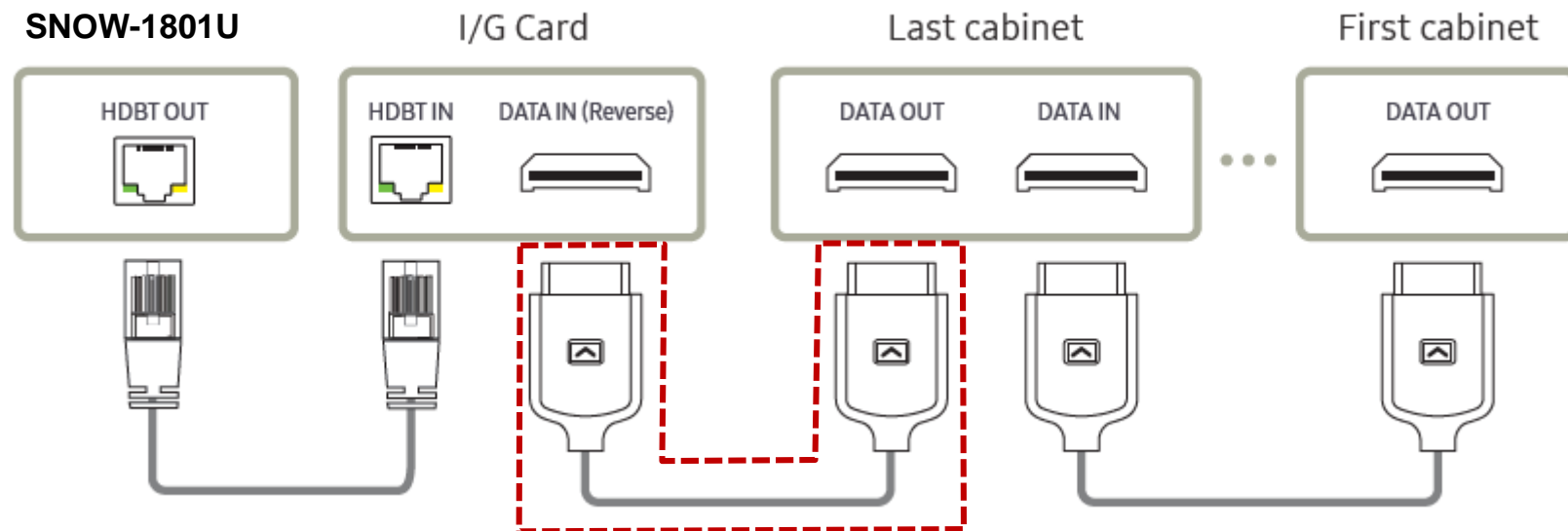

- Use 15–100 m long CAT 6 *STP and *FTP level cables to ensure HDBT signal stability.
- Do not bend cables or bind multiple cables together.



5. S-Box Installation and Connection

• S-Box Connection (External IR Receiver)

※ Only one external IR receiver is provided for a set.

- External IR receiver can be connected to the S-Box body or Interface Gender card (I/G card).



OR

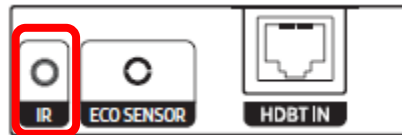

※ When connected to the I/G card, make sure “Network Standby” is set to “On” in System - Power Control.

5. S-Box Installation and Connection

• S-Box Connection (Panel Configuration)

① Initial S-Box picture quality settings

- S-Box is delivered with default picture quality settings optimized for the IWJ cabinet.
- After an LED display is installed, the picture quality settings become automatically optimized for the installed LED display model.
- To ensure configuration of optimum picture quality settings, make sure you use the LSM SW to connect the S-Box to the LED display.
- Make sure the LED display is connected to HDBT Port 1.
- Picture quality settings are configured based on the master cabinet model connected to HDBT Port 1.

* If the S-Box is not connected to the LED display via LSM, displayed colors may not look natural.

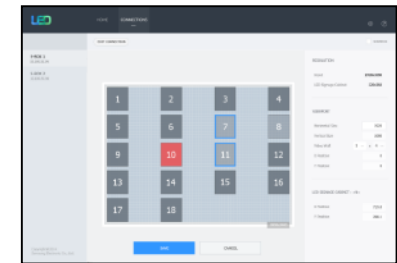
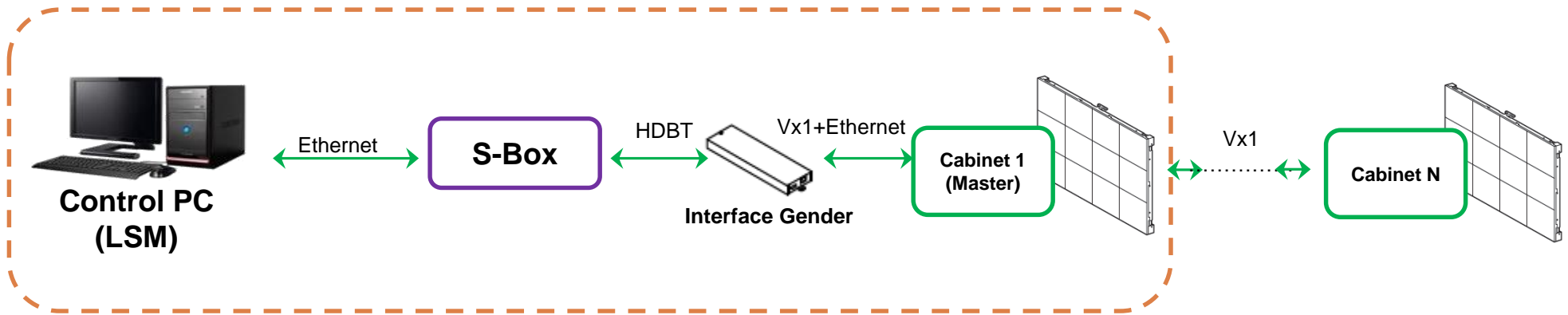

<Connection screen>

5. S-Box Installation and Connection

• S-Box connection (Grouping)

Press the Home button on the remote control and set Video Wall to “On”

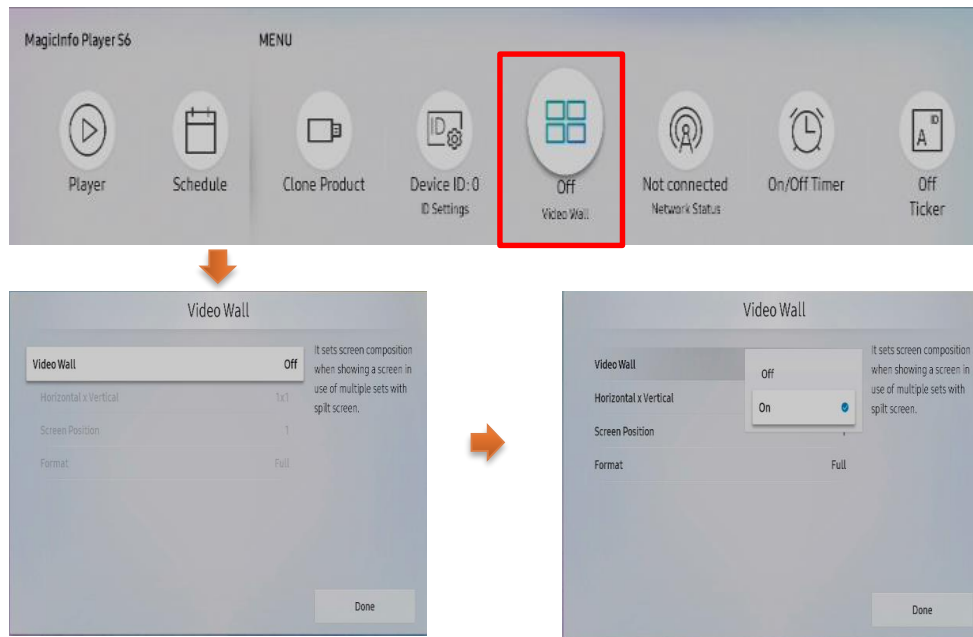

[Precautions]

- 1) Prior to running S-Box Grouping from LSM (LED Signage Manager), make sure you set the resolution for the input source device to a resolution compatible with S-Box Grouping.
- 2) If a resolution not compatible with S-Box Grouping is selected, a blank or static screen may be displayed. If this is the case, turn off the Video Wall function and change the resolution for the video output source to 50 Hz or 60 Hz.

※ Since June 2013, the S-Box Grouping function has been provided through LSM. Check the latest LSM version.

5. S-Box Installation and Connection

③ Changing the PC output frequency

- Right-click with the mouse on the computer desktop and click “Screen Resolution” → “Advanced settings.”



- Click the “Monitor” tab and select “60 Hertz” from the “Screen refresh rate” dropdown box under “Monitor Settings.”

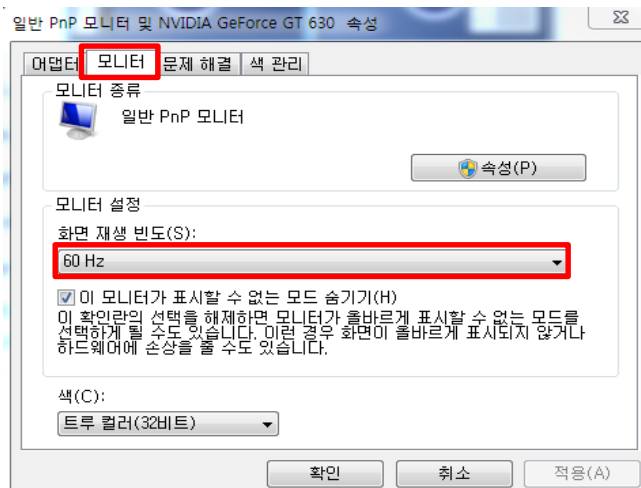

5. S-Box Installation and Connection

④ Frequencies compatible with S-Box Grouping (1/2)

Resolution	Horizontal frequency (KHz)	Vertical frequency (KHz)	Clock frequency (MHz)	Polarity Horizontal / Vertical	S-Box Grouping
IBM/VESA, 640 x 480	31.469	59.940	25.175	N / N	-
Mac, 640 x 480	35.000	66.667	30.240	N / N	-
VESA, 640 x 480	37.861	72.809	31.500	N / N	-
VESA, 640 x 480	37.500	75.000	31.500	N / N	-
IBM, 720 x 400	31.469	70.087	28.322	N / P	-
VESA, 800 x 600	35.156	56.250	36.000	P / P	-
VESA, 800 x 600	37.879	60.317	40.000	P / P	-
VESA, 800 x 600	48.077	72.188	50.000	P / P	-
VESA, 800 x 600	46.875	75.000	49.500	P / P	-
Mac, 832 x 624	49.726	74.551	57.284	N / N	-
VESA, 1024 x 768	48.363	60.004	65.000	N / N	0
VESA, 1024 x 768	56.476	70.069	75.000	N / N	-
VESA, 1024 x 768	60.023	75.029	78.750	P / P	-
VESA, 1152 x 864	67.500	75.000	108.000	P / P	-
Mac, 1152 x 870	68.681	75.062	100.000	N / N	-
VESA, 1280 x 720	45.000	60.000	74.250	P / P	0
VESA, 1280 x 800	49.702	59.810	83.500	N / P	-
VESA, 1280 x 1024	63.981	60.020	108.000	P / P	0
VESA, 1280 x 1024	79.976	75.025	135.000	P / P	-
VESA, 1366 x 768	47.712	59.790	85.500	P / P	-
VESA, 1440 x 900	55.935	59.887	106.500	N / P	-

5. S-Box Installation and Connection

④ Frequencies compatible with S-box Grouping (2/2)

VESA, 1600 x 900	60.000	60.000	108.000	P / P	0
VESA, 1680 x 1050	65.290	59.954	146.250	N / P	-
VESA, 1920 x 1080	67.500	60.000	148.500	P / P	0
VESA CVT, 1920 x 1080	66.587	59.934	138.500	P / N	-
VESA CVT, 2560 x 1440	88.787	59.951	241.500	P / N	-
VESA CVT, 3840 x 2160	133.313	59.997	533.250	P / N	-
CTA-861 VIC 3, 720 x 480	31.469	59.940	27.000	N / N	-
CTA-861 VIC 4, 1280 x 720	45.000	60.000	74.250	P / P	0
CTA-861 VIC 5, 1920 x 1080i	33.750	60.000	74.250	P / P	-
CTA-861 VIC 16, 1920 x 1080	67.500	60.000	148.500	P / P	0
CTA-861 VIC 18, 720 x 576	31.250	50.000	27.000	N / N	0
CTA-861 VIC 19, 1280 x 720	37.500	50.000	74.250	P / P	0
CTA-861 VIC 20, 1920 x 1080i	28.125	50.000	74.250	P / P	-
CTA-861 VIC 31, 1920 x 1080	56.250	50.000	148.500	P / P	0
CTA-861 VIC 32, 1920 x 1080	27.000	24.000	74.250	P / P	-
CTA-861 VIC 33, 1920 x 1080	28.125	25.000	74.250	P / P	-
CTA-861 VIC 34, 1920 x 1080	33.750	30.000	74.250	P / P	-
CTA-861 VIC 93, 3840 x 2160	54.000	24.000	297.000	P / P	-
CTA-861 VIC 94, 3840 x 2160	56.250	25.000	297.000	P / P	-
CTA-861 VIC 95, 3840 x 2160	67.500	30.000	297.000	P / P	-
CTA-861 VIC 96, 3840 x 2160	112.500	50.000	594.000	P / P	0
CTA-861 VIC 97, 3840 x 2160	135.000	60.000	594.000	P / P	0

5. S-Box Installation and Connection

⑤ Picture settings

- To use S-Box Grouping, make sure both the Dynamic Contrast and Black Tone functions are off so as to minimize a picture quality difference between S-Boxes.
- Menu → Picture → Advanced Settings,
 - Dynamic Contrast: default “Medium” → Off
 - Black Tone: default “Darker” → Off

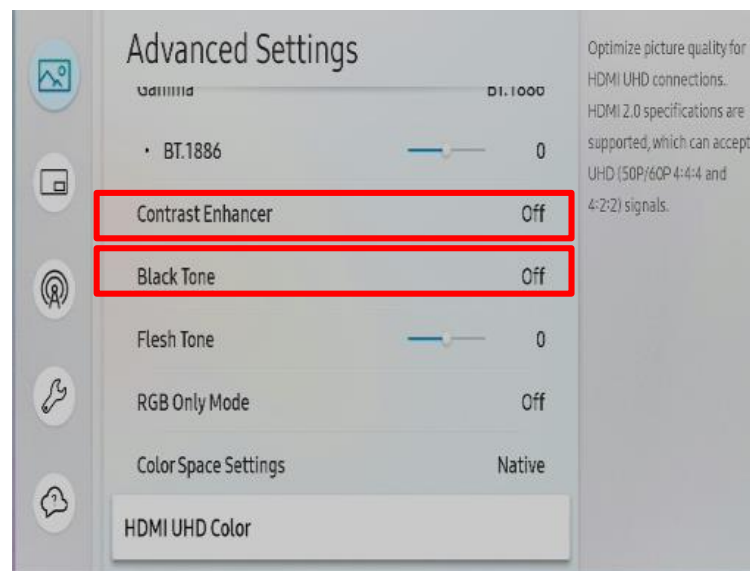
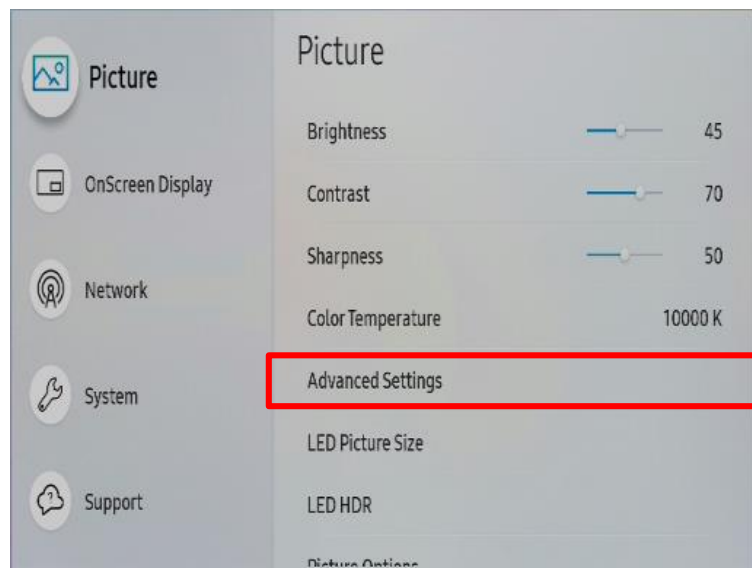

5. S-Box Installation and Connection

• S-BOX Connection (Service Port)

- ① The Service port is a dedicated monitoring port used to access the OSD menu during initial installation of an S-Box and check the playback status of a source device.
- ② The resolution for the Service port is FHD (1920*1080 @ 60 Hz).
- ③ If a source device with a UHD resolution is connected to an S-Box, screen flickering may occur or a corrupted screen may be displayed. This issue is caused due to 2:1 downscaling of the Service port with no specific scaling algorithm and has nothing to do with the actual LED cabinet screen display.

[Caution!] This port is for service use only and has no function for the user. Do not connect any cable to this port.

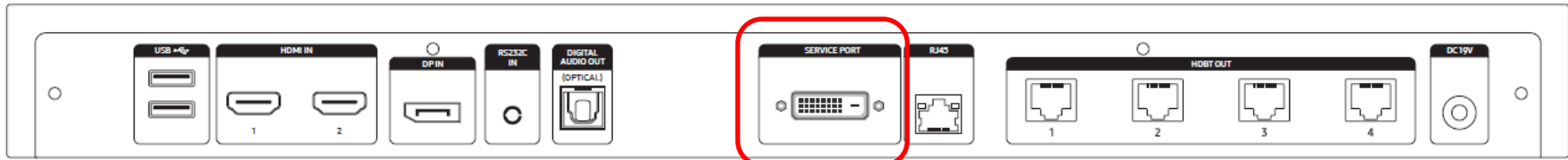

5. S-Box Installation and Connection

• Simple wall mode

- This mode is used to easily display a wallpaper when you do not want the product to display a blank screen while not in use.
- If the screen resolution is smaller than the S-Box output resolution, use the Factory Menu to turn on the Simple wall mode.

① Follow the steps below to access the Factory Menu.

- Connect the external IR cable to the S-Box.

- Press the power off button on the remote control → Wait for 10 seconds → **Press Mute - 1 - 8 - 2** → Click the “Power on” button

② In the Factory Menu, select Option → MRT option → SIMPLE WALL MODE SUPPORT → ON



Home	Updates	Exit			
Front Color	U-T-CL-M8B	BT Support	OFF	SPDF Support	ON
Leds Format	JEIDA	BT ADDRESS	Not Support	HDR PLUS Support	OFF
Language Set	US	HP LINE	LineOut	OPTION_NUM	
Region	USA	Resolution	UHD	IPv6 Support	ON
PIP Language	ENG_US	Local Dimming	0	TV Plus Support	OFF
WiFi REGION	S	Wifi Vendor	MT7603U	NigSam Support	OFF
OTM Support	OFF	Voice Recognition	OFF	EWBS Support	OFF
OTA Support	OFF	MBR Support	OFF	360 Audio Support	OFF
Teletext (TTX)	OFF	Samsung Smart Control	OFF	Decor Mode Support	OFF
BD Wide Plus	OFF	Simple IR Remote Control	OFF	Bendable Panel	OFF
Extended PVR	OFF	Instant On	OFF	802.1x Support	OFF
HV Flip	OFF	Always Instant On Support	OFF	Ambient Screen Support	OFF
Light Effect	OFF	Motion plus	ON	Game Mode	0
Network Support	Cable	Sound Mirroring	OFF	MRT SYSTEM INFO	
Eco Sensor	ON	IOT Hub Support	OFF	SIMPLE WALL MODE SUPPORT	OFF

[Caution!] Do not run Simple wall mode if multiple S-Boxes are connected.

The S-Boxes may not display wallpaper simultaneously.

5. S-BOX Installation and Connection (Only SBB-SNOWJMU model) Samsung Electronics

• How to install when use Multi Link HDR function

- Product recommend installing this product in a standard 19-inch server rack, please refer 25 page about basic installation guide.

- ① Please open rubber plug of Multi Link HDR port.
- ② Connect the connector of the cable of Multi Link HDR to the Multi Link HDR port of each S-BOX.
(Refer 87page about Cable)
(※ Note : Connect the connector's structure to face up)
- ③ Menu – Picture – LED HDR – Multi Link HDR Settings – ON
- ④ Set the quantity of S-BOX connected each other. (2/3/4)
- ⑤ Set S-BOX ID
(※ Note: It is necessary to set the ID not to overlap between connected S-BOX)

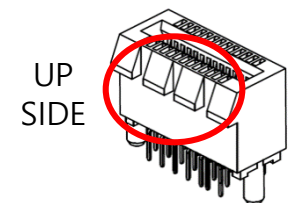
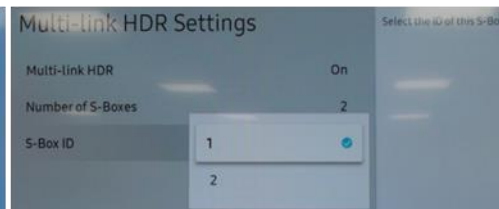
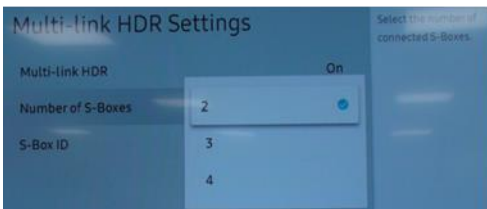
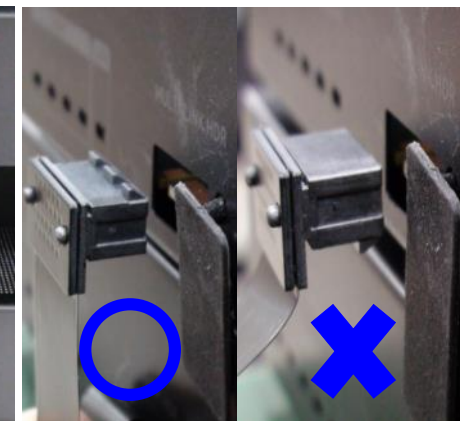

5. S-BOX Installation and Connection (Only SBB-SNOWJMU model) Samsung Electronics

- **Multi Link HDR Cable**

- Use the appropriate cable according to the quantity of S-BOX connected.



5. S-BOX Installation and Connection (Only SBB-SNOWJMU model) Samsung Electronics

• FPGA Update Guide when using Multi Link HDR Cable

※ Note : Before update, disconnect the Multi Link HDR Cable from S-BOX.

▪ Factory update method

- ① Save a SW program called 'TB-XCKUSBMWWWS.bin' in USB root.
- ② Connect the USB to S-BOX.
- ③ Enter Factory mode.
(Remote control 'mute +1+8+2+Power ON' in power off state)
- ④ Select "SVC → UPGRADE" menu.
- ⑤ Move the cursor to "FPGA UPGRADE" menu.
- ⑥ Press 'Enter' in the remote control.
- ⑦ Press '▶' button in remote control to start the upgrade.

▪ LSM update method

- ① Select 'S-BOX Settings – Software Update' in LSM menu.
- ② Select 'Browser' and move to the folder with the FPGA update file (TB-XCKUSBMWWWF.bin + Info.txt)
※ Version in 'Info.txt' file should be higher than currently installed version
- ③ Select 'TB-XCKUSBMWWWF.bin' file.
- ④ Select 'Update' button to start the upgrade.

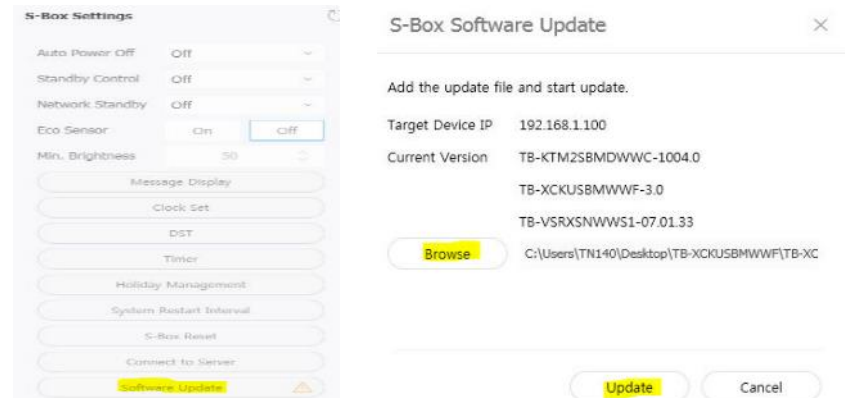

※ Note : In case of the sites that are difficult to remove the Multi Link HDR cable, all connected S-BOX should be AC power off/on after LSM update done. (Must turn off AC power after the update of all S-BOX are completed)
Check the version of FPGA after update.

6. Settings / How to Use

9-1. PC-specific control software

LSM (LED Signage Manager)

- How to download LSM: Access GSBN, select SLM - Display solution download, and then select "LED SIGNAGE MANAGER" or "LSM"

- GSBN: <http://v3.samsunggsbn.com/ep>

SLM
Display Solution Download Center

Hide Search Options ^

Category: VD
Title: LED SIGNAGE MANAGER
Level 1: -- Select --
Level 3: -- Select --
Post Date: [] ~ []
Contents: []
Level 2: -- Select --
Display Order: descending Total Download

Reset Search

List Generate

No	Category Name	Title	Level 1	Level 2	Level 3	Attached file	Total Download	Registered By	Registered On
1074	VD	LED Signage Manager (A-LEDMGDSP-1002.02)	LFD	Software		2	128	Kim 김석범 Seokb	28.04.2016
1292	VD	LED Signage Manager (A-LEDMGDSP-1003.03)	LFD	Software		2	93	Kim 김석범 Seokb	29.07.2016
1739	VD	LED Signage Manager (A-LEDMGDSP-1004.02)	LFD	Software		2	55	Kim 김석범 Seokb	09.12.2016
1589	VD	[User Manual] LED Signage Manager user manual	LFD	Manuals		2	49	Kim 김석범 Seokb	09.11.2016
1047	VD	LED Signage Manager (A-LEDMGDSP-1001.08)	LFD	Software		2	34	Kim 김석범 Seokb	01.04.2016
1984	VD	LED Signage Manager (A-LEDMGDSP1005.00)	LFD	Software		2	10	Kim 김석범 Seokb	14.03.2017

6. Settings / How to Use

9-1. PC-specific control software

Network IP Setting Tool

Use the File Explorer to go to the folder where LSM is installed.

Select [Start] – Programs – Samsung – LED Signage Manager – Network Configuration.

1. Use the RS232C cable to connect the PC to the S-Box. Select the connected Serial port and press the Open button to establish a connection.
2. The ID of an S-Box is set to “1” by default.
3. Enter the IP address, subnet mask, gateway and DNS for the S-Box, and press the Apply button to send the data.
4. View the result. View the MDC Protocol setting status.
5. The “Change Type to RJ45” button is displayed if IP settings have been configured correctly. Connect the LSM to the S-Box. If the product works properly, press the “Change Type to RJ45” button to switch the S-Box connection mode to “RJ45.”

[★ Caution!] When configuring S-Box network settings, it is recommended that a static IP address be used. If DHCP is used and the IP address is changed, the connection with LSM may be disconnected. The 192.168.10.x band is used for internal communication with LED cabinets. Use an IP address that does not belong to this band. Use the IP address for S-Box (x1) assigned by your IT administrator. Do not allocate an IP address arbitrarily.

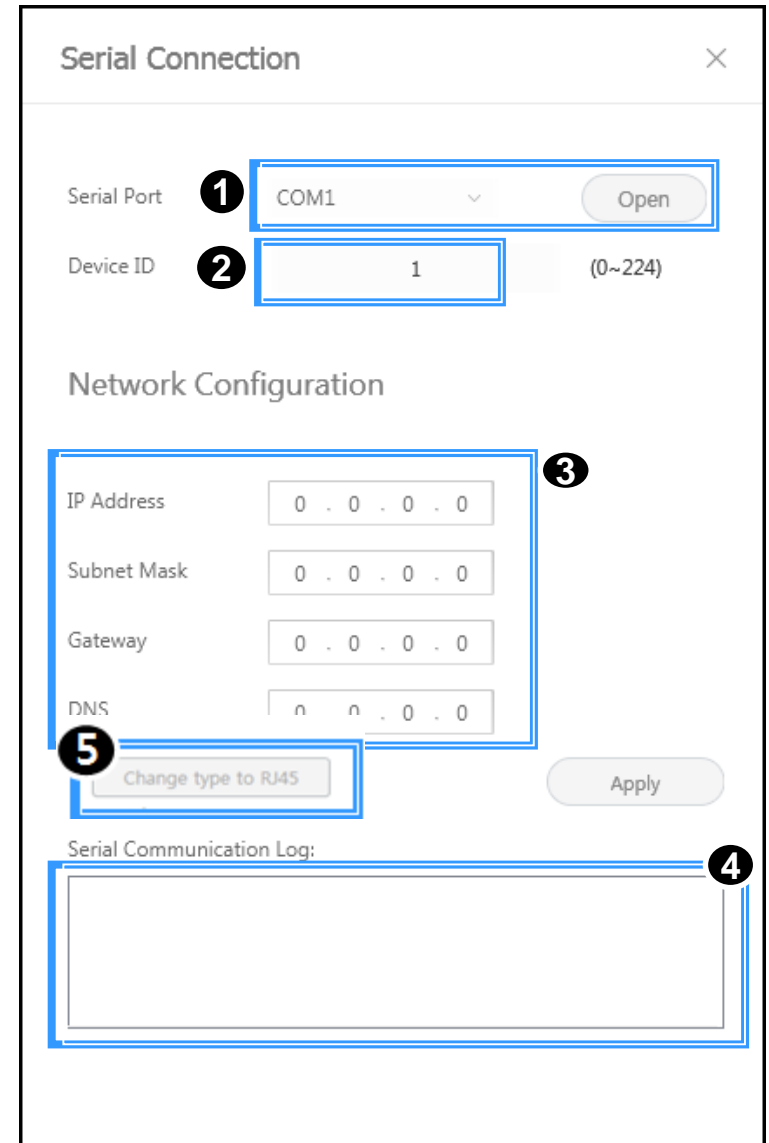

6. Settings / How to Use

9-1. PC-specific control software

LSM (LED Signage Manager)

- Software for remote control of LED cabinet layout

1. Connect the PC to the S-Box via Ethernet.
2. Use a LAN cable to connect the S-Box to the Interface Gender.
3. Use an OCM cable to connect the Interface Gender to the first LED cabinet.
4. Use OCM cables to connect the LED cabinets to one another in a daisy-chain configuration.

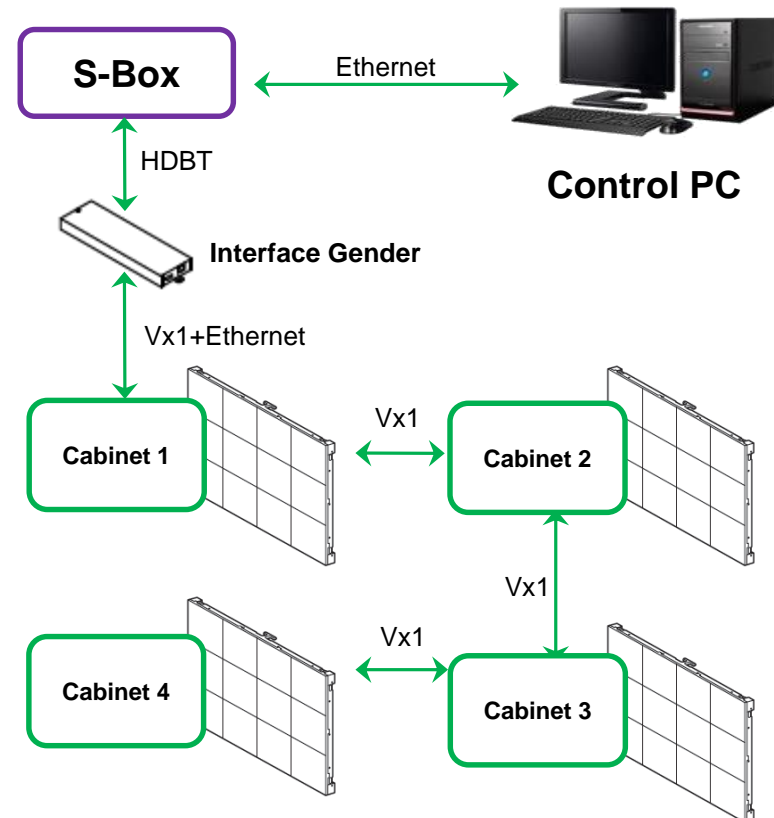

9-1. PC-specific control software

● LSM (LED Signage Manager)

- **Start– Login Page**

1. When the LSM is launched for the first time, the password setting page appears.
2. To set a password, enter the same password of your choice twice and click the Start button.
3. If you do not want to use a password, select the “Don’t use password” checkbox.
If this checkbox is selected, you are not prompted for a password when the LSM is launched subsequently.

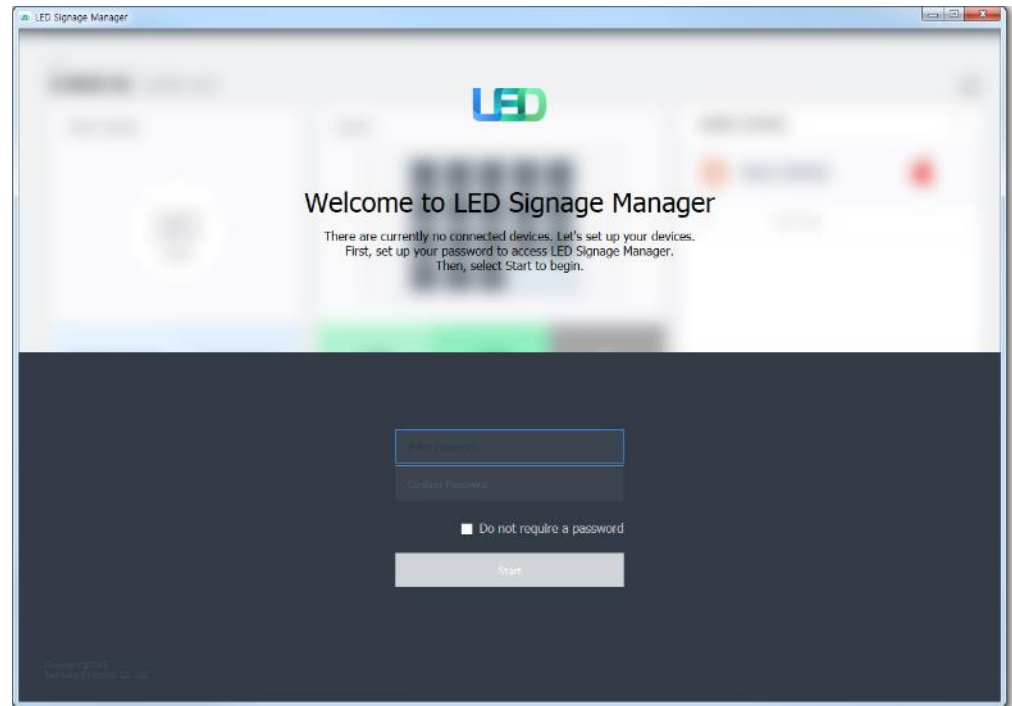

9-1. PC-specific control software

LED Signage Manager (LSM)

New Connection

1. To add connection information, use the Search button to search for an IP address or manually enter an IP address. If you click the Search button, the IP address for LSBs available for connection on the same network appear. Alternatively, manually enter the IP address if you know the IP address for the target LSB for connection.
2. Click the Add button. Entered connection information is added to the Setup and Connect settings.
3. The user can select an S-Box model type. Three model types are available for selection:

Without Cabinet IP / With Cabinet IP(FHD) / With Cabinet IP(UHD).

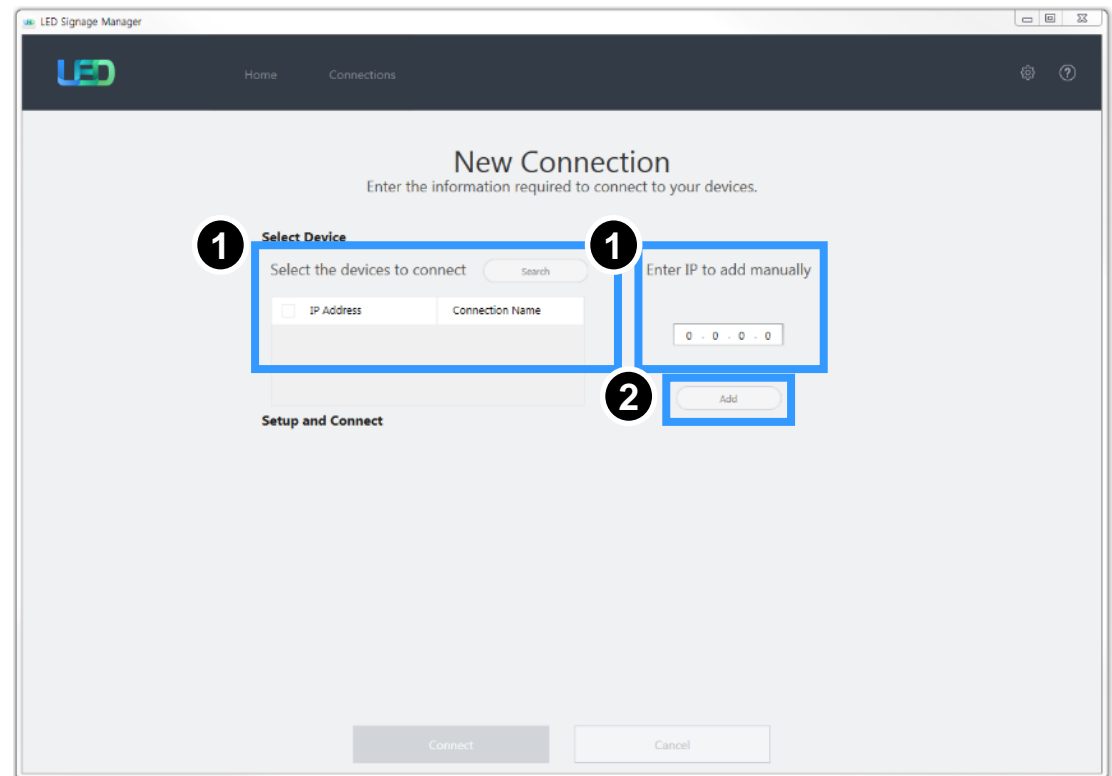

6. Settings / How to Use

9-1. PC-specific control software

LSM (LED Signage Manager)

New Connection-Connect

1. If using an old version LSB, select “Without Cabinet IP.”
2. If using a UHD LSB, select “With Cabinet IP (UHD).” Make sure assigning a different IP address for each port connected LED cabinets. Set the number of connected cabinets and click “Connect.”
3. If using an FHD LSB, select “With Cabinet IP (FHD).” Set the IP addresses for the LED cabinets, and the number of connected cabinets, and then click “Connect.”

※ If IP addresses are already set for the cabinets, select the “Connect with existing settings” checkbox.

※ If using UHD and some of the four ports will only be used, only enter the IP addresses for the corresponding groups.

[★ Caution!] When configuring LED cabinet network settings, it is recommended that a static IP address be used. If DHCP is used and the IP address is changed, the connection with LSM may be disconnected. The 192.168.10.x band is used for internal communication with LED cabinets. Use an IP address that does not belong to this band. Use the IP address for LED (x4) assigned by your IT administrator. Do not assign an IP address arbitrarily.

Setup and Connect

S-Box 192.168.1.1 Enter the number of cabinets. 🗑️

Model Type: Without Cabinet IP Connect with existing settings

Cabinets: 1 Assign IDs and Positions Automatically

Setup and Connect

S-Box 192.168.1.1 Enter the IP Address of each group. 🗑️

Model Type: With Cabinet IP (UHD) **IMPORTANT** Connect with existing settings

※ Should be different than S-Box / Should be different for each group

Group 1	IP Address: 0 . 0 . 0 . 0	Cabinets: 1	<input checked="" type="checkbox"/> Assign IDs and Positions Automatically
Group 2	IP Address: 0 . 0 . 0 . 0	Cabinets: 1	<input checked="" type="checkbox"/> Assign IDs and Positions Automatically
Group 3	IP Address: 0 . 0 . 0 . 0	Cabinets: 1	<input checked="" type="checkbox"/> Assign IDs and Positions Automatically
Group 4	IP Address: 0 . 0 . 0 . 0	Cabinets: 1	<input checked="" type="checkbox"/> Assign IDs and Positions Automatically

Setup and Connect

S-Box 192.168.1.1 Enter the number of cabinets of each group. 🗑️

Model Type: With Cabinet IP (FHD) Connect with existing settings

Group 1 IP Address: 0 . 0 . 0 . 0 Cabinets: 1 Assign IDs and Positions Automatically

9-1. PC-specific control software

LSM (LED Signage Manager)

[★ Caution!] For internal communication between the S-Box and LED cabinets, use ports 1515 and 48485.
When firewalls / security network are in use, make sure the corresponding port between the S-Box and LED cabinets is enabled.

- **Main Window-Home Window**

1. Home screen: Shows information about connected devices, the input source, the cabinet configuration, and devices with errors.

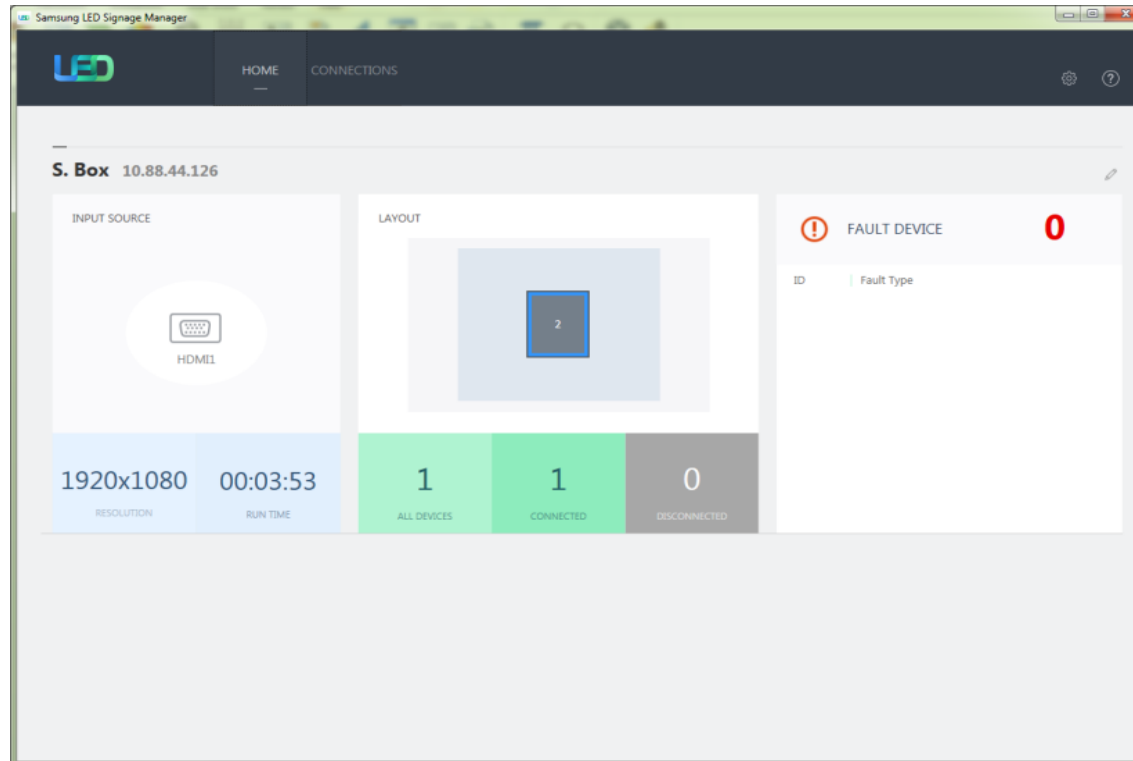

6. Settings / How to Use

9-1. PC-specific control software

LSM (LED Signage Manager)

- **Main Window-Home Window**

1. **INPUT SOURCE:** Shows the LSB input source, resolution and connection duration.

2. **LAYOUT:** Shows the layout and quantity of all LED cabinets and the quantities of connected and disconnected cabinets.

3. **FAULT DEVICE:** Shows the IDs of faulty LED cabinets and the fault details.

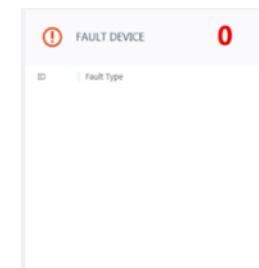
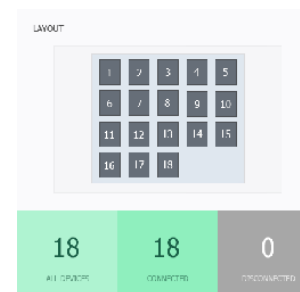
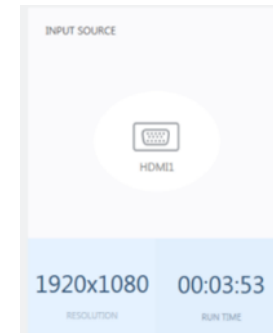

6. Settings / How to Use

9-1. PC-specific control software

LSM (LED Signage Manager)

Main Window-Edit Connection Layout Window

1. **Connection layout:** Use the LSB output source section to adjust the LED cabinet layout by rearranging cabinets.
2. **Feature View:** Provides the Edit button used to edit connection information and the automatic LED cabinet alignment function.
3. **Device Information/Setting View:** Shows LED cabinet information based on the following categories.
 - (i) **Resolution:** Resolution of the input source
 - (ii) **ViewPort:** Width/height, video wall matrix, x/y coordinate settings
 - (iii) **LED Signage Cabinet:** X, Y positions of LED cabinets
4. **Show ID:** Select to cause each of all connected LED cabinets to display their ID.
5. **Save/apply or cancel settings**

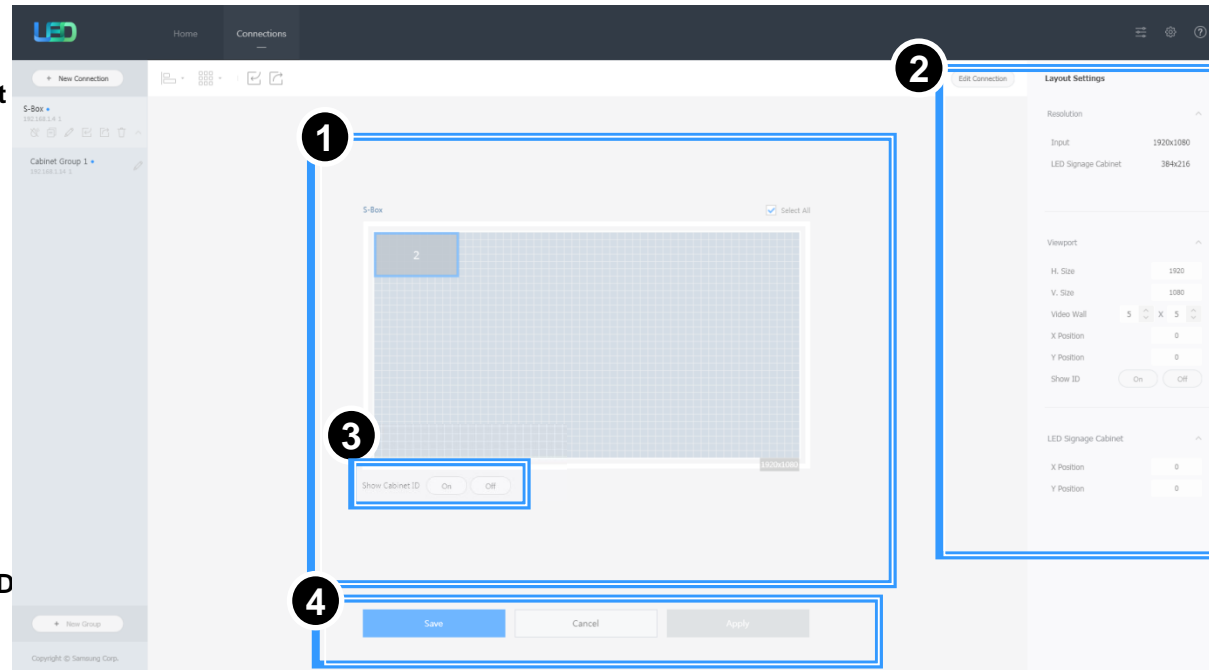

6. Settings / How to Use

9-1. PC-specific control software

LSM (LED Signage Manager)

Main Window-Connection Window

1. Device connection list view:
View LSB configuration information. Edit or delete LSB connections. View LED cabinets by group.
2. Connection layout (View Port):
View the LED cabinet layout and the position of each LED cabinet
3. Category View:
Use the Home and Connections tabs to configure system settings.
4. Device Information/Setting View:
Change LSB settings (e.g. screen settings).
5. Sub Information View: Displays monitoring logs, and LSB and LED cabinet information.

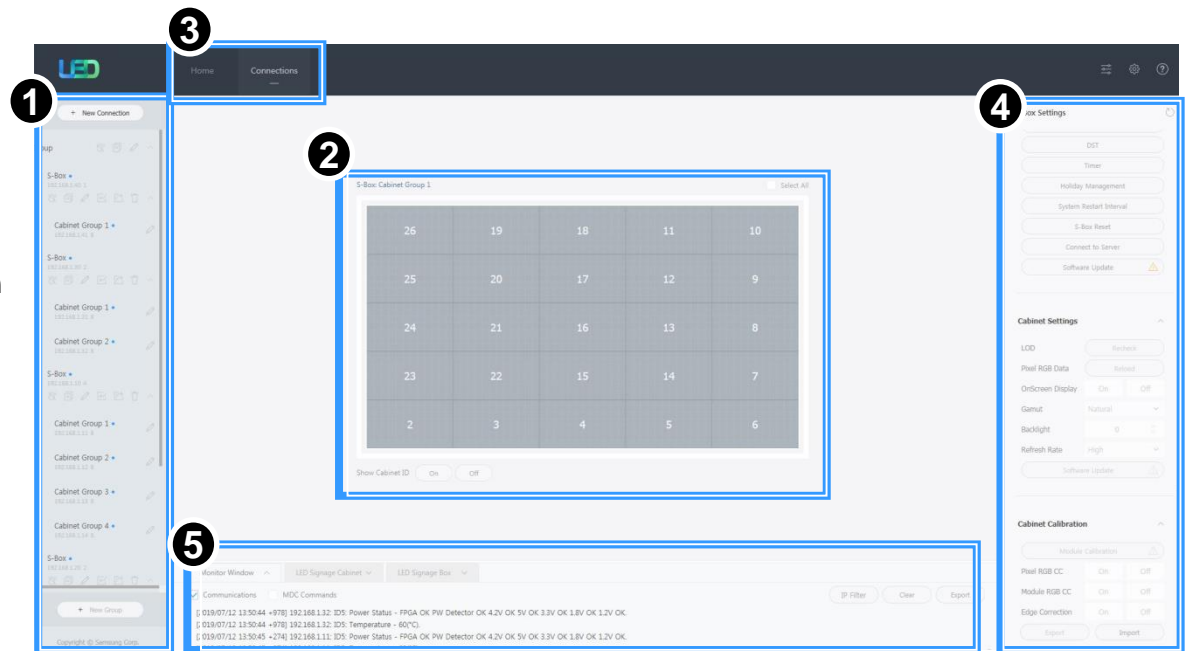

6. Settings / How to Use

9-1. PC-specific control software

LSM (LED Signage Manager)

Main Window-Connection Window - Device Information/Setting View

- Basic :**
 - Turn on/off the S-Box. Change the input source. Mute or free the screen.
- Picture**
 - Change the screen mode. Adjust brightness, contrast, sharpness, color, tint (G/R), color temperature (K), gamma or white balance.
- Picture Options**
 - Adjust color tone, HDMI black level, film mode and other settings.
- Advanced Settings**
 - Adjust black tone, facial color tone, color space and other settings.
- System**
 - Turn on/off Auto Power On or Off. Turn on/off Standby Control. Set the clock, timer and/or system restart interval. Use the software update function.

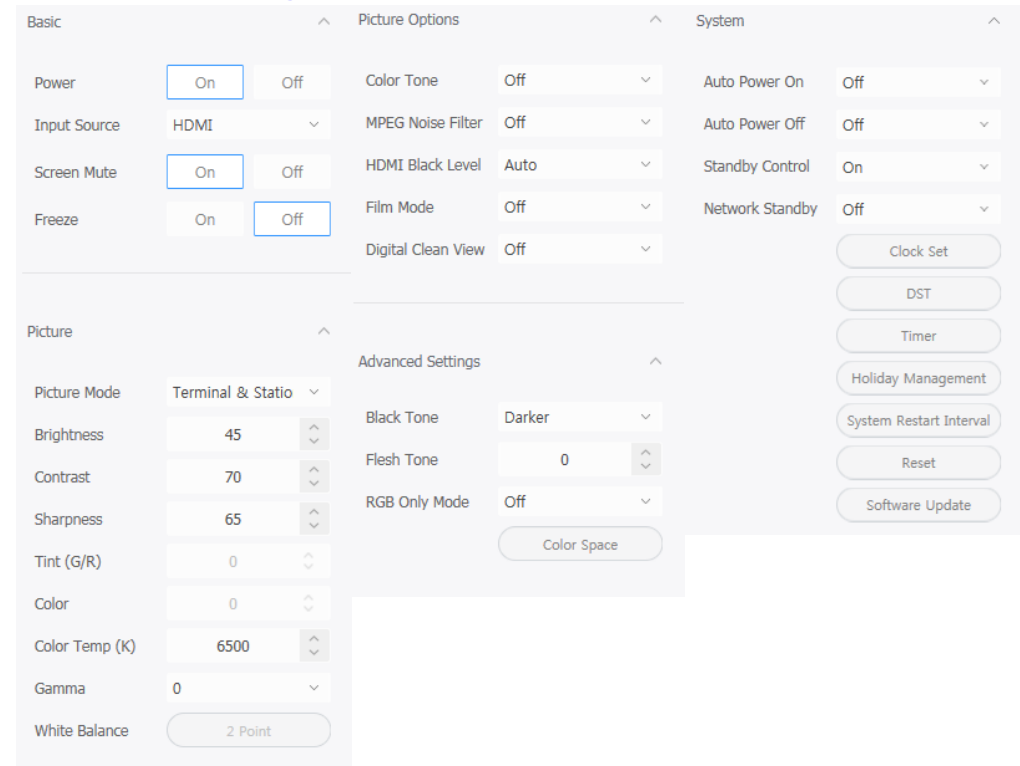

6. Settings / How to Use

9-1. PC-specific control software

LSM (LED Signage Manager)

Main Window-Connection Window - Device Information/Setting View

6. Cabinet Settings

- . Turn on/off ABL, and set Gamut and Backlight.
- . Use the software update function (e.g. FPGA, module calibration data).

6. Cabinet Calibration

- . Perform RGB CC calibration for each module.
- . Calibrate the boundary surface of each module.
- . Turn on/off CC. Turn on/off Edge Correction.
- . Download module calibration data through Batch Upload/Import/Export.

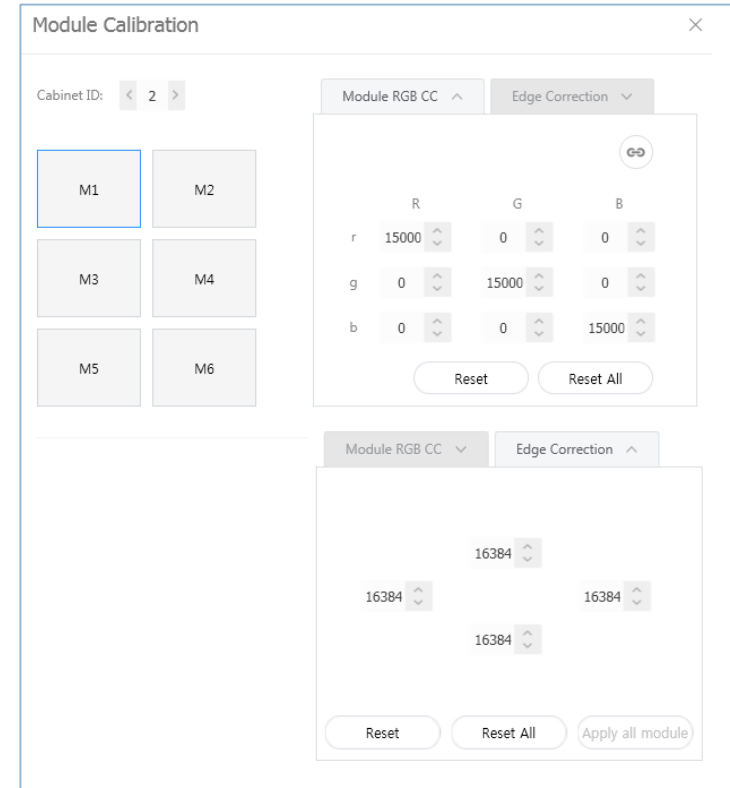
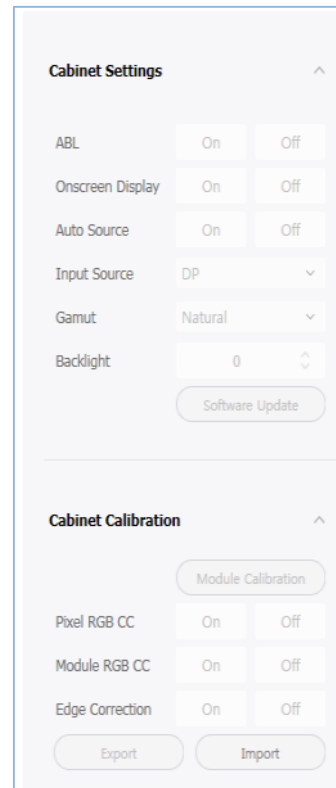

6. Settings / How to Use

9-1. PC-specific control software

LSM (LED Signage Manager)

Main Window-Connection Window - Sub Information View

- Monitor Window:**
View MDC communication logs and information about connected devices. Extract data by using files.
- LED Signage Cabinet:** Shows chip information and cabinet power information.
- LED Signage Box:** Shows the IP address, MAC address, LED cabinet ID range, numbers of all, connected and disconnected, serial number, and version information.

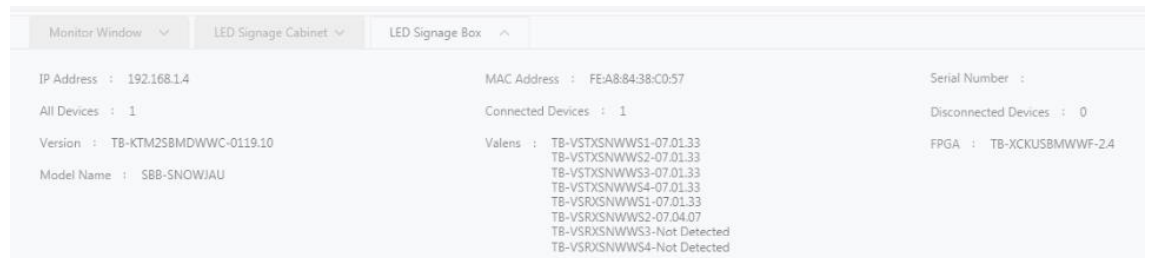
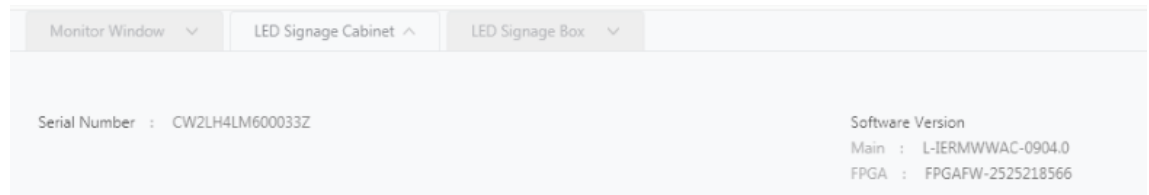
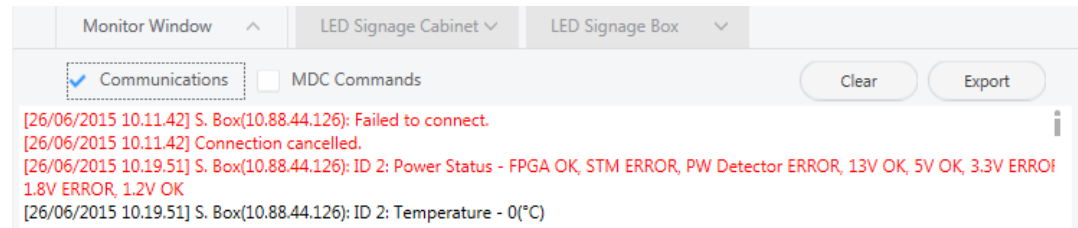

6. Settings / How to Use

9-1. PC-specific control software

LSM (LED Signage Manager)

- **Main Window - Preference**

1. **Options**

Set the command retry count.
Set the error status checking interval.
Set the temperature alert threshold.

2. **Support**

Select a language.
Configure log data management settings.

3. **Set the interval to email a device error alert.**

Change the password.

4. **About Software**

Shows the LSM version and provides the update function.

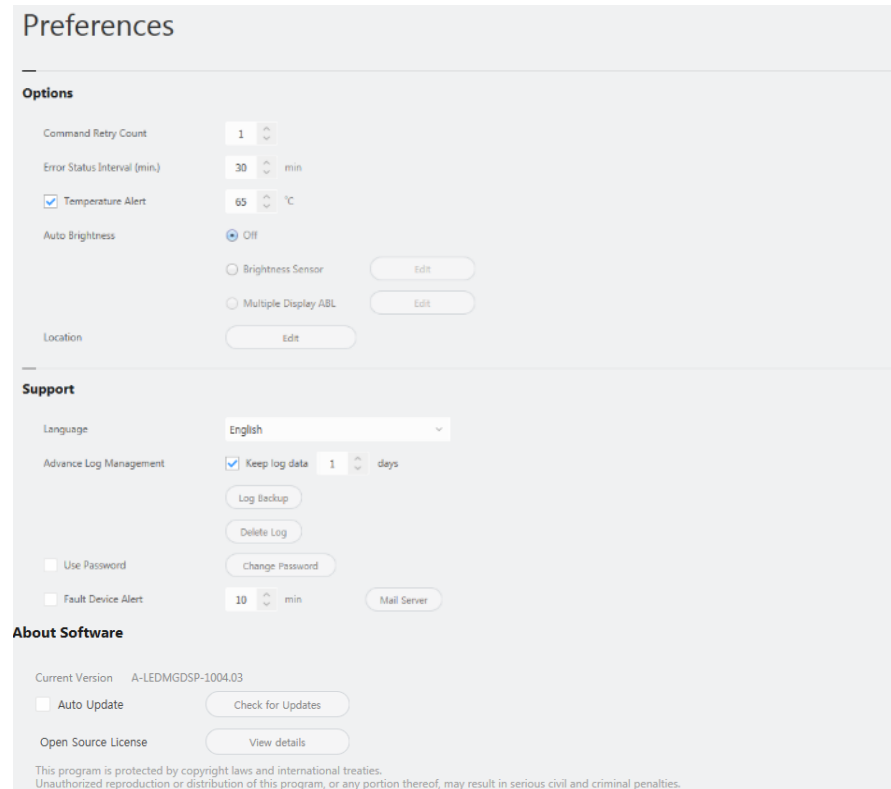

6. Settings / How to Use

9-1. PC-specific control software

LSM (LED Signage Manager)

Dehumidification Mode using LSM

1. The dehumidification mode icon is provided under the S-Box menu.
2. To turn on dehumidification mode, click the icon.
3. It is possible to view how long the dehumidification has been on.
4. To turn off the mode, click the “Stop” button.

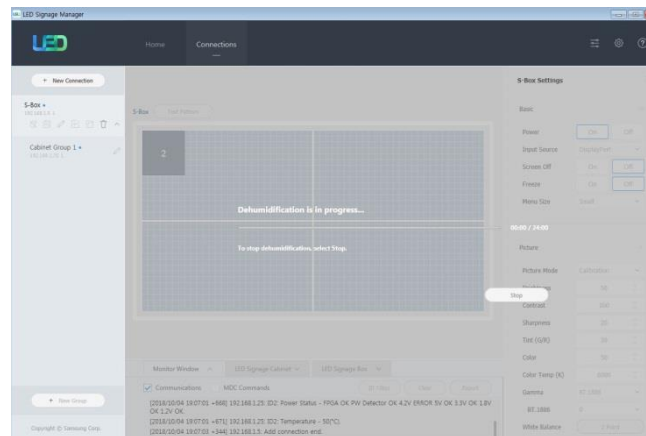
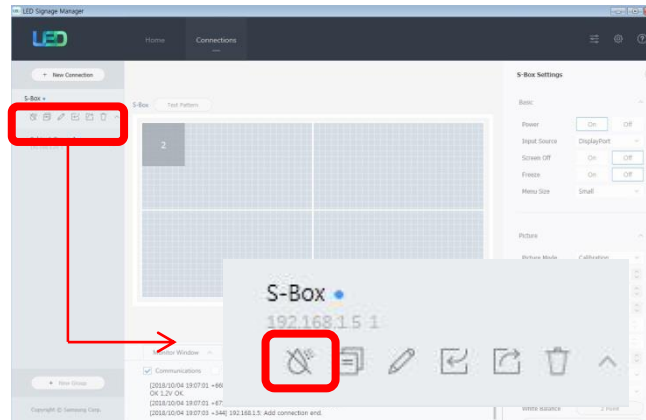

7. Settings / How to Use

7. Control Program for PC

LSM(LED Signage Manager)

- Mixed use for IER and IER-F

※ IER and IER-F can be connected to the same port.

- There is no connection order for IER and IER-F.
- Combination is possible within an FHD screen (the same I/G port).
- Use the same firmware for both IER and IER-F.

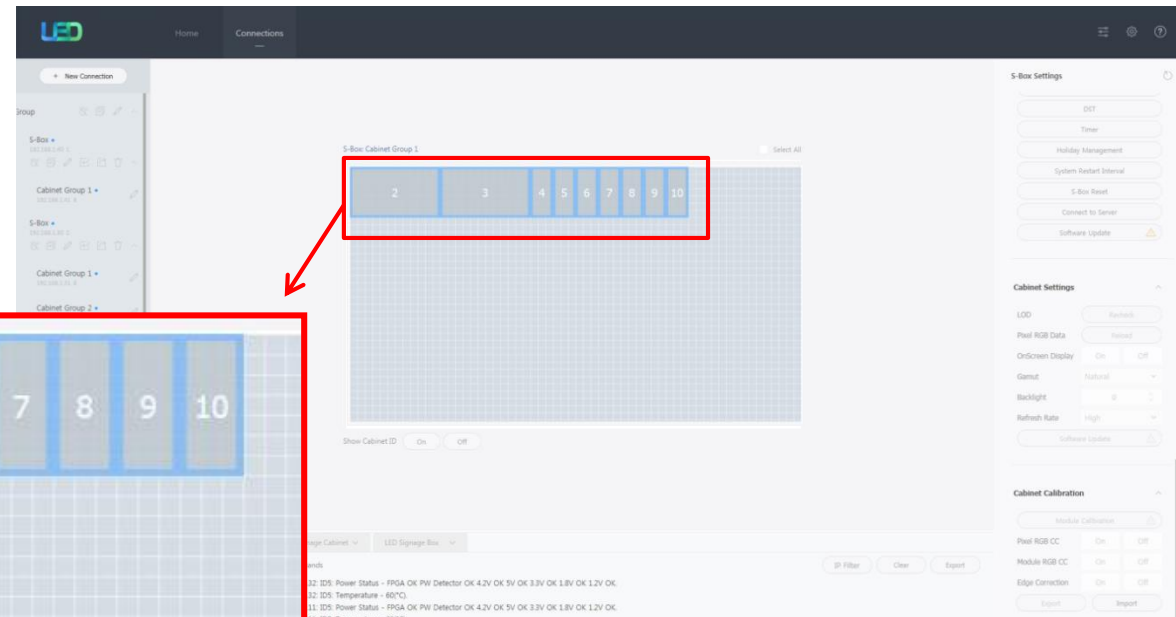
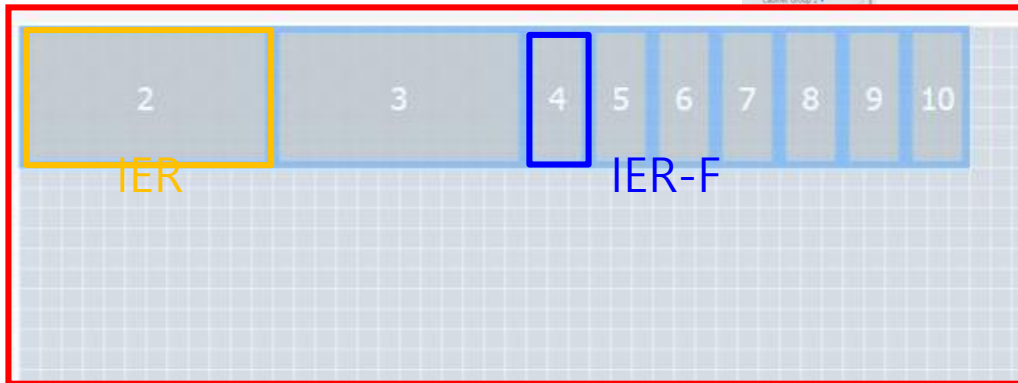

8. Power and Cable Connection

8-1. Cable connection (IER Series)

- If using 110V power, IER P2.0 / P2.5 / P4.0 allows power connection to a maximum of 3 / 4 / 4 cabinets.
For IER-F, 10 cabinets (each pitch)
- If using 220V power, IER P2.0 / P2.5 / P4.0 allows power connection to a maximum of 6 / 7 / 7 cabinets.
For IER-F, 20 cabinets (each pitch)
- In case of powering IER and IER-F together, adjust cabinet number so that total Power consumption is under 1000W
- **Make sure the quantity of connected cabinets does not exceed the recommended quantity. If the recommended quantity is exceeded, the breaker may trip or the product may become damaged due to over-current.**
- **※ Samsung Electronics is not responsible for problems caused as a result of exceeding the recommended quantity of connections.**
- The rated voltage for the product and the rated current for the outlet can be found in the label attached on the rear of the product.

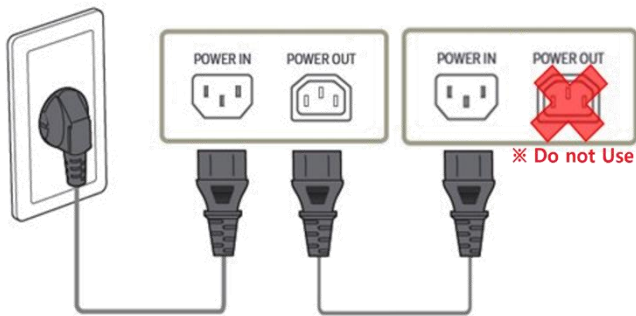

- Transfer power by daisy chain with extension power cable
- Do not use Power out socket of last Cabinet

SAMSUNG Color Display Unit
Type No.: LH0261FH5

Model / MODELE NO / Modelo: IF025H-D
Model Code : LH0261FHSDS/ZA

USA/CANADA : AC100-240V~50/60Hz 6.0A
MEXICO : 100-240V~50/60Hz 6.0A

OUTLET : 4.0A



This device complies with Part 15 of the FCC Rules. Operation is subject to the following two conditions: (1) this device may not cause harmful interference, and (2) this device must accept any interference received, including interference that may cause undesired operation.

CAN ICES-3 (A) / NMB-3 (A)
MFD./FABRIQUE: DECEMBER 2017
MADE IN KOREA(SEC)
FABRIQUE AU COREE(SEC)
HECHO EN COREA(SEC)
S/N / Serie No : *****Z



CAUTION
RISK OF ELECTRIC SHOCK
DO NOT OPEN

**WARNING : TO PREVENT FIRE OR SHOCK HAZARD
DO NOT EXPOSE THIS UNIT TO RAIN OR MOISTURE
AVIS : RISQUE DE CHOC ELECTRIQUE - NE PAS OUVRI**



Version No : XXXX

8. Power and Cable Connection

8-1. Cable connection (IFR Series)

- If using 110V power, IFR P2.5 / P4.0 allows power connection to a maximum of 2 / 2 cabinets. For IFR-F, 7 cabinets (each pitch)
- If using 220V power, IFR P2.5 / P4.0 allows power connection to a maximum of 4 / 4 cabinets. For IFR-F, 20 cabinets (each pitch)
- In case of powering IFR and IFR-F together, adjust cabinet number so that total Power consumption is under 1000W
- **Make sure the quantity of connected cabinets does not exceed the recommended quantity. If the recommended quantity is exceeded, the breaker may trip or the product may become damaged due to over-current.**
- **※ Samsung Electronics is not responsible for problems caused as a result of exceeding the recommended quantity of connections.**
- The rated voltage for the product and the rated current for the outlet can be found in the label attached on the rear of the product.

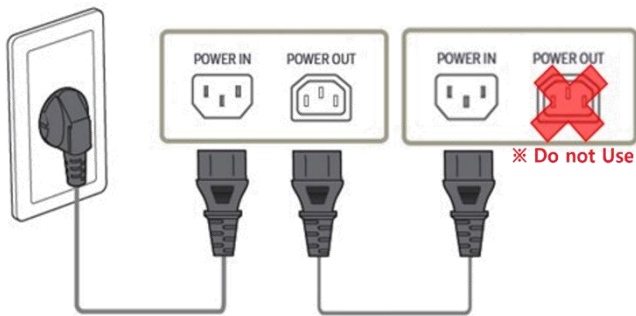

- Transfer power by daisy chain with extension power cable
- Do not use Power out socket of last Cabinet

SAMSUNG Color Display Unit
Type No.: LH0251FH5
Model / MODELE NO / Modelo: IF025H-D
Model Code : LH0251FHSDS/ZA

USA/CANADA : AC100-240V~50/60Hz 6.0A
MEXICO : 100-240V~50/60Hz 6.00W 6.0A

OUTLET : 4.0A



This device complies with Part 15 of the FCC Rules. Operation is subject to the following two conditions: (1) this device may not cause harmful interference, and (2) this device must accept any interference received, including interference that may cause undesired operation.

CAN ICES-3 (A) / NMB-3 (A)
MFD./FABRIQUE: DECEMBER 2017
MADE IN KOREA(SEC)
FABRIQUE AU COREE(SEC)
HECHO EN COREA(SEC)
S/N / Serie No : *****Z



CAUTION
RISK OF ELECTRIC SHOCK
DO NOT OPEN

**WARNING : TO PREVENT FIRE OR SHOCK HAZARD
DO NOT EXPOSE THIS UNIT TO RAIN OR MOISTURE
AVIS : RISQUE DE CHOC ELECTRIQUE - NE PAS OUVRI**



Version No : XXXX

8. Power and Cable Connection

8-2. Precautions during cabinet installation and cable connection (Full Front fixing)

1) If cabinets are installed on a dedicated wall mount, the cabinets are fastened toward the bottom-left direction.

Sets can only be installed in the left-to-right direction.

→ The set installation direction may be different from the cable connection direction.

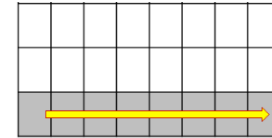

2) After installing all cabinets for one row, connect the signal and power cables and turn on the sets to check that there is no problem with connection before installing cabinets for the next row.



3) To connect cables between upper and lower sets, first connect the cables to the lower sets before assembling the upper sets.

→ If installing upper and lower sets together before connecting cables, it is difficult to connect cables to the lower cabinets.

3) The two Video Out ports on the Interface Gender should be connected to the first and last cabinets by using OCM cables so as to ensure proper redundancy operation.

→ The Interface Gender should be installed in the middle on the left end of the LED wall. (See page 13.)

→ The distance between the first and last cabinets should be within 2 to 4 m to be connected with OCM cables.

8. Power and Cable Connection

8-3. Cabinet installation direction (Full Front fixing)

- 1) For the lowest row, install cabinets in the left-to-right direction.
- 2) After installing one row of sets is completed, connect signal and power cables between the cabinets.
※ After installation of one row of sets and signal connection are completed, turn on the sets to check that the installation has been done correctly before installing the next row sets.
- 3) From the second row, install cabinets vertically (left→right).

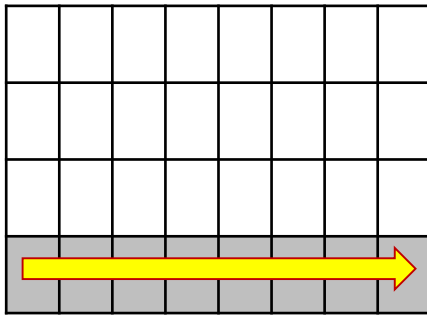

1) First row: Install in the left → right direction

Check that there is no significant height difference between modules inside cabinets.

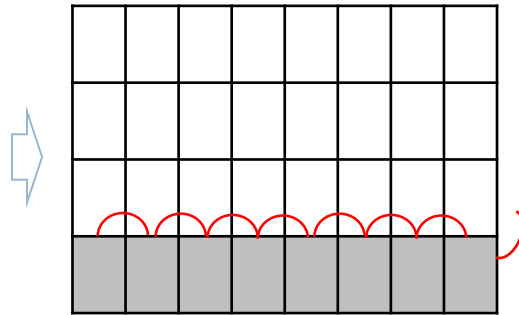

2) Connect signal/power cables between the sets

After connecting all signal/power cables between the sets, make sure you turn on the sets to check that the display on one row works properly before installing the upper row.

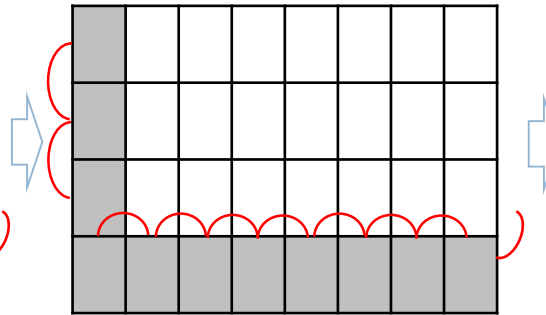

3) From second row: Install cabinets and connect cables vertically

Check that there is no significant front/back height difference between cabinets and the LEDs are arranged in a straight line.

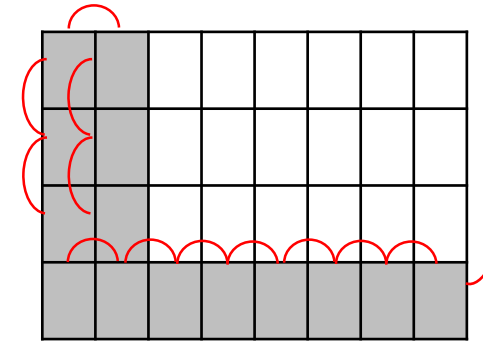

4) Use the same method to install cabinets and connect cables vertically.

8-4. Cable connection

- After installation and connection, automatic sorting can be made on LSM. (automatic sorting for cabinets)
- It is recommended to install the cabinets in automatic sorting order.

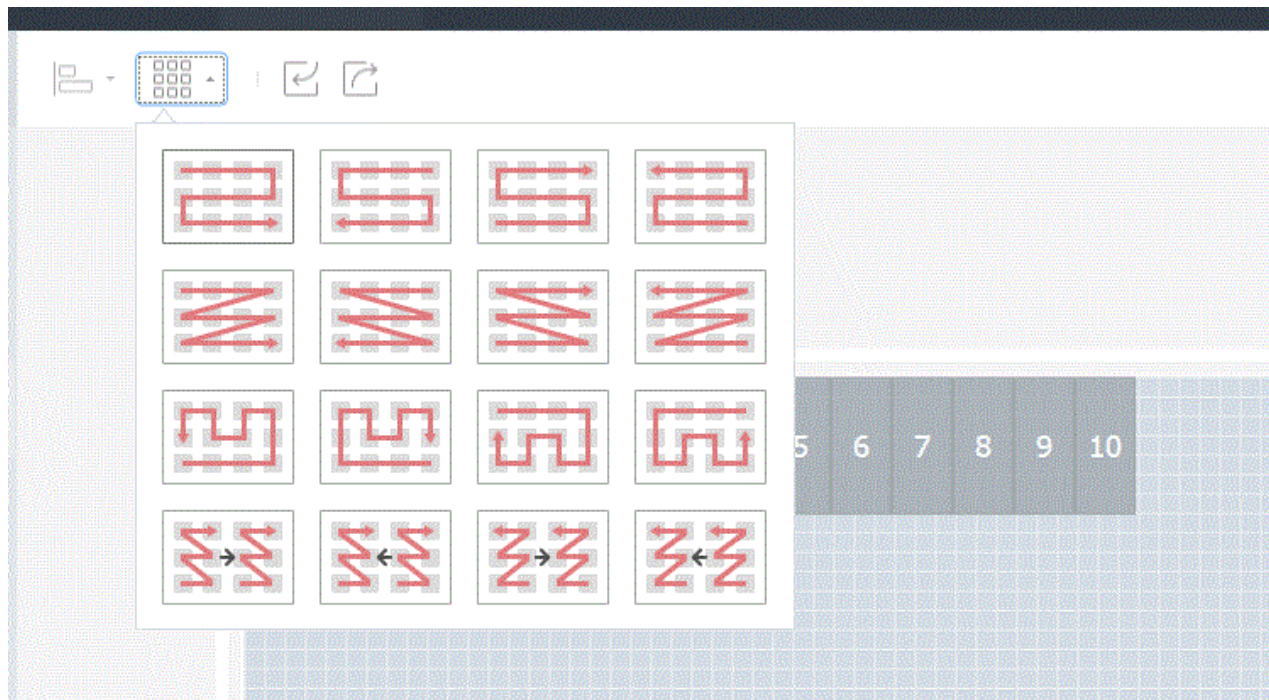

8. Power and Cable Connection

8-4. Cable connection

FHD 50/60 Hz screen with IER/IFR would be : 4x4 for P2.0 / 5x5 for P2.5 / 8x8 for P4.0

Ex)



Case 1:

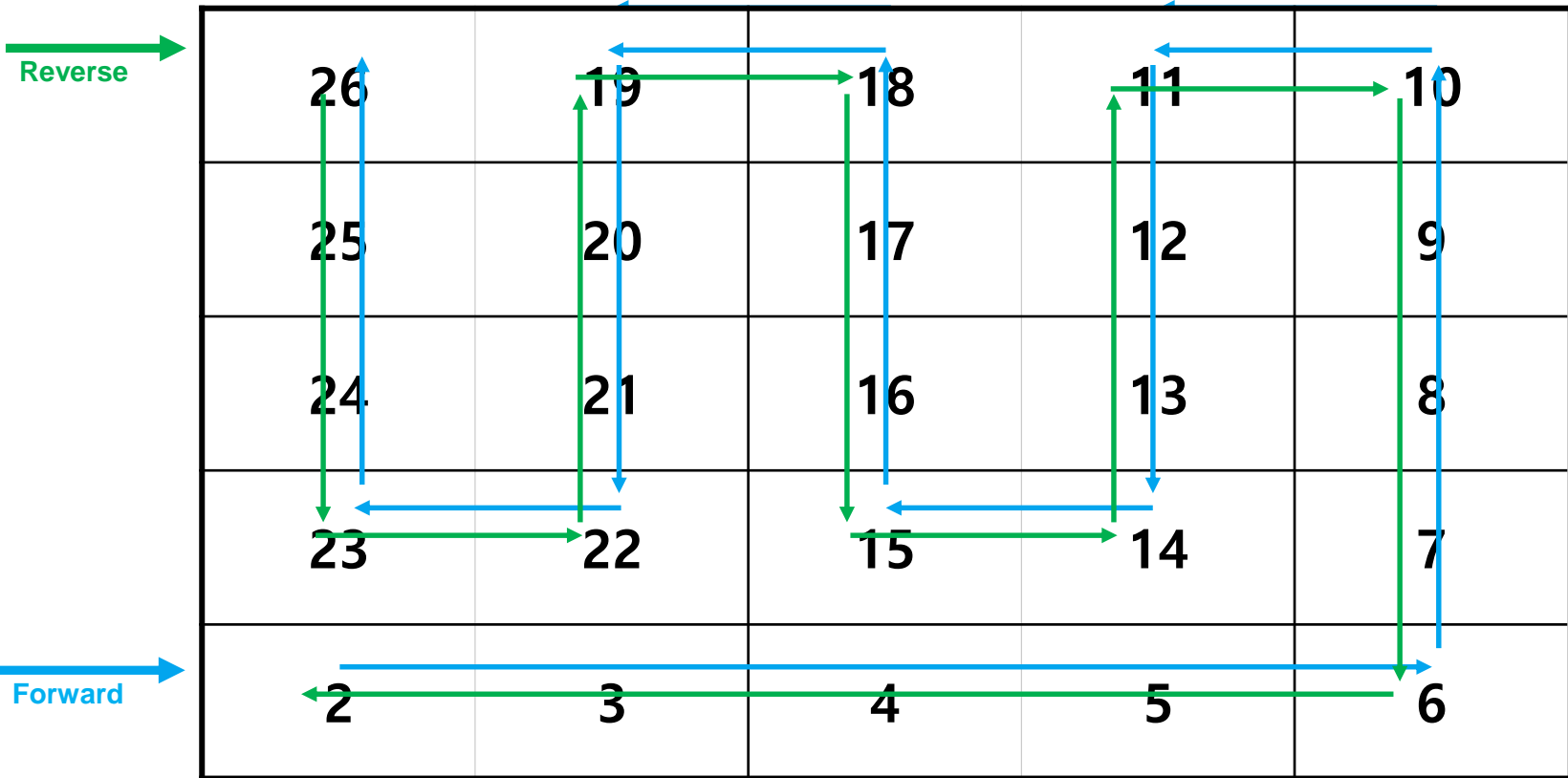

8. Power and Cable Connection

8-4. Cable connection

FHD 50/60 Hz screen with IER-F/IFR-F would be : 16x4 for P2.0 / 20x5 for P2.5 / 32x8 for P4.0
 (recommended to install mixed with IER/IFR)

Ex)

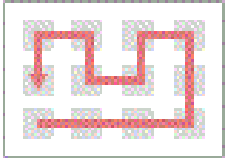

Case 2:

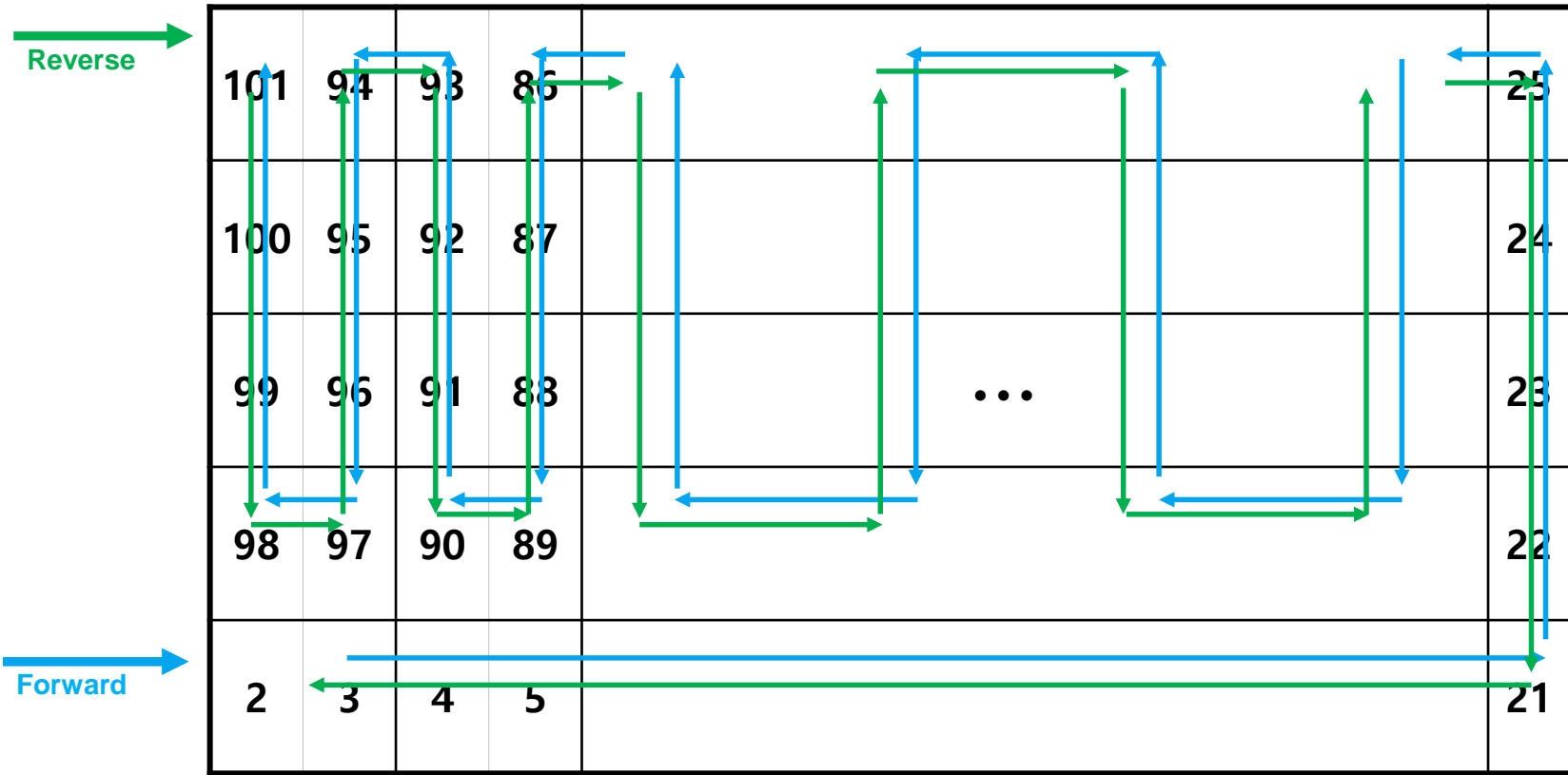

9. Seam Adjustment

◇ Checking and adjusting seam

- ① On the white screen, check that there is no **black line** found between cabinets. (See Fig.1.)
- ② Check for a gap or significant height difference between modules. (See Fig.2.)
 - ※ If a gap is found: A black line is visible from all directions.
 - ※ If a significant height difference is found: A white line is visible when viewed from one direction. When viewed from the opposite direction, a black line is visible.
- ③ If a gap is found, move the modules with hands, beginning from the outer modules.
- ④ If a significant height difference is found, disassemble the lower LED modules and adjust the height by turning the Holder-Magnet with an appropriate tool.
 - ※ If the Holder-Magnet is turned halfway and then turned 360 degrees with the tool, the module height is moved by 0.1 mm (Fig.3).

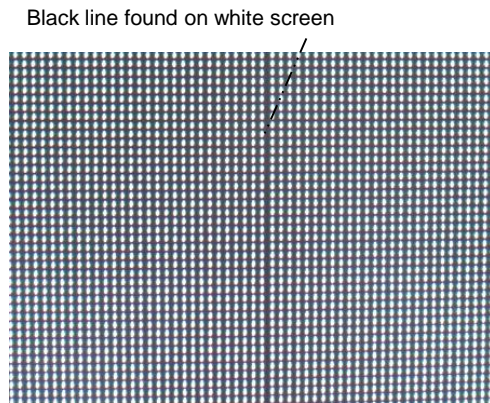

Fig.1 Black line

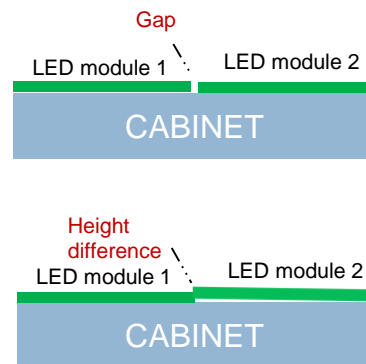

Fig.2 Gap / height difference between modules

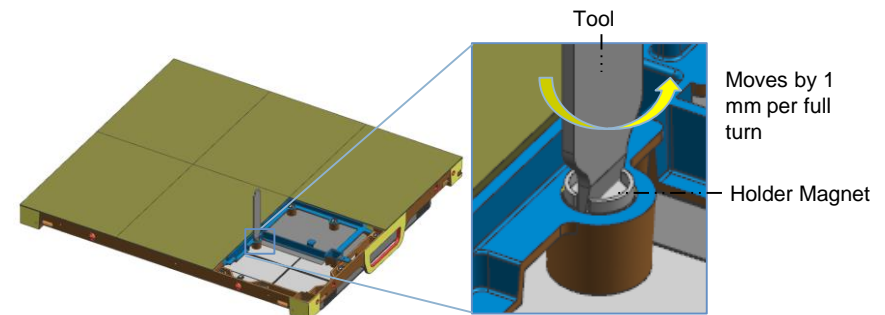

Fig.3 Adjusting height difference

9. Seam Adjustment

◇ Module disassembly/reassembly

Hold the JIG with the UNLOCK marking facing up.

Put the JIG to the LED module.

Separate the JIG and the module together.

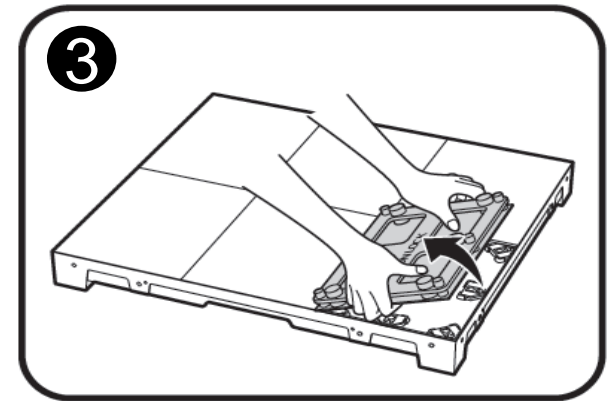
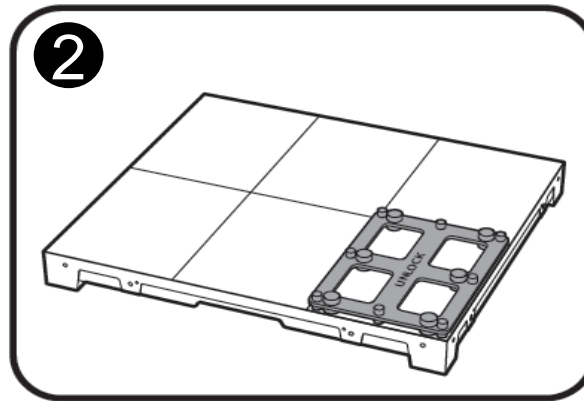
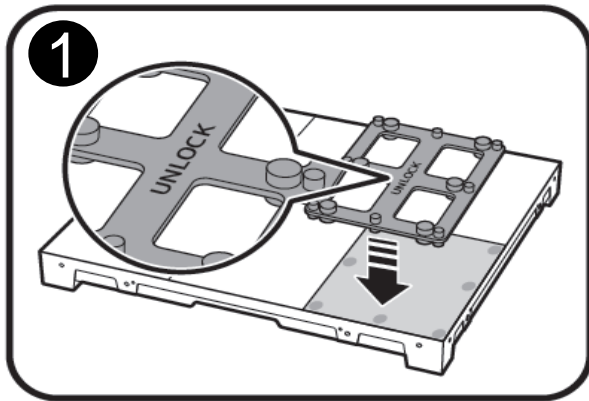

Place the new module on the cabinet.

Hold the JIG with the LOCK marking facing up.

Put the JIG to the LED module to lock the module.

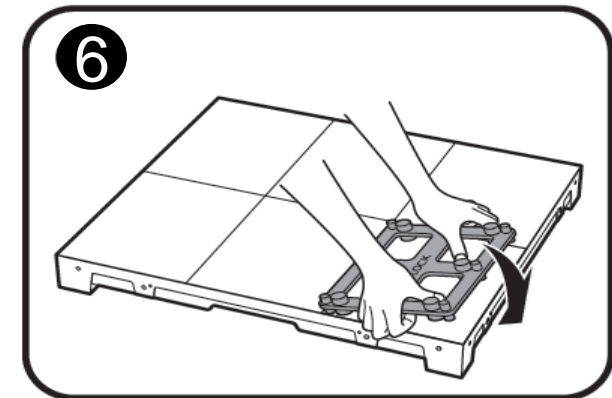
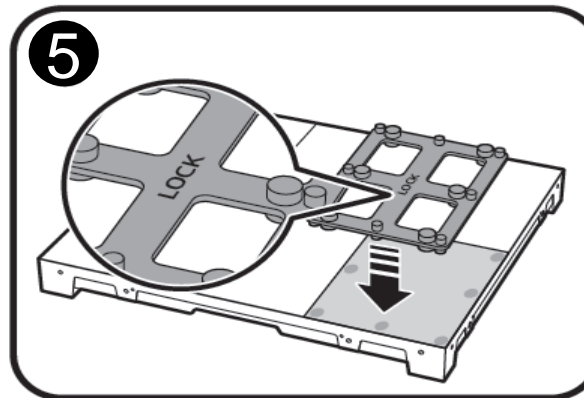
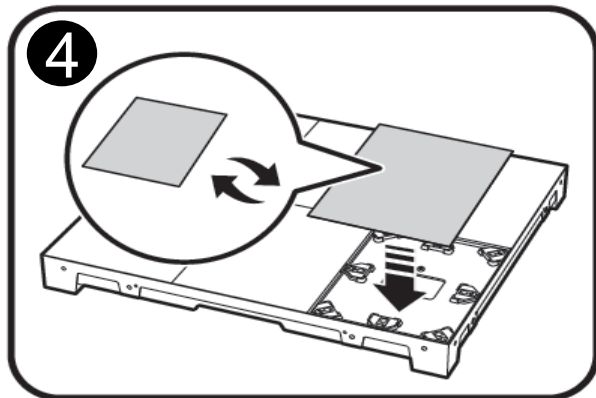

IER-F/IFR-F series Installation Manual

LH0IER*F***

LH0IFR*F***

0. Product Information

1. Frame Kit & JIG Configuration

2. IER(IFR) Landscape Installation + IER-F(IFR-F) Extension

2-1. IER + IER-F Extension (Left to Right)

2-2. IER + IER-F Extension (Up to Down)

2-3. IER-F + IER-F Extension (Left to Right)

2-4. IER-F + IER-F Extension (Up to Down)

2-5. IER-F + IER-F L-Type

3. PIVOT Installation

4. Fastening the Cover PCB

0. Product Information

◇ Components of the Frame Kit (only for installation of IER-F)

Code	Installation Layout	Remarks
VG-LFR13SWL	1*3 (3 Set)	FRAME F
VG-LFR11SWL	1*1 (1 Set)	FRAME F
VG-LFR11PWF	1*1 (1 Set, PIVOT)	FRAME F PIVOT
CY-LJRNEF	-	JIG F
CY-LJRNPF	-	JIG F PIVOT

◇ SNOW-1810U (S-Box, I/G)

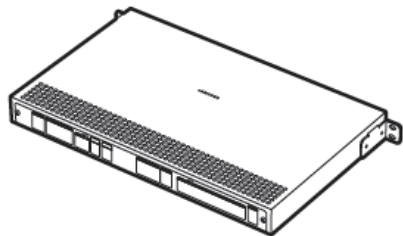

<S-Box>

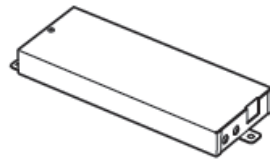

<I/G>
(Interface Gender)

◇ Cabinet product information / Gap to the Frame

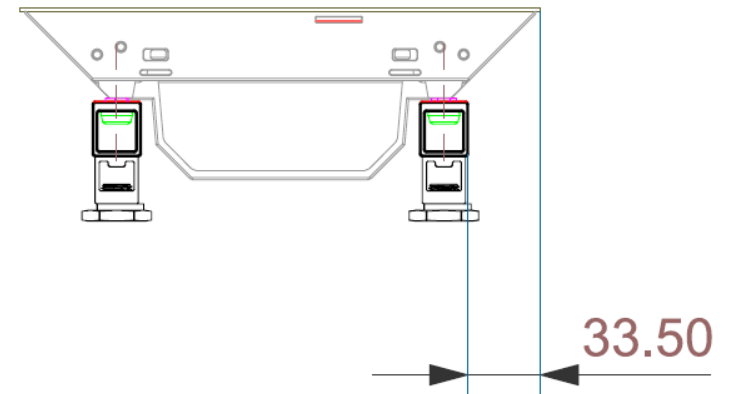
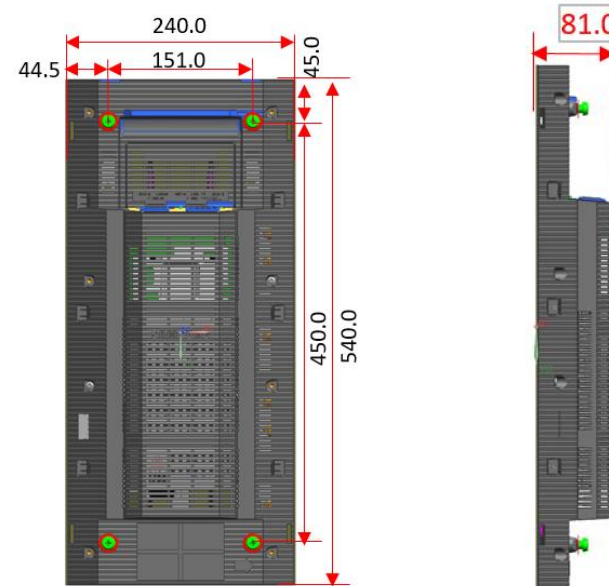

◇ IER-F accessories

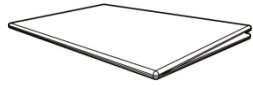

Quick Setup Guide



Product Warranty Card
(Not provided in some regions)

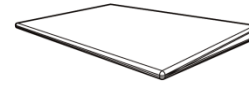

Specification

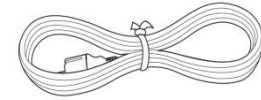

Power Cord

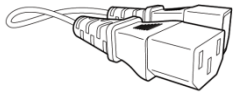

Extension Power Cable

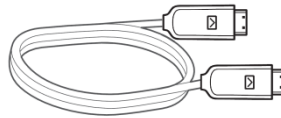

OCM Cable

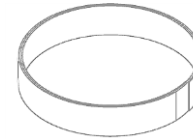

PET Tape (W10*L540,1 EA)

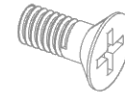

Machine Screws (M4*L10, 13 EA)

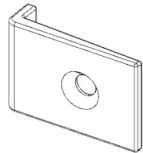

COVER PCB (4ea)

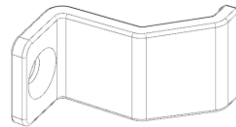

COVER PCB (6ea)

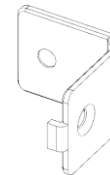

BRACKET LINK (2ea)



BRACKET ALIGN (1ea)

1. Frame Kit & JIG Configuration

- Check the following items in each package.

No.	Item	Frame F Lv3	Frame F Lv1	Frame F PIVOT
		VG-LFR13SWL	VG-LFR11SWL	VG-LFR11PWF
		Quantity		
		1x3	1x1	1x1 PIVOT
(a)	ASSY BRACKET SIDE	2	2	2
(b)	JOINT V	2	2	-
(c)	SCREW (M4)	4	4	-
(d)	WRENCH	1	1	-
(e)	ASSY ANCHOR SCREW	8	4	4
(f)	QUICK INSTALL Guide	1	1	1
Installation Screen Size (mm)		240X1620	240X180	180X240

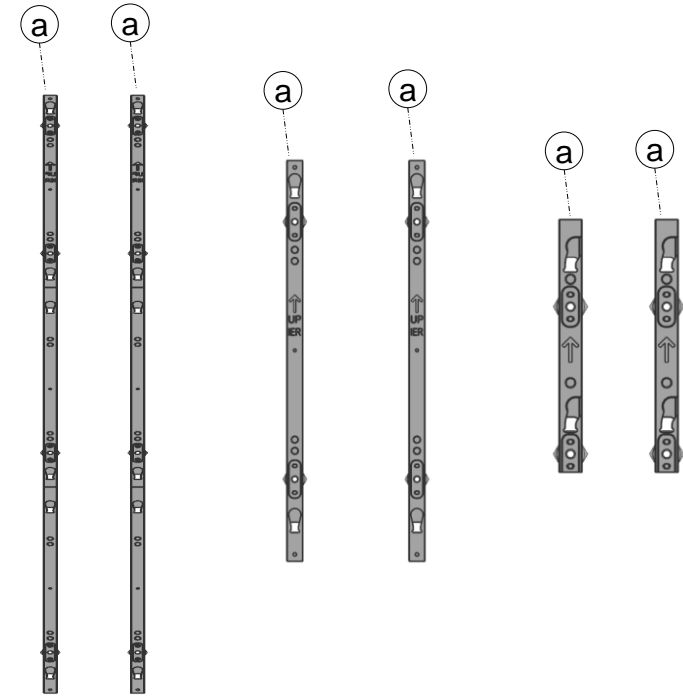

Frame F Lv3, Frame F Lv1, Frame F PIVOT

(b)



JOINT V

(c)



SCREW (M4)

(d)



WRENCH

(e)



ASSY ANCHOR SCREW

(f)



QSG

1. Frame Kit & JIG Configuration

- Check the following items in each package.

No.	Item	JIG F	JIG F PIVOT
		CY-LJRNEF	CY-LJRNPF
		Quantity	
(a)	JIG	1	1
(b)	STUD - PEM	-	4
(c)	L SUPPORT	1	-
(d)	QSG	1	1
(e)	D-TOOL	1	1

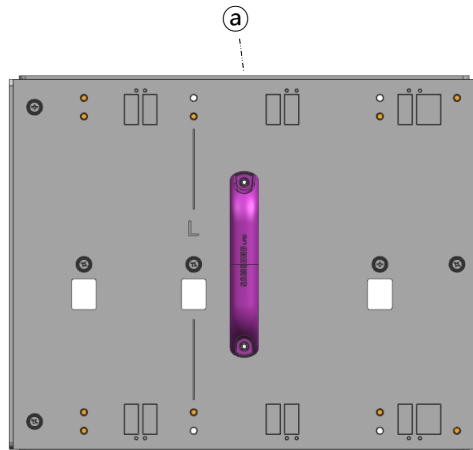
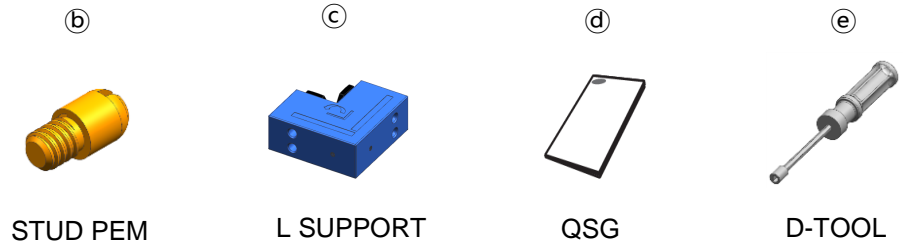

JIG F

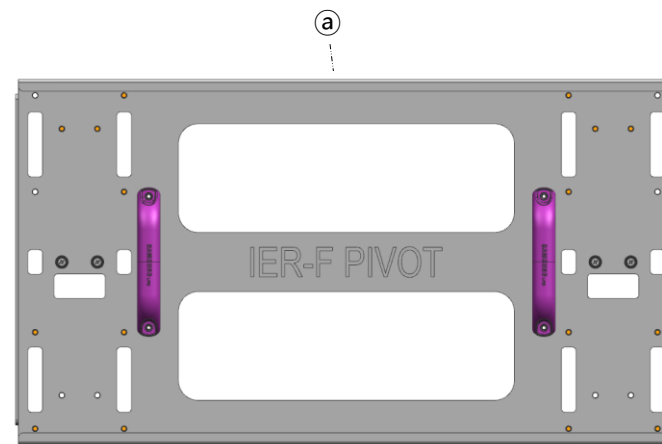

JIG F PIVOT

2. IER Landscape Installation + IER-F Extension

- For installation of IER-F, use 1 x 1 Frame (VG-LFR11SWL) and use the JIG hole gap different from that of IER.
(IER: 270 mm / IER-F: 240 mm)
- As in the following figure, use the JIG F (NEW) for ①, ③, and ④ and use the previous JIG (included in VG-LFR84FWL, VG-LFR53FWL, and VG-LFR52SWL) for ②.
- For installation of ②, it is required to move the Stud of JIG (see page 9).

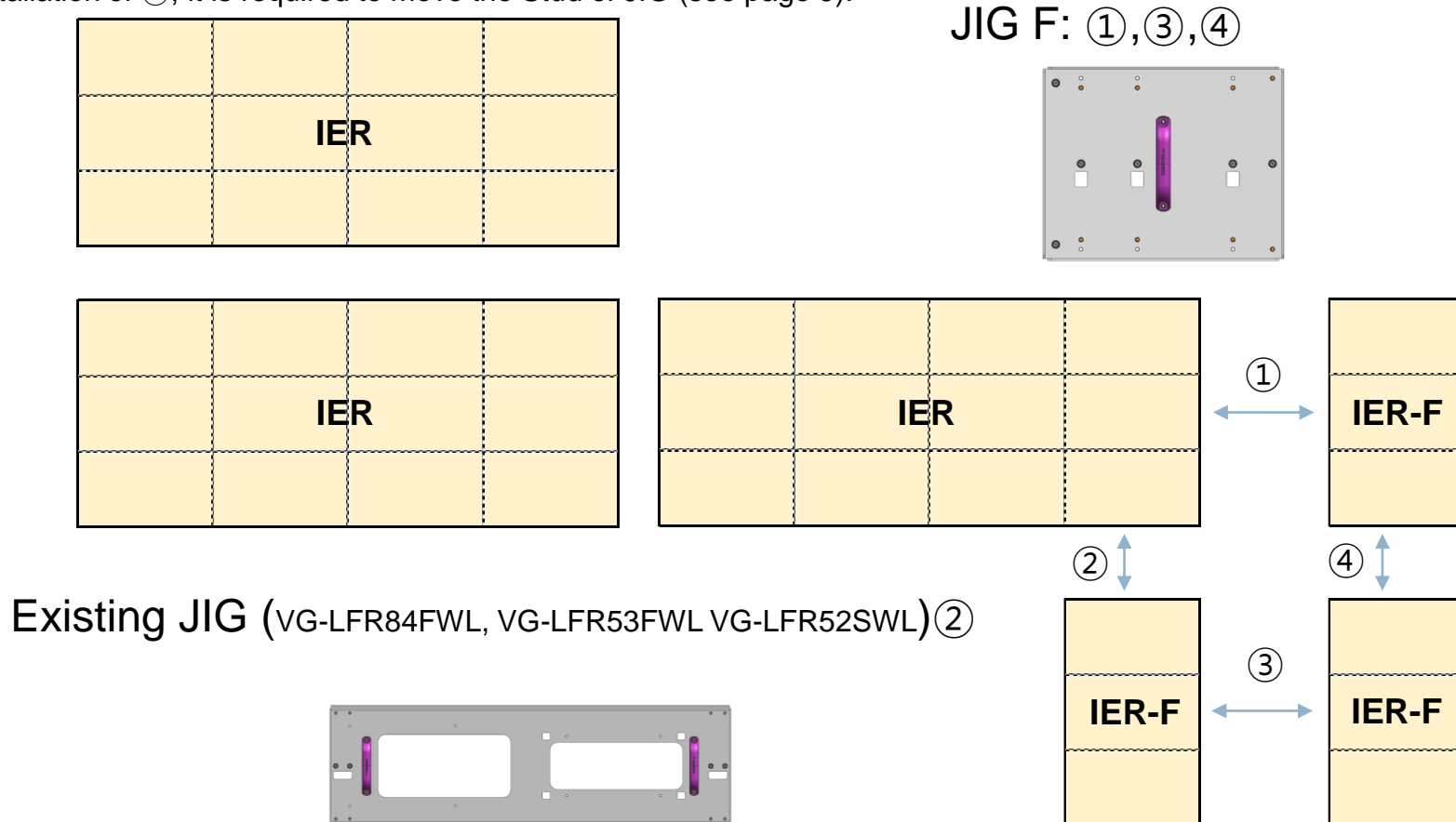

Fig1. IER-F Extension for General Installation of IER

2. IER Landscape Installation + IER-F Extension

- The JIG F needs 3 different gaps between IER and IER-F, between IER-F cabinets, and between IER-Fs.
- In the place with a Stud hole, mount the IER Frame. In the place with two Stud holes, mount the IER-F Frame.

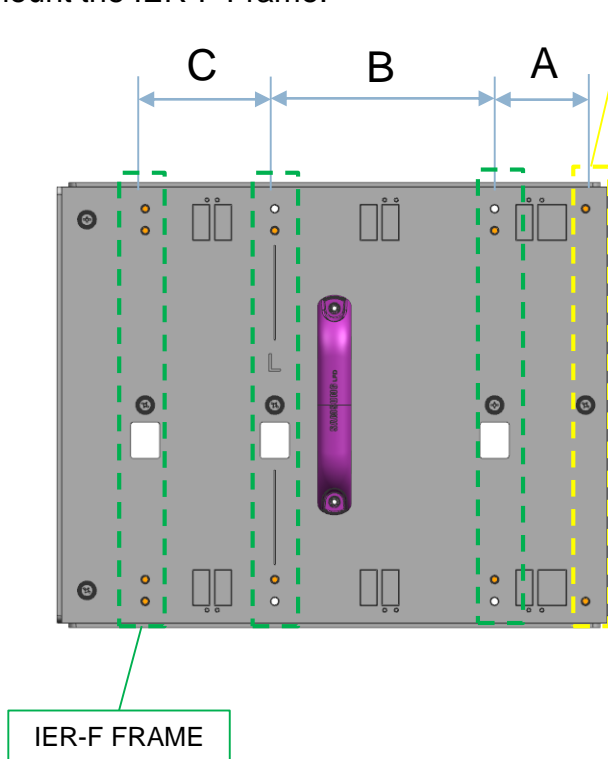
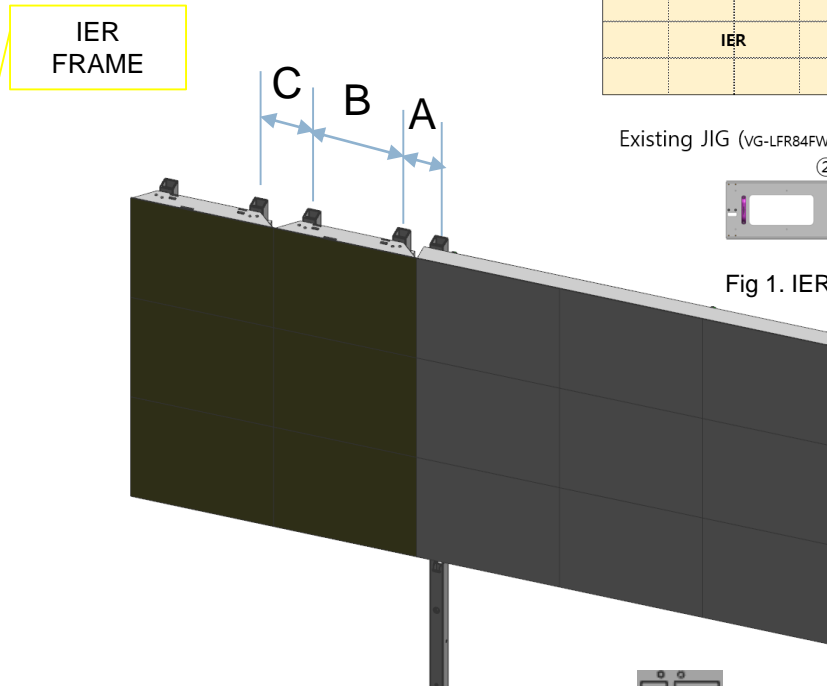

Fig 2. Locations of JIG F Studs



- A: Frame gap between IER and IER-F
- B: Frame gap in the IER-F Cabinet
- C: Frame gap between IER-Fs

Fig 3. Gaps between JIG F Studs

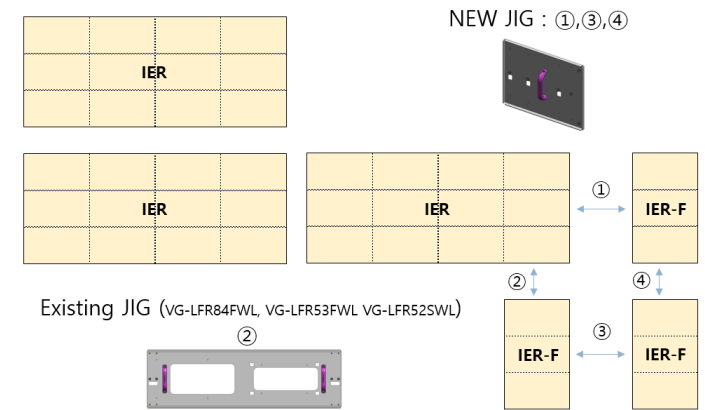

Fig 1. IER-F Extension for General Installation of IER

2. General Installation of IER + IER-F Extension Frame F

- There are two types of Frame Kits (LV1 & LV3) for installation of IER-F Landscape (Fig 4).
- Different from the IER Frame, be careful upon installation because the Frame F has no direction for left and right. (Fig 5)
- There are two types of JIG hole gaps (240 mm, 270 mm) on the Frame F, but 240 mm is used mostly for installation and
- 270 mm is used only when IER-Fs are extended (Fig 6).

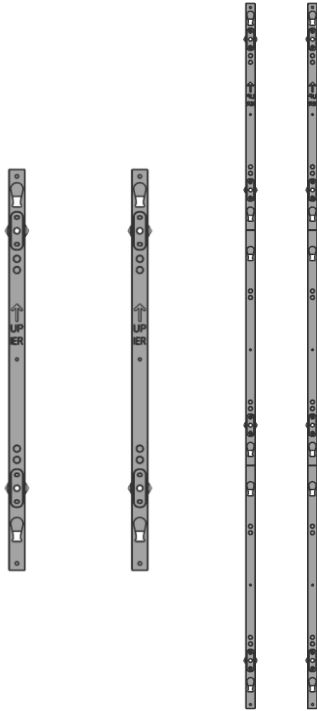

Fig 4. FRAME F (LV1, LV3)

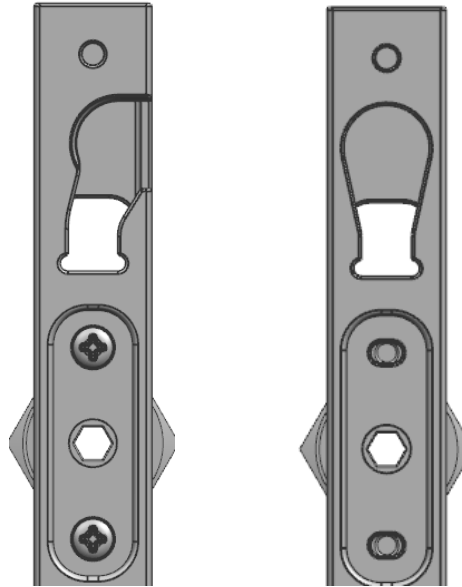

Fig 5. Different Shapes of IER Frame and F Frame Cabinet Joints (Directional)

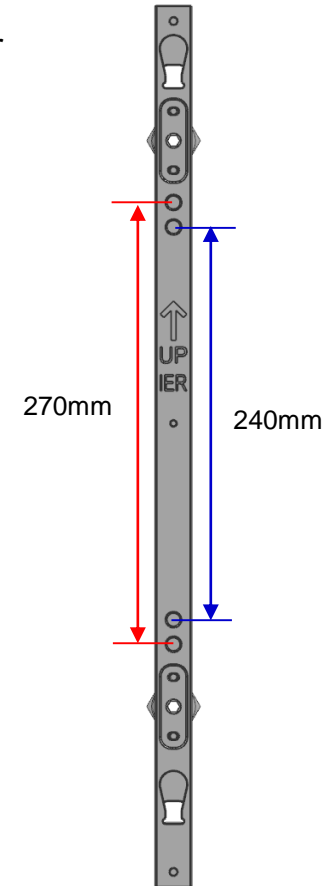

Fig 6. FRAME F JIG HOLE

2-1. IER + IER-F Extension (Left to Right)

- Use the JIG F when installing the IER-F ("F") left to right on the installed IER Frame.
- Fasten an IER Frame Side and two Frame Fs on the JIG.
- Align the Stud of JIG with the JIG hole of the Frame, and then fasten the JIG screws.

*Be sure to check the hole locations – IER: 270 mm / IER-F: 240 mm

- Fasten the Frame F to the wall with screws.

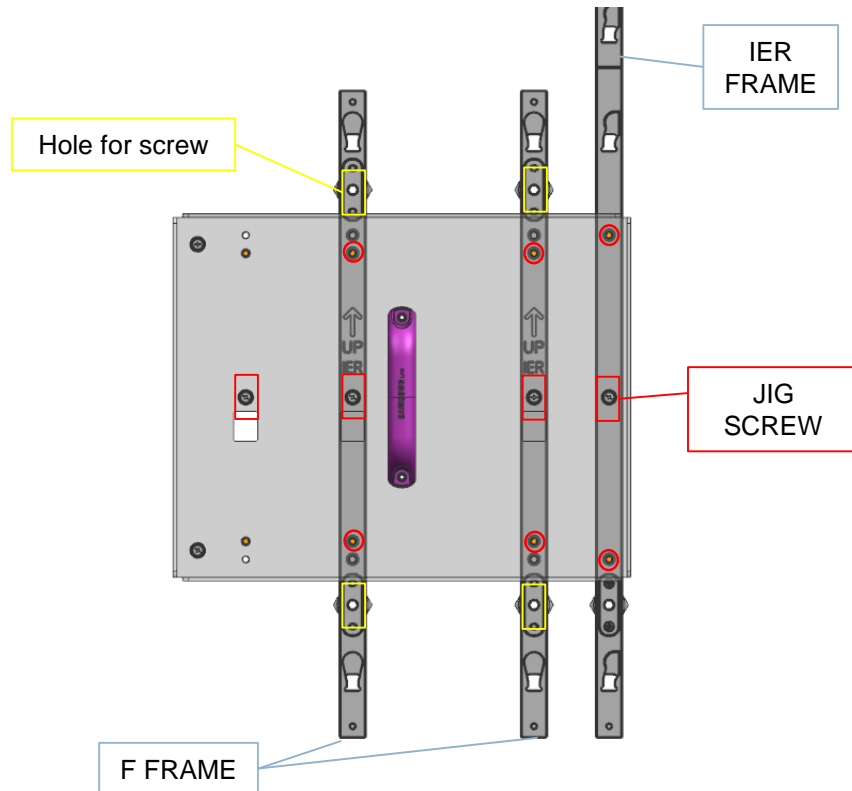
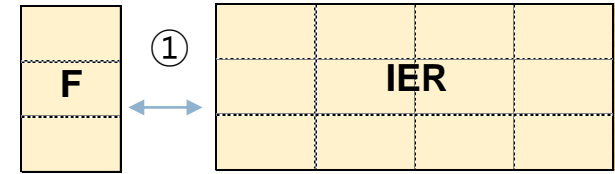

Fig 7. Shape of Mounted JIG F

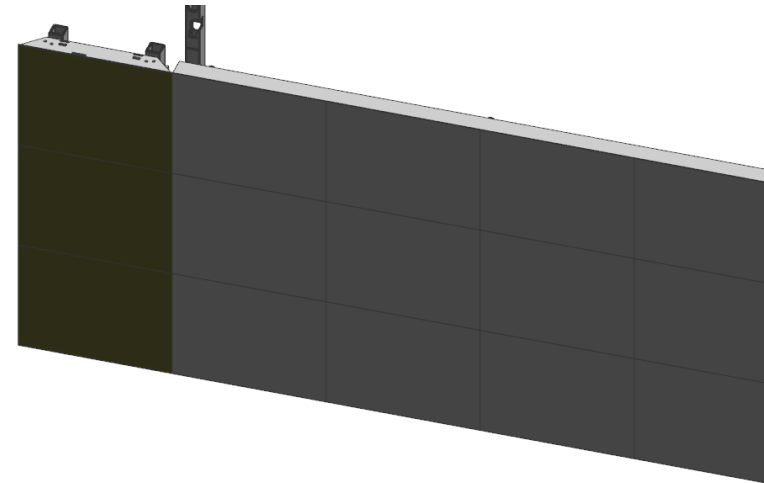

Fig 8. IER-F Installed to the Left of IER

2-2. IER + IER-F Extension (Up to Down)

- When F is installed horizontally on the installed IER Frame, use the default JIG of IER (included in VG-LFR84FWL, VG-LFR53FWL, and VG-LFR52SWL).
- The Stud location of the default JIG must be adjusted (FIG 9).
- Align the JIG Stud with the JIG hole of the Frame.
 - *Be sure to check the hole locations – IER: 270 mm / IER-F: 240 mm
- Fasten the Frame F to the wall with screws.

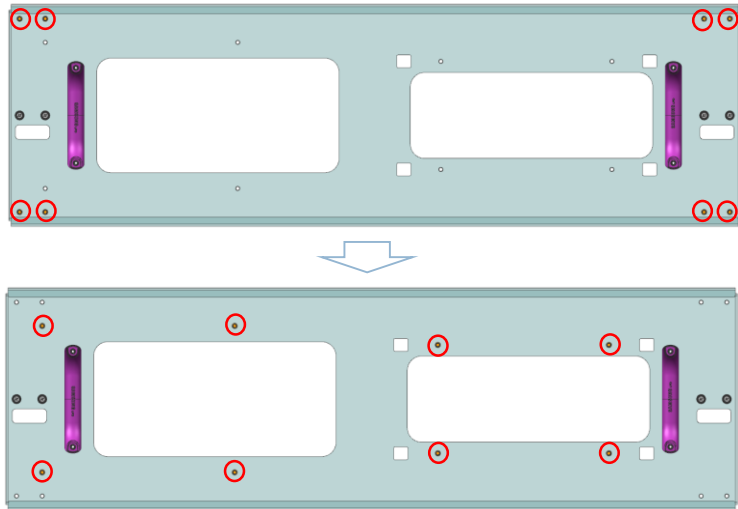

Fig 9. Before and After Changing the JIG Stud Location

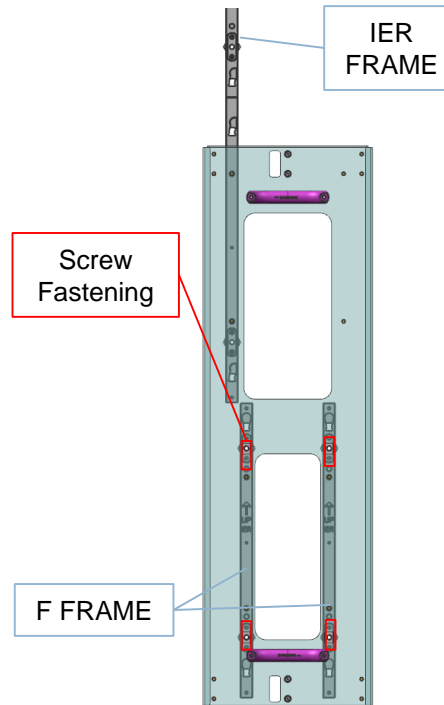

Fig 10. Shape of Mounted JIG

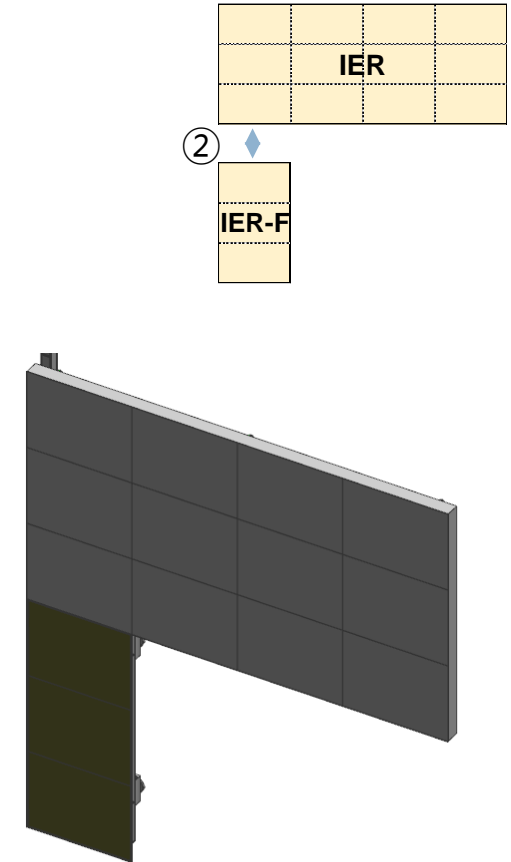

Fig 11. IER-F Installed to the Bottom of IER

2-3. IER-F + IER-F Extension (Left to Right) Samsung Electronics

- Use the JIG F when installing the F left to right on the installed Frame F.
- Fasten a Frame F and two Frame Fs on the JIG.
- Align the Stud of JIG with the JIG hole of the Frame, and then fasten the JIG screws.
- Fasten the Frame F to the wall with screws.

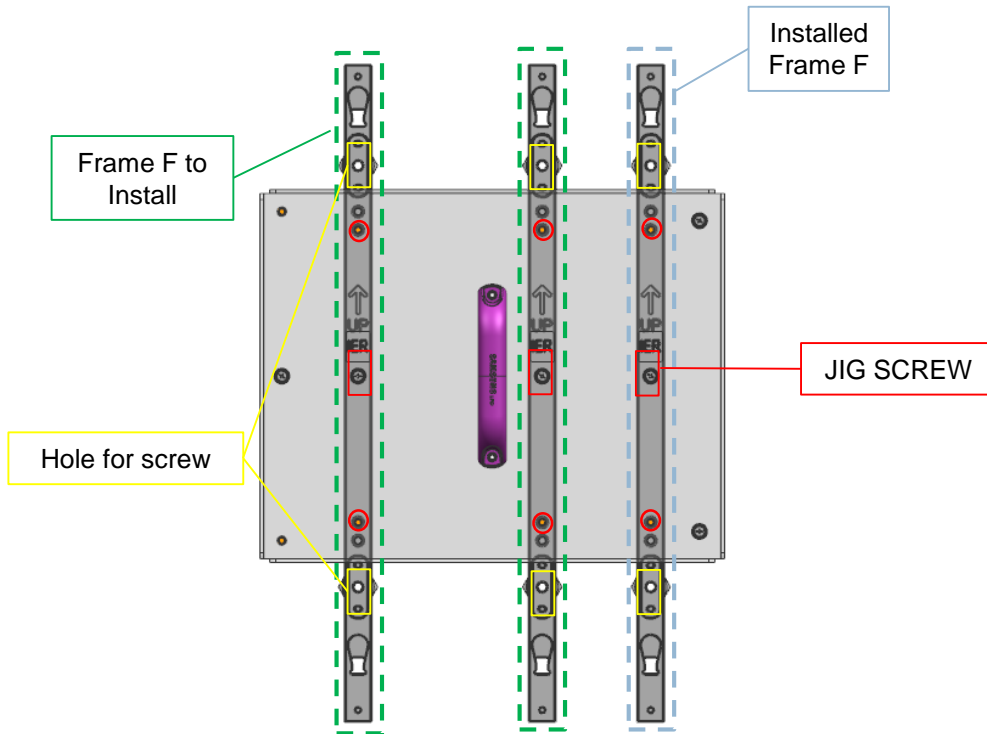
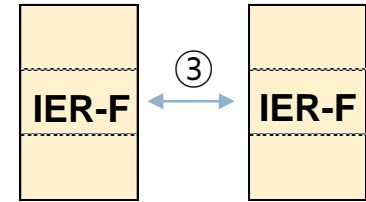

Fig 12. Shape of Mounted JIG F

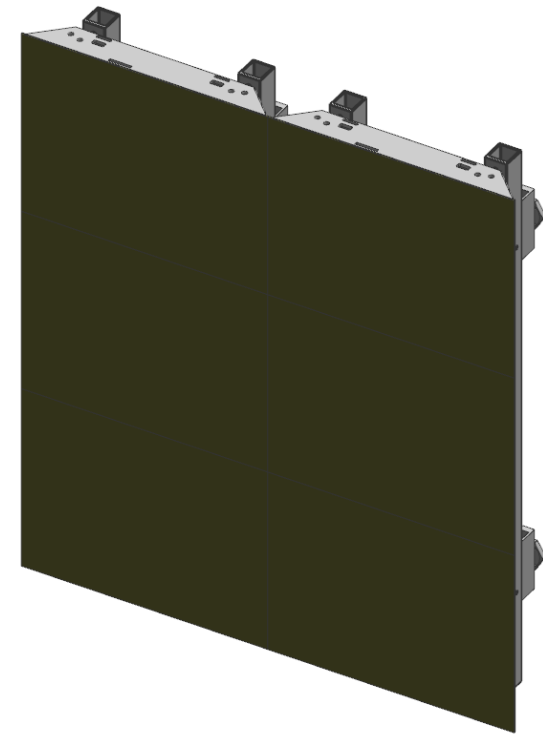

Fig 13. IER-F Installed to the Left of IER-F

2-4. IER + IER-F Extension (Up to Down)

- Like the vertical extension of the IER Frame, use the Joint V and for this purpose, change the Stud location of the JIG F.
- However, in this case, the frames may not be aligned vertically. Accordingly, the **vertical and horizontal checks** are mandatory.
- Extended installation is the same as in IER.
- Fasten the Joint V to the Frame to extend.
- Insert the Joint V of the Frame to extend into the previous Frame for exact positioning, and then fasten the screws.
- The vertical gap between Frames after extension is 1 mm.

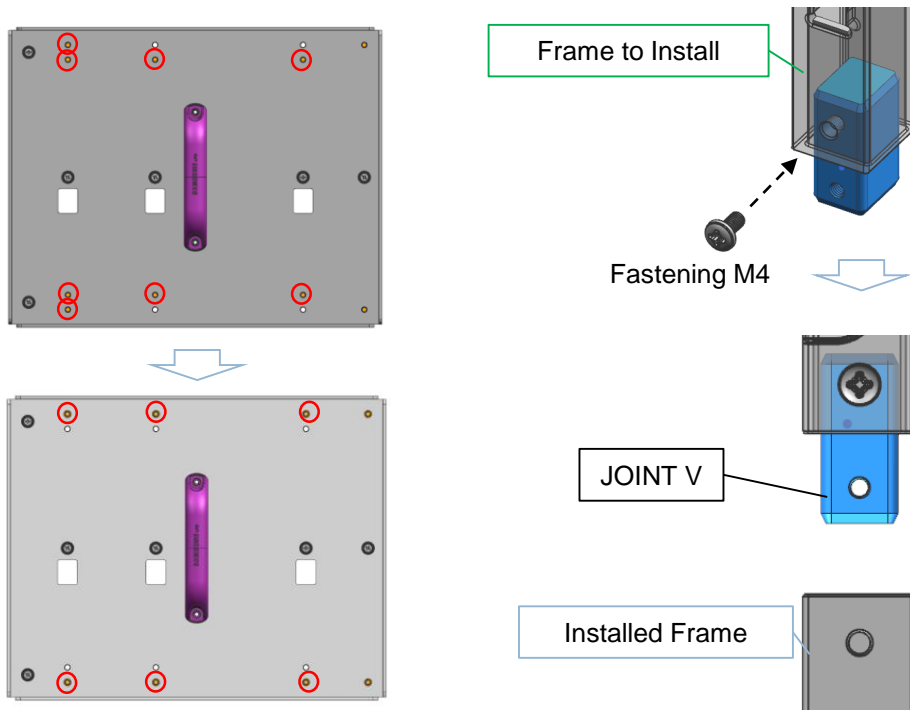

Fig 14. Before and After Changing the JIG Stud Location

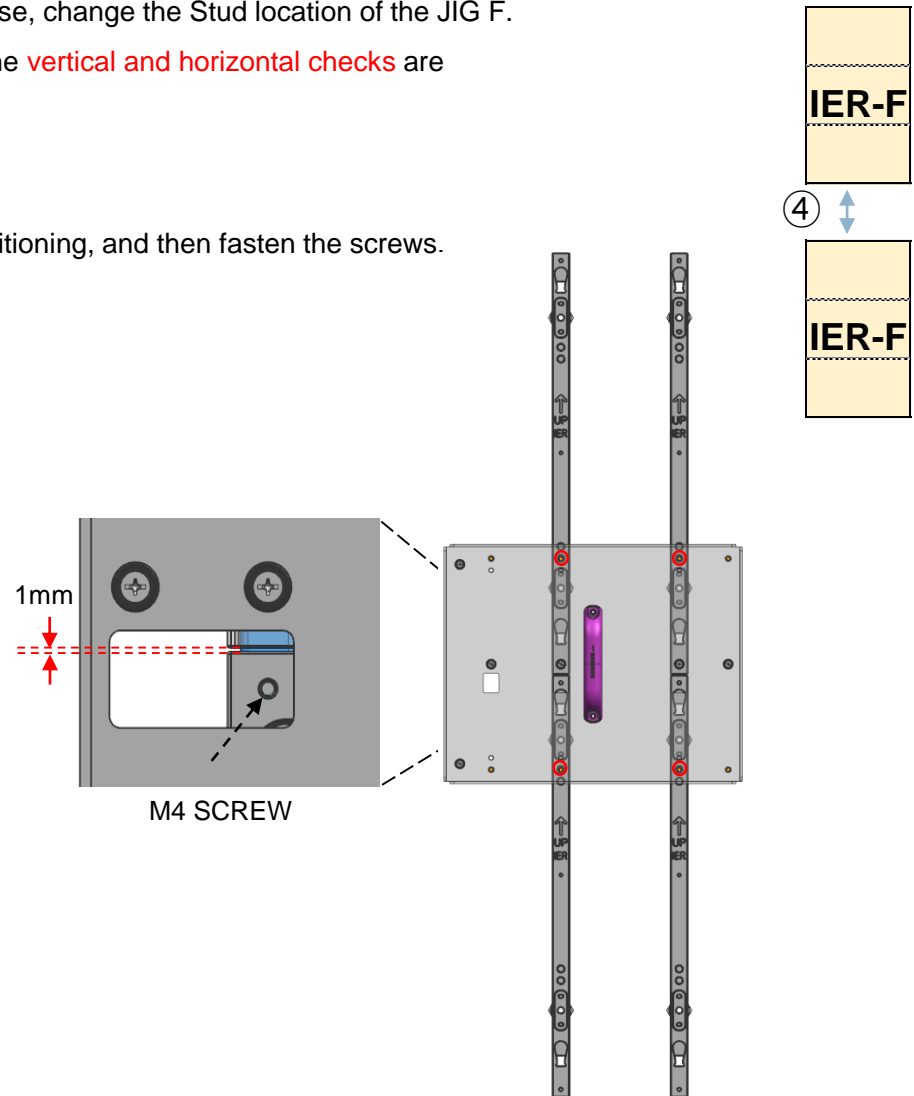

Fig 15. Vertical Extension

2-5. IER-F + IER-F L-Type Installation

- When there is any L-type installation, install the L-type Frame Kit first of all.
- For L-type installation, use **two JIG Fs (CY-LJRNEF)**.
- Align the fastened Stud with the L Support and then fasten JIG screws. (Fig 17)
- Fasten two Frame F Sides in the **L mark of the JIG F**.
- Align the Stud of JIG with the JIG hole of the Frame, and then fasten the JIG screws.
- **Adhere the inner side of L Support to the wall.**
- Fasten the Frame F to the wall with screws.

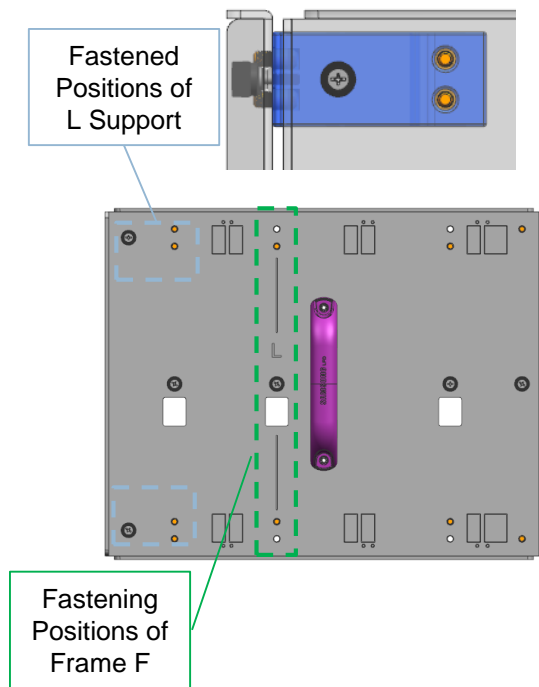

Fig 16. Fastening Positions of L-type JIG

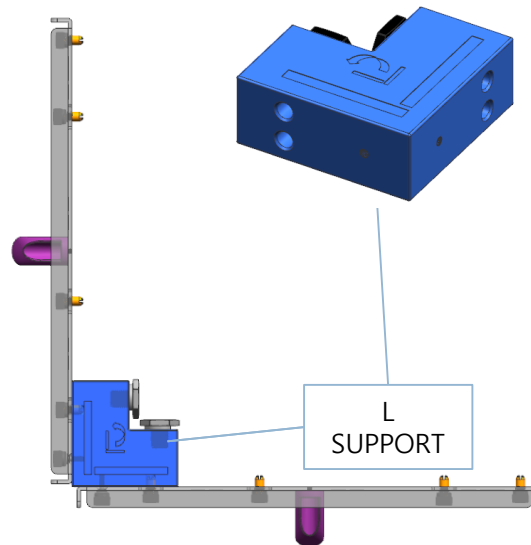

Fig 17. JIG F with the L Support Fastened

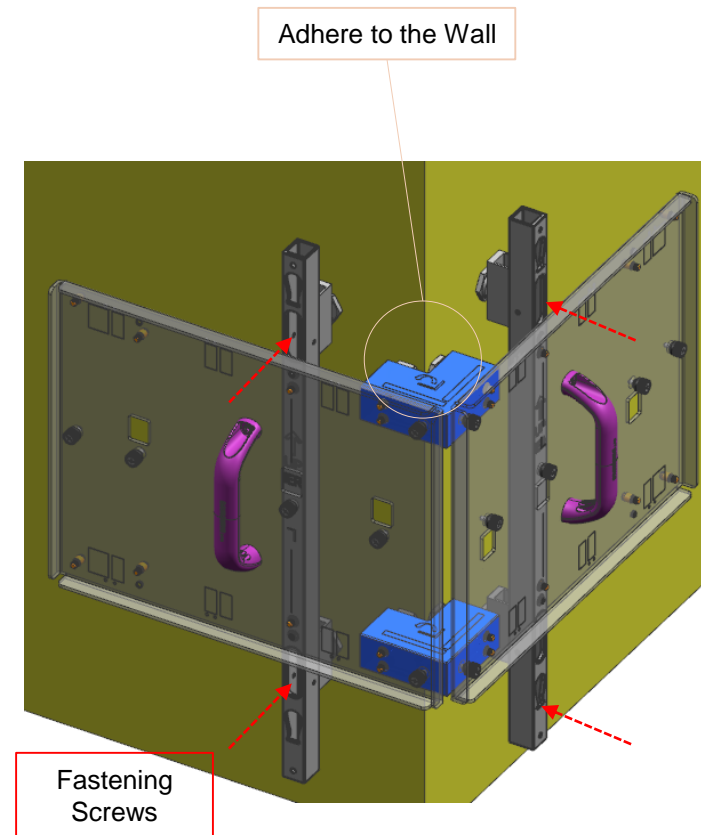

Fig 18. Fastened L-type JIG

2-5. IER-F + IER-F L-Type Installation

- When the Frame F Lv3 is used, repeat JIG fastening and screw fastening from top to bottom.
- After fastening the Frame F to the wall with screws, for detaching the JIG F from the Frame F,
- Remove a JIG F from the L Support and then remove another JIG F.
 - * Otherwise, be careful because deformation may happen to the JIG F or L Support.

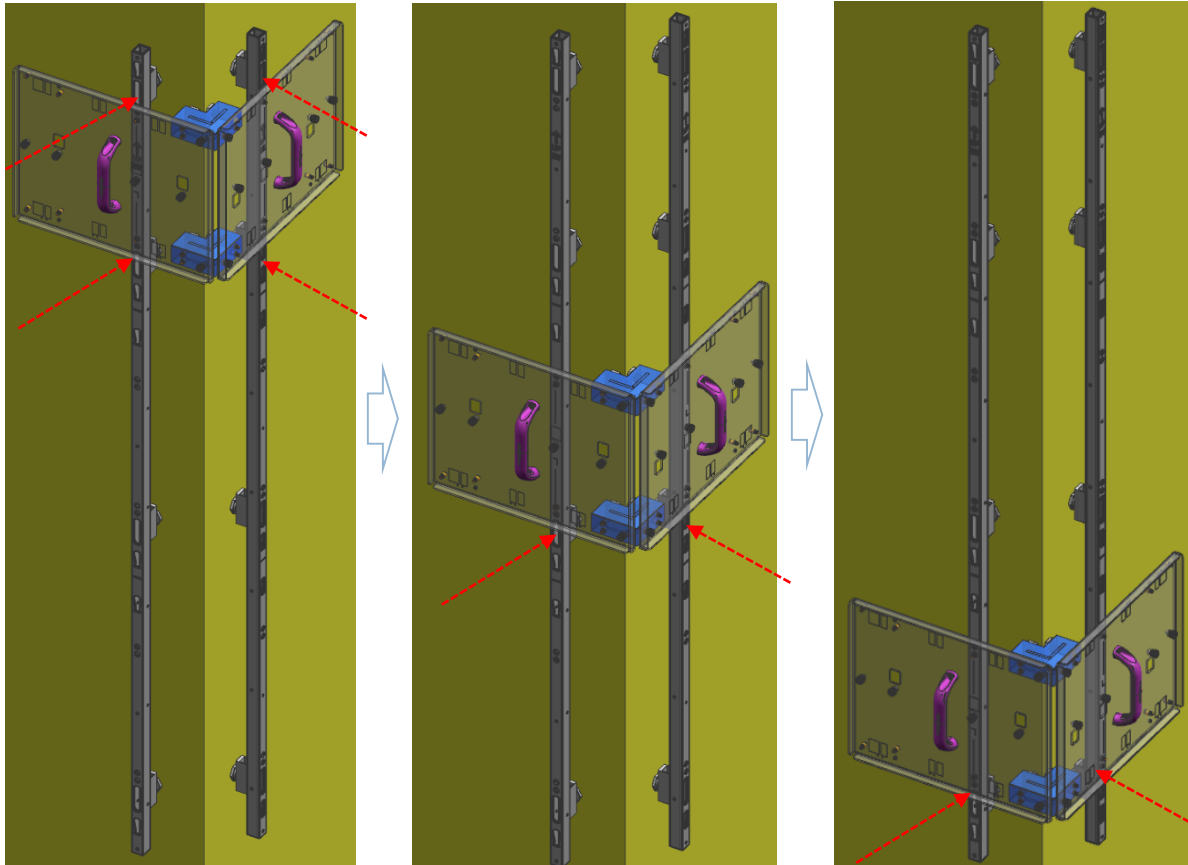

Fig 19. Frame F's Lv3 L-type Installation Order

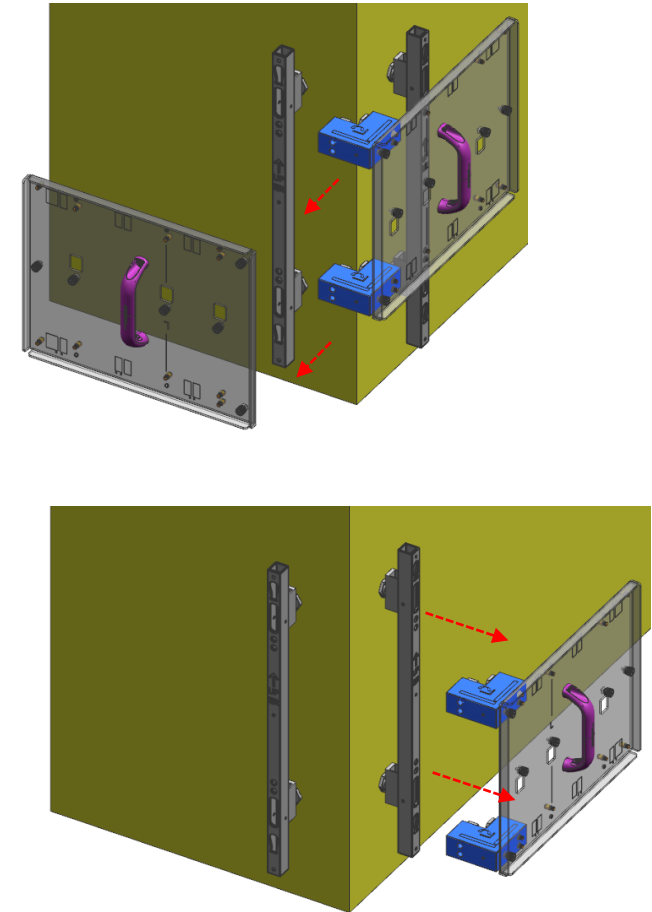

Fig 20. L-type JIG Disassembly Order

2-5. IER-F + IER-F L-Type Installation

Cabinet Installation

- For IER-F L-type installation, use only two among four BOLT ETCs and remove the BOLT-ETCs not in use. (Fig. 21)
- In the joint where two cabinets are met (L-type corner), do not use the BOLT ETC but the outer BOLT-ETC. (Fig. 22)
- During L-type installation, a cabinet protrudes to cover another one. This direction can be determined, noting the L Support mark while installing the Frame Kit. (Fig. 23)



Fig 21. Removal of BOLT ETC

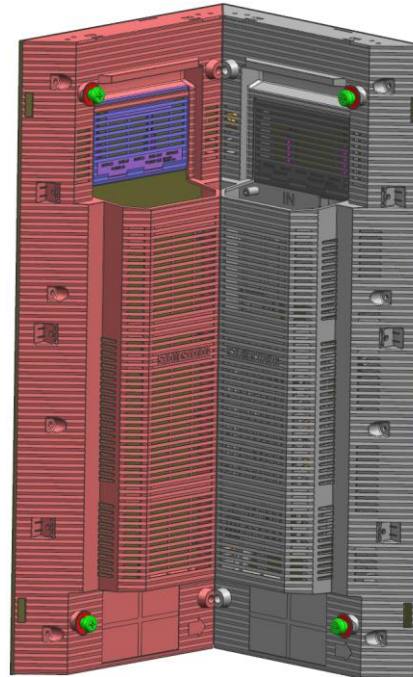

Fig 22. Rear Panel during L-type Installation

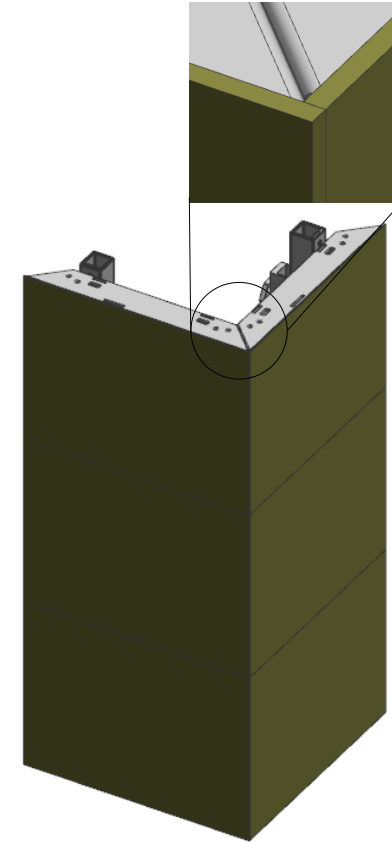

Fig 23. Overlapping Area of L-type Module

2-5. IER-F + IER-F L-Type Installation

Cabinet Installation

- During L-type installation, a module covers another one. This direction can be determined, noting the L Support mark while installing the Frame Kit.

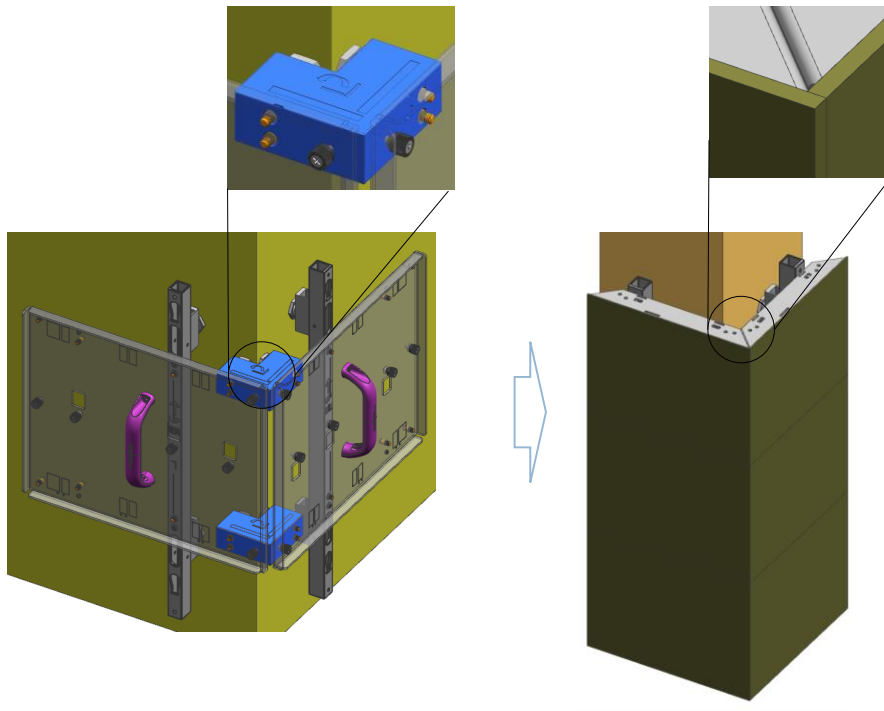

Fig 24. L Support Marks and Module Overlapping Structure

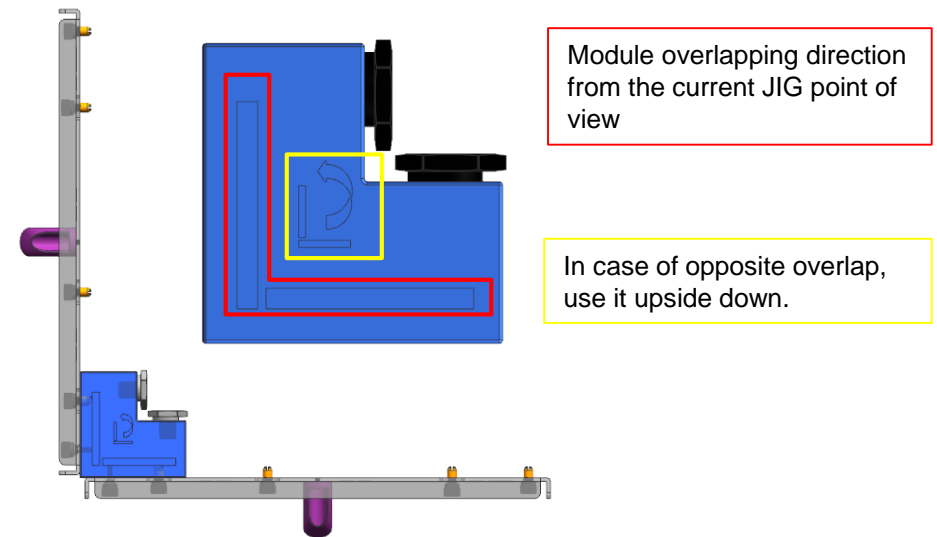
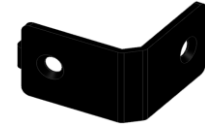

Fig 25. L Support Marks

2-5. IER-F + IER-F L-Type Installation

Cabinet Installation

- Mount IER-F Cabinets one by one.
- Remove two (Up and Down) of three modules.
- Assemble the Bracket Link and fasten it with screws through the hole in the L-shaped corner where the module has been removed. * See next page.
- Connect and assemble the modules (Power, FFC, Cable) to end the L-type installation.



Bracket Link
(included in the L-type/Set)

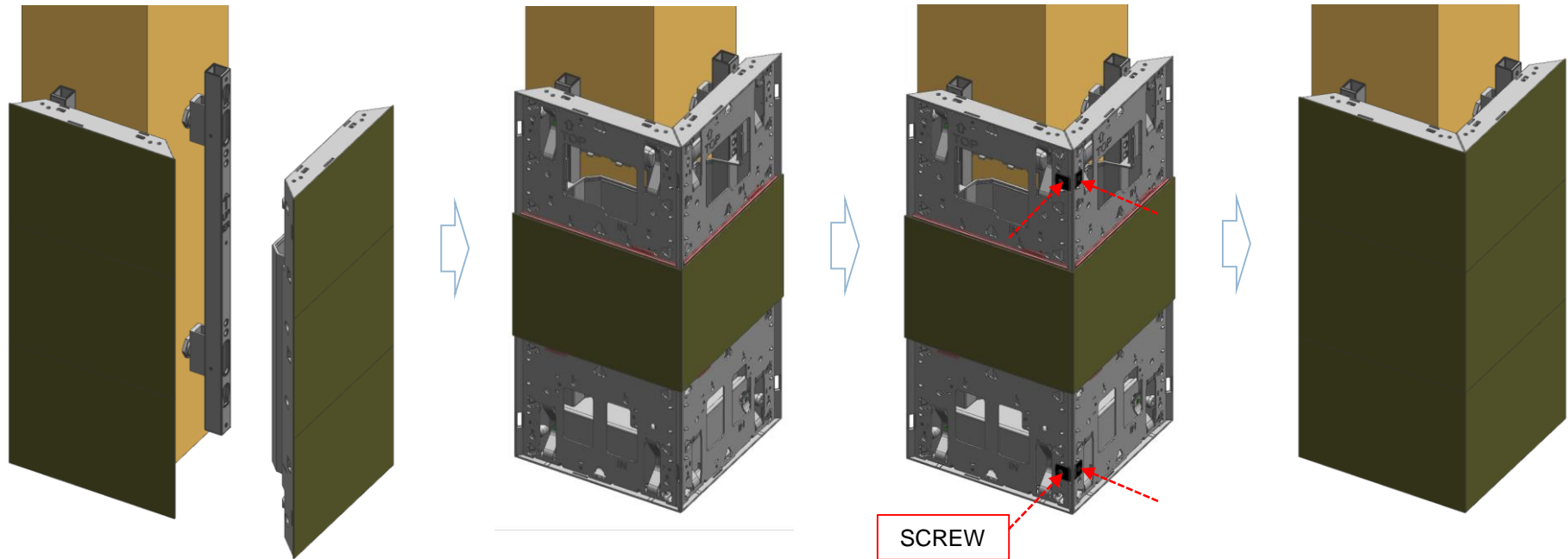

Fig 26. L-type Installation Procedure

2-5. IER-F + IER-F L-Type Installation BRACKET-LINK

- Remove the Insulator Sheet attached to the Bracket Link's assembly part of the Cover Rear.
- Check the Bracket Link assembly marks to make sure that the TOP is assembled with the TOP and the BTM with the BTM.
- Only an end of the Bracket Link has the assembly position guide.
- Insert the Bracket Link through the Bracket Link assembly hole on the Cover Rear, fix the Guide, and fasten the Bracket Link with screws.
- At this time, the Guide of the Bracket Link must be fixed through the Guide Hole of the Plate that protrudes outward (Module Side is exposed).

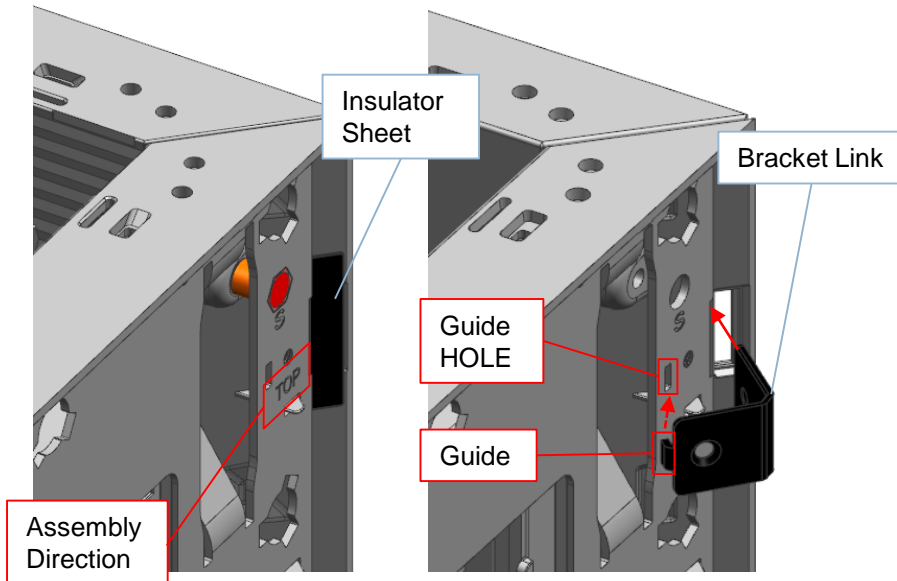

Fig 27. Bracket Link Assembly

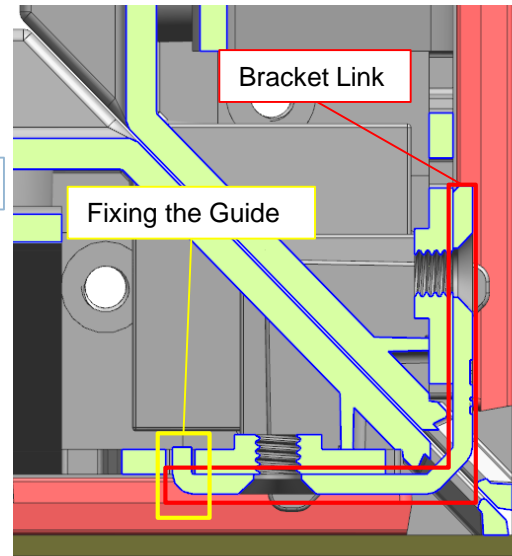
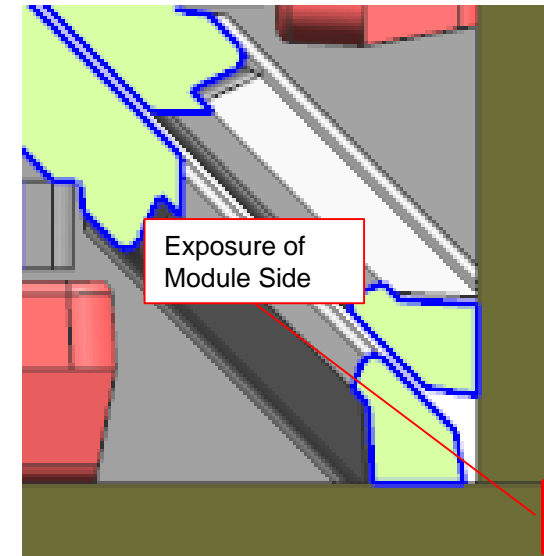

Fig 28. Bracket Link Direction



2-5. IER-F + IER-F L-Type Installation

BRACKET-ALIGN

- When IER-Fs are stacked upward, fasten the Bracket Align that is used to compensate for Z-axis difference between top and bottom cabinets.
 - Remove the bottom module from the upper cabinet and the top module from the lower cabinet.
 - Pass the Bracket Align through the hole of the Cover Rear from the top to connect the up and down cabinets and fasten them with screws.
 - Connect the modules again.
- * Apply Bracket Align for L-type and all IER-F cabinets that are connected vertically.



Bracket Align
(included in the Set)

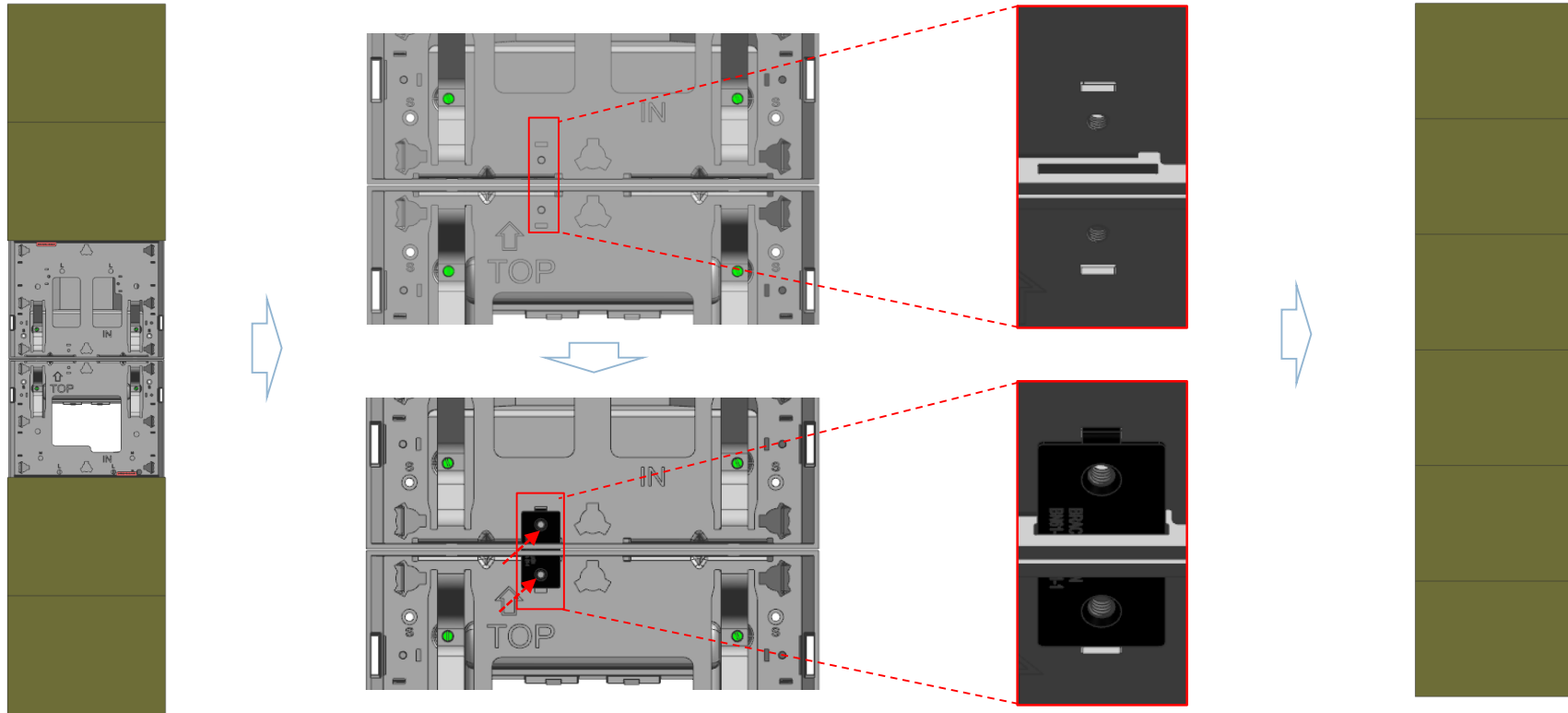

Fig 29. IER-F Bracket Align Installation Procedure

3. [PIVOT] IER + IER-F Extension

- During installation of IER Pivot, install the IER-F with the JIG F Pivot (CY-LJRNPF).

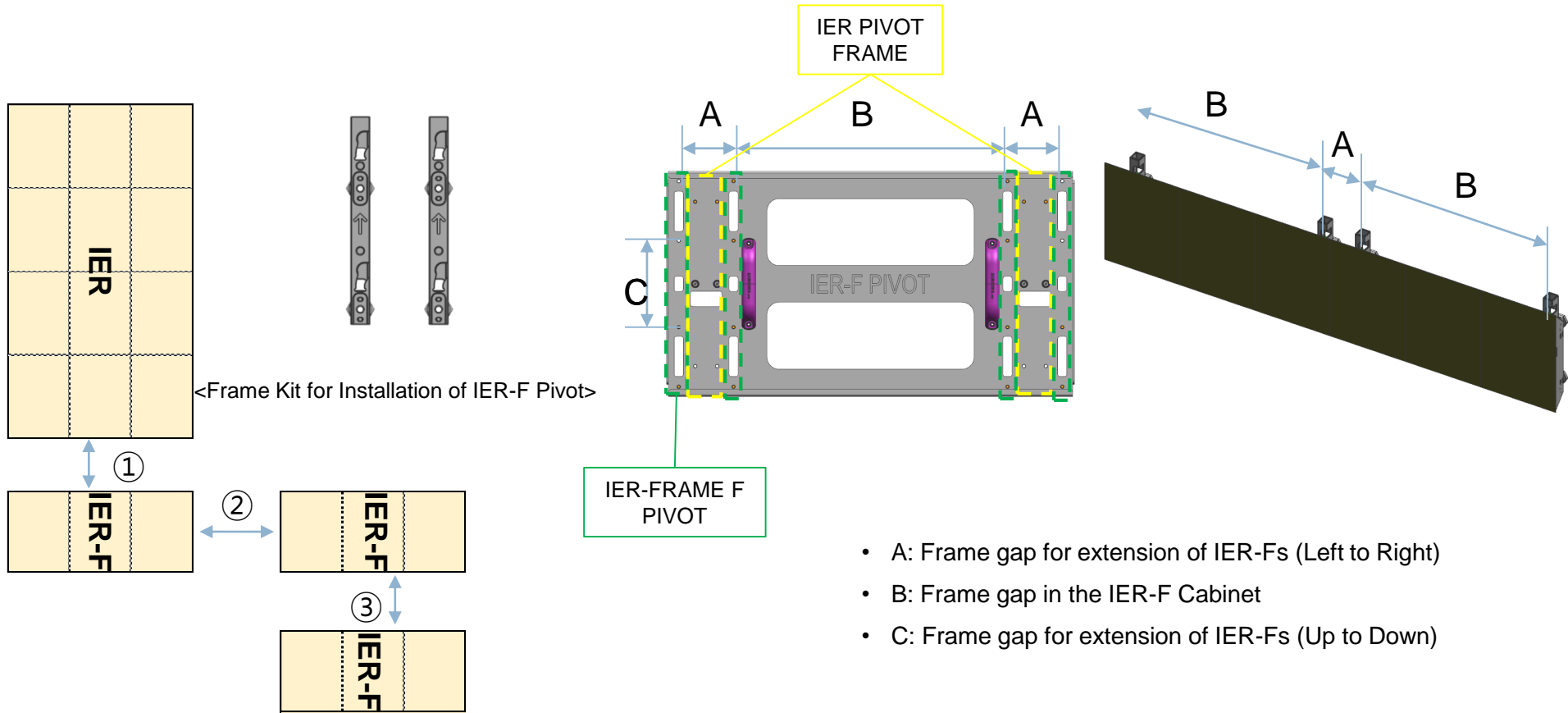

Fig 1. IER-F Extension and Frame Kit during Installation of the IER Pivot

Fig 2. JIG F PIVOT

3. [PIVOT] IER + IER-F Extension

- When installing the IER Pivot, install the Cabinet by turning it clockwise (from Front view).
-> Install it by turning the arrow on the rear to be upward.
- For installation of IER-F, use the **Frame F Pivot** (VG-LFR11PWF) and **JIG F Pivot** (CY-LJRNPf).
- The Studs for Case 1, 2, and 3, are different.

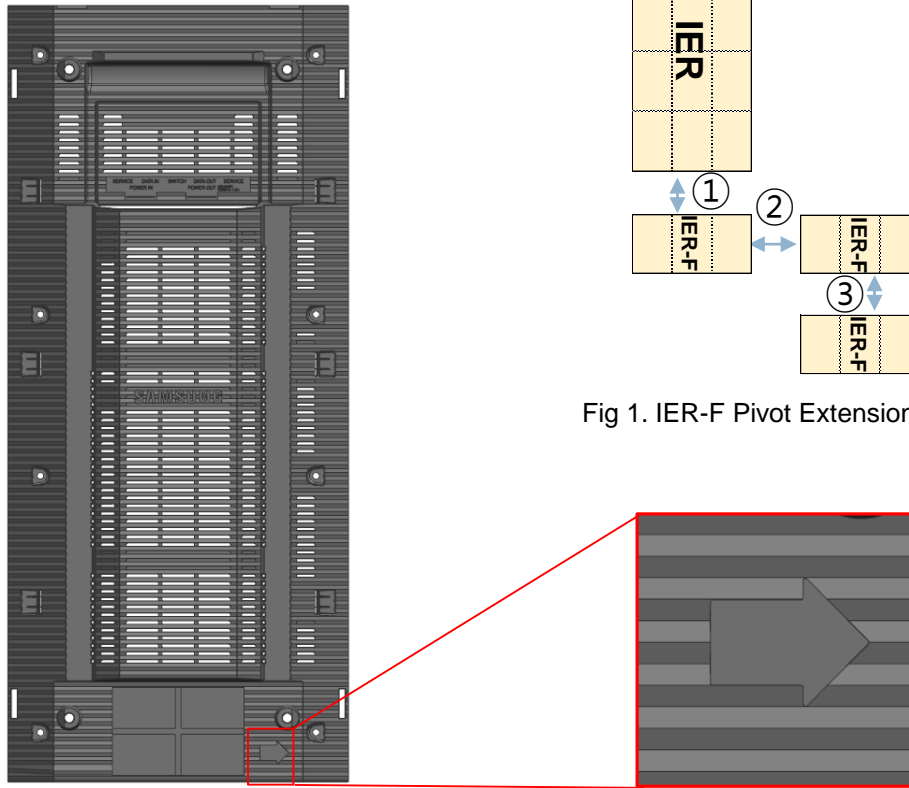
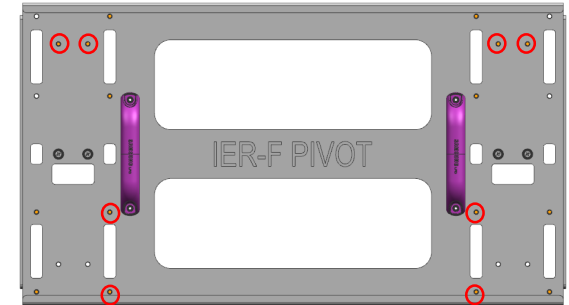
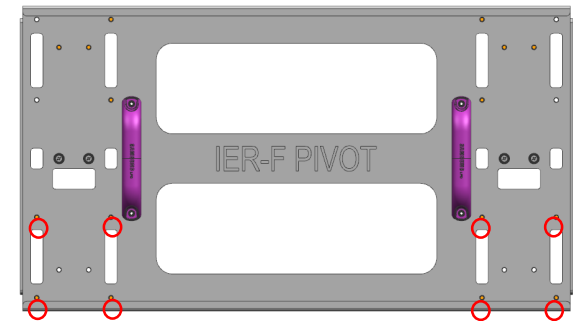

Fig 1. IER-F Pivot Extension Case

Fig 3. Pivot Arrow on the Rear



Case ① Installation (Default)



Case ② Installation

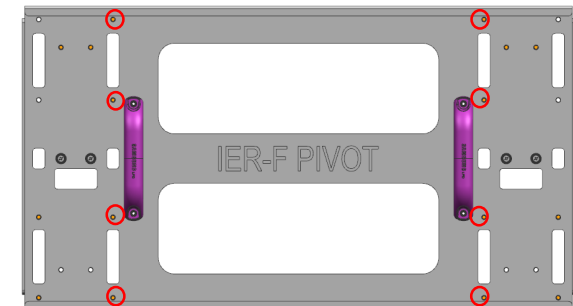

Case ③ Installation

Fig 4. JIG F Pivot Stud Positions for each Case

3-1. [Pivot] IER + IER-F Extension (Up to Down)

- Fasten an IER Pivot Frame and two Frame F Pivots on the JIG.
- Align the JIG Stud with the JIG hole of the Frame.
- Fasten the Frame F Pivot to the wall with screws.

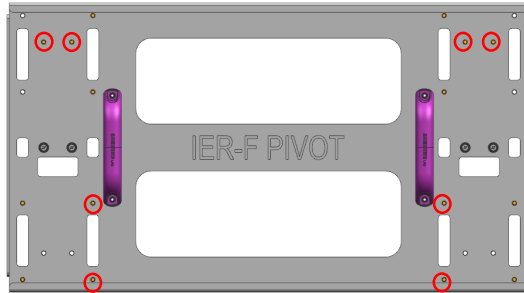

Fig *. Studs for Extension between IER and IER-F (Up to Down)

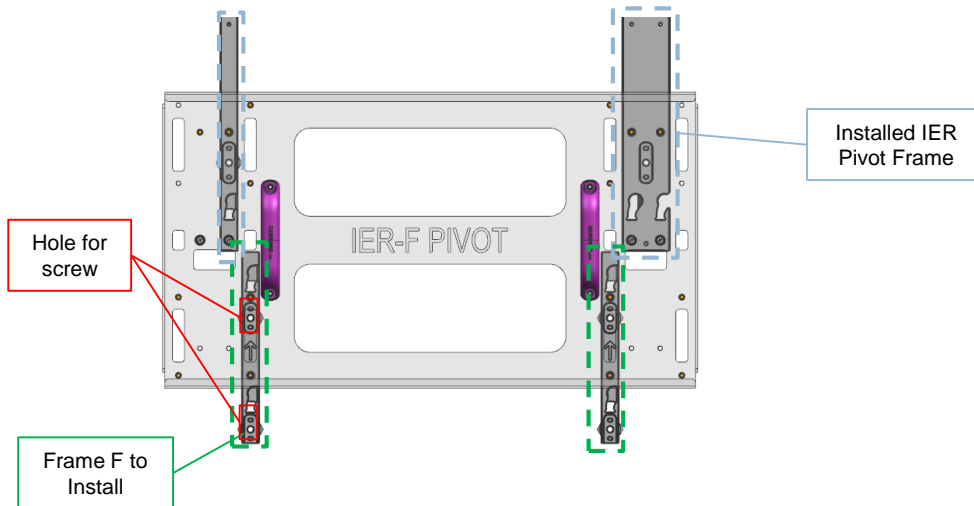

Fig 5. Fastened Shape of the JIG F Pivot

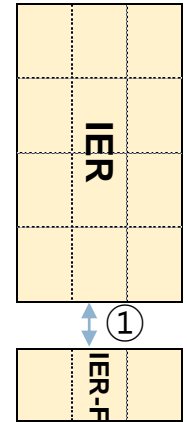
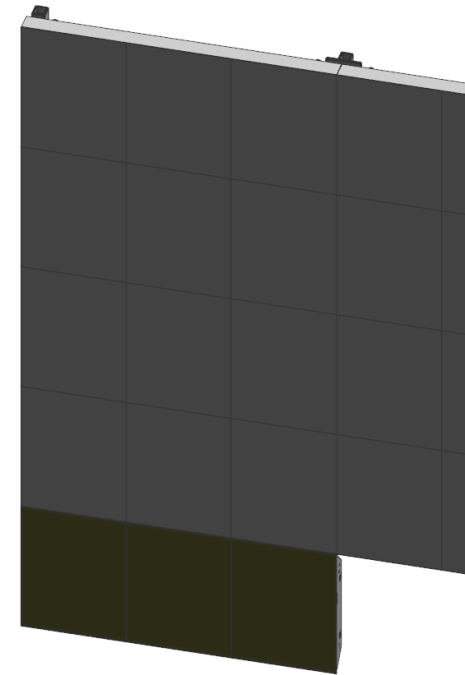
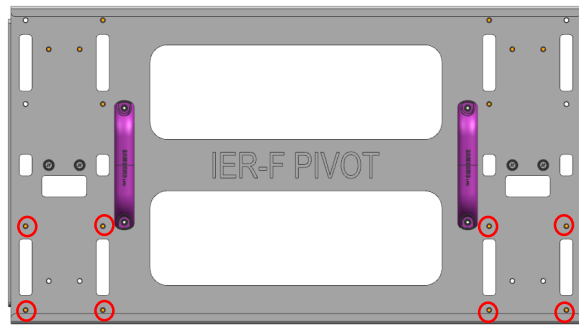

Fig 6. IER-F installed at the bottom of IER Pivot

3-2. [Pivot] IER-F + IER-F Extension (Left to Right)

Samsung Electronics

- Fasten the installed Frame F Pivot and two Frame F Pivots to install on the JIG.
- Align the JIG Stud with the JIG hole of the Frame. (without using the JIG screws)
- Fasten the Frame F Pivot to the wall with screws.
- Install it again after repositioning. (Fig 7)



Case ② Installation

Fig 7. Studs for Extension (Left to Right)

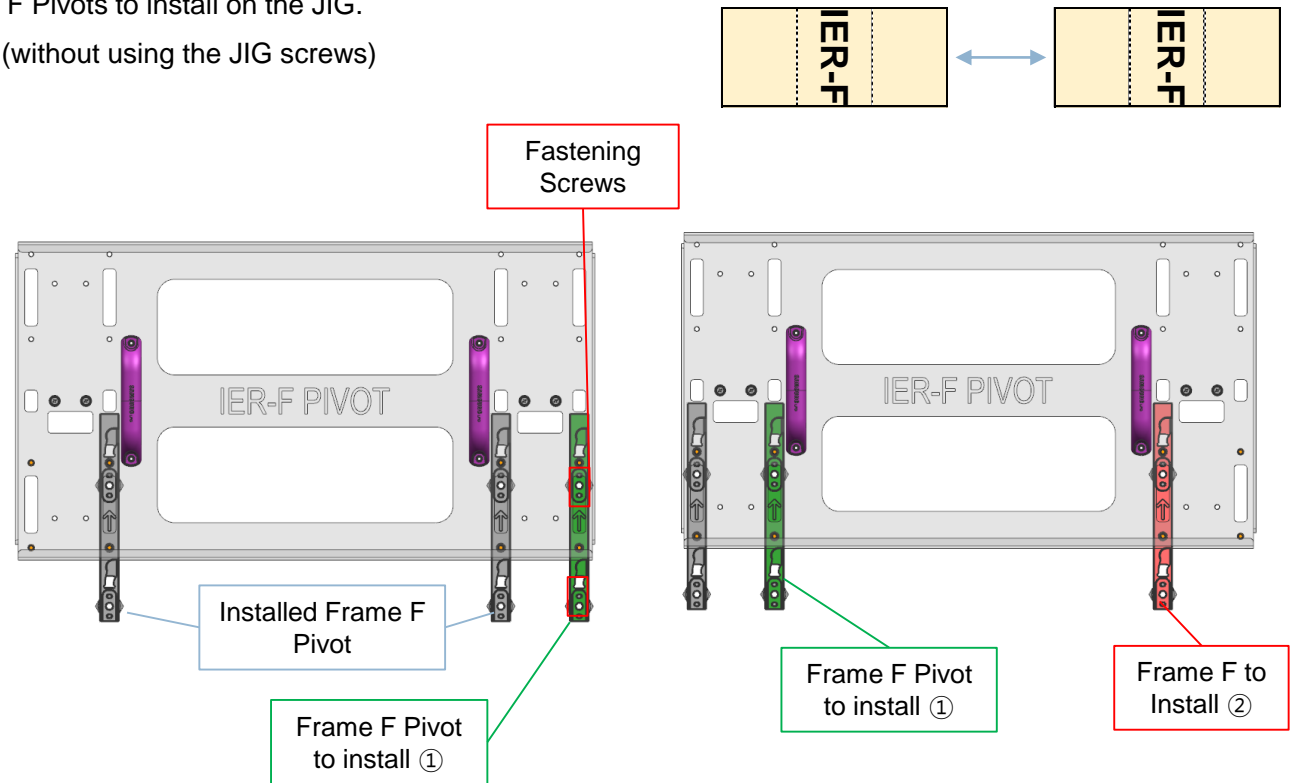

Fig 8. Frame F Extension (Left to Right)

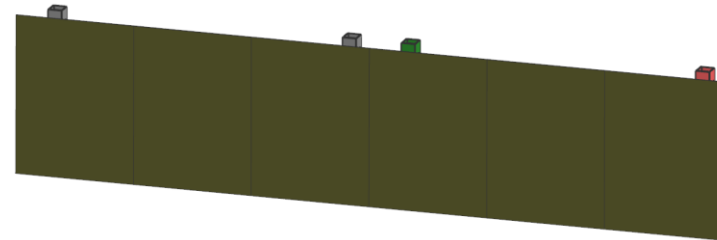
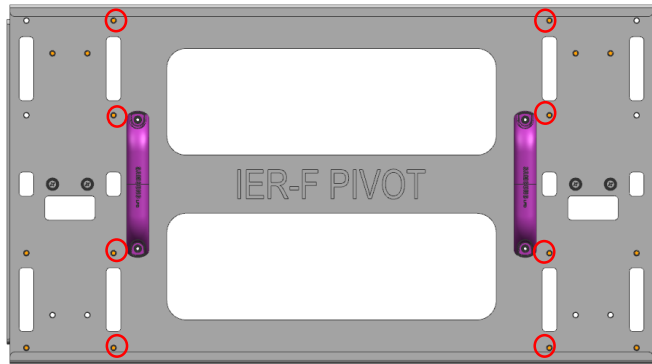
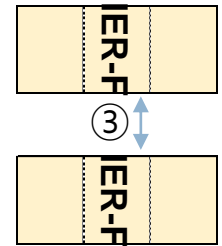

Fig 9. IER-F installed to the right of IER-F

3-3. [Pivot] IER-F + IER-F Extension (Up to Down)

- Fasten the installed Frame F Pivot and two Frame F Pivots to install on the JIG.
- Align the JIG Stud with the JIG hole of the Frame. (without using the JIG screws)
- Fasten the Frame F Pivot to the wall with screws.



Case ③ Installation

Fig 10. Studs for Extension (Up to Down)

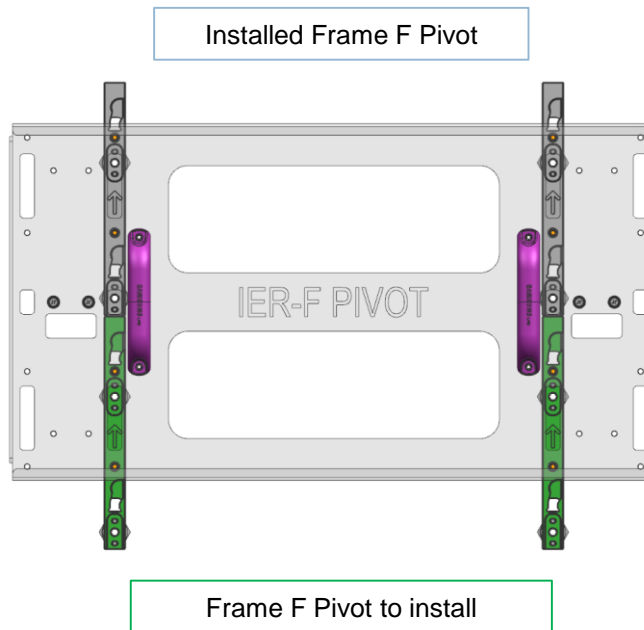

Fig 11. Fastening the JIG F Pivot Extension (Up to Down)

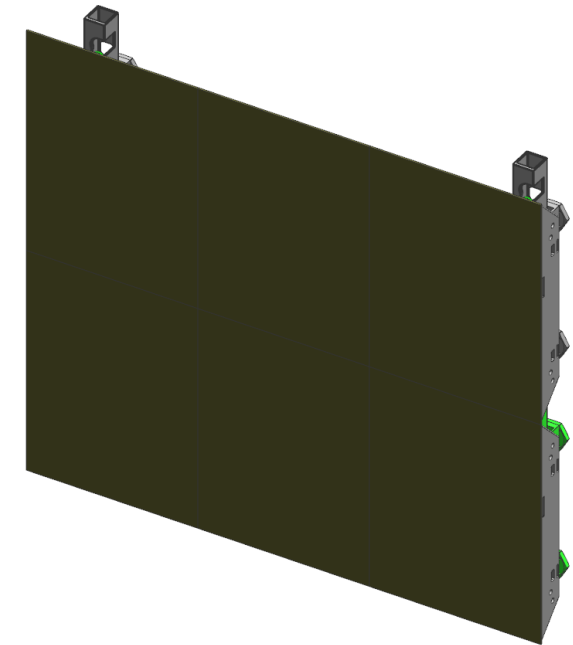

Fig 12. IER-F installed at the bottom of IER-F

4. Fastening the Cover PCB

- After IER + IER-F Cabinet installation, fasten the Cover PCB to the outermost edge to fix the Module.
- You can fasten two Cover PCBs on the horizontal side and a Cover PCB on the vertical side based on a module.
- IER-Fs have different Cover PCBs on the horizontal and vertical sides, and the horizontal Cover PCB can be used together with IER.

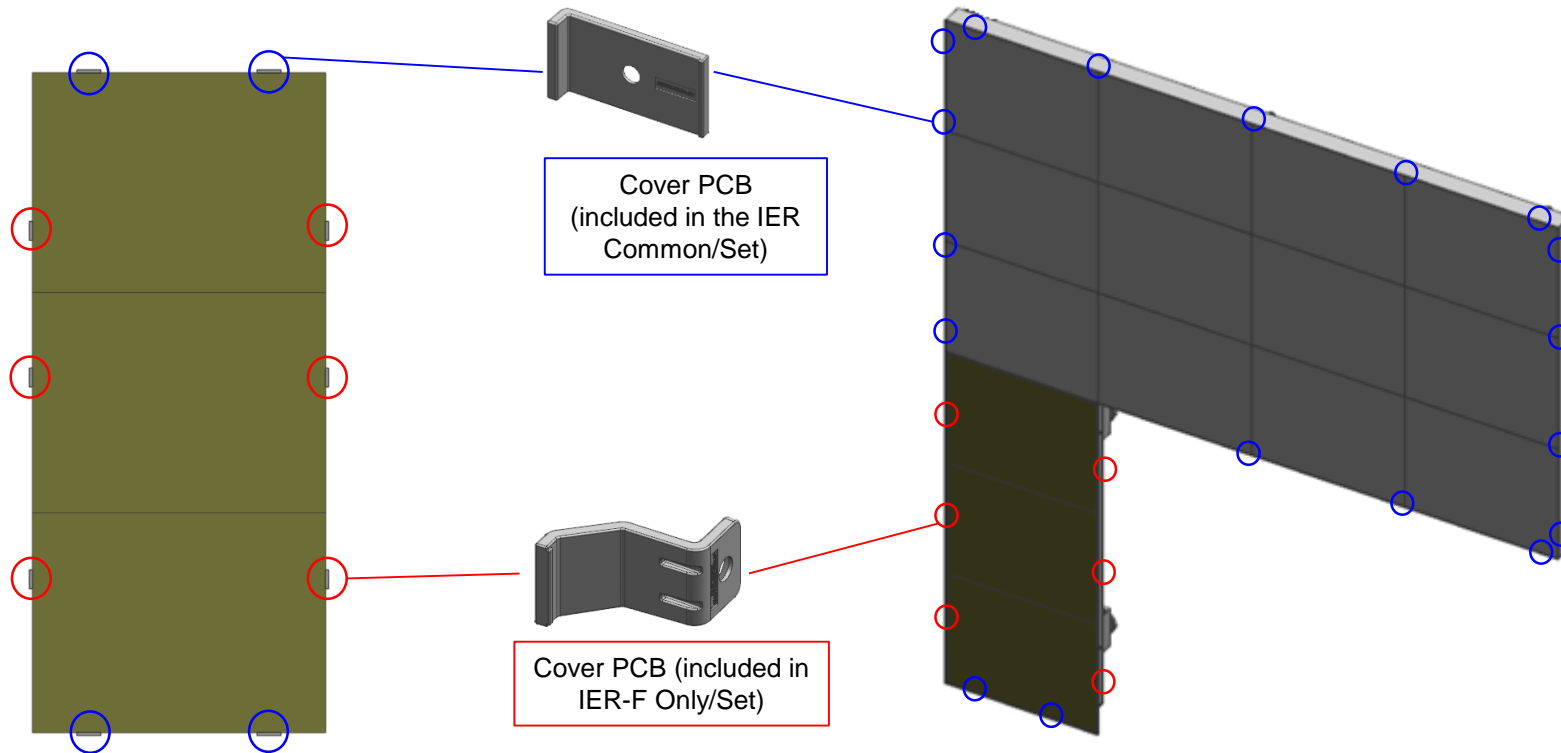

Fig 1. Cover PCB for each IER-F Position

Fig 2. Cover PCB Fastening Positions Example for IER+IER-F Installation