

User Guide

© Copyright 2014 Hewlett-Packard Development Company, L.P.

AMD is a registered trademark of Advanced Micro Devices, Inc. in the U.S. and other countries. Bluetooth is a trademark owned by its proprietor and used by Hewlett-Packard Company under license. Intel and Centrino are trademarks of Intel Corporation in the U.S. and other countries. SD logo is a trademark of its proprietor. Java is a U.S. trademark of Sun Microsystems, Inc. Microsoft and Windows are U.S. registered trademarks of the Microsoft group of companies.

The information contained herein is subject to change without notice. The only warranties for HP products and services are set forth in the express warranty statements accompanying such products and services. Nothing herein should be construed as constituting an additional warranty. HP shall not be liable for technical or editorial errors or omissions contained herein.

First Edition: June 2014

Document Part Number: 768564-001

Product notice

This user guide describes features that are common to most models. Some features may not be available on your computer.

Not all features are available in all editions of Windows. This computer may require upgraded and/or separately purchased hardware, drivers and/or software to take full advantage of Windows functionality. Go to <http://www.microsoft.com> for details.

To access the latest user guide, go to <http://www.hp.com/support>, and select your country. Select **Drivers & Downloads**, and then follow the on-screen instructions.

Software terms

By installing, copying, downloading, or otherwise using any software product preinstalled on this computer, you agree to be bound by the terms of the HP End User License Agreement (EULA). If you do not accept these license terms, your sole remedy is to return the entire unused product (hardware and software) within 14 days for a full refund subject to the refund policy of your seller.

For any further information or to request a full refund of the price of the computer, please contact your seller.

Safety warning notice

 **WARNING!** To reduce the possibility of heat-related injuries or of overheating the computer, do not place the computer directly on your lap or obstruct the computer air vents. Use the computer only on a hard, flat surface. Do not allow another hard surface, such as an adjoining optional printer, or a soft surface, such as pillows or rugs or clothing, to block airflow. Also, do not allow the AC adapter to contact the skin or a soft surface, such as pillows or rugs or clothing, during operation. The computer and the AC adapter comply with the user-accessible surface temperature limits defined by the International Standard for Safety of Information Technology Equipment (IEC 60950).

Table of contents

1 Welcome	1
Finding information	2
2 Getting to know your computer	5
Right	5
Left	7
Display	9
Top	10
TouchPad	10
Lights	11
Buttons, speakers, and fingerprint reader (select models only)	12
Keys	14
Bottom	15
Front	17
Rear	18
3 Connecting to a network	19
Connecting to a wireless network	19
Using the wireless controls	19
Using the wireless button	19
Using operating system controls	20
Using a WLAN	20
Using an Internet service provider	20
Setting up a WLAN	21
Configuring a wireless router	21
Protecting your WLAN	21
Connecting to a WLAN	22
Using HP Mobile Broadband (select models only)	22
Inserting and removing a SIM	23
Using GPS (select models only)	24
Using Bluetooth wireless devices	24

Connecting to a wired network	25
Connecting to a local area network (LAN)	25
4 Navigating using the keyboard, touch gestures and pointing devices	27
Using pointing devices	27
Setting pointing device preferences	27
Using the pointing stick	27
Using the TouchPad and gestures	27
Turning the TouchPad off and on	28
Tapping	28
Scrolling	29
2-finger pinch zoom	29
2-finger click	30
Rotating (select models only)	30
Flicking (select models only)	30
Edge swipes (select models only)	31
Right-edge swipe	31
Left-edge swipe	32
Top-edge swipe	32
Using the keyboard	33
Using Windows shortcut keys	33
Identifying the hot keys	33
Using keypads	34
Using the integrated numeric keypad	34
Using an optional external numeric keypad	34
5 Multimedia	35
Using the media activity controls	35
Audio	35
Connecting speakers	35
Adjusting the volume	35
Connecting headphones	36
Connecting a microphone	36
Connecting headphones and microphones	36
Checking audio functions on the computer	36
Webcam (select models only)	37
Video	37
VGA	38
DisplayPort (select models only)	38
Connecting a Thunderbolt DisplayPort device	39
Connecting wired displays using MultiStream Transport	40

Connecting wired displays with an optional hub	40
Connecting wireless displays (Miracast-compatible wireless displays only)	41
6 Power management	43
Shutting down (turning off) the computer	43
Setting power options	44
Using power-saving states	44
Initiating and exiting Sleep	44
Enabling and exiting user-initiated Hibernation	44
Using the power meter and power settings	45
Setting password protection on wakeup	45
Using battery power	45
Finding additional battery information	45
Using Battery Check	47
Displaying the remaining battery charge	47
Maximizing battery discharge time	47
Managing low battery levels	47
Identifying low battery levels	47
Resolving a low battery level	48
Inserting or removing the battery	48
Inserting a battery	48
Removing a battery	48
Conserving battery power	49
Storing a user-replaceable battery (select models only)	49
Disposing of a user-replaceable battery (select models only)	49
Replacing a user-replaceable battery (select models only)	50
Using external AC power	50
Testing an AC adapter	50
Hybrid Graphics and AMD Dual Graphics (select models only)	51
Using Hybrid Graphics (select models only)	51
Using AMD Dual Graphics (select models only)	51
7 External cards and devices	53
Using memory card readers (select models only)	53
Inserting a memory card	53
Removing a memory card	53
Using ExpressCards (select models only)	54
Configuring an ExpressCard	54
Inserting an ExpressCard	54
Removing an ExpressCard	56
Using smart cards (select models only)	56



Inserting a smart card	56
Removing a smart card	57
Using a USB device	57
Connecting a USB device	58
Removing a USB device	58
Using optional external devices	58
Using optional external drives	59
Using the docking connector (select models only)	59
8 Drives	61
Handling drives	61
Using hard drives	62
Removing or replacing the service door	62
Removing the service door	62
Replacing the service door	62
Replacing or upgrading the hard drive	63
Removing the hard drive	63
Installing a hard drive	64
Improving hard drive performance	65
Using Disk Defragmenter	65
Using Disk Cleanup	66
Using HP 3D DriveGuard (select models only)	66
Identifying HP 3D DriveGuard status	66
Using RAID (select models only)	66
9 Security	69
Protecting the computer	69
Using passwords	70
Setting passwords in Windows	70
Setting passwords in Computer Setup	71
Managing a BIOS administrator password	71
Entering a BIOS administrator password	72
Managing a Computer Setup DriveLock password	72
Setting a DriveLock password	73
Entering a DriveLock password	74
Changing a DriveLock password	74
Removing DriveLock protection	74
Using Computer Setup Automatic DriveLock	75
Entering an Automatic DriveLock password	75
Removing Automatic DriveLock protection	76
TPM Embedded Security device (select models only)	76

Using antivirus software	77
Using firewall software	77
Installing critical security updates	78
Using HP Client Security	78
Installing an optional security cable	78
Using the fingerprint reader (select models only)	79
Locating the fingerprint reader	79
10 Maintenance	81
Adding or replacing memory modules	81
Cleaning your computer	83
Cleaning procedures	84
Cleaning the display (All-in-Ones or Notebooks)	84
Cleaning the sides or cover	84
Cleaning the TouchPad, keyboard, or mouse	84
Updating programs and drivers	85
Using SoftPaq Download Manager	85
11 Backup and recovery	87
Backing up your information	87
Performing a system recovery	87
Using the Windows recovery tools	88
Using f11 recovery tools	88
Using Windows operating system media (purchased separately)	89
Using Windows Refresh or Windows Reset	90
Using HP Software Setup	90
12 Computer Setup (BIOS), MultiBoot, and HP PC Hardware Diagnostics (UEFI)	91
Using Computer Setup	91
Starting Computer Setup	91
Navigating and selecting in Computer Setup	91
Restoring factory settings in Computer Setup	92
Updating the BIOS	93
Determining the BIOS version	93
Downloading a BIOS update	93
Using MultiBoot	94
About the boot device order	94
Choosing MultiBoot preferences	94
Setting a new boot order in Computer Setup	95
Dynamically choosing a boot device using the f9 prompt	95

Setting a MultiBoot Express prompt	95
Entering MultiBoot Express preferences	96
Using HP PC Hardware Diagnostics (UEFI)	96
Downloading HP PC Hardware Diagnostics (UEFI) to a USB device	97
Using HP Sure Start	98
13 Support	99
Contacting support	99
Labels	100
14 Specifications	101
Input power	101
Operating environment	102
Appendix A Traveling with the computer	103
Appendix B Troubleshooting	105
Troubleshooting resources	105
Resolving issues	105
The computer is unable to start up	105
The computer screen is blank	106
Software is functioning abnormally	106
The computer is on but not responding	106
The computer is unusually warm	106
An external device is not working	107
The wireless network connection is not working	107
A disc does not play	107
A movie is not visible on an external display	108
The process of burning a disc does not begin, or it stops before completion	108
Appendix C Electrostatic discharge	109
Index	111

1 Welcome

After you set up and register the computer, we recommend the following steps to get the most out of your smart investment:

-  **TIP:** To quickly return to the computer Start screen from an open app or the Windows desktop, press the Windows key  on your keyboard. Pressing the Windows key again will return you to the previous screen.
- **Connect to the Internet**—Set up your wired or wireless network so that you can connect to the Internet. For more information, see [Connecting to a network on page 19](#).
- **Update your antivirus software**—Protect your computer from damage caused by viruses. The software is preinstalled on the computer. For more information, see [Using antivirus software on page 77](#).
- **Get to know your computer**—Learn about your computer features. See [Getting to know your computer on page 5](#) and [Navigating using the keyboard, touch gestures and pointing devices on page 27](#) for additional information.
- **Find installed software**—Access a list of the software preinstalled on the computer:

From the Start screen, type **a**, click **Apps**, and then select from the displayed options. For details about using the software included with the computer, see the software manufacturer's instructions, which may be provided with the software or on the manufacturer's website.
- **Create powerful presentations**—You can connect to a projector to share your ideas with a group. See [Connecting a Thunderbolt DisplayPort device on page 39](#).
- Back up your hard drive by creating recovery discs or a recovery flash drive. See [Backup and recovery on page 87](#).

Finding information

You have already used *Setup Instructions* to turn on the computer and locate this guide. To locate resources that provide product details, how-to information, and more, use this table.



Resources	For information about
<i>Setup Instructions</i> poster	<ul style="list-style-type: none">• How to set up the computer• Help to identify computer components
HP Support Assistant To access HP Support Assistant, from the Start screen, select the HP Support Assistant app. To access the latest user guide, go to http://www.hp.com/support , and select your country. Select Drivers & Downloads , and then follow the on-screen instructions.	<ul style="list-style-type: none">• Operating system information• Software, driver, and BIOS updates• Troubleshooting tools• How to access support
Worldwide support To get support in your language, go to http://welcome.hp.com/country/us/en/wwcontact_us.html .	<ul style="list-style-type: none">• Online chat with an HP technician• Support telephone numbers• HP service center locations
HP website To access the latest user guide, go to http://www.hp.com/support , and select your country. Select Drivers & Downloads , and then follow the on-screen instructions.	<ul style="list-style-type: none">• Support information• Ordering parts and finding additional help• Accessories available for the device
<i>Safety & Comfort Guide</i> To access this guide: ▲ From the Start screen, type <code>support</code> , and then select the HP Support Assistant app. – or – Go to http://www.hp.com/ergo .	<ul style="list-style-type: none">• Proper workstation setup, posture, health, and work habits• Electrical and mechanical safety information
<i>Regulatory, Safety, and Environmental Notices</i> To access this guide: 1. From the Start screen, type <code>support</code> , and then select the HP Support Assistant app. 2. Select My computer , and then select User guides .	<ul style="list-style-type: none">• Regulatory and safety information• Battery disposal information

Resources	For information about
<i>Limited Warranty*</i>	Warranty information
To access this guide, from the Start screen, select the HP Support Assistant app, select My computer , and then select Warranty and services .	
– or –	
Go to http://www.hp.com/go/orderdocuments .	
*You can find the expressly provided HP Limited Warranty applicable to your product located with the user guides on your computer and/or on the CD/DVD provided in the box. In some countries/regions, HP may provide a printed HP Limited Warranty in the box. For some countries/regions where the warranty is not provided in printed format, you may request a printed copy from http://www.hp.com/go/orderdocuments or write to:	
<ul style="list-style-type: none">● North America: Hewlett-Packard, MS POD, 11311 Chinden Blvd., Boise, ID 83714, USA● Europe, Middle East, Africa: Hewlett-Packard, POD, Via G. Di Vittorio, 9, 20063, Cernusco s/Naviglio (MI), Italy● Asia Pacific: Hewlett-Packard, POD, P.O. Box 200, Alexandra Post Office, Singapore 911507	
When you request a printed copy of your warranty, please include your product number, warranty period (found on your service label), name, and postal address.	
IMPORTANT: Do NOT return your HP product to the addresses above. For U.S. support, go to http://www.hp.com/go/contactHP . For worldwide support, go to http://welcome.hp.com/country/us/en/wwcontact_us.html .	

2 Getting to know your computer

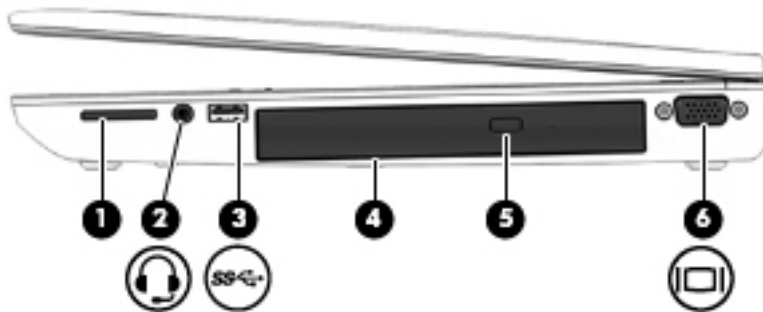
Right



Component	Description
(1)	Memory card reader
(2) 	Audio-out (headphone)/Audio-in (microphone) jack
(3) 	USB 3.0 port

Reads optional memory cards that store, manage, share, or access information.

Connects optional powered stereo speakers, headphones, earbuds, a headset, or a television audio cable. Also connects an optional headset microphone. This jack does not support optional microphone-only devices.

WARNING! To reduce the risk of personal injury, adjust the volume before putting on headphones, earbuds, or a headset. For additional safety information, see the *Regulatory, Safety, and Environmental Notices*. To access this guide, from the Start screen, type `support`, and then select the **HP Support Assistant** app.

NOTE: When a device is connected to the jack, the computer speakers are disabled.

NOTE: Be sure that the device cable has a 4-conductor connector that supports both audio-out (headphone) and audio-in (microphone).





Connects an optional USB device, such as a keyboard, mouse, external drive, printer, scanner, or USB hub.

For details about different types of USB ports, see [Using a USB device on page 57](#).

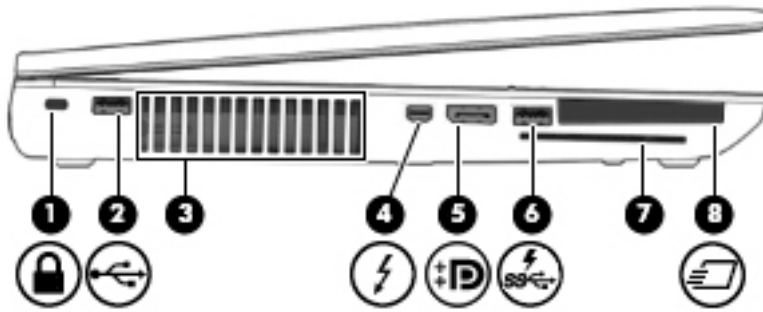
Component	Description
(4) Upgrade bay (optical drive shown) (select models only)	<p>Depending on your computer model, reads an optical disc or reads and writes to an optical disc.</p> <p>NOTE: For disc compatibility information, navigate to the Help and Support web page (see Finding information on page 2). Follow the web page instructions to select your computer model. Select Support & Drivers, and then select Product Information.</p> <p>NOTE: The upgrade bay can hold either a hard drive or an optical drive that reads and writes (select models only) to an optical disc. It can also hold a weight saver option.</p>
(5) Optical drive eject button (select models only)	Releases the optical drive disc tray.
(6)  External monitor port	Connects an external VGA monitor or projector.

Left



Component	Description
(1)  Security cable slot	Attaches an optional security cable to the computer. NOTE: The security cable is designed to act as a deterrent, but it may not prevent the computer from being mishandled or stolen.
(2)  USB 2.0 port	Connects an optional USB device, such as a keyboard, mouse, external drive, printer, scanner or USB hub. For details about different types of USB ports, see Using a USB device on page 57 .
(3) Vent	Enables airflow to cool internal components. NOTE: The computer fan starts up automatically to cool internal components and prevent overheating. It is normal for the internal fan to cycle on and off during routine operation.
(4)  Thunderbolt DisplayPort	Connects an optional high-resolution display device or a high-performance data device. NOTE: Thunderbolt is new technology. Install all the latest drivers for your Thunderbolt device before connecting the device to the Thunderbolt DisplayPort. Thunderbolt cable and Thunderbolt device (sold separately) must be compatible with Windows. To determine whether your device is Thunderbolt Certified for Windows, go to https://thunderbolttechnology.net/products .
(5)  Dual-Mode DisplayPort	Connects an optional digital display device, such as a high-performance monitor or projector.
(6)  USB 3.0 charging (powered) port	Connects an optional USB device, such as a keyboard, mouse, external drive, printer, scanner or USB hub. Standard USB ports will not charge all USB devices or will charge using a low current. Some USB devices require power and require you to use a powered port. NOTE: USB charging ports can also charge select models of cell phones and MP3 players, even when the computer is off. For details about different types of USB ports, see Using a USB device on page 57 .

Component	Description
(7) Smart card reader	Supports optional smart cards.
(8)  ExpressCard slot or smart card reader (depending on the configuration)	Supports optional ExpressCards or smart cards.

Display

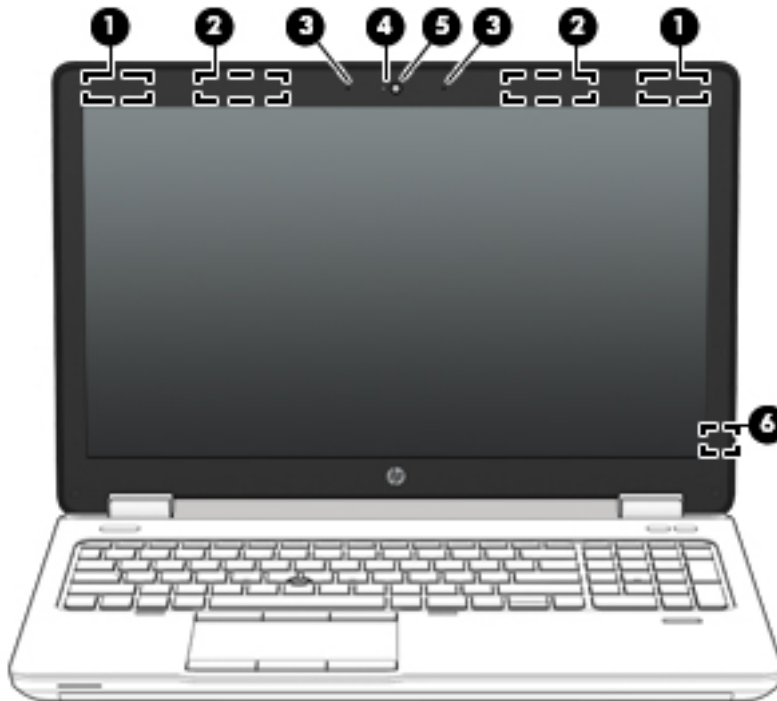

Component	Description
(1) WLAN antennas*	Send and receive wireless signals to communicate with wireless local area networks (WLAN).
(2) WWAN antennas* (select models only)	Send and receive wireless signals to communicate with wireless wide area networks (WWAN).
(3) Internal microphones	Record sound.
(4) Webcam light (select models only)	On: The webcam is in use.
(5) Webcam (select models only)	Records video and captures photographs. Some models allow you to video conference and chat online using streaming video. For information on using the webcam, access HP Support Assistant. To access HP Support Assistant, from the Start screen, select the HP Support Assistant app.
(6) Internal display switch	Turns off the display or initiates Sleep if the display is closed while the power is on. NOTE: The display switch is not visible from the outside of the computer.

*The antennas are not visible from the outside of the computer. For optimal transmission, keep the areas immediately around the antennas free from obstructions. For wireless regulatory notices, see the section of the *Regulatory, Safety, and Environmental Notices* that applies to your country or region. To access this guide, from the Start screen, type `support`, and then select the **HP Support Assistant** app.

Top

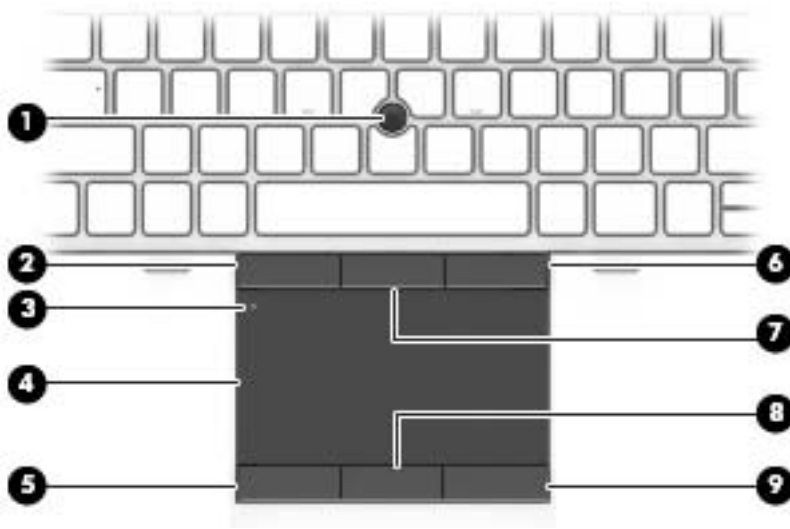

TouchPad



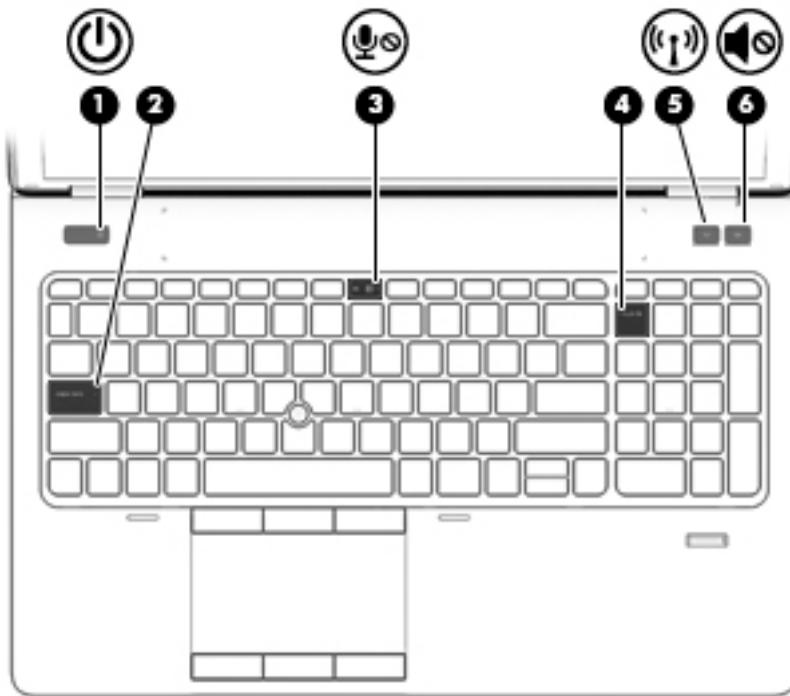

Component	Description
(1) Pointing stick	Moves the pointer and selects or activates items on the screen.
(2) Left pointing stick button	Functions like the left button on an external mouse.
(3) TouchPad on/off button	Turns the TouchPad on and off.
(4) TouchPad zone	Reads your finger gestures to move the pointer or activate items on the screen. NOTE: The TouchPad also supports edge-swipe gestures. For more information, see Edge swipes (select models only) on page 31 .
(5) Left TouchPad button	Functions like the left button on an external mouse.
(6) Right pointing stick button	Functions like the right button on an external mouse.
(7) Center pointing stick button	Functions like the center button on an external mouse.
(8) Center TouchPad button	Functions like the center button on an external mouse.
(9) Right TouchPad button	Functions like the right button on an external mouse.

Lights





Component	Description
(1)  Power light	<ul style="list-style-type: none"> On: The computer is on. Blinking: The computer is in the Sleep state, a power-saving state. The computer shuts off power to the display and other unneeded components. Off: The computer is off or in Hibernation. Hibernation is a power-saving state that uses the least amount of power. <p>NOTE: For select models, the Intel® Rapid Start Technology feature is enabled at the factory. Rapid Start Technology allows your computer to resume quickly from inactivity. For more information, see Using power-saving states on page 44.</p>
(2) Caps lock light	On: Caps lock is on, which switches the keys to all capital letters.
(3)  Microphone mute light	<ul style="list-style-type: none"> Amber: microphone sound is off. Off: microphone sound is on.
(4) Num lock light	On: Num lock is on.

Component	Description
(5)  Wireless light	<p>On: An integrated wireless device, such as a wireless local area network (WLAN) device and/or a Bluetooth® device, is on.</p> <p>NOTE: On some models, the wireless light is amber when all wireless devices are off.</p>
(6)  Mute light	<ul style="list-style-type: none"> • Amber: Computer sound is off. • Off: Computer sound is on.

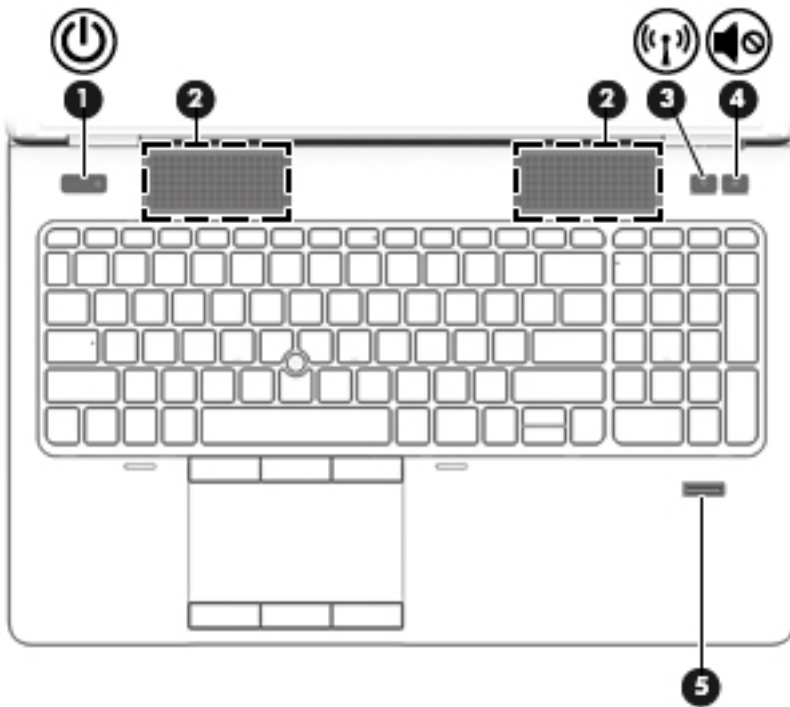
Buttons, speakers, and fingerprint reader (select models only)



Component	Description
(1)  Power button	<ul style="list-style-type: none"> • When the computer is off, press the button to turn on the computer. • When the computer is on, press the button briefly to initiate Sleep. • When the computer is in the Sleep state, press the button briefly to exit Sleep. • When the computer is in Hibernation, press the button briefly to exit Hibernation. <p>CAUTION: Pressing and holding down the power button will result in the loss of unsaved information.</p> <p>If the computer has stopped responding and Windows® shutdown procedures are ineffective, press and hold the power button for at least 5 seconds to turn off the computer.</p> <p>NOTE: For select models, the Intel® Rapid Start Technology feature is enabled at the factory. Rapid Start Technology allows your computer to resume quickly from inactivity. For more information, see Using power-saving states on page 44.</p> <p>To learn more about your power settings, see your power options. From the Start screen, type <code>power</code>, select Power and sleep settings, and then select Power and sleep from the list of applications.</p>
(2) Speakers	Produce sound.
(3)  Wireless button	Turns the wireless feature on or off but does not establish a wireless connection.
(4)  Volume mute button	Mutes and restores speaker sound.
(5) Fingerprint reader (select models only)	Allows a fingerprint logon to Windows, instead of a password logon.



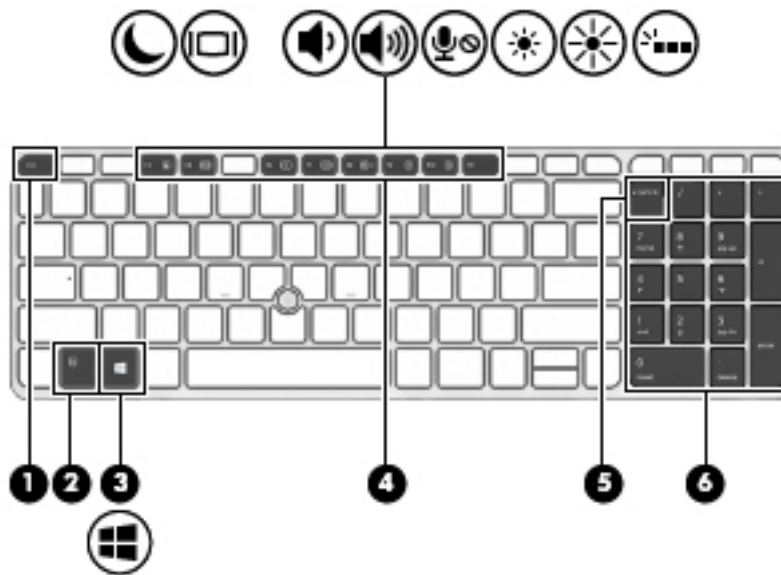

Keys

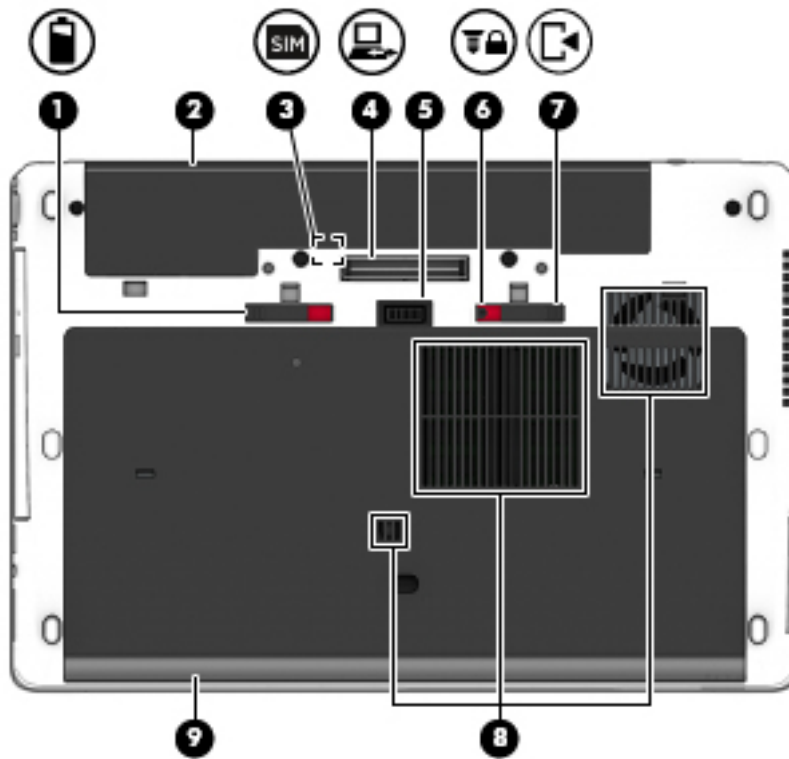

Component	Description
(1) esc key	Displays system information when pressed in combination with the fn key.
(2) fn key	Executes frequently used system functions when pressed in combination with a function key, the num lock key, the esc key, or the b key.
(3)  Windows key	Returns you to the Start screen from an open app or the Windows desktop. NOTE: Pressing the Windows key again will return you to the previous screen.
(4) Function keys	Execute frequently used system functions when pressed in combination with the fn key.
(5) num lock key	Alternates between the navigational and numeric functions on the integrated numeric keypad.
(6) Integrated numeric keypad	When num lock has been enabled, it can be used like an external numeric keypad.

Bottom





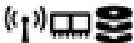

Component	Description
(1) 	Battery release latch Releases the battery.
(2)	Battery bay Holds the battery.
(3) 	SIM slot Supports a wireless subscriber identity module (SIM). The SIM slot is located inside the battery bay.
(4) 	Docking connector Connects an optional docking device.
(5)	Accessory battery connector Connects an optional accessory battery.
(6) 	Service door release lock Locks the service door.
(7) 	Service door release latch Releases the service door.

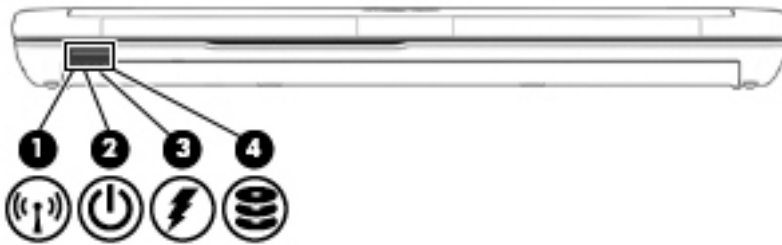
Component	Description
(8) Vents (3)	Enable airflow to cool internal components. NOTE: The computer fan starts up automatically to cool internal components and prevent overheating. It is normal for the internal fan to cycle on and off during routine operation.
(9)  Service door	Provides access to the hard drive bay, the wireless LAN (WLAN) module slot, the WWAN module slot, and the memory module slots. CAUTION: To prevent an unresponsive system, replace the wireless module only with a wireless module authorized for use in the computer by the governmental agency that regulates wireless devices in your country or region. If you replace the module and then receive a warning message, remove the module to restore computer functionality, and then contact support through HP Support Assistant. To access HP Support Assistant, from the Start screen, select the HP Support Assistant app.





Front



Component	Description
(1)  Wireless light	<p>On: An integrated wireless device, such as a wireless local area network (WLAN) device and/or a Bluetooth® device, is on.</p> <p>NOTE: On some models, the wireless light is amber when all wireless devices are off.</p>
(2)  Power light	<ul style="list-style-type: none"> On: The computer is on. Blinking: The computer is in the Sleep state, a power-saving state. The computer shuts off power to the display and other unneeded components. Off: The computer is off or in Hibernation. Hibernation is a power-saving state that uses the least amount of power. <p>NOTE: For select models, the Intel® Rapid Start Technology feature is enabled at the factory. Rapid Start Technology allows your computer to resume quickly from inactivity. For more information, see Using power-saving states on page 44.</p>
(3)  AC adapter/Battery light	<ul style="list-style-type: none"> White: The computer is connected to external power and the battery is charged from 90 to 99 percent. Amber: The computer is connected to external power and the battery is charged from 0 to 90 percent. Blinking amber: A battery that is the only available power source has reached a low battery level. When the battery reaches a critical battery level, the battery light begins blinking rapidly. Off: The battery is fully charged.
(4)  Hard drive/optical drive light	<ul style="list-style-type: none"> Blinking white: The hard drive or optical drive is being accessed. Amber: HP 3D DriveGuard has temporarily parked the hard drive. <p>NOTE: For more information about HP 3D DriveGuard, see Using HP 3D DriveGuard (select models only) on page 66.</p>

Rear



Component		Description
(1)	 USB 3.0 port	Connects an optional USB device, such as a keyboard, mouse, external drive, printer, scanner or USB hub. For details about different types of USB ports, see Using a USB device on page 57 .
(2)	 Power connector	Connects an AC adapter.
(3)	 AC adapter/battery light	<ul style="list-style-type: none"> • White: The computer is connected to external power and the battery is charged from 90 to 99 percent. • Amber: The computer is connected to external power and the battery is charged from 0 to 90 percent. • Blinking amber: A battery that is the only available power source has reached a low battery level. When the battery reaches a critical battery level, the battery light begins blinking rapidly. • Off: The battery is fully charged.
(4)	 RJ-45 (network) jack/lights	Connects a network cable. <ul style="list-style-type: none"> • Green (left): The network is connected. • Amber (right): Activity is occurring on the network.

3 Connecting to a network

Your computer can travel with you wherever you go. But even at home, you can explore the globe and access information from millions of websites using your computer and a wired or wireless network connection. This chapter will help you get connected to that world.

Connecting to a wireless network

Wireless technology transfers data across radio waves instead of wires. Your computer may be equipped with one or more of the following wireless devices:

- **Wireless local area network (WLAN) device**—Connects the computer to wireless local area networks (commonly referred to as Wi-Fi networks, wireless LANs, or WLANs) in corporate offices, your home, and public places such as airports, restaurants, coffee shops, hotels, and universities. In a WLAN, the mobile wireless device in your computer communicates with a wireless router or a wireless access point.
- **HP Mobile Broadband Module (select models only)**—A wireless wide area network (WWAN) device that gives you wireless connectivity over a much larger area. Mobile network operators install base stations (similar to cell phone towers) throughout large geographic areas, effectively providing coverage across entire states, regions, or even countries.
- **Bluetooth device**—Creates a personal area network (PAN) to connect to other Bluetooth-enabled devices such as computers, phones, printers, headsets, speakers, and cameras. In a PAN, each device communicates directly with other devices, and devices must be relatively close together—typically within 10 meters (approximately 33 feet) of each other.

For more information about wireless technology, see the information and website links provided in HP Support Assistant. To access HP Support Assistant, from the Start screen, select the **HP Support Assistant** app.

Using the wireless controls

You can control the wireless devices in your computer using one or more of these features:

- **Wireless button, wireless switch, wireless key, or airplane mode key** (referred to in this chapter as the wireless button) (select models only)
- **Operating system controls**

Using the wireless button

The computer has a wireless button, one or more wireless devices, and, on select models, one or two wireless lights. All the wireless devices on your computer are enabled at the factory, and if your computer has a wireless light, the wireless light is on (white) when you turn on the computer.

The wireless light indicates the overall power state of your wireless devices, not the status of individual devices. If the wireless light is white, at least one wireless device is on. If the wireless light is off, all wireless devices are off.

 **NOTE:** On some models, the wireless light is amber when all wireless devices are off.

Because the wireless devices are enabled at the factory, you can use the wireless button to turn on or turn off the wireless devices simultaneously.

Using operating system controls

The Network and Sharing Center allows you to set up a connection or network, connect to a network, and diagnose and repair network problems.

To use operating system controls:

1. From the Start screen, type `control panel`, and then select **Control Panel**.
2. Select **Network and Internet**, and then select **Network and Sharing Center**.

For more information, access HP Support Assistant. To access HP Support Assistant, from the Start screen, select the **HP Support Assistant** app.

Using a WLAN

With a WLAN device, you can access a wireless local area network (WLAN), which is composed of other computers and accessories that are linked by a wireless router or a wireless access point.

 **NOTE:** The terms *wireless router* and *wireless access point* are often used interchangeably.

- A large-scale WLAN, such as a corporate or public WLAN, typically uses wireless access points that can accommodate a large number of computers and accessories and can separate critical network functions.
- A home or small office WLAN typically uses a wireless router, which allows several wireless and wired computers to share an Internet connection, a printer, and files without requiring additional pieces of hardware or software.

To use the WLAN device in your computer, you must connect to a WLAN infrastructure (provided through a service provider or a public or corporate network).

Using an Internet service provider

When you are setting up Internet access in your home, you must establish an account with an Internet service provider (ISP). To purchase Internet service and a modem, contact a local ISP. The ISP will help set up the modem, install a network cable to connect your wireless computer to the modem, and test the Internet service.

 **NOTE:** Your ISP will give you a user ID and a password to use for Internet access. Record this information and store it in a safe place.

Setting up a WLAN

To set up a WLAN and connect to the Internet, you need the following equipment:

- A broadband modem (either DSL or cable) **(1)** and high-speed Internet service purchased from an Internet service provider
- A wireless router **(2)** (purchased separately)
- A wireless computer **(3)**

 **NOTE:** Some modems have a built-in wireless router. Check with your ISP to determine what type of modem you have.

The illustration below shows an example of a wireless network installation that is connected to the Internet.



As your network grows, additional wireless and wired computers can be connected to the network to access the Internet.

For help in setting up your WLAN, see the information provided by your router manufacturer or your ISP.

Configuring a wireless router

For help in configuring a wireless router, see the information provided by your router manufacturer or your ISP.

 **NOTE:** It is recommended that you initially connect your new wireless computer to the router by using the network cable provided with the router. When the computer successfully connects to the Internet, disconnect the cable, and access the Internet through your wireless network.

Protecting your WLAN

When you set up a WLAN or access an existing WLAN, always enable security features to protect your network from unauthorized access. WLANs in public areas (hotspots) like coffee shops and airports may not provide any security. If you are concerned about the security of your computer in a hotspot, limit your network activities to e-mail that is not confidential and basic Internet surfing.

Wireless radio signals travel outside the network, so other WLAN devices can pick up unprotected signals. Take the following precautions to protect your WLAN:

- Use a firewall.

A firewall checks both data and requests for data that are sent to your network, and discards any suspicious items. Firewalls are available in both software and hardware. Some networks use a combination of both types.

- Use wireless encryption.

Wireless encryption uses security settings to encrypt and decrypt data that is transmitted over the network. For more information, access HP Support Assistant. To access HP Support Assistant, from the Start screen, select the **HP Support Assistant** app.

Connecting to a WLAN

To connect to the WLAN, follow these steps:

1. Be sure that the WLAN device is on. If the device is on, the wireless light is on. If the wireless light is off, press the wireless button.

 **NOTE:** On some models, the wireless light is amber when all wireless devices are off.

2. From the Start screen, point to the far-right upper or lower corner of the screen to display the charms.
3. Select **Settings**, and then click the network status icon.
4. Select your WLAN from the list.
5. Click **Connect**.

If the WLAN is a security-enabled WLAN, you are prompted to enter a security code. Type the code, and then click **Sign in**.

 **NOTE:** If no WLANs are listed, you may be out of range of a wireless router or access point.

 **NOTE:** If you do not see the WLAN you want to connect to, from the Windows desktop, right-click the network status icon, and then select **Open Network and Sharing Center**. Click **Set up a new connection or network**. A list of options is displayed, allowing you to manually search for and connect to a network or to create a new network connection.

6. Follow the on-screen instructions to complete the connection.

After the connection is made, place the mouse pointer over the network status icon in the notification area, at the far right of the taskbar, to verify the name and status of the connection.

 **NOTE:** The functional range (how far your wireless signals travel) depends on WLAN implementation, router manufacturer, and interference from other electronic devices or structural barriers such as walls and floors.

Using HP Mobile Broadband (select models only)

HP Mobile Broadband enables your computer to use WWANs to access the Internet from more places and over larger areas than it can by using WLANs. Using HP Mobile Broadband requires a network service provider (called a *mobile network operator*), which in most cases is a cellular phone network operator. Coverage for HP Mobile Broadband is similar to cellular phone voice coverage.

When used with mobile network operator service, HP Mobile Broadband gives you the freedom to stay connected to the Internet, send e-mail, or connect to your corporate network whether you are on the road or outside the range of Wi-Fi hotspots.

HP supports the following technologies:

- HSPA (High Speed Packet Access), which provides access to networks based on the Global System for Mobile Communications (GSM) telecommunications standard.
- EV-DO (Evolution Data Optimized), which provides access to networks based on the code division multiple access (CDMA) telecommunications standard.
- LTE (Long Term Evolution), which provides access to networks supporting LTE technology.

You may need the HP Mobile Broadband Module serial number to activate mobile broadband service. The serial number is printed on a label inside the battery bay of your computer.

Some mobile network operators require the use of a SIM. A SIM contains basic information about you, such as a personal identification number (PIN), as well as network information. Some computers include a SIM that is preinstalled in the battery bay. If the SIM is not preinstalled, it may be provided in the HP Mobile Broadband information provided with your computer or the mobile network operator may provide it separately from the computer.

For information about inserting and removing the SIM, see [Inserting and removing a SIM on page 23](#) in this chapter.

For information about HP Mobile Broadband and how to activate this service with a preferred mobile network operator, see the HP Mobile Broadband information included with your computer.

Inserting and removing a SIM

 **CAUTION:** To prevent damage to the connectors, use minimal force when inserting a SIM.

To insert a SIM, follow these steps:

1. Turn off the computer by using the Shut down command.
2. Close the display.
3. Disconnect all external devices connected to the computer.
4. Unplug the power cord from the AC outlet.
5. Turn the computer upside down on a flat surface, with the battery bay toward you.
6. Remove the battery.

7. Insert the SIM into the SIM slot, and gently push the SIM into the slot until it is firmly seated.

 **NOTE:** The SIM in your computer may look slightly different from the illustration in this section.

 **NOTE:** See the image on the battery bay to determine which way the SIM card should be inserted into your computer.

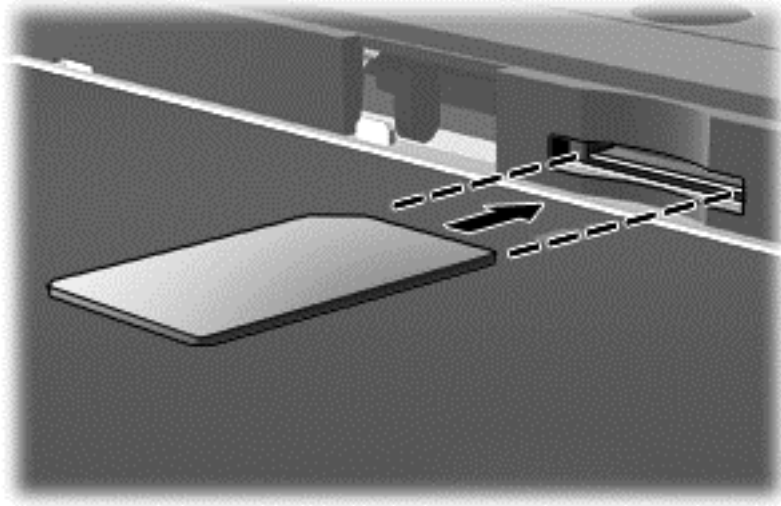

8. Replace the battery.

 **NOTE:** HP Mobile Broadband will be disabled if the battery is not replaced.

9. Reconnect external power.
10. Reconnect external devices.
11. Turn on the computer.

To remove a SIM, press in on the SIM, and then remove it from the slot.

Using GPS (select models only)

Your computer may be equipped with a Global Positioning System (GPS) device. GPS satellites deliver location, speed, and direction information to GPS-equipped systems.

For more information, see the HP GPS and Location software Help.

Using Bluetooth wireless devices

A Bluetooth device provides short-range wireless communications that replace the physical cable connections that traditionally link electronic devices such as the following:

- Computers (desktop, notebook, PDA)
- Phones (cellular, cordless, smart phone)
- Imaging devices (printer, camera)
- Audio devices (headset, speakers)
- Mouse

Bluetooth devices provide peer-to-peer capability that allows you to set up a personal area network (PAN) of Bluetooth devices. For information about configuring and using Bluetooth devices, see the Bluetooth software Help.

Connecting to a wired network

There are 2 kinds of wired connections: local area network (LAN) and modem connection. A LAN connection uses a network cable and is much faster than a modem, which uses a telephone cable. Both cables are sold separately.

⚠ WARNING! To reduce the risk of electric shock, fire, or damage to the equipment, do not plug a modem cable or telephone cable into an RJ-45 (network) jack.

Connecting to a local area network (LAN)

Use a LAN connection if you want to connect the computer directly to a router in your home (instead of working wirelessly), or if you want to connect to an existing network at your office.

Connecting to a LAN requires an 8-pin, RJ-45 network cable.

To connect the network cable, follow these steps:

1. Plug the network cable into the network jack **(1)** on the computer.
2. Plug the other end of the network cable into a network wall jack **(2)** or router.

📝 NOTE: If the network cable contains noise suppression circuitry **(3)**, which prevents interference from TV and radio reception, orient the circuitry end of the cable toward the computer.

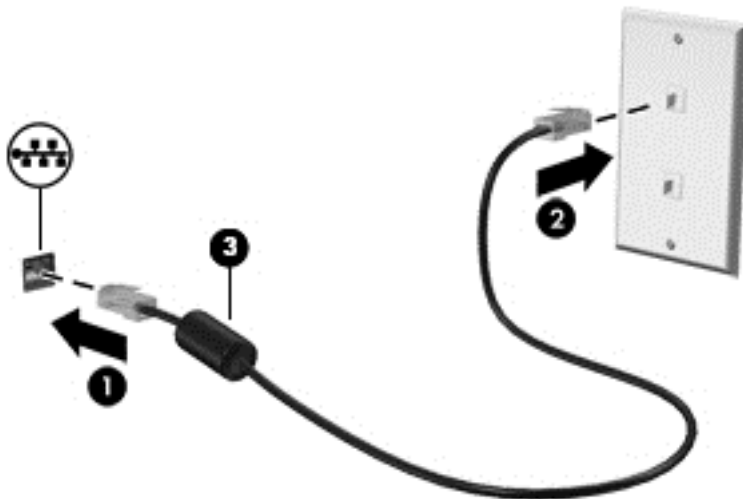

4 Navigating using the keyboard, touch gestures and pointing devices

Your computer allows navigation using touch gestures (select models only) in addition to the keyboard and mouse. Touch gestures can be used on your computer TouchPad or on a touch screen (select models only).

Select computer models have special action keys or hot key functions on the keyboard to perform routine tasks.

Using pointing devices

 **NOTE:** In addition to the pointing devices included with your computer, you can use an external USB mouse (purchased separately) by connecting it to one of the USB ports on the computer.

Setting pointing device preferences

Use Mouse Properties in Windows to customize settings for pointing devices, such as button configuration, click speed, and pointer options. You can also view demonstrations of TouchPad gestures.

To access Mouse Properties:

- From the Start screen, type `mouse`, click **Settings**, and then select **Mouse**.

Using the pointing stick

Press the pointing stick in the direction you want to move the pointer on the screen. Use the left and right pointing stick buttons as you would the left and right buttons on an external mouse.

Using the TouchPad and gestures

The TouchPad allows you to navigate the computer screen and control the pointer by using simple finger movements.

 **TIP:** Use the left and right buttons on the TouchPad as you would use the corresponding buttons on an external mouse.

 **NOTE:** TouchPad gestures are not supported in all apps.

Turning the TouchPad off and on

To turn the TouchPad off and on, quickly double-tap the TouchPad on/off button.

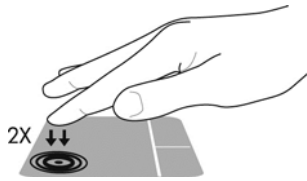

Tapping

To make an on-screen selection, use the Tap function on the TouchPad.

- Tap one finger on the TouchPad zone to make a selection. Double-tap an item to open it.



Scrolling

Scrolling is useful for moving up, down, or sideways on a page or image.

- Place two fingers slightly apart on the TouchPad zone and then drag them up, down, left, or right.

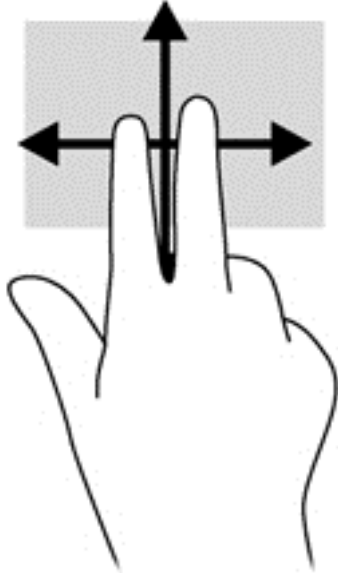

2-finger pinch zoom

2-finger pinch zoom allows you to zoom out or in on images or text.

- Zoom in by placing two fingers together on the TouchPad zone and then moving your fingers apart.
- Zoom out by placing two fingers apart on the TouchPad zone and then moving your fingers together.

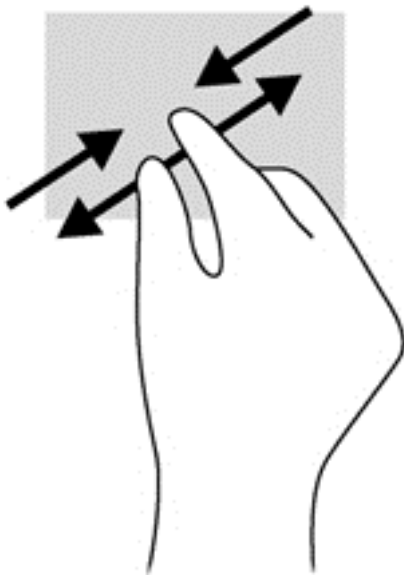

2-finger click

2-finger click allows you to make menu selections for an object on the screen.

 **NOTE:** Using 2-finger click is the same action as using right-click with the mouse.

- Place two fingers on the TouchPad zone and press to open the options menu for the selected object.



Rotating (select models only)

Rotating allows you to turn items such as photos.

- Anchor the forefinger of your left hand in the TouchPad zone. Using your right hand, slide your forefinger in a sweeping motion from 12 o'clock to 3 o'clock. To reverse the rotation, move your forefinger from 3 o'clock to 12 o'clock.

 **NOTE:** Rotating is intended for specific apps where you can manipulate an object or image. It may not be functional for all apps.

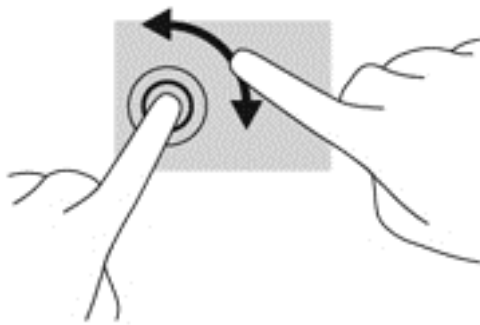

Flicking (select models only)

Flicking allows you to navigate through screens or quickly scroll through documents.

- Place three fingers on the TouchPad zone and flick your fingers in a light, quick motion up, down, left or right.

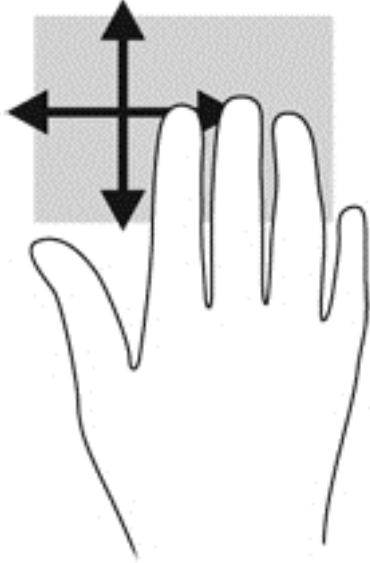

Edge swipes (select models only)

Edge swipes allow you to access toolbars on your computer for tasks such as changing settings and finding or using apps.

Right-edge swipe

The right-edge swipe reveals the charms, which let you search, share, start apps, access devices, or change settings.

- Swipe your finger gently from the right edge to reveal the charms.

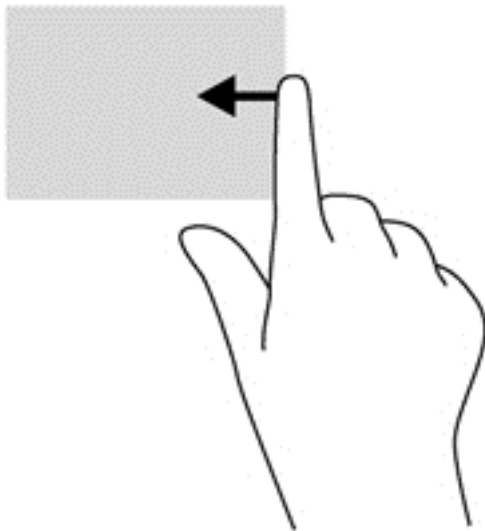

Left-edge swipe

The left-edge swipe accesses your recently opened apps so that you can switch between them quickly.

Swipe your finger gently from the left edge of the TouchPad to switch between recently opened apps.

- Swipe from the left edge of the TouchPad to switch between apps.

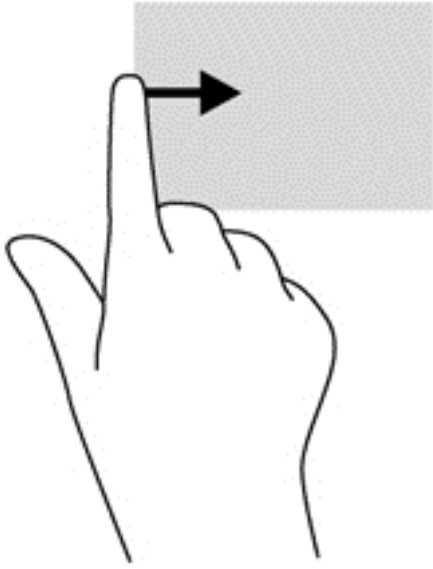

Top-edge swipe

The top-edge swipe displays app command options that allow you to customize apps.

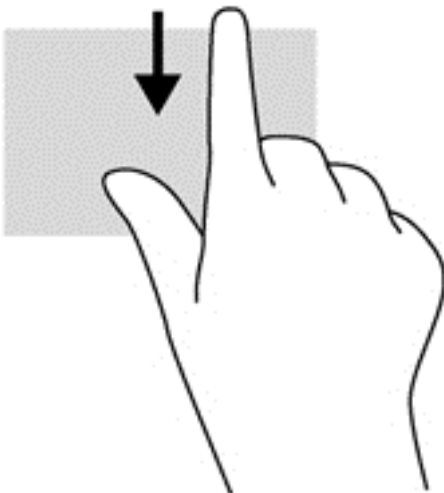

 **IMPORTANT:** When an app is open, the top-edge gesture varies depending on the app.

- Gently swipe your finger from the top edge to reveal the app command options.



Using the keyboard

The keyboard and mouse allow you to type select items, scroll and to perform the same functions as using touch gestures. The keyboard also allows you to use action keys and hot keys to perform specific functions.

 **TIP:** The Windows key  on the keyboard allows you to quickly return to the Start screen from an open app or the Windows desktop. Pressing the Windows key again will return you to the previous screen.

 **NOTE:** Depending on the country or region, your keyboard may have different keys and keyboard functions than those discussed in this section.

Using Windows shortcut keys







Windows provides shortcuts so that you can perform actions quickly. Press the Windows key  alone or in combination with a specific key to perform a designated action.



Identifying the hot keys

A hot key is a combination of the **fn** key and either the **esc** key or one of the function keys.

To use a hot key:

- ▲ Briefly press the **fn** key, and then briefly press the second key of the hot key combination.

Hot key combination	Description
 fn+esc	Displays system information.
 fn+f3	Initiates Sleep, which saves your information in system memory. The display and other system components turn off and power is conserved. To exit Sleep, briefly press the power button. CAUTION: To reduce the risk of information loss, save your work before initiating Sleep.
 fn+f4	Switches the screen image among display devices connected to the system. For example, if a monitor is connected to the computer, fn+f4 alternates the screen image from computer display to monitor display to simultaneous display on both the computer and the monitor. Most external monitors receive video information on the computer using the external VGA video standard. The fn+f4 hot key can also alternate images among other devices that are receiving video information on the computer.
 fn+ f6	Decreases speaker volume.
 fn+f7	Increases speaker volume.
 fn+f8	Mutes or restores microphone sound.
 fn+f9	Decreases the screen brightness level.

Hot key combination	Description
 fn+f10	Increases the screen brightness level.
 fn+f11	Turns the keyboard backlight on and off. (select models only)
	NOTE: The keyboard backlight is turned on at the factory. To extend battery life, turn off the keyboard backlight.

Using keypads

The computer includes an integrated numeric keypad, and it also supports an optional external numeric keypad, or an optional external keyboard that includes a numeric keypad.

Using the integrated numeric keypad

The computer includes an integrated numeric keypad, and it also supports an optional external numeric keypad or an optional external keyboard that includes a numeric keypad. For more details about the integrated numeric keypad, see [Keys on page 14](#).

Component	Description
(1) num lock key	Alternates between the navigational and numeric functions on the integrated numeric keypad. NOTE: The keypad function that is active when the computer is turned off is reinstated when the computer is turned back on.
(2) Integrated numeric keypad	When num lock has been enabled, it can be used like an external numeric keypad.

Using an optional external numeric keypad

Keys on most external numeric keypads function differently according to whether num lock is on or off. (Num lock is turned off at the factory.) For example:

- When num lock is on, most keypad keys type numbers.
- When num lock is off, most keypad keys function like the arrow, page up, or page down keys.

When num lock on an external keypad is turned on, the num lock light on the computer is turned on. When num lock on an external keypad is turned off, the num lock light on the computer is turned off.

To turn num lock on or off on an external keypad as you work:

- ▲ Press the **num lk** key on the external keypad, not on the computer.

5 Multimedia

Your computer may include the following:

- Integrated speaker(s)
- Integrated microphone(s)
- Integrated webcam (select models only)
- Preinstalled multimedia software
- Multimedia buttons or keys

Using the media activity controls

Depending on your computer model, you may have the following media activity controls that allow you to play, pause, fast forward, or rewind a media file:

- Media buttons
- Media hot keys (specific keys pressed in combination with the **fn** key)
- Media keys

Audio

On your computer, or on select models using an external optical drive, you can play music CDs, download and listen to music, stream audio content from the web (including radio), record audio, or mix audio and video to create multimedia. To enhance your listening enjoyment, attach external audio devices such as speakers or headphones.

Connecting speakers

You can attach wired speakers to your computer by connecting them to a USB port (or the audio-out jack) on your computer or on a docking station.

To connect wireless speakers to your computer, follow the device manufacturer's instructions. Before connecting audio devices, be sure to adjust the volume.

Adjusting the volume

Depending on your computer model, you can adjust the volume using the following:

- Volume buttons
- Volume hot keys (specific keys pressed in combination with the **fn** key)
- Volume keys

 **WARNING!** To reduce the risk of personal injury, adjust the volume before putting on headphones, earbuds, or a headset. For additional safety information, see the *Regulatory, Safety and Environmental Notices*. To access this guide, from the Start screen, type `support`, and then select the **HP Support Assistant** app.

 **NOTE:** Volume can also be controlled through the operating system and some programs.

 **NOTE:** See [Getting to know your computer on page 5](#) for information on what type of volume controls your computer has.

Connecting headphones

You can connect wired headphones to the headphone jack on your computer.

To connect wireless headphones to your computer, follow the device manufacturer's instructions.

 **WARNING!** To reduce the risk of personal injury, lower the volume setting before putting on headphones, earbuds, or a headset. For additional safety information, see the *Regulatory, Safety and Environmental Notices*.

Connecting a microphone

To record audio, connect a microphone to the microphone jack on the computer. For best results when recording, speak directly into the microphone and record sound in a setting free of background noise.

Connecting headphones and microphones

You can connect wired headphones or headsets to the audio-out (headphone)/audio-in (microphone) jack on your computer. Many headsets with integrated microphones are commercially available.

To connect *wireless* headphones or headsets to your computer, follow the device manufacturer's instructions.

 **WARNING!** To reduce the risk of personal injury, lower the volume setting before putting on headphones, earbuds, or a headset. For additional safety information, see the *Regulatory, Safety and Environmental Notices*. To access this guide, from the Start screen, type `support`, and then select the **HP Support Assistant** app.

Checking audio functions on the computer

 **NOTE:** For best results when recording, speak directly into the microphone and record sound in a setting free of background noise.

To check the audio functions on your computer, follow these steps:

1. From the Start screen, type `control panel`, and then select **Control Panel**.
2. Select **Hardware and Sound**, and then select **Sound**.
3. When the Sound window opens, select the **Sounds** tab. Under **Program Events**, select any sound event, such as a beep or alarm and then click **Test**.

You should hear sound through the speakers or through connected headphones.

To check the recording functions on your computer, follow these steps:

1. From the Start screen, type `sound`, and then select **Sound Recorder**.
2. Click **Start Recording** and speak into the microphone.
3. Save the file to your desktop.
4. Open a multimedia program and play the recording.

To confirm or change the audio settings on your computer:

1. From the Start screen, type `control panel`, and then select **Control Panel**.
2. Select **Hardware and Sound**, and then select **Sound**.

Webcam (select models only)

Some computers include an integrated webcam. With the preinstalled software, you can use the webcam to take a photo or record a video. You can preview and save the photo or video recording.

The webcam software enables you to experiment with the following features:

- Capturing and sharing video
- Streaming video with instant message software
- Taking still photos

Video

Your HP computer is a powerful video device that enables you to watch streaming video from your favorite websites and download video and movies to watch on your computer without needing to connect to a network.

To enhance your viewing enjoyment, use one of the video ports on the computer to connect an external monitor, projector, or TV. Your computer may have an high-definition multimedia interface (HDMI) port, which allows you to connect a high-definition monitor or TV.

Your computer has one or more of the following external video ports:

- VGA
- DisplayPort
- Thunderbolt

 **IMPORTANT:** Be sure that the external device is connected to the correct port on the computer, using the correct cable. Check the device manufacturer's instructions if you have questions.

 **NOTE:** See [Getting to know your computer on page 5](#) for information about your computer's video ports.

VGA

The external monitor port, or VGA port, is an analog display interface that connects an external VGA display device such as an external VGA monitor or a VGA projector to the computer.

1. Connect the VGA cable from the monitor or projector to the VGA port on the computer as shown.

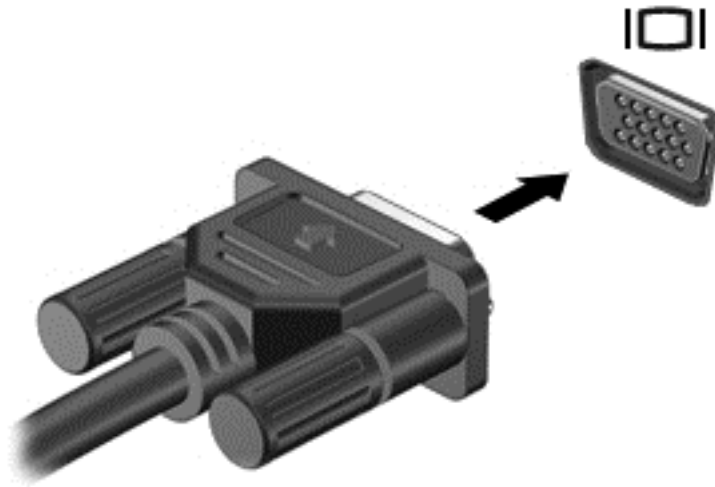

2. Press **fn+f4** to alternate the screen image between 4 display states:
 - **PC Screen only:** View the screen image on the computer only.
 - **Duplicate:** View the screen image simultaneously on both the computer and the external device.
 - **Extend:** View the screen image extended across both the computer and the external device.
 - **Second screen only:** View the screen image on the external device only.

Each time you press **fn+f4**, the display state changes.

 **NOTE:** For best results, especially if you choose the "Extend" option, adjust the screen resolution of the external device, as follows. From the Start screen, type `control panel`, and then select **Control Panel**. Select **Appearance and Personalization**. Under **Display**, select **Adjust screen resolution**.

DisplayPort (select models only)

The DisplayPort connects the computer to an optional video or audio device, such as a high-definition television, or to any compatible digital or audio component. The DisplayPort delivers higher performance than the VGA external monitor port and improves digital connectivity.

 **NOTE:** To transmit video and/or audio signals through the DisplayPort, you need a DisplayPort cable (purchased separately).

 **NOTE:** One DisplayPort device can be connected to the DisplayPort port on the computer. The information displayed on the computer screen can be simultaneously displayed on the DisplayPort device.

To connect a video or audio device to the DisplayPort:

1. Connect one end of the DisplayPort cable to the DisplayPort port on the computer.

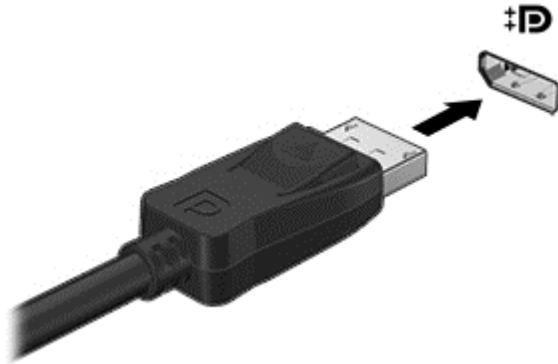

2. Connect the other end of the cable to the digital display device.
3. Press **fn+f4** to alternate the computer screen image between 4 display states:
 - **PC screen only:** View the screen image on the computer only.
 - **Duplicate:** View the screen image simultaneously on both the computer and the external device.
 - **Extend:** View the screen image extended across both the computer and the external device.
 - **Second screen only:** View the screen image on the external device only.

Each time you press **fn+f4**, the display state changes.

 **NOTE:** For best results, especially if you choose the “Extend” option, adjust the screen resolution of the external device, as follows. From the Start screen, type `control panel`, and then select **Control Panel**. Select **Appearance and Personalization**. Under **Display**, select **Adjust screen resolution**.

 **NOTE:** To remove the device cable, press down on the connector release button to disconnect it on the computer.

Connecting a Thunderbolt DisplayPort device

The Thunderbolt DisplayPort connects an optional high-resolution display device or a high-performance data device. This port delivers higher performance than the VGA external monitor port and improves digital connectivity.

 **NOTE:** Thunderbolt is new technology. Install all the latest drivers for your Thunderbolt device before connecting the device to the Thunderbolt DisplayPort. Thunderbolt cable and Thunderbolt device (sold separately) must be compatible with Windows. To determine whether your device is Thunderbolt Certified for Windows, go to <https://thunderbolttechnology.net/products>.

1. Connect one end of the Thunderbolt DisplayPort cable to the Thunderbolt DisplayPort on the computer.

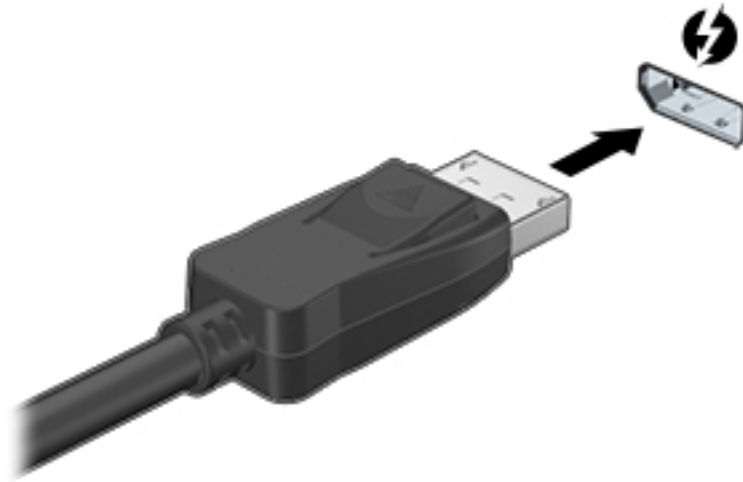

2. Connect the other end of the cable to the digital display device.
3. Press **fn+f4** to alternate the computer screen image between 4 display states.
 - **PC screen only:** View the screen image on the computer only.
 - **Duplicate:** View the screen image simultaneously on both the computer and external device.
 - **Extend:** View the screen image extended across both the computer and external device.
 - **Second screen only:** View the screen image on the external device only.

Each time you press **fn+f4** the display state changes.

 **NOTE:** Adjust the screen resolution of the external device, especially if you choose the “Extend” option. From the Start screen, type `control panel`, and then select **Control Panel** from the list of applications. Select **Appearance and Personalization**. Under **Display**, select **Adjust screen resolution**.

Connecting wired displays using MultiStream Transport

Connecting wired displays with an optional hub

MultiStream Transport (MST) provides multiple display support from a single connector, the DisplayPort, on your computer.

 **NOTE:** If your computer has an Nvidia graphics controller, you can connect up to 4 external display devices using the DisplayPort.

 **NOTE:** If your computer has an AMD graphics controller, you can connect up to 6 external display devices using the DisplayPort.

To set up multiple displays, follow these steps:

1. Connect an external hub (purchased separately) into the DisplayPort (DP) on your computer using a DP-to-DP cable (purchased separately). Be sure that the hub power adapter is connected to AC power.
2. Connect the external display devices to the VGA ports or DisplayPorts on the hub.
3. For details on how to set up multiple displays, go to the Nvidia Control Panel or from the Start screen type `screen resolution` in the search box, or press `fn+f4`. If you don't see one of your connected displays, be sure that each device is connected to the correct port on the hub.



NOTE: Multiple display choices include “Duplicate,” which mirrors your computer screen on all enabled displays, or “Extend,” which spans your computer screen across all enabled displays.

Connecting wireless displays (Miracast-compatible wireless displays only)

To discover and connect Miracast-compatible wireless displays without leaving your current apps, follow the steps below.

To open Miracast:

- ▲ Swipe from the right edge of the Start screen, tap **Devices**, tap **Project**, and then follow the on-screen instructions.

– or –

Point to the upper-right or lower-right corner of the Start screen to display the charms, click **Devices**, click **Project**, and then follow the on-screen instructions.

6 Power management

 **NOTE:** A computer may have a power button or a power switch. The term *power button* is used throughout this guide to mean both types of power controls.

Shutting down (turning off) the computer

 **CAUTION:** Unsaved information is lost when the computer shuts down.

The shutdown command closes all open programs, including the operating system, and then turns off the display and computer.

Shut down the computer under any of the following conditions:

- When you need to replace the battery or access components inside the computer
- When you are connecting an external hardware device that does not connect to a Universal Serial Bus (USB) port
- When the computer will be unused and disconnected from external power for an extended period

Although you can turn off the computer with the power button, the recommended procedure is to use the Windows shutdown command:

 **NOTE:** If the computer is in the Sleep state or in Hibernation, you must first exit Sleep or Hibernation before shutdown is possible by briefly pressing the power button.

1. Save your work and close all open programs.
2. From the Start screen, point to the upper-right or lower-right corner of the screen.
3. Click **Settings**, click the **Power** icon, and then click **Shut down**.

– or –

Right-click the Start button in the lower-left corner of the screen, select **Shut down or signout**, and then select **Shut down**.

If the computer is unresponsive and you are unable to use the preceding shutdown procedure, try the following emergency procedures in the sequence provided:

- Press **ctrl+alt+delete**. Click the **Power** icon, and then click **Shut Down**.
- Press and hold the power button for at least 5 seconds.

- Disconnect the computer from external power.
- On models with a user-replaceable battery, remove the battery.

Setting power options

Using power-saving states

Sleep is enabled at the factory.

When Sleep is initiated, the power lights blink and the screen clears. Your work is saved to memory.

 **CAUTION:** To reduce the risk of possible audio and video degradation, loss of audio or video playback functionality, or loss of information, do not initiate Sleep while reading from or writing to a disc or an external memory card.

 **NOTE:** You cannot initiate any type of networking connection or perform any computer functions while the computer is in the Sleep state.

Initiating and exiting Sleep

With the computer on, you can initiate Sleep in any of the following ways:

- Briefly press the power button.
- From the Start screen, point to the upper-right or lower-right corner of the screen. When the charms list opens, click **Settings**, click the **Power** icon, and then click **Sleep**.

To exit Sleep, briefly press the power button.

When the computer exits Sleep, the power lights turn on and the computer returns to the screen where you stopped working.

 **NOTE:** If you have set a password to be required on wakeup, you must enter your Windows password before the computer will return to the screen.

Enabling and exiting user-initiated Hibernation

You can enable user-initiated Hibernation and change other power settings and timeouts using Power Options:

1. From the Start screen, type `power options`, and then select **Power Options**.
2. In the left pane, click **Choose what the power button does**.
3. Click **Change Settings that are currently unavailable**.
4. In the **When I press the power button** area, select **Hibernate**.
5. Click **Save changes**.

To exit Hibernation, briefly press the power button. The power lights turn on and your work returns to the screen where you stopped working.

 **NOTE:** If you have set a password to be required on wakeup, you must enter your Windows password before your work will return to the screen.

Using the power meter and power settings

The power meter is located on the Windows desktop. The power meter allows you to quickly access power settings and view the remaining battery charge.

- To reveal the percentage of remaining battery charge and the current power plan, on the Windows desktop, point over the power meter icon.
- To use Power Options, or to change the power plan, click the power meter icon and select an item from the list. From the Start screen, you can also type `power options`, and then select **Power Options**.

Different power meter icons indicate whether the computer is running on battery or external power. The icon also reveals a message if the battery has reached a low or critical battery level.

Setting password protection on wakeup

To set the computer to prompt for a password when the computer exits Sleep or Hibernation, follow these steps:

1. From the Start screen, type `power options`, and then select **Power Options**.
2. In the left pane, click **Require a password on wakeup**.
3. Click **Change Settings that are currently unavailable**.
4. Click **Require a password (recommended)**.

 **NOTE:** If you need to create a user account password or change your current user account password, click **Create or change your user account password**, and then follow the on-screen instructions. If you do not need to create or change a user account password, go to step 5.

5. Click **Save changes**.

Using battery power

 **WARNING!** To reduce potential safety issues, use only the battery provided with the computer, a replacement battery provided by HP, or a compatible battery purchased from HP.

The computer runs on battery power whenever it is not plugged into external AC power. Computer battery life varies, depending on power management settings, running programs, display brightness, external devices connected to the computer, and other factors. Keeping the battery in the computer whenever the computer is plugged into AC power charges the battery and also protects your work in case of a power outage. If the computer contains a charged battery and is running on external AC power, the computer automatically switches to battery power if the AC adapter is disconnected on the computer or an AC power loss occurs.

 **NOTE:** When you disconnect AC power, the display brightness is automatically decreased to save battery life. Select computer models can switch between graphic modes to increase battery life. For more information, see [Hybrid Graphics and AMD Dual Graphics \(select models only\) on page 51](#).

Finding additional battery information

HP Support Assistant provides the tools and information about the battery. To access battery information, select the **HP Support Assistant** app on the Start screen, and then select **Battery and performance**.

- Battery Check tool to test battery performance
- Information on calibration, power management, and proper care and storage to maximize battery life
- Information on battery types, specifications, life cycles, and capacity

To access battery information:

- ▲ To access battery information, select the **HP Support Assistant** app on the Start screen, and then select **Battery and performance**.

Using Battery Check

HP Support Assistant provides information on the status of the battery installed in the computer.

To run Battery Check:

1. Connect the AC adapter to the computer.

 **NOTE:** The computer must be connected to external power for Battery Check to work properly.

2. To access battery information, select the **HP Support Assistant** app on the Start screen, and then select **Battery and performance**.

Battery Check examines the battery and its cells to see if they are functioning properly, and then reports the results of the examination.

Displaying the remaining battery charge

- ▲ Move the pointer over the power meter icon on the Windows desktop in the notification area, at the far right of the taskbar.

Maximizing battery discharge time

Battery discharge time varies depending on features you use while on battery power. Maximum discharge time gradually decreases as the battery storage capacity naturally degrades.

Tips for maximizing battery discharge time:

- Lower the brightness on the display.
- Remove the battery from the computer when it is not being used or charged, if the computer contains a user-replaceable battery.
- Store the user-replaceable battery in a cool, dry location.
- Select the **Power saver** setting in Power Options.

Managing low battery levels

The information in this section describes the alerts and system responses set at the factory. Some low-battery alerts and system responses can be changed using Power Options. Preferences set using Power Options do not affect lights.

From the Start screen, type `power`, select **Settings**, and then select **Power Options**.

Identifying low battery levels

When a battery that is the sole power source for the computer reaches a low or critical battery level, the following behavior occurs:

- The battery light (select models only) indicates a low or critical battery level.

– or –

- The power meter icon in the notification area shows a low or critical battery notification.

 **NOTE:** For additional information about the power meter, see [Using the power meter and power settings on page 45](#).

If the computer is on or in the Sleep state, the computer remains briefly in the Sleep state, and then shuts down and loses any unsaved information.

Resolving a low battery level

Resolving a low battery level when external power is available

- ▲ Connect one of the following devices:
 - AC adapter
 - Optional docking or expansion device
 - Optional power adapter purchased as an accessory from HP

Resolving a low battery level when no power source is available

To resolve a low battery level when no power source is available, save your work and shut down the computer.

Inserting or removing the battery

Inserting a battery

To insert the battery:

1. Turn the computer upside down on a flat surface, with the battery bay toward you.
2. Insert the battery into the battery bay, aligning the tabs on the battery (1) with the notches on the computer, and then press the battery down (2) until it is seated.

The battery release latch automatically locks the battery into place.

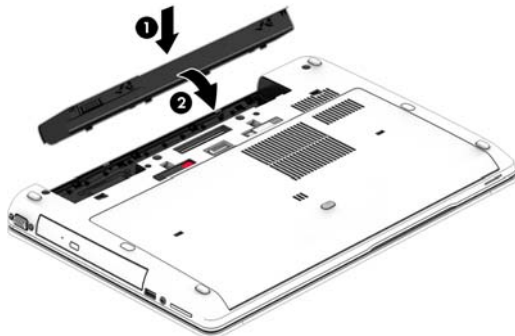

Removing a battery

To remove the battery:

⚠ CAUTION: Removing a battery that is the sole power source for the computer can cause loss of information. To prevent loss of information, save your work and shut down the computer through Windows before removing the battery.

1. Turn the computer upside down on a flat surface, with the battery bay toward you.
2. Slide the battery release latch (1) to release the battery.

3. Pivot the battery up (2), and then remove the battery from the computer (3).

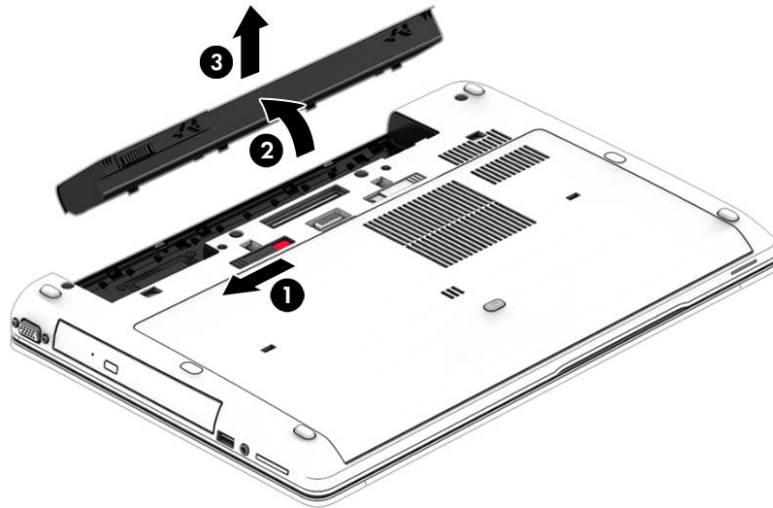

Conserving battery power

- From the Start screen, type `power`, select **Settings**, and then select **Power Options**.
- Select low power-use settings through Power Options.
- Turn off wireless and LAN connections and exit modem applications when you are not using them.
- Disconnect unused external devices that are not plugged into an external power source.
- Stop, disable, or remove any external memory cards that you are not using.
- Decrease screen brightness.
- Before you leave your work, initiate Sleep, or shut down the computer.

Storing a user-replaceable battery (select models only)

CAUTION: To reduce the risk of damage to a battery, do not expose it to high temperatures for extended periods of time.

If a computer will be unused and unplugged from external power for more than 2 weeks, remove the user-replaceable battery and store it separately.

To prolong the charge of a stored battery, place it in a cool, dry place.

NOTE: A stored battery should be checked every 6 months. If the capacity is less than 50 percent, recharge the battery before returning it to storage.

Calibrate a battery before using it if it has been stored for one month or more.

Disposing of a user-replaceable battery (select models only)

WARNING! To reduce the risk of fire or burns, do not disassemble, crush, or puncture; do not short external contacts; do not dispose of in fire or water.

See the *Regulatory, Safety and Environmental Notices* for proper battery disposal. To access this guide, from the Start screen, type `support`, and then select the **HP Support Assistant** app. To access battery information, select the **HP Support Assistant** app on the Start screen, and then select **Battery and performance**.

Replacing a user-replaceable battery (select models only)

Battery Check notifies you to replace the battery when an internal cell is not charging properly or when the battery storage capacity has reached a weak condition. If the battery is possibly covered by an HP warranty, instructions include a warranty ID. A message refers you to the HP website for more information about ordering a replacement battery.

Using external AC power

 **WARNING!** Do not charge the computer battery while you are onboard aircraft.

 **WARNING!** To reduce potential safety issues, use only the AC adapter provided with the computer, a replacement AC adapter provided by HP, or a compatible AC adapter purchased from HP.

 **NOTE:** For information on connecting to AC power, see the *Setup Instructions* poster provided in the computer box.

External AC power is supplied through an approved AC adapter or an optional docking or expansion device.

Connect the computer to external AC power under any of the following conditions:

- When charging or calibrating a battery
- When installing or modifying system software
- When writing information to a CD, a DVD, or a BD (select models only)
- When running Disk Defragmenter
- When performing a backup or recovery

When you connect the computer to external AC power, the following events occur:

- The battery begins to charge.
- If the computer is turned on, the power meter icon in the notification area changes appearance.

When you disconnect external AC power, the following events occur:

- The computer switches to battery power.
- The display brightness is automatically decreased to save battery life.

Testing an AC adapter

Test the AC adapter if the computer exhibits any of the following symptoms when it is connected to AC power:

- The computer does not turn on.
- The display does not turn on.
- The power lights are off.

To test the AC adapter:

 **NOTE:** The following instructions apply to computers with user-replaceable batteries.

1. Shut down the computer.
2. Remove the battery from the computer.
3. Connect the AC adapter to the computer, and then plug it into an AC outlet.
4. Turn on the computer.
 - If the power lights turn *on*, the AC adapter is working properly.
 - If the power lights remain *off*, the AC adapter is not functioning and should be replaced.

Contact support for information on obtaining a replacement AC power adapter.

Hybrid Graphics and AMD Dual Graphics (select models only)

Select computers are equipped with either the Hybrid Graphics feature or the AMD Dual Graphics feature.

 **NOTE:** To determine whether Hybrid Graphics or AMD Dual Graphics is installed on your computer, see your notebook graphics processor configuration and software Help.

Both Hybrid Graphics and AMD Dual Graphics offer two modes for processing graphics:

- High Performance mode—Applications assigned to this mode run on the higher-performance graphics processing unit (GPU) for optimal performance.
- Power Saving mode—Applications assigned to this mode run on the lower-performance GPU to conserve battery power.

Using Hybrid Graphics (select models only)

The Hybrid Graphics feature allows an application to run in either High Performance mode or Power Saving mode, based on the application's graphics-processing demands. Typically, 3D and gaming applications run on the higher-performance GPU, and applications with lightweight graphics-processing demands run on the lower-performance GPU. You can change the mode an application uses (High Performance or Power Saving) through the Hybrid Graphics control panel.

 **NOTE:** Due to hardware limitations, some applications can be run in only one of the two modes.

For more information, see your Hybrid Graphics software Help.

Using AMD Dual Graphics (select models only)

The AMD Dual Graphics feature allows the AMD accelerated processing unit (APU) and the discrete AMD graphics card to work together. When AMD Dual Graphics is enabled, graphics performance improves over the performance available using only one of the graphics devices. This improvement applies to DirectX versions 10 or 11 (DX10 and DX11) applications operating in full-screen mode. In windowed mode or when running non-DX10/11 applications, the system operates in a manner similar to Hybrid Graphics.

 **NOTE:** For more information, see the AMD Dual Graphics software Help.

7 External cards and devices

Using memory card readers (select models only)

Optional memory cards provide secure data storage and convenient data sharing. These cards are often used with digital media–equipped cameras and PDAs as well as with other computers.

To determine the memory card formats that are supported on your computer, see [Getting to know your computer on page 5](#).

Inserting a memory card

⚠ CAUTION: To reduce the risk of damage to the memory card connectors, use minimal force to insert a memory card.

1. Hold the card label-side up, with the connectors facing the computer.
2. Insert the card into the memory card reader, and then press in on the card until it is firmly seated.

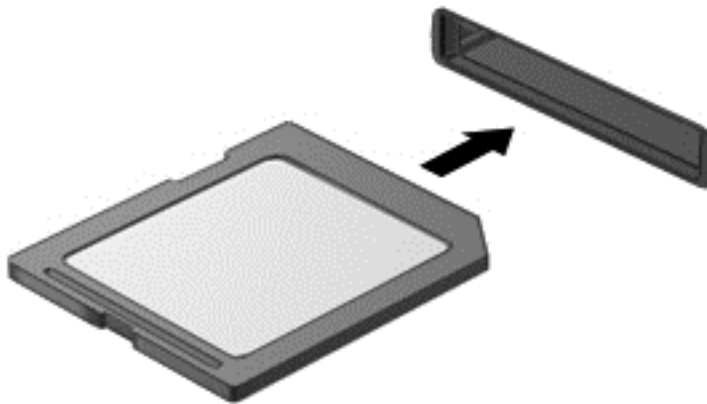



You will hear a sound when the device has been detected, and a menu of options may be displayed.

Removing a memory card

⚠ CAUTION: To reduce the risk of loss of data or an unresponsive system, use the following procedure to safely remove the memory card.

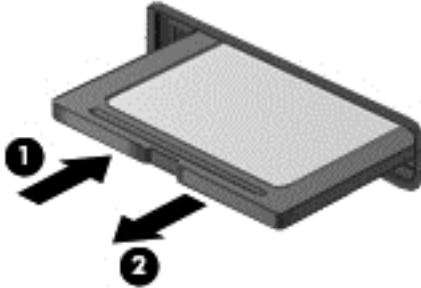
1. Save your information and close all programs associated with the memory card.
2. Click the remove hardware icon on the Windows desktop in the notification area, at the far right of the taskbar. Then follow the on-screen instructions.
3. Press in on the card (1), and then remove it from the slot (2).



 **NOTE:** If the card does not eject, pull the card out of the slot.

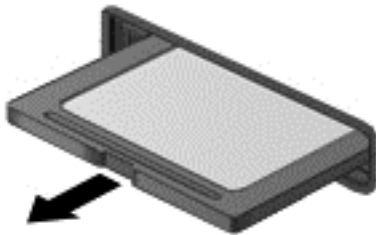

Using ExpressCards (select models only)

An ExpressCard is a high-performance PC Card that is inserted into the ExpressCard slot.

ExpressCards are designed to conform to the standard specifications of the Personal Computer Memory Card International Association (PCMCIA).

Configuring an ExpressCard

Install only the software required for the card. If you are instructed by the ExpressCard manufacturer to install device drivers:

- Install only the device drivers for your operating system.
- Do not install additional software, such as card services, socket services, or enablers, that are supplied by the ExpressCard manufacturer.

Inserting an ExpressCard

 **CAUTION:** To prevent damage to the computer and external memory cards, do not insert a PC Card into an ExpressCard slot.

CAUTION: To reduce the risk of damage to the connectors:

- Use minimal force when inserting an ExpressCard.
- Do not move or transport the computer when an ExpressCard is in use.

 **NOTE:** The following illustration may look slightly different than your device.

The ExpressCard slot may contain a protective insert. To remove the insert:

1. Press in on the insert (1) to unlock it.
2. Pull the insert out of the slot (2).



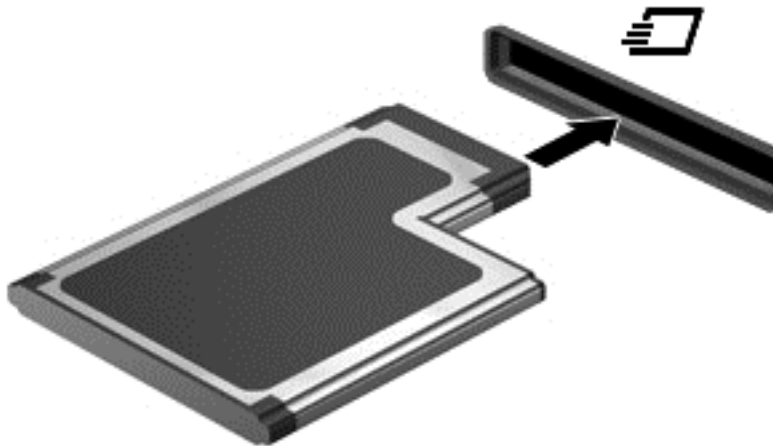

To insert an ExpressCard:

1. Hold the card label-side up, with the connectors facing the computer.
2. Insert the card into the ExpressCard slot, and then press in on the card until it is firmly seated.



You will hear a sound when the card has been detected, and a menu of options may be displayed.

 **NOTE:** The first time you connect an ExpressCard, a message in the notification area lets you know that the card is recognized by the computer.

 **NOTE:** To conserve power, stop or remove an ExpressCard when it is not in use.

Removing an ExpressCard

⚠ CAUTION: To reduce the risk of loss of data or an unresponsive system, use the following procedure to safely remove the ExpressCard.

1. Save your information and close all programs associated with the ExpressCard.
2. Click the remove hardware icon on the Windows desktop in the notification area, at the far right of the taskbar, and then follow the on-screen instructions.
3. Release and remove the ExpressCard:
 - a. Gently press in on the ExpressCard **(1)** to unlock it.
 - b. Pull the ExpressCard out of the slot **(2)**.

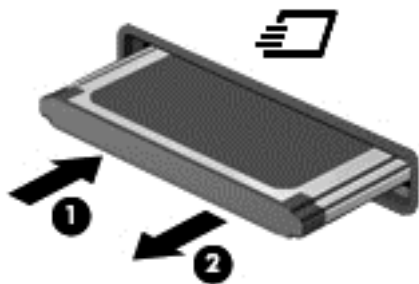

Using smart cards (select models only)

📄 NOTE: The term *smart card* is used throughout this chapter to mean both smart cards and Java™ Cards.

A smart card is a credit card-sized accessory that carries a microchip containing memory and a microprocessor. Like personal computers, smart cards have an operating system to manage input and output, and they include security features to protect against tampering. Industry-standard smart cards are used with the smart card reader (select models only).

A PIN is needed to gain access to the contents of the microchip. For more information about smart card security features, access HP Support Assistant. To access HP Support Assistant on the Start screen, select the **HP Support Assistant** app.

Inserting a smart card

1. Hold the card label-side up, and gently slide the card into the smart card reader until the card is seated.

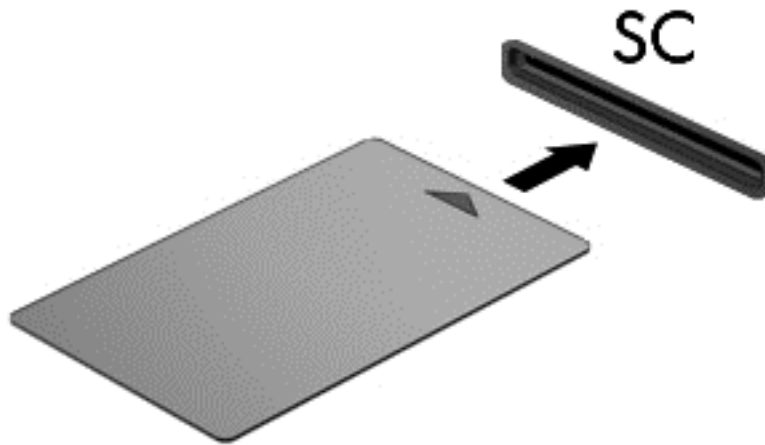

2. Follow the on-screen instructions for logging on to the computer using the smart card PIN.

Removing a smart card

- ▲ Grasp the edge of the smart card, and then pull it out of the smart card reader.

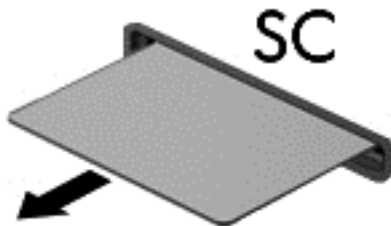

Using a USB device

Universal Serial Bus (USB) is a hardware interface that can be used to connect an optional external device, such as a USB keyboard, mouse, drive, printer, scanner, or hub.

Some USB devices may require additional support software, which is usually included with the device. For more information about device-specific software, see the manufacturer's instructions. These instructions may be provided with the software, on disc, or on the manufacturer's website.

The computer has at least 1 USB port that supports USB 1.0, 1.1, 2.0, or 3.0 devices. Your computer may also have a USB charging port that provides power to an external device. An optional docking device or USB hub provides additional USB ports that can be used with the computer.

Connecting a USB device

⚠ CAUTION: To reduce the risk of damage to a USB connector, use minimal force to connect the device.

▲ Connect the USB cable for the device to the USB port.

📝 NOTE: The following illustration may look slightly different than your computer.



You will hear a sound when the device has been detected.

📝 NOTE: The first time you connect a USB device, a message in the notification area lets you know that the device is recognized by the computer.

Removing a USB device

⚠ CAUTION: To reduce the risk of damage to a USB connector, do not pull on the cable to remove the USB device.

CAUTION: To reduce the risk of loss of information or an unresponsive system, use the following procedure to safely remove the USB device.

1. To remove a USB device, save your information and close all programs associated with the device.
2. Click the remove hardware icon on the Windows desktop in the notification area, at the far right of the taskbar, and then follow the on-screen instructions.
3. Remove the device.

Using optional external devices

📝 NOTE: For more information about required software and drivers, or to learn which computer port to use, see the manufacturer's instructions.

To connect an external device to the computer:

⚠ CAUTION: To reduce the risk of damage to the equipment when connecting a powered device, be sure that the device is turned off and the AC power cord is unplugged.

1. Connect the device to the computer.
2. If you are connecting a powered device, plug the device power cord into a grounded AC outlet.
3. Turn on the device.

To disconnect an unpowered external device, turn off the device, and then disconnect it from the computer. To disconnect a powered external device, turn off the device, disconnect it from the computer, and then unplug the AC power cord.

Using optional external drives

Removable external drives expand your options for storing and accessing information. A USB drive can be added by connecting the drive to a USB port to the computer.

 **NOTE:** HP external USB optical drives should be connected to the powered USB port to the computer.

USB drives include the following types:

- 1.44-megabyte diskette drive
- Hard drive module
- External optical drive (CD, DVD, and Blu-ray)
- MultiBay device

Using the docking connector (select models only)

The docking connector connects the computer to an optional docking device. An optional docking device provides additional ports and connectors that can be used with the computer.

 **NOTE:** The following image may look slightly different than your computer or docking device.

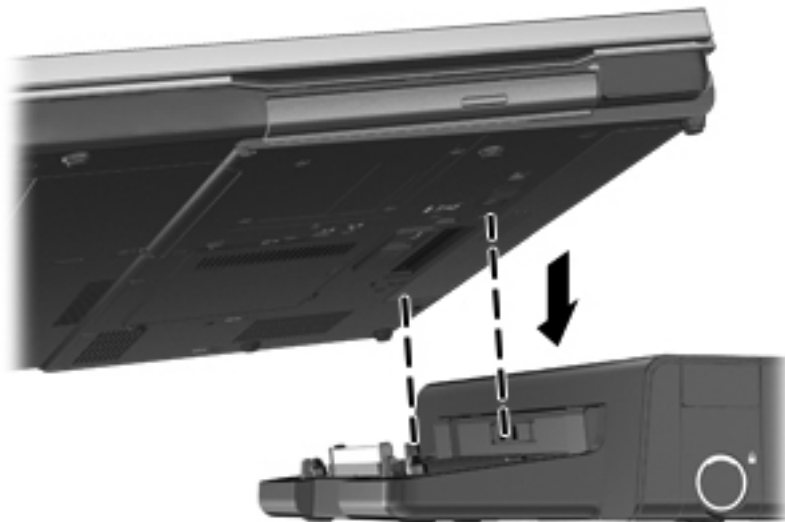

8 Drives

Handling drives

 **CAUTION:** Drives are fragile computer components that must be handled with care. Refer to the following cautions before handling drives. Additional cautions are included with the procedures to which they apply.

Observe these precautions:

- Before you move a computer that is connected to an external hard drive, initiate Sleep and allow the screen to clear, or properly disconnect the external hard drive.
- Before handling a drive, discharge static electricity by touching a grounded surface.
- Do not touch the connector pins on a removable drive or on the computer.
- Handle a drive carefully; do not drop a drive or place items on it.
- Before removing or inserting a drive, shut down the computer. If you are unsure whether the computer is off, in the Sleep state, turn the computer on, and then shut it down through the operating system.
- Do not use excessive force when inserting a drive into a drive bay.
- Do not type on the keyboard or move the computer while an optical drive is writing to a disc. The write process is sensitive to vibration.
- Avoid exposing a drive to temperature or humidity extremes.
- Avoid exposing a drive to liquids. Do not spray the drive with cleaning products.
- Remove media from a drive before removing the drive from the drive bay, or traveling with, shipping, or storing a drive.
- If a drive must be mailed, place the drive in a bubble-pack mailer or other suitable protective packaging and label the package “FRAGILE.”
- Avoid exposing a drive to magnetic fields. Security devices with magnetic fields include airport walk-through devices and security wands. Airport conveyer belts and similar security devices that check carry-on baggage use X-rays instead of magnetism and do not damage drives.

Using hard drives

⚠ CAUTION: To prevent information loss or an unresponsive system:

- Save your work and shut down the computer before adding or replacing a memory module or hard drive.
- If you are not sure whether the computer is off, turn the computer on by pressing the power button. Then shut down the computer through the operating system.

Removing or replacing the service door

Removing the service door

Remove the service door to access the memory module slot, hard drive, and other components.

1. Remove the battery (see [Removing a battery on page 48](#)).
2. With the battery bay toward you, slide the service door release latch (1) to the left, remove the screw (if the optional screw is being used) (2), and then slide the release latch again (3) to release the service door.

📝 NOTE: If you do not want to use the optional screw, you can store it inside the service door.

3. Slide the service door toward the front of the computer (4) and lift (5) to remove the service door.

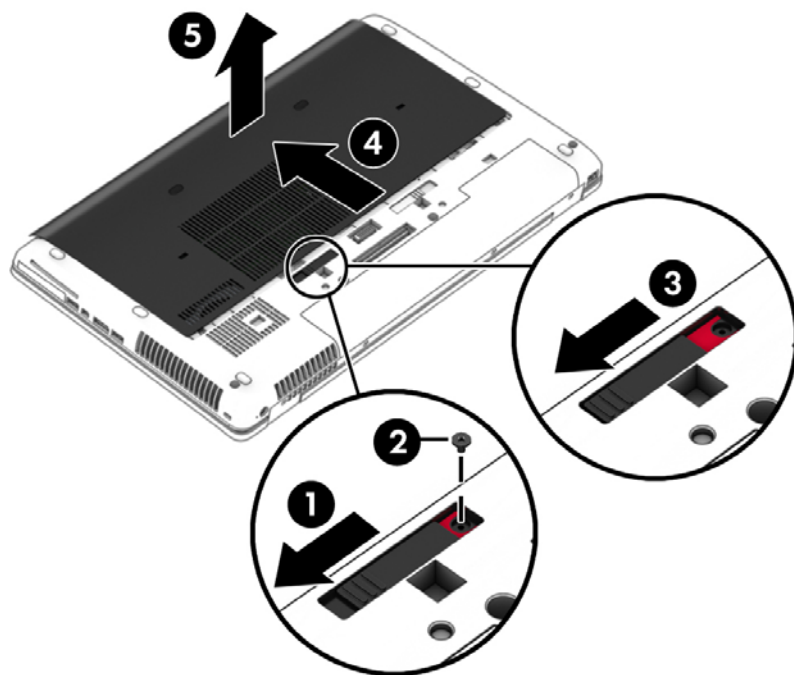

Replacing the service door

Replace the service door after accessing the memory module slot, hard drive, regulatory label, and other components.

1. Tilt down the service door to align the front edge of the service door near the front edge of the computer (1).
2. Insert the alignment tabs (2) on the rear edge of the service door with the notches on the computer.
3. Slide the service door toward the battery bay until the service door snaps into place.
4. With the battery bay toward you, slide the service door release latch to the left (3), and if you choose to, insert and tighten the optional screw (4) to hold the service door in place. Slide the release latch to the right to lock the service door (5).

 **NOTE:** If you do not want to use the optional screw, you can store it inside the service door.

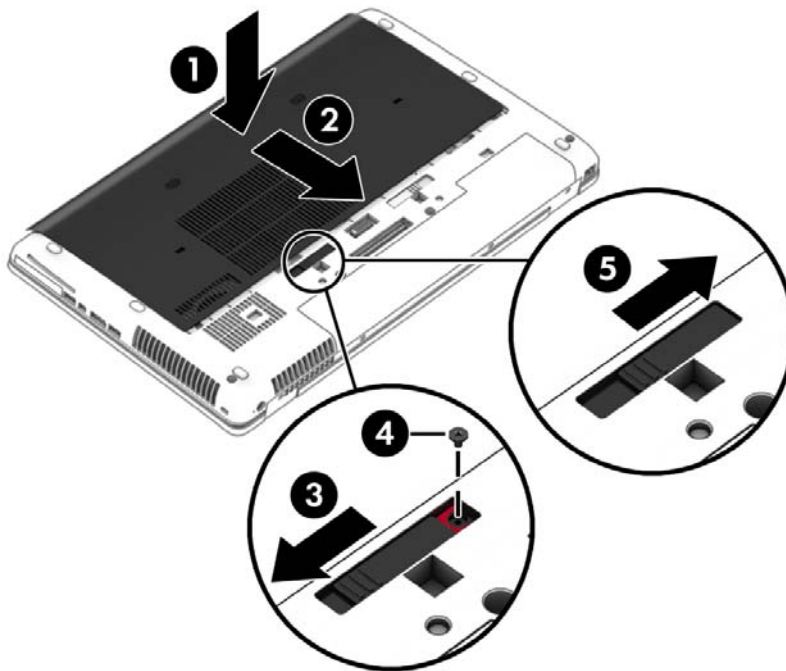

5. Insert the battery (see [Inserting a battery on page 48](#)).

Replacing or upgrading the hard drive

 **CAUTION:** To prevent information loss or an unresponsive system:

Shut down the computer before removing the hard drive from the hard drive bay. Do not remove the hard drive while the computer is on, in the Sleep state, or in Hibernation.

If you are not sure whether the computer is off, turn the computer on by pressing the power button. Then shut down the computer through the operating system.

Removing the hard drive

To remove a hard drive:

1. Save your work and shut down the computer.
2. Disconnect AC power and external devices connected to the computer.

3. Turn the computer upside down on a flat surface.
4. Remove the battery (see [Removing a battery on page 48](#)).
5. Remove the service door (see [Removing or replacing the service door on page 62](#)).
6. Loosen the 3 hard drive screws (1). Pull the hard drive tab (2) to the left to disconnect the hard drive.
7. Lift the hard drive (3), and then pull the hard drive out of the hard drive bay.

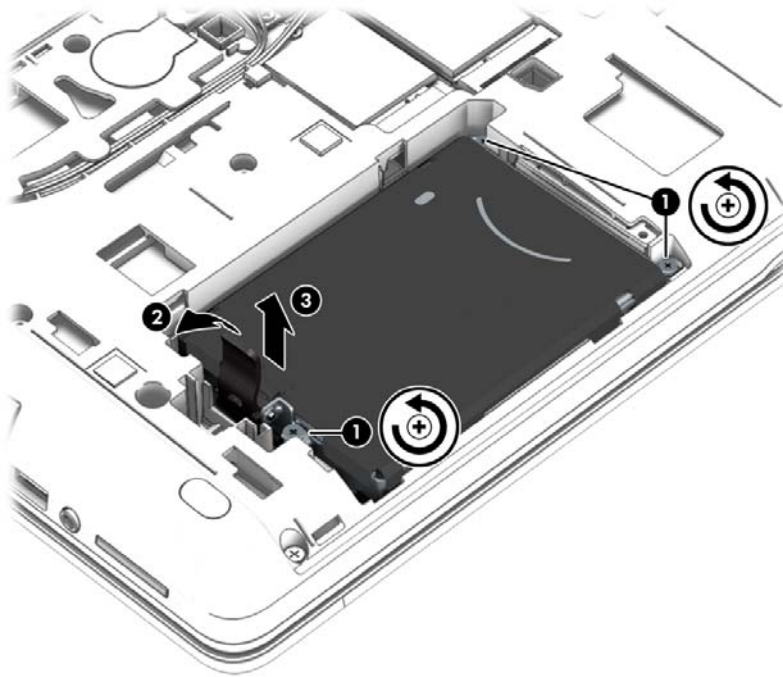

Installing a hard drive

 **NOTE:** Your computer may look slightly different from the illustration in this section.

To install the hard drive:

1. Insert the hard drive into the hard drive bay at an angle (1), and then lower the hard drive into the hard drive bay.
2. Pull the plastic tab (2) toward the center of the computer to engage the hard drive with the connector.

3. Tighten the hard drive screws (3).

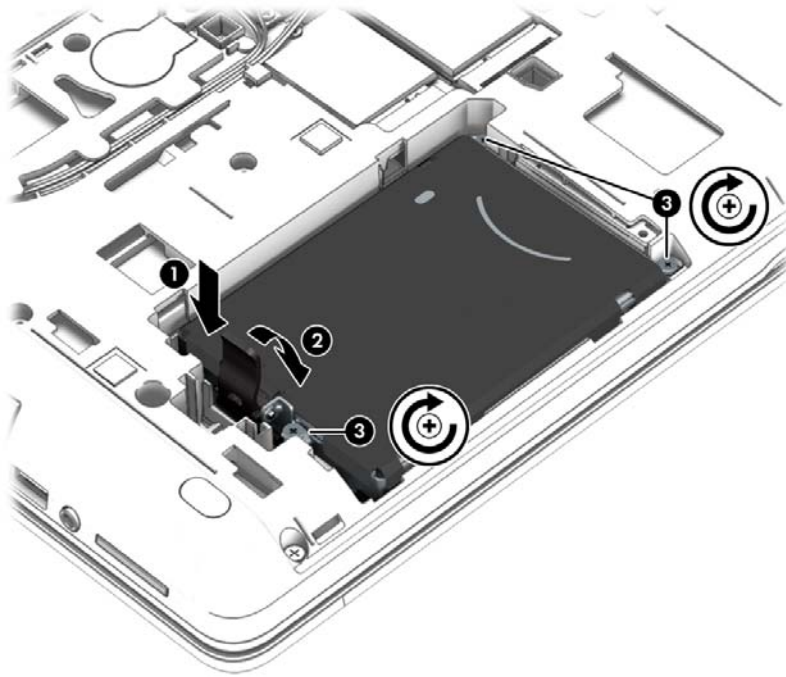

4. Replace the service door (see [Replacing the service door on page 62](#)).
5. Insert the battery (see [Inserting a battery on page 48](#)).
6. Connect AC power and external devices to the computer.
7. Turn on the computer.

Improving hard drive performance

Using Disk Defragmenter

As you use the computer, files on the hard drive become fragmented. Disk Defragmenter consolidates the fragmented files and folders on the hard drive so that the system can run more efficiently.

 **NOTE:** It is not necessary to run Disk Defragmenter on solid-state drives.

After you start Disk Defragmenter, it works without supervision. Depending on the size of your hard drive and the number of fragmented files, Disk Defragmenter may take more than an hour to complete. You may want to set it to run during the night or at another time when you do not need access to your computer.

HP recommends defragmenting your hard drive at least once a month. You may set Disk Defragmenter to run on a monthly schedule, but you can defragment your computer manually at any time.

To run Disk Defragmenter:

1. Connect the computer to AC power.
2. From the Start screen, type `disk`.
3. Click **Optimize**.

 **NOTE:** Windows includes the User Account Control feature to improve the security of your computer. You may be prompted for your permission or password for tasks such as installing software, running utilities, or changing Windows settings. Refer to HP Support Assistant. To access HP Support Assistant, from the Start screen, select the **HP Support Assistant** app.

For additional information, access the Disk Defragmenter software Help.

Using Disk Cleanup

Disk Cleanup searches the hard drive for unnecessary files that you can safely delete to free up disk space and help the computer to run more efficiently.

To run Disk Cleanup:

1. From the **Start** screen, type `disk`, and then select **Uninstall apps to free up disk space**.
2. Follow the on-screen instructions.

Using HP 3D DriveGuard (select models only)

HP 3D DriveGuard protects a hard drive by parking the drive and halting data requests under either of the following conditions:

- You drop the computer.
- You move the computer with the display closed while the computer is running on battery power.

A short time after the end of one of these events, HP 3D DriveGuard returns the hard drive to normal operation.

 **NOTE:** Because solid-state drives (SSDs) lack moving parts, HP 3D DriveGuard is unnecessary.

 **NOTE:** A hard drive in a primary hard drive bay or in a secondary hard drive bay is protected by HP 3D DriveGuard. A hard drive installed in an optional docking device or connected to a USB port is not protected by HP 3D DriveGuard.

For more information, see the HP 3D DriveGuard software Help.

Identifying HP 3D DriveGuard status

The hard drive light on the computer changes color to show that a drive in the primary hard drive bay and/or the drive in a secondary hard drive bay (select models only) is parked. To determine whether a drive is currently protected or whether it is parked, view the icon on the Windows desktop in the notification area, at the far right of the taskbar, or in the Mobility Center.

Using RAID (select models only)





Redundant Arrays of Independent Disks (RAID) technology allows a computer to use two or more hard disks at the same time. RAID treats multiple drives as one contiguous drive, either through

hardware or software settings. If multiple disks are set up to work together in this fashion, they are referred to as a RAID array. For more information, see the HP website. To access the latest user guides, contact support. For U.S. support, go to <http://www.hp.com/go/contactHP>. For worldwide support, go to http://welcome.hp.com/country/us/en/wwcontact_us.html.

9 Security

Protecting the computer

Standard security features provided by the Windows operating system and the non-Windows Computer Setup utility (BIOS) can protect your personal settings and data from a variety of risks.

-  **NOTE:** Security solutions are designed to act as deterrents. These deterrents may not prevent a product from being mishandled or stolen.
-  **NOTE:** Before you send your computer for service, back up and delete confidential files, and remove all password settings.
-  **NOTE:** Some features listed in this chapter may not be available on your computer.
-  **NOTE:** Your computer supports Computrace, which is an online security-based tracking and recovery service available in select regions. If the computer is stolen, Computrace can track the computer if the unauthorized user accesses the Internet. You must purchase the software and subscribe to the service in order to use Computrace. For information about ordering the Computrace software, go to <http://www.hp.com>.

Computer risk	Security feature
Unauthorized use of the computer	HP Client Security, in combination with a password, smart card, contactless card, registered fingerprints, or other authentication credential
Unauthorized access to Computer Setup (f10)	BIOS administrator password in Computer Setup*
Unauthorized access to the contents of a hard drive	DriveLock password or Automatic DriveLock password in Computer Setup*
Unauthorized startup from an optional external optical drive (select models only), optional external hard drive (select models only), or internal network adapter	Boot options feature in Computer Setup*
Unauthorized access to a Windows user account	Windows user password
Unauthorized access to data	<ul style="list-style-type: none">• HP Drive Encryption software• Windows Defender
Unauthorized access to Computer Setup settings and other system identification information	BIOS administrator password in Computer Setup*
Unauthorized removal of the computer	Security cable slot (used with an optional security cable)

*Computer Setup is a preinstalled, ROM-based utility that can be used even when the operating system is not working or will not load. You can use either a pointing device (TouchPad, pointing stick, or USB mouse) or the keyboard to navigate and make selections in Computer Setup.

Using passwords

A password is a group of characters that you choose to secure your computer information. Several types of passwords can be set, depending on how you want to control access to your information. Passwords can be set in Windows or in the non-Windows Computer Setup utility that is preinstalled on the computer.

- BIOS administrator and DriveLock passwords are set in Computer Setup and are managed by the system BIOS.
- Automatic DriveLock passwords are enabled in Computer Setup.
- Windows passwords are set only in the Windows operating system.
- If HP SpareKey has been set up previously, and if you forget the BIOS administrator password set in Computer Setup, you can use HP SpareKey to access the utility.
- If you forget both the DriveLock user password and the DriveLock master password set in Computer Setup, the hard drive that is protected by the passwords is permanently locked and can no longer be used.

You can use the same password for a Computer Setup feature and for a Windows security feature. You can also use the same password for more than one Computer Setup feature.

Use the following tips for creating and saving passwords:

- When creating passwords, follow requirements set by the program.
- Do not use the same password for multiple applications or websites, and do not reuse your Windows password for any other application or website.
- Use HP Client Security's Password Manager to store your user names and passwords for all of your websites and applications. You can securely read them in the future if they cannot be remembered.
- Do not store passwords in a file on the computer.

The following tables list commonly used Windows and BIOS administrator passwords and describe their functions.

Setting passwords in Windows

Password	Function
Administrator password*	Protects access to a Windows administrator-level account. NOTE: Setting the Windows Administrator password does not set the BIOS Administrator password.
User password*	Protects access to a Windows user account.

*For information about setting a Windows administrator password or a Windows user password from the Start screen, access HP Support Assistant. To access HP Support Assistant, from the Start screen, select the **HP Support Assistant** app.

Setting passwords in Computer Setup

Password	Function
BIOS administrator password*	Protects access to Computer Setup. NOTE: If features have been enabled to prevent removing the BIOS administrator password, you may not be able to remove it until those features have been disabled.
DriveLock master password*	Protects access to the internal hard drive that is protected by DriveLock. It is also used to remove DriveLock protection. This password is set under DriveLock Passwords during the enable process. NOTE: A BIOS Administrator password must be set before you can set a DriveLock password.
DriveLock user password*	Protects access to the internal hard drive that is protected by DriveLock, and is set under DriveLock Passwords during the enable process. NOTE: A BIOS Administrator password must be set before you can set a DriveLock password.

*For details about each of these passwords, see the following topics.

Managing a BIOS administrator password

To set, change, or delete this password, follow these steps:

Setting a new BIOS administrator password

1. Turn on or restart the computer, and then press **esc** while the “Press the ESC key for Startup Menu” message is displayed at the bottom of the screen.
2. Press **f10** to enter Computer Setup.
3. Use a pointing device or the arrow keys to select **Security > Setup BIOS Administrator Password**, and then press **enter**.
4. When prompted, type a password.
5. When prompted, type the new password again to confirm.
6. To save your changes and exit Computer Setup, click the **Save** icon and then follow the on-screen instructions.

– or –

Use the arrow keys to select **Main > Save Changes and Exit**, and then press **enter**.

Your changes go into effect when the computer restarts.

Changing a BIOS administrator password

1. Turn on or restart the computer, and then press **esc** while the “Press the ESC key for Startup Menu” message is displayed at the bottom of the screen.
2. Press **f10** to enter Computer Setup.

3. Use a pointing device or the arrow keys to select **Security > Change Password**, and then press **enter**.
4. When prompted, type your current password.
5. When prompted, type your new password again to confirm.
6. To save your changes and exit Computer Setup, click the **Save** icon in the lower-left corner of the screen, and then follow the on-screen instructions.

– or –

Use the arrow keys to select **Main > Save Changes and Exit**, and then press **enter**.

Your changes go into effect when the computer restarts.

Deleting a BIOS administrator password

1. Turn on or restart the computer, and then press **esc** while the “Press the ESC key for Startup Menu” message is displayed at the bottom of the screen.
2. Press **f10** to enter Computer Setup.
3. Use a pointing device or the arrow keys to select **Security > Change Password**, and then press **enter**.
4. When prompted, type your current password.
5. When prompted for the new password, leave the field empty, and then press **enter**.
6. Read the warning. To continue, select **YES**.
7. When prompted to type your new password again, leave the field empty, and then press **enter**.
8. To save your changes and exit Computer Setup, click the **Save** icon in the lower-left corner of the screen, and then follow the on-screen instructions.

– or –

Use the arrow keys to select **Main > Save Changes and Exit**, and then press **enter**.

Your changes go into effect when the computer restarts.

Entering a BIOS administrator password

At the **BIOS administrator password** prompt, type your password (using the same kind of keys you used to set the password), and then press **enter**. After 3 unsuccessful attempts to enter the BIOS administrator password, you must restart the computer and try again.

Managing a Computer Setup DriveLock password

⚠ CAUTION: To prevent the DriveLock-protected hard drive from becoming permanently unusable, record the DriveLock user password and the DriveLock master password in a safe place away from your computer. If you forget both DriveLock passwords, the hard drive will be permanently locked and can no longer be used.

DriveLock protection prevents unauthorized access to the contents of a hard drive. DriveLock can be applied only to the internal hard drive(s) of the computer. After DriveLock protection is applied to a

drive, a password must be entered to access the drive. The drive must be inserted into the computer or an advanced port replicator in order for it to be accessed by the DriveLock passwords.

 **NOTE:** A BIOS Administrator password must be set before you can access the DriveLock features.

To apply DriveLock protection to an internal hard drive, a user password and a master password must be set in Computer Setup. Note the following considerations about using DriveLock protection:

- After DriveLock protection is applied to a hard drive, the hard drive can be accessed only by entering either the user password or the master password.
- The owner of the user password should be the day-to-day user of the protected hard drive. The owner of the master password may be either a system administrator or the day-to-day user.
- The user password and the master password can be identical.
- You can delete a user password or master password only by removing DriveLock protection from the drive. DriveLock protection can be removed from the drive only with the master password.

Setting a DriveLock password

To set a DriveLock password in Computer Setup, follow these steps:

1. Turn on the computer, and then press **esc** while the “Press the ESC key for Startup Menu” message is displayed at the bottom of the screen.
2. Press **f10** to enter Computer Setup.
3. Use a pointing device or the arrow keys to select **Security > Hard Drive Tools > DriveLock**, and then press **enter**.
4. Click Set DriveLock Password (global).
5. Enter the BIOS Administrator password, and then press **enter**.
6. Use a pointing device or the arrow keys to select the hard drive you want to protect, and then press **enter**.
7. Read the warning. To continue, select **YES**.
8. When prompted, type a master password, and then press **enter**.
9. When prompted, type the master password again to confirm, and then press **enter**.
10. When prompted, type a user password, and then press **enter**.
11. When prompted, type the user password again to confirm, and then press **enter**.
12. To confirm DriveLock protection on the drive you have selected, type **DriveLock** in the confirmation field, and then press **enter**.

 **NOTE:** The DriveLock confirmation is case sensitive.

13. To save your changes and exit Computer Setup, click the **Save** icon in the lower-left corner of the screen, and then follow the on-screen instructions.

– or –

Use the arrow keys to select **Main > Save Changes and Exit**, and then press [enter](#).

Your changes go into effect when the computer restarts.

Entering a DriveLock password

Be sure that the hard drive is inserted into the computer (not into an optional docking device or external MultiBay).

At the **DriveLock Password** prompt, type your user or master password (using the same kind of keys you used to set the password), and then press [enter](#).

After 2 incorrect attempts to enter the password, you must shut down the computer and try again.

Changing a DriveLock password

To change a DriveLock password in Computer Setup, follow these steps:

1. Turn on the computer, and then press [esc](#) while the “Press the ESC key for Startup Menu” message is displayed at the bottom of the screen.
2. Press [f10](#) to enter Computer Setup.
3. Use a pointing device or the arrow keys to select **Security > Hard Drive Tools > DriveLock**, and then press [enter](#).
4. Enter the BIOS Administrator password, and then press [enter](#).
5. Use a pointing device or the arrow keys to select **Set DriveLock Password**, and then press [enter](#).
6. Use the arrow keys to select an internal hard drive, and then press [enter](#).
7. Use a pointing device or the arrow keys to select **Change Password**.
8. When prompted, type your current password, and then press [enter](#).
9. When prompted, type a new password, and then press [enter](#).
10. When prompted, type the new password again to confirm, and then press [enter](#).
11. To save your changes and exit Computer Setup, click the **Save** icon in the lower-left corner of the screen, and then follow the on-screen instructions.

– or –

Use the arrow keys to select **Main > Save Changes and Exit**, and then press [enter](#).

Your changes go into effect when the computer restarts.

Removing DriveLock protection

To remove DriveLock protection in Computer Setup, follow these steps:

1. Turn on the computer, and then press [esc](#) while the “Press the ESC key for Startup Menu” message is displayed at the bottom of the screen.
2. Press [f10](#) to enter Computer Setup.
3. Use a pointing device or the arrow keys to select **Security > Hard Drive Tools > DriveLock**, and then press [enter](#).

4. Enter the BIOS Administrator password, and then press [enter](#).
5. Use a pointing device or the arrow keys to select **Set DriveLock Password**, and then press [enter](#).
6. Use a pointing device or the arrow keys to select an internal hard drive, and then press [enter](#).
7. Use a pointing device or the arrow keys to select **Disable protection**.
8. Type your master password, and then press [enter](#).
9. To save your changes and exit Computer Setup, click the **Save** icon and then follow the on-screen instructions.

– or –

Use the arrow keys to select **Main > Save Changes and Exit**, and then press [enter](#).

Your changes go into effect when the computer restarts.

Using Computer Setup Automatic DriveLock

In a multiple-user environment, you can set an Automatic DriveLock password. When the Automatic DriveLock password is enabled, a random user password and a DriveLock master password will be created for you. When any user passes the password credential, the same random user and DriveLock master password will be used to unlock the drive.



NOTE: A BIOS Administrator password must be set before you can access the Automatic DriveLock features.

Entering an Automatic DriveLock password

To enable an Automatic DriveLock password in Computer Setup, follow these steps:

1. Turn on or restart the computer, and then press [esc](#) while the “Press the ESC key for Startup Menu” message is displayed at the bottom of the screen.
2. Press [f10](#) to enter Computer Setup.
3. Use a pointing device or the arrow keys to select **Security > Hard Drive Tools > Automatic DriveLock**, and then press [enter](#).
4. Enter the BIOS Administrator password, and then press [enter](#).
5. Use a pointing device or the arrow keys to select an internal hard drive, and then press [enter](#).
6. Read the warning. To continue, select **YES**.
7. To save your changes and exit Computer Setup, click the **Save** icon and then follow the on-screen instructions.

– or –

Use the arrow keys to select **Main > Save Changes and Exit**, and then press [enter](#).

Removing Automatic DriveLock protection

To remove DriveLock protection in Computer Setup, follow these steps:

1. Turn on or restart the computer, and then press **esc** while the “Press the ESC key for Startup Menu” message is displayed at the bottom of the screen.
2. Press **f10** to enter Computer Setup.
3. Use a pointing device or the arrow keys to select **Security > Hard Drive Tools > Automatic DriveLock**, and then press **enter**.
4. Enter the BIOS Administrator password, and then press **enter**.
5. Use a pointing device or the arrow keys to select an internal hard drive, and then press **enter**.
6. Use a pointing device or the arrow keys to select **Disable protection**.
7. To save your changes and exit Computer Setup, click the **Save** icon in the lower-left corner of the screen, and then follow the on-screen instructions.

– or –

Use the arrow keys to select **Main > Save Changes and Exit**, and then press **enter**.

TPM Embedded Security device (select models only)

TPM (Trusted Platform Module) provides additional security for your computer. You can modify the TPM settings in Computer Setup. For information on changing Computer Setup settings, see [Using Computer Setup on page 91](#).

The following table describes the TPM settings in Setup Utility.

Settings	Function
TPM Embedded Security Device	Available/Hidden <ul style="list-style-type: none">• If the administrator password is set, you can select Available.• If you select Hidden, the TPM device is not visible in the operating system.
TPM Status	Enabled/Disabled <ul style="list-style-type: none">• If the administrator password is not set, or if TPM Security Device is set to Hidden, this entry is hidden.• This value reflects the current physical state for the TPM. The state is enabled or disabled by the Embedded Security State setting.

Settings	Function
Embedded Security State	No Operation/Disabled/Enabled <ul style="list-style-type: none"> If the administrator password is not set, or if TPM Security Device is set to Hidden, this entry is hidden. You can enable or disable the TPM function. The next time the computer is restarted after the TPM function is set, this value is set to No Operation.
TPM Set to Factory Defaults	No/Yes <ul style="list-style-type: none"> If the administrator password is not set, or if the TPM Security Device is set to Hidden, this entry is hidden. If the Embedded Security State is set to Enabled, select Yes to reset the TPM to factory settings, and then press f10 to save and exit. A confirmation message is displayed to Clear the TPM. Press f1 to reset the TPM, or press f2 to cancel the action.

Using antivirus software

When you use the computer to access e-mail, a network, or the Internet, you potentially expose it to computer viruses. Computer viruses can disable the operating system, programs, or utilities, or cause them to function abnormally.

Antivirus software can detect most viruses, destroy them, and, in most cases, repair any damage they have caused. To provide ongoing protection against newly discovered viruses, antivirus software must be kept up to date.

Windows Defender is preinstalled on your computer. It is strongly recommended that you continue to use an antivirus program in order to fully protect your computer.

For more information about computer viruses, access HP Support Assistant. To access HP Support Assistant, from the Start screen, select the **HP Support Assistant** app.

Using firewall software

Firewalls are designed to prevent unauthorized access to a system or network. A firewall can be a software program you install on your computer and/or network, or it can be a solution made up of both hardware and software.

There are two types of firewalls to consider:

- Host-based firewalls—Software that protects only the computer it is installed on.
- Network-based firewalls—Installed between your DSL or cable modem and your home network to protect all the computers on the network.

When a firewall is installed on a system, all data sent to and from the system is monitored and compared with a set of user-defined security criteria. Any data that does not meet those criteria is blocked.

Your computer or networking equipment may already have a firewall installed. If not, firewall software solutions are available.

 **NOTE:** Under some circumstances a firewall can block access to Internet games, interfere with printer or file sharing on a network, or block authorized e-mail attachments. To temporarily resolve the problem, disable the firewall, perform the task that you want to perform, and then reenable the firewall. To permanently resolve the problem, reconfigure the firewall.

Installing critical security updates

 **CAUTION:** Microsoft® sends out alerts regarding critical updates. To protect the computer from security breaches and computer viruses, install all critical updates from Microsoft as soon as you receive an alert.

You can choose whether updates are installed automatically. To change the settings, from the Start screen, type `control panel`, and then select **Control Panel**. Select **System and Security**, select **Windows Update**, select **Change settings**, and then follow the on-screen instructions.

Using HP Client Security

HP Client Security software is preinstalled on computer models. This software can be accessed through the HP Client Security tile on the Start screen, the HP Client Security icon in the notification area at the far right of the taskbar, or Windows Control Panel. It provides security features that help protect against unauthorized access to the computer, networks, and critical data. For more information, see the HP Client Security software Help.

Installing an optional security cable

 **NOTE:** A security cable is designed to act as a deterrent, but it may not prevent the computer from being mishandled or stolen.

 **NOTE:** The security cable slot on your computer may look slightly different from the illustration in this section. See [Getting to know your computer on page 5](#) for the location of the security cable slot on your computer.

1. Loop the security cable around a secured object.
2. Insert the key (1) into the cable lock (2).
3. Insert the cable lock into the security cable slot on the computer (3), and then lock the cable lock with the key.

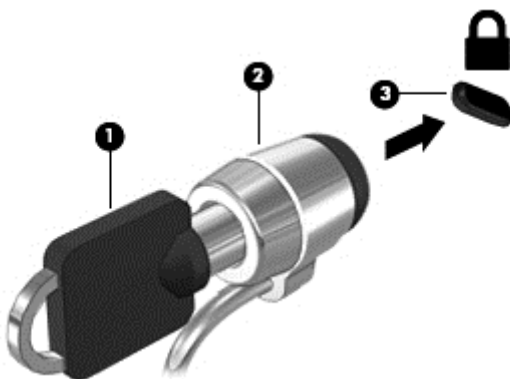

Using the fingerprint reader (select models only)

Integrated fingerprint readers are available on select computer models. In order to use the fingerprint reader, you must enroll your fingerprints in the HP Client Security's Credential Manager. Refer to the HP Client Security software Help.

After you enroll your fingerprints in Credential Manager, you can use HP Client Security's Password Manager to store and fill in your user names and passwords in supported websites and applications.

Locating the fingerprint reader

The fingerprint reader is a small metallic sensor that is located in one of the following areas of your computer:

- Near the bottom of the TouchPad
- On the right side of the keyboard
- On the upper-right side of the display
- On the left side of the display

Depending on your computer model, the reader may be oriented horizontally or vertically. Both orientations require that you swipe your finger perpendicular to the metallic sensor. See [Buttons, speakers, and fingerprint reader \(select models only\) on page 12](#) for the location of the finger print reader on your computer.

10 Maintenance

Adding or replacing memory modules

The computer has one memory module compartment. The capacity of the computer can be upgraded by adding a memory module to the vacant expansion memory module slot or by upgrading the existing memory module in the primary memory module slot.

 **NOTE:** Before adding or replacing a memory module, make sure the computer has the most recent BIOS version, and update the BIOS if needed. See [Updating the BIOS on page 93](#).

 **CAUTION:** Failure to update the computer to the latest BIOS prior to installing or replacing a memory module may result in various system problems.

 **WARNING!** To reduce the risk of electric shock and damage to the equipment, unplug the power cord and remove all batteries before installing a memory module.

 **CAUTION:** Electrostatic discharge (ESD) can damage electronic components. Before beginning any procedure, ensure that you are discharged of static electricity by touching a grounded metal object.

CAUTION: To prevent information loss or an unresponsive system:

Shut down the computer before adding or replacing memory modules. Do not remove a memory module while the computer is on, in the Sleep state, or in Hibernation.

If you are not sure whether the computer is off or in Hibernation, turn the computer on by pressing the power button. Then shut down the computer through the operating system.

 **NOTE:** To use a dual-channel configuration when adding a second memory module, be sure that both memory modules are identical.

 **NOTE:** The primary memory is located in the bottom memory slot and the expansion memory is located in the top memory slot.

To add or replace a memory module:

1. Save your work and shut down the computer.
2. Disconnect AC power and external devices connected to the computer.
3. Remove the battery (see [Removing a battery on page 48](#)).
4. Remove the service door (see [Removing the service door on page 62](#)).
5. If you are replacing a memory module, remove the existing memory module:

- a. Pull away the retention clips (1) on each side of the memory module.

The memory module tilts up.

- b. Grasp the edge of the memory module (2), and then gently pull the memory module out of the memory module slot.

⚠ CAUTION: To prevent damage to the memory module, hold the memory module by the edges only. Do not touch the components on the memory module.

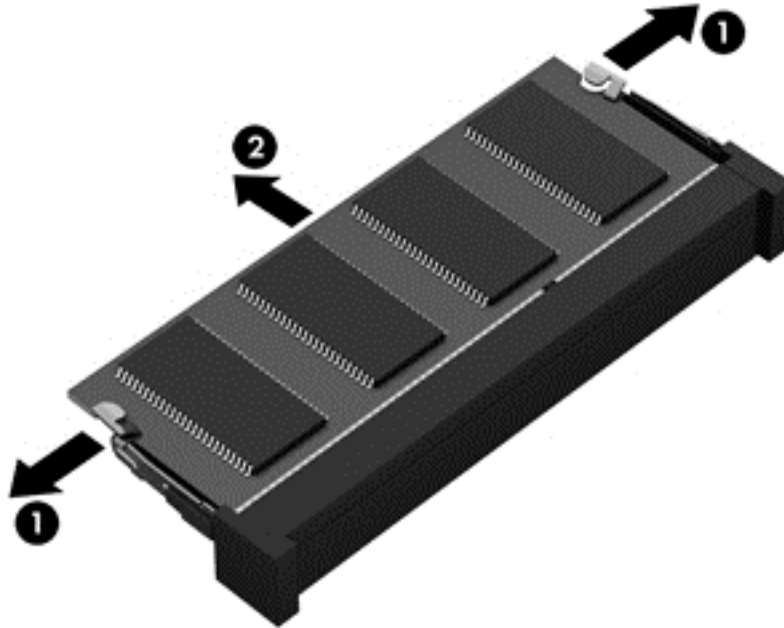

To protect a memory module after removal, place it in an electrostatic-safe container.

6. Insert a new memory module:

⚠ CAUTION: To prevent damage to the memory module, hold the memory module by the edges only. Do not touch the components on the memory module.

- a. Align the notched edge (1) of the memory module with the tab in the memory module slot.
- b. With the memory module at a 45-degree angle from the surface of the memory module compartment, press the module (2) into the memory module slot until it is seated.

- c. Gently press the memory module (3) down, applying pressure to both the left and right edges of the memory module, until the retention clips snap into place.

⚠ CAUTION: To prevent damage to the memory module, be sure that you do not bend the memory module.

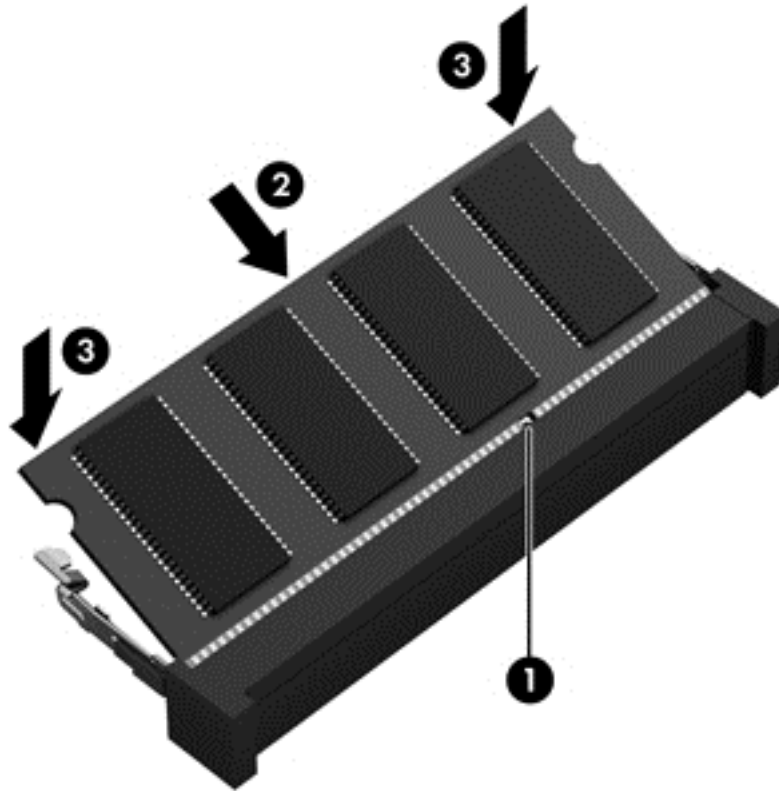

7. Replace the service door (see [Replacing the service door on page 62](#)).
8. Insert the battery (see [Inserting a battery on page 48](#)).
9. Connect AC power and external devices to the computer.
10. Turn on the computer.

Cleaning your computer

Use the following products to safely clean your computer:

- Dimethyl benzyl ammonium chloride 0.3 percent maximum concentration (for example, disposable wipes, which come in a variety of brands).
- Alcohol-free glass-cleaning fluid
- Water with mild soap solution
- Dry microfiber cleaning cloth or a chamois (static-free cloth without oil)
- Static-free cloth wipes

⚠ CAUTION: Avoid strong cleaning solvents that can permanently damage your computer. If you are not sure that a cleaning product is safe for your computer, check the product contents to make sure that ingredients such as alcohol, acetone, ammonium chloride, methylene chloride, and hydrocarbons are not included in the product.

Fibrous materials, such as paper towels, can scratch the computer. Over time, dirt particles and cleaning agents can get trapped in the scratches.

Cleaning procedures

Follow the procedures in this section to safely clean your computer.

⚠ WARNING! To prevent electric shock or damage to components, do not attempt to clean your computer while it is turned on.

- Turn off the computer.
- Disconnect AC power.
- Disconnect all powered external devices.

⚠ CAUTION: To prevent damage to internal components, do not spray cleaning agents or liquids directly on any computer surface. Liquids dripped on the surface can permanently damage internal components.

Cleaning the display (All-in-Ones or Notebooks)

Gently wipe the display using a soft, lint-free cloth moistened with an *alcohol-free* glass cleaner. Be sure that the display is dry before closing the display.

Cleaning the sides or cover

To clean the sides or cover, use a soft microfiber cloth or chamois moistened with one of the cleaning solutions listed previously or use an acceptable disposable wipe.

📝 NOTE: When cleaning the cover of the computer, use a circular motion to aid in removing dirt and debris.

Cleaning the TouchPad, keyboard, or mouse

⚠ WARNING! To reduce the risk of electric shock or damage to internal components, do not use a vacuum cleaner attachment to clean the keyboard. A vacuum cleaner can deposit household debris on the keyboard surface.

⚠ CAUTION: To prevent damage to internal components, do not allow liquids to drip between the keys.

- To clean the TouchPad, keyboard, or mouse, use a soft microfiber cloth or a chamois moistened with one of the cleaning solutions listed previously or use an acceptable disposable wipe.
- To prevent keys from sticking and to remove dust, lint, and particles from the keyboard, use a can of compressed air with a straw extension.

Updating programs and drivers

HP recommends that you update your programs and drivers on a regular basis with the latest versions. Go to <http://www.hp.com/support> to download the latest versions. You can also register to receive automatic update notifications when they become available.

Using SoftPaq Download Manager

HP SoftPaq Download Manager (SDM) is a tool that provides quick access to SoftPaq information for HP business computers without requiring the SoftPaq number. Using this tool, you can easily search for SoftPaqs, and then download and unpack them.

SoftPaq Download Manager works by reading and downloading, from the HP FTP site, a published database file containing computer model and SoftPaq information. SoftPaq Download Manager allows you to specify one or more computer models to determine which SoftPaqs are available for download.

SoftPaq Download Manager checks the HP FTP site for updates to the database and software. If updates are found, they are downloaded and applied automatically.

SoftPaq Download Manager is available on the HP website. To use SoftPaq Download Manager to download SoftPaqs, you must first download and install the program. Go to <http://www.hp.com/go/sdm>, and follow the instructions to download and install SoftPaq Download Manager.

To download SoftPaqs:

- ▲ From the Start screen, type `s`. In the search box, type `softpaq`, and then select HP SoftPaq Download Manager. Follow the instructions to download SoftPaqs.



NOTE: If prompted by User Account Control, click **Yes**.

11 Backup and recovery

To protect your information, use Windows backup and restore utilities to back up individual files and folders, back up your entire hard drive, create system repair media (select models only) by using the installed optical drive (select models only) or an optional external optical drive, or create system restore points. In case of system failure, you can use the backup files to restore the contents of your computer.

From the Start screen, type `restore`, click **Settings**, and then select from the list of displayed options.

 **NOTE:** For detailed instructions on various backup and restore options, perform a search for these topics in Windows Help and Support.

In case of system instability, HP recommends that you print the recovery procedures and save them for later use.

 **NOTE:** Windows includes the User Account Control feature to improve the security of your computer. You may be prompted for your permission or password for tasks such as installing software, running utilities, or changing Windows settings. For more information, see Windows Help and Support.

Backing up your information

Recovery after a system failure is as good as your most recent backup. You should create system repair media and your initial backup immediately after initial system setup. As you add new software and data files, you should continue to back up your system on a regular basis to maintain a reasonably current backup.

For more information on the Windows backup features, see Windows Help and Support.

Performing a system recovery

In case of system failure or instability, the computer provides the following tools to recover your files:

- **Windows recovery tools:** You can use Windows Backup and Restore to recover information you have previously backed up. You can also use Windows Automatic Repair to fix problems that might prevent Windows from starting correctly.
- **f11 recovery tools:** You can use the **f11** recovery tools to recover your original hard drive image. The image includes the Windows operating system and software programs installed at the factory.

 **NOTE:** If you are unable to boot (start up) your computer and you cannot use the system repair media you previously created (select models only), you must purchase Windows operating system media to reboot the computer and repair the operating system. For additional information, see [Using Windows operating system media \(purchased separately\) on page 89](#).

Using the Windows recovery tools

To recover information you previously backed up, see Windows Help and Support for steps on restoring files and folders.

To recover your information using Automatic Repair, follow these steps:

 **CAUTION:** Some Startup Repair options will completely erase and reformat the hard drive. All files you have created and any software installed on the computer are permanently removed. When reformatting is complete, the recovery process restores the operating system, as well as the drivers, software, and utilities from the backup used for recovery.

1. If possible, back up all personal files.
2. If possible, check for the presence of the Recovery Image partition and the Windows partition.

From the Start screen, type `file`, and then click **File Explorer**.

– or –

From the Start screen, type `pc`, and then select **This PC**.

 **NOTE:** If the Windows partition and the Recovery Image partition are not listed, you must recover your operating system and programs using the Windows operating system DVD and the *Driver Recovery* media (both purchased separately). For additional information, see [Using Windows operating system media \(purchased separately\) on page 89](#).

3. If the Windows partition and the Recovery Image partition are listed, restart the computer by pressing and holding the `shift` key while clicking **Restart**.
4. Select **Troubleshoot**, then select **Advanced Options**, and then select **Startup Repair**.
5. Follow the on-screen instructions.

 **NOTE:** For additional information on recovering information using the Windows tools, perform a search for these topics in Windows Help and Support.

Using f11 recovery tools

 **CAUTION:** Using `f11` completely erases hard drive contents and reformats the hard drive. All files that you have created and any software that you have installed on the computer are permanently removed. The `f11` recovery tool reinstalls the operating system and HP programs and drivers that were installed at the factory. Software not installed at the factory must be reinstalled.

To recover the original hard drive image using **f11**:

1. If possible, back up all personal files.
2. If possible, check for the presence of the Recovery Image partition: From the Start screen, type **PC**, and then select **This PC**.

 **NOTE:** If the Recovery Image partition is not listed, you must recover your operating system and programs using the Windows operating system media and the *Driver Recovery* media (both purchased separately). For additional information, see [Using Windows operating system media \(purchased separately\) on page 89](#).

3. If the Recovery Image partition is listed, restart the computer, and then press **esc** while the “Press the ESC key for Startup Menu” message is displayed at the bottom of the screen.
4. Press **f11** while the “Press <F11> for recovery” message is displayed on the screen.
5. Follow the on-screen instructions.

Using Windows operating system media (purchased separately)

To order a Windows operating system DVD, contact support. See the *Worldwide Telephone Numbers* booklet included with the computer. You can also find contact information from the HP website. Go to <http://www.hp.com/support>, select your country or region, and follow the on-screen instructions.

 **CAUTION:** Using a Windows operating system media completely erases hard drive contents and reformats the hard drive. All files that you have created and any software that you have installed on the computer are permanently removed. When reformatting is complete, the recovery process helps you restore the operating system, as well as drivers, software, and utilities.

To initiate a full install of the operating system using a Windows operating system DVD:

 **NOTE:** This process takes several minutes.

1. If possible, back up all personal files.
2. Insert the Windows operating system DVD into the optical drive, and then restart the computer.
3. When prompted, press any keyboard key.
4. Follow the on-screen instructions.

After the installation is completed:

1. Eject the Windows operating system media and then insert the *Driver Recovery* media.
2. Install the Hardware Enabling Drivers first, and then install Recommended Applications.

Using Windows Refresh or Windows Reset

When your computer is not working properly and you need to regain system stability, the Windows Refresh option allows you to start fresh and keep what is important to you.

The Windows Reset option allows you to perform detailed reformatting of your computer, or remove personal information before you give away or recycle your computer. For more information on these features, see Windows Help and Support.

Using HP Software Setup

HP Software Setup can be used to reinstall drivers or select software that has been corrupted or deleted from the system.

1. From the Start screen, type `HP Software Setup`.
2. Open HP Software Setup.
3. Follow the on-screen directions to reinstall drivers or select software.

12 Computer Setup (BIOS), MultiBoot, and HP PC Hardware Diagnostics (UEFI)

Using Computer Setup

Computer Setup, or Basic Input/Output System (BIOS), controls communication between all the input and output devices on the system (such as disk drives, display, keyboard, mouse, and printer). Computer Setup includes settings for the types of devices installed, the startup sequence of the computer, and the amount of system and extended memory.

 **NOTE:** Use extreme care when making changes in Computer Setup. Errors can prevent the computer from operating properly.

Starting Computer Setup

 **NOTE:** An external keyboard or mouse connected to a USB port can be used with Computer Setup only if USB legacy support is enabled.

To start Computer Setup, follow these steps:

1. Turn on or restart the computer, and then press **esc** while the “Press the ESC key for Startup Menu” message is displayed at the bottom of the screen.
2. Press **f10** to enter Computer Setup.

Navigating and selecting in Computer Setup

To navigate and select in Computer Setup, follow these steps:

1. Turn on or restart the computer, and then press **esc** while the “Press the ESC key for Startup Menu” message is displayed at the bottom of the screen.

 **NOTE:** You can use either a pointing device (TouchPad, pointing stick, or USB mouse) or the keyboard to navigate and make selections in Computer Setup.

2. Press **f10** to enter Computer Setup.

- To select a menu or a menu item, use the **tab** key and the keyboard arrow keys and then press **enter**, or use a pointing device to click the item.
- To scroll up and down, click the up arrow or the down arrow in the upper-right corner of the screen, or use the up arrow key or the down arrow key on the keyboard.
- To close open dialog boxes and return to the main Computer Setup screen, press **esc**, and then follow the on-screen instructions.

To exit Computer Setup menus, choose one of the following methods:

- To exit Computer Setup menus without saving your changes:

Click the **Exit** icon in the lower-right corner of the screen, and then follow the on-screen instructions.

– or –

Use the arrow keys to select **Main > Ignore Changes and Exit**, and then press **enter**.

- To save your changes and exit Computer Setup menus:

Click the **Save** icon in the lower-right corner of the screen, and then follow the on-screen instructions.

– or –

Use the arrow keys to select **Main > Save Changes and Exit**, and then press **enter**.

Your changes go into effect when the computer restarts.

Restoring factory settings in Computer Setup

 **NOTE:** Restoring defaults will not change the hard drive mode.

To return all settings in Computer Setup to the values that were set at the factory, follow these steps:

1. Turn on or restart the computer, and then press **esc** while the “Press the ESC key for Startup Menu” message is displayed at the bottom of the screen.
2. Press **f10** to enter Computer Setup.
3. Use a pointing device or the arrow keys to select **Main > Restore Defaults**.
4. Follow the on-screen instructions.
5. To save your changes and exit, click the **Save** icon in the lower-right corner of the screen, and then follow the on-screen instructions.

– or –

Use the arrow keys to select **Main > Save Changes and Exit**, and then press **enter**.

Your changes go into effect when the computer restarts.

 **NOTE:** Your password settings and security settings are not changed when you restore the factory settings.

Updating the BIOS

Updated versions of the BIOS may be available on the HP website.

Most BIOS updates on the HP website are packaged in compressed files called *SoftPaqs*.

Some download packages contain a file named *Readme.txt*, which contains information regarding installing and troubleshooting the file.

Determining the BIOS version

To determine whether available BIOS updates contain later BIOS versions than those currently installed on the computer, you need to know the version of the system BIOS currently installed.

BIOS version information (also known as *ROM date* and *System BIOS*) can be revealed by pressing **fn+esc** (if you are already in Windows) or by using Computer Setup.

1. Start Computer Setup.
2. Use a pointing device or the arrow keys to select **Main > System Information**.
3. To exit Computer Setup without saving your changes, click the **Exit** icon in the lower-right corner of the screen, and then follow the on-screen instructions.

– or –

Use the arrow keys to select **Main > Ignore Changes and Exit**, and then press **enter**.

Downloading a BIOS update

 **CAUTION:** To reduce the risk of damage to the computer or an unsuccessful installation, download and install a BIOS update only when the computer is connected to reliable external power using the AC adapter. Do not download or install a BIOS update while the computer is running on battery power, docked in an optional docking device, or connected to an optional power source. During the download and installation, follow these instructions:

Do not disconnect power on the computer by unplugging the power cord from the AC outlet.

Do not shut down the computer or initiate Sleep.

Do not insert, remove, connect, or disconnect any device, cable, or cord.

1. From the Start screen, type `support`, and then select the HP Support Assistant app.
2. Click **Updates and tune-ups**, and then click **Check for HP updates now**.
3. Follow the on-screen instructions.
4. At the download area, follow these steps:
 - a. Identify the most recent BIOS update and compare it to the BIOS version currently installed on your computer. Make a note of the date, name, or other identifier. You may need this information to locate the update later, after it has been downloaded to your hard drive.
 - b. Follow the on-screen instructions to download your selection to the hard drive.

If the update is more recent than your BIOS, make a note of the path to the location on your hard drive where the BIOS update is downloaded. You will need to access this path when you are ready to install the update.

 **NOTE:** If you connect your computer to a network, consult the network administrator before installing any software updates, especially system BIOS updates.

BIOS installation procedures vary. Follow any instructions that are revealed on the screen after the download is complete. If no instructions are revealed, follow these steps:

1. From the Start screen, type `file`, and then select **File Explorer**.
2. Click your hard drive designation. The hard drive designation is typically Local Disk (C:).
3. Using the hard drive path you recorded earlier, open the folder on your hard drive that contains the update.
4. Double-click the file that has an `.exe` extension (for example, `filename.exe`).

The BIOS installation begins.

5. Complete the installation by following the on-screen instructions.

 **NOTE:** After a message on the screen reports a successful installation, you can delete the downloaded file from your hard drive.

Using MultiBoot

About the boot device order

As the computer starts, the system attempts to boot from enabled devices. The MultiBoot utility, which is enabled at the factory, controls the order in which the system selects a boot device. Boot devices can include optical drives, diskette drives, a network interface card (NIC), hard drives, and USB devices. Boot devices contain bootable media or files that the computer needs to start and operate properly.

 **NOTE:** Some boot devices must be enabled in Computer Setup before they can be included in the boot order.

You can change the order in which the computer searches for a boot device by changing the boot order in Computer Setup. You can also press `esc` while the “Press the ESC key for Startup Menu” message is displayed at the bottom of the screen, and then press `f9`. Pressing `f9` displays a menu that shows the current boot devices and allows you to select a boot device. Or, you can use MultiBoot Express to set the computer to prompt you for a boot location each time the computer turns on or restarts.

Choosing MultiBoot preferences

You can use MultiBoot in the following ways:

- To set a new boot order that the computer uses each time it is turned on, by changing the boot order in Computer Setup.
- To dynamically choose the boot device, by pressing `esc` while the “Press the ESC key for Startup Menu” message is displayed at the bottom of the screen, and then pressing `f9` to enter the Boot Device Options menu.
- To use MultiBoot Express to set variable boot orders. This feature prompts you for a boot device each time the computer is turned on or restarted.

Setting a new boot order in Computer Setup

To start Computer Setup and set a boot device order that the computer uses each time it is turned on or restarted, follow these steps:

1. Turn on or restart the computer, and then press **esc** while the “Press the ESC key for Startup Menu” message is displayed at the bottom of the screen.
2. Press **f10** to enter Computer Setup.
3. Use a pointing device or the arrow keys to select one of the following options:
 - **Advanced > Boot Options > UEFI Boot Order > UEFI Hybrid**
 - **Advanced > Boot Options > UEFI Boot Order > UEFI Native Boot mode**
 - **Advanced > Boot Options > Legacy Boot Order > Legacy Boot Mode**Press **enter**.
4. To move the device up in the boot order, use a pointing device to click the up arrow, or press the **+** key.

– or –

To move the device down in the boot order, use a pointing device to click the down arrow, or press the **-** key.
5. To save your changes and exit Computer Setup, click the **Save** icon in the lower-left corner of the screen, and then follow the on-screen instructions.

– or –

Use the arrow keys to select **Main > Save Changes and Exit**, and then press **enter**.

Dynamically choosing a boot device using the f9 prompt

To dynamically choose a boot device for the current startup sequence, follow these steps:

1. Open the Select Boot Device menu by turning on or restarting the computer, and then pressing **esc** while the “Press the ESC key for Startup Menu” message is displayed at the bottom of the screen.
2. Press **f9**.
3. Use a pointing device or the arrow keys to select a boot device, then press **enter**.

Setting a MultiBoot Express prompt

To start Computer Setup and set the computer to display the MultiBoot startup location menu each time the computer is started or restarted, follow these steps:

1. Turn on or restart the computer, and then press **esc** while the “Press the ESC key for Startup Menu” message is displayed at the bottom of the screen.
2. Press **f10** to enter Computer Setup.

3. Use a pointing device or the arrow keys to select **Advanced > Boot Options > MultiBoot Express Boot Popup Delay (Sec)**, and then press **enter**.
4. In the **MultiBoot Express Popup Delay (Sec)** field, enter the length of time in seconds that you want the computer to display the startup location menu before it defaults to the current MultiBoot setting. (When 0 is selected, the Express Boot startup location menu is not displayed.)
5. To save your changes and exit Computer Setup, click the **Save** icon in the lower-left corner of the screen, and then follow the on-screen instructions.

– or –

Use the arrow keys to select **Main > Save Changes and Exit**, and then press **enter**.

Your changes go into effect when the computer restarts.

Entering MultiBoot Express preferences

When the Express Boot menu is displayed during startup, you have the following choices:

- To specify a boot device from the Express Boot menu, select your preference within the allotted time, and then press **enter**.
- To prevent the computer from defaulting to the current MultiBoot setting, press any key before the allotted time expires. The computer will not start until you select a boot device and press **enter**.
- To allow the computer to start according to the current MultiBoot settings, wait for the allotted time to expire.

Using HP PC Hardware Diagnostics (UEFI)

HP PC Hardware Diagnostics is a Unified Extensible Firmware Interface (UEFI) that allows you to run diagnostic tests to determine whether the computer hardware is functioning properly. The tool runs outside the operating system so that it can isolate hardware failures from issues that are caused by the operating system or other software components.

To start HP PC Hardware Diagnostics UEFI:

1. Turn on or restart the computer, quickly press **esc**, and then press **f2**.

The BIOS searches three places for the diagnostic tools, in the following order:

- a. Connected USB drive



NOTE: To download the HP PC Hardware Diagnostics (UEFI) tool to a USB drive, see [Downloading HP PC Hardware Diagnostics \(UEFI\) to a USB device on page 97](#).

- b. Hard drive

- c. BIOS

2. When the diagnostic tool opens, use the keyboard arrow keys to select the type of diagnostic test you want to run, and then follow the on-screen instructions.



NOTE: If you need to stop a diagnostic test, press **esc**.

Downloading HP PC Hardware Diagnostics (UEFI) to a USB device



NOTE: Instructions for downloading HP PC Hardware Diagnostics (UEFI) are provided in English only.

There are two options to download HP PC Hardware Diagnostics to a USB device:

Option 1: HP PC Diagnostics homepage— Provides access to the latest UEFI version

1. Go to <http://hp.com/go/techcenter/pcdiags>.
2. Click the **UEFI Download** link, and then select **Run**.

Option 2: Support and Drivers page—Provides downloads for a specific product for earlier and later versions

1. Go to <http://www.hp.com>.
2. Point to **Support**, located at the top of the page, and then click **Download Drivers**.
3. In the text box, enter the product name, and then click **Go**.

– or –

Click **Find Now** to let HP automatically detect your product.

4. Select your computer model, and then select your operating system.
5. In the **Diagnostic** section, click **HP UEFI Support Environment**.

– or –

Click **Download**, and then select **Run**.

Using HP Sure Start

Select computer models are configured with HP Sure Start, a technology that continuously monitors your computer's BIOS for attacks or corruption. If the BIOS becomes corrupted or is attacked, HP Sure Start restores the BIOS to its previously safe state automatically, without user intervention. Your computer ships with HP Sure Start configured and enabled. Most users can use HP Sure Start with the default configuration.

For more information, go to <http://www.hp.com/support>, and then select your country. Select **Drivers & Downloads**, and then follow the on-screen instructions.

13 Support

Contacting support

If the information provided in this user guide or HP Support Assistant does not address your questions, you can contact support. For U.S. support, go to <http://www.hp.com/go/contactHP>. For worldwide support, go to http://welcome.hp.com/country/us/en/wwcontact_us.html.

Here you can:

- Chat online with an HP technician.



NOTE: When support chat is not available in a particular language, it is available in English.

- E-mail support.
- Find support telephone numbers.
- Locate an HP service center.

Labels

The labels affixed to the computer provide information you may need when you troubleshoot system problems or travel internationally with the computer:

 **IMPORTANT:** All labels described in this section will be located in one of 3 places depending on your computer model: affixed to the bottom of the computer, located in the battery bay, or under the service door.

- Service label—Provides important information to identify your computer. When contacting support, you will probably be asked for the serial number, and possibly for the product number or the model number. Locate these numbers before you contact support.

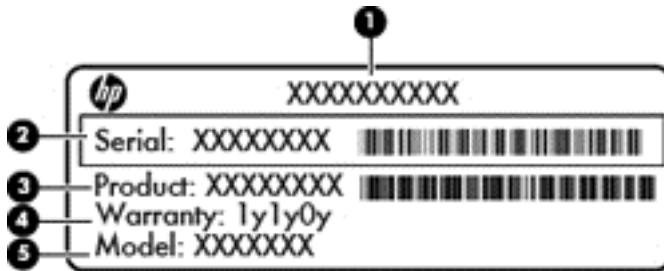

Component	
(1)	Product name
(2)	Serial number
(3)	Product number
(4)	Warranty period
(5)	Model description (select models only)

- Microsoft® Certificate of Authenticity label (select models only prior to Windows 8)—Contains the Windows Product Key. You may need the Product Key to update or troubleshoot the operating system. HP platforms preinstalled with Windows 8 or Windows 8.1 do not have the physical label, but have a Digital Product Key electronically installed.

 **NOTE:** This Digital Product Key is automatically recognized and activated by Microsoft Operating Systems on a reinstall of the Windows 8 or Windows 8.1 operating system with HP-approved recovery methods.

- Regulatory label(s)—Provide(s) regulatory information about the computer.
- Wireless certification label(s)—Provide(s) information about optional wireless devices and the approval markings of some of the countries or regions in which the devices have been approved for use.

14 Specifications

- [Input power](#)
- [Operating environment](#)

Input power

The power information in this section may be helpful if you plan to travel internationally with the computer.

The computer operates on DC power, which can be supplied by an AC or a DC power source. The AC power source must be rated at 100–240 V, 50–60 Hz. Although the computer can be powered from a standalone DC power source, it should be powered only with an AC adapter or a DC power source supplied and approved by HP for use with this computer.

The computer can operate on DC power within the following specifications.

Input Power	Rating
Operating voltage and current	19.5 V dc @ 7.69 A – 150 W, Slim Smart AC Adapter (select models only)
	19.5 V dc @ 10.3 A — 200 W, Slim Smart AC Adapter (select models only)

 **NOTE:** This product is designed for IT power systems in Norway with phase-to-phase voltage not exceeding 240 V rms.

 **NOTE:** The computer operating voltage and current can be found on the system regulatory label.

Operating environment

Factor	Metric	U.S.
Temperature		
Operating (writing to optical disc)	5°C to 35°C	41°F to 95°F
Nonoperating	-20°C to 60°C	-4°F to 140°F
Relative humidity (noncondensing)		
Operating	10% to 90%	10% to 90%
Nonoperating	5% to 95%	5% to 95%
Maximum altitude (unpressurized)		
Operating	-15 m to 3,048 m	-50 ft to 10,000 ft
Nonoperating	-15 m to 12,192 m	-50 ft to 40,000 ft

A Traveling with the computer

For best results, follow these traveling and shipping tips:

- Prepare the computer for traveling or shipping:
 - Back up your information.
 - Remove all discs and all external media cards, such as memory cards.
- ⚠ **CAUTION:** To reduce the risk of damage to the computer, damage to a drive, or loss of information, remove the media from a drive before removing the drive from a drive bay and before shipping, storing, or traveling with a drive.
- Turn off and then disconnect all external devices.
- Shut down the computer.
- Take along a backup of your information. Keep the backup separate on the computer.
- When traveling by air, carry the computer as hand luggage; do not check it in with the rest of your bags.
- ⚠ **CAUTION:** Avoid exposing a drive to magnetic fields. Security devices with magnetic fields include airport walk-through devices and security wands. Airport conveyer belts and similar security devices that check carry-on baggage use X-rays instead of magnetism and do not damage drives.
- In-flight computer use is at the discretion of the airline. If you plan to use the computer during a flight, check with the airline in advance.
- If the computer will be unused and disconnected from external power for more than 2 weeks, remove the battery and store it separately.
- If you are shipping the computer or a drive, use suitable protective packaging and label the package “FRAGILE.”
- If the computer has a wireless device or an HP Mobile Broadband Module installed, such as an 802.11b/g device, a Global System for Mobile Communications (GSM) device, or a General Packet Radio Service (GPRS) device, the use of these devices may be restricted in some environments. Such restrictions may apply aboard aircraft, in hospitals, near explosives, and in hazardous locations. If you are uncertain of the policy that applies to the use of a particular device, ask for authorization to use it before you turn it on.
- If you are traveling internationally, follow these suggestions:

- Check the computer-related customs regulations for each country or region on your itinerary.
- Check the power cord and adapter requirements for each location in which you plan to use the computer. Voltage, frequency, and plug configurations vary.

 **WARNING!** To reduce the risk of electric shock, fire, or damage to the equipment, do not attempt to power the computer with a voltage converter kit sold for appliances.

B Troubleshooting

Troubleshooting resources

- Access website links and additional information about the computer through HP Support Assistant. To access HP Support Assistant, from the Start screen, select the **HP Support Assistant** app.

 **NOTE:** Some checkup and repair tools require an Internet connection. HP also provides additional tools that do not require an Internet connection.

- Contact HP support. For U.S. support, go to <http://www.hp.com/go/contactHP>. For worldwide support, go to http://welcome.hp.com/country/us/en/wwcontact_us.html.

Choose from the following types of support:

- Chat online with an HP technician.

 **NOTE:** When chat is not available in a particular language, it is available in English.

- E-mail HP support.
- Find HP support worldwide telephone numbers.
- Locate an HP service center.

Resolving issues

The following sections describe several common issues and solutions.

The computer is unable to start up

If the computer does not turn on when you press the power button, the following suggestions may help you determine why the computer does not start up:

- If the computer is plugged into an AC outlet, plug another electrical device into the outlet to be sure that the outlet is providing adequate power.

 **NOTE:** Use only the AC adapter provided with the computer or one approved by HP for this computer.

- If the computer is plugged into an external power source other than an AC outlet, plug the computer into an AC outlet using the AC adapter. Be sure that the power cord and AC adapter connections are secure.

The computer screen is blank

If the screen is blank but you have not turned off the computer, one or more of these settings may be the cause:

- The computer may be in the Sleep state. To exit Sleep, briefly press the power button. Sleep is an energy-saving feature that turns off the display. Sleep can be initiated by the system while the computer is on but is not in use, or when the computer has reached a low battery level. To change these and other power settings, right-click the **Battery** icon on the Windows desktop in the notification area, at the far right of the taskbar, and then click **Preferences**.
- The computer may not be set to display the image on the computer screen. To transfer the image to the computer screen, press **fn+f4**. On most models, when an optional external display, such as a monitor, is connected to the computer, the image can be displayed on the computer screen or the external display, or on both devices simultaneously. When you press **fn+f4** repeatedly, the image alternates among the computer display, one or more external displays, and simultaneous display on all devices.

Software is functioning abnormally

If the software is unresponsive or responds abnormally, restart the computer by pointing to the right side of the screen. When the charms display, click **Settings**. Click the **Power** icon, and then click **Shut down**. If you cannot restart the computer using this procedure, see the next section, [The computer is on but not responding on page 106](#).

The computer is on but not responding

If the computer is turned on but is not responding to software or keyboard commands, try the following emergency shutdown procedures, in the sequence provided, until shutdown occurs:

 **CAUTION:** Emergency shutdown procedures result in the loss of unsaved information.

- Press and hold the power button for at least 5 seconds.
- Disconnect the computer from external power and remove the battery.

The computer is unusually warm

It is normal for the computer to feel warm to the touch while it is in use. But if the computer feels *unusually* warm, it may be overheating because a vent is blocked.

If you suspect that the computer is overheating, allow the computer to cool to room temperature. Be sure to keep all vents free from obstructions while you are using the computer.

 **WARNING!** To reduce the possibility of heat-related injuries or of overheating the computer, do not place the computer directly on your lap or obstruct the computer air vents. Use the computer only on a hard, flat surface. Do not allow another hard surface, such as an adjoining optional printer, or a soft surface, such as pillows or rugs or clothing, to block airflow. Also, do not allow the AC adapter to contact the skin or a soft surface, such as pillows or rugs or clothing, during operation. The computer and the AC adapter comply with the user-accessible surface temperature limits defined by the International Standard for Safety of Information Technology Equipment (IEC 60950).

 **NOTE:** The fan in the computer starts up automatically to cool internal components and prevent overheating. It is normal for the internal fan to cycle on and off during operation.

An external device is not working

Follow these suggestions if an external device does not function as expected:

- Turn on the device according to the manufacturer's instructions.
- Be sure that all device connections are secure.
- Be sure that the device is receiving electrical power.
- Be sure that the device, especially if it is older, is compatible with the operating system.
- Be sure that the correct drivers are installed and updated.

The wireless network connection is not working

If a wireless network connection is not working as expected, follow these suggestions:

- To enable or disable a wireless or wired network device, right-click the **Network Connection** icon on the Windows desktop in the notification area, at the far right of the taskbar. To enable devices, select the check box from the menu option. To disable the device, clear the check box.
- Be sure that the wireless device is turned on.
- Be sure that the computer wireless antennas are free from obstructions.
- Be sure that the cable or DSL modem and its power cord are properly connected and that the lights are on.
- Be sure that the wireless router or access point is properly connected to its power adapter and to the cable or DSL modem, and that the lights are on.
- Disconnect and then reconnect all cables, and turn the power off and then back on.

A disc does not play

- Save your work and close all open programs before playing a CD or a DVD.
- Log off the Internet before playing a CD or a DVD.
- Be sure that you insert the disc properly.
- Be sure that the disc is clean. If necessary, clean the disc with filtered water and a lint-free cloth. Wipe from the center of the disc to the outer edge.
- Check the disc for scratches. If you find scratches, treat the disc with an optical disc repair kit available at many electronics stores.
- Disable Sleep mode before playing the disc.

Do not initiate Sleep while playing a disc. Otherwise, you may see a warning message asking if you want to continue. If this message is displayed, click **No**. After you click No, the computer may behave in either of the following ways:

- Playback may resume.

– or –

- The playback window in the multimedia program may close. To return to playing the disc, click the **Play** button in your multimedia program to restart the disc. In rare cases, you may need to exit the program and then restart it.

A movie is not visible on an external display

1. If both the computer display and an external display are turned on, press **fn+f4** one or more times to switch between the 2 displays.
2. Configure the monitor settings to make the external display primary:
 - a. From the Windows desktop, right-click on a blank area of the computer desktop, and select **Screen resolution**.
 - b. Specify a primary display and a secondary display.

 **NOTE:** When using both displays, the DVD image will not appear on any display designated as the secondary display.

When an external display is connected to the Thunderbolt port, the DVD image will appear on any connected displays.

The process of burning a disc does not begin, or it stops before completion

- Be sure that all other programs are closed.
- Turn off Sleep mode.
- Be sure that you are using the right kind of disc for your drive.
- Be sure that the disc is inserted properly.
- Select a slower write speed and try again.
- If you are copying a disc, save the information on the source disc to your hard drive before trying to burn the contents to a new disc, and then burn from your hard drive.

C Electrostatic discharge

Electrostatic discharge is the release of static electricity when two objects come into contact—for example, the shock you receive when you walk across the carpet and touch a metal door knob.

A discharge of static electricity from fingers or other electrostatic conductors may damage electronic components. To prevent damage to the computer, damage to a drive, or loss of information, observe these precautions:

- If removal or installation instructions direct you to unplug the computer, unplug it after being properly grounded and before removing a cover.
- Keep components in their electrostatic-safe containers until you are ready to install them.
- Avoid touching pins, leads, and circuitry. Handle electronic components as little as possible.
- Use nonmagnetic tools.
- Before handling components, discharge static electricity by touching an unpainted metal surface of the component.
- If you remove a component, place it in an electrostatic-safe container.

If you need more information about static electricity or assistance with component removal or installation, contact HP support.

Index

Symbols/Numerics

2-finger pinch zoom TouchPad gesture 29

A

AC adapter, testing 50
AC adapter/battery light 18
accessory battery connector, identifying 15
administrator password 70
airport security devices 61
AMD Dual Graphics 51
AMD graphics controller, using 40
antivirus software 77
audio functions, checking 36
audio-in (microphone) jack, identifying 5
audio-out (headphone) jack, identifying 5
Automatic DriveLock password entering 75 removing 76

B

battery
 conserving power 49
 discharging 47
 displaying remaining charge 47
 disposing 49
 low battery levels 47
 replacing 50
 storing 49
battery bay 100
Battery Check 47
battery cover, identifying 15
battery information, finding 45
battery power 45

battery release latch 15
battery temperature 49
BIOS
 determining version 93
 downloading an update 93
 updating 93
Bluetooth device 19, 24
Bluetooth label 100
buttons
 center TouchPad 10
 left pointing stick 10
 left TouchPad 10
 media 35
 optical drive eject 6
 power 13, 43
 right pointing stick 10
 right TouchPad 10
 volume 35

C

cables
 USB 58
caps lock light, identifying 11
caring for your computer 83
Center TouchPad button 10
checking audio functions 36
cleaning your computer 83
components
 bottom 15
 display 9
 front 17
 left side 7
 rear 18
 right side 5
 top 10
Computer Setup
 BIOS administrator password 71
 DriveLock password 72

 navigating and selecting 91
 restoring factory settings 92
computer, traveling 49, 103
configuring
 ExpressCards 54
connecting to a WLAN 22
connector
 power 18
connector, docking 59
conservation, power 49
corporate WLAN connection 22
critical battery level 44
critical updates, software 78

D

Disk Cleanup software 66
Disk Defragmenter software 65
display image, switching 33
DisplayPort
 connecting 38
 connecting wired displays 40
 Dual-Mode 7
 Thunderbolt 7
docking connector 59
docking connector, identifying 15
drive media 44
DriveLock password
 changing 74
 description 72
 entering 74
 removing 74
 setting 73
drives
 external 59
 handling 61
 hard 59
 optical 59
 using 62

Dual-Mode DisplayPort,
identifying 7

E

electrostatic discharge 109
esc key, identifying 14
ExpressCard
 configuring 54
 defined 54
 inserting 54
 removing 56
 removing insert 55
ExpressCard slot 8
external AC power, using 50
external devices 58
external drive 59
external monitor port 6, 38

F

f11 recovery 88
Face Recognition 37
fingerprint reader 79
fingerprint reader, identifying 13
firewall software 77
fn key, identifying 14, 33
function keys, identifying 14

G

GPS 24
graphics
 AMD Dual Graphics 51
 Hybrid Graphics 51

H

hard drive
 external 59
 HP 3D DriveGuard 66
 installing 64
 removing 63
hard drive light 17, 66
hard drive recovery 88
hard drive, identifying 16
headphone (audio-out) jack 5
headphones and microphones,
 connecting 36
Hibernation
 exiting 44
 initiating 44
high-definition devices,
 connecting 41

hot keys

 adjusting volume 33
 decrease screen brightness
 33
 decreasing speaker sound 33
 description 33
 increase screen brightness 34
 increasing speaker sound 33
 keyboard backlight 34
 Sleep 33
 switching screen image 33
 using 33

hot keys, media 35

HP 3D DriveGuard 66

HP Client Security 78

HP Mobile Broadband, disabled
23

HP PC Hardware Diagnostics
(UEFI)

 downloading 97

 using 96

HP Sure Start, using 98

hubs 57

Hybrid Graphics 51

I

input power 101
integrated numeric keypad,
 identifying 14, 34
integrated webcam light,
 identifying 9
internal display switch 9
internal microphones, identifying
9
Internet connection setup 21
issues, resolving 105

J

jacks
 audio-in (microphone) 5
 audio-out (headphone) 5
 network 18
 RJ-45 (network) 18
Java Card
 defined 56
 inserting 56
 removing 57

K

keyboard backlight 34
keyboard hot keys, identifying 33

keypad

 integrated numeric 14
keypad, external
 num lock 34
 using 34
keypads, identifying 34
keys
 esc 14
 fn 14
 function 14
 media 35
 volume 35
 Windows key 14

L

labels

 Bluetooth 100
 Microsoft Certificate of
 Authenticity 100
 regulatory 100
 serial number 100
 wireless certification 100
 WLAN 100

latch, battery release 15

latches, service door release 15

legacy support, USB 91

lights

 AC adapter/battery 17, 18
 caps lock 11
 hard drive 17
 microphone mute 11
 num lock 11
 optical drive 17
 power 11, 17
 RJ-45 (network) 18
 webcam 9
 wireless 12, 17

lights, hard drive 66

low battery level 47

M

maintenance

 Disk Cleanup 66
 Disk Defragmenter 65
media activity controls 35
media hot keys 35
memory card 44
 inserting 53
 removing 53
 supported formats 53

- memory card reader, identifying 5
 - memory module
 - identifying 16
 - inserting 82
 - removing 81
 - replacing 81
 - microphone (audio-in) jack, identifying 5
 - microphone mute light, identifying 11
 - Microsoft Certificate of Authenticity label 100
 - Miracast 41
 - mouse, external
 - setting preferences 27
 - MultiStream Transport technology, using 40
- N**
- network jack, identifying 18
 - num lock key, identifying 34
 - num lock light 11
 - num lock, external keypad 34
 - Nvidia graphics controller, using 40
- O**
- operating environment 102
 - optical drive 59
 - optical drive eject button, identifying 6
 - optical drive, identifying 6
 - optional external devices, using 58
- P**
- passwords
 - administrator 70
 - BIOS administrator 71
 - DriveLock 72
 - user 70
 - pointing devices, setting preferences 27
 - pointing stick 10
 - ports
 - DisplayPort 38
 - external monitor 6, 38
 - Miracast 41
 - USB 2.0 7
 - USB 3.0 18
 - USB 3.0 charging (powered) 7
 - VGA 38
 - power
 - battery 45
 - conserving 49
 - options 44
 - power button 43
 - power button, identifying 13
 - power connector, identifying 18
 - power lights 11, 17
 - power switch 43
 - power-saving states 44
 - product name and number, computer 100
 - public WLAN connection 22
- R**
- RAID 66
 - readable media 44
 - recovery 90
 - recovery partition 88
 - refresh 90
 - regulatory information
 - regulatory label 100
 - wireless certification labels 100
 - reset 90
 - restoring the hard drive 88
 - RJ-45 (network) jack, identifying 18
 - RJ-45 (network) lights, identifying 18
 - rotating TouchPad gesture 30
- S**
- screen brightness keys 34
 - screen image, switching 33
 - scrolling TouchPad gesture 29
 - security cable slot, identifying 7
 - security, wireless 21
 - serial number 100
 - serial number, computer 100
 - service door release latch 15
 - service door release lock 15
 - setting password protection on wakeup 45
 - setting power options 44
 - setup of WLAN 21
- setup utility**
- navigating and selecting 91
 - restoring factory settings 92
- shutdown 43
- SIM
- inserting 23
- SIM slot, identifying 15
- Sleep
- exiting 44
 - initiating 44
- slots
- ExpressCard 8
 - security cable 7
 - SIM 15
 - smart card 8
- smart card
- defined 56
 - inserting 56
 - removing 57
- Smart card reader 8
- smart card slot 8
- SoftPaqs, downloading 85
- software
- antivirus 77
 - critical updates 78
 - Disk Cleanup 66
 - Disk Defragmenter 65
 - firewall 77
- speakers, identifying 13
- storing a battery 49
- switch, power 43
- T**
- temperature 49
 - testing an AC adapter 50
 - Thunderbolt DisplayPort
 - connecting 39
 - identifying 7
 - TouchPad
 - buttons 10
 - using 27
 - TouchPad gestures
 - 2-finger pinch zoom 29
 - rotating 30
 - scrolling 29
 - TouchPad zone
 - identifying 10
 - TPM Embedded Security 76
 - traveling with the computer 49, 100, 103

- troubleshooting
 - disc burning 108
 - disc play 107
- troubleshooting, external display 108
- turning off the computer 43

U

- unresponsive system 43
- upgrade bay, identifying 6
- USB 2.0 port 7
- USB 3.0 charging (powered), identifying 7
- USB 3.0 port 5
- USB cable, connecting 58
- USB devices
 - connecting 58
 - description 57
 - removing 58
- USB hubs 57
- USB legacy support 91
- USB port, identifying 18
- USB ports, identifying 5
- user password 70
- using
 - external AC power 50
 - power-saving states 44

V

- vents, identifying 7, 16
- VGA port, connecting 38
- video 37
- volume
 - adjusting 35
 - buttons 35
 - keys 35
- volume keys, identifying 33

W

- webcam 9, 37
- webcam light, identifying 9
- webcam, identifying 9
- Windows
 - Refresh 90
 - Reset 90
- Windows key, identifying 14
- Windows operating system DVD 89
- wired displays, connecting 40
- wireless antennas, identifying 9
- wireless button 19

- wireless certification label 100
- wireless controls
 - button 19
 - operating system 19
- wireless light 12, 17, 19
- wireless network (WLAN)
 - connecting 22
 - corporate WLAN connection 22
 - equipment needed 21
 - functional range 22
 - public WLAN connection 22
 - security 21
 - using 20
- WLAN antennas, identifying 9
- WLAN device 20, 100
- WLAN label 100
- writable media 44
- WWAN antennas, identifying 9
- WWAN device 19, 22