



## English

- Read **Safety and Reference**.
- For the power supply and power consumption, refer to the label attached to the product.

## Български

- Прочетете **Безопасност и справки**.
- Направете справка с етикета на продукта за електрозахранването и консумацията на енергия.

## Français

- Lire le document **Sécurité et référence**.
- Reportez-vous à l'étiquette apposée sur le téléviseur pour connaître l'alimentation et la consommation électriques.

## Ελληνικά

- Ανάγνωση **Ασφάλεια και αναφορά**.
- Για πληροφορίες σχετικά με την τροφοδοσία και την κατανάλωση ενέργειας, δείτε την ετικέτα του προϊόντος.

## Italiano

- Consultare la sezione **Sicurezza e informazioni di riferimento**.
- Per l'alimentazione e il consumo di energia, consultare l'etichetta applicata sul prodotto.

## Português

- Consulte o manual de **Segurança e Referência**.
- No que respeita à fonte de alimentação e ao consumo de energia, consulte a etiqueta mostrada no produto.

## Русский

- Прочтите **Руководство по технике безопасности**.
- Требования параметров электропитания и значения потребляемой мощности указаны на информационном лейбле на задней крышке изделия.

## Hrvatski

- Pročitajte **Sigurnost i reference**.
- Informacije o napajanju i potrošnji energije potražite na oznaci koja se nalazi na proizvodu.

## Español

- Leer **Seguridad y Referencias**.
- Para obtener información acerca de la fuente de alimentación y el consumo de energía, consulte la etiqueta del producto.

## Українська

- Прочитайте **Правила безпеки та довідкова інформація**.
- Відомості щодо подачі живлення і споживання електроенергії дивіться на наліпці на виробі.

## العربية

- قراءة السلامة والمرجع.
- لمعرفة المزيد حول مصدر الإمداد بالطاقة ومعايير استهلاك الطاقة، راجع الملصق الموجود على المنتج.

## Česky

- Přečtěte si část **Bezpečnost a reference**.
- Informace o napájení a příkonu naleznete na štítku připevněném k výrobku.

## Deutsch

- **Sicherheitshinweise und Referenzen:** Bitte lesen!
- Informationen zur Stromversorgung und zum Stromverbrauch sind dem Etikett auf dem Gerät zu entnehmen.

## Magyar

- Lásd: **Biztonsági óvintézkedések**.
- A tápellátásra és az áramfogyasztásra vonatkozó adatok a készülékre ragasztott címkén találhatóak.

## Polski

- Przeczytaj **Zasady bezpieczeństwa i informacje dodatkowe**.
- Dokładne informacje o zasilaniu i zużyciu energii są umieszczone na etykiecie znajdującej się na produkcie.

## Română

- Citiți **Siguranță și referințe**.
- Pentru sursa de alimentare și consumul de energie, consultați eticheta atașată pe produs.

## Srpski

- Pročitajte **Bezbednost i informacije**.
- Da biste saznali informacije u vezi sa napajanjem i potrošnjom energije, pogledajte oznaku na proizvodu.

## Slovenščina

- Preberite **Varnostne informacije in napotki**.
- Podatke o napajanju in porabi energije si oglejte na nalepki izdelka.

## Türkçe

- **Güvenlik ve Referans** bölümünü okuyun.
- Güç kaynağı ve güç tüketimi için ürüne yapıştirilmiş olan etikete bakın.

## O'zbekcha

- **Xavfsizlik bo'yicha ko'rsatmalar va havolalar** o'qib chiqing.
- Quvvat ta'minoti va quvvat iste'moli uchun mahsulotga yopishtirilgan yorliqqa qarang.

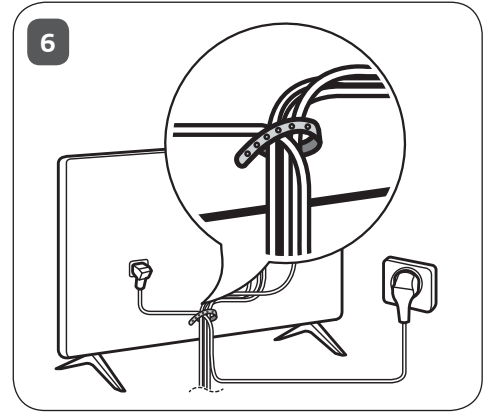
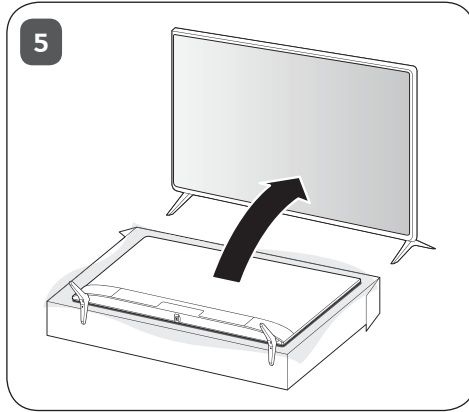
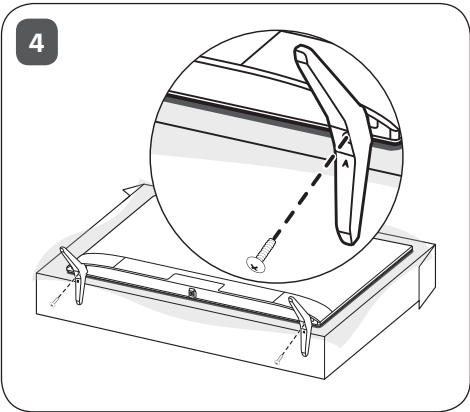
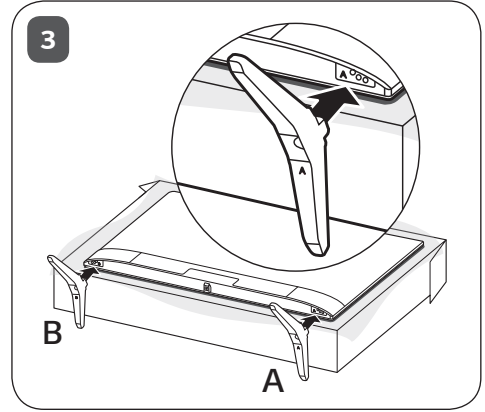
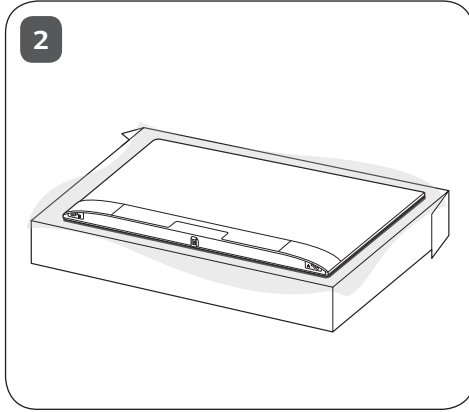
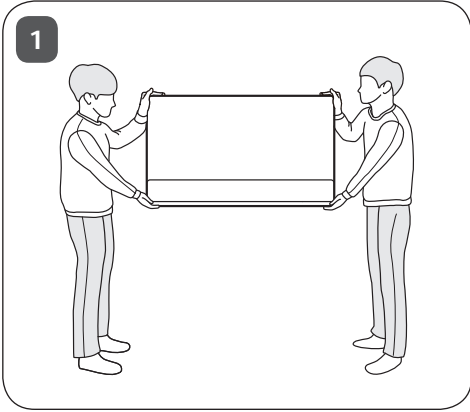

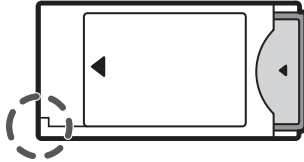
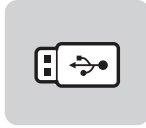
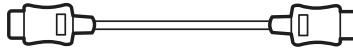
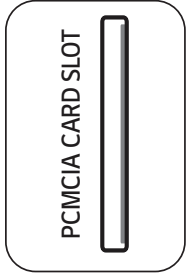
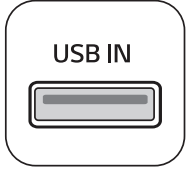
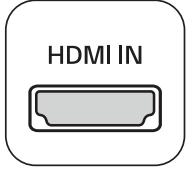
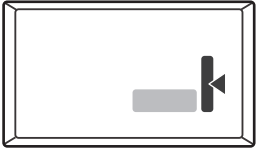

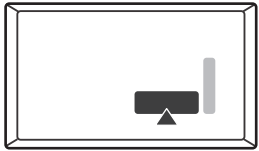

ANTENNA/  
CABLE IN

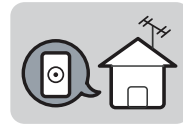
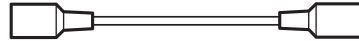
A circular port with a raised outer ring and a smaller inner circle, used for antenna or cable connections.

Satellite IN

A circular port with a central hole and a raised outer ring, specifically for satellite dish connections.

HDMI IN

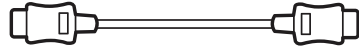
A rectangular port with a trapezoidal shape and a small notch, used for HDMI connections.

OPTICAL  
DIGITAL  
AUDIO OUT

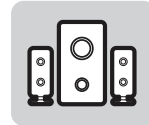
A square port with a small square opening in the center, used for optical digital audio output.

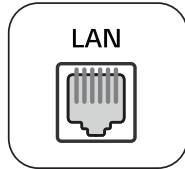
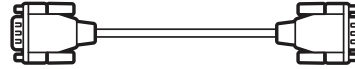
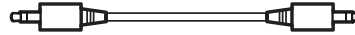
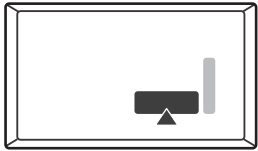

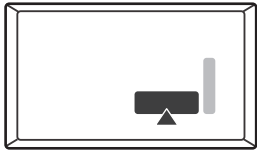

### COMPONENT IN

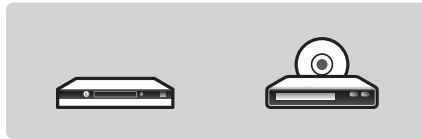
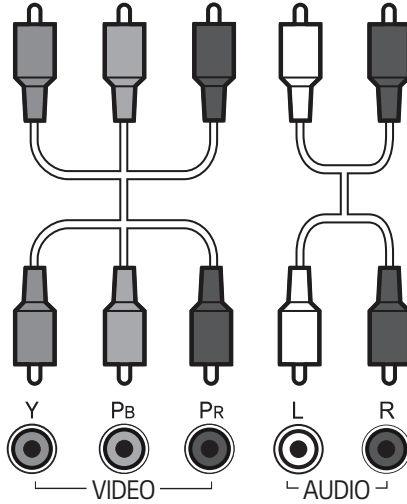
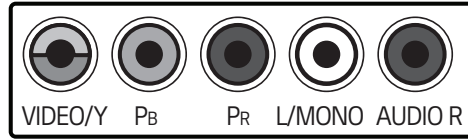

### AV IN

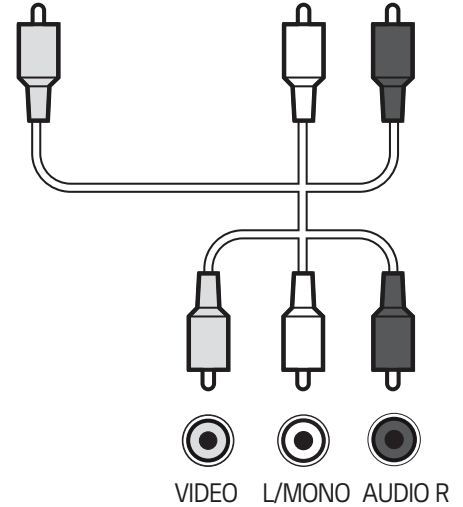
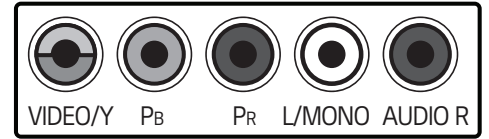

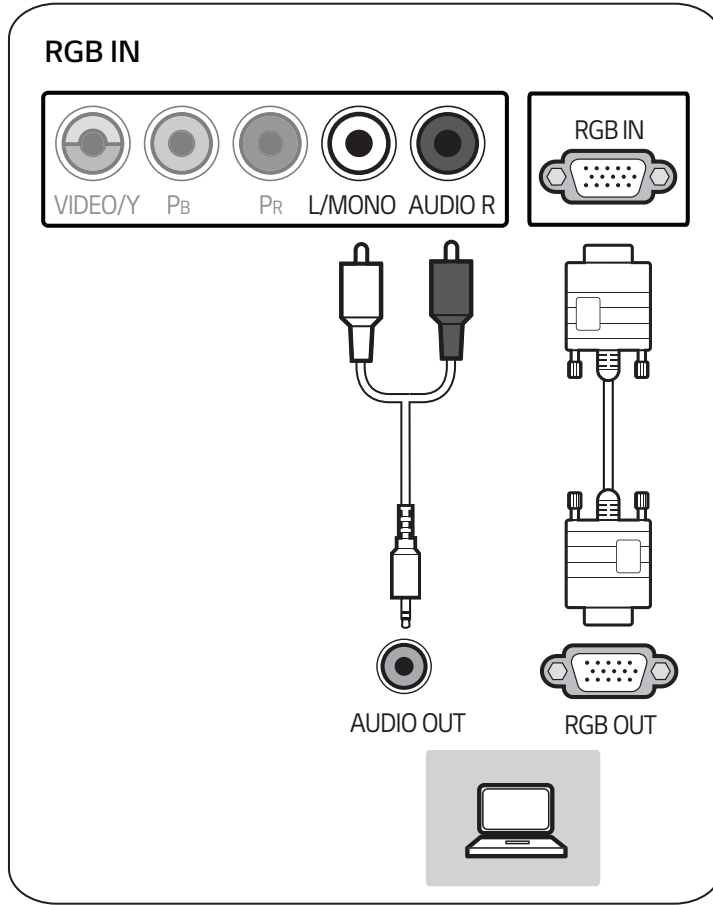
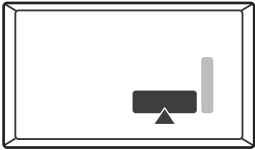



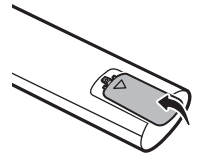
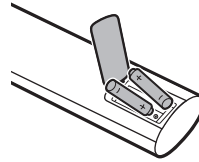
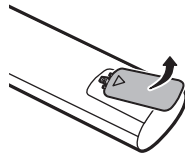
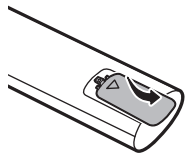
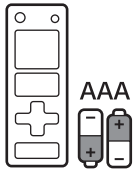

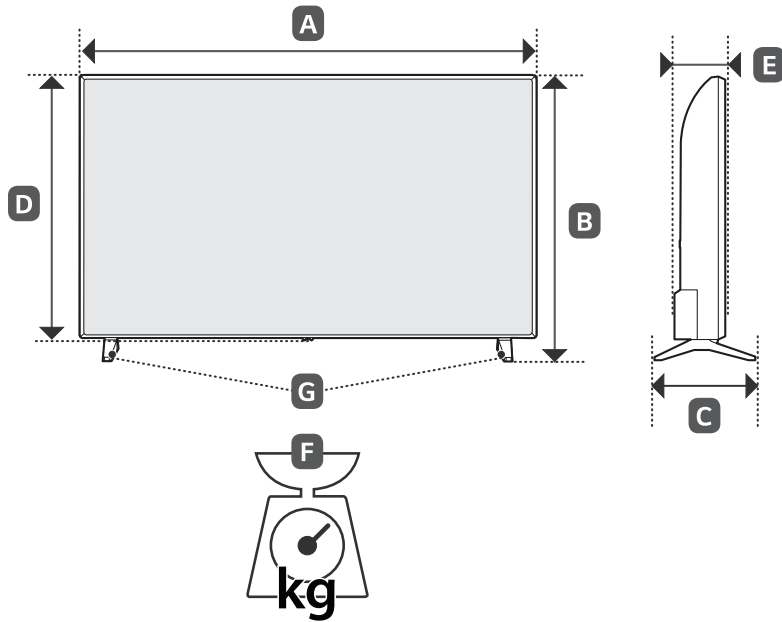

	A	B	C	D	E	F	F - G
	(mm)					(kg)	
32LT340CBZB	739	472	168	441	84	4.90	4.85
43LT340C0ZB	977	615	187	575	80.8	8.1	8.0
Power requirement					AC 100-240 V ~ 50 / 60 Hz		