

Ultra Short-Throw Laser Projector User's Manual

XGA/WXGA/1080P

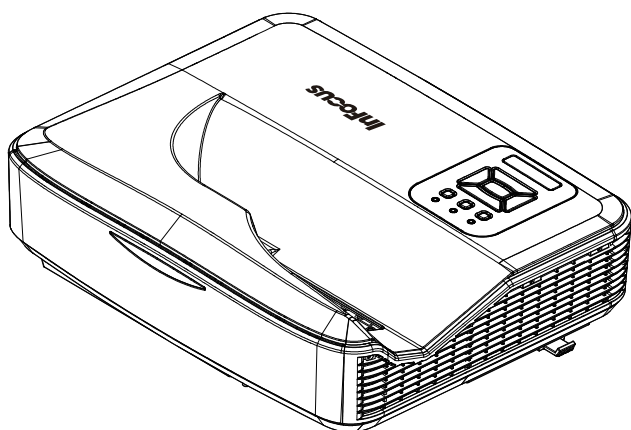



Table of Contents

Table of Contents	2	EZ View.....	49
Usage Notice	3	Crestron	54
Safety Information.....	3	Multimedia	57
Precautions.....	4	Accessing Multimedia Files	57
Introduction.....	6	How to access Multimedia mode.....	57
Package Overview.....	6	Appendices.....	61
Product Overview	7	Compatibility Modes	61
Main Unit.....	7	VGA Analog	61
Control Panel.....	8	HDMI Digital.....	63
Input/Output Connections.....	9	RS232 Commands and Protocol	
Remote Control.....	10	Function List	65
Installation	11	RS232 Port Settings	65
Connecting the Projector	11	RS232 Signals Connection.....	65
Connect to Computer/Notebook	11	Set Commands.....	66
Connect to Video Sources.....	12	Ceiling Mount Installation.....	69
Powering the Projector On / Off.....	13	Regulation & Safety Notices	70
Powering On the Projector.....	13		
Powering Off the Projector.....	14		
Warning Indicator.....	14		
LED Lighting Message.....	15		
Adjusting the Projected Image	16		
Adjusting the Projector's Height	16		
Adjusting the Projector's Focus	17		
Adjusting Projection Image Size			
(Diagonal)	18		
User Controls	24		
Control Panel & Remote Control	24		
Control Panel.....	24		
Remote Control.....	25		
On-screen Display Menus	27		
How to operate	27		
Image.....	28		
Configuration	30		
Settings.....	33		
Audio.....	35		
Options	36		
Options Laser Settings	38		
3D	39		
Blending mode.....	40		
LAN.....	41		

Usage Notice

Safety Information

	The lightning flash with arrow head within an equilateral triangle is intended to alert the user to the presence of uninsulated "dangerous voltage" within the product's enclosure that may be of sufficient magnitude to constitute a risk of electric shock to persons.
	The exclamation point within an equilateral triangle is intended to alert the user to the presence of important operating and maintenance (servicing) instructions in the literature accompanying the appliance.

WARNING: TO REDUCE THE RISK OF FIRE OR ELECTRIC SHOCK, DO NOT EXPOSE THIS APPLIANCE TO RAIN OR MOISTURE. DANGEROUS HIGH VOLTAGES ARE PRESENT INSIDE THE ENCLOSURE. DO NOT OPEN THE CABINET. REFER SERVICING TO QUALIFIED PERSONNEL ONLY.

Class B emissions limits

This Class B digital apparatus meets all requirements of the Canadian Interference-Causing Equipment Regulations.

Important Safety Instruction

1. Do not block any ventilation openings. To ensure reliable operation of the projector and to protect from over heating, it is recommended to install the projector in a location that does not block ventilation. As an example, do not place the projector on a crowded coffee table, sofa, bed, etc. Do not put the projector in an enclosure such as a book case or a cabinet that restricts air flow.
2. Do not use the projector near water or moisture. To reduce the risk of fire and/or electric shock, do not expose the projector to rain or moisture.
3. Do not install near heat sources such as radiators, heaters, stoves or any other apparatus such as amplifiers that emits heat.
4. Clean only with dry cloth.
5. Only use attachments/accessories specified by the manufacturer.
6. Do not use the unit if it has been physically damaged or abused.
Physical damage/abuse would be (but not limited to):
 - Unit has been dropped.
 - Power supply cord or plug has been damaged.
 - Liquid has been spilled on to the projector.
 - Projector has been exposed to rain or moisture.
 - Something has fallen in the projector or something is loose inside.Do not attempt to service the unit yourself. Opening or removing covers may expose you to dangerous voltages or other hazards.
7. Do not let objects or liquids enter the projector. They may touch dangerous voltage points and short out parts that could result in fire or electric shock.
8. See projector enclosure for safety related markings.
9. The unit should only be repaired by appropriate service personnel.

Precautions



Please follow all warnings, precautions and maintenance as recommended in this user's guide.

- Warning- Do not look into the projector's lens when the laser is on. The bright light may hurt and damage your eyes.

- Warning- To reduce the risk of fire or electric shock, do not expose this projector to rain or moisture.

- Warning- Please do not open or disassemble the projector as this may cause electric shock.

Usage Notice

Do:

- ❖ Turn off and unplug the power plug from the AC outlet before cleaning the product.
- ❖ Use a soft dry cloth with mild detergent to clean the display housing.
- ❖ Disconnect the power plug from AC outlet if the product is not being used for a long period of time.

Do not:

- ❖ Block the slots and openings on the unit provided for ventilation.
- ❖ Use abrasive cleaners, waxes or solvents to clean the unit.
- ❖ Do not operate the projector under the following conditions:
 - In extremely hot, cold or humid environments.
 - ▶ Sea level to 6000 feet
Extremely hot: > 35°C
Extremely cool: < 5°C
 - ▶ 6000 feet above
Extremely hot: > 30°C
Extremely cool: < 5°C
 - ▶ Extremely humid: > 70% R.H. (Relative Humidity)
 - In areas susceptible to excessive dust and dirt.
 - Near any appliance generating a strong magnetic field.
 - In direct sunlight.

Introduction

Package Overview

Unpack and inspect the box contents to ensure all parts listed below are in the box. If something is missing, please contact your nearest customer service center.



❖ Due to different applications in each country, some regions may have different accessories.



Projector

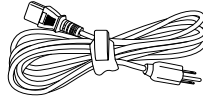

Power Cord (US/EU)

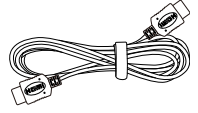

HDMI Cable



IR Remote Control

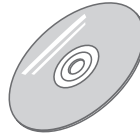

CD-ROM
(User's Manual &
Software)

Introduction

Product Overview

Main Unit

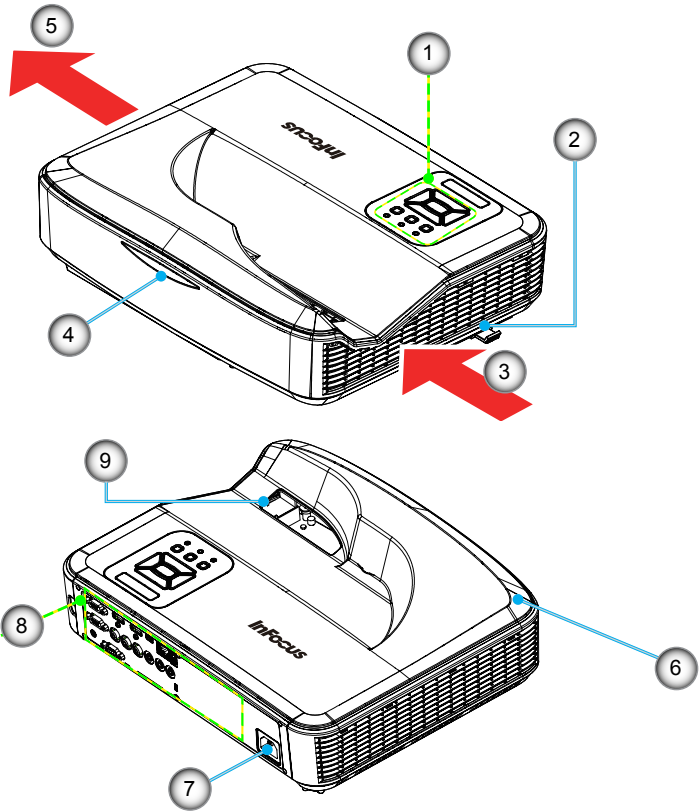

❖ The interface is subject to model's specifications.

- | | |
|-------------------------|-------------------------------|
| 1. Control Panel | 6. Speaker |
| 2. Focus Slide | 7. Power Socket |
| 3. Ventilation (inlet) | 8. Input / Output Connections |
| 4. IR Receiver | 9. Lens |
| 5. Ventilation (outlet) | |

Introduction

Control Panel

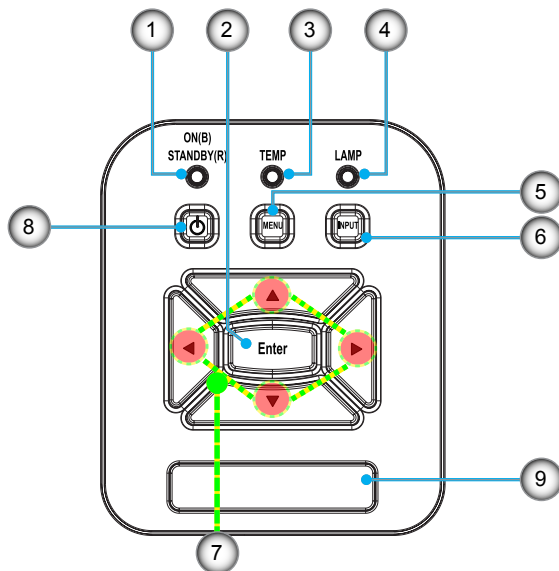

1. Power LED
2. Enter Key
3. Temperature LED
4. Lamp LED
5. Menu Key
6. Input Key
7. Four Direction Keys
8. Power/Standby Key
9. IR Receiver

Input/Output Connections

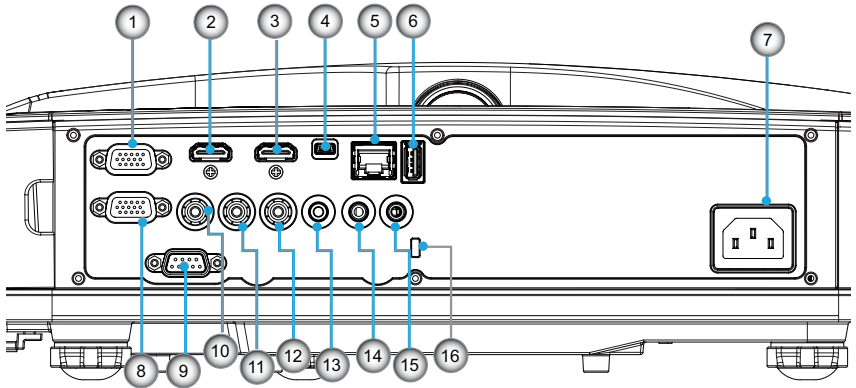

NOTE

❖ The interface is subject to model's specifications.

NOTE

❖ Monitor loop through only supported in VGA1-In/YPbPr.

1. VGA1 Connector
(PC Analog Signal/Component Video Input/HDTV/YPbPr)
2. HDMI2 Connector
3. HDMI1 Connector
4. USB Connector (Service only)
5. Network Connector
6. USB Type A Connector
7. Power Socket
8. VGA-Out/VGA2-In Connector
9. RS-232 Connector (9-pin DIN Type)
10. Composite Video Connector
11. Composite Audio Right
12. Composite Audio Left
13. Audio Output Connector
14. Audio Connector (3.5mm mini jack)
15. Microphone Connector
16. Kensington™ Lock Port

Introduction

Remote Control

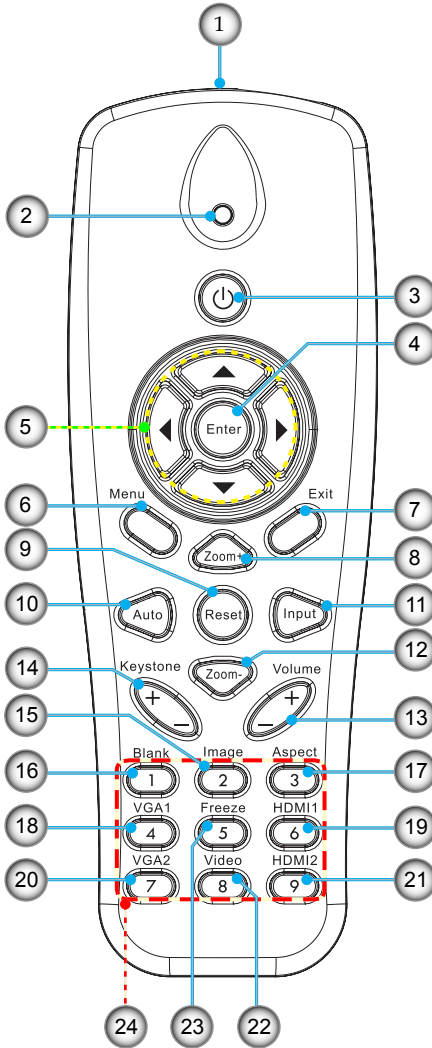

1. Transmitter
2. LED Indicator
3. Power On/Off
4. Enter
5. Four Directional Keys
6. Menu
7. Exit
8. Zoom In
9. Reset
10. Auto
11. Source
12. Zoom Out
13. Volume +/-
14. Keystone +/-
15. Image
16. Blank Screen
17. Aspect Ratio
18. VGA1
19. HDMI1
20. VGA2
21. HDMI2
22. Video
23. Freeze
24. Number Pad

Installation

Connecting the Projector Connect to Computer/Notebook

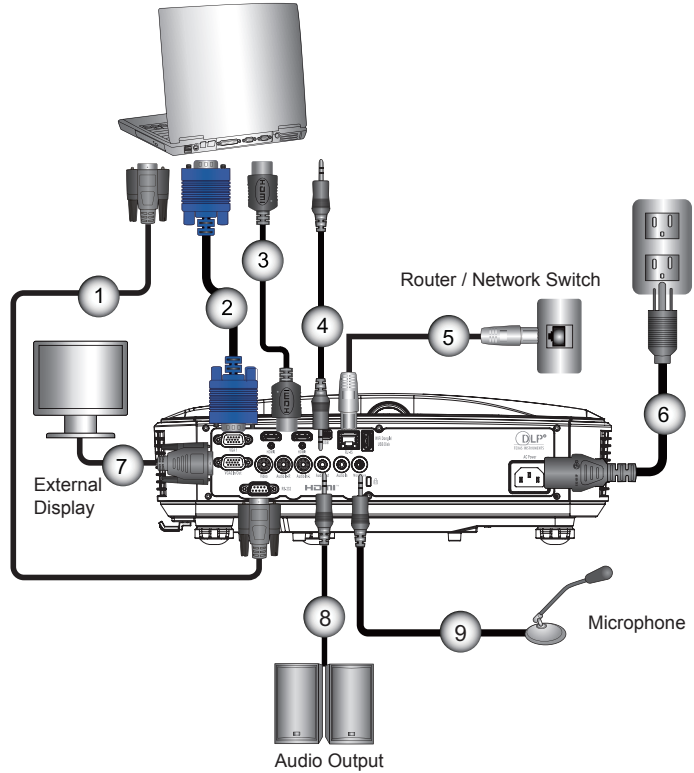

- ❖ Due to the difference in applications for each country, some regions may have different accessories.
- ❖ (*) Optional accessory

1.....	*RS232 Cable
2.....VGA Cable
3.....*HDMI Cable
4.....*Audio Cable/3.5mm
5.....*RJ45 Cable
6.....Power Cord
7.....*VGA Output Cable
8.....*Audio Output Cable
9.....*Audio Input Cable

Installation

Connect to Video Sources

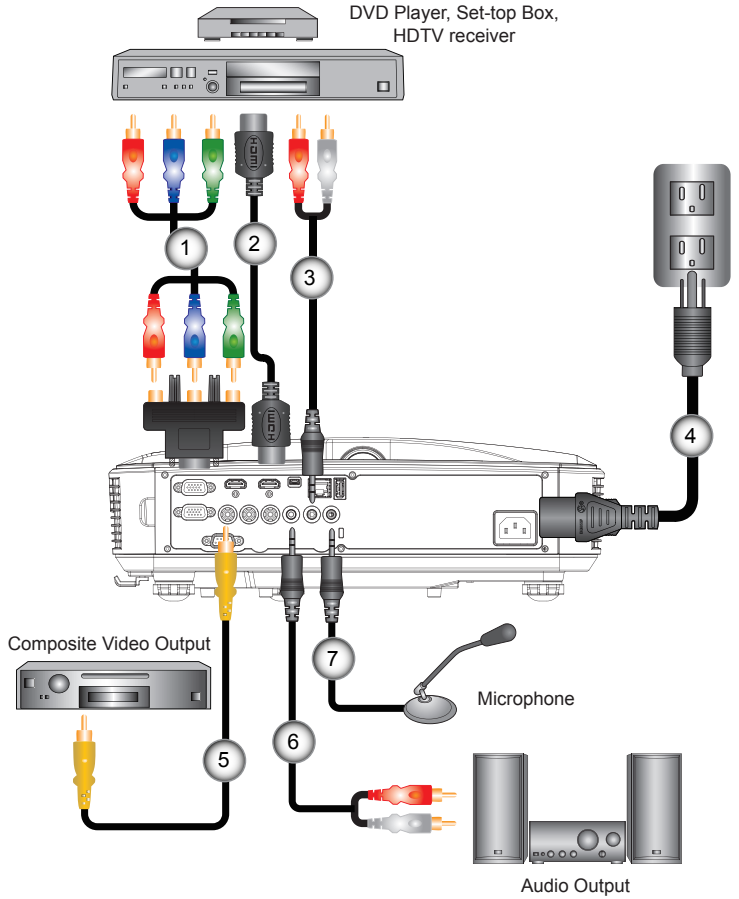

- ❖ Due to the difference in applications for each country, some regions may have different accessories.
- ❖ (*) Optional accessory

- | | |
|--------|---|
| 1..... | *15-Pin to 3 RCA Component/HDTV Adaptor |
| 2..... | *HDMI Cable |
| 3..... | *Audio Cable/RCA |
| 4..... | Power Cord |
| 5..... | *Composite Video Cable |
| 6..... | *Audio Output Cable |
| 7..... | *Audio Cable |

Installation

Powering the Projector On / Off

Powering On the Projector

1. Securely connect the power cord and signal cable. When connected, the POWER/STANDBY LED will turn Red.
2. Turn on the lamp by pressing “” button either on the projector or on the remote. The POWER/STANDBY LED will turn Blue. ❶

The startup screen will display in approximately 10 seconds. The first time you use the projector, you will be asked to select the preferred language and power saving mode.

3. Turn on and connect the source that you want to display on the screen (computer, notebook, video player, etc). The projector will detect the source automatically. If not, push the menu button and go to “Options”. Make sure that the “Source Lock” has been set to “Off”.
- ❖ If you connect multiple sources at the same time, press the “INPUT” button on the control panel or direct source keys on the remote control to switch between inputs.



❖ When the power mode is in standby mode (power consumption < 0.5W), the VGA output/ input and audio will be deactivated when the projector is in standby.



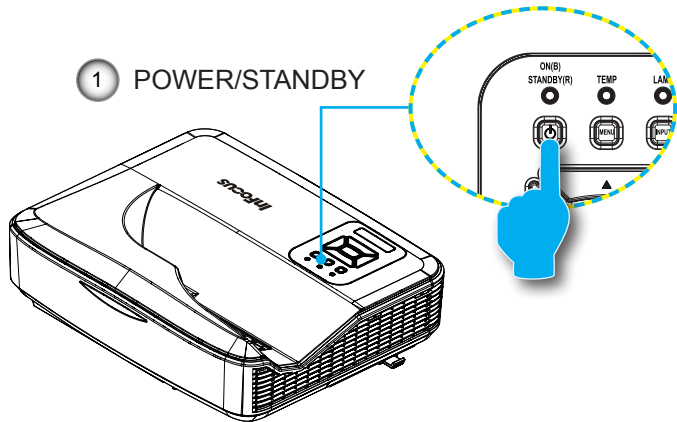

❖ Turn on the projector first and then select the signal sources.

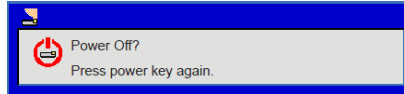

Powering Off the Projector

1. Press the “” button on the remote control or on the control panel to turn off the projector. The following message will be displayed on the screen.



Press the “” button again to confirm otherwise the message will disappear after 10 seconds. When you press the “” button for the second time the system will shut down and begin cooling.

2. The cooling cycle lasts 5 seconds, the POWER/STANDBY LED will flash red. When the LED lights solid red the projector is in standby mode.

If you wish to turn the projector back on, you must wait until the projector has completed the cooling cycle and has entered standby mode. Once in standby mode, simply press “” button to restart the projector.

3. Disconnect the power cord from the electrical outlet and the projector.

Warning Indicator

When the warning indicators (see below) come on, the projector will automatically shutdown:



- ❖ Contact the nearest service center if the projector displays these symptoms.

- ❖ “LAMP” LED indicator is lit red and if “POWER/STANDBY” indicator flashes red.
- ❖ The cooling cycle lasts 5 seconds, the POWER/STANDBY LED will flash red. When the LED lights solid red the projector is in standby mode.

Unplug the power cord from the projector, wait for 30 seconds and try again. If the warning indicator lights up again, please contact your nearest service center for assistance.

LED Lighting Message

Message	Power LED		Temp_LED	Lamp_LED
	Red	Blue	Red	Red
Standby State (Input Power cord)	*	--	--	--
Power on	--	*	--	--
Warming	Flashing	--	--	--
Cooling Down	Flashing	Flashing	--	--
Burn-in ON	Flashing	Flashing	--	--
Burn-in OFF	--	--	--	--
Power NG	--	--	*	*
Fan Lock			Flashing slow:3s	--
CW breakdown			Flashing fast:500ms	
Overheat	--	--	*	--
LD Overheat	--	--	*	--
LD Voltage Error	--	--	--	*



No Light: "--",

* Steady light

Adjusting the Projected Image

Adjusting the Projector's Height

The projector is equipped with adjustable feet for adjusting the image height position.

1. Locate the foot you want to adjust on the underside of the projector.
2. Turn the adjustable foot counter-clockwise to move it outwards or clockwise to move it inwards. Repeat with the remaining feet as needed.

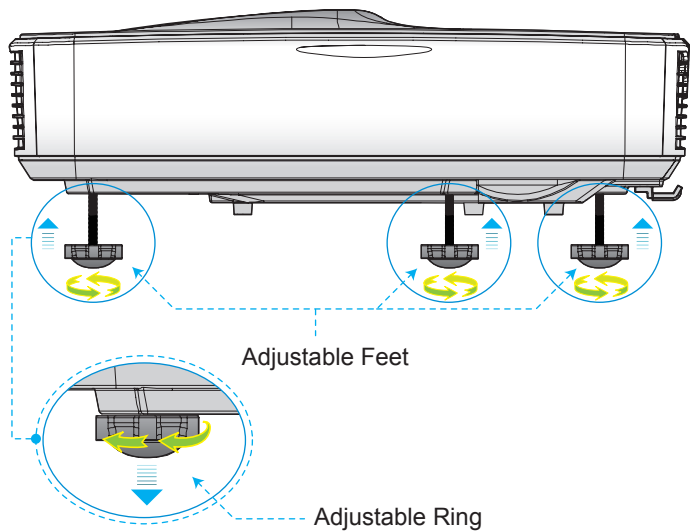

Installation

Adjusting the Projector's Focus

To focus the image, slide the focus slide until the image is clear.

- ▶ XGA series: The projector will focus at distances (lens to wall) from 0.53~0.68 meters
- ▶ WXGA series: The projector will focus at distances (lens to wall) from 0.49~0.68 meters
- ▶ 1080p series: The projector will focus at distances (lens to wall) from 0.49~0.57 meters

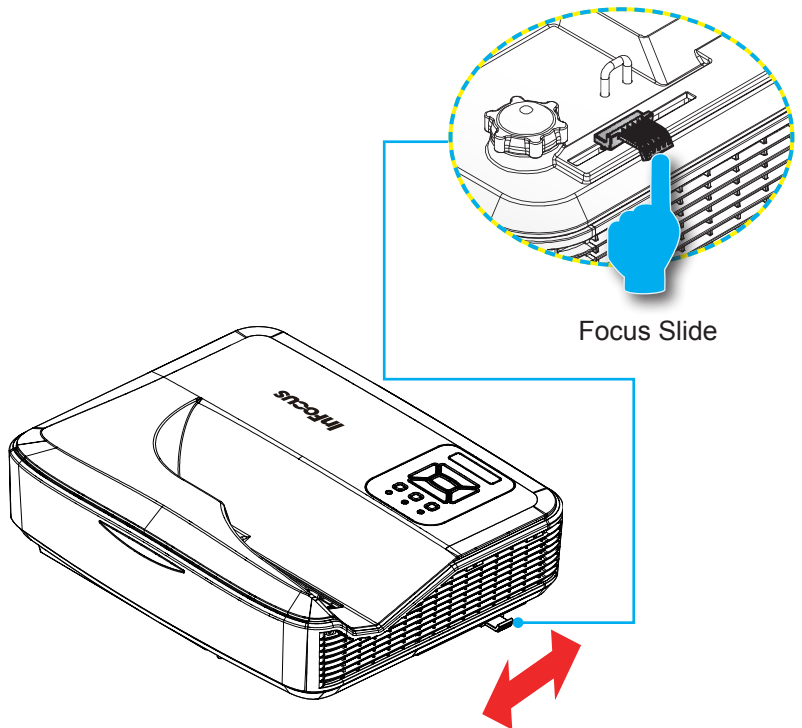

Installation

Adjusting Projection Image Size (Diagonal)

- ▶ XGA series: Projection Image Size from 72.1" to 92.5".
- ▶ WXGA series: Projection Image Size from 85" to 115".
- ▶ 1080p series: Projection Image Size from 86.8" to 102.1".

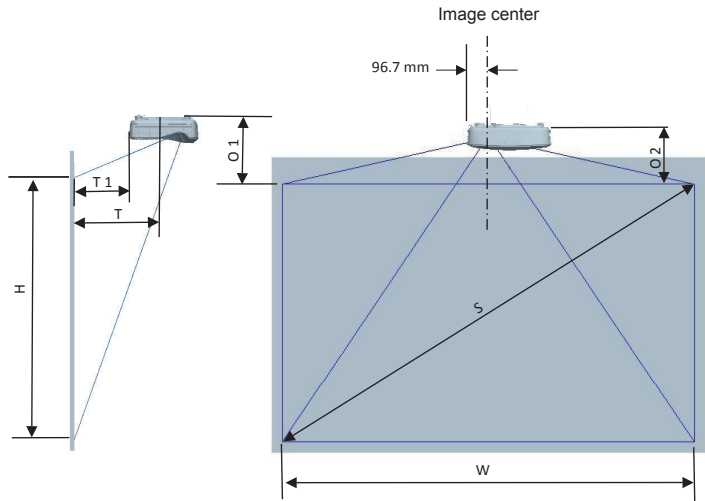

Installation

❖ This table is for user's reference only.

XGA (4:3) Wall mount installation measurement chart							
Diagonal image size (S) in inch	Diagonal image size (S) in mm	Image width (W) in mm	Image height (H) in mm	Distance from surface of whiteboard to back of projector (T1) in mm	Distance from surface of whiteboard to center of projector mount (T) in mm	Distance from top of image to top of interface boss (O1) in mm	Distance from top of image to top of projector (O2) in mm
72	1829	1463	1097	371	486.7	257	237
73	1854	1483	1113	377	492.7	260	240
74	1880	1504	1128	384	499.7	263	243
75	1905	1524	1143	391	506.7	265	245
76	1930	1544	1158	398	513.7	268	248
77	1956	1565	1173	404	519.7	271	251
78	1981	1585	1189	411	526.7	273	253
79	2007	1605	1204	418	533.7	276	256
80	2032	1626	1219	425	540.7	279	259
81	2057	1646	1234	431	546.7	281	261
82	2083	1666	1250	438	553.7	284	264
83	2108	1687	1265	445	560.7	287	267
84	2134	1707	1280	452	567.7	290	270
85	2159	1727	1295	458	573.7	292	272
86	2184	1748	1311	465	580.7	295	275
87	2210	1768	1326	472	587.7	298	278
88	2235	1788	1341	479	594.7	300	280
89	2261	1808	1356	485	600.7	303	283
90	2286	1829	1372	492	607.7	306	286
91	2311	1849	1387	499	614.7	308	288
92	2337	1869	1402	506	621.7	311	291
93	2362	1890	1417	512	627.7	314	294
94	2388	1910	1433	519	634.7	317	297
95	2413	1930	1448	526	641.7	319	299
96	2438	1951	1463	533	648.7	322	302
97	2464	1971	1478	539	654.7	325	305

Installation

WXGA (16:10) Wall mount installation measurement chart							
Diagonal image size (S) in inch	Diagonal image size (S) in mm	Image width (W) in mm	Image height (H) in mm	Distance from surface of whiteboard to back of projector (T1) in mm	Distance from surface of whiteboard to center of projector mount (T) in mm	Distance from top of image to top of interface boss (O1) in mm	Distance from top of image to top of projector (O2) in mm
85	2159	1831	1144	370	485.7	266	246
86	2184	1852	1158	376	491.7	268	248
87	2210	1874	1171	382	497.7	270	250
88	2235	1895	1185	387	502.7	273	253
89	2261	1917	1198	393	508.7	275	255
90	2286	1939	1212	399	514.7	277	257
91	2311	1960	1225	404	519.7	280	260
92	2337	1982	1239	410	525.7	282	262
93	2362	2003	1252	416	531.7	285	265
94	2388	2025	1265	422	537.7	287	267
95	2413	2046	1279	427	542.7	289	269
96	2438	2068	1292	433	548.7	292	272
97	2464	2089	1306	439	554.7	294	274
98	2489	2111	1319	444	559.7	297	277
99	2515	2132	1333	450	565.7	299	279
100	2540	2154	1346	456	571.7	301	281
101	2565	2175	1360	461	576.7	304	284
102	2591	2197	1373	467	582.7	306	286
103	2616	2219	1387	473	588.7	308	288
104	2642	2240	1400	479	594.7	311	291
105	2667	2262	1414	484	599.7	313	293
106	2692	2283	1427	490	605.7	316	296
107	2718	2305	1440	496	611.7	318	298
108	2743	2326	1454	501	616.7	320	300
109	2769	2348	1467	507	622.7	323	303
110	2794	2369	1481	513	628.7	325	305
111	2819	2391	1494	519	634.7	327	307
112	2845	2412	1508	524	639.7	330	310
113	2870	2434	1521	530	645.7	332	312
114	2896	2455	1535	536	651.7	335	315
115	2921	2477	1548	541	656.7	337	317

Installation

1080P (16:9) Wall mount installation measurement chart							
Diagonal image size (S) in inch	Diagonal image size (S) in mm	Image width (W) in mm	Image height (H) in mm	Distance from surface of whiteboard to back of projector (T1) in mm	Distance from surface of whiteboard to center of projector mount (T) in mm	Distance from top of image to top of interface boss (O1) in mm	Distance from top of image to top of projector (O2) in mm
87	2210	1926	1083	370	485.7	288	268
88	2235	1948	1096	376	491.7	291	271
89	2261	1970	1108	382	497.7	294	274
90	2286	1992	1121	387	502.7	296	276
91	2311	2015	1133	393	508.7	299	279
92	2337	2037	1146	398	513.7	301	281
93	2362	2059	1158	404	519.7	304	284
94	2388	2081	1171	409	524.7	307	287
95	2413	2103	1183	415	530.7	309	289
96	2438	2125	1196	421	536.7	312	292
97	2464	2147	1208	426	541.7	314	294
98	2489	2170	1220	432	547.7	317	297
99	2515	2192	1233	437	552.7	320	300
100	2540	2214	1245	443	558.7	322	302
101	2565	2236	1258	448	563.7	325	305
102	2591	2258	1270	454	569.7	327	307

Installation

Projector installation measurement chart Table top

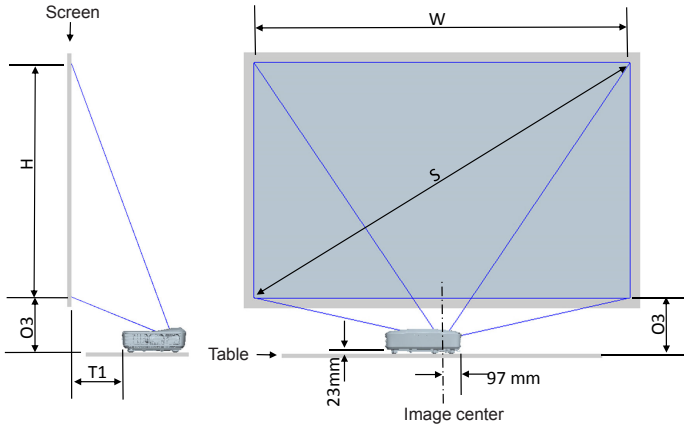

❖ This table is for user's reference only.

XGA (4:3) Table top installation measurement chart					
Diagonal image size (S) in inch	Diagonal image size (S) in mm	Image width (W) in mm	Image height (H) in mm	Distance from surface of whiteboard to back of projector (T1) in mm	Distance from bottom of image to top of table (O3) in mm
72	1829	1463	1097	234	260
73	1854	1483	1113	240	263
74	1880	1504	1128	247	266
75	1905	1524	1143	254	268
76	1930	1544	1158	261	271
77	1956	1565	1173	267	274
78	1981	1585	1189	274	276
79	2007	1605	1204	281	279
80	2032	1626	1219	288	282
81	2057	1646	1234	294	284
82	2083	1666	1250	301	287
83	2108	1687	1265	308	290
84	2134	1707	1280	315	293
85	2159	1727	1295	321	295
86	2184	1748	1311	328	298
87	2210	1768	1326	335	301
88	2235	1788	1341	342	303
89	2261	1808	1356	348	306
90	2286	1829	1372	355	309
91	2311	1849	1387	362	311
92	2337	1869	1402	369	314
93	2362	1890	1417	375	317
94	2388	1910	1433	382	320
95	2413	1930	1448	389	322
96	2438	1951	1463	396	325
97	2464	1971	1478	402	328

Installation

WXGA (16:10) Table top installation measurement chart					
Diagonal image size (S) in inch	Diagonal image size (S) in mm	Image width (W) in mm	Image height (H) in mm	Distance from surface of whiteboard to back of projector (T1) in mm	Distance from bottom of image to top of table (O3) in mm
85	2159	1831	1144	233	269
86	2184	1852	1158	239	271
87	2210	1874	1171	245	273
88	2235	1895	1185	250	276
89	2261	1917	1198	256	278
90	2286	1939	1212	262	280
91	2311	1960	1225	267	283
92	2337	1982	1239	273	285
93	2362	2003	1252	279	288
94	2388	2025	1265	285	290
95	2413	2046	1279	290	292
96	2438	2068	1292	296	295
97	2464	2089	1306	302	297
98	2489	2111	1319	307	300
99	2515	2132	1333	313	302
100	2540	2154	1346	319	304
101	2565	2175	1360	324	307
102	2591	2197	1373	330	309
103	2616	2219	1387	336	311
104	2642	2240	1400	342	314
105	2667	2262	1414	347	316
106	2692	2283	1427	353	319
107	2718	2305	1440	359	321
108	2743	2326	1454	364	323
109	2769	2348	1467	370	326
110	2794	2369	1481	376	328
111	2819	2391	1494	382	330
112	2845	2412	1508	387	333
113	2870	2434	1521	393	335
114	2896	2455	1535	399	338
115	2921	2477	1548	404	340

1080P (16:9) Table top installation measurement chart					
Diagonal image size (S) in inch	Diagonal image size (S) in mm	Image width (W) in mm	Image height (H) in mm	Distance from surface of whiteboard to back of projector (T1) in mm	Distance from bottom of image to top of table (O3) in mm
87	2210	1926	1083	233	291
88	2235	1948	1096	239	294
89	2261	1970	1108	245	297
90	2286	1992	1121	250	299
91	2311	2015	1133	256	302
92	2337	2037	1146	261	304
93	2362	2059	1158	267	307
94	2388	2081	1171	272	310
95	2413	2103	1183	278	312
96	2438	2125	1196	284	315
97	2464	2147	1208	289	317
98	2489	2170	1220	295	320
99	2515	2192	1233	300	323
100	2540	2214	1245	306	325
101	2565	2236	1258	311	328
102	2591	2258	1270	317	330

Control Panel & Remote Control

Control Panel

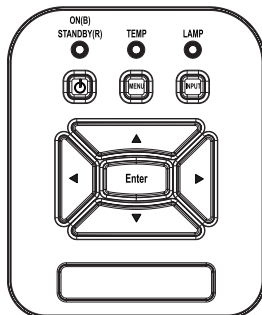

Using the Control Panel

POWER		Refer to the “Power On/Off the Projector” section.
Enter		Press “Enter” to confirm your item selection.
INPUT		Press “INPUT” to select an input signal.
MENU		Press “MENU” to launch the on-screen display (OSD) menu. To exit OSD, press “MENU” again.
Four Directional Keys		Use ▲▼◀▶ to select items or make adjustments to your selection.
LAMP LED		Indicates lamp status.
TEMP LED		Indicates temperature status.
ON/STANDBY LED		Indicates power status.

User Controls

Remote Control

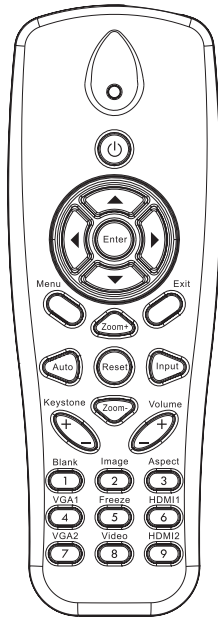

Using the Remote Control

Infrared Transmitter	Sends signals to the projector.
LED	LED Indicator.
Power 	Refer to the “Power On/Off the Projector” section.
Exit	Press “Exit” to close the OSD menu.
Zoom in	Zoom in the projector display.
Reset	Return the adjustments and settings to the factory default values.
Zoom out	Zoom out the projector display.
Enter	Confirm your item selection.
Source	Press “Source” to select an input signal.
Auto	Automatically synchronizes the projector to the input source.
Four Directional Select Keys	Use ▲▼◀▶ to select items or make adjustments to your selection.
Keystone +/-	Adjust image distortion caused by tilting the projector.
Volume +/-	Adjust to increase / decrease the volume.
Menu	Press “Menu” to launch the on-screen display (OSD) menu. To exit OSD, press “Menu” again.
Blank	Turns off video and audio. Press again to turn on video and audio.

User Controls

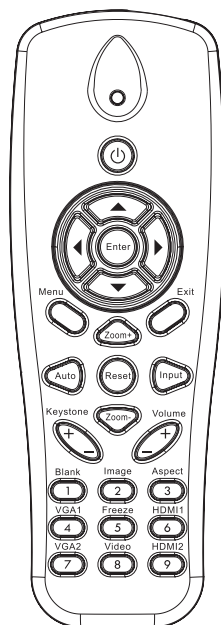

Using the Remote Control

Image	Select the display mode from Bright, PC, Movie, Game, and User.
Aspect	Select aspect ratio.
VGA1	Select VGA1 video input.
Freeze	Pause the screen image. Press again to resume the screen image.
HDMI1	Select HDMI1 video input.
VGA2	Select the VGA2 video input.
Video	Select the Composite video input.
HDMI2	Select HDMI2 video input.

On-screen Display Menu

The Projector has multilingual On-screen Display menus that allow you to make image adjustments and change a variety of settings.

How to operate

1. To open the OSD menu, press “Menu” on the Remote Control or Projector Keypad.
2. When the OSD menu is displayed, use the ▲▼ keys to select any item in the main menu. While making a selection on a particular page, press the ► or “Enter” key to enter sub menu.
3. Use the ▲▼ keys to select the desired item and adjust the settings using the ◀▶ keys.
4. Select the next item to be adjusted in the sub menu and adjust as described above.
5. Press “Enter” to confirm, and the screen will return to the main menu.
6. To exit, press “Menu” again. The OSD menu will close and the projector will automatically save the new settings.

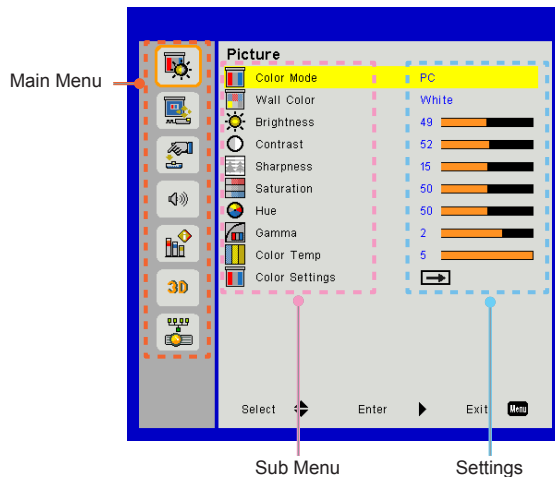

Image

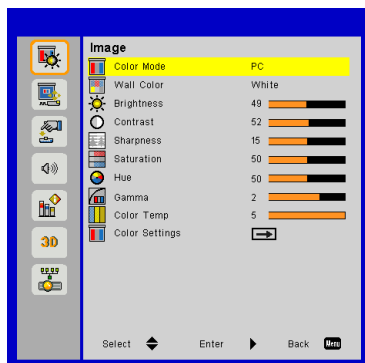

Color Mode

There are many factory presets optimized for various types of images. Use the ◀ or ▶ button to select the item.

- ▶ Bright: For brightness optimization.
- ▶ PC: For meeting presentation.
- ▶ Movie: For playing video content.
- ▶ Game: For game content.
- ▶ User: Stored user settings.

Wall Color

Use this function to obtain an optimized screen image according to the wall color. You can select from “White”, “Light Yellow”, “Light Blue”, “Pink”, and “Dark Green”.

Brightness

Adjust the brightness of the image.

- ▶ Press the ◀ button to darken image.
- ▶ Press the ▶ button to brighten image.

Contrast

The Contrast controls the difference between the lightest and darkest parts of the picture. Adjusting the contrast changes the amount of black and white in the image.

- ▶ Press the ◀ button to decrease the contrast.
- ▶ Press the ▶ button to increase the contrast.



- ❖ “Sharpness”, “Saturation” and “Hue” functions are only supported under video mode.

Sharpness

Adjust the sharpness of the image.

- ▶ Press the ◀ button to decrease the sharpness.
- ▶ Press the ▶ button to increase the sharpness.

Saturation

Adjust a Composite video image from black and white to full color saturation.

- ▶ Press the ◀ button to decrease the amount of saturation in the image.
- ▶ Press the ▶ button to increase the amount of saturation in the image.

Hue

Adjust the color balance of red and green.

- ▶ Press the ◀ button to increase the amount of green in the image.
- ▶ Press the ▶ button to increase the amount of red in the image.

Gamma

Adjusts the gamma value to get better contrast.

Color Temp

Adjusts color temperature. At higher temperature the screen looks more blue, at lower temperature the screen looks more red.

Color Settings

Use these settings for advanced adjustment of the individual Red, Green, Blue, Cyan, Magenta and Yellow colors.

Configuration

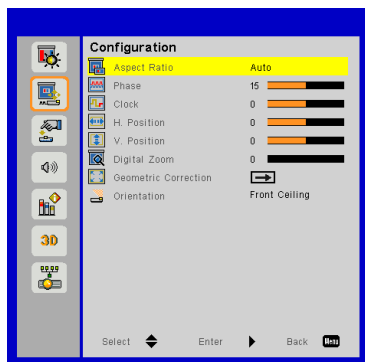

Aspect Ratio

- ▶ Auto: Displays using the source's aspect ratio, maximizing screen coverage.
- ▶ 4:3: The image will be scaled to fit the screen using a 4:3 aspect ratio.
- ▶ 16:9: The image will be scaled to fit the screen using a 16:9 aspect ratio.
- ▶ 16:10: The image will be scaled to fit the screen using a 16:10 aspect ratio.



- ❖ "H. Position" and "V. Position" ranges will depend on input source.

Phase

Synchronize the signal timing with an analog graphics card. If the image appears to be unstable or flickers, use this function to correct it.

Clock

Adjust to achieve an optimal image when there is vertical flicker from an analog graphics card.

H. Position

- ▶ Press the ◀ button to move the image left.
- ▶ Press the ▶ button to move the image right.

V. Position

- ▶ Press the ◀ button to move the image down.
- ▶ Press the ▶ button to move the image up.

Digital Zoom

- ▶ Press the ◀ button to reduce the size of an image.
- ▶ Press the ▶ button to magnify an image on the projection screen.

Geometric Correction



❖ V. Keystone and H. Keystone are not adjustable under 4 corners adjustment mode is on.

- ▶ V Keystone: Press the ◀ or ▶ button to adjust image distortion vertically. If the image looks trapezoidal, this option can help make the image rectangular.
- ▶ H Keystone: Press the ◀ or ▶ button to adjust image distortion horizontally. If the image looks trapezoidal, this option can help make the image rectangular.
- ▶ Grid Color: Use this function to change the color of 4 corners background grid. You can select from “White”, “Green”, “Red”, and “Purple”.

Adjust the display area using the 4 Corners adjustment.

Step 1: Select "4 Corners On/Off" and turn it On.

Step 2: Select "4 Corners Adjust" and a grid will be displayed.

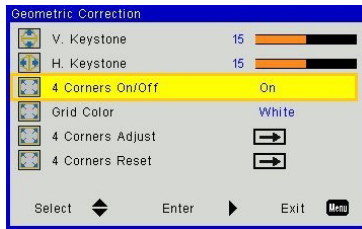

Step 3: Press ▲▼ and ◀▶ to select a corner.

Step 4: Press “Enter” and the color of the selected corner will change from blue to red.

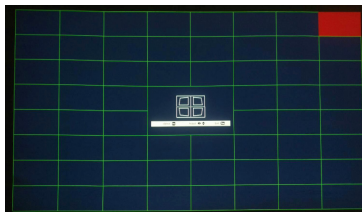

User Controls

Step 5: Press ▲▼ and ◀▶ to adjust the geometry.

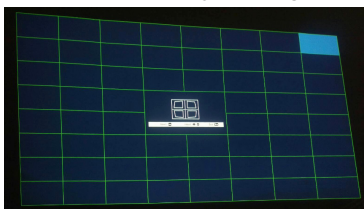

Step 6: Press "Menu" and select another corner to adjust.

Step 7: Press "Menu" and select another corner to adjust.

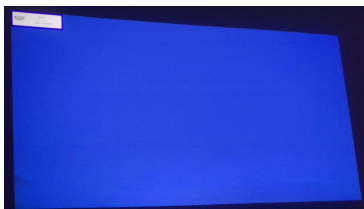

Step 8: Select "4 Corners Reset" to restore the original settings.

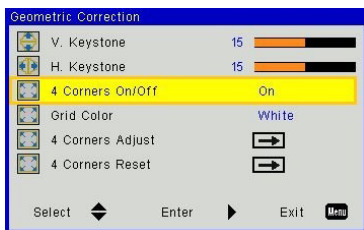

Orientation

- ▶ Front: The image is projected straight on the screen.
- ▶ Front Ceiling: This is the default selection. When selected, the image will turn upside down.
- ▶ Rear: When selected, the image will appear reversed.
- ▶ Rear Ceiling: When selected, the image will appear reversed in upside down position.

Settings

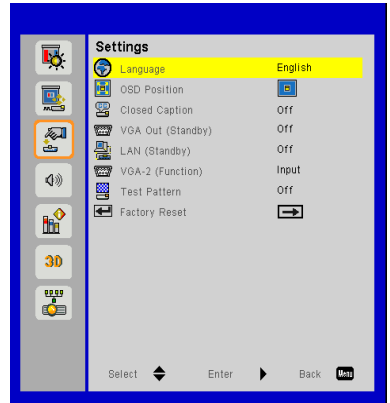

Language

Opens the multilingual selection menu. Use the ▲▼ and ◀▶ keys to select the preferred language then press Enter to finalize the selection.



OSD Position

Select location of the Menu on the display.

Closed Caption

Use this function to open the Closed Caption menu. Select between Off, CC1, CC2, CC3, and CC4.

VGA Out (Standby)

Select "On" to make VGA OUT available during standby. Select "Off" to make VGA OUT unavailable during standby.

LAN (Standby)

Select “Off” to make the LAN connection unavailable during standby. Select “On” to make the connection available during standby.

When in standby the Web Management is not available. The projector must be turned on with a magic packet.

VGA-2 (Function)

- ▶ Input: Select “Input” to configure VGA2 as a VGA video input.
- ▶ Output: Select “Output” to configure VGA2 as a VGA output.

Test Pattern

Display a test pattern.

Factory Reset

Select “Yes” to return all parameters to factory default.

Audio



Speaker

- ▶ Select “On” to enable the speaker.
- ▶ Select “Off” to disable the speaker.

Line Out

- ▶ Select “On” to enable the line out function.
- ▶ Select “Off” to disable the line out function.

Microphone

- ▶ Select “On” to enable the microphone.
- ▶ Select “Off” to disable the microphone.

Mute

- ▶ Select “On” to turn mute on.
- ▶ Select “Off” to turn mute off.

Volume

- ▶ Press the ◀ button to decrease the volume.
- ▶ Press the ▶ button to increase the volume.

Microphone Volume

- ▶ Press the ◀ button to decrease the microphone volume.
- ▶ Press the ▶ button to increase the microphone volume.

Options

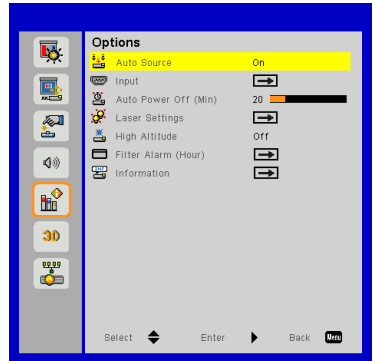

Auto Source

- ▶ On: The projector will search for other signals if the current input signal is lost.
- ▶ Off: The projector will only search the current input connection.

Input

Press ▶ button to enable/disable input sources. The projector will not search for inputs that are not selected.

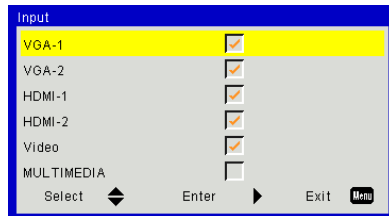

Auto Power Off (Min)

Sets the countdown timer interval. The countdown timer will start when there is no signal being sent to the projector. The projector will automatically power off when the countdown has finished (in minutes).

Laser Settings

Refer to the “Options/Laser Settings” section on page 38.

High Altitude

- ▶ On: The built-in fans run at high speed. Select this option when using the projector at altitudes above 2500 feet/762 meters or higher.
- ▶ Off: The built-in fans automatically run at a variable speed according to the internal temperature.

Filter Alarm (Hours)

- ▶ Filters Remind (Hour): Set the filter reminder time.
- ▶ Filter Reminder Reset: Select "Yes" to reset the dust filter hour counter after replacing or cleaning the dust filter.

Information

Display the projector information for model name, SNID, source, resolution, software version, and aspect ratio on the screen.

Options | Laser Settings

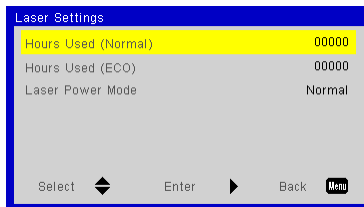

Hours Used (Normal)

Displays the hours that the laser has been on in Normal Mode.

Hours Used (ECO)

Displays the hours that the laser has been on in ECO Mode.

Laser Power Mode

- ▶ Normal: Normal mode.
- ▶ ECO: Select to lower laser power. This dims the projected display and extends laser life.

3D



- ❖ “Frame Sequential” is supported on input signals from the VGA, HDMI, and Composite video connectors.
- ❖ “Frame Packing” / “Side-by-Side(Half)” / “Top and Bottom” are supported from HDMI 1.4a 3D input signals.

3D

- ▶ Auto: When an HDMI 1.4a 3D timing identification signal is detected the 3D setting is set automatically.
- ▶ Select “On” to enable the 3D function.
- ▶ Select “Off” to disable the 3D function.

3D Invert

If you see a discrete or overlapping image while wearing DLP 3D glasses, you may need to execute “Invert” to get best match of left/right image sequence.

3D Format

Use this feature to select the 3D format. Options are: “Frame Packing”, “Side-by-Side”, “Top and Bottom”, “Frame Sequential”, and “Field Sequential”.

1080p@24

Select 96 or 144Hz refresh rate to match the DLPLink 3D glasses being used.

User Controls



Blending mode

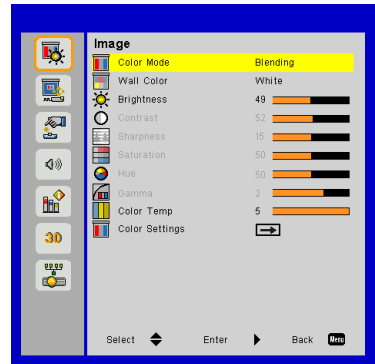

Brightness

Use to manually adjust the brightness of blended projectors.

Color Temp

Use to manually adjust the color temperature of blended projectors.

Blending application

Example of system architecture

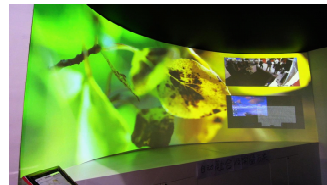
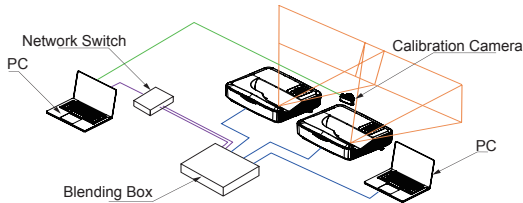

Meeting Room

- ▶ Laptop, Switch and Camera is for image calibration only
- ▶ Laptop Source: Image source
- ▶ Blending Box
- ▶ Multiple projectors (two in this example)
- ▶ For more details, please check the Blending Box HW/SW specifications

LAN

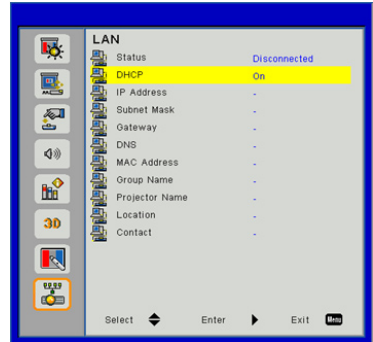

Status

Displays the network connection status.

DHCP

Use to configure the DHCP setting.

- ▶ On: Select "On" to obtain an IP address automatically from the network.
- ▶ Off: Select "Off" to manually assign a fixed IP, Subnet Mask, Gateway, and DNS.

IP Address

Displays the projector IP address.

Subnet Mask

Displays the projector Subnet Mask number.

Gateway

Displays the network Gateway address.

DNS

Displays the DNS address.

MAC Address

Displays the projector MAC address.

User Controls

Group Name

Displays the group name.

Projector Name

Displays the projector name.

Location

Displays the projector location.

Contact

Displays the contact information.

User Controls

How to use a web browser to control your projector

You can control the projector remotely via a web browser on your controlling device. You can connect directly or via a network.

1. When making a LAN connection from your network to the projector:

Step 1: Please select DHCP On.

Step 2: Find the "IP Address" of the projector in the LAN menu.

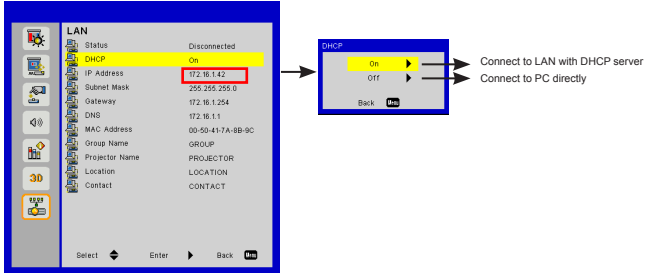

Step 3: Open your web browser and type in the IP address in the URL and press "Enter".
Then you can **Control the projector over a network.**

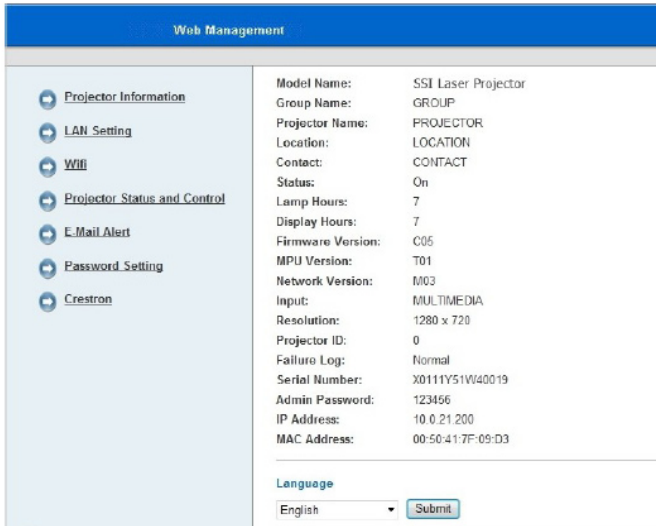

User Controls

2. When making Wi-Fi connection between your computer and the projector

Step 1: Setup the WiFi connection

- ▶ Insert a WiFi dongle (optional SP-WIFIUSB-2) in the USB-A socket in the projector.
- ▶ Go to Input → Multimedia → Settings → WiFi.
- ▶ Define SSID/AP name and password in the AP settings menu. Note! The password must be minimum 8 characters. Press exit on the remote control to exit the virtual keyboard to be able to save the settings.
- ▶ You are now ready to connect your wireless device directly to the projector (AP mode).
- ▶ If you want to connect via a WiFi network (client mode) you must connect the projector and the wireless device to a common WiFi network and ensure that the network allows connected units to see each other.
- ▶ Turn ON the AP list to see available wireless networks (Client mode only).
- ▶ Connect the projector to the desired wireless network (Client mode only).
- ▶ Exit Settings

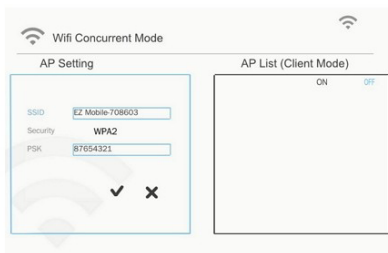

AP Mode

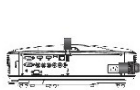

Wi-Fi



Device:
Tablet
Smart Phone
Laptop
PC

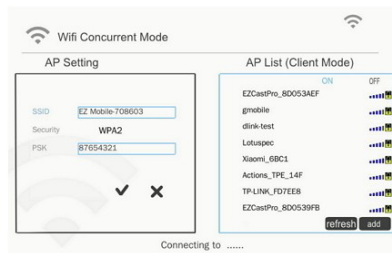

Client Mode



WLAN



Wi-Fi



Wi-Fi

Device: Tablet/Smart Phone/Laptop/PC

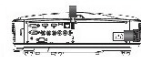

Step 2: Connect to the projector (AP Mode only)

- ▶ Go to Input → Multimedia → Mobile/Tablet or Laptop (depending on device)
- ▶ On your mobile/tablet or laptop: Open the list of available wireless networks and connect to the listed AP using the displayed password

User Controls

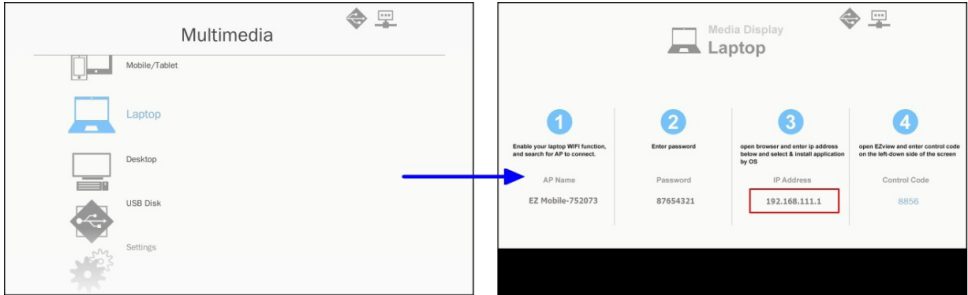

Step 3: Access the Web Management Page in AP mode.

Open your web browser and type in the IP address 192.168.111.1 in the URL then press "Enter".

Projector Information

Use to get Projector Information and select different languages for Web Management.

The screenshot shows the 'Web Management' page. On the left is a navigation menu with options: Projector Information, LAN Setting, Wifi, Projector Status and Control, E-Mail Alert, Password Setting, and Crestron. The main content area displays projector details:

Model Name:	SSI Laser Projector
Group Name:	GROUP
Projector Name:	PROJECTOR
Location:	LOCATION
Contact:	CONTACT
Status:	On
Lamp Hours:	7
Display Hours:	7
Firmware Version:	C05
MPU Version:	T01
Network Version:	M03
Input:	MULTIMEDIA
Resolution:	1280 x 720
Projector ID:	0
Failure Log:	Normal
Serial Number:	X0111Y51W40019
Admin Password:	123456
IP Address:	10.0.21.200
MAC Address:	00:50:41:7F:09:D3

Below the details is a 'Language' section with a dropdown menu set to 'English' and a 'Submit' button.

User Controls

LAN Setting

Use to configure network parameters and edit the projector information.

The screenshot shows the 'Web Management' interface for LAN settings. On the left is a navigation menu with options: Projector Information, LAN Setting (selected), Wifi, Projector Status and Control, E-Mail Alert, Password Setting, and Crestron. The main content area is titled 'LAN Setting' and contains the following fields:

- DHCP: On Off
- IP Address:
- Subnet Mask:
- Gateway:
- DNS:
- Group Name:
- Projector Name:
- Location:
- Contact:

A 'Submit' button is located at the bottom of the form.

Wi-Fi

Use to download and install EZ View for different platforms and operating systems.

The screenshot shows the 'Web Management' interface for Wifi settings. On the left is a navigation menu with options: Projector Information, LAN Setting, Wifi (selected), Projector Status and Control, E-Mail Alert, Password Setting, and Crestron. The main content area is titled 'Wifi' and contains a 'Download Link:' section with icons and text for different operating systems:

- Windows
- Mac OS
- iOS
- Android

User Controls

Projector Status and Control

Use to control the projector and get status information.

When the projector is in standby Web Management is not available due to regulations on power usage. To turn the projector back on over the Ethernet connection you must use a magic packet.

Web Management

Projector Status and Control

- Projector Information
- LAN Setting
- Wifi
- Projector Status and Control**
- E-Mail Alert
- Password Setting
- Crestron

Projector Status:

Input:

Logo:

Orientation:

High Altitude: On Off

Auto Source: On Off

LASER Power Mode: Normal ECO

Auto Power Off (Min): (0~120)

Image Control

Color Mode:

Aspect Ratio:

Video Mute: On Off

Brightness: (0~100)

Contrast: (0~100)

Clock:

Phase: (0~31)

Saturation: (0~100)

Hue: (0~100)

User Controls

E-mail Alert

Use to configure email settings and alert notices.

The screenshot shows the 'Web Management' interface with a sidebar on the left containing navigation links: Projector Information, LAN Setting, Wifi, Projector Status and Control, E-Mail Alert (highlighted), Password Setting, and Crestron. The main content area is titled 'E-Mail Alert' and includes the following sections:

- E-Mail Alert:** Radio buttons for 'Enable' and 'Disable' (selected). An 'E-Mail Alert Test' button is present.
- Fields:** Text boxes for 'TO', 'CC', 'From', and 'Subject' (containing 'NPSI-1').
- SMTP Setting:** Text boxes for 'Outgoing SMTP server', 'Username', and 'Password'.
- Alert Condition:** A list of checkboxes for various error types: System Overtemp, Fan Failure - System 1, Fan Failure - System 2, Fan Failure - System 3, Fan Failure - DMD, Fan Failure - PW, Color Wheel Fail, and LASER Error.
- Save:** A 'Save' button at the bottom.

Password Setting

Use to set the password for access to web management.

The screenshot shows the 'Web Management' interface with a sidebar on the left containing navigation links: Projector Information, LAN Setting, Wifi, Projector Status and Control, E-Mail Alert, Password Setting (highlighted), and Crestron. The main content area is titled 'Password Setting' and includes the following sections:

- Text:** A message: 'Please set your password if you enable this feature for first time. If password is set, you will require to enter with your password upon you connected to the Web Management.'
- Administrator:** Radio buttons for 'Enable' and 'Disable' (selected). A 'Submit' button is present.
- Fields:** Text boxes for 'New Password' and 'Confirm Password', both containing six dots.
- Submit:** A 'Submit' button at the bottom right.

Crestron control: See “Crestron” section on how to control the projector via Crestron flash UI.

EZ View

EZ View is an APP and software that can wirelessly transfer content from a smart phone, tablet, laptop, desktop, etc. and have it displayed on a projector. There is a limitation to what you can do via the app whilst using the software has no other limitation than a maximum resolution of XGA (1024x768).

EZ View APP features:

- ▶ Supports viewing local photos and documents (PDF and Office files).
- ▶ Supports viewing local videos.
- ▶ Displays Web pages.
- ▶ View image data from a camera.
- ▶ Supports Web Video like Youtube
- ▶ Supports Dropbox
- ▶ Annotate over photos, documents and Web pages

Screen Display via EZ View APP or software

Step 1: Install the EZ View tool on your device according to the device operating system.

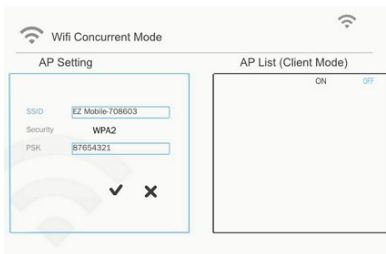

AP Mode

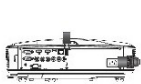

Wi-Fi

Device:
Tablet
Smart Phone
Laptop
PC

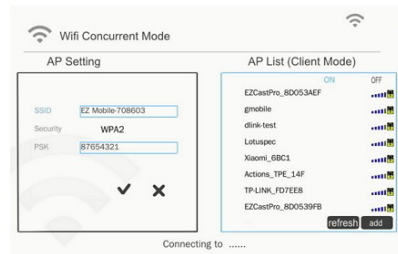

Client Mode



WLAN

Wi-Fi

WLAN

Wi-Fi

Device: Tablet/Smart Phone/Laptop/PC

User Controls

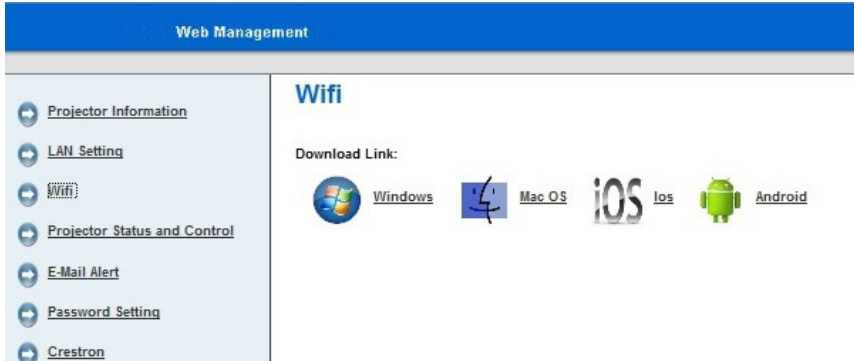

Step 2: Start EZ View on your device by clicking on the icon below.

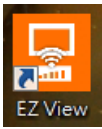

on PC or Laptop,



on tablet or smart phone.

EZ View on PC or Laptop

Step 1: Connect your PC/Laptop to the projector (AP mode) or connect both the PC/Laptop and the projector to a common WiFi or LAN network (Client mode)

Step 2: Select the Multimedia video source on the projector and select Laptop (AP mode) or Desktop (Client mode) then start EZ View on your PC or laptop by clicking on the icon below.

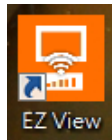

Step 3: Click Auto Search or enter the IP address then click Start

User Controls

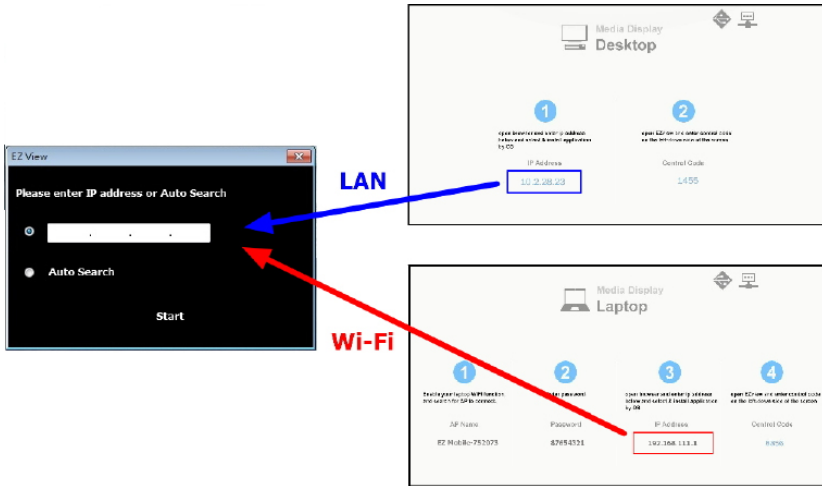

Step 4: Select Mirror or Extension to display.

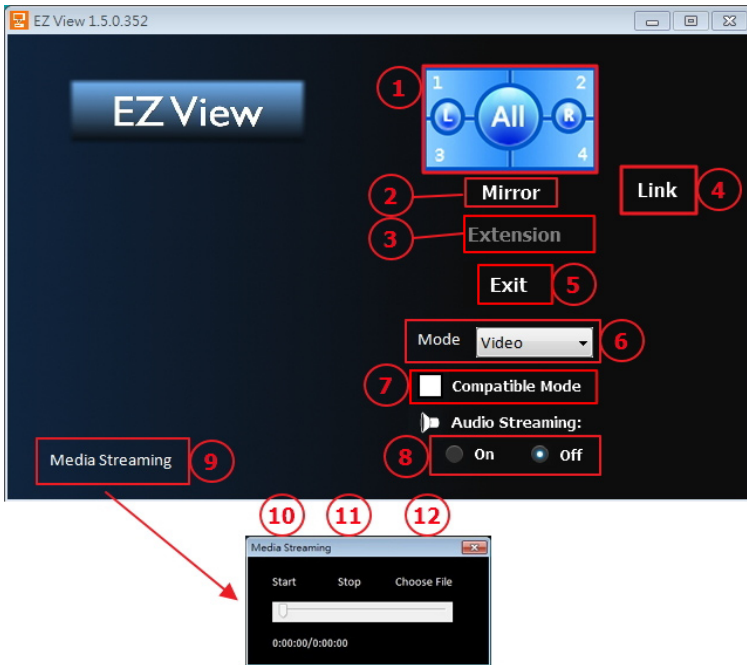

User Controls

1. Selects the image position (1 of 4, 1 of 2 or full screen)
2. Mirror Mode Display
3. Extension Mode Display
4. Link to Web management page (AP mode and client mode via LAN network only)
5. Exit
6. Display Mode : Video or Graphic
7. Compatible Mode
8. Audio On/Off
9. Media Streaming mode for playing video application
10. Start playing video
11. Stop playing video
12. Select video streaming file

EZ View on Tablet or Smart phone

Step 1: Connect your mobile/tablet to the projector (AP mode) or connect both the mobile/tablet and the projector to a common WiFi or LAN network (Client mode).

Step 2: Select the Multimedia video source on the projector and select Mobile/Tablet then start EZ View on your phone or tablet by clicking on the icon below.



Step 3: Select the projector from the list by name.

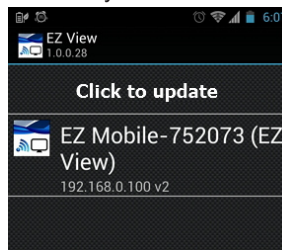

User Controls

Step 4: Enter the connection password shown on the screen.

The image shows two parts of the EZ View app setup process. On the left is a 'Media Display Laptop' configuration screen with four numbered steps:

1. Enable your laptop WiFi function, and search for AP to connect. (AP Name: EZ Mobile-752073)
2. Enter password (Password: 87654321)
3. open browser and enter ip address below and select & install application by OS (IP Address: 192.168.111.1)
4. open EZView and enter control code on the left-down side of the screen (Control Code: 8856)

The 'Control Code' field in step 4 is highlighted with a red box. A red arrow points from this box to a smartphone screen on the right. The smartphone screen shows an 'EZ View' notification with an 'Enter PIN' dialog box containing a masked PIN '****' and 'Cancel' and 'OK' buttons. Below the dialog is a numeric keypad.

Step 5: Select the function to stream to the projector via the EZ View APP.

The image displays four sequential screenshots of the EZ View app interface:

- Screenshot 1:** Shows the 'Devices' menu with options: PDF, Word, Excel, PowerPoint, Pages, Numbers, and Keynotes.
- Screenshot 2:** Shows the 'Camera' menu with a live video feed of a dog.
- Screenshot 3:** Shows the 'More' menu with options: Dropbox, Media, and Split Control.
- Screenshot 4:** Shows the 'More' menu with options: Dropbox, Media, and Split Control.

User Controls

Crestron

Use to control the projector.

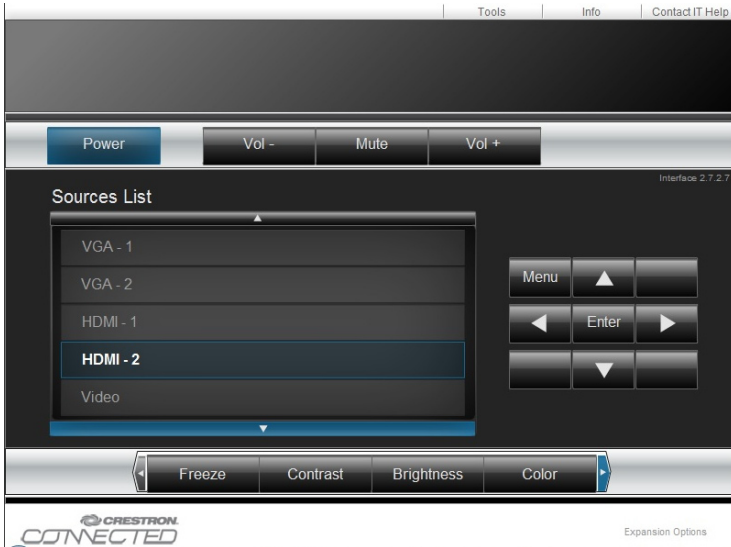

Character length limitations for entering Projector Information.

Category	Item	Input-Length (characters)
Crestron Control	IP Address	15
	IP ID	2
	Port	5
Projector	Projector Name	10
	Location	9
	Assigned To	9
Network Configuration	DHCP (Enabled)	(N/A)
	IP Address	15
	Subnet Mask	15
	Default Gateway	15
	DNS Server	15
User Password	Enabled	(N/A)
	New Password	15
Admin Password	Confirm	15
	Enabled	(N/A)
	New Password	15
	Confirm	15

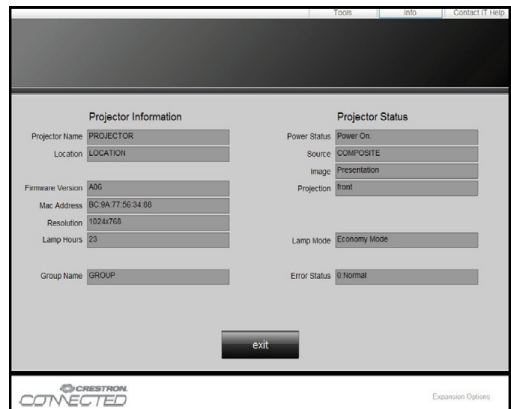

Crestron RoomView Control Tool

Crestron RoomView™ provides a central monitoring station for 250+ control systems on a single Ethernet network (more are possible, the number depends on the combination of IP ID and IP address). Crestron RoomView monitors each projector, including the projector's online status, system power, lamp life, network settings and hardware faults, plus any custom attribute as defined by the Administrator. The Administrator can add, delete, or edit room information, contact information and events, which are logged automatically by the software for all users. (Example of user interface below)

1. Main Screen

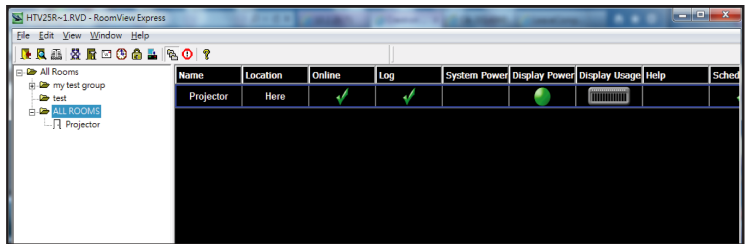

2. Edit Room



❖ Crestron RoomView's function is set according to the products' models and specifications.

The 'Edit Room' dialog box for 'crestron room' has tabs for General, Groups, Attributes, Assets, Contacts, and Events. The 'Room Information' section contains the following fields:

- Name: crestron room
- Location: [text box]
- IP Address: 192.168.0.101
- IPID/IP Port: 03 | 41794
- Phone: [text box]
- e Control Link: [text box] with a 'Browse...' button
- Video Link: [text box]
- DHCP Enabled
- External Gateway: [text box] with '0.0.0.0' below it
- SSL
- Username: [text box]
- Password: [text box]
- Comment: [text area]

Buttons at the bottom include 'Save Room', 'Save As', 'Help', 'OK', 'Cancel', and 'Apply'.

User Controls

3. Edit Attribute

33

General | Alert | Groups | Contacts |

Attribute Properties

Signal Name: Display Power Graphic: Off On

Device: None

Signal Type: Digital

Join Number: 5 Default Max. Value: 1

Options

Apply attribute to all rooms Display on main view

Apply attribute to all contacts Show on context menu *Advanced...*

Record attribute changes to log

OK Cancel Apply

4. Edit Event

34

General | Rooms |

Event Properties

Name: Display Off Warning Enable this event

Type: Digital Repeat event

Join: 5

Schedule

Start Date: 2010/ 9/ 2 Weekdays Weekends

End Date: 2010/ 9/ 2 Monday Saturday

Time: 0:00:00 Tuesday Sunday

Wednesday Thursday Friday

OK Cancel Apply

For further information, please visit:

<http://www.crestron.com> & www.crestron.com/getroomview.

Accessing Multimedia Files

This projector supports two methods to project media files (photos, videos, music, documents) stored on following devices:

- a. via Wireless dongle (see above) - wirelessly access the media files stored on your mobile phone, tablet PC, notebook, or desktop.
- b. via USB flash drive - directly access the media files stored on the device.

How to access Multimedia mode

1. Plug a USB flash drive into the projector's USB-A connector.
2. Turn on the projector.

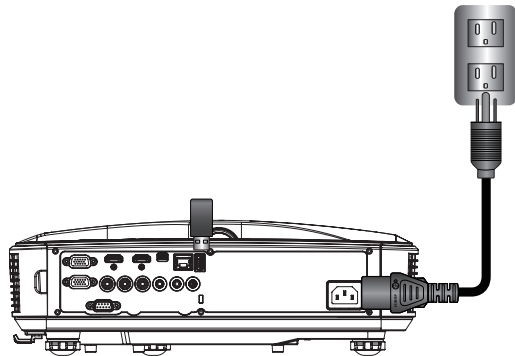

3. Press "INPUT" on the remote control or on the control panel and press the ▲▼ keys to select "Multimedia" and the "Enter" key to confirm.

Multimedia

USB Storage Display

To access the media files stored on your USB flash drive, do the following:

Supported File Formats

Multimedia Category	File Formats
<i>Photo</i>	<i>BMP, JPG</i>
<i>Music</i>	<i>MP3, WMA</i>
<i>Video</i>	<i>AVI, MOV, MP4, RM, RMVB, DAT, MPG, ISO, TS, MKV, VOB, and WMV</i>
<i>Document</i>	<i>WORD, EXCEL, PPT, PDF</i>

1. In the **Multimedia** menu, select **USB Disk**.

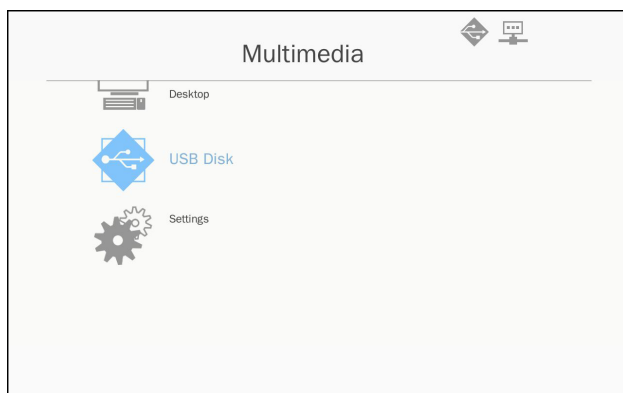

2. Use the ▲▼ keys to select the file category and press the "Enter" key.

Multimedia

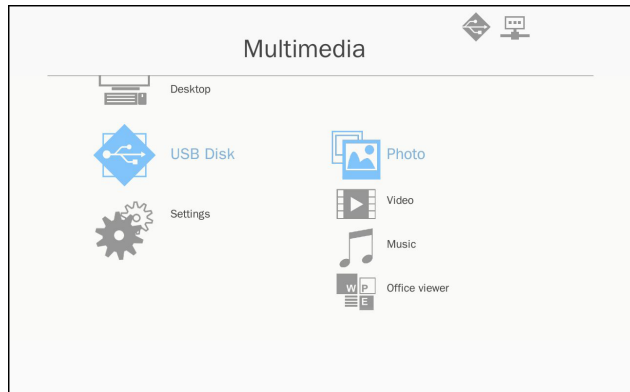

3. Use the ▲▼ keys to select the file to view/play and press the “Enter” key to confirm.

Configuring Multimedia Settings

To change the settings, do the following:

1. In the **Multimedia** menu, select **Settings**.

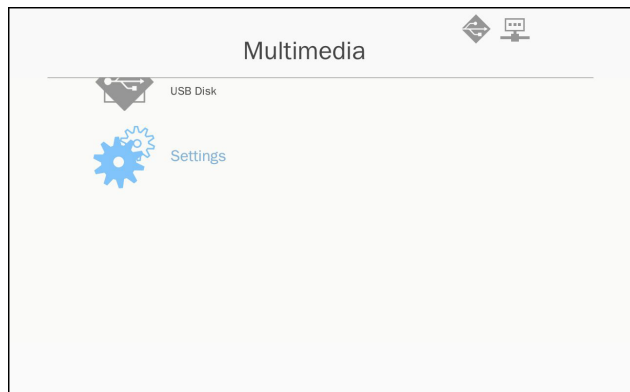

2. Use the ▲▼ keys to select the desired menu option and press the “Enter” key to enter the submenu.

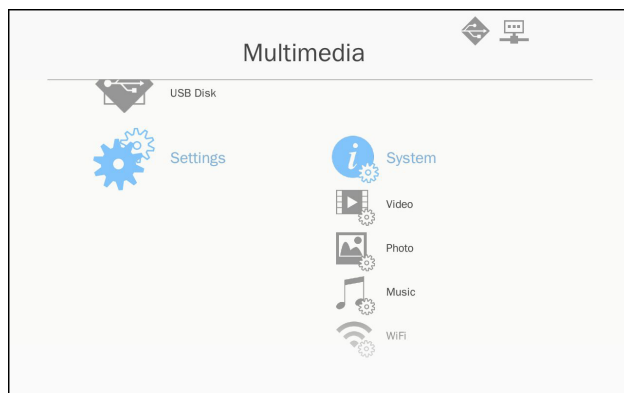

- ▶ System: Select this option to view the firmware version and update firmware.
 - ▶ Video: Select this option to change the display ratio and set the repeat mode.
 - ▶ Photo: Select this option to change the display ratio, slide-show pattern, and slideshow duration.
 - ▶ Music: Select this option to set the repeat mode.
 - ▶ WiFi: Select this option to configure the Wi-Fi connection.
3. Use the ▲▼ keys to select the adjust/select the setting and press the “Enter” key to confirm.

Compatibility Modes

► VGA Analog

a. PC signal			
Modes	Resolution	V. Frequency [Hz]	H. Frequency [KHz]
VGA	640x480	60	31.5
	640x480	67	35.0
	640x480	72	37.9
	640x480	75	37.5
	640x480	85	43.3
IBM	720x400	70	31.5
SVGA	800x600	56	35.1
	800x600	60	37.9
	800x600	72	48.1
	800x600	75	46.9
	800x600	85	53.7
Apple, MAC II	832x624	75	49.1
XGA	1024x768	60	48.4
	1024x768	70	56.5
	1024x768	75	60.0
	1024x768	85	68.7
	1024x768	120	99.0
Apple, MAC II	1152x870	75	68.7
SXGA	1280x1024	60	64.0
	1280x1024	72	77.0
	1280x1024	75	80.0
QuadVGA	1280x960	60	60.0
	1280x960	75	75.2
SXGA+	1400x1050	60	65.3
UXGA	1600x1200	60	75.0

Appendices

b. Extended wide timing			
Modes	Resolution	V. Frequency [Hz]	H. Frequency [KHz]
WXGA	1280x720	60	44.8
	1280x800	60	49.6
	1366x768	60	47.7
	1440x900	60	59.9
WSXGA+	1680x1050	60	65.3
UWHD	1920x720	60	44.4
Full HD	1920x1080	60	67.5
WUXGA with reduced blanking	1920x1200	60(RB)	74
c. Component signal			
Modes	Resolution	V. Frequency [Hz]	H. Frequency [KHz]
480i	720x480 (1440x480)	59.94(29.97)	15.7
576i	720x576 (1440x576)	50(25)	15.6
480p	720x480	59.94	31.5
576p	720x576	50	31.3
720p	1280x720	60	45.0
	1280x720	50	37.5
1080i	1920x1080	60(30)	33.8
	1920x1080	50(25)	28.1
1080p	1920x1080	23.98/24	27.0
	1920x1080	60	67.5
	1920x1080	50	56.3

Appendices

► HDMI Digital

a. PC signal			
Modes	Resolution	V. Frequency [Hz]	H. Frequency [KHz]
VGA	640x480	60	31.5
	640x480	67	35.0
	640x480	72	37.9
	640x480	75	37.5
	640x480	85	43.3
IBM	720x400	70	31.5
SVGA	800x600	56	35.1
	800x600	60	37.9
	800x600	72	48.1
	800x600	75	46.9
	800x600	85	53.7
Apple, MAC II	832x624	75	49.1
XGA	1024x768	60	48.4
	1024x768	70	56.5
	1024x768	75	60.0
	1024x768	85	68.7
	1024x768	120	99.0
Apple, MAC II	1152x870	75	68.7
SXGA	1280x1024	60	64.0
	1280x1024	72	77.0
	1280x1024	75	80.0
QuadVGA	1280x960	60	60.0
	1280x960	75	75.2
SXGA+	1400x1050	60	65.3
UXGA	1600x1200	60	75.0
Full HD	1920x1080	60	67.5
WUXGA with reduced blanking	1920x1200	60 (RB)	74

Appendices

b. Extended wide timing			
Modes	Resolution	V. Frequency [Hz]	H. Frequency [KHz]
WXGA	1280x720	60	44.8
	1280x800	60	49.6
	1366x768	60	47.7
	1440x900	60	59.9
WSXGA+	1680x1050	60	65.3
UWHD	1920x720	60	44.4
c. Video signal			
Modes	Resolution	V. Frequency [Hz]	H. Frequency [KHz]
480p	640x480	59.94/60	31.5
480i	720x480 (1440x480)	59.94(29.97)	15.7
576i	720x576 (1440x576)	50(25)	15.6
480p	720x480	59.94	31.5
576p	720x576	50	31.3
720p	1280x720	60	45.0
	1280x720	50	37.5
1080i	1920x1080	60(30)	33.8
	1920x1080	50(25)	28.1
1080p	1920x1080	23.98/24	27.0
	1920x1080	60	67.5
	1920x1080	50	56.3
d. HDMI 1.4a mandatory 3D timing- Video Signal			
Modes	Resolution	V. Frequency [Hz]	H. Frequency [KHz]
Frame Packing	720p	50	31.5
	720p	59.94/60	15.7
	1080p	23.98/24	15.6
Side-by-Side(Half)	1080i	50	31.5
	1080i	59.94/60	31.3
Top and Bottom	720p	50	45.0
	720p	59.94/60	37.5
	1080p	23.98/24	33.8

RS232 Commands and Protocol Function List

▶ RS232 Port Settings

Items	Method
Communication Method	Asynchronous Communication
Bits per seconds	19200
Data bits	8 bits
Parity	None
Stop bits	1
Flow control	None



- ❖ RS232 shell is grounded.

▶ RS232 Signals Connection

Computer COM Port
(D-Sub 9pin connector)

Projector COM Port
(D-Sub 9pin connector)

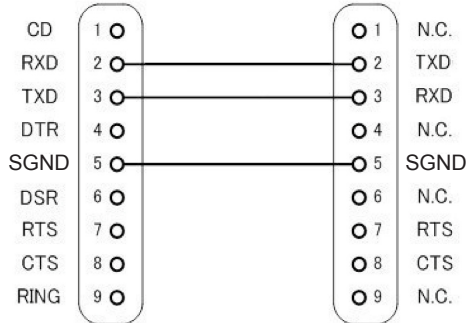

Appendices

▶ Set Commands

Command Description	ASCII Code	Projector Return	n value	Note
Power	#0000 n		0 : Off 1 : On	
Emulate Remote	#0001 n		1 : Up 2 : Left 3 : Right 4 : Down 5 : Menu 6 : Source 7 : Keystone+ 8 : Keystone- 9 : Volume+ 10 : Volume-	
Resync	#0002 1			VGA only
AV Mute (Blank)	#0003 n		0 : Off 1 : On	
Freeze	#0004 n		0 : Unfreeze 1 : Freeze	
Input Source	#0005 n		1 : VGA 1 2 : VGA 2 3 : HDMI 1 4 : HDMI 2 5 : Video 6 : Multimedia	
Color Mode	#0010 n		1 : Bright 2 : PC 3 : Movie 4 : Game 5 : User	
Brightness	#0011 n		0~100	
Contrast	#0012 n		0~100	
Sharpness	#0013 n		0~31	Video only

Appendices

Aspect Ratio	#0020 n		1 : Auto 2 : 4:3 3 : 16:9 4 : 16:10 / Ultra Wide	
Zoom	#0021 n		0 : Zoom- 1 : Zoom+	
Keystone	#0022 n		-40~40	
Orientation	#0023 n		1 : Front 2 : Rear 3 : Front Ceiling 4 : Rear Ceiling	
Language	#0030 n		1 : English 2 : German 3 : Swedish 4 : French 5 : Arabic 6 : Dutch 7 : Norwegian 8 : Danish 9 : Simplified Chinese 10 : Polish 11 : Korean 12 : Russian 13 : Spanish 14 : Traditional Chinese 15 : Italian 16 : Portuguese 17 : Turkish 18 : Japanese	
Menu Location	#0031 n		1 : Top Left 2 : Top Right 3 : Center 4 : Bottom Left 5 : Bottom Right	
Reset	#0032 1			
Mute	#0040 n		0 : Off 1 : On	
Volume	#0041 n		0~30	

Appendices

Microphone Volume	#0042 n		0~30	
Auto Power Off (min)	#0050 n		0~120	Step = 5
High Altitude	#0051 n		0 : Off 1 : On	

Read Commands

Color Mode Read	#00110 1	Okn	n : 1/2/3/4/5 = Bright / PC / Movie / Game / User	
Aspect Ratio Read	#00120 1	Okn	n : 1/2/3/4 = Auto / 4:3 / 16:9 / 16:10 (Ultra Wide)	
Input Source (curr. src)	#00160 1	Okn	n : 0/1/2/3/4/5/6 = None / VGA1 / VGA2 / HDMI1 / HDMI2 / Video / Multimedia	
Software Version	#00161 1	Okddd	ddd : FW version	
Information	#00162 1	Okabbbbccddeee	a : Power Status / b : LD Hour / c : Input Source / d : Firmware Version / e : Color mode	

Ceiling Mount Installation

1. To prevent damage to your projector, please use the InFocus ceiling mount.
2. If you wish to use a third party ceiling mount kit, please ensure the screws used to attach a mount to the projector meet the following specifications:
 - ▶ Screw type: M4*4
 - ▶ Minimum screw length: 10mm



❖ Please note that damage resulting from incorrect installation will void the warranty.



⚠ Warning:

1. If you buy a ceiling mount from another company, please be sure to use the correct screw size. Screw size will vary depending on the thickness of the mounting plate.
2. Be sure to keep at least 10 cm gap between the ceiling and the bottom of the projector.
3. Avoid installing the projector near a heat source.

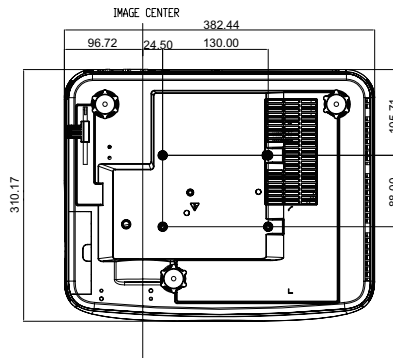
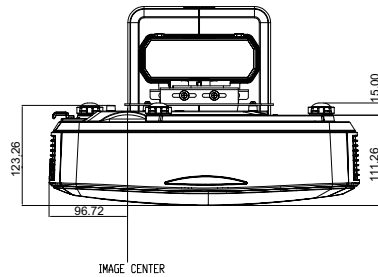

Regulation & Safety Notices

This appendix lists the general notices of your projector.

FCC notice

This device has been tested and found to comply with the limits for a Class B digital device pursuant to Part 15 of the FCC rules. These limits are designed to provide reasonable protection against harmful interference in a residential installation. This device generates, uses and can radiate radio frequency energy and, if not installed and used in accordance with the instructions, may cause harmful interference to radio communications.

However, there is no guarantee that interference will not occur in a particular installation. If this device does cause harmful interference to radio or television reception, which can be determined by turning the device off and on, the user is encouraged to try to correct the interference by one or more of the following measures:

- Reorient or relocate the receiving antenna.
- Increase the separation between the device and receiver.
- Connect the device into an outlet on a circuit different from that to which the receiver is connected.
- Consult the dealer or an experienced radio/television technician for help.

Notice: Shielded cables

All connections to other computing devices must be made using shielded cables to maintain compliance with FCC regulations.

Caution

Changes or modifications not expressly approved by the manufacturer could void the user's authority, which is granted by the Federal Communications Commission, to operate this projector.

Operating Conditions

This device complies with Part 15 of the FCC Rules. Operation is subject to the following two conditions:

1. This device may not cause harmful interference and
2. This device must accept any interference received, including interference that may cause undesired operation.

Notice: Canadian users

This Class B digital apparatus complies with Canadian ICES-003.

Remarque à l'intention des utilisateurs canadiens

Cet appareil numérique de la classe B est conforme à la norme NMB-003 du Canada.

Declaration of Conformity for EU countries

- EMC Directive 2014/30/EU
- Low Voltage Directive 2014/35/ EU
- (RED) 2014/53/EU (if product has RF function)

Disposal instructions



Do not throw this electronic device into the trash when discarding. To minimize pollution and ensure utmost protection of the global environment, please recycle it.

Appendices

Safety notice

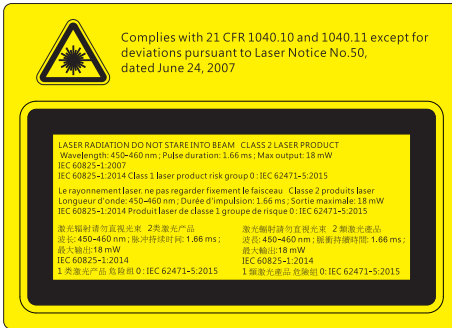

WARNING

- This projector is a Class 2 laser device that conforms with IEC 60825-1:2007 and CFR 1040.10 and 1040.11.
- Class 2 laser product, Do Not Stare Into Beam.
- IEC 60825-1:2014 Class 1 laser product/risk group 0 IEC 62471-5:2015.
- This projector has a built-in Class 4 laser module. Disassembly or modification is very dangerous and should never be attempted.
- Any operation or adjustment not specifically instructed by the user's guide creates the risk of hazardous laser radiation exposure.
- Do not open or disassemble the projector as this may cause damage from exposure to laser radiation.
- Do not stare into the beam when the projector is on. The bright light may result in permanent eye damage.
- Failure to follow the control adjustment or operation procedures may cause damage from exposure to laser radiation.
- Adequate instructions for assembly, operation, and maintenance, including clear warnings concerning precautions to avoid possible exposure to laser and collateral radiation in excess of the accessible emission limits in Class 2.