



# Thor™ VM2

---

Vehicle-Mount Computer

Microsoft® Windows® Embedded CE 6 Operating System

## User's Guide

---

# Disclaimer

Honeywell International Inc. ("HII") reserves the right to make changes in specifications and other information contained in this document without prior notice, and the reader should in all cases consult HII to determine whether any such changes have been made. The information in this publication does not represent a commitment on the part of HII.

HII shall not be liable for technical or editorial errors or omissions contained herein; nor for incidental or consequential damages resulting from the furnishing, performance, or use of this material.

This document contains proprietary information that is protected by copyright. All rights are reserved. No part of this document may be photocopied, reproduced, or translated into another language without the prior written consent of HII.

© 2012-2013 Honeywell International Inc. All rights reserved.

Web Address: [www.honeywellaidc.com](http://www.honeywellaidc.com)

RFTerm is a trademark or registered trademark of EMS Technologies, Inc. in the United States and/or other countries.

Microsoft® Windows, ActiveSync®, MSN, Outlook®, Windows Mobile®, the Windows logo, and Windows Media are registered trademarks or trademarks of Microsoft Corporation.

Intel® and Atom™ are trademarks or registered trademarks of Intel Corporation or its subsidiaries in the United States and other countries.

Summit Data Communications, the Laird Technologies Logo, the Summit logo, and "Connected. No Matter What" are trademarks of Laird Technologies, Inc.

The Bluetooth® word mark and logos are owned by the Bluetooth SIG, Inc.

Symbol® is a registered trademark of Symbol Technologies. MOTOROLA, MOTO, MOTOROLA SOLUTIONS and the Stylized M Logo are trademarks or registered trademarks of Motorola Trademark Holdings, LLC and are used under license.

Wavelink®, the Wavelink logo and tagline, Wavelink Studio™, Avalanche Management Console™, Mobile Manager™, and Mobile Manager Enterprise™ are trademarks of Wavelink Corporation, Kirkland.

RAM® and RAM Mount™ are both trademarks of National Products Inc., 1205 S. Orr Street, Seattle, WA 98108.

Verizon® is a registered trademark of Verizon Trademark Services LLC.

T-MOBILE® is a registered trademark of Deutsche Telekom AG.

AT&T® is a registered trademark of AT&T Intellectual Property.

Acrobat® Reader © 2013 with express permission from Adobe Systems Incorporated.

Other product names or marks mentioned in this document may be trademarks or registered trademarks of other companies and are the property of their respective owners.

## Patents

For patent information, please refer to [www.honeywellaidc.com/patents](http://www.honeywellaidc.com/patents).

## Limited Warranty

Refer to [www.honeywellaidc.com/warranty\\_information](http://www.honeywellaidc.com/warranty_information) for your product's warranty information.

# Table of Contents

<b>Chapter 1 - Introduction</b>	<b>1-1</b>
About this Guide	1-1
End User License Agreement (EULA)	1-1
Components	1-2
Front View	1-2
Back View Quick Mount Smart Dock	1-3
Access Panels	1-3
Keyboard Options	1-4
Integrated Keypad	1-4
Blue Key	1-4
Orange Key	1-5
95-Key External Keyboard	1-6
Keyboard Backlight	1-6
USB Keyboard / Mouse	1-6
<b>Chapter 2 - Set Up A New Thor VM2</b>	<b>2-1</b>
Hardware Setup	2-1
Software Setup	2-1
Quick Mount Smart Dock	2-2
Preparing the Dock	2-3
Place the Thor VM2 in the Dock	2-4
Removing the Thor VM2 from the Dock	2-4
Backlights and Indicators	2-5
Display Backlight	2-5
Power Management	2-5
Backlight Brightness	2-5
Screen Blanking	2-5
Keypad Backlight	2-5
LED Functions	2-6
System LEDs	2-7
SYS (System Status) LED	2-7
UPS Status LED	2-8
Charge Level	2-8
Charging State	2-8
SSD (Solid State Drive) LED	2-8
Connection LEDs	2-9
WWAN LED	2-9
WiFi LED	2-9
Bluetooth LED	2-9

---

Keyboard LEDs.....	2-10
Blue LED.....	2-10
Orange LED.....	2-10
Programmable LED.....	2-10
Power Up.....	2-11
Tapping the Touch Screen with a Stylus.....	2-12
Set Power Scheme Timers.....	2-13
UPS Power Scheme.....	2-13
AC/DC Power Scheme.....	2-13
Ignition Control Power Scheme, Ignition On.....	2-13
Ignition Control Power Scheme, Ignition Off.....	2-14
Auto On Power Scheme.....	2-14
Adjust Speaker Volume.....	2-15
Using the Keypad.....	2-15
Using the Control Panel.....	2-15
Set Date and Time Zone.....	2-16
Grab Time Utility.....	2-16
Autolaunch Time-Sync.....	2-16
Synchronize with a Local Time Server.....	2-16
Touch Screen.....	2-17
Calibrating the Touch Screen.....	2-17
Apply the Touch Screen Protective Film.....	2-17
Installation.....	2-17
Removal.....	2-18
Using the Input Panel / Virtual Keyboard.....	2-19
Setup Terminal Emulation Parameters.....	2-20
Using the AppLock Switchpad.....	2-21
Using the Keypad.....	2-21
Using the Touch Screen.....	2-21
Connecting Bluetooth Devices.....	2-22
Taskbar Connection Indicator.....	2-22
Reboot.....	2-23
Warmboot.....	2-23
Restart.....	2-23
Cleaning the Touch Screen.....	2-24
Startup Help.....	2-25
<b>Chapter 3 - Connecting Cables to the Thor VM2.....</b>	<b>3-1</b>
Connect External Keyboard.....	3-1
Connect Cable - USB Client.....	3-2

---

Connect Cable - USB Host .....	3-2
Connect Cable - Serial.....	3-3
Connect a Tethered Scanner.....	3-3
Connecting the Headset Cable.....	3-4
Adjust Headset / Microphone and Secure Cable.....	3-5
Connecting an AC/DC Power Supply.....	3-6
Connecting Vehicle Power.....	3-7
Vehicle 10-60VDC Power Connection.....	3-7
Connect Vehicle 10-60VDC.....	3-8
Ignition Control.....	3-9
Auto-On Control.....	3-10
Manual Control.....	3-11
VX6 / VX7 Adapter Cable.....	3-12
Vehicle 72-144VDC Power Connection.....	3-13
Connect Vehicle 72-144VDC.....	3-14
Wiring Diagram.....	3-15
Thor VM2 Screen Blanking.....	3-16
Screen Blanking Box.....	3-17
Screen Blanking with Switch.....	3-18
Fuse.....	3-19
<b>Chapter 4 - Product Agency Compliance - Thor VM2.....</b>	<b>4-1</b>
Lithium Battery Safety Statement.....	4-5
Vehicle Power Supply Connection Safety Statement.....	4-7
<b>Chapter 5 - Technical Assistance.....</b>	<b>5-1</b>



# Chapter 1 - Introduction

The Honeywell Thor VM2 Vehicle Mount Computer (VMC) is a rugged, vehicle mounted computer running a Microsoft Windows®CE 6 operating system and capable of wireless data communications from a fork-lift truck or any properly configured vehicle.

The optional Bluetooth® module supports Honeywell Bluetooth printers and scanners. The Thor VM2 provides the power and functionality of a desktop computer in a vehicle mounted unit, with a wide range of options.

The Thor VM2 is designed for use with a vehicle Quick Mount Smart Dock. The dock installs in the vehicle and connects to vehicle power. The dock provides conditioned input power for the Thor VM2. Peripheral connections are on the dock. The Thor VM2 is designed to easily be removed from the dock with a latch on the lower rear of the Thor VM2 housing. Since the dock remains attached to the vehicle, the Thor VM2 computer can easily be moved from one vehicle equipped with a Quick Mount Smart Dock to another vehicle equipped with a Quick Mount Smart Dock.

The Thor VM2 contains a UPS battery which, when fully charged, can power the Thor VM2 for a minimum of 30 minutes. This can be when the Thor VM2 is not attached to a Quick Mount Smart Dock or when the Thor VM2 is attached to a dock but the vehicle power is interrupted, such as when the vehicle battery is being changed.

## About this Guide

This Thor VM2 User's Guide provides instruction for the end-user or system administrator to follow when setting up a new Thor VM2.

This user's guide has been developed for a Thor VM2 with a Microsoft® Windows® Embedded CE 6 operating system.

## End User License Agreement (EULA)

When a new Thor VM2 starts up a EULA is displayed on the touch screen. It remains on the screen until the Accept or Decline button is tapped with a stylus.

Tap the Accept button to accept the EULA terms and the Thor VM2 continues the startup process. The EULA is not presented to the user again.

Tap the Decline button to decline the EULA and the Thor VM2 will reboot. It will continue to reboot until the Accept button is tapped with the stylus.

*Note: The EULA will be presented after any operating system upgrade or re-installation, including language-specific operating systems.*

---

## Components

### *Front View*

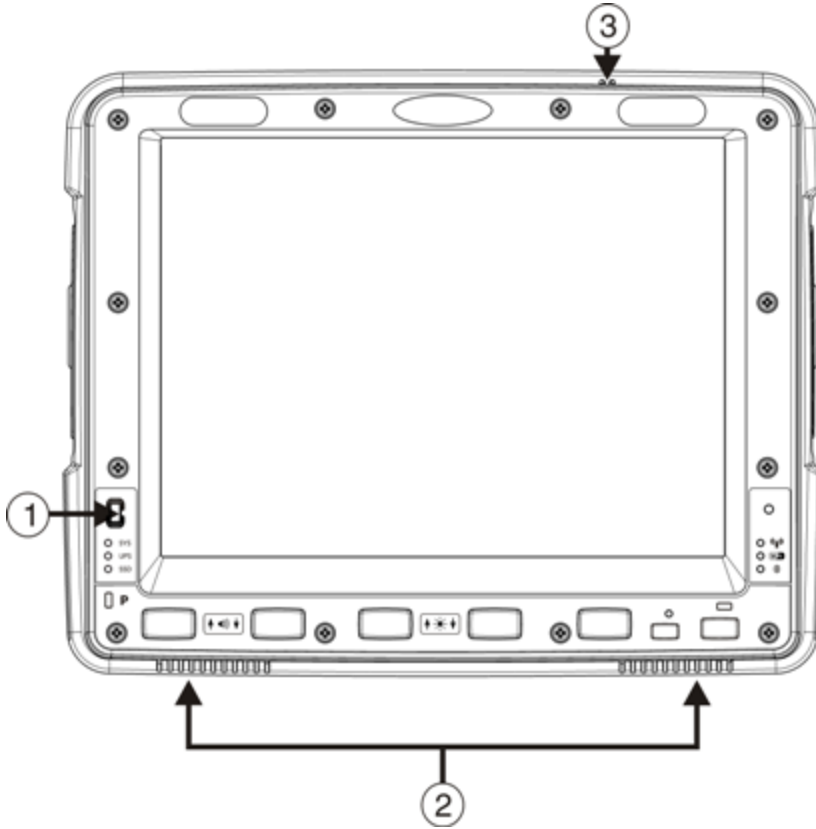

1. Power Button
2. Speakers
3. Microphone



## Back View Quick Mount Smart Dock

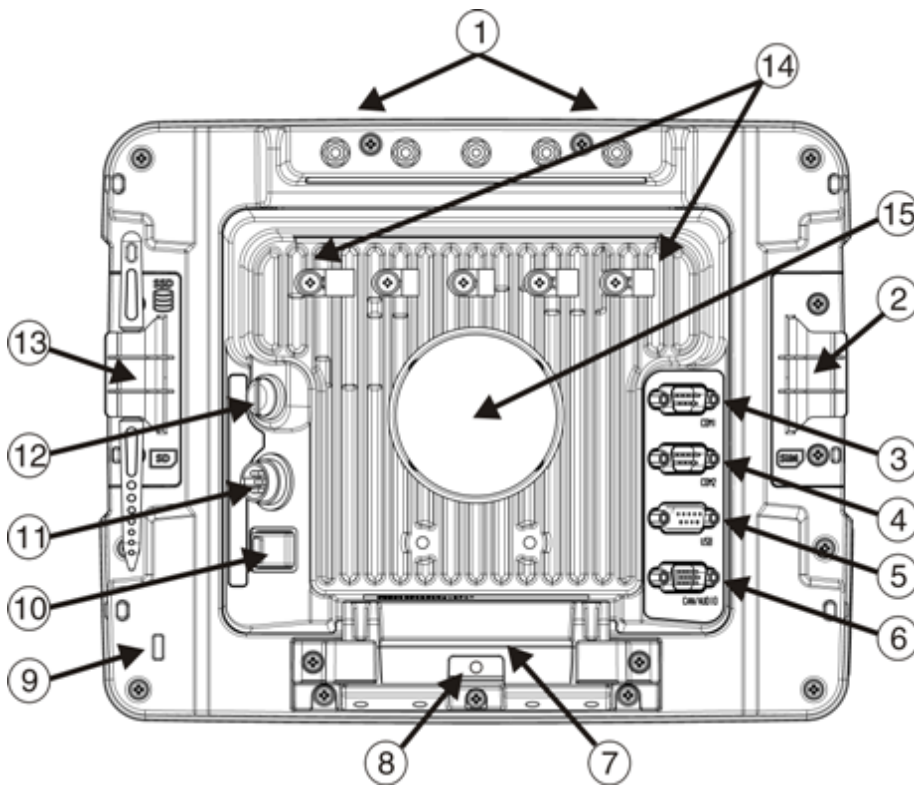

1. Antenna Connectors (on Thor VM2)
2. SIM card Access Panel (on Thor VM2)
3. COM1 Connector (on Dock)
4. COM2 Connector (on Dock)
5. USB Connector (on Dock)
6. CAN/Audio Connector (on Dock)
7. Quick Release Handle (On Thor VM2)
8. Provision for Padlock (on Thor VM2)
9. Provision for Laptop Security Cable (on Thor VM2)
10. Power Switch (on Dock)
11. Power Connector (on Dock)
12. Fuse (on Dock)
13. SD Card Access Panel (On Thor VM2)
14. Strain Relief Clamps (on Dock)
15. RAM Ball (on Dock)

## Access Panels

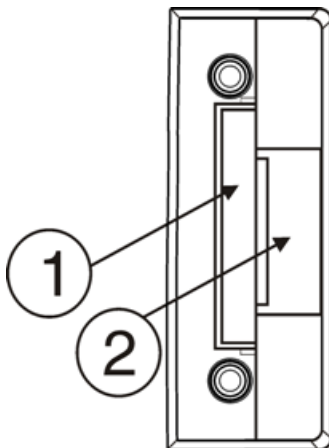

Access Panel Door is labeled with **SSD** and **SD**.

1. CompactFlash Hard Drive
2. SD (Secure Digital) Memory Card Slot

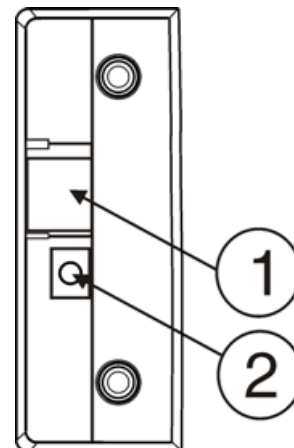

Access Panel Door is labeled with **SIM**.

1. SIM card slot for WWAN radio
2. UPS battery disconnect

---

## Keyboard Options

The Thor VM2 has an integrated keypad with five programmable keys and an available external keyboard.

### Integrated Keypad



The integrated keypad contains five programmable keys, a blue modifier key and an orange modifier key. Press Orange plus P1-P5 to access P6-P10. The default programmable key functions are described below. Default functions may be overridden by custom settings. Consult your system administrator.

Key	Assigned Function	Key	Assigned Function
P1	F1	P6	Not assigned
P2	F2	P7	Not assigned
P3	F3	P8	Not assigned
P4	F4	P9	Not assigned
P5	F5	P10	Not assigned

### Blue Key

When the Blue LED is illuminated, the programmable keys are used to adjust speaker volume and display brightness. Press the **Blue** key to enter Blue mode and then press

- **P1** to Increase speaker volume
- **P2** to Decrease speaker volume
- **P3** to Increase display brightness
- **P4** to Decrease display brightness
- No function is assigned to **P5** in Blue mode

The Blue key has a five second timeout. If the Blue key is pressed and no additional key is pressed within the five second timeout period, the Blue modifier mode is exited and the Blue LED is turned off.

When the Blue modifier key is active, the LED located next to the key is illuminated. The modifier key remains active until:

- The Blue modifier key is pressed again, or
- The Orange modifier key is pressed, or
- A five second timeout with no keypress occurs.

---

## **Orange Key**

When the Orange LED is illuminated, the programmable keys provide the secondary function.

- Orange + P1 = P6
- Orange + P2 = P7, etc.

When the Orange modifier key is active, the LED located next to the key is illuminated. The modifier key remains active until:

- The Orange modifier key is pressed again, or
- A non-modifier key is pressed (i.e.: P1-P5), or
- The Blue modifier key is pressed.

---

## 95-Key External Keyboard



The Thor VM2 uses an optional rugged QWERTY 95 key keyboard, designed for ease of use with the Windows CE operating system. The keyboard connects directly to the D9 USB connector on the Thor VM2 Quick Mount Smart Dock.

- The 95 key keyboard supports all 104 keyboard functions (101 standard keyboard plus Windows keys) and includes an integrated pointing device and left and right mouse buttons. However, because the keyboard only has 95 keys, all functions are not visible (or printed on the keyboard). Therefore the keyboard supports what is called hidden keys - keys that are accessible but not visible on the keyboard.
- The 95 key keyboard keys are backlit. The keyboard backlight is manually controlled.

### ***Keyboard Backlight***

The keyboard backlight key in the top right hand corner has a light bulb icon.

The keyboard keys are backlit. The keyboard backlight is manually controlled using the backlight key in the upper right hand corner of the keyboard. Pressing the backlight key cycles the keyboard backlight through the levels of backlight intensity: Off, Low intensity, Medium intensity, Maximum intensity, Off, etc. When the Thor VM2 is powered on, the keyboard backlight defaults to Off.

By default, the external keypad backlight turns off when the Thor VM2 enters Suspend.

### **USB Keyboard / Mouse**

A standard USB keyboard or mouse can be attached to the Thor VM2 using the appropriate dongle cable.

The dongle cable attaches to the Thor VM2 and provides a USB connector. Please refer to documentation provided with the USB keyboard or mouse for more information on their operation.

# Chapter 2 - Set Up A New Thor VM2

This page lists a quick outline of the steps you might take when setting up a new Thor VM2. More instruction for each step is listed later in this guide. Please refer to the *Thor VM2 Reference Guide* for additional information and instruction.

Contact [Technical Assistance](#) if you need additional help.

*Note: Installing or removing accessories should be performed on a clean, well-lit surface. When necessary, protect the work surface, the Thor VM2, and components from electrostatic discharge.*

<p>Caution</p> 	<p>Before shipping, the internal UPS battery must be disconnected. Please refer to the <i>Thor VM2 Reference Guide</i> for details.</p>
--	---

## Hardware Setup

1. Connect accessories to the [Quick Mount Smart Dock](#).
2. [Connect cables](#).
3. Connect power cable to the dock.
4. Secure all cables to the dock with the Strain Relief Cable Clamps.
5. Secure the Thor VM2 in the dock.
6. Press the power switch on the dock.
7. Press the Power key.

## Software Setup

Hardware setup should be completed before starting software setup.

1. [Calibrate Touch screen](#)
2. [Set Date and Time Zone](#)
3. Set Power Schemes Timers
4. [Adjust Speaker Volume](#)
5. [Pair Bluetooth devices](#)
6. Setup Wireless client parameters
7. Setup [terminal emulation](#) parameters
8. [Save changed settings](#) to the registry
9. Setup the AppLock parameters
10. Set the DC Wedge parameters

Please refer to the *Thor VM2 Reference Guide* for additional information and instruction.

---

## Quick Mount Smart Dock

The Thor VM2 assembly consists of two parts, the Thor VM2 computer and the Quick Mount Smart Dock.

The Thor VM2 contains an internal UPS battery that, once fully charged, powers the Thor VM2 for a minimum of 30 minutes when the unit is not mounted in the dock.

The Dock provides:

- A mount for the Thor VM2 computer. The Dock attaches to a vehicle via a RAM or U-bracket mount.
- Conditioned power for the Thor VM2. The Dock accepts 10-60VDC power input directly or 72-144VDC power input with a DC/DC converter.
- COM1 and COM2 serial connections for a tethered scanner, printer, PC connection, etc.
- USB host and client connections via an adapter cable.
- CANbus connection via an adapter cable.
- Headset connection via an adapter cable. When a headset is not attached, the microphone and speakers on the Thor VM2 are active.
- Strain relief cable mounts.
- Mobility of the Thor VM2, since the Dock remains attached to the vehicle the Thor VM2 computer can easily be moved from one vehicle equipped with a Dock to another.

External antenna connectors may be present on the back of the Thor VM2. The connectors may include:

- 802.11 antenna connectors, used when the Thor VM2 is not equipped with internal antennas.
- External GPS antenna connector, when the Thor VM2 is equipped with GPS.
- External WWAN antenna connectors, when the Thor VM2 is equipped with WWAN.

Optional WWAN radio (available in North America, Europe, New Zealand, and Australia only).

---

## Preparing the Dock

1. Attach RAM mount to vehicle (see *Thor VM2 Vehicle Mounting Reference Guide*).
2. [Attach accessories](#) to dock.
3. Attach power cable, [10-60VDC](#) or [72-144VDC](#).
4. If the tethered I/O port cover is in place, lift the cover to expose the I/O port on the dock. The tether allows the cover to be swung over the back of the dock.

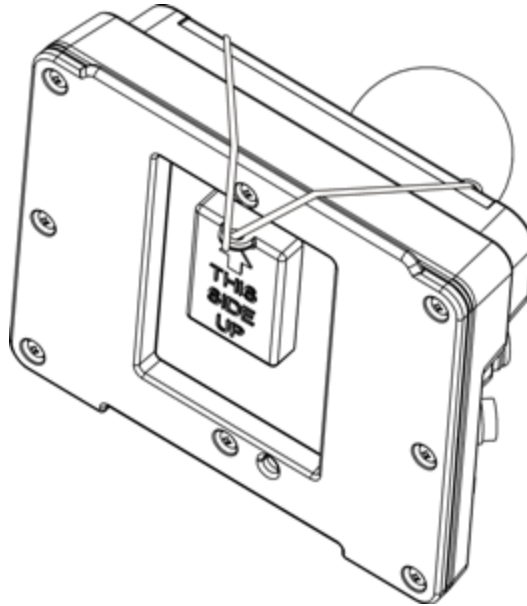

---

## Place the Thor VM2 in the Dock

Back of Thor VM2

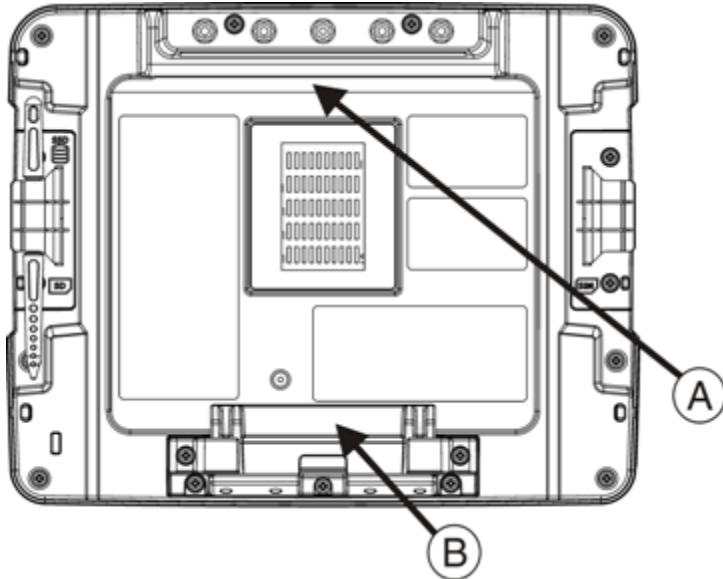

Front of Quick Mount Smart Dock

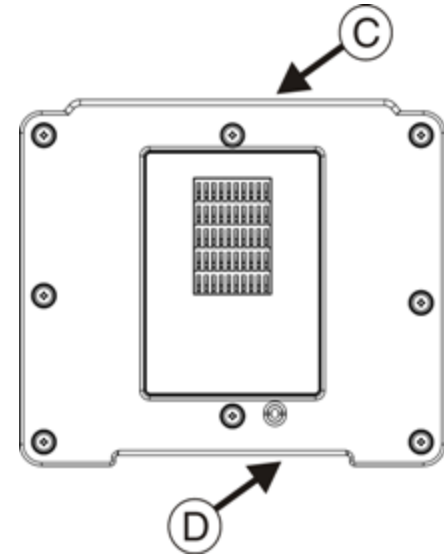

- A. Notch on Thor VM2
- B. Release lever

- C. Upper Lip on Dock
- D. Lower Lip on Dock

1. Locate the notch on the upper rear of the Thor VM2 (item A above).
2. Slide this notch over the top lip (C) of the Dock. Slide the Thor VM2 from side to side on the Dock to make sure it fully engages on the lip of the Dock. If the Thor VM2 cannot be slid side to side, the lip is engaged.
3. Pull the quick release lever (B) on the Thor VM2 down and push the Thor VM2 against the Dock.
4. Release the quick release lever. The quick release lever catches the lower lip on the Dock and secures the Thor VM2 to the Dock.
5. If necessary, adjust the viewing angle of the Thor VM2.

## Removing the Thor VM2 from the Dock

The Thor VM2 may be removed from the Quick Mount for limited periods of use or the transfer from vehicle to vehicle. The UPS battery inside the Thor VM2 powers a fully functional Thor VM2 for a minimum of 30 minutes.

To remove the Thor VM2 from the Dock:

1. Pull the quick release lever (item B) downward on the back of the Thor VM2.
2. Pull the bottom of the Thor VM2 away from the Dock.
3. Lift the Thor VM2 away from the Dock.



---

## Backlights and Indicators

### ***Display Backlight***

There are several configuration options for the Thor VM2 display backlight:

### **Power Management**

The display backlight is controlled by power management. When the user activity timer expires, the display backlight is turned off. Different timeouts can be set for when the Thor VM2 is operating in the following power configuration modes:

- AC/DC Mode
- Ignition Mode (ignition on)
- Ignition Mode (ignition off)
- Auto-on Mode
- UPS.

Please refer to the *Thor VM2 Reference Guide* for details.

### **Backlight Brightness**

The intensity of the display backlight can be manually configured:

Brightness control does not “roll-over” from minimum to maximum or from maximum to minimum. Continuously holding down the up or down arrow keys does not cause an automatic repeat of the up (or down) arrow key.

### **Screen Blanking**

The Thor VM2 can be configured to blank (blackout) the display while the vehicle is in motion.

Please refer to the *Thor VM2 Reference Guide* for details.

### **Keypad Backlight**

By default, the integrated keypad backlight follows the display backlight. The integrated keypad backlight can be disabled.

Please refer to the *Thor VM2 Reference Guide* for details.

The external USB keyboard backlight is manually controlled.

---

## LED Functions

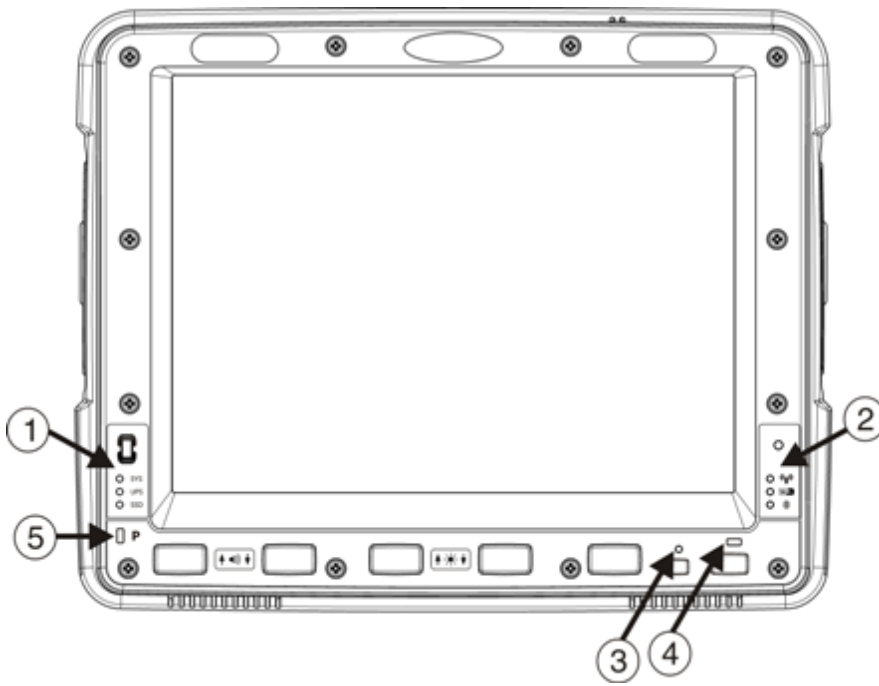

1. System LEDs
2. Connection LEDs
3. Blue LED
4. Orange LED
5. Programmable LED

## System LEDs

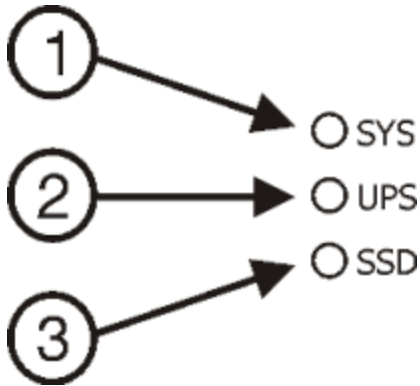

1. SYS (System Status) LED
2. UPS (Uninterruptible Power Supply) LED
3. SSD (Solid State Drive) LED

### SYS (System Status) LED

LED Behavior	System State
Solid Green	<ul style="list-style-type: none"> <li>• On</li> <li>• On but Backlight Off</li> <li>• On but Display Off</li> </ul>
Green blinking very slowly External power present (1/2 sec. on, 4 1/2 sec. off)	<ul style="list-style-type: none"> <li>• Suspend</li> </ul>
Off External power present	<ul style="list-style-type: none"> <li>• Off</li> </ul>
Off External power not present	<ul style="list-style-type: none"> <li>• Off,</li> <li>• Suspend</li> </ul>
Green blinking slowly External power present (1/2 sec. on, 1 1/2 sec. off)	CPU temperature less than -20°C, Heater warming CPU for 30 sec.
Green blinking slowly External power not present (1/2 sec. on, 1 1/2 sec. off)	CPU temperature less than -20°C, Need to move unit to warmer environment

---

## UPS Status LED

The color of the UPS LED identifies the charge level and the behavior of the LED identifies the charging state.

### *Charge Level*

LED Color	Status
Green	Fully charged (>90%)
Amber	<ul style="list-style-type: none"><li>• Less than fully charged, but more than 2 minutes runtime remaining,</li><li>• Out of safe charging temperature range (charging only occurs between approximately -10°C and 35°C ambient temperature),</li><li>• No UPS present,</li><li>• Charge timeout (not fully charged after 4 or 8 hours depending on software revision).</li></ul>
Red	Low battery, less than 2 minutes runtime until shutdown

### *Charging State*

LED Behavior	Status
Slow Blink (1 sec. on, 3 sec. off)	Charging.
Fast Blink (1/2 sec. on, 1/2 sec. off)	UPS supplying power and discharging.
On	Neither charging or discharging.
Off	Unit is off or is in Suspend.

## SSD (Solid State Drive) LED

LED Behavior	Status
Flashing Green	SSD read or write activity.
Off	No SSD read or write activity.

---

## Connection LEDs

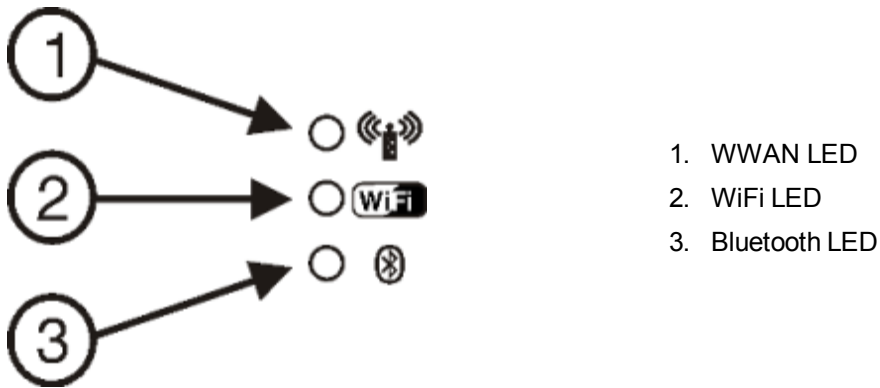

### WWAN LED

LED Behavior	Status
Solid Green	Indicates a WWAN connection to a network.
Off	Indicates no WWAN connection.

### WiFi LED

LED Behavior	Status
Solid Green	Indicates a connection with an IP address to an Access Point
Off	Indicates no connection to an Access Point.

### Bluetooth LED

LED Behavior	Status
Blue Blinking Slowly	Bluetooth is paired but not connected to a device.
Blue Blinking Medium	Bluetooth is paired and connected to a device.
Blue Blinking Fast	Bluetooth is discovering Bluetooth devices.
Off	Bluetooth hardware has been turned off.

---

## Keyboard LEDs

The keyboard LEDs are located near the specified key.

### Blue LED

LED Behavior	Status
Solid Blue	<ul style="list-style-type: none"><li>Indicates the <b>Blue</b> modifier key is active. Blue modifier mode is invoked for the next keypress.</li><li>Pressing the <b>Blue</b> key a second time exits this modifier mode and turns off the LED.</li><li>Pressing the <b>Orange</b> key exits the Blue mode and turns off the Blue LED.</li><li>When Blue mode is active, keys P1 through P4 provide volume and brightness adjustment functions.</li></ul>
Off	Blue mode is not invoked.

### Orange LED

LED Behavior	Status
Solid Orange	<ul style="list-style-type: none"><li>Indicates the <b>Orange</b> modifier key is active. Orange mode is invoked for the next keypress only.</li><li>Pressing the <b>Orange</b> key a second time exits this modifier mode and turns off the LED.</li><li>Pressing the <b>Blue</b> key exits the Orange mode and turns off the Orange LED.</li></ul>
Off	Orange mode is not invoked.

### Programmable LED

LED Behavior	Status
Controlled by application	Refer to application developer for LED behavior details
Off	Default mode. Refer to application developer for LED behavior details

---

## Power Up



If a USB drive, such as a thumb drive is attached to the Thor VM2, the device attempts to boot from the USB drive and cannot. Please remove the USB drive and power up the Thor VM2 again.

The Quick Mount Smart Dock has a power switch on the back.

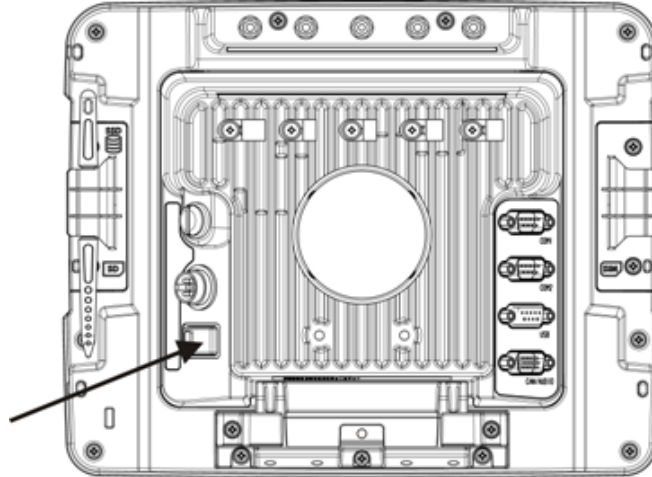

The "On" side of this rocker switch has a raised bump to allow the state of the switch to be determined when the switch may not be easily viewed, for example, after the Dock is mounted in a vehicle.

After external power has been connected and the Thor VM2 has been mounted in the Dock, press the side of the power switch with the raised bump to pass power from the Dock to the Thor VM2. Generally, once the Dock is powered On, there is no need to power if Off.

Next locate the [power button](#) on the front of the Thor VM2.

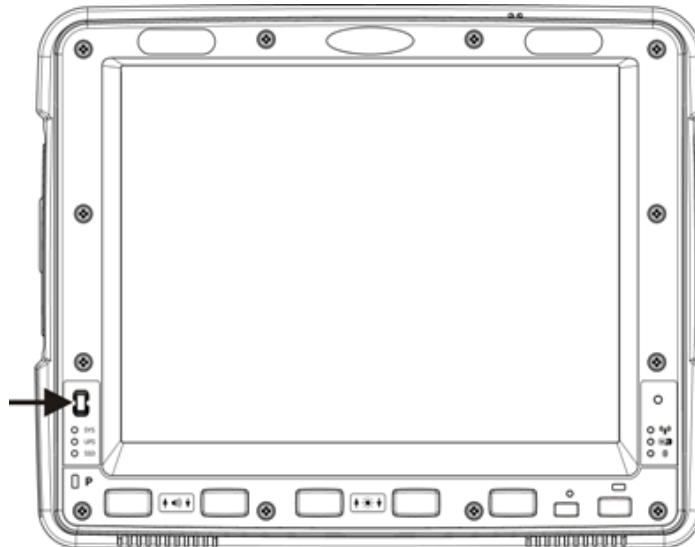

Press the power button to turn the Thor VM2 on. When the Windows desktop is displayed or an application begins, the power up sequence is complete.

---

## Tapping the Touch Screen with a Stylus

*Note:* Always use the point of the stylus for tapping or making strokes on the touch screen.

**Never use an actual pen, pencil, or sharp/abrasive object to write on the touch screen.**

Hold the stylus as if it were a pen or pencil. Touch an element on the screen with the tip of the stylus then remove the stylus from the screen.

Firmly press the stylus into the stylus holder when the stylus is not in use.

Using a stylus is similar to moving the mouse pointer then left-clicking icons on a desktop computer screen.

Using the stylus to tap icons on the touch screen is the basic action that can:

- Open applications
- Choose menu commands
- Select options in dialog boxes or drop-down boxes
- Drag the slider in a scroll bar
- Select text by dragging the stylus across the text
- Place the cursor in a text box prior to typing in data
- Place the cursor in a text box prior to retrieving data using a scanner/imager or an input/output device connected to a serial port.

A stylus replacement kit is available.



---

## Set Power Scheme Timers

Start > Settings > Control Panel > Power > Schemes

Change the parameter values and tap OK to save the changes.

User Idle	An amount of time has passed, set by the User Idle timer, and the device shuts down a minimum number of services e.g., backlights. The System Idle timer and the Suspend timer have not expired yet.
System Idle	An amount of time has passed, set by the System Idle timer, and the device shuts down a few more services e.g., display. The System Idle timer has expired and the Suspend timer has not expired yet.
Suspend	Suspend mode is entered when (1) the unit is inactive for a predetermined period of time, (2) the user taps the Power key, or (3) Start > Suspend is chosen. Inactivity means that internal devices that reset the power state are not active and the Suspend Timer has expired.
Shutdown	An amount of time has passed, set by the Shutdown timer, and the Thor VM2 performs an orderly shutdown.

### ***UPS Power Scheme***

This power scheme is automatically selected any time the Thor VM2 is operating from UPS power. This scheme overrides any user selected power configuration mode.

Switch state to User Idle	Default is After 30 seconds
Switch state to System Idle	Default is After 1 minute
Switch state to Suspend	Default is After 10 minutes
Shutdown	Default is After 20 minutes

### ***AC/DC Power Scheme***

This power scheme is used when the AC/DC power configuration mode is selected.

Switch state to User Idle	Default is After 15 minutes
Switch state to System Idle	Default is After 1 hour
Switch state to Suspend	Default is After 8 hours
Shutdown	Default is Never

### ***Ignition Control Power Scheme, Ignition On***

This power scheme is used when the Ignition Control power configuration mode is selected and the vehicle ignition is On.

Switch state to User Idle	Default is After 15 minutes
Switch state to System Idle	Default is After 1 hour
Switch state to Suspend	Default is After 8 hours
Shutdown	Default is Never

---

## ***Ignition Control Power Scheme, Ignition Off***

This power scheme is used when the Ignition Control power configuration mode is selected and the vehicle ignition is Off.

Switch state to User Idle	Default is After 1 minute
Switch state to System Idle	Default is After 5 minutes
Switch state to Suspend	Default is After 1 hour
Shutdown	Default is After 8 hours

## ***Auto On Power Scheme***

This power scheme is used when the Auto On power configuration mode is selected.

Switch state to User Idle	Default is After 1 minute
Switch state to System Idle	Default is After 1 hour
Switch state to Suspend	Default is After 8 hours
Shutdown	Default is Never

The timers are cumulative. The System Idle timer begins the countdown after the User Idle timer has expired and the Suspend timer begins the countdown after the System Idle timer has expired. When the User Idle timer is set to "Never", the power scheme timers never place the Thor VM2 in User Idle, System Idle, Suspend or Shutdown modes (even when the Thor VM2 is idle).

Using the UPS Power Scheme Defaults listed above, the cumulative effect results in the following:

- The backlight turns off after 30 seconds of no activity,
- The display turns off after 90 seconds of no activity (1 minute + 30 seconds),
- The Thor VM2 enters Suspend after 11 minutes and 30 seconds of no activity,
- And the Thor VM2 shuts down after 31 minutes and 30 seconds of no activity.

---

## Adjust Speaker Volume

The Thor VM2 has two speakers, located on the bottom of the unit.

Speaker volume can be adjusted to a comfortable level for the listener by using the keypad or by changing parameters in the Volume & Sounds control panel.

### *Using the Keypad*

*Note: Sounds must be enabled (Settings > Control Panel > Volume & Sounds) before the following key sequences can adjust the volume.*

The volume is increased or decreased one step each time the volume key sequence is pressed.

To adjust speaker volume, locate the **Blue** key located below the display. Press the **Blue** key.

Adjust the speaker volume :

- Use the **P1** key for volume Up and **P2** key for volume Down.
- Adjust volume until the speaker volume is satisfactory.
- Press the **Blue** again key to exit this mode. The Blue modifier also times out after 5 seconds of inactivity.

The LED for the Blue key is lit as long as the blue modifier mode is active.

Volume control using a keypad key press has volume setting increments that match those supported by the Volume and Sounds control panel. Volume does not “roll-over” from minimum to maximum or from maximum to minimum. Continuously holding down the up or down arrow keys does not cause an automatic repeat of the up (or down) arrow key.

### *Using the Control Panel*

**Start > Settings > Control Panel > Volume & Sounds > Volume**

Change the volume setting and tap **OK** to save the change.

You can also select / deselect sounds for key clicks and screen taps and whether each is loud or soft.

As the volume scrollbar is moved between Loud and Soft, the Thor VM2 emits a tone each time the volume increases or decreases in decibel range.

---

## Set Date and Time Zone

Tap **Start > Settings > Control Panel > Date/Time** icon or tap the Date/Time in the taskbar.

Set Date, Time, Time Zone, and assign a Daylight Savings location on the Thor VM2 after a warm boot or anytime.

There is very little functional change from standard desktop PC Date/Time Properties options. Adjust the settings and tap the OK button or the Apply button to save changes to the registry. Any changes take effect immediately.

Double-tapping the time displayed in the Taskbar causes the Date/Time Properties screen to appear.

## *Grab Time Utility*

The GrabTime utility can be configured to synchronize the time with a local server during each reboot function.

Tap the Sync button to synchronize date and time with a networked time server. By default, the Thor VM2 operating system first searches for a time server on the local intranet. If not found, it then searches the Internet for a time server. A connection to the Internet is required for this option.

## *Autolaunch Time-Sync*

**Start > Settings > Control Panel > Options > Communication**

By default, TimeSync does not automatically run on the Thor VM2. To enable TimeSync to run automatically on the Thor VM2 using the GrabTime utility, check this checkbox.

## *Synchronize with a Local Time Server*

By default, GrabTime synchronizes via an Internet connection. To synchronize with a local time server:

1. Use ActiveSync to copy GrabTime.ini from the My Device > Windows folder on the Thor VM2 to the host PC.
2. Edit the copy of GrabTime.ini on the host PC. Add the local time server's domain name to the beginning of the list of servers. You can optionally delete the remainder of the list.
3. Copy the modified GrabTime.ini file to the My Device > System folder on the Thor VM2. The System/GrabTime.ini file takes precedence over the Windows/GrabTime.ini file. System/Grabtime.ini also persists after a coldboot; Windows/Grabtime.ini does not persist.

---

## Touch Screen

### *Calibrating the Touch Screen*

If the touch screen is not responding properly to stylus taps, you may need to recalibrate the touch screen.

Recalibration involves tapping the center of a target. If you miss the center, keep the stylus on the screen, slide it over the target's center, and then lift the stylus.

To recalibrate the screen, select **Start > Settings > Control Panel > Stylus > Calibration** tab.

Follow the instructions on the screen. Tap the OK button when complete, if necessary.

### *Apply the Touch Screen Protective Film*

The Thor VM2 touch screen protective film is shipped in packs of 10. The protective film is flexible and treated with an anti-glare coating on the outer surface.

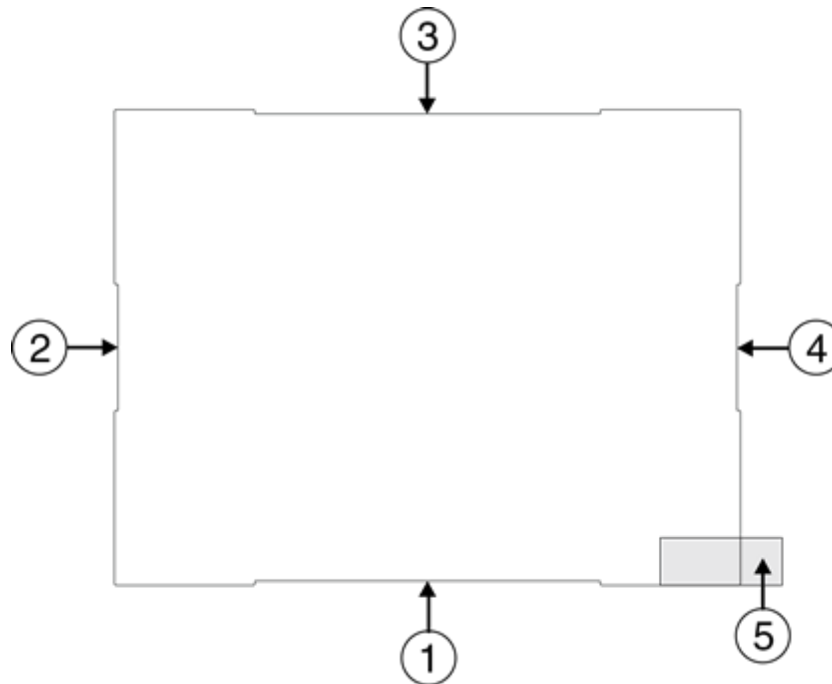

The protective film is slightly larger than the Thor VM2 touch screen, however the notches on the edge of the protective film (indicated by arrows 1 - 4 above) correspond to the display size of the Thor VM2. The protective film is not adhesive. The corner edges are designed to fit between the Thor VM2 display and the display housing to hold the protective film in place.

A protective backing is applied to the rear surface of the protective film. A pull tab (item 5 above) is attached to the protective backing for easy removal of the protective backing from the film.

### **Installation**

1. Make sure the touch screen is clean and dry before installation. Please review [Cleaning the Display](#) for instructions on suitable cleaning agents.

- 
2. Pull the release tab to separate the protective backing from the rear of the protective film. Avoid touching the rear side of the protective film while removing the liner.
  3. Place the rear side of the protective film against the Thor VM2 display, roughly centering the protective film over the display.
  4. Slide the protective film until one corner can be slid back between the touch screen and the display housing as the protective film is re-centered on the display. It may be necessary to press the edges of the protective film against the display to ensure the entire edge slides under the display housing. It is easiest to start with one of the bottom corners.
  5. Slide the protective film away from the other bottom corner. The film may bulge slightly away from the User's Guide as it is being slid. Only slide the protective film enough so that the protective film can slide under the display housing on that corner when the protective film is returned to center.
  6. Repeat with each of the top corners, sliding the protective film away from the corner just enough that the protective film can slide under the display housing when the protective film is returned to center.
  7. It may be necessary to flex the protective film during the install, however use care not to flex the protective film so much that the protective film kinks.
  8. Once all corners are secure under the display housing, adjust the protective film, if necessary, so it is centered on the touch screen.

## Removal

1. To remove the protective film, slide the protective film in one direction until the edge clears.
2. Lift up on the edge of the protective film so it does not slide between the touch screen and display housing when the protective film is slid back to the center.
3. Repeat until all edges are free and remove the protective film.

Contact [Technical Assistance](#) about protective film packs designed specifically for your Thor VM2 touch screen.

---

## Using the Input Panel / Virtual Keyboard

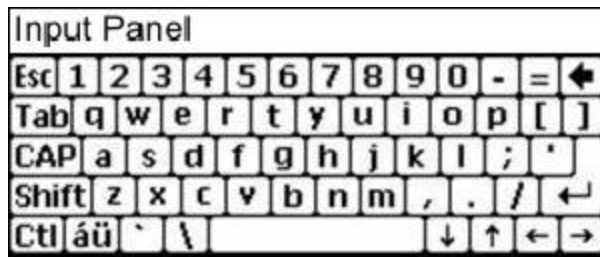

The virtual keyboard is always available when needed e.g., text entry.

Place the cursor in the text entry field and, using the stylus:

- Tap the Shift key to type one capital letter.
- Tap the CAPS key to type all capital letters.
- Tap the áü key to access symbols.

Some applications do not automatically display the Input Panel. In this case, do the following to use the Input Panel:



Input Panel icon in the taskbar



Keyboard icon in the taskbar

- Tap the Input Panel or Keyboard icon in the taskbar.
- Select **Keyboard** from the menu.
- Move the cursor into the text entry field when you want to enter data using the Input Panel.

When finished entering data, tap the icon in the Taskbar again. Select **Hide Input Panel**.

---

## Setup Terminal Emulation Parameters

Before you make a host connection, you will, at a minimum, need to know:

- the alias name or IP address (Host Address) and
  - the port number (Telnet Port) of the host system to properly set up your host session.
1. Make sure the mobile client network settings are configured and functional. If you are connecting over wireless LAN (802.11x), make sure your mobile client is communicating with the Access Point.
  2. From **Start > Program**, run **RFTerm** or tap the RFTerm icon on the desktop.
  3. Select **Session > Configure** from the application menu and select the "host type" that you require. This will depend on the type of host system that you are going to connect to; i.e., 3270 mainframe, AS/400 5250 server or VT host.
  4. Enter the "Host Address" of the host system that you wish to connect to. This may either be a **DNS name or an IP address of the host** system.
  5. Update the **telnet port number**, if your host application is configured to listen on a specific port. If not, just use the default telnet port.
  6. Select **OK**.
  7. Select **Session > Connect** from the application menu or tap the "Connect" button on the Tool Bar. Upon a successful connection, you should see the host application screen displayed.

To change options such as Display, Colors, Cursor, Bar Code, etc., please refer to these sections in the *RFTerm Reference Guide* for complete descriptions of these and other features.



---

## Using the AppLock Switchpad

*Note:* The touch screen must be enabled. Select **Start > Settings > Control Panel > Options > Misc. tab** to verify touch screen status.



Click the switchpad icon in the taskbar.

A checkmark on the switchpad menu indicates applications currently active or available for Launching by the Thor VM2 user. When Keyboard, on the Switchpad Menu, is selected, the default input method (Input Panel, Transcriber, or custom input method) is activated.

## Using the Keypad

One switch key sequence (or hotkey) is defined by the Administrator for the end-user to use when switching between locked applications. This is known as the **Activation key**.

When the switch key sequence is pressed on the keypad, the next application in the AppLock configuration is moved to the foreground and the previous application moves to the background. The previous application continues to run in the background. Thor VM2 key presses affect the application in focus only.

## Using the Touch Screen

The figure shown above is an example and is shown only to aid in describing how the user can switch between applications using a stylus.

When the user taps the Switchpad icon with the stylus, a menu pops up listing the applications available to the user. The user can tap an application name in the popup menu and the selected application is brought to the foreground. The previous application continues to run in the background. Stylus taps affect the application in focus only. When the user needs to use the Input Panel, they tap the Keyboard option. Input Panel taps affect the application in focus only.

---

## Connecting Bluetooth Devices

Before connecting to Bluetooth Devices:

- The system administrator has discovered, paired, connected and disconnected (using EZPair ) Bluetooth devices for each Thor VM2.
- The system administrator has enabled and disabled EZPair parameters for the Thor VM2.
- The system administrator has also assigned a Computer Friendly Name using EZPair for the Thor VM2.



To connect Bluetooth devices, the Thor VM2 should be as close as possible and in direct line of sight (distances up to 32.8 feet or 10 meters) with the targeted Bluetooth device during the discovery and pairing process.

If the devices are in Suspend, tap the power key to wake the Thor VM2.

Using the correct procedure, wake the targeted Bluetooth device if necessary.

There may be audible or visual signals as both devices discover and pair with each other.

### ***Taskbar Connection Indicator***

	Thor VM2 is connected to one or more of the targeted Bluetooth device(s).
	Thor VM2 is not connected to any Bluetooth device. Thor VM2 is ready to connect with any Bluetooth device. Thor VM2 is out of range of all paired Bluetooth device(s). Connection is inactive.

There may be audible or visual signals from paired devices as they move back into range and re-connect with the Bluetooth hardware in the Thor VM2.

---

## Reboot

When the Windows desktop is displayed or an application begins, the power up (or reboot) sequence is complete.

## Warmboot

A warmboot reboots the computer without erasing any registry data. Configuration settings and data in RAM are preserved during a warmboot. Network and ActiveSync sessions are lost and any data in running applications that had not been previously saved may be lost. CAB files already installed remain installed.

There are several methods available:

- Using the Registry, select **Start > Settings > Control Panel > Registry** and tap the **Warmboot** button. The Thor VM2 immediately warmboots.
- Using the Start menu, select **Start > Run** and type WARMBOOT in the text box. Press Enter. The Thor VM2 immediately warmboots. The WARMBOOT text command is not case-sensitive.
- Use the **P1 + P5 + Orange** keypress sequence to reboot the Thor VM2. The keys may be pressed in sequence; they do not need to be held down simultaneously.
- If an external keyboard is attached use the **Ctrl + Alt + Del** keypress sequence to reboot the Thor VM2. The keys may be pressed in sequence; they do not need to be held down simultaneously.

## Restart

A restart reboots the computer without erasing any registry data. Configuration settings are preserved during a restart. The contents of RAM are erased. Network and ActiveSync sessions are lost and any data in running applications that had not been previously saved may be lost. The OS and CAB files are reloaded.

To restart, select **Start > Settings > Control Panel > Registry** and tap the **Restart** button.

---

## Cleaning the Touch Screen

*Note: These instructions are for components made of glass. If there is a removable protective film sheet on the display, remove the film sheet before cleaning the screen.*

Keep fingers and rough or sharp objects away from the bar code reader scanning aperture and the mobile device touch screen.

If the glass becomes soiled or smudged, clean only with a standard household cleaner such as Windex® without vinegar or use Isopropyl Alcohol. Dampen the cloth with the cleaner and then wipe the surface.

Do not use paper towels or harsh-chemical-based cleaning fluids since they may result in damage to the glass surface. Use a clean, damp, lint-free cloth.

Do not scrub optical surfaces. If possible, clean only those areas which are soiled. Lint and particulates can be removed with clean, filtered canned air.

---

## Startup Help

Contact [Technical Assistance](#) if you need more help.

Touch screen is not accepting stylus taps or needs recalibration.	<a href="#">See Also: "Calibrating the Touch Screen"</a> when the touch screen needs recalibration, or Press Ctrl+Esc to force the Start Menu to appear. Use the tab, backtab and arrow keys to move the cursor from element to element.
Thor VM2 seems to lockup as soon as it is rebooted.	There may be slight delays while the wireless client connects to the network, authorization for voice-enabled applications complete, and Bluetooth relationships establish or re-establish. When an application begins, the Thor VM2 is ready for use.



# Chapter 3 - Connecting Cables to the Thor VM2

## Connect External Keyboard

The Thor VM2 supports an optional external 95-key USB keyboard. The external keyboard has a D9 connector to connect to the USB port on the Thor VM2 Quick Mount Smart Dock.

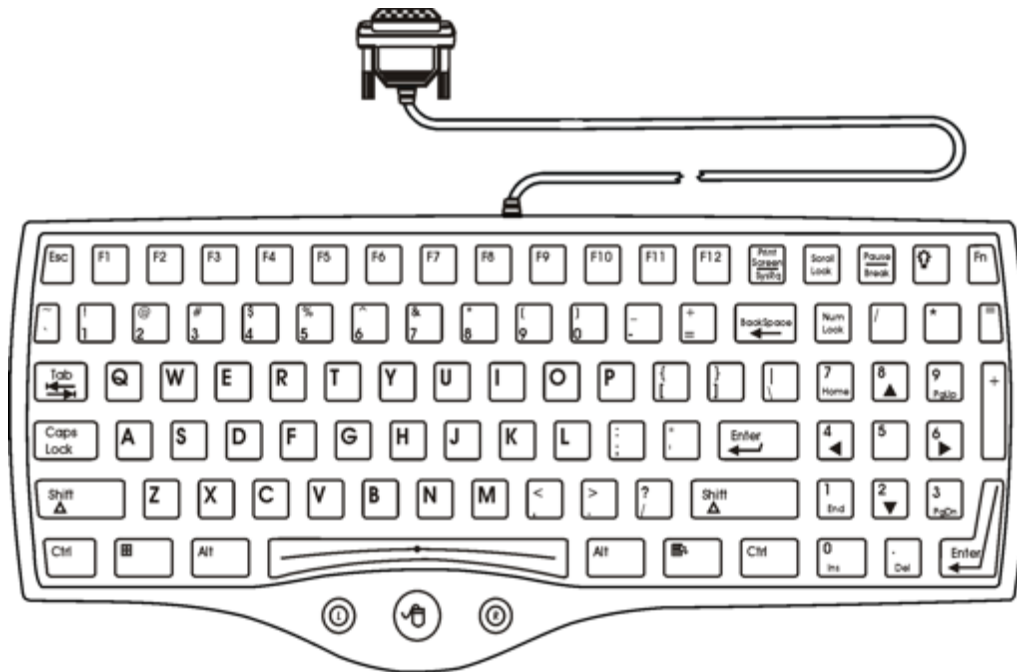

1. Seat the keyboard cable end connector over the USB connector on the Thor VM2 Quick Mount Smart Dock.
2. Tighten the thumbscrews in a clockwise direction. Do not over tighten.

---

## Connect Cable - USB Client

### USB-C Cable Assembly

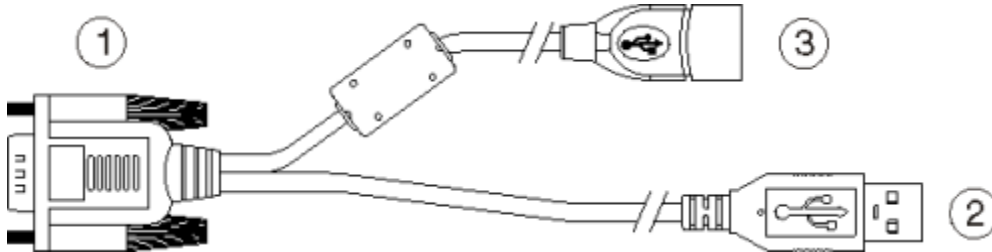

1. D9 Connector
2. USB Client Connector (for connecting to a USB host)
3. USB Host Connector (for connecting to a USB device)

1. Seat the cable end connector (connector 1) firmly over the USB Cable Connector on the Quick Mount Smart Dock.
2. Tighten the thumbscrews in a clockwise direction. Do not over tighten.
3. Connector 2 on the cable provides a USB-Client connection. Connector 3 (USB-Host) is not used for the USB-C connection.

## Connect Cable - USB Host

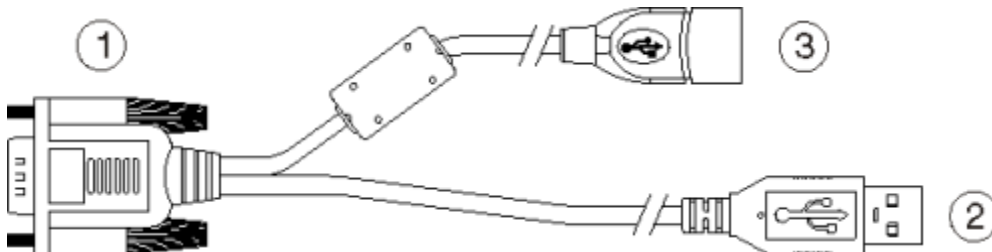

1. D9 Connector
2. USB Client Connector (for connecting to a USB host)
3. USB Host Connector (for connecting to a USB device)

1. Seat the cable end connector (connector 1) firmly over the USB Cable Connector on the Quick Mount Smart Dock.
2. Tighten the thumbscrews in a clockwise direction. Do not over tighten.
3. Connector 3 on the cable provides a USB-Host connection. Connector 2 (USB-Client) is not used for the USB-H connection.



---

## Connect Cable - Serial

*Note: Pin 9 of the desired COM port must be configured to provide +5V or RI as needed for the connected device. See the Thor VM2 Reference Guide for details.*

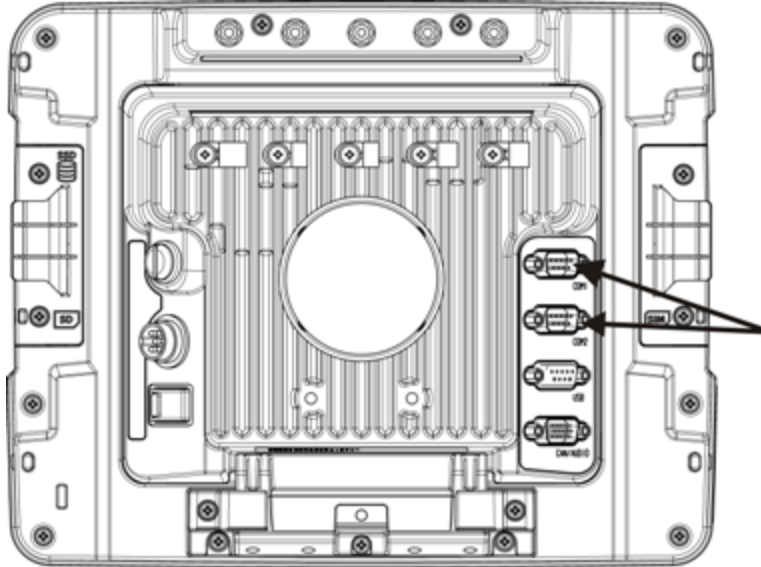

1. Seat the cable end connector firmly over the serial COM port on the Quick Mount Smart Dock.
2. Turn the thumbscrews in a clockwise direction. Do not over tighten.
3. Use a strain relief clamp to secure the cable to the Thor VM2.
4. Connect the other cable end to the desired serial device.

## Connect a Tethered Scanner

1. The scanner cable is attached to either the COM1 or COM2 port on the Quick Mount Smart Dock.
2. Connect the serial cable for the scanner as directed above.
3. When the Thor VM2 is powered on, it provides power to the serial scanner.

---

## Connecting the Headset Cable

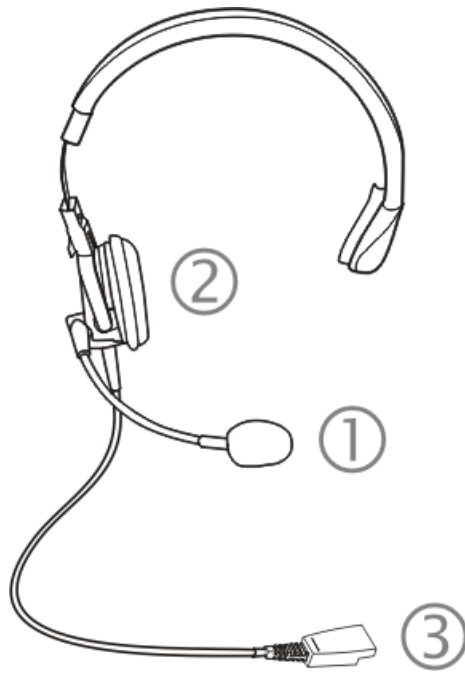

### Headset

1. Microphone
2. Headphones
3. Connects to end of voice cable

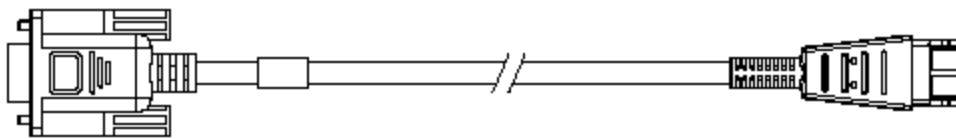

Thor VM2 Audio Cable

1. Seat the D15 cable end connector firmly over the CANbus/Audio Connector on the Quick Mount Smart Dock.
2. Tighten the thumbscrews in a clockwise direction. Do not over tighten.

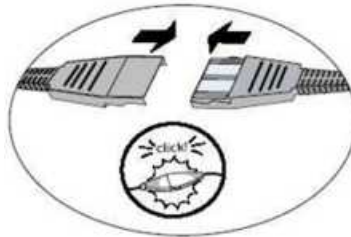

3. Slide the cable ends together until they click shut. Do not twist or bend the connectors. The Thor VM2 internal microphone and speakers are automatically disabled when the headset is connected.

The Thor VM2 is ready for voice-enabled applications.

---

## Adjust Headset / Microphone and Secure Cable



The headset consists of an earpiece, a microphone, a clothing clip and a cable. The headset attaches to the audio cable end of the voice cable which attaches to the Thor VM2.

Align the audio connector and the headset quick connect cable end. Firmly push the cable ends together until they click and lock in place.

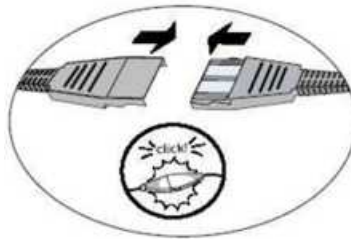

Do not twist the microphone boom when adjusting the microphone. The microphone should be adjusted to be about two finger widths from your mouth.

Make sure the microphone is pointed at your mouth. Note the small "Talk" label near the mouthpiece. Make sure the Talk label is in front of your mouth. The microphone cable can be routed over or under clothing.

### Under Clothing

- Leave the cable exposed only at the top of the collar.
- Be sure to leave a small loop of cable to allow movement of your head.

### Over Clothing

- Use clothing clips to hold the cable close to your body.
- Tuck the cable under the belt, but leave a small loop where it goes under the belt.
- Do not wear the cable on the front of your body. It may get in your way or get caught on protruding objects.

---

## Connecting an AC/DC Power Supply

*Note: The Honeywell-approved AC Power Supply and Adapter Cable are only intended for use in a 25°C (77°F) maximum ambient temperature environment.*

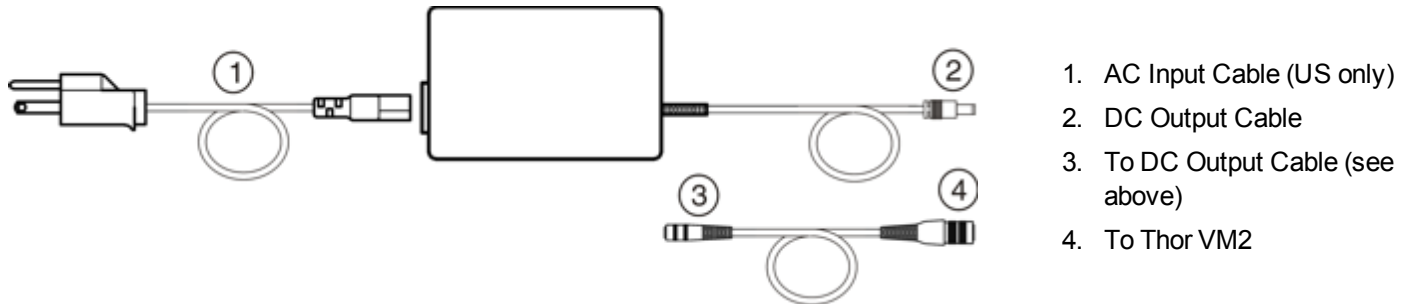

In North America, this unit is intended for use with a UL Listed ITE power supply with output rated 12 – 80VDC, minimum 60W. Outside North America, this unit is intended for use with an IEC certified ITE power supply with output rated 12 – 80VDC, minimum 60W.

The external power supply may be connected to either a 120V, 60Hz supply or, outside North America, to a 230V, 50Hz supply, using the appropriate detachable cordset. In all cases, connect to a properly grounded source of supply provided with maximum 15 Amp overcurrent protection (10 Amp for 230V circuits).



1. Turn the Thor VM2 off.
2. Connect the detachable cordset provided by Honeywell (US only, all others must provide their own cable) to the external power supply (IEC 320 connector).
3. Plug cordset into appropriate, grounded, electrical supply receptacle (AC mains).
4. Connect the DC Output Cable end to the power connector on the Thor VM2 Quick Mount.
5. Turn the Thor VM2 on.

---

## Connecting Vehicle Power

Complete vehicle cradle mounting and power instruction is contained in the *Thor VM2 Vehicle Mounting Reference Guide*.

### Vehicle 10-60VDC Power Connection

Caution: 	For installation by trained service personnel only.
Caution: 	For proper and safe installation, the input power cable must be connected to a fused circuit on the vehicle. This fused circuit requires a 10 Amp maximum time delay (slow blow) high interrupting rating fuse. If the supply connection is made directly to the battery, the fuse should be installed in the positive lead within 5 inches of the battery positive (+) terminal. Note: For North America, a UL Listed fuse is to be used.

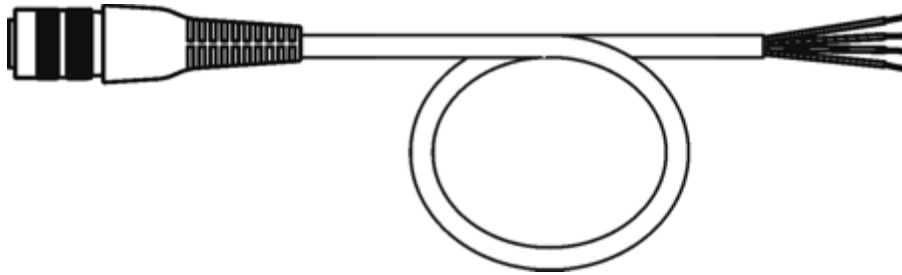

**VM1054CABLE**

Wire Color	Connection
Red	DC + (10-60VDC)
Black	DC -
Green	Ground
Blue	Ignition Input (optional)

*Note: Correct electrical polarity is required for safe and proper installation. See the figures below for additional wire color-coding specifics.*

The Thor VM2 DC input wires (Red DC+ and Black DC-) and the Blue ignition input wire are galvanically isolated. The Green ground input is used for electrostatic discharge (ESD) protection.

---

## Connect Vehicle 10-60VDC

1. The Thor VM2 must not be mounted in the Quick Mount Smart Dock. The power switch on the Dock must be turned **Off**. The power cable must be UNPLUGGED from the Dock.
2. While observing the fuse requirements specified above, connect the power cable as close as possible to the actual battery terminals of the vehicle (if using unswitched power).
3. Wiring installation
  - Use proper electrical and mechanical fastening means for terminating the cable. Properly sized “crimp” type electrical terminals are an accepted method of termination. Please select electrical connectors sized for use with 20AWG (0.81mm<sup>2</sup>) conductors.
  - Refer to the diagrams following this section for wire colors and connections:
    - [Ignition Control](#)
    - [Auto-On Control](#)
    - [Manual Control](#)
    - [VX6/VX7 Adapter Cable](#)
5. Route the power cable:
  - Route the power cable the shortest way possible removing any left-over cable
  - The cable is rated for a maximum temperature of 105°C (221°F). Therefore, routing this cable it should be protected from physical damage and from surfaces that might exceed this temperature.
  - Cable should be protected from physical damage from moving parts
  - Do not expose the cable to chemicals or oil that may cause the wiring insulation to deteriorate
  - Always route the cable so that it does not interfere with safe operation and maintenance of the vehicle.
  - Provide mechanical support for the cable by securing it to the vehicle structure at approximately one foot intervals, taking care not to over tighten and pinch conductors or penetrate outer cable jacket.
5. Connect the DC power cable to the input connector on the back of the Dock.
6. Flip the power switch on the back of the Dock to On.
7. The Thor VM2 can be installed in the Dock.
8. If using the [optional screen blanking feature](#), install the screen blanking box or switch.

Once installation is complete, remember to start the Thor VM2 and configure the Power Mode. Please see the *Thor VM2 Reference Guide* for details: **Start > Settings > Control Panel > Power Configuration Mode**.

---

## Ignition Control

Ignition wire must be connected and the Ignition Control power mode must be selected. When switched vehicle power is available the Thor VM2 ignition signal wire can be connected (less than 1mA over input voltage range) to the switched circuit to allow the Thor VM2 to power on when the vehicle is switched on. When the vehicle is switched off, more aggressive power management settings are enabled to preserve the vehicle battery charge.

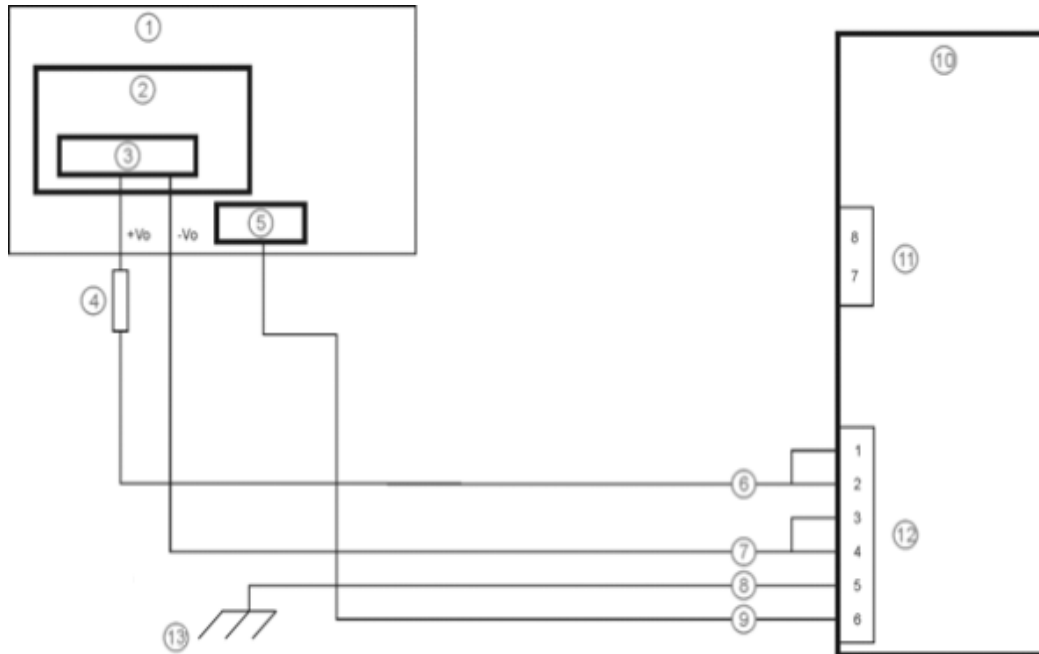

1. Existing Circuitry on Vehicle
2. Forklift Battery
3. Main Switch
4. 10A Slow blow Fuse close to power source
5. Ignition
6. Red Wire (DC +)
7. Black Wire (DC -)
8. Green Wire (Ground)
9. Blue Wire (Ignition Signal)
10. Thor VM2 Computer in Quick Mount Smart Dock
11. COM1 or COM2 Connector on Dock
12. Circular Power Connector on Dock
13. If the vehicle chassis is not a suitable ground, connect the Green wire to the negative terminal (-Vo) of the power source.

## Auto-On Control

Auto-On power mode must be selected. The vehicle supply connections should be made to vehicle switched power to allow the terminal to automatically power-up when vehicle power is switched on or when the power switch on the back of the Dock is placed in the On position. The Ignition wire is not used and should be left disconnected.

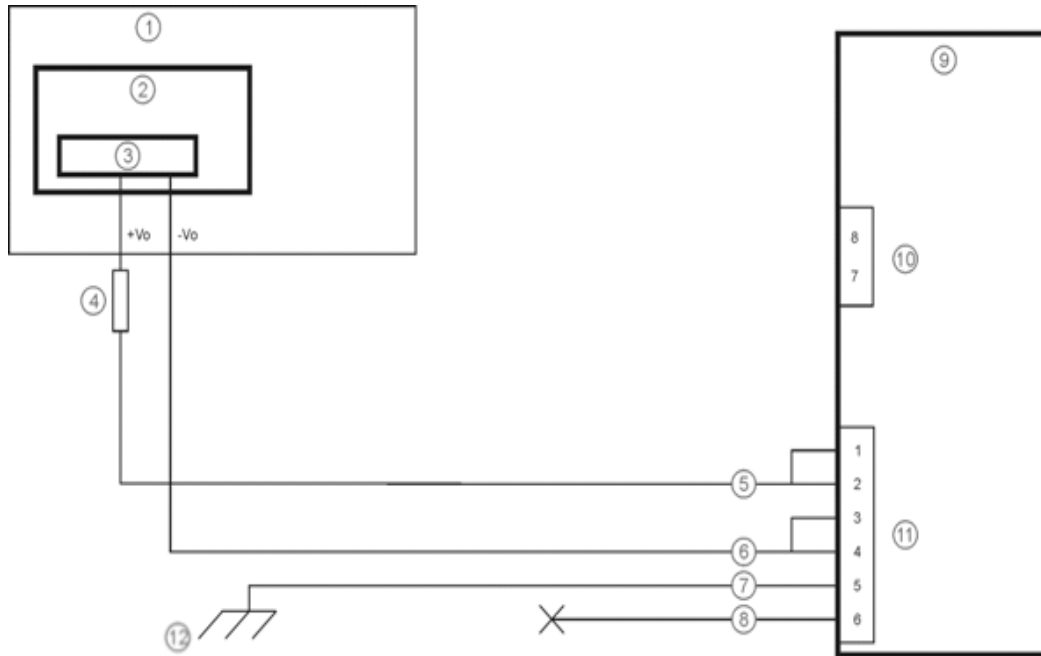

1. Existing Circuitry on Vehicle
2. Forklift Battery
3. Main Switch
4. 10A Slow blow Fuse close to power source
5. Red Wire (DC +)
6. Black Wire (DC -)
7. Green Wire (Ground)
8. Blue Wire (not connected)
9. Thor VM2 Computer in Quick Mount Smart Dock
10. COM1 or COM2 Connector on Dock
11. Circular Power Connector on Dock
12. If the vehicle chassis is not a suitable ground, connect the Green wire to the negative terminal (-Vo) of the power source.



---

## Manual Control

Ignition wire must be left unconnected and AC/DC power mode must be selected.

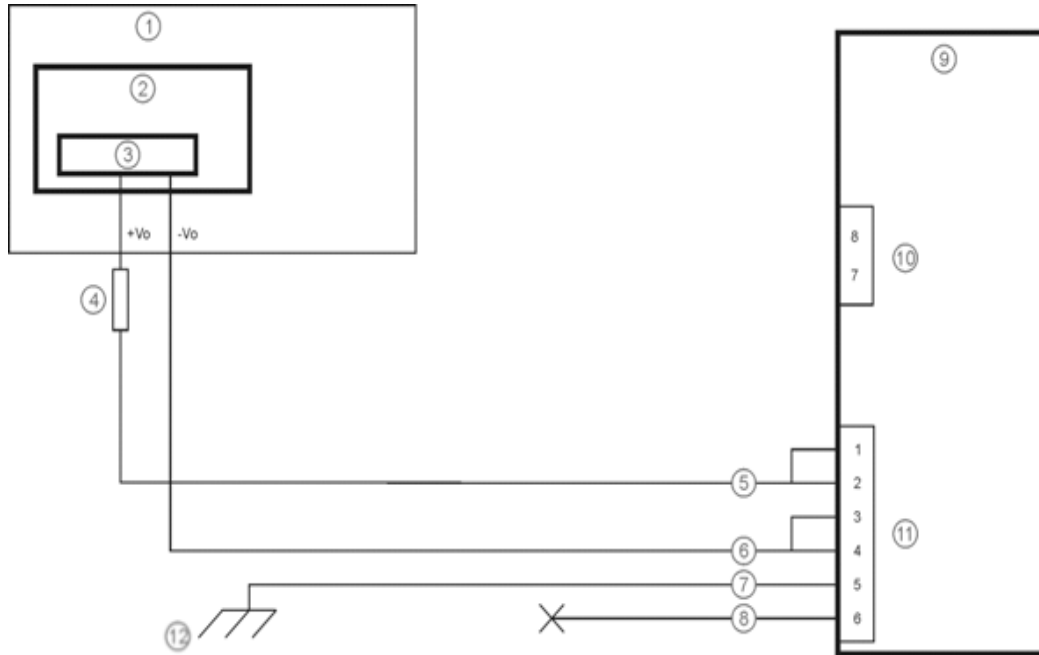

1. Existing Circuitry on Vehicle
2. Forklift Battery
3. Main Switch
4. 10A Slow blow Fuse close to power source
5. Red Wire (DC +)
6. Black Wire (DC -)
7. Green Wire (Ground)
8. Blue Wire (not connected)
9. Thor VM2 Computer in Quick Mount Smart Dock
10. COM1 or COM2 Connector on Dock
11. Circular Power Connector on Dock
12. If the vehicle chassis is not a suitable ground, connect the Green wire to the negative terminal (-Vo) of the power source.

---

## VX6 / VX7 Adapter Cable

An adapter cable is available to attach the Thor VM2 to a vehicle previously equipped with a VX6/VX7 DC power cable. The adapter cable has a 5-pin connector to match with the VX6/VX7 power supply cable on one end and a 6-pin connector to match to the Thor VM2 on the other.

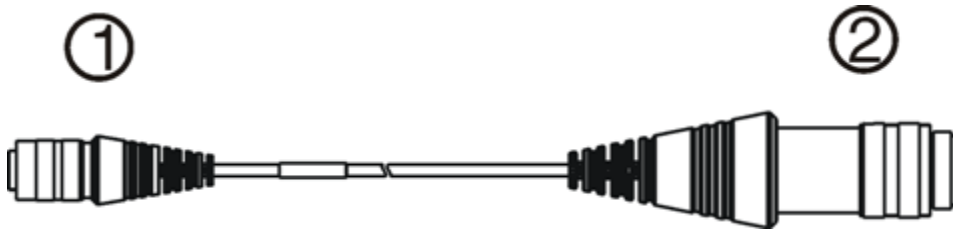

1. To Thor VM2
2. To VX6/VX7 Power Supply Cable

Caution:





Because the Thor VM2 supports 10-60VDC power input, verify input voltages before using this adapter cable with an existing VX6 or VX7 power connection installation.

When this adapter cable is used there is no provision for an ignition switch input. Therefore the vehicle ignition control function is not available when using this cable.

## Vehicle 72-144VDC Power Connection

This option requires DC/DC external power supply Part no. VX89303PWRSPLY.

<p>Caution:</p> 	<p>For installation by trained service personnel only.</p>
<p>Caution:</p> 	<p>For proper and safe installation, the input power cable must be connected to a fused circuit on the vehicle. This fused circuit requires a 10 Amp maximum time delay (slow blow) high interrupting rating fuse. If the supply connection is made directly to the battery, the fuse should be installed in the positive lead within 5 inches of the battery positive (+) terminal. Note: For North America, a UL Listed fuse is to be used.</p>
<p>Caution:</p> 	<p>The VX89303PWRSPLY power supply is sealed per IPXX. Usage in areas where moisture can affect the power supply connections should be avoided. The power supply should be mounted in a dry location within the vehicle or placed in a suitable protective enclosure.</p>

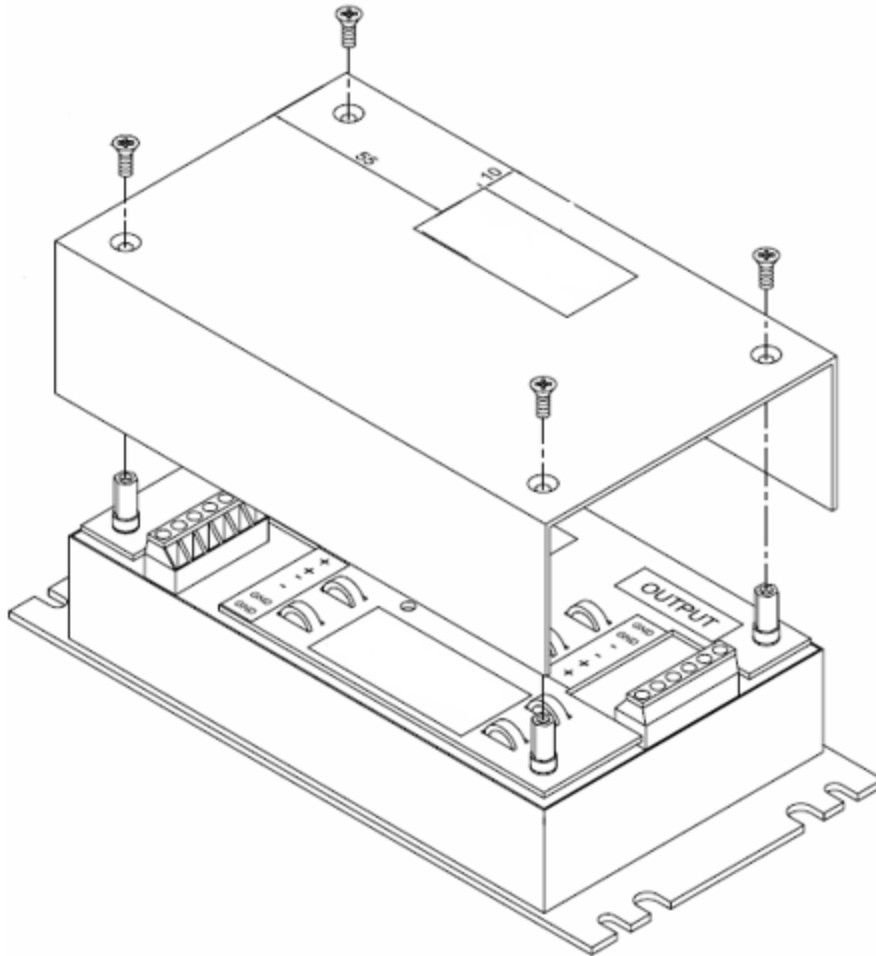

**VX89303PWRSPLY**

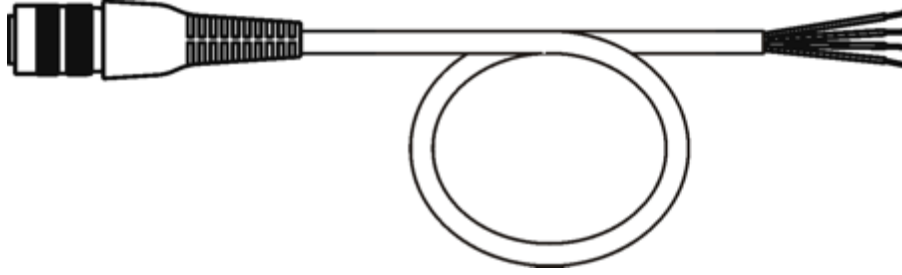

### VM1054CABLE

Wire Color	Connection
Red	DC + output from DC/DC Power Supply
Black	DC - output from DC/DC Power Supply
Green	Ground output from DC/DC Power Supply
Blue	Ignition Input (not connected)

*Note:* Correct electrical polarity is required for safe and proper installation. See the figure below for additional wire color-coding specifics.

The Thor VM2 DC input wires (Red DC+ and Black DC-) and the Blue ignition input wire are galvanically isolated. The Green ground input is used for electrostatic discharge (ESD) protection.

### Connect Vehicle 72-144VDC

1. The Thor VM2 must not be mounted in the Quick Mount Smart Dock. The power switch on the Dock must be turned **Off**. The power cable must be UNPLUGGED from the Dock.
2. While observing the fuse requirements specified above, connect the power cable as close as possible to the actual battery terminals of the vehicle.
3. Wiring installation:
  - The user must supply wiring from the vehicle to the DC/DC power supply.
  - Use proper electrical and mechanical fastening means for terminating the cable. Properly sized “crimp” type electrical terminals are an accepted method of termination. Please select electrical connectors sized for use with 20AWG (0.81mm<sup>2</sup>) conductors.
  - Remove the lid from the DC to DC converter. Attach the stripped wire ends to the output side of the DC to DC converter. Attach stripped wire ends to the input side of the DC to DC converter.
  - The input and output blocks each have two + and two – minus connectors. Either connector in the block can be used to connect the matching polarity wire.
  - Use the looms and wire ties to secure all wiring then reattach the cover with the screws.
  - Connect as shown in [wiring diagram](#).
4. Route the power cable:
  - Route the power cable the shortest way possible removing any left-over cable
  - The cable is rated for a maximum temperature of 105°C (221°F). Therefore, routing this cable it should be protected from physical damage and from surfaces that might exceed this temperature.
  - Cable should be protected from physical damage from moving parts
  - Do not expose the cable to chemicals or oil that may cause the wiring insulation to deteriorate

- Always route the cable so that it does not interfere with safe operation and maintenance of the vehicle.
  - Provide mechanical support for the cable by securing it to the vehicle structure at approximately one foot intervals, taking care not to over tighten and pinch conductors or penetrate outer cable jacket.
5. Connect the DC power cable to the input connector on the back of the Dock.
  6. Flip the power switch on the back of the Dock to On.
  7. The Thor VM2 can be installed in the Dock.
  8. If using the [optional screen blanking feature](#), install the screen blanking box or switch.

Once installation is complete, remember to start the Thor VM2 and configure the Auto-On behavior. Please see the *Thor VM2 Reference Guide* for details: **Start > Settings > Control Panel > Options > Misc** tab.

## Wiring Diagram

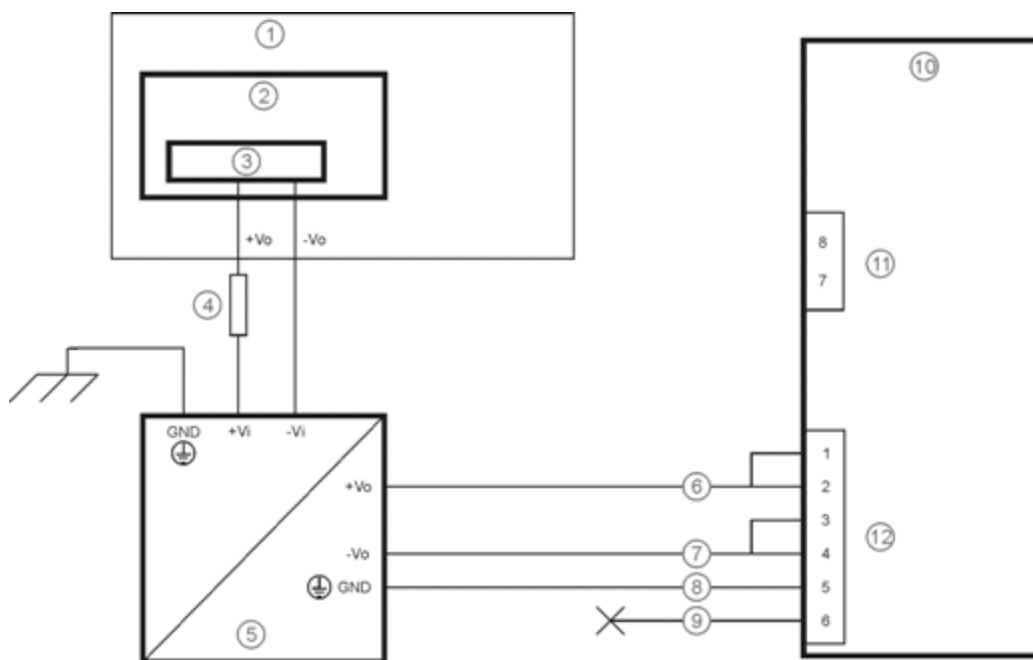



1. Existing Circuitry on Vehicle
2. Forklift Battery
3. Main Switch
4. 10A Slow blow Fuse close to power source
5. Isolated DC/DC Power Supply
6. Red Wire (DC +)

7. Black Wire (DC -)
8. Green Wire (Ground)
9. Blue Wire (not connected)
10. Thor VM2 Computer in Quick Mount Smart Dock
11. COM1 or COM2 Connector on Dock
12. Circular Power Connector on Dock

---

## Thor VM2 Screen Blanking

*Note:* Before this process begins, the steps outlined in *Power Cable Connection* need to be performed for either the [10-60VDC Connection](#) or the [72-144VDC Connection](#).

Caution: 	For installation by trained service personnel only.
Caution: 	For proper and safe installation, the input power lead to the Screen Blanking Box requires a 3 Amp maximum time delay (slow blow) high interrupting rating fuse. Note: For North America, a UL Listed fuse is to be used.

An optional Screen Blanking Box Cable (VM1080CABLE) is available from Thor VM2 to connect the Screen Blanking Box to the COM port on the Thor VM2. A user-supplied cable can also be used.

Please refer to the *Thor VM2 Reference Guide* for specifications on building a serial cable for the screen blanking feature and Screen Control (in the Windows Control Panel) to configure the Thor VM2 for screen blanking.

When routing any additional cables for screen blanking:

- Route the cable the shortest way possible removing any left-over cable
- Fuses and cabling are user supplied. Therefore, route these cables so they are protected from physical damage and from surfaces that might exceed the cable's rated temperature threshold.
- Cable should be protected from physical damage from moving parts
- Do not expose the cable to chemicals or oil that may cause the wiring insulation to deteriorate
- Always route the cable so that it does not interfere with safe operation and maintenance of the vehicle.
- Provide mechanical support for the cable by securing it to the vehicle structure at approximately one foot intervals, taking care not to over tighten and pinch conductors or penetrate outer cable jacket.

## Screen Blanking Box

Screen Blanking Box Terminal	Connection
12-xxV	Input from vehicle motion sensing circuitry. Please refer to label on Screen Blanking Box for allowable voltage input range.
GND	DC -
	These two terminals are for a user provided serial cable. The cable must be constructed so that <b>Pin 7 (RTS)</b> connects to <b>switched</b> side of the connection and <b>Pin 8 (CTS)</b> connects to the <b>other terminal</b> .

Please refer to the appropriate illustration below for Screen Blanking Box wiring diagrams.

<p>Caution:</p> 	<p>Do not exceed the maximum input voltage, either 60 or 72VDC, specified on the Screen Blanking Box label when using this configuration.</p>
---	---

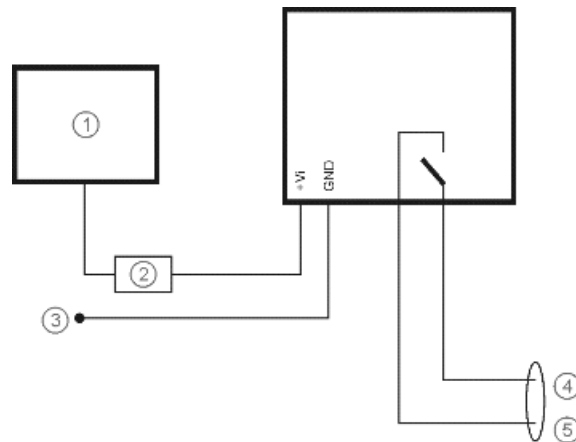

1. Motion Circuitry - The voltage at the +Vi input on the Screen Blanking Box must be between 10VDC and 60 or 72VDC (see Screen Blanking Box label) when the vehicle is in motion and less than 5VDC when the vehicle is not in motion.
2. 3 Amp Fuse
3. To -Vo on Vehicle, i.e., Negative Battery Terminal
4. To Pin 7 of COM1 or COM2 (Gray wire when using VM1080CABLE)
5. To Pin 8 of COM1 or COM2 (Black wire when using VM1080CABLE)

---

## Screen Blanking with Switch

In applications where it is impractical to use the screen blanking box due to vehicle voltage or lack of a motion sensing signal, screen blanking can be controlled via a user supplied switch or relay that provides an electrical conductive connection on vehicle motion.

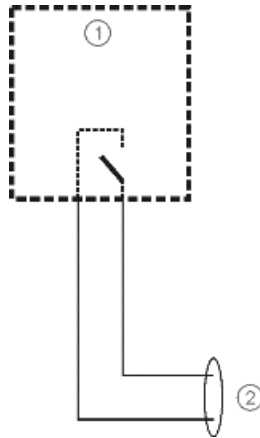

1. Switch
2. To Pins 7 and 8 of COM1 or COM2



---

## Fuse

The Thor VM2 uses an 8A time delay (slow blow), fuse that is externally accessible and user replaceable. The fuse is located on the back of the Quick Mount Smart Dock. The fuse is accessed by unscrewing the cap as indicated below.

Should it need replacement, replace with same size, rating and type of fuse – Littelfuse 0215008.MXP or equivalent.

Fuse has voltage on it even when power is off. Always disconnect input power before changing the fuse.

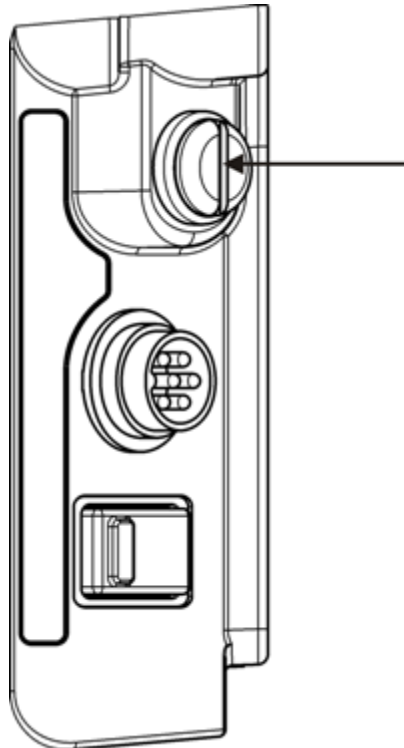



# Chapter 4 - Product Agency Compliance - Thor VM2

## ***Class B Digital Device***

### **FCC Rules, Part 15**

This device complies with Part 15 of the FCC Rules [and with RSS-210 of Industry Canada]. Operation is subject to the following two conditions:

1. This device may not cause harmful interference, and
2. This device must accept any interference received, including interference that may cause undesired operation.

NOTE: This equipment has been tested and found to comply with the limits for a Class B digital device, pursuant to Part 15 of the FCC Rules. These limits are designed to provide reasonable protection against harmful interference in a residential installation. This equipment generates, uses and can radiate radio frequency energy and, if not installed and used in accordance with the instructions, may cause harmful interference to radio communications. However, there is no guarantee that interference will not occur in a particular installation. If this equipment does cause harmful interference to radio or television reception, which can be determined by turning the equipment off and on, the user is encouraged to try to correct the interference by one or more of the following measures:

- Reorient or relocate the receiving antenna.
- Increase the separation between the equipment and the receiver.
- Connect the equipment into an outlet on a circuit different from that to which the receiver is connected.
- Consult the dealer or an experienced radio/TV technician for help.

### **Notice**

Changes or modifications made to this equipment not expressly approved by Honeywell may void the FCC authorization to operate this equipment.

### **EMC Directive Requirements**

This is a Class B product. In a domestic environment this product may cause radio interference in which case the user may be required to take adequate measures.

### **Canada, Industry Canada (IC) Notices**

This Class B digital apparatus complies with Canadian ICES-003

This device complies with Industry Canada licence-exempt RSS standard(s). Operation is subject to the following two conditions: (1) this device may not cause interference, and (2) this device must accept any interference, including interference that may cause undesired operation of the device.

### **Exposure of humans to RF fields (RSS-102)**

The computers employ low gain integral antennas that do not emit RF field in excess of Health Canada limits for the general population; consult Safety Code 6, obtainable from Health Canada's Web site at <http://www.hc-sc.gc.ca/>

The radiated energy from the antennas connected to the wireless adapters conforms to the IC limit of the RF exposure requirement regarding IC RSS-102, Issue 4 clause 4.1.

---

## Canada, avis d'Industry Canada (IC)

Cet appareil numérique de classe B est conforme à la norme NMB-003.

Le présent appareil est conforme aux CNR d'Industrie Canada applicables aux appareils radio exempts de licence. L'exploitation est autorisée aux deux conditions suivantes: (1) l'appareil ne doit pas produire de brouillage, et (2) l'utilisateur de l'appareil doit accepter tout brouillage adioélectrique subi, même si le brouillage est susceptible d'en compromettre le fonctionnement.

### Conformité des appareils de radiocommunication aux limites d'exposition humaine aux radiofréquences (CNR-102)

L'ordinateur utilise des antennes intégrales à faible gain qui n'émettent pas un champ électromagnétique supérieur aux normes imposées par Santé Canada pour la population. Consultez le Code de sécurité 6 sur le site Internet de Santé Canada à l'adresse suivante : <http://www.hc-sc.gc.ca/>

L'énergie émise par les antennes reliées aux cartes sans fil respecte la limite d'exposition aux radiofréquences telle que définie par Industrie Canada dans la clause 4.1 du document CNR-102, version 4.

## ANATEL (Brazil)

Este equipamento opera em caráter secundário, isto é, não tem direito a proteção contra interferência prejudicial, mesmo de estações do mesmo tipo, e não causar interferência a sistema operando em caráter primário.

## Cofetel

La operación de este equipo está sujeta a las siguientes dos condiciones: (1) es posible que este equipo o dispositivo no cause interferencia perjudicial y (2) este equipo o dispositivo debe aceptar cualquier interferencia, incluyendo la que pueda causar su operación no deseada.

## Li-Ion Battery

When disposing of the Thor VM2 UPS battery, the following precautions should be observed: The battery should be disposed of properly. The battery should not be disassembled or crushed. The battery should not be heated above 212°F (100°C) or incinerated.

## RF Safety Notice



This device is intended to transmit RF energy. For protection against RF exposure to humans and in accordance with FCC rules and Industry Canada rules, this transmitter should be installed such that a minimum separation distance of at least 20 cm (7.8 in.) is maintained between the antenna and the general population. This device can only be co-located with FCC ID: TWG-SDCM30G.

## FCC 5GHz Statement

LAN devices are restricted to indoor use only in the band 5150-5250 MHz.

For the band 5600-5650 MHz, no operation is permitted.



When using IEEE 802.11a wireless LAN, this product is restricted to indoor use, due to its operation in the 5.15- to 5.25-GHz Frequency range. The FCC requires this product to be used indoors for the frequency range of 5.15 GHz to 5.25 GHz to reduce the potential for harmful interference to co-channel mobile satellite systems. High-power radar is allocated as the primary user of the 5.25- to 5.35-GHz and 5.65- to 5.85-GHz bands. These radar stations can cause interference with and/or damage to this device.

---

## **Waste *Electrical and Electronic Equipment* (WEEE)**



Important:

This symbol is placed on the product to remind users to dispose of Waste Electrical and Electronic Equipment (WEEE) appropriately, per Directive 2002-96-EC. In most areas, this product can be recycled, reclaimed and re-used when properly discarded. Do not discard labeled units with trash. For information about proper disposal, visit [www.honeywellaidc.com](http://www.honeywellaidc.com).

---

## **R&TTE Directive Requirements**

This device bearing the CE marking is in compliance with the essential requirements and other relevant provisions of Directive 1999/5/EC. This device complies with the following harmonized European Standards:

Health: EN63211:2008

Safety: EN60950-1:2006 + A1:2010 + A11:2009 + A12:2011

EMC: EN301 489-1 V1.9.2:2011, EN301 489-17 V2.1.1:2009

Radio: EN300 328 V1.7.1:2006

The following CE marking is valid for EU harmonized telecommunications products.

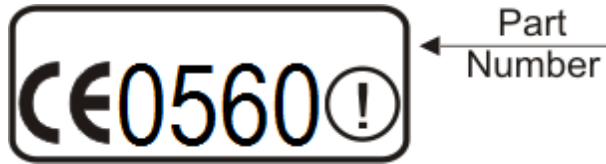

EN300328 V1.7.1:2006
EN301893 V1.6.1:2011
EN62311: 2008
EN301489-1 V1.9.2:2011 EN301489-17 V2.1.1:2009
EN55022/EN55024: 2010

## **Dealer License - Republic of Singapore**

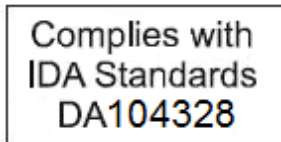

Republic of Singapore - Dealer License Number DA104328 complies with IDA Standards.

WWAN is not available in Singapore.

---

## Lithium Battery Safety Statement

Caution: Lithium battery inside. Danger of explosion if battery is incorrectly replaced. Replace only with same or equivalent type recommended by battery manufacturer. (US)

Attention: Contient une pile de lithium. Risque d'explosion dans le cas où la pile ne serait pas correctement remplacée. Remplacer uniquement avec une pile semblable ou équivalente au type de pile recommandé par le fabricant. (FR)

Forsigtig: Indeholder lithiumbatterier. Risiko for eksplosion, hvis batteriet udskiftes forkert. Må kun udskiftes med samme eller tilsvarende type, som anbefalet af fabrikanten. (DK)

Varoitus: Tämä tuote käyttää laservaloa. Skannerissa on jokin seuraavista tarroista. Lue Huomio-kohta. (FI)

Vorsicht: Enthält Lithium-Batterie. Bei unsachgemäßem Ersatz besteht Explosionsgefahr. Nur durch gleichen oder vom Hersteller empfohlenen Typ ersetzen. (DE)

Attenzione: Batteria al litio. Pericolo di esplosione qualora la batteria venga sostituita in maniera scorretta. Sostituire solo con lo stesso tipo o equivalente consigliato per il fabbricante. (IT)

Atenção: Contém pilha de lítio. Há perigo de explosão no caso de uma substituição incorreta. Substitua somente pelo mesmo tipo, ou equivalente, recomendado pelo fabricante. (PT)

Varning: Innehåller litiumbatteri. Fara för explosion om batteriet är felaktigt placerat eller av fel typ. Använd endast samma eller motsvarande typ batterier rekommenderade av tillverkaren. (SE)

Advarsel: Innmontert Lithium batteri. Eksplosjonsfare ved feil montering av batteri. Benytt kun batteri anbefalt av produsent. (NO)

Cuidado: Pila de litio adentro. Peligro de explosión si la pila se reemplaza incorrectamente. Reemplace solamente con el mismo tipo o equivalente recomendado por el fabricante. (ES)

Oppassen: Bevat Lithium-batterij. Incorrecte plaatsing van batterij kan leiden tot explosiegevaar. Alleen vervangen door hetzelfde of door fabrikant aanbevolen gelijkwaardig type. (NL)

<p><b>Προσοχή:</b> Υπάρχει μπαταρία από λίθιο εσωτερικά. Υπάρχει κίνδυνος έκρηξης εάν η μπαταρία αντικατασταθεί με λανθασμένο τρόπο. Αντικαταστήστε μόνο με τον ίδιο ή ισοδύναμο τύπο που συνιστάται από τον κατασκευαστή. <b>(GR)</b></p>	<p><b>주의:</b> 리튬 배터리 내부. 배터리가 잘못 설치되었을 경우 폭발의 위험이 있습니다. 동일한 배터리, 또는 배터리 제조업체가 권장하는 배터리로 교체하십시오. <b>(KR)</b></p>
<p><b>注意:</b> リチウム電池が入っています。間違った種類の電池を使用すると、破裂する恐れがあります。同じ電池、または電池製造元が推奨する同等の電池を使用してください。 <b>(JP)</b></p>	<p><b>小心:</b> 内装锂电池。如电池更换不当，则有发生爆炸的危险。只能用电池制造商推荐的相同或同等电池进行更换。 <b>(CN)</b></p>
<p><b>Dikkat:</b> İçinde lityum bataryası bulunur. Bataryanın yanlış değiştirilmesi patlama tehlikesi yaratır. Aynısıyla veya üreticinin önerdiği eşdeğer tipte değiştirin. <b>(TR)</b></p>	

Legend: Chinese – CN; Danish – DK; Dutch – NL; English – US; Finnish – FI; French – FR; German – DE; Greek – GR; Italian – IT; Japanese – JP; Korean – KR; Norwegian – NO; Portuguese – PT; Spanish – ES; Swedish – SE; Turkish – TR.



---

## Vehicle Power Supply Connection Safety Statement

Vehicle Power Supply Connection: If the supply connection is made directly to the battery, a 10A slow-blow fuse should be installed in the positive lead within 5 inches (12.7 cm.) of the battery positive (+) terminal. (US)

Raccordement de l'alimentation du véhicule Si l'alimentation est raccordée directement à la batterie, un fusible à action retardée de 10A doit être installé sur le câble positif à moins de 12,7 cm de la borne positive (+) de la batterie. (FR)

EL forsyning af køretøjet. Er forsyningsforbindelsen direkte tilknyttet til batteriet og og tilsluttet til den positive part indenfor 12,7 cm (+ delen). vil der være en langsom tændelse af 10 ampere. (DK)

Kytkentä ajoneuvon virtalähteeseen Jos virtaa otetaan suoraan akusta, 10 ampeerin hidas sulake on asennettava positiiviseen johtoon enintään 12 cm:n etäisyydelle akun positiivisesta (+) navasta. (FI)

Anschluss an Fahrzeugbatterie Bei direktem Anschluss an die Fahrzeugbatterie sollte eine träge 10A-Sicherung in die positive Leitung zwischengeschaltet werden, und zwar nicht weiter als ca. 13 cm von der positiven (+) Batterieklemme entfernt. (DE)

Σύνδεση Τροφοδοτικού Ισχύος Οχήματος Αν η σύνδεση του τροφοδοτικού γίνει κατευθείαν στη μπαταρία, μια ασφάλεια βραδείας τήξης των 10Α θα πρέπει να τοποθετηθεί στο θετικό καλώδιο εντός 5 ιντσών (12,7 εκ.) του θετικού (+) ακροδέκτη της μπαταρίας. (GR)

Collegamento dell'alimentazione del veicolo Se il collegamento dell'alimentazione viene stabilito direttamente con la batteria, è necessario installare un fusibile ad azione lenta da 10A nel conduttore positivo a meno di 5 in. (12,7 cm) dal terminale positivo (+) della batteria. (IT)

Tilkople strømforsyningen til kjøretøyet Hvis strømforsyningen koples direkte til batteriet, skal det installeres en 10A treg sikring i den positive ledningen innen 12,7 cm fra plusspolen (+) på batteriet. (NO)

Ligação do fornecimento de corrente do veículo Se a ligação de fornecimento de corrente for ligada directamente à bateria, deve instalar-se um fusível de 10A no terminal positivo, a 12,7 cm. do terminal positivo (+) da bateria. (PT)

Conexión de suministro eléctrico para el vehículo Si el suministro eléctrico se proporciona directamente a la batería, se debe instalar un fusible de retardo de 10A en el conductor positivo, como máximo a 12,7 cm (5 pulgadas) del terminal positivo (+). (ES)

Fordonets strömförsörjningskoppling Om strömkopplingen görs direkt till batteriet, måste en 10A-säkring installeras i den positivt laddade ledningen inom 12.7 cm från batteriets pluspol (+). (SE)

Taşıt Güç Kaynağı Bağlantısı Kaynak bağlantısı doğrudan aküye yapılırsa, pozitif bağlantı kablosu üzerinde akünün pozitif (+) kutbuna 12.7 cm mesafede 10A'lık yavaş atan bir sigorta monte edilmelidir. (TR)

Legend: Danish – DK; English – US; Finnish – FI; French- - FR; German – DE; Greek – GR; Italian – IT; Norwegian – NO; Portuguese – PT; Spanish – ES; Swedish – SE; Turkish – TR.



# Chapter 5 - Technical Assistance

If you need assistance installing or troubleshooting your device, please contact us by using one of the methods below:

**Knowledge Base:** [www.hsmknowledgebase.com](http://www.hsmknowledgebase.com)

Our Knowledge Base provides thousands of immediate solutions. If the Knowledge Base cannot help, our Technical Support Portal (see below) provides an easy way to report your problem or ask your question.

**Technical Support Portal:** [www.hsmsupportportal.com](http://www.hsmsupportportal.com)

The Technical Support Portal not only allows you to report your problem, but it also provides immediate solutions to your technical issues by searching our Knowledge Base. With the Portal, you can submit and track your questions online and send and receive attachments.

**Web form:** [www.hsmcontactsupport.com](http://www.hsmcontactsupport.com)

You can contact our technical support team directly by filling out our online support form. Enter your contact details and the description of the question/problem.

**Telephone:** [www.honeywellaidc.com/locations](http://www.honeywellaidc.com/locations)

For our latest contact information, please check our website at the link above.

## Product Service and Repair

Honeywell International Inc. provides service for all of its products through service centers throughout the world. To obtain warranty or non-warranty service, please visit [www.honeywellaidc.com](http://www.honeywellaidc.com) and select **Support > Contact Service and Repair** to see your region's instructions on how to obtain a Return Material Authorization number (RMA #). You should do this prior to returning the product.

## Limited Warranty

Honeywell International Inc. ("HII") warrants its products to be free from defects in materials and workmanship and to conform to HII's published specifications applicable to the products purchased at the time of shipment. This warranty does not cover any HII product which is (i) improperly installed or used; (ii) damaged by accident or negligence, including failure to follow the proper maintenance, service, and cleaning schedule; or (iii) damaged as a result of (A) modification or alteration by the purchaser or other party, (B) excessive voltage or current supplied to or drawn from the interface connections, (C) static electricity or electro-static discharge, (D) operation under conditions beyond the specified operating parameters, or (E) repair or service of the product by anyone other than HII or its authorized representatives.

This warranty shall extend from the time of shipment for the duration published by HII for the product at the time of purchase ("Warranty Period"). Any defective product must be returned (at purchaser's expense) during the Warranty Period to HII factory or authorized service center for inspection. No product will be accepted by HII without a Return Materials Authorization, which may be obtained by contacting HII. In the event that the product is returned to HII or its authorized service center within the Warranty Period and HII determines to its satisfaction that the product is defective due to defects in materials or workmanship, HII, at its sole option, will either repair or replace the product without charge, except for return shipping to HII.

EXCEPT AS MAY BE OTHERWISE PROVIDED BY APPLICABLE LAW, THE FOREGOING WARRANTY IS IN LIEU OF ALL OTHER COVENANTS OR WARRANTIES, EITHER EXPRESSED OR IMPLIED, ORAL OR WRITTEN, INCLUDING, WITHOUT LIMITATION, ANY IMPLIED WARRANTIES OF MERCHANTABILITY OR FITNESS FOR A PARTICULAR PURPOSE, OR NON-INFRINGEMENT.

HII'S RESPONSIBILITY AND PURCHASER'S EXCLUSIVE REMEDY UNDER THIS WARRANTY IS LIMITED TO THE REPAIR OR REPLACEMENT OF THE DEFECTIVE PRODUCT WITH NEW OR REFURBISHED PARTS. IN NO EVENT

---

SHALL HII BE LIABLE FOR INDIRECT, INCIDENTAL, OR CONSEQUENTIAL DAMAGES, AND, IN NO EVENT, SHALL ANY LIABILITY OF HII ARISING IN CONNECTION WITH ANY PRODUCT SOLD HEREUNDER (WHETHER SUCH LIABILITY ARISES FROM A CLAIM BASED ON CONTRACT, WARRANTY, TORT, OR OTHERWISE) EXCEED THE ACTUAL AMOUNT PAID TO HII FOR THE PRODUCT. THESE LIMITATIONS ON LIABILITY SHALL REMAIN IN FULL FORCE AND EFFECT EVEN WHEN HII MAY HAVE BEEN ADVISED OF THE POSSIBILITY OF SUCH INJURIES, LOSSES, OR DAMAGES. SOME STATES, PROVINCES, OR COUNTRIES DO NOT ALLOW THE EXCLUSION OR LIMITATIONS OF INCIDENTAL OR CONSEQUENTIAL DAMAGES, SO THE ABOVE LIMITATION OR EXCLUSION MAY NOT APPLY TO YOU.

All provisions of this Limited Warranty are separate and severable, which means that if any provision is held invalid and unenforceable, such determination shall not affect the validity of enforceability of the other provisions hereof. Use of any peripherals not provided by the manufacturer may result in damage not covered by this warranty. This includes but is not limited to: cables, power supplies, cradles, and docking stations. HII extends these warranties only to the first end-users of the products. These warranties are non-transferable.

The duration of the limited warranty for the Thor VM2 is 1 year.

The duration of the limited warranty for the Thor VM2 Quick Mount Smart Dock is 1 year.

The duration of the limited warranty for the Thor VM2 Vehicle Mount Assembly is 1 year.

The duration of the limited warranty for the Thor VM2 internal UPS battery is 1 year.

The duration of the limited warranty for the Thor VM2 AC power supply and cables is 1 year.

The duration of the limited warranty for the Thor VM2 DC-DC Converter is 1 year.

The duration of the limited warranty for the Thor VM2 cables (USB, Serial, Communication, Power) is 1 year.



Honeywell Scanning & Mobility  
9680 Old Bailes Road  
Fort Mill, SC 29707  
[www.honeywellaidc.com](http://www.honeywellaidc.com)