



DIGITAL VOICE RECORDER

WS-883

WS-882

USER MANUAL

Getting started

Recording

Playback

Menu

Use with a PC

Other information

1

2

3

4

5

6

- Thank you for your purchase of our company's voice recorder. Consult the "Basic Manual" and this manual (PDF version) while operating the recorder to ensure that you are using the product safely and correctly.
- Be sure you have read and understood the contents of "**Safety precautions**" (P.83 - P.87), before using this product. Keep these instructions available for future reference.
- Read the "Basic Manual" and this manual (PDF version) thoroughly before using the product and record test audio to confirm that it is functioning normally before making important recordings.
- The screen and product illustrations shown in the manuals were produced during the development stages and may differ from the actual product.
- If there are additions and/or modifications of functions due to firmware update for the recorder, the contents will differ. For the latest information, please visit our website.

Table of contents

Names of parts	4
Recorder	4
Display (Normal Mode)	5
Display (Simple Mode)	6

1 Getting started

Setup	7
Inserting the battery	8
Turning the power ON	9
Setting the language	9
Setting the inserted battery	10
Setting the time/date	10
Selecting the mode	11
Charging the battery	12
Charging the battery by connecting to a PC's USB connector	12
Charging the batteries by connecting to an AC adapter with a USB connection (model F-5AC; optional)	14
Batteries	16
Inserting/removing a microSD card	18
Inserting a microSD card	18
Removing a microSD card	19
Preventing accidental operation	20
Setting HOLD mode	20
Releasing HOLD mode	20
Turning the power OFF	21
Folders	22
Folders for Audio Recordings	22
Music Folders	23
Podcast Folders	24
Selecting folders and files	25
Using the Calendar Search function to search for a file	26

2 Recording

Recording	27
Basic recording procedure	27
Pausing/resuming recording	29
Quickly checking a recording	29
Monitoring while recording	30

Changing the recording scene [Rec Scene]	31
Changing the recording scene	31
Recording with an external microphone	33
Recording with an external microphone	33
Recording from another connected device	34
Recording audio from another device with this recorder	34
Recording audio from this recorder with another device	36

3 Playback

Playback	37
Basic playback procedure	37
Fast-forwarding	38
Rewinding	38
Skipping to the beginning of a file	39
Playback through the earphones	40
Changing the playback voice (Voice changer)	42
ABC repeat playback	44
Index marks	47
Writing an index mark	47
Erasing an index mark	47
Erasing files/folders/indexes	48
Erasing files/indexes	48
Erasing a folder	50

4 Menu

Setting menu items	52
Basic operation	52
File menu [File Menu]	55
Preventing accidental file erasure [File Lock]	55
Sorting files [Sort by]	55
Dividing a file [File Divide]	55
Increasing the overall volume level of a file [Normalize]	56
Displaying file or folder information [Property]	57

Table of contents

Recording menu [Rec Menu]	58
Selecting the recording level [Rec Level]	58
Setting the recording mode [Rec Mode].....	58
Reducing noise during recording [Low Cut Filter]	59
Voice-activated recording function [VCVA].....	59
Voice sync recording function [V-Sync. Rec]....	60
Writing an index mark at the start position of the active sound [Auto index].....	62
Playback menu [Play Menu]	63
Reducing noise during playback [Noise Cancel].....	63
Playing back alternately with and without sound [Shadowing].....	63
Adjusting low volume portions during playback [Voice Balancer]	64
Selecting playback modes [Play Mode]	64
Setting a skip space [Skip Space].....	65
LCD/Sound menu [LCD/Sound Menu]	67
Adjusting the contrast [Contrast].....	67
Setting the LED indicator light [LED].....	67
Turning beeping sound ON/OFF[Beep].....	67
Changing the display language [Language]	67
Device menu [Device Menu]	68
Selecting the recording media [Memory Select]	68
Setting the battery in use [Battery]	68
Setting the time/date [Time & Date]	68
Selecting the mode [Mode Select]	69
Restoring the default settings [Reset Settings].....	69
Formatting a recording media [Format].....	70
Checking recording media information [Memory Info.]	71
Checking voice recorder information [System Info.]	71

5 Use with a PC

PC connection/disconnection	73
Connecting the voice recorder to a PC	73
Disconnecting the voice recorder from a PC....	74

6 Other information

Alarm message list	75
Troubleshooting	77
Recorder care	80
Accessories (optional)	81
Copyright and trademark information	82
Safety precautions	83
Specifications	88

Indications used in this manual

NOTE

Describes precautions and operations that should be absolutely avoided in using the voice recorder.

TIP

Describes useful information and hints that will help you getting the most out of your voice recorder.



Indicates reference pages describing details or related information.

Names of parts

Recorder

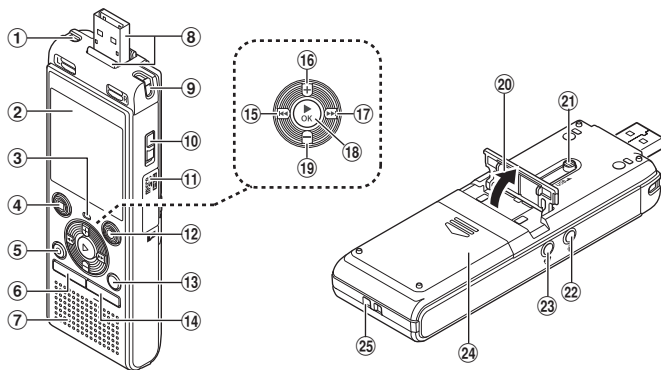

- ① Built-in stereo microphone (L)
- ② Display
- ③ LED indicator light (LED)
- ④ **STOP** (■) button
- ⑤ **ERASE** button
- ⑥ **MENU** button
- ⑦ Built-in speaker
- ⑧ **USB connector/USB connector cover (retractable)**
- ⑨ Built-in stereo microphone (R)
- ⑩ **POWER** switch
- ⑪ Card cover
- ⑫ **REC (record)** (●) button
- ⑬ **FOLDER/INDEX** button
- ⑭ **CALENDAR/SCENE** button
- ⑮ **◀◀** button
- ⑯ **+** button
- ⑰ **▶▶** button
- ⑱ **▶OK** button
- ⑲ **-** button
- ⑳ **Stand**
- ㉑ **USB connector slide lever**
- ㉒ **Microphone jack** (🎤)
- ㉓ **Earphone jack** (🎧)
- ㉔ **Battery cover**
- ㉕ **Strap hole**

Names of parts

Display (Normal Mode)

During recording mode

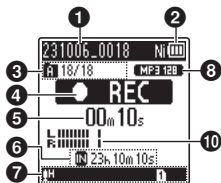

- 1 File name**
- 2 Battery indicator**
[Ni]: Ni-MH*1
[Al]: Alkaline*1
- 3 Folder indicator, Current file number in folder/Total number of recorded files in folder and file lock indicator**
- 4 Voice recorder status indicator**
[]: Recording indicator
[]: Recording pause indicator
[]: Stop indicator
[]: Playback indicator
[]: Fast playback indicator
[]: Slow playback indicator
[]: Fast-forward indicator
[]: Fast-rewind indicator
- 5 Elapsed recording time or playback time**
- 6 Recording media indicator**
[IN]: Internal memory
[]: microSD card
Possible recording time remaining
- 7 Meanings of indicators shown in indicator display area**

During stop mode or playback mode

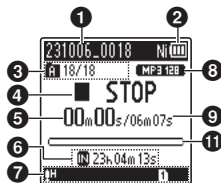

Rec Scene:

- []: Dictation
- []: Meeting
- []: Conference
- []: Dupl.: Duplication (Auto Divide)
- []: Dupl.: Duplication (Timer)
- []: TEL.REC

[] [] []: Rec Level

[]: VCVA

[]: V-Sync. Rec

[]: Auto index

[]: Low Cut Filter

[]: Voice Balancer

[]: Noise Cancel

Play Mode:

[]: Folder

[]: All

[]: File

[]: Repeat

[]: Random

- 8 Recording format indicator**
 - 9 File length**
 - 10 Level meter**
 - 11 Playback position bar indicator**
- *1 WS-883 model only

Names of parts

Display (Simple Mode)

During recording mode

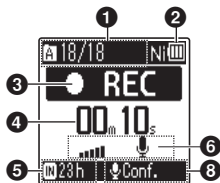

- 1 Folder indicator, Current file number in folder/Total number of recorded files in folder and file lock indicator

2 Battery indicator

[Ni]: Ni-MH*1
[Al]: Alkaline*1

3 Voice recorder status indicator

[]: Recording indicator
[]: Recording pause indicator
[■]: Stop indicator
[▶]: Playback indicator
[▶▶]: Fast playback indicator
[▶▶]: Slow playback indicator
[▶▶▶]: Fast-forward indicator
[◀◀]: Fast-rewind indicator

4 Elapsed recording time or playback time

5 Recording media indicator

[M]: Internal memory
[μ]: microSD card

Possible recording time remaining

During stop mode or playback mode

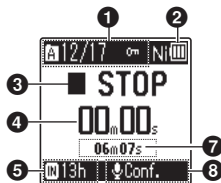

6 Level meter

- 7 File length (During stop mode), Playback position bar indicator (During playback mode)

8 Rec Scene

* 1 WS-883 model only

TIP

- Pressing and holding the **STOP** (■) button while the voice recorder is in stop mode displays the settings [Time & Date] and [Remain] (amount of possible recording time remaining). If the current time/date is set incorrectly, see "Setting the time/date [Time & Date]" (P.68).



Getting started

Setup

After unpacking the voice recorder, follow the steps below to have it ready for use.

Getting started **1**

Inserting the battery

Getting started **2**

Turning the power ON

Getting started **3**

Setting the language

Getting started **4**

Selecting the battery setting (WS-883 model only)

Select the battery setting to match the inserted battery. Select the setting for a nickel-metal hydride rechargeable battery or the setting for an alkaline battery.

Getting started **5**

Setting the time/date

Set the voice recorder's clock for use with file management.

Getting started **6**

Selecting the mode

Select either normal mode or simple mode.

Getting started **7**

Charging the recorder (WS-883 model only)

1

Getting started

Inserting the battery

1

Before using the voice recorder, insert the battery in the battery compartment of the voice recorder.

Getting started

- 1 Slide open the battery cover while pressing down on it.

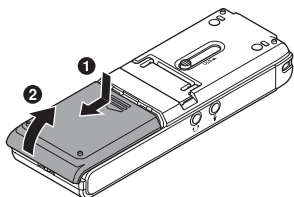

- 3 Slide the battery cover completely closed.

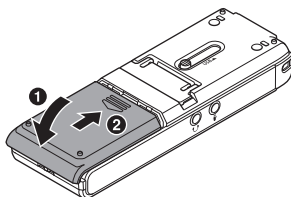

- 2 Insert AAA batteries, making sure to place the positive and negative terminals correctly.

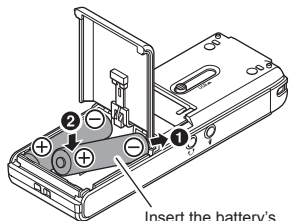

Insert the battery's negative terminal first

Turning the power ON

- 1 Slide the **POWER** switch to the **[ON]** position.

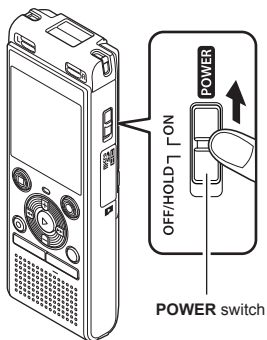

Setting the language

- 1 Press the **+** or **-** button to select a language.

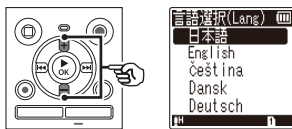

- 2 Press the **▶OK** button to finalize the language.

Setting the inserted battery

! WS-883 model only

- 1 Press the + or - button to select the type of battery you inserted.

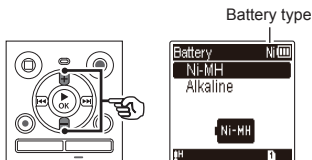

[Ni-MH]

Select if you inserted a nickel-metal hydride rechargeable battery manufactured by our company (model BR404).

[Alkaline]

Select if you inserted an alkaline battery.

- 2 Press the ►OK button to finalize the setting.

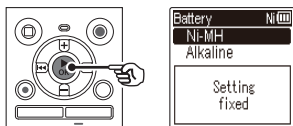

NOTE

- The mode can be switched even after setting "Setting the battery in use [Battery]" (☞ P.68).

Setting the time/date

- 1 Press the ►► or ◀◀ button to select the item to set.

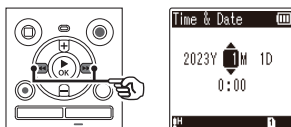

- 2 Press the + or - button to change the number.

- To change the setting of another item, press the ►► or ◀◀ button to move the blinking cursor, then press the + or - button to change the number.

- 3 Press the ►OK button to finalize the setting.

TIP

- You can press the ►OK button during the setting procedure to set the items entered so far and start the clock.

Selecting the mode

- 1 Press the + or - button to change the mode.

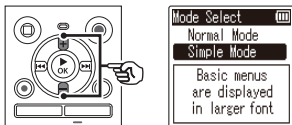

[Normal Mode]:

This is the standard mode in which all functions are available.

[Simple Mode]:

This mode lists frequently used functions. Displayed text becomes larger for easier viewing.

- 2 Press the ►OK button to finalize the setting.

TIP

- The mode can be switched even after setting. "**Selecting the mode [Mode Select]**" (P.69)
- Once the mode is set after purchase, the [Mode Select] screen is not displayed again, even if the batteries are replaced.

Charging the battery

Charging the battery by connecting to a PC's USB connector

1

Getting started

! WS-883 model only

NOTE

- Before charging the battery, insert the rechargeable battery provided and set **[Battery]** to **[Ni-MH]** (☞ P.8, P.68).

1 Start the PC.

2 Slide the USB connector slide lever in the direction of the arrow.

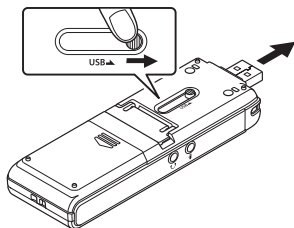

3 After making sure the voice recorder is stopped, connect the USB connector to a USB port on a PC.

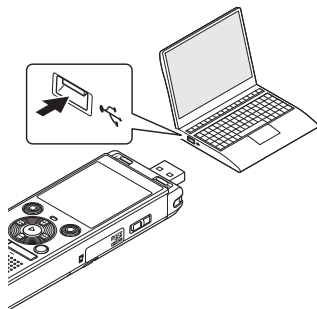

4 Press the **▶OK** button to start charging the battery.

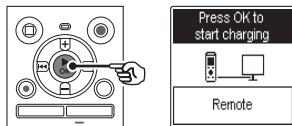

- When **[Battery]** (☞ P.68) is set to **[Ni-MH]**, **[Press OK to start charging]** appears on the display. Press the **▶OK** button while this message is blinking.

5 Charging has finished when the battery indicator changes to **[F]**.

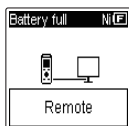

Charging time: About 3 hours*

* Approximate time needed to fully charge a completely flat battery at room temperature. Battery charging time will depend on the amount of remaining power and the state of the battery.

NOTE

- Never attempt to charge an alkaline battery, lithium battery or other primary cell battery. Fluid leakage or overheating may cause the recorder to malfunction.
- The power of the PC must be ON to charge the battery using the USB connector. You cannot charge the battery when the power of the PC is OFF, or the PC is in standby, sleep or auto power OFF mode.
- Do not use a USB hub when charging the battery by connecting to the PC.
- You cannot charge the battery if **[G]***1 or **[H]***2 is blinking. Charge the battery in an ambient temperature of between 5 and 35°C (41 and 95°F).
 - *1 **[G]** Ambient temperature is too low.
 - *2 **[H]** Ambient temperature is too high
- If battery life has become noticeably short on a full charge, replace the battery with a new one.
- Insert the USB connector securely all the way. Operation will not be normal if the connection is not made properly.
- Use the optional USB extension cable (KP19) if needed.
- Use only a compatible USB extension cable (KP19). Operation is not guaranteed if another manufacturer's cable is used. Only use the USB extension cable manufactured by our company with the voice recorder and never use if a product from another manufacturer is used.

Charging the battery

Charging the batteries by connecting to an AC adapter with a USB connection (model F-5AC; optional)

1

Getting started

NOTE

- Before charging the batteries, insert the rechargeable batteries provided and set **[Battery]** to **[Ni-MH]** (P.8, P.68).
-  indicates there is little remaining battery charge. Charge the batteries or replace them with fresh ones.

- 1 Connect the recorder to a USB port on the AC adapter.

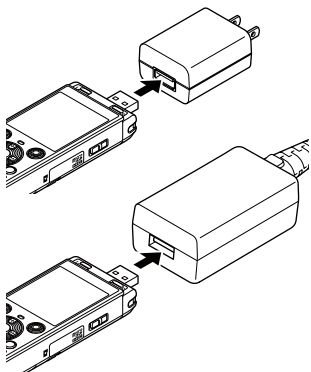

- 2 Plug the AC adapter into an AC power outlet.

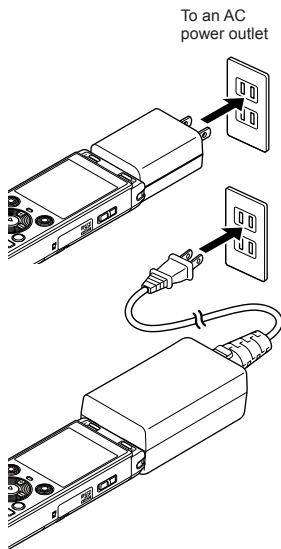

Charging the battery

- 3** Press the ►OK button to start charging the battery.

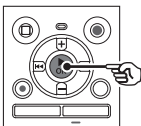

- When **[Battery]** (P.68) is set to **[Ni-MH]**, **[Press OK to start charging]** appears on the display. Press the ►OK button while this message is blinking.

- 4** Charging has finished when the battery indicator changes to **[F]**.

- **[Please wait]** appears on the display regardless of whether the battery is charging or charging is complete.

NOTE

- Do not charge primary batteries such as alkaline batteries or lithium batteries. Doing so may cause the recorder to malfunction due to liquid leakage, heat generation, etc.
- Charge the batteries via a USB connection when the power of the computer is ON. You cannot charge the batteries when the power of the computer is OFF or the computer is in the standby, sleep, or auto power OFF mode.
- Do not use a USB hub when charging the batteries by connecting to the computer.
- You cannot charge the batteries if **[C]***1 or **[H]***2 is displayed. Charge the batteries in an ambient temperature of between 5 and 35°C (41 and 95°F).
 - *1 **[C]** Ambient temperature is too low.
 - *2 **[H]** Ambient temperature is too high
- If battery life has become noticeably short on a full charge, replace the batteries with new ones.
- Insert the USB connector securely all the way. Operation will not be normal if the connection is not made properly.
- If necessary, use the separately sold USB extension cable (KP19).
- Be sure to use the dedicated cable (KP19) as a USB extension cable. We cannot guarantee proper operation if you use a product manufactured by another company. Also, never connect this dedicated cable to a product manufactured by another company.

Batteries



1

Getting started

Battery indicator

As the battery loses its remaining charge, the battery indicator on the display changes as follows:



-  indicates there is little remaining battery charge. Charge the battery or replace it with a fresh one. When the battery has run out () and **[Battery low]** appear, and operation stops.

Battery precautions

- The voice recorder does not support manganese batteries.
- Always turn the power off before replacing the battery. Files may be damaged if the battery is removed while the voice recorder is recording or performing an operation such as erasing a file.
- If the batteries are removed from the voice recorder, the **[Time & Date]** screen is displayed automatically when the power is turned on. See **“Setting the time/date [Time & Date]”** (☞ P.68) for the procedure.
- When not using the voice recorder for an extended period, always remove the battery before storage.
- The continuous battery usage time is reduced when using a microSD card (☞ P.89).
- The continuous battery usage time will vary depending on the performance of the battery in use (☞ P.89).

Rechargeable batteries

WS-883 model only

Read the information below carefully when using a nickel-metal hydride rechargeable battery (model BR404).

■ Discharging

Rechargeable batteries discharge naturally when not in use. Be sure to charge the battery before use.

■ Operating temperature

Rechargeable batteries are chemical-based products. Their performance can vary even when used within the recommended operating temperature range. This variation is normal.

■ Recommended temperature ranges

When powering voice recorder: 0 to 42°C (32 to 107.6°F)

When being charged: 5 to 35°C (41 to 95°F)

During long-term storage: -20 to 30°C (-4 to 86°F)

Use of a rechargeable battery outside the temperature ranges above may result reduced in battery performance or life. When not using the voice recorder for an extended period, remove the rechargeable battery before storage to prevent fluid leakage or rust.

NOTE

- Due to the nature of nickel-metal hydride rechargeable batteries, new batteries and batteries not used for an extended period (one month or more) may not charge completely. The battery should become fully charged after charging and discharging the battery up to three times.
- When buying rechargeable batteries, always select model BR404 nickel-metal hydride rechargeable batteries. Operation is not guaranteed, if batteries from another manufacturer is used.
- Always dispose rechargeable batteries in the legally prescribed manner. Before disposing rechargeable batteries that are not fully discharged, take steps to prevent shorting such as insulating their terminals with tape.
- The continuous battery usage time of a nickel-metal hydride rechargeable battery that has been used repeatedly will be reduced due to battery degradation (☞ P.89).
- The **[Battery]** screen appears automatically after you have replaced the battery. You can also use a menu operation to display this screen and set the battery (☞ P.68).

Inserting/removing a microSD card

The voice recorder has its own internal memory, and also supports standard microSD cards (microSD, microSDHC) sold separately.

1

Inserting a microSD card

Getting started

- 1 While the voice recorder is in stop mode, open the card cover.

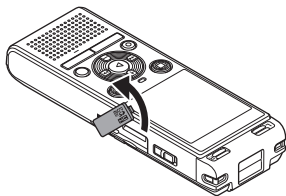

- 2 Insert a microSD card, making sure it is placed correctly as shown.

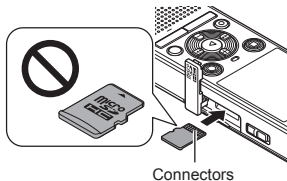

- Insert the microSD card straight, avoiding crooked insertion.
- Inserting a microSD card the wrong way or crookedly could damage its contact surface or cause it to jam in the slot.
- A microSD card not inserted fully (until it clicks into place) might not record data.

- 3 Close the card cover.

- The recording media selection screen appears after a microSD card has been inserted.

- 4 To record onto the microSD card, press the + or - button and select [Yes].

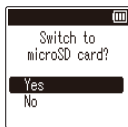
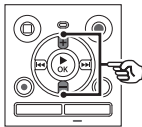

- 5 Press the ►OK button to finalize the setting.

TIP

- You can also select the internal memory as the recording media (☞ P.68).

NOTE

- The voice recorder may not be able to recognize a microSD card formatted (initialized) for a PC or other device. Before using a microSD card, always initialize it on the voice recorder (☞ P.70).

Inserting/removing a microSD card

Removing a microSD card

- 1 While the voice recorder is in stop mode, open the card cover.

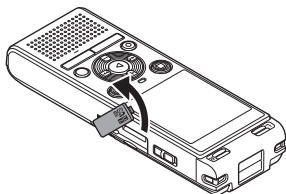

- 2 Release the microSD card by pressing it inward, then letting it slowly return.

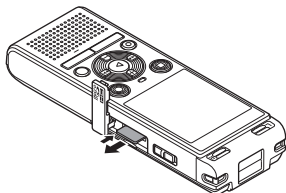

- The microSD card moves outward and stops. Pull the microSD card out with your fingertips.
- If **[Memory Select]** was set to **[microSD card]**, **[Internal memory selected]** is displayed after removing a microSD card.

- 3 Close the card cover.

NOTE

- microSD cards may pop out forcefully on removal if you flick or release your finger too quickly after pressing the card in.
- Depending on the card's manufacturer and type, some microSD cards and microSDHC cards may not be fully compatible with the voice recorder and not be recognized properly.
- For microSD card compatibility, please visit our website's customer support page.
Note that our customer support will provide information on microSD card manufacturers and card types for which we have verified operation, but will not guarantee their performance. Also note that some cards may no longer be recognized correctly by the voice recorder in case card manufacturer changes card specifications.
- Read the operating instructions provided with the card when using a microSD card.
- If a microSD card is not recognized by the voice recorder, try removing and reinserting the card to have the voice recorder recognizing the card again.
- Processing speed may be low for some microSD card types. Processing performance may also be reduced by writing or deleting data repeatedly from a microSD card. In this case, reinitialize the card (P.70).

Preventing accidental operation

Setting the voice recorder to HOLD mode maintains the current operation and disables button operations. HOLD mode is a handy feature for preventing unintentional operation from accidentally pressing the button when the voice recorder is carried in a bag or pocket. It is also useful for preventing the voice recorder being accidentally stopped during recording.

1

Getting started

Setting HOLD mode

- 1 While the recorder is in recording mode or playback mode, slide the **POWER** switch to the **[OFF/HOLD]** position.

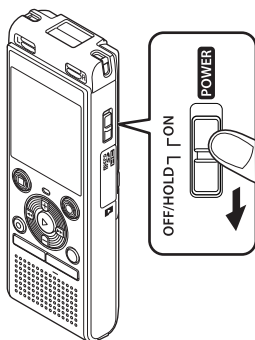

Releasing HOLD mode

- 1 Slide the **POWER** switch to the **[ON]** position.

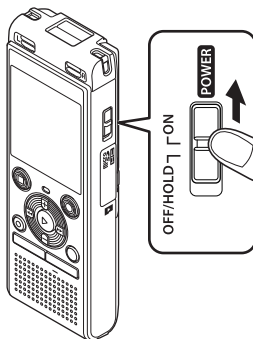

- **[Hold]** appears in the display, and the recorder enters HOLD mode.

NOTE

- When any button is pressed during HOLD mode, **[Hold]** appears in the display for 2 seconds. No other operation is performed.
- Setting HOLD mode during voice recorder playback (or recording) continues the playback (or recording) operation and prevents any other operation from being performed (The power turns off when playback ends or when recording ends because, for example, there is no remaining memory space).

Turning the power OFF

Existing data, menu settings and the clock setting are saved when the power is turned OFF.

- 1 While the recorder is in stop mode, slide the **POWER** switch to the **[OFF/HOLD]** position.

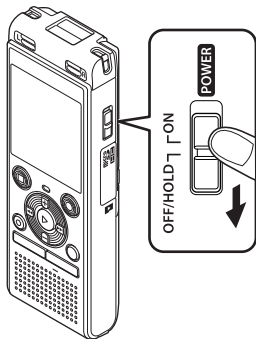

- The playback stop position at power OFF is stored in the memory.

TIP

- Turning the power OFF whenever the voice recorder is not in use minimizes battery consumption.

Power Save mode

When the voice recorder has been stopped for at least 5 minutes after power ON, the display disappears and the voice recorder automatically enters the Power Save mode.

- Pressing any button releases the Power Save mode.

Folders

You can use the internal memory or microSD cards as data recording media. Regardless of the recording media, audio files, music files, and content files are sorted into folders with a tree structure and saved. You can rearrange the saved files in the desired order (P.55).

1

Getting started

Folders for Audio Recordings

Audio recordings are stored in **[Folder A]** through **[Folder E]** directly under the **[Recorder]** folder.

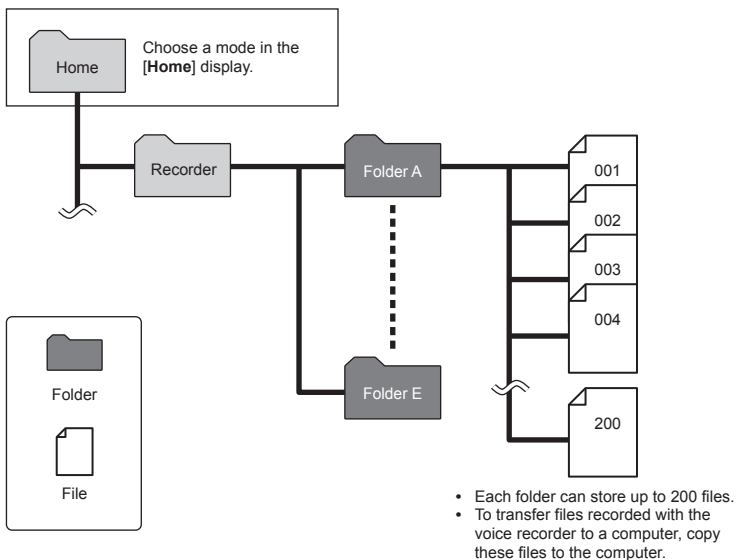

- Files and folders stored directly under the **[Recorder]** folder are not displayed on the voice recorder.

Folders

Music Folders

By transferring music files and folders containing music files from a computer, you can manage the files and folders with the hierarchical structure shown in the diagram below.

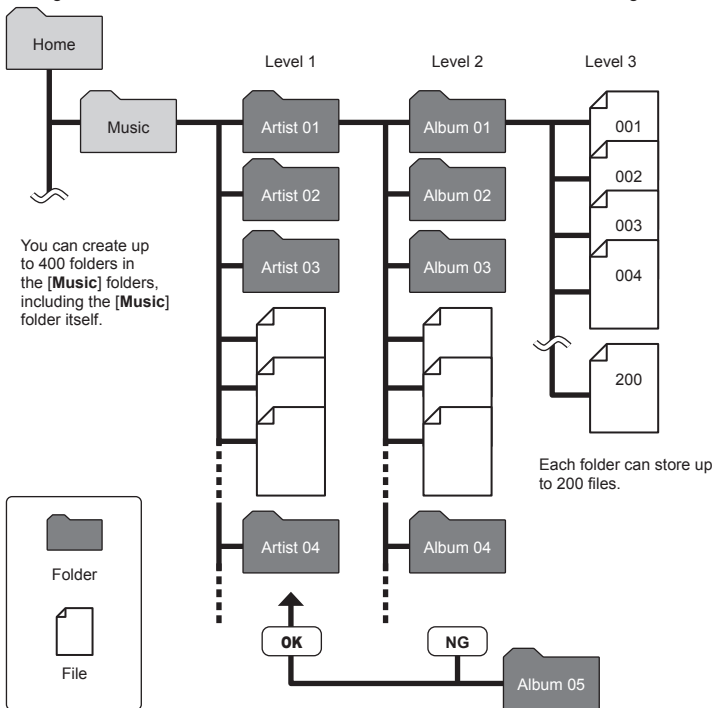

Folders

Podcast Folders

1

Getting started

A **[Podcast]** folder has been created in advance to save files distributed as podcasts. This makes it easier to manage files transferred from a computer to the voice recorder.

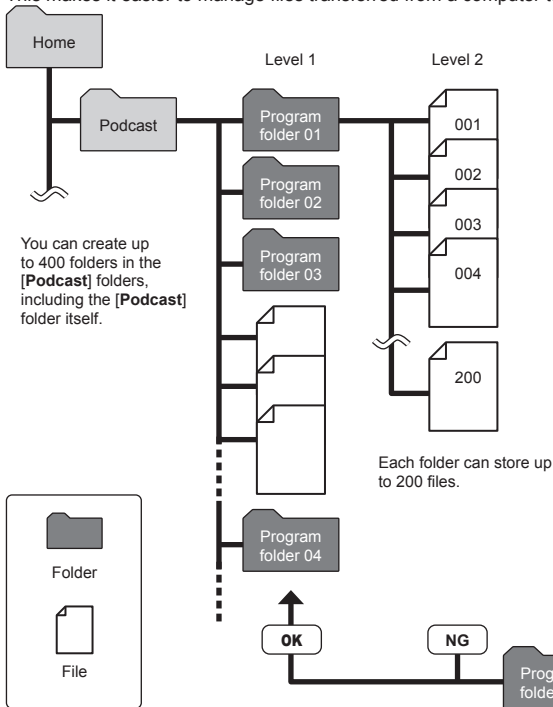

The recorder will not detect files in folders copied from a computer to the second level of folders.

Selecting folders and files

You can select a different folder while the voice recorder is in stopped. See “**Folders**” (P.22) for a description of the voice recorder’s hierarchical folder structure.

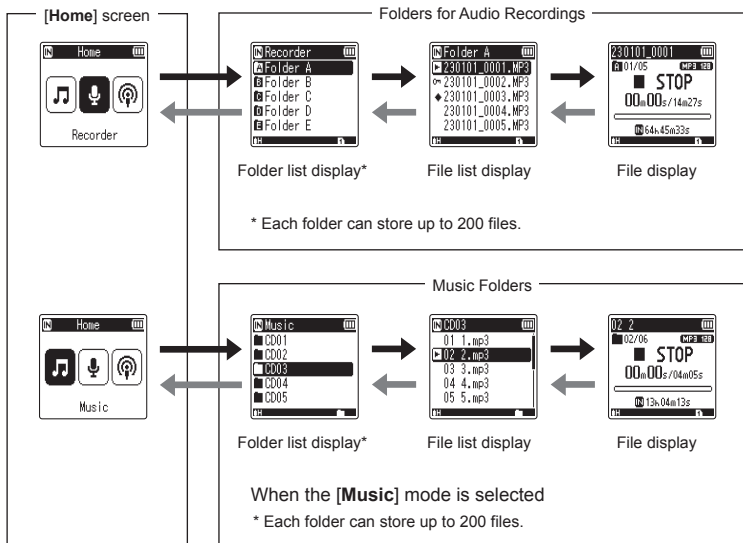

→ Forward: ►OK button

Each press on the ►OK button opens the currently selected folder or file in the list, moving forward to the next (lower) level in the folder hierarchy. When a list is displayed, you can perform the same function by pressing the ►► button.

← Back: FOLDER/INDEX button

Each press on the FOLDER/INDEX button moves back to the previous (higher) level in the folder hierarchy. When a list is displayed, you can perform the same function by pressing the ◀◀ button.

+ or – button

Used to select a folder or file.

[Home] screen

Used to select the voice recorder mode by pressing the ►► or ◀◀ button.

List display

Displays the folders and files recorded in the voice recorder.

File display

Displays the information of the selected file.

Selecting folders and files

Using the Calendar Search function to search for a file

1

Getting started

You can search for voice files by specifying a recording date. If you have forgotten in which folder a file has been saved, this feature lets you access it quickly by entering its recording date.

NOTE

- To perform a calendar search, you need to set [Time & Date] in advance (☞ P.68).
- You can only search for files saved in the folders for audio recordings (☞ to ☞).

- 1 Press the **CALENDAR/SCENE** button while the voice recorder is in stop mode.

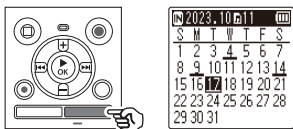

- 2 Press the **+**, **-**, **▶▶** or **◀◀** button to select the desired date.

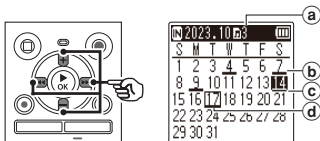

- a Number of files saved (recorded) on selected date
- b Date file was recorded
- c Selected date
- d Today's date

- Dates on which files were saved are underlined.

▶▶ or ◀◀ button:

Move to the previous/next date.

Press and hold to skip to the next date on which a file was recorded.

+ or - button:

Move to the previous/next week.

- Press the **STOP** (■) button to cancel the calendar search and return to the previous screen.

- 3 Press the **▶OK** button.

- 4 Press the **+** or **-** button to select the desired file.

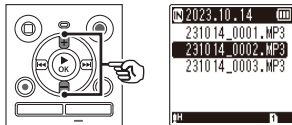

- 5 Press the **▶OK** button to start playback.

Recording

Recording

The voice recorder has five folders ([F1] to [F5]) in which recorded files can be saved. These folders provide a handy way to sort recordings into separate categories (such as business and leisure).

Basic recording procedure

- 1 Select the folder to save the recording in (see P.25).**
 - Each new voice recording file is saved in the selected folder.
- 2 Point the built-in microphone in the direction of the sound to record.**

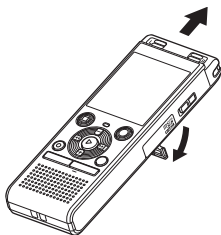

- When necessary, you can use the voice recorder with the stand extended as shown in the figure.

- 3 Press the REC (●) button to start recording.**

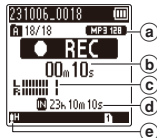
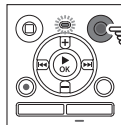

- a) Rec Mode
- b) Elapsed recording time
- c) Level meter (changes according to recording volume and recording function setting)
- d) Remaining possible recording time
- e) Recording level
 - The LED indicator light lights.

- 4 Press the STOP (■) button when you want to stop recording.**

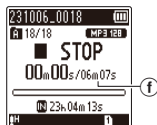
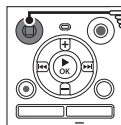

- f) File length

Sound files recorded with the voice recorder are automatically given a file name in the format below.

231006_0018.MP3

①

②

③

① **Date recorded**

Indicates the year, month and day the recording was made.

② **File number**

Appended file numbers are consecutive regardless of whether the recording media has been switched.

③ **Extension**

A file extension indicating the recording format the file was recorded in by the voice recorder.

- Linear PCM format: “.WAV”
- MP3 format: “.MP3”

TIP

- **[Rec Mode]** must be set with the voice recorder stopped (☞ P.58).

Recording linear PCM format files of over 2 GB

When recording a linear PCM format file, recording will continue even after the file size exceeds 2 GB.

- The data is divided and saved in separate files of up to 2 GB. The files are processed as multiple files during playback.
- If the 200th file exceeds 2 GB, recording will end.

NOTE

- To prevent the beginning of the recording being cut off, start recording after the LED indicator light has lit or recording indicator has appeared in the display.
- When the remaining possible recording time is 60 seconds, the LED indicator light starts flashing. It flashes more rapidly as the remaining time decreases (at the 30- and 10-second points).
- When **[Folder full]** appears, no more recording can be done. To record more, you will need to select a different folder or delete unneeded files (☞ P.48).
- If **[Memory full]** appears, the voice recorder has no more available memory space. You will need to delete unneeded files to record more (☞ P.48).
- When using a microSD card in the voice recorder, be sure the desired recording media setting (**[Internal memory]** or **[microSD card]**) has been selected (☞ P.68).
- Processing performance may be reduced when data has been repeatedly written to or deleted from the recording media. Please initialize the recording media in this case (☞ P.70).

Pausing/resuming recording

- 1 Press the **REC** (●) button during recording.

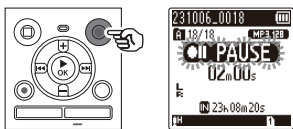

- Recording pauses, and the blinking message [● PAUSE] appears in the display.
- Recording is stopped automatically after being paused for at least 60 minutes.

- 2 Press the **REC** (●) button again while recording is paused.

- Recording resumes from the position it was paused at.

Quickly checking a recording

- 1 Press the ► **OK** button during recording.

Recording settings

Various recording settings are available, letting you tailor recording to different recording conditions.

[Rec Level] (E38 P.58)	Sets the recording level.
[Rec Mode] (E38 P.58)	Sets the recording sound quality.
[Low Cut Filter] (E38 P.59)	Reduces humming sounds from equipment such as air-conditioners or projectors.
[VCVA] (E38 P.59)	Sets the trigger level for voice-activated recording (VCVA).
[V-Sync. Rec] (E38 P.60)	Sets the trigger level for voice-synchronized recording.
[Auto index] (E38 P.62)	Adds an index mark at the start position of the active sound after a period of silence.
[Rec Scene] (E38 P.31)	Used to select one of multiple pre-registered templates of recording settings. When selected, each template enters several settings tailored to a particular recording location or condition all in a single operation.

Monitoring while recording

You can monitor the recording as you are making it by listening on the earphones plugged into the voice recorder's earphone jack (🎧). Use the + or – button to adjust the recording monitor volume.

- The earphones are optional.

- 1 Connect the earphones to the voice recorder's earphone jack (🎧).**

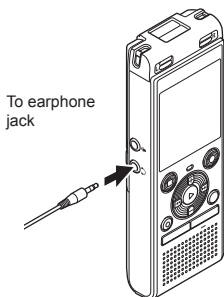

- Changing the volume will not affect the recording level.

NOTE

- To avoid unpleasantly loud sound, set the volume to [00] before plugging in the earphone.
- To prevent feedback, do not place the earphone near the microphone while recording.
- When [Rec Level] (🔊 P.58) is set to [Auto], the effect of the level setting will not be reflected in the recording monitor audio.

Changing the recording scene [Rec Scene]

Changing the recording scene

The voice recorder has pre-registered templates of optimum settings tailored to various recording applications such as conference and dictation. When selecting one of these templates you can enter several settings recommended for your recording application all in a single operation.

[Dictation] [M]DICT.	Suitable for recording your own voice and other sounds that are extremely close.
[Meeting] [M]MEETING	Suitable for recording meetings held in a small space and other sounds that are fairly close.
[Conference] [M]CONF.	Suitable for recording conferences in a large space and other sounds over a wide area.
[Duplication (Auto Divide)] [L]DUPL	Suitable for duplicating from cassette tapes and CDs. The silent intervals between tracks are detected to automatically divide the tracks so each one is saved as a separate file during recording.
[Duplication (Timer)] [L]DUPL	Records continuously to one file and stops when the set time is reached.
[Telephone Rec] [M]TEL.REC	Suitable for recording telephone conversations.

- 1 While the voice recorder is in stop mode, press and hold the CALENDAR/SCENE button.**

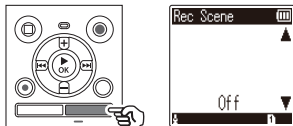

- 2 Press the + or - button to select the desired recording application.**

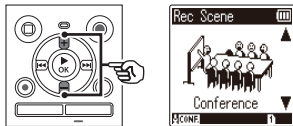

- You can choose from **[Dictation]**, **[Meeting]**, **[Conference]**, **[Duplication (Auto Divide)]** (P.34), **[Duplication (Timer)]** (P.34), **[Telephone Rec]** (P.33) or **[Off]**.
- 3 Press the ► OK button to finalize the setting.**

Changing the recording scene [Rec Scene]

TIP

- [Rec Scene] also can be set from the menu (☰ P.52).

NOTE

- Recording menu settings cannot be changed when a [Rec Scene] selection has been made. To use these functions, you must select [Off] for the [Rec Scene] setting.
- During simple mode, [Rec Scene] cannot be set to [Off] (☰ P.69).

Pre-registered [Rec Scene] settings

[Dictation]

[Rec Level]	[Low]
[Rec Mode]	[MP3 128 kbps]
[Low Cut Filter]	[On]
[VCVA]	[Off]
[V-Sync. Rec]	[Off]
[Auto index]	[Off]

[Meeting]

[Rec Level]	[High]
[Rec Mode]	[MP3 128 kbps]
[Low Cut Filter]	[Off]
[VCVA]	[Off]
[V-Sync. Rec]	[Off]
[Auto index]	[Off]

[Conference]

[Rec Level]	[Auto]
[Rec Mode]	[MP3 128 kbps]
[Low Cut Filter]	[On]
[VCVA]	[Off]
[V-Sync. Rec]	[Off]
[Auto index]	[Off]

[Duplication (Auto Divide)]

[Rec Level]	[Low]
[Rec Mode]	[MP3 128 kbps]
[Low Cut Filter]	[Off]
[VCVA]	[Off]
[V-Sync. Rec]	[On]
[Auto index]	[Off]

[Duplication (Timer)]

[Rec Level]	[Low]
[Rec Mode]	[MP3 128 kbps]
[Low Cut Filter]	[Off]
[VCVA]	[Off]
[V-Sync. Rec]	[Off]
[Auto index]	[Off]

[Telephone Rec]

[Rec Level]	[Low]
[Rec Mode]	[MP3 128 kbps]
[Low Cut Filter]	[On]
[VCVA]	[Off]
[V-Sync. Rec]	[Off]
[Auto index]	[Off]

Recording with an external microphone

Recording with an external microphone

You can record audio input using an external microphone or other device connected to the voice recorder's microphone jack (🎧). Do not plug or unplug devices into voice recorder jacks while recording.

- 1 Connect an external microphone to the voice recorder's microphone jack (🎧).**

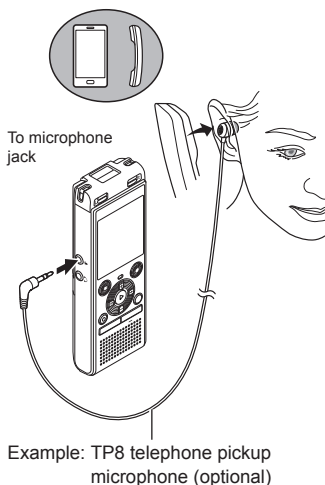

- 2 Press the **REC** (●) button to start recording.**

TIP

- When using the phone microphone (Telephone pickup TP8), set **[Rec Scene]** to **[Telephone Rec]**. This allows you to record conversations on mobile and landline telephones clearly (☞ P.31).
- See "**Accessories (optional)**" (☞ P.81) for the compatible external microphones.

NOTE

- Microphones with plug-in power supplies can be used.
- When **[Rec Mode]** is set to stereo, recording with an external mono microphone records on the left channel only (☞ P.58).
- When **[Rec Mode]** is set to mono, only the input from the left channel microphone is recorded when using an external stereo microphone (☞ P.58).

Recording from another connected device

Recording audio from another device with this recorder

Audio can be recorded when you have connected the audio output terminal (earphone jack) of another device and the microphone jack (🎤) of the recorder using the connecting cord KA333 (optional) for duplication.

2

Recording

- 1 While the voice recorder is in stop mode, press and hold the **CALENDAR/SCENE** button.

- 2 Press the **+** or **-** button to select **[Duplication (Auto Divide)]** or **[Duplication (Timer)]**.

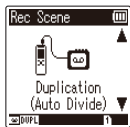
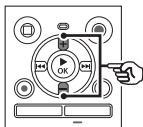

- [Duplication (Auto Divide)]:**
Files are automatically divided into each song when recording.
- [Duplication (Timer)]:**
Recording is saved to one file and stops when the previously set time has been reached.

- 3 Press the **▶ OK** button.

- 4 Press the **+** or **-** button to change the setting.

When **[Duplication (Auto Divide)]** was selected:

[Cassette]:

Suitable for sound sources with a lot of noise such as a cassette tape duplicated from a CD or record.

[CD]:

Suitable for sound sources with little noise such as a CD.

When **[Duplication (Timer)]** was selected:

The time used for duplication can be selected from among **[Off]**, **[30 min.]**, **[60 min.]**, **[90 min.]** and **[120 min.]**.

- 5 Press the **▶ OK** button to finalize the setting.

Recording from another connected device

- 6 **Connect the voice recorder with another device using the connecting cord KA333.**

To audio output terminal of other device

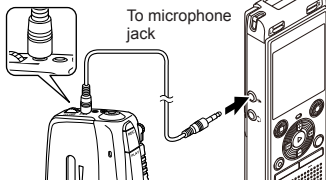

- 7 **Press the REC (●) button to start recording.**
- 8 **Start playback on the other device.**
- 9 **When duplication is completed, press the STOP (■) button to stop recording.**
 - When [Duplication (Timer)] was selected, recording automatically stops when the set time is reached.

NOTE

- Do not plug or unplug devices into voice recorder jacks while recording.
- Perform adjustment of the recording level on the other device.
- To ensure successful recording, we recommend that you test the record function and volume before use.
- In [Duplication (Auto Divide)], an original recording will be copied to separate files divided into each song by the signal level or the noise level of a silent part. When the signal level is too low or the noise is significant, recording and division may not be performed properly. In that case, select [Duplication (Timer)] and manually start and stop recording.
- If the connecting cord is not connected when [Duplication] is selected, the message [Connect an audio cable to the mic jack] is displayed.

Recording from another connected device

Recording audio from this recorder with another device

Audio from this recorder can be recorded to another device by connecting the audio input terminal (microphone/line jack) of the other device and the earphones jack of this recorder using the connecting cord KA333 (optional).

2

Recording

- 1 **Connect the voice recorder with another device using the connecting cord KA333.**

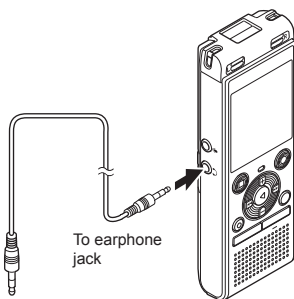

To audio input terminal of other device

NOTE

- Adjusting playback sound quality settings on the voice recorder affects the audio output signals output from the earphones jack (P.63 to P.64).

- 2 **Start recording on the other device.**
- 3 **Press the ► OK button to start playback.**
- 4 **When duplication is completed, press the STOP (■) button to stop playback.**

Playback

In addition to files recorded by the voice recorder, you can also play WAV or MP3 format files transferred from a PC.

Basic playback procedure

- 1 Select the file to play from the folder containing it (see P.25).

TIP

- Files are saved in the locations below.

Files recorded by the voice recorder:

Stored in the [Recorder] folder

([A]-[E] folders)

Music files transferred from a computer:

Stored in the [Music] folder

Podcast files transferred from a computer:

Stored in the [Podcast] folder

- 2 Press the ►OK button to start playback.

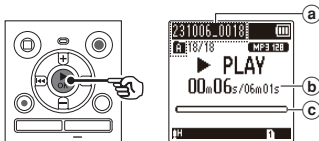

- File name and folder indicator
- Elapsed playback time/File length
- Playback position bar indicator

- 3 Press the + or – button to adjust the volume to the desired level.

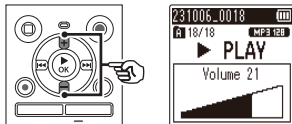

- The volume can be adjusted to a setting between [00] to [30]. The higher the number, the louder the volume.
- If the volume is set too loud, a warning screen may appear.

- 4 Press the STOP (■) button to stop playback.

- The file being played stops right away. The resume function automatically stores the playback stop position in memory. The position is retained even if the power is turned OFF. The next time the power is turned ON, playback can be resumed from the stop position stored in the memory.

Fast-forwarding

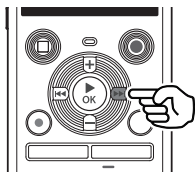

Fast-forwarding while the voice recorder is in stop mode

- 1 With the voice recorder stopped, press and hold the ►► button.

- Fast-forwarding stops when you release the ►► button. Press the ►OK button to start playback from the current position.

Fast-forwarding during playback

- 1 Press and hold the ►► button during playback.
- Playback starts from the current position when you release the ►► button.
 - If an index mark in the file is reached, fast-forwarding stops at the mark (⏮ P.47).
 - Fast-forwarding stops when the end of the file is reached. Press and hold the ►► button again to fast-forward from the beginning of the next file.

Rewinding

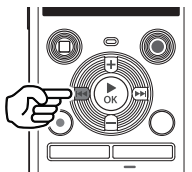

Rewinding while the voice recorder is in stop mode

- 1 With the voice recorder stopped, press and hold the ◀◀ button.

- Rewinding stops when you release the ◀◀ button. Press the ►OK button to start playback from the current position.

Rewinding during playback

- 1 Press and hold the ◀◀ button during playback.
- Playback starts from the current position when you release the ◀◀ button.
 - If an index mark in the file is reached, rewinding stops at the mark (⏮ P.47).
 - Rewinding stops when the beginning of the file is reached. Press and hold the ◀◀ button again to rewind from the end of the previous file.

Skipping to the beginning of a file



Skipping to the beginning of the next file

- 1 Press the **▶▶▶** button while the voice recorder is in stop mode, or during playback.

Skipping to the beginning of the current file

- 1 Press the **◀◀◀** button while the voice recorder is in stop mode, or during playback.

Skipping to the beginning of the previous file

- 1 Press the **◀◀◀** button when the playback position is the beginning of the file.
 - To skip to the beginning of the previous file during playback, press the **◀◀◀** button twice consecutively.

NOTE

- If an index mark is reached when skipping to the beginning of a file during playback, playback starts from the position of the mark. When skipping to the beginning of a file while the voice recorder is in stop mode, the mark is ignored (☞ P.47).
- If a setting other than **[File Skip]** is set for **[Skip Space]**, playback starts after the set amount of time has been skipped backwards or forwards. Playback does not skip to the beginning of the file (☞ P.65).

Playback settings

You can select various file playback methods tailored to different applications and tastes.

[Noise Cancel]* (<small>E33</small> P.63)	A setting that makes recorded voices more discernable when muffled by projector noise or similar sounds.
[Shadowing] (<small>E33</small> P.63)	Alternates between playing with sound and playing without sound (or at a low volume, slowly).
[Voice Balancer]* (<small>E33</small> P.64)	Cuts low- and high-frequency components and compensates low-volume portions during playback.
[Play Mode] (<small>E33</small> P.64)	Selecting from among three playback modes.
[Skip Space] (<small>E33</small> P.65)	A handy function for quickly moving the playback position, and playing short segments repeatedly.

* Function active only when a file in the [Recorder] folder is selected.

Playback through the earphones

You can connect the earphones to the voice recorder's earphone jack (🔌) and listen to playback through them.

- The earphones are optional.

- 1 Connect the earphones to the voice recorder's earphone jack (🔌).**

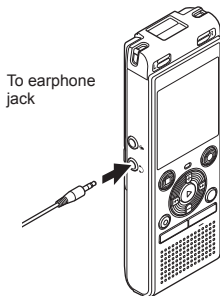

- 2 Press the ▶OK button to start playback.**

- There will be no sound from the speaker when the earphones are connected.

NOTE

- To avoid unpleasantly loud sound, set the volume to [00] before plugging in the earphone.
- Avoid excessive volume when listening to playback through the earphones. It may cause hearing damage or loss.
- If the volume is set too loud, a warning screen may appear.

Music files

If a music file transferred to the voice recorder is unplayable, check that its sampling rate and bit rate values are within the supported ranges. The sampling rate and bit rate combinations supported for music file playback by the voice recorder are shown below.

File format	Sampling rate	Bit count/ bit rate
Linear PCM (WAV) format	22.05 kHz	16 bits
MP3 format	MPEG 1 Layer 3: 32 kHz, 44.1 kHz, 48 kHz MPEG 2 Layer 3: 16 kHz, 22.05 kHz, 24 kHz	8 to 320 kbps

- MP3 files with variable bit rates (bit rates converted variably in a single file) may not play normally.
- Linear PCM-format WAV files are the only WAV files the voice recorder can play. Playback of other WAV files is not supported.
- Even if the file formats is compatible for playback on this recorder, the recorder does not support every encoder.

Changing the playback voice (Voice changer)

You can change the playback speed and voice pitch. Changing the playback speed is handy for speeding up conference presentations, or for slowing down parts difficult to discern when learning a language. Changing the voice pitch makes it possible to convert a voice that is hard to hear into a voice that is easy to hear.

3

Playback

- 1 Press the ►OK button during playback.

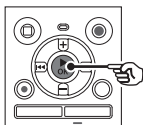

- 2 Press the +/- or ►►/||/◀◀ button to make the voice easier to hear.

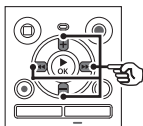

- The playback speed can be selected from [x0.5 Play] (slow playback) to [x2.0 Play] (fast playback) ([x1.0 Play] (normal playback)) in increments of 0.1.
- The pitch can be selected from -10 to +10 in increments of 1.
- ►►/||/◀◀ button:
You can adjust the playback speed.
- +/- button:
You can adjust the pitch (Voice changer).

- 3 Press the ►OK button to finalize the setting.

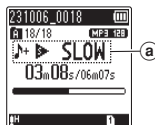
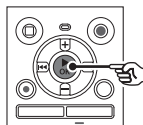

- a Playback speed and pitch indicator

TIP

- To return to the normal playback speed, set the setting to [x1.0 Play].
- To return to the normal pitch, set the setting to [± 0].
- When changing the playback speed or pitch, playback operations such as stopping playback, skipping to the beginning of a file, and writing index marks are the same as during standard playback.

NOTE

- Modified playback speed and pitch settings are retained even after power OFF.
- Changing the playback speed or pitch will make the battery deplete more quickly.
- The **[Noise Cancel]** function cannot be used when changing the playback speed or pitch (☞ P.63).

Fast playback restrictions

Depending on their sampling frequency and bit rate, some files may not play normally.

In this case, you will need to reduce the playback speed.

ABC repeat playback

The voice recorder has a function with which you repeat the playback of a portion (segment) of the file being played. In addition to the A-B repeat function available from previous models, the segment to repeat can be changed during repeat playback. During A-B-C repeat playback, you can use the shadowing playback function which is convenient for language learning. To use the shadowing playback function, set **[Shadowing]** to a setting other than **[Off]** in advance (P.63).

3

Playback

ABC repeat playback

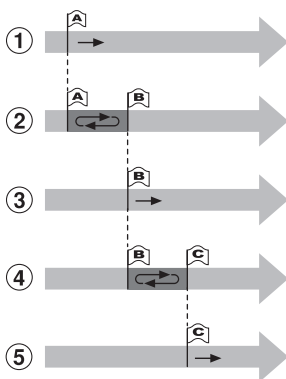

- 1 Select the starting point for repeat playback (A) during playback.
- 2 When the ending point (B) is selected, repeat playback of the AB section starts.
- 3 When the starting point for repeat playback (A) is canceled during repeat playback, the ending point of the segment (B) becomes the new starting point and playback continues.

- 4 When the ending point (C) is selected, repeat playback of the BC section starts again.
- 5 These steps can be repeated to re-specify a new segment to be played back repeatedly up to the end of the file.

- 1 **Select a file for ABC repeat playback, and start playback.**
- 2 **Press the REC (●) button when playback reaches the desired start position for ABC repeat playback.**

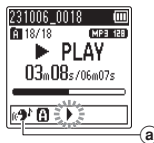
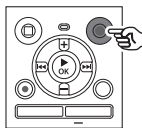

- a Shadowing
- If the **[Shadowing]** setting is enabled, **[Shadowing]** will light up until the end position is fixed.

TIP

- You can change the playback speed (☞ P.42), and fast-forward/rewind (☞ P.38) when the [▶] indicator is blinking.
- If playback reaches the end of the file when the [▶] indicator is blinking, the end of the file is treated as the segment end position, and repeat playback starts.

3 Press the REC (●) button again when playback reaches the desired end position for ABC repeat playback.

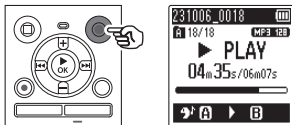

- Segment A-B is set, and ABC repeat playback starts.
- When the [Shadowing] setting is enabled, the repeated section is played silently (low volume or slowly depending on the setting) ([Shadowing] lights up) after the repeated section is played normally ([▶] lights up). This sequence of actions is repeated until the setting is disabled.

Specifying new starting/ending points: ☞ Go to Step 4
Stopping ABC repeat playback: ☞ Go to Step 6

Specifying new starting/ending points

4 Press the REC (●) button during ABC repeat playback.

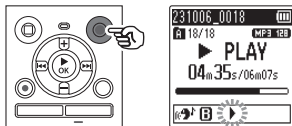

- Segment A-B is canceled. [B] becomes the new start position, and playback continues.
- You can change the playback speed (☞ P.42), and fast-forward/rewind (☞ P.38).
- Shadowing playback does not work until the end position is fixed.

5 Press the REC (●) button at the desired end position for ABC repeat playback.

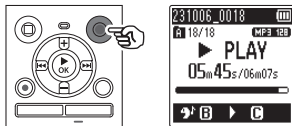

- Segment B-C is set, and ABC repeat playback starts.
- Shadowing playback works.

TIP

- Repeat Steps 4 and 5 to update the ABC repeat segment.

6 Press the **STOP** (■) button.

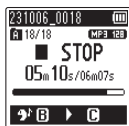
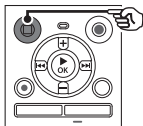

- Playback stops. The playback segment specified for this function is retained.

NOTE

- You cannot change the end position of a repeat playback segment to a position before the start position.
- When an index mark is written or erased during ABC repeat playback, ABC repeat playback is canceled and the voice recorder returns to normal playback.

Canceling ABC repeat playback

- 1 Press the **STOP** (■) button while the voice recorder is in stop mode.

NOTE

- If the **▶▶** or **◀◀** button is operated and the playback position exceeds the start or end position, or if the file is switched to another file, ABC repeat playback is canceled.

Index marks

Writing an index mark in a file enables you to quickly access desired position in the file with the same operations used for fast-forwarding, rewinding or skipping to the start of a file. However, index marks may not be written in files created with devices other than OM Digital Solutions or Olympus voice recorders. Index marks are written during recording or playback.

Writing an index mark

- 1 When the desired position has been reached during recording or playback, press the **FOLDER/INDEX** button to write an index mark.

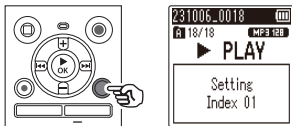

NOTE

- You can write up to 99 index marks in a single file. The message **[No more can be set]** appears if you attempt to write more than 99 marks.
- You cannot write or erase index marks in files that have been locked by the file lock function (P.55).
- If files created with this recorder are played on a computer, index marks may become unable to be written in the files.
- The index function cannot be used for files with tag information other than ID3 tag V2.

Erasing an index mark

- 1 Select a file that contains index mark you want to erase and start playback.
- 2 Use the **▶▶|** or **|◀◀** button to select the index mark you want to erase.

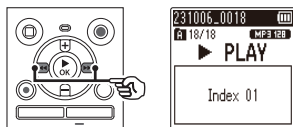

- 3 When the number of the index mark to erase is being shown (for about 2 seconds) in the display, press the **ERASE** button.

- Any subsequent index marks in the file are automatically renumbered.

TIP

- Index marks can be erased all at once (P.48).

Erasing files/folders/indexes

The voice recorder has 5 types of deletion menus ([Indexes in a file]/[All in folder]/[Selected files]/[One file]/[Folder]). Choose according to your purpose.

NOTE

- Stop recording and playback before operating.
- Erased files, folders, and indexes cannot be recovered. Check carefully before erasing.

3

Erasing files/indexes

- 1 Select the file you want to erase from the file list display or file display (see P.25).

File list display

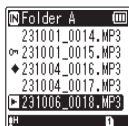

File display



- 2 Press the **ERASE** button while the voice recorder is in stop mode.

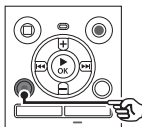

- 3 Press the + or – button to select [Indexes in a file], [All in folder], [Selected files] or [One file].

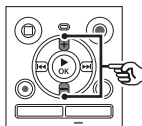

[Indexes in a file]:

Erases all index marks written in the selected files.

[All in folder]:

Erases all the files saved in the same folder as the selected file.

[Selected files]:

Selects the files you want to erase and erases them all at once.

[One file]:

Erases only the selected file.

- The voice recorder returns to the stop mode if no operation is performed for 8 seconds.

Erasing files/folders/indexes

4 Press the ►OK button.

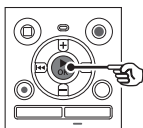

If you select **[Indexes in a file]**, **[All in folder]** or **[One file]**:

➡ Go to Step **5**

If you select **[Selected files]**:

➡ Go to Step **7**

If you select **[Indexes in a file]**, **[All in folder]** or **[One file]**

5 Press the + button to select **[Start]**.

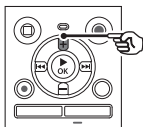

6 Press the ►OK button.

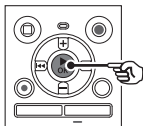

- **[Erasing!]** appears in the display, and the erasing process starts. **[Erased]** appears when the process has finished.

If you select **[Selected files]**

7 Press the + or - button to select the file you want to erase, and press the ►I button to confirm your selection.

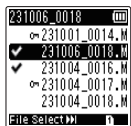
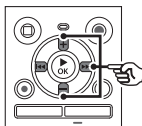

- Press the ►I button again to cancel the selection.

8 Press the ►OK button.

9 Press the + button to select **[Start]**.

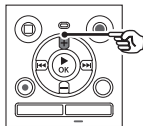

10 Press the ►OK button.

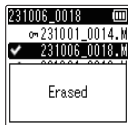
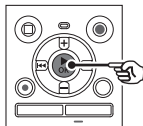

- **[Erasing!]** appears in the display, and the erasing process starts. **[Erased]** appears when the process has finished.

Erasing files/folders/indexes

3

Playback

Erasing a folder

- 1 Select the folder you want to erase from the folder list display (P.25).



- 2 Press the **ERASE** button while the voice recorder is in stop mode.

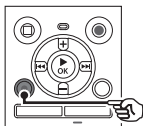

- The voice recorder returns to the stop mode if no operation is performed for 8 seconds.

- 3 Press the **+** button to select **[Start]**.

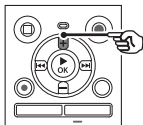

- 4 Press the **▶ OK** button.

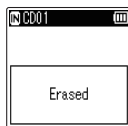
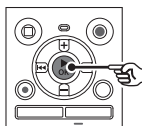

- **[Erasing!]** appears in the display, and the erasing process starts. **[Erased]** appears when the process has finished.

NOTE

- Locked files and read-only files cannot be erased (☞ P.55).
- When there is a microSD in the voice recorder, be sure to check whether the recording media being erased is [**Internal memory**] or [**microSD card**] (☞ P.68).
- The voice recorder's default [**Recorder**] folders ([**Folder A**] – [**Folder E**]), [**Music**] folder, and [**Podcast**] folder cannot be erased.
- Files unrecognizable to the voice recorder will not be erased, nor will folders containing these files. The voice recorder must be connected to a computer to erase these files and folders.
- Before erasing a file or folder, charge or replace the batteries to ensure they will not run out before the process has finished. Erasing processes can take over 10 seconds to complete. To prevent the risk of damage to data, never attempt to perform any of the following processes before an erasing process has finished:
 - Disconnecting the AC adapter
 - Removing the batteries
 - Removing the microSD card (if the recording media has been set to [**microSD card**]).

Setting menu items

Basic operation

In normal mode, menu items are arranged by tabs, letting you quickly set desired items by selecting a tab and then moving to the desired item within the tab. Follow the steps below to set a menu item.

4

Menu

- 1 During recording/playback or while the voice recorder is in stop mode, press the MENU button.

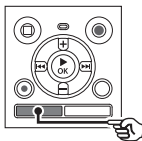

When the screen display is [Simple Mode].



NOTE

- In [Simple Mode], press the MENU button while the voice recorder is in stop mode or playback mode.

TIP

- Some menu items that can be set during recording/playback (P.54).

- 2 Press the + or - button to select the tab containing the item you want to set.

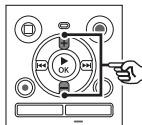

When the screen display is [Simple Mode].



- Moving the cursor from one tab to another switches the displayed menu screen.

- 3 Press the ►OK button to move the cursor to the desired setting item.

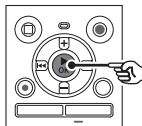

Setting menu items

When the screen display is [Simple Mode].



- You can also use the ►► button to perform this operation.
- Press the ◀◀ button to return to the previous screen.

4 Press the + or - button to select the desired setting item.

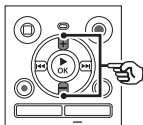

When the screen display is [Simple Mode].



5 Press the ►OK button.

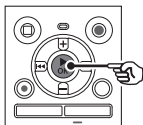

When the screen display is [Simple Mode].



- The setting of the selected item is displayed.

6 Press the + or - button to change the setting.

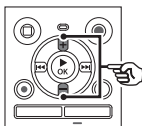

When the screen display is [Simple Mode].



7 Press the ►OK button to finalize the setting.

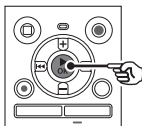

When the screen display is [Simple Mode].



- A message indicating the setting has been entered appears.
- You can cancel the setting and return to the previous screen by pressing the ◀◀ button instead of the ►OK button.

Setting menu items

- 8 Press the **STOP** (■) button to exit the menu screen.

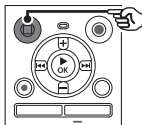

- When the menu screen is displayed during recording or playback, press the **MENU** button to return to the previous screen without ending recording/playback.

NOTE

- For menu settings done while the voice recorder is in stop mode, the voice recorder exits the menu and returns to the stopped mode if no operation is performed for 3 minutes. The selected setting item is not changed in this case.
- For menu settings done during recording/playback, the voice recorder exits the menu if no operation is performed for 8 seconds.

Menu items that can be set during recording

Normal mode only

[Rec Level]	[VCVA]*1
[Low Cut Filter]	[LED]

Menu items that can be set during Playback

Normal mode

[Property]	[Play Mode]
[Noise Cancel]*2	[Skip Space]
[Voice Balancer]*2	[LED]

Simple mode

[Skip Space]

Menu items that can be set during simple mode

[Rec Scene]	[Time & Date]
[Skip Space]	[Beep]
[Memory Select]	[Mode Select]
[Battery]*3	[Language]

*1 [VCVA] is not displayed during V-Sync. Rec or when [Auto index] is set to [On].

*2 [Noise Cancel] and [Voice Balancer] are not displayed in [Music] mode or [Podcast] mode.

*3 WS-883 model only

File menu [File Menu]

Preventing accidental file erasure [File Lock]

The file lock feature lets you lock important files to prevent them being accidentally erased. Once locked, a file is not erased even if the operation for erasing all the files in its folder is performed (P.48).

- 1 **Select the file you want to lock (P.25).**

[Lock]:

File is locked.

[Unlock]:

File lock is canceled.

Sorting files [Sort by]

You can change the playback order of the files in a folder.

- 1 **Press the + or - button to select [File name], [Date ascending] or [Date descending].**

[File name]:

Automatically sorts the files by file name.

[Date ascending]:

Automatically sorts the files by date (recording time/date) from oldest to newest files.

[Date descending]:

Automatically sorts the files by date (recording time/date) from newest to oldest files.

- 2 **Press the + or - button to select the priority of unplayed files.**

[On]:

Sorts unplayed files with priority.

[Off]:

Turns off the priority of the unplayed files.

- 3 **Press the + or - button to select [Recorder], [Music], or [Podcast].**

- All files in the selected folder are sorted.

NOTE

- Folders are always listed in order of their names. You cannot sort folders.

Dividing a file [File Divide]

Large files or files with long recording times can be divided for easier management and editing.

NOTE

- Only file recording on the voice recorder can be divided.

- 1 **Play the file to divide, and stop playback at the desired division point.**
- 2 **Select [File Divide] from the menu on the [File Menu].**

File menu [File Menu]

4

Menu

3 Press the **+** button to select **[Start]**.

4 Press the **▶OK** button.

- **[Dividing!]** appears on the display, and the file dividing process starts. **[File divide completed]** appears when the process has finished.

TIP

- After dividing a file, the first half of the file is given the name "**File name_1**" and the second half "**File name_2**".

NOTE

- Files cannot be divided if there are 200 files in the folder.
- Locked files cannot be divided.
- It may not be possible to divide some file with extremely short recording times.
- To prevent the risk of data damage, never remove the battery while dividing a file.

Increasing the overall volume level of a file [Normalize]

Increase the overall volume level until the highest volume level of the recorded file becomes the no clipping (no distortion) threshold value and then save as a new file.

1 Select the file you want to normalize.

2 Select **[Normalize]** from the menu on the **[File Menu]**.

3 Press the **+** button to select **[Start]**.

4 Press the **▶OK** button.

- **[Normalization in progress]** appears on the display, and the normalization process starts. **[Normalization done]** appears when the process has finished.

TIP

- The file is given the name "**File name_1**" after editing.

NOTE

- The normalize effect may not be achieved for files such as the following.
 - Files originally recorded at a high volume level.
 - Files in which sudden loud sounds are recorded.
 - Files containing a large variation of volume levels.
- If the current folder contains 200 files, **[Normalize]** cannot be performed.
- Do not remove the batteries while normalizing. Data may be corrupted.

Displaying file or folder information [Property]

You can display the information of a file or folder from a menu screen.

File information

1 Press the + or - button to switch the screen.

- Information is displayed for the items **[Name]**, **[Date]**, **[Size]** and **[Bit Rate]**.

Folder information

2 Press the + or - button to switch the screen.

- Information is displayed for the items **[Name]**, **[File]** (the number of files) and **[Folder]** (the number of folders).
- The **[Folder]** item is not displayed in **[Recorder]** mode.
- Displayed numbers of files do not include files in formats that are unrecognizable to the voice recorder.

Recording menu [Rec Menu]

Selecting the recording level [Rec Level]

You can change the recording level (sensitivity) as needed for your recording application.

[High]:

Suited to recording lectures, large conferences and other applications with distant or quiet sound sources.

[Low]:

Suited to recording dictation.

[Auto]:

The recording level always automatically changes according to the volume of the input sound. Suited to recording all sounds.

TIP

- To record the speaker's voice clearly, set **[Rec Level]** to **[Low]**, and place the voice recorder's built-in microphone near the speaker's mouth (5 to 10 cm away).

Setting the recording mode [Rec Mode]

You can prioritize sound quality or recording time. Select the recording mode that best matches your recording application.

[MP3 128 kbps]

[MP3 64 kbps mono]*

[MP3 8 kbps mono]*

[PCM 22.05k mono]*

* Mono recording

TIP

- Sound quality increases as the recording rate value increases.
- Setting a higher recording rate increases file size. Check that you have enough remaining memory before recording.
- To record conferences and presentations clearly, it is recommended to set **[Rec Mode]** to **[MP3 128 kbps]**.

NOTE

- When **[Rec Mode]** is set to stereo, recording with a connected external mono microphone records on the left channel only.
- When **[Rec Mode]** is set to **[MP3 8kbps mono]**, the **(R)** side of the built-in microphone is switched off automatically.

Recording menu [Rec Menu]

Reducing noise during recording [Low Cut Filter]

With the voice recorder's low cut filter function you can make recordings that reduce humming sounds from air-conditioners or low-frequency sounds from equipment such as projectors.

- [On]:**
Turns the low cut filter on.
- [Off]:**
Turns the low cut filter off.

Voice-activated recording function [VCVA]

The voice-activated recording function (VCVA) automatically starts recording when a sound louder than a preset voice activation level is detected, and automatically pauses recording when the sound volume level falls. Use this function to automatically omit unneeded quiet segments when recording (such as long silences during conferences), saving memory.

- [On]:**
Turns VCVA on. You can adjust the voice activation level used for VCVA.
- [Off]:**
Turns VCVA off. Restores standard recording.

Adjusting the voice activation level for voice-activated recording

1 Press the **REC (●)** button to start recording.

- Recording pauses automatically about 1 second after the input sound becomes quieter than the set activation sensitivity. The blinking message **[Standby]** appears in the display. The LED indicator light becomes lit when recording is activated and flashes when recording is paused.

2 Press the **▶▶** or **◀◀** button to adjust the voice activation level.

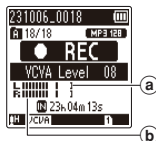
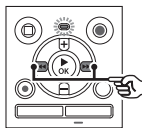

- a** Voice activation level (moves left/right to match set level)
 - b** Level meter (changes in proportion to recording sound volume)
- The setting can be adjusted to between **[01]** and **[15]**.

TIP

- Increasing the setting number increases the VCVA activation sensitivity, enabling quieter sounds to activate the start of recording.
- Adjust the VCVA voice activation level to suit the recording conditions (to cope with high levels of surrounding noise or alike).
- To avoid recording mistake, it's recommended to perform a test recording beforehand to adjust the voice activation level.

NOTE

- The following functions are disabled when using the [VCVA] function:
 - [Rec Scene] (P.31)
 - [V-Sync. Rec] (P.60)
 - [Auto index] (P.62)

Voice sync recording function [V-Sync. Rec]

The voice sync recording function automatically starts recording when a sound louder than a preset voice sync recording level (detection level) is detected, and automatically stops recording when the sound volume level decreases. When copying music from another device connected to the voice recorder, use the voice sync recording function to detect the silent intervals between music tracks and save each track as a separate file.

[1 sec.], [2 sec.], [3 sec.], [5 sec.]:

Set the detection time. The voice recorder enters standby mode when the input (recording level) is below the preset level for at least the set detection time.

[Off]:

Recording is done normally.

Recording menu [Rec Menu]

Adjusting the voice sync level for voice sync recording

- 1 Press the **REC** (●) button to prepare for recording.
- 2 Press the **▶▶** or **◀◀** button to adjust the voice sync level.

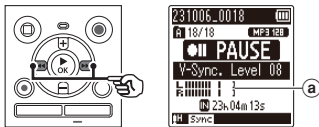

- a Voice sync level (moves left/right to match set level)
- The voice sync level can be adjusted to a setting between [01] and [15].
 - Increasing the setting number increases the activation sensitivity, enabling quieter sounds to activate the start of recording.
- 3 Press the **REC** (●) button again.

- The blinking message [Standby] appears in the display, and the LED indicator light flashes.
- Recording starts automatically if the input is louder than the voice sync level.

TIP

- The voice recorder automatically ends recording and returns to recording standby mode when the input sound has been below the voice sync level for at least the set detection time. Each time the voice recorder enters standby mode, the current file is closed. Recording continues in a new file the next time sound is detected.
- Press the **STOP** (■) button to end a voice sync recording session.

NOTE

- The following functions are disabled when using the [V-Sync. Rec] function:
 - [Rec Scene] (P.31)
 - [VCVA] (P.59)
 - [Auto index] (P.62)

Recording menu [Rec Menu]

4

Menu

Writing an index mark at the start position of the active sound [Auto index]

Auto index is a function that writes an index mark at the start position of active sound after silence continues for 3 minutes or more. This makes it easier to skip silent sections during playback.

[On]:

Turns the auto index on. An index mark is written automatically at the start position of active sound after silence continues for 3 minutes.

[Off]:

Turns the auto index off.

Adjusting the index level

- 1 Press the **REC** (●) button to start recording.
- 2 Press the **▶▶** or **◀◀** button to adjust the index level.

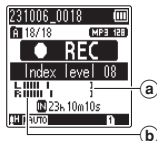
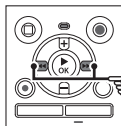

- a Index level (moves left/right to match set level)
 - b Level meter (changes in proportion to recording sound volume)
- The setting can be adjusted to between [01] and [15].

NOTE

- Up to 99 auto index marks can be written. The message [Index full] appears if the mark number exceeds 99.
- The following functions are disabled when using the [Auto index] function:
 - [Rec Scene] (P.31)
 - [VCVA] (P.59)
 - [V-Sync. Rec] (P.60)

Playback menu [Play Menu]

Reducing noise during playback [Noise Cancel]

Use the **[Noise Cancel]** function to reduce noise when a recorded voice is difficult to discern.

[High] [Low]:

Reduces surrounding noise, producing higher sound-quality playback.

[Off]:

The noise cancel function is disabled.

NOTE

- **[Noise Cancel]** is only enabled in **[Recorder]** mode.
- If the **[Noise Cancel]** function is used, the battery will deplete more quickly.
- The following function will not be available while you are using the **[Noise Cancel]** function.
 - Changing the playback voice (☞ P.42)
 - **[Slow playback]** of the **[Shadowing]** function (☞ P.63)

Playing back alternately with and without sound [Shadowing]

With the shadowing function of the voice recorder, the ABC repeat playback (☞ P.44) setting section is alternately played back at normal volume and silence (lower volume or slower depending on the setting). This is an optimal function for listening and speaking practice. Please use it for language learning.

[Silent]:

After the repeat section is played at normal volume, the repeat section is played silently.

[Small volume]:

After the repeat section is played at normal volume, the repeat section is played at low volume.

[Slow playback]:

After the repeat section is played, the repeat section is played at a slow speed.

[Off]:

Turn the shadowing playback off.

NOTE

- Shadowing playback is a function that is enabled by performing ABC repeat playback. After finalizing the settings for shadowing playback and exiting the menu screen, see **"ABC repeat playback"** (☞ P.44).
- When **[Shadowing]** is set to **[Slow playback]**, the **[Noise Cancel]** function will not be available (☞ P.63).

Playback menu [Play Menu]

4

Menu

Adjusting low volume portions during playback [Voice Balancer]

Cuts low- and high-frequency components and compensates low-volume portions during playback. Use it to make quiet parts of conversations or other recorded audio louder and clearer.

[On]:
Turns the voice balancer function on.

[Off]:
Turns the voice balancer function off.

NOTE

- [Voice Balancer] is only enabled in [Recorder] mode.
- Using the [Voice Balancer] function will make the battery deplete more quickly.

Selecting playback modes [Play Mode]

Several playback modes are available for different listening styles.

1 Press the + or – button to select [Recorder], [Music] or [Podcast].

2 Press the ► OK button.

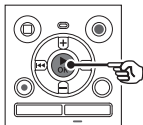

If you select [Recorder] or [Podcast]:

➤ Go to Step **3**

If you select [Music]:

➤ Go to Step **5**

When [Recorder] or [Podcast] was selected

3 Press the + or – button to select [Playback range] or [Repeat].

[Playback range]:

Lets you specify a range of files for playback.

[Repeat]:

Repeatedly plays the files in the set range.

4 Press the + or – button to select a setting.

When [Playback range] was selected:

[File]:

Stops playback after the current file has been played.

[Folder]:

Plays all the files in the current folder consecutively, stopping playback after the last file in the folder is played.

When [Repeat] was selected:

[On]:

The files in the specified playback range are played repeatedly.

[Off]:

Cancels repeat playback.

Playback menu [Play Menu]

When [Music] was selected

- 5 Press the + or – button to select [Playback range], [Repeat] or [Random].**

[Playback range]:

Lets you specify a range of files for playback.

[Repeat]:

Repeatedly plays the files in the set range.

[Random]:

Plays the files in the set range at random.

- 6 Press the + or – button to select a setting.**

When [Playback range] was selected:

[File], [Folder], [All]:

Specify the range of files for playback.

When [Repeat] or [Random] was selected:

[On]:

The files in the specified playback range are played repeatedly or at random.

[Off]:

Cancels repeat playback and random playback.

NOTE

- When [Playback range] is set to [File], [End] blinks in the display for 2 seconds after the last file in the folder has been played, then playback stops at the start position of the last file.
- When [Playback range] is set to [Folder], [End] blinks in the display for 2 seconds after the last file in the folder has been played, then playback stops at the start position of the first file in the folder.

Setting a skip space [Skip Space]

The [Skip Space] function lets you skip a preset amount forward (forward skip) or backward (reverse skip) in a file during playback. It is handy for quickly moving the playback position, or for repeated playback of a short segment.

When the screen display is [Normal Mode]

- 1 Press the + or – button to select [Forward Skip] or [Reverse Skip].**

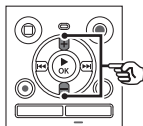

Playback menu [Play Menu]

[Forward Skip]:

Starts playback after moving the playback position forward by the set amount.

[Reverse Skip]:

Starts playback after moving the playback position backward by the set amount.

2 Press the + or - button to select a setting.

When [Forward Skip] was selected:

[File Skip], [10 sec. Skip], [30 sec. Skip], [1 min. Skip], [5 min. Skip], [10 min. Skip]

When [Reverse Skip] was selected:

[File Skip], [1 sec. Skip] to [3 sec. Skip], [5 sec. Skip], [10 sec. Skip], [30 sec. Skip], [1 min. Skip], [5 min. Skip]

When the screen display is [Simple Mode]

- 1 Press the + or - button to select [File Skip], [◀◀5sec 10sec ▶▶] or [◀◀5min 10min ▶▶].

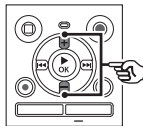

[File Skip]:

Skips in units of files.

[◀◀5sec 10sec ▶▶]:

Pressing the ◀◀ button rewinds 5 seconds; pressing the ▶▶ button fast-forwards 10 seconds and then the playback starts.

[◀◀5min 10min ▶▶]:

Pressing the ◀◀ button rewinds 5 minutes; pressing the ▶▶ button fast-forwards 10 minutes and then the playback starts.

NOTE

- Forward/reverse skip operations over a skip space that contains an index mark or the starting position of a file will stop at that mark or at the start position.

Forward/reverse skip playback

- 1 Press the ▶OK button to start playback.
- 2 Press the ▶▶ or ◀◀ button during playback.

- Playback starts after skipping forward or backward by the set amount.

LCD/Sound menu [LCD/Sound Menu]

Adjusting the contrast [Contrast]

You can adjust the contrast of the display to 12 different levels.

- The setting can be adjusted to between [01] to [12].

Setting the LED indicator light [LED]

You can set the LED indicator light to not become lit.

- [On]:
LED indicator light is switched on.
- [Off]:
LED indicator light stays off.

TIP

- Even if you set the [LED] setting to [Off], the LED indicator light will flash while files are being transferred between the voice recorder and a PC.

Turning beeping sound ON/OFF [Beep]

The voice recorder makes beeping sounds when buttons are pressed, or to warn in case of operation errors. You can select whether the voice recorder makes these beeping sounds.

- [On]:
Enables beeping sounds.
- [Off]:
Disables beeping sounds.

Changing the display language [Language]

You can select the language used in the voice recorder's displays.

- [日本語], [Čeština], [Dansk], [Deutsch], [English], [Español], [Français], [Italiano], [Nederlands], [Polski], [Русский], [Svenska], [繁體中文].

Device menu [Device Menu]

Selecting the recording media [Memory Select]

If a microSD card is inserted into the voice recorder, you can select whether to use the internal memory or the microSD card (P.18).

[Internal memory]:

Uses on the internal memory on the voice recorder.

[microSD card]:

Uses on the microSD card.

Setting the battery in use [Battery]

Set the battery type to match the battery you are using.

! WS-883 model only

[Ni-MH]:

Select this setting when using Ni-MH rechargeable BR404 batteries.

[Alkaline]:

Select this setting when using an alkaline dry cell battery.

Setting the time/date [Time & Date]

If you set the date and time, you will be able to check when a file was recorded in the information for each file accessed from [Property] of the menu.

- 1 Press the ►► or ◀◀ button to select the desired setting item.

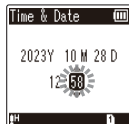
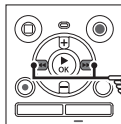

- 2 Press the + or - button to change the number.

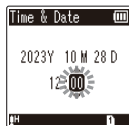
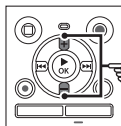

- To change the setting of another item, press the ►► or ◀◀ button to move the blinking cursor, then press the + or - button to change the number.
- 3 Press the ►OK button to finalize the setting.

TIP

- When setting the year, month or date, each time you press the **FOLDER/INDEX** button the display order used for the date changes.

Example: October 28, 2023

2023Y 10M 28D
(default format)



10M 28D 2023Y



28D 10M 2023Y



NOTE

- If the batteries are removed from the voice recorder, the **[Time & Date]** screen is displayed automatically when the power is turned on.

WS-883 model only:

- If you use nickel-metal hydride rechargeable batteries (BR404), the **[Time & Date]** screen may be displayed when the batteries are running out of power, even though they have not been replaced.

Selecting the mode [Mode Select]

With this recorder, you can choose between normal mode and simple mode, which lists frequently used functions. In simple mode, the displayed text becomes larger for easier viewing.

[Normal Mode]:

This is the standard mode in which all functions are available.

[Simple Mode]:

This mode lists frequently used functions. Displayed text becomes larger for easier viewing.

Restoring the default settings [Reset Settings]

The **[Reset Settings]** function restores all the voice recorder's functions to their initial (factory default) settings. Time setting and file number will remain the same.

- Press the + button to select [Start].**

Rec Menu:

Rec Level: Auto
Rec Mode: MP3 128 kbps
Low Cut Filter: Off
VCVA: Off
V-Sync Rec: Off
Auto index: Off
Rec Scene: Off

Play Menu:

Noise Cancel: Off
Shadowing: Off
Voice Balancer: Off
Play Mode:
 Playback range: File
 Repeat: Off
 Random: Off
Skip Space:
 Forward Skip: File Skip
 Reverse Skip: File Skip

LCD/Sound Menu:

Contrast: Level 06
LED: On
Beep: On
Language: 日本語

Device Menu:

Memory Select: Internal memory
Battery*: Ni-MH
Mode Select: Normal Mode

* WS-883 model only

Formatting a recording media [Format]

Formatting a recording media erases all existing files saved on it. Be sure to transfer all important files to a PC before formatting.

- 1 Press the + or - button to select the recording media to be formatted.**

[Internal memory]:

Formats the internal memory.

[microSD card]:

Formats the microSD card.

- 2 Press the ►OK button.**
- 3 Press the + button to select [Start], then press the ►OK button.**
- 4 Press the + button to select [Start] again, then press the ►OK button.**

- [Formatting!] appears, and formatting starts.
- [Format done] appears when the process has finished.

TIP

- To reset all the voice recorder's settings to their default values, use the [Reset Settings] operation (P.69).

NOTE

- Never format the voice recorder from a PC.
- Formatting erases all the existing data, including locked files and read-only files.
- Before formatting, charge or replace the battery to ensure it will not run out before the process is finished. The formatting process can sometimes take over 10 seconds to complete. To prevent the risk of damage to data, never attempt to perform any of the following processes before a formatting process has finished:
 - ① Removing the battery
 - ② Removing the microSD card (if the recording media to be initialized is a **[microSD card]**).
- If there is a microSD card in the voice recorder, make sure **[Internal memory]** or **[microSD card]** has been correctly selected as the recording media to erase (☞ P.68).
- Even when formatting or erasing (☞ P.48) is performed, only the file management information of the internal memory and/or microSD card is updated and the recorded data is not completely erased. When disposing of a microSD card, be sure to destroy the card, format the card and record silence until the recording time runs out, or perform a similar operation in order to prevent the leakage of personal information.

Checking recording media information [Memory Info.]

You can display the capacity and remaining memory space of the recording media from a menu screen.

NOTE

- Some recording media memory capacity is used as a management area, so the actual usable capacity will always be slightly less than the displayed capacity.

Checking voice recorder information [System Info.]

You can display voice recorder information from a menu screen.

- The voice recorder's **[Model]**, **[Version]** (system version) and **[Serial No.]** information is displayed.

Use with a PC

When connecting the voice recorder to a PC you can do the following:

- You can enjoy language content or music files in MP3 and linear PCM (WAV) format stored on your PC.
- Use the voice recorder as external storage to save or load data to/from your PC (☞ P.22).

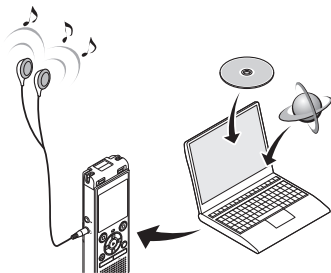

- The earphones are optional.

5

Use with a PC

PC connection precautions

- When uploading or downloading a file to or from the voice recorder, data transfer will continue as long as the voice recorder's LED indicator light is flashing, even if the PC data communication screen disappears. Never disconnect the USB connector before data communication has finished. Always use the procedure on ☞ P.74 to disconnect the USB connector. Data may not be transferred correctly if you disconnect the connector before the drive has stopped.
- Do not format (initialize) the voice recorder's drive from a PC. Formatting done from a PC will not be done correctly. Use the voice recorder's **[Format]** menu for formatting (☞ P.70).
- Voice recorder folders or files that are moved or renamed on a PC file management screen may be reordered or become unrecognizable.
- To prevent nearby electronic devices being affected by noise, disconnect the external microphone and earphones when connecting the voice recorder to a PC.

PC connection/disconnection

Connecting the voice recorder to a PC

- 1 Start the PC.
- 2 Slide the USB connector slide lever in the direction of the arrow.

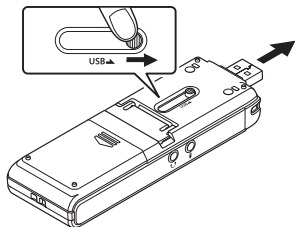

- 3 After making sure the voice recorder is in stop mode, connect its USB connector to a USB port on the PC.

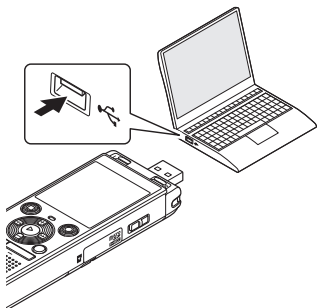

- [Remote] appears in the recorder display when the recorder is connected to a computer via USB.

WS-883 model only: When you use a nickel-metal hydride rechargeable battery:

- To charge the battery, press the ►OK button.
- To cancel the battery charging, press the any button other than ►OK.

TIP

- For information on the PC's USB port, see the PC's user manual.
- Use the optional USB extension cable (KP19) if needed.

NOTE

- Insert the USB connector securely all the way. Operation will not be normal if the connection is not made properly.
- Connecting the voice recorder through a USB hub may result in unstable operation. Do not use a USB hub if operation is unstable.
- Use only the dedicated USB extension cable (KP19). Operation is not guaranteed if another manufacturer's cable is used. Also, never use this dedicated cable with any other company's products.

PC connection/disconnection

Disconnecting the voice recorder from a PC

Check that the LED indicator light of the voice recorder has stopped blinking and then disconnect the USB cable.

TIP

- You can disconnect the USB cable and use the voice recorder before the battery is fully charged (WS-883 model only).

NOTE

- To prevent the risk of data damage, never disconnect the voice recorder from the USB port while the LED indicator light is flashing.

Other information

Alarm message list

Message	Meaning	Action required
Battery low	The remaining battery power is low.	Replace or charge the battery (☞ P.8, P.12).
File locked	An attempt was made to erase a locked file.	You must unlock the file before you can erase it (☞ P.55).
No more can be set	The maximum number of index marks (99) have been written in the file.	Erase unneeded index marks (☞ P.47).
Folder full	The maximum number of files (200) have been saved in the folder.	Erase unneeded files (☞ P.48).
Memory error	An internal memory error occurred.	Contact the Customer Support Center (☞ back cover).
Card error	The microSD card was not recognized correctly.	Remove and reinsert the microSD card (☞ P.18, P.19).
Memory full	There is no remaining memory.	Erase unneeded files (☞ P.48).
No file	There are no files in the folder.	Select another folder (☞ P.25).
Format error	A formatting problem occurred.	Format the memory again (☞ P.70).
Can't create the system file. Connect to PC and erase unnecessary file	The voice recorder is unable to create a management file due to low remaining memory.	Connect the voice recorder to a PC and erase unneeded files.
	The attribute of the voice recorder's drive is set to 'Read only' on a PC.	Connect to a PC and undo the 'Read only' setting.

Alarm message list

Message	Meaning	Action required
Cannot play this file	The file's format is not supported.	Select a file that can be played by the voice recorder (P.41).
Select a file	No file has been selected.	You must select a file before you can perform the operation (P.25).
This file can't be divided.	An attempt was made to divide a file other than an MP3 and a linear PCM (WAV) format file recorded by the voice recorder.	Select another file (P.25).
Connect an audio cable to the mic jack	Another device was not connected to the voice recorder when duplicating was performed.	Use a separately sold connecting cord (KA333) to connect another device to the microphone jack of the voice recorder (P.34).

Troubleshooting

Problem	Possible cause	Solution
The display is blank.	The battery is not inserted properly.	Check that the positive and negative terminals of the battery are placed correctly (☞ P.8).
	The remaining battery power is low.	Replace or charge the battery (☞ P.8, P.12).
	The power is OFF.	Turn the power ON (☞ P.9).
Unable to operate the voice recorder.	The remaining battery power is low.	Replace or charge the battery (☞ P.8, P.12).
	The power is OFF.	Turn the power ON (☞ P.9).
	The voice recorder is in HOLD mode.	Release HOLD mode (☞ P.20).
Unable to record.	There is no remaining memory.	Erase unneeded files (☞ P.48).
	The maximum number of recordable files has been reached.	Select another folder (☞ P.25).
Playback is inaudible.	The earphones are connected to the earphone jack.	To output the playback through the built-in speaker, disconnect the earphones.
	The volume is set to [00].	Adjust the volume (☞ P.37).
The recording is too quiet.	A low recording level has been set.	Redo recording after setting the recording level to [High] (☞ P.58).
	The recording target is too far away.	Bring the voice recorder closer to the recording target.
	The output level of the connected external device may be too low.	Adjust the output level of the external device.

Troubleshooting

Problem	Possible cause	Solution
An audio file is not recorded in stereo.	The connected external microphone is a mono microphone.	Sound recorded by a connected external mono microphone is recorded on the left channel only.
	[Rec Mode] is set to a mono recording format.	Set [Rec Mode] to [MP3 128 kbps] (P.58).
Missing audio file.	The file was recorded in a different folder.	Select another folder (P.25).
Noise during playback.	Objects brushed against the voice recorder while recording.	Try your best not to touch the voice recorder during recording.
	The voice recorder was placed near a mobile phone or fluorescent light during recording or playback.	Redo the operation with the voice recorder in a different location.
Unable to erase a file.	The file is locked.	You must unlock the file before you can erase it (P.55).
	The file is a read-only file.	Unlock the file, or undo the read-only setting on a PC.
Noise when monitoring a recording.	Feedback is being caused.	Connecting a speaker with a built-in amplifier may cause feedback during recording. Using the earphones to monitor recording is recommended. Adjust the recording setup such as by moving the earphones and microphone farther apart, or ensuring the microphone is not facing the earphones.

Troubleshooting

Problem	Possible cause	Solution
Unable to write index marks.	The maximum number of marks (99) has been reached.	Erase unneeded marks (☞ P.47).
	The file is locked.	Unlock the file (☞ P.55).
	The file is a read-only file.	Unlock the file, or undo the read-only setting on a PC.
Unable to charge the battery.	WS-883 model only	
	[Alkaline] has been selected for [Battery]. Or you are trying to charge a non-specified rechargeable battery.	Use the specified rechargeable battery (BR404) and select [Ni-MH] for [Battery]. Do not use the rechargeable battery at higher/lower temperatures than the recommended range (☞ P.16, P.68).
	The ►OK button was not pressed.	Press the ►OK button as directed in the confirmation screen shown when connecting the USB connector (☞ P.12).
Unable to select the menu item I want to set.	[Simple Mode] has been selected for [Mode Select].	When you want to set a menu item other than [Rec Scene], [Skip Space], [Memory Select], [Time & Date], [Beep], [Mode Select], and [Language], set the mode selection setting to [Normal Mode] (☞ P.69).
Playback speed is fast (or slow).	Playback speed function is set to anything other than [x1.0 Play].	Set the playback speed function setting to [x1.0 Play] (☞ P.42).

Recorder care

● Exterior

- Wipe gently with a soft cloth. If the recorder is very dirty, soak the cloth in mild soapy water and wring well. Wipe the recorder with the damp cloth and then wipe it with a dry cloth.

● Display

- Wipe gently with a soft cloth.

NOTE

- Do not use benzene, alcohol or other strong solvents, or chemical cleaning cloths.

Accessories (optional)

For more information on the accessories available for this product, visit our website. Availability of accessories differs depending on the country.

BR404 nickel-metal hydride AAA rechargeable battery

A high-efficiency, long-lasting rechargeable battery.

F-5AC USB-connection AC adapter

A USB-connected AC adapter that provides 5-volt DC output. (100-240 VAC, 50/60 Hz)

ME33 boundary microphone

A microphone for recording conferences that enables connection of up to three left- and three right-channel units.

Cascade connection enables the left/right channel connections to be extended up to about 12 meters, to capture sound from a broad range.

ME30W two-channel microphone (omni-directional)

An omni-directional microphone pair with a low-noise design ideal for recording in lecture halls or other large venues. The left and right microphones can be placed up to about 5 meters apart.

TP8 telephone pickup microphone

An earphone microphone that can be worn in the ear during phone calls. Clearly captures voices and conversations during phone calls.

KP19 USB connection cable

KA333 connecting cord

A resistive connection cord with stereo 3.5 mm diameter plugs on both ends. Used to connect the earphone jack output to the microphone input when recording. Comes with plug adapters (PA331/PA231) that adapt to mono 3.5 mm diameter plugs or mono 2.5 mm diameter plugs.

CS131 Soft carrying case

Copyright and trademark information

- The information in this document is subject to change in future without prior notice. Contact Customer Support Center for the latest product names, model numbers and other information.
- Voice recorder displays and product illustrations shown in this manual may differ from the actual product. While every precaution has been taken to ensure the accuracy of the information in this manual, errors may occasionally arise. Any questions or concerns regarding doubtful information, or possible errors or omissions should be directed to the Customer Support Center.
- OM Digital Solutions Corporation is the copyright holders of this manual. Copyright law prohibits unauthorized reproduction of this manual, or unauthorized distribution of reproductions thereof.
- Note that we will not be held liable in the event of damages, lost earnings, or any claims from third parties resulting from improper use of the product.

Trademarks and registered trademarks

- IBM and PC/AT are trademarks or registered trademarks of International Business Machines Corporation.
- microSDHC Logo is a trademark of SD-3C LLC.
- The product uses MP3 audio coding technology licensed from Fraunhofer IIS and Thomson.

All other brand or product names in this manual are the trademarks or registered trademarks of their respective owners.

All other company and product names are registered trademarks and/or trademarks of their respective owners. “™” and “®” symbols may sometimes be omitted.



Third-Party Software

The software in this product may include third party software. Any third party software is subject to the terms and conditions, imposed by the owners or licensors of that software, under which software is provided to you.

Those terms and other third party software notices, if any, may be found in the software notice PDF file stored at <https://cs.olympus-imaging.jp/en/support/imsg/digicamera/download/notice/notice.cfm>

Safety precautions

Before using the voice recorder, read this manual to ensure correct and safe operation. After reading this manual, be sure to keep it on hand for reference whenever needed.

Important safety precautions

- Important safety precautions in this manual are accompanied by the symbols and labels below. Always follow these precautions to prevent harming yourself or others, or causing damage to property.
- The meaning of each precaution type is given below.

DANGER

A precaution about an imminent danger that is expected to result in death or serious injury if equipment is handled incorrectly.

WARNING

A precaution about a situation that is expected to potentially result in death or serious injury if equipment is handled incorrectly.

CAUTION

A precaution about a situation that is expected to potentially result in injury, or is expected to result only in property damage, if equipment is handled incorrectly.

Voice recorder safety precautions

WARNING

- **Do not use the voice recorder in an atmosphere that might contain flammable or explosive gases.**

It may cause fire or explosion.

- **Do not attempt to disassemble, repair or modify the voice recorder.**

It may cause electric shock or injury.

- **Do not operate the voice recorder while operating a vehicle (such as a bicycle, motorcycle or car).**

It may cause traffic accidents.

- **Do not leave the voice recorder in a location accessible to infants and children.**

Pay attention when using the voice recorder near infants and children, taking care not to leave it unattended. Infants and children are unable to understand voice recorder safety precautions, and are at risk of accidents such as:

- Strangulation caused by accidental entanglement of the earphone cord around the neck.
- Operation errors resulting in injury or electric shock.

- **Use microSD/microSDHC memory cards only. Never place other types of cards in the voice recorder.**

If another card type is placed in the voice recorder by accident, do not try to pull it out with force. Contact repair center or service center.

Safety precautions

- **If the voice recorder is dropped in water or, if water, metal or combustible foreign matter gets inside:**

- ① Remove the battery immediately.
- ② Contact your place of purchase or service center for repair. Continued use may result in fire or electric shock.

- **Do not use the voice recorder or use it only as directed in airplanes, hospitals or other locations where use of electronic devices is restricted.**
- **Stop using the voice recorder if you notice unusual odor, noise, or smoke coming from it.**

It may cause fire or burns. Remove the battery immediately, taking care not to burn yourself. Contact your place of purchase, repair center, or service center. (Do not touch the batteries with bare hands when removing them. Remove the batteries outdoors, and away from flammable objects.)

- **When carrying the voice recorder by its strap, take care to prevent it becoming caught on other items.**

CAUTION

- **Do not raise the volume before performing an operation.**
Hearing damage or loss may result.

Batteries

DANGER

- **Do not place the battery near ignition sources.**

- **Do not incinerate, heat or disassemble the battery. Do not short-circuit the battery's positive and negative electrodes.**

It may cause fire, ruptures, combustion or overheating.

- **Do not solder connections directly onto the battery. Do not deform, modify or disassemble the battery.**

- **Do not connect the battery's positive and negative terminals.**

It may cause overheating, electric shock or fire.

- **When carrying or storing the battery, always place it in the case and protect its terminals. Do not carry or store the battery together with precious metal items such as key rings.**

It may cause overheating, electric shock or fire.

- **Do not connect the battery directly to a power outlet or car cigarette lighter.**

- **Do not use or leave the battery in a hot location such as in direct sunlight, inside a vehicle on a hot day, or near a room heater.**

It may cause fire, burns or injuries from leaking, overheating or ruptures.

WARNING

- **Do not touch or hold the battery with wet hands.**

It may cause electric shock or failure.

- **Do not use a battery with a scratched or damaged case.**

Safety precautions

It may cause ruptures or overheating.

- **Do not insert the battery with its positive/negative terminals in the opposite direction.**

It may cause leaking, overheating, combustion or ruptures.

- Do not use a battery with a torn casing seal (insulating covering).
- Always remove the battery when the voice recorder will not be used for an long period.
- When disposing used batteries, insulate their contacts with tape and discard them as general waste in the manner prescribed by the local authority.
- Remove the battery from the voice recorder as soon as the battery becomes unusable. It may cause leakage.
- **Battery fluid in the eyes may cause blindness. If battery fluid gets in eyes, do not rub the eyes. Instead, rinse them thoroughly with tap water or other clean water right away. Go to doctor immediately.**
- **Do not attempt to recharge alkaline, lithium or any other non-rechargeable batteries.**
- **Keep the battery out of the reach of infants and children.**

The battery could be swallowed by infants and children. Swallowing may lead to burns, perforation of soft tissue, and death. Severe burns can occur within 2 h of ingestion. If swallowed, go to doctor immediately.

- **If you notice abnormal sound, heat, burning odor, or smoke from the voice recorder during use:**

- ① Remove the battery immediately, taking care not to injure yourself.
- ② Have the voice recorder repaired by your place of purchase or service center. Continued use may result in fire or burns.

- **Do not submerge the battery in freshwater or saltwater, or allow its terminals to become wet.**
- **Discontinue use of the battery if it develops a problem such as leaking, discoloration or deformation.**
- **Stop charging the rechargeable battery if charging has not finished after the specified amount of charging time.**
- **Battery fluid on clothing or skin may damage the skin, so rinse the battery fluid off right away with tap water or other clean water.**



CAUTION

- **Do not mix charged and discharged batteries.**
- **Do not mix batteries of different capacities, types, or makes.**
- **Charge each pair of batteries together.**
- **Do not throw the battery around, or subject it to strong shocks.**

Safety precautions

6

Other information

- **Always charge the rechargeable battery before use when using it for the first time or if it has not been used for a long time.**
- **Rechargeable batteries have a limited life. When the recorders operating time becomes shorter after recharging under the specified condition, please consider that battery is expired and replace it with a new one.**
- **There is a risk of explosion if the batteries are replaced with batteries of the incorrect type. When disposing used batteries follow the instructions. Please recycle batteries to help save our planet's resources. When you throw away dead batteries, be sure to cover their terminals and always observe local laws and regulations.**

Disposing the rechargeable battery

- **Recycling batteries helps saving resources. When disposing a used battery, always cover its terminals and observe local laws and regulations.**

Operating precautions

- Do not leave the voice recorder in hot or humid locations such as in direct sunlight inside a vehicle, or on a beach during summer.
- Do not store the voice recorder in humid or dusty locations.

- If the voice recorder becomes wet or damp, wipe off the moisture right away with a dry cloth. Contact with salt water should be particularly avoided.
- Do not place the voice recorder on top of or near a TV, refrigerator or other electrical appliance.
- Prevent sand or mud from getting on the voice recorder. It may cause product not to be repairable.
- Do not subject the voice recorder to intense vibrations or shocks.
- Do not use the voice recorder in humid locations.
- Placing a magnetic card (such as a bank cash card) near the speaker or earphones may cause errors in the data stored on the magnetic card.
- Noise may be heard when the voice recorder is placed near an electric lamp line, fluorescent light or a mobile phone during recording or playback.

<Data loss precautions>

- Recorded content in the internal memory and microSD card may be destroyed or lost due to reasons such as operating errors, device failure or repair.
- Also, when content is saved in the memory for long period of time or is used repeatedly, operations such as writing to, reading from, or erasing of contents may not be possible.
- Making a backup of important recorded information and saving it on a PC's hard disk or other recording media is recommended.
- Note that we will assume no liability for damages or lost earnings resulting from recorded data damage or loss, regardless of the nature or cause thereof.

Safety precautions

<Recorded file precautions>

- Note that we will not be held liable for recorded files being erased or becoming unplayable due to voice recorder or PC failure.
- Recording of copyrighted material is permitted when the recording is for your personal use only. Any other type of use without the permission of the copyright owner is prohibited by copyright law.

<Voice recorder and microSD cards disposal precautions>

- Even when formatting (☞ P.70) or erasing (☞ P.48) are performed, only the file management information of the internal memory and/or microSD card is updated and the recorded data is not completely erased. When disposing of the voice recorder or a microSD card, be sure to destroy it, format and record silence until the recording time runs out, or perform a similar operation in order to prevent the leakage of personal information.

<INSTRUCTIONS>

- As the main plug of AC adaptor is used to disconnect the AC adaptor from the mains, connect it to an easily accessible AC outlet.

Specifications

General items

■ Recording formats

MP3 format

Linear PCM format

■ Sampling frequency

MP3 format

128 kbps	44.1 kHz
64 kbps mono	44.1 kHz
8 kbps mono	11.025 kHz

Linear PCM format

22.05 kHz/16 bits mono	22.05 kHz
------------------------	-----------

■ Maximum working output

250 mW (8 Ω speaker)

■ Maximum headphone output

≤ 150 mV (conforms to EN 50332-2)

■ Recording media*

Internal NAND flash memory

WS-883 model: 8 GB

WS-882 model: 4 GB

microSD card

(Supports card capacities ranging from 2 to 32 GB.)

* Some recording media memory capacity is used as a management area, so the actual usable capacity will always be slightly less than the displayed capacity.

■ Speaker

Built-in 20 mm diameter round dynamic speaker

■ Microphone jack

3.5 mm diameter; Impedance: 2 kΩ

■ Earphone jack

3.5 mm diameter; Impedance: 8 Ω or more

■ Power source

Standard voltage: 3 V

Battery: Two AAA dry cell batteries (model LR03), or two nickel-metal hydride rechargeable batteries

External power supply: USB-connection AC adapter (model F-5AC-1/F-5AC-2; 5 VDC)

■ External dimensions

111.5 × 39 × 18 mm

(Not including largest projection)

■ Weight

77 g (including battery)

■ Operating environment (Temperature)

0 to 42°C (32 to 107.6°F) (operating)

Frequency response

■ When recording from microphone jack

MP3 format

128 kbps	40 Hz to 17 kHz
64 kbps mono	40 Hz to 15 kHz
8 kbps mono	40 Hz to 3.5 kHz

Linear PCM format

22.05 kHz/16 bits mono	40 Hz to 11 kHz
------------------------	-----------------

■ When recording with built-in microphone

70 Hz to 17 kHz (frequency response upper limit is set by recording mode during MP3-format recording)

■ During playback

30 Hz to 20 kHz (However, the upper and lower limits of the frequency characteristic depend on each recording format)

Specifications

Battery life

The figures below are guideline values.

■ Alkaline dry cell battery

Recording mode		When recording with built-in microphone	During speaker playback	During earphone playback
MP3 format	128 kbps	41 hours (approx.)	15 hours (approx.)	70 hours (approx.)
	64 kbps mono	48 hours (approx.)	15 hours (approx.)	73 hours (approx.)
	8 kbps mono	110 hours (approx.)	24 hours (approx.)	92 hours (approx.)
Linear PCM format	22.05 kHz/16 bits mono	53 hours (approx.)	15 hours (approx.)	73 hours (approx.)

■ Nickel-metal hydride rechargeable battery

Recording mode		When recording with built-in microphone	During speaker playback	During earphone playback
MP3 format	128 kbps	30 hours (approx.)	11 hours (approx.)	49 hours (approx.)
	64 kbps mono	31 hours (approx.)	11 hours (approx.)	53 hours (approx.)
	8 kbps mono	68 hours (approx.)	16 hours (approx.)	64 hours (approx.)
Linear PCM format	22.05 kHz/16 bits mono	32 hours (approx.)	11 hours (approx.)	53 hours (approx.)

NOTE

- The figures given here for battery life are the results of in-house testing (When [LED] is set to [Off]). Actual battery life figures will vary greatly according to the battery used and usage conditions (Changing the playback speed, or using the [Noise Cancel] and [Voice Balancer] functions may affect the battery life).
- Battery life will be shorter when using a nickel-metal hydride rechargeable battery that has been used repeatedly.
- Battery life will be shorter when using a microSD card.

Specifications

Recording time

The figures below are guideline values.

Recording media		MP3 format			Linear PCM format
		128 kbps	64 kbps mono	8 kbps mono	22.05 kHz/16 bits mono
Internal memory	WS-883 (8 GB)	130 hours (approx.)	260 hours (approx.)	2080 hours (approx.)	47 hours 15 minutes (approx.)
	WS-882 (4 GB)	65 hours (approx.)	130 hours (approx.)	1040 hours (approx.)	23 hours 40 minutes (approx.)
microSD card	32 GB	530 hours (approx.)	1060 hours (approx.)	8480 hours (approx.)	191 hours 45 minutes (approx.)
	16 GB	264 hours (approx.)	525 hours (approx.)	4220 hours (approx.)	95 hours 50 minutes (approx.)
	8 GB	132 hours (approx.)	264 hours (approx.)	2110 hours (approx.)	47 hours 50 minutes (approx.)

NOTE

- Actually available recording times may be shorter than the figures shown here when making short recordings repeatedly (Equipment displays of available/elapsed recording times should be considered guideline values).
- Available recording time will also vary due to differences in the available memory capacity of different microSD cards.

Specifications

Maximum recording time per file

- The maximum file size is limited to approximately 2 GB in linear PCM (WAV) format, and approximately 4 GB in MP3 format.
- Regardless of the amount of remaining memory, the maximum recording time per file is restricted to the following values:

Recording mode		Recording time
MP3 format	128 kbps	74 hours 30 minutes (approx.)
	64 kbps mono	149 hours (approx.)
	8 kbps mono	1193 hours (approx.)
Linear PCM format	22.05 kHz/16 bits mono	12 hours (approx.)

Note that voice recorder specifications and appearance are subject to change without prior notice for performance improvements or other upgrading.

date of issue 2023.03.



<https://om-digitalsolutions.com/>