

Acer LCD Monitor

User Guide

Copyright © 2021. Acer Incorporated.
All Rights Reserved.

Acer LCD Monitor User Guide
Original Issue: 08/2021

Changes may be made periodically to the information in this publication without obligation to notify any person of such revisions or changes. Such changes will be incorporated in new editions of this manual or supplementary documents and publications. This company makes no representations or warranties, either expressed or implied, with respect to the contents hereof and specifically disclaims the implied warranties of merchantability or fitness for a particular purpose.

Record the model number, serial number, purchase date and place of purchase information in the space provided below. The serial number and model number are recorded on the label affixed to your computer. All correspondence concerning your unit should include the serial number, model number and purchase information.

No part of this publication may be reproduced, stored in a retrieval system, or transmitted, in any form or by any means, electronically, mechanically, by photocopy, recording or otherwise, without the prior written permission of Acer Incorporated.

Acer LCD Monitor User Guide

Model number: _____

Serial number: _____

Date of purchase: _____

Place of purchase: _____

Acer and the Acer logo are registered trademarks of Acer Incorporated. Other companies' product names or trademarks are used herein for identification purposes only and belong to their respective companies.

Information for your safety and comfort

Safety instructions

Read these instructions carefully. Keep this document for future reference. Follow all warnings and instructions marked on the product.

Special notes on LCD monitors

The following are normal with the LCD monitor and do not indicate a problem.

- Due to the nature of the fluorescent light, the screen may flicker during initial use. Turn off the power switch and then turn it on again to make sure the flicker disappears.
- You may find slightly uneven brightness on the screen depending on the desktop pattern you use.
- The LCD screen has 99.99% or more effective pixels. It may include blemishes of 0.01% or less such as a missing pixel or pixel lit all the time.
- Due to the nature of the LCD screen, an afterimage of the previous screen may remain after switching the image, when the same image is displayed for hours. In this case, the screen is recovered slowly by changing the image or turning off the power switch for a few hours.

Cleaning your monitor

Please carefully follow these guidelines when cleaning the monitor:

- Always unplug the monitor before cleaning.
- Use a soft cloth to wipe the screen and cabinet front and sides.

Accessibility

Be sure that the power outlet you plug the power cord into is easily accessible and located as close to the equipment operator as possible. When you need to disconnect power from the equipment, be sure to unplug the power cord from the electrical outlet.

Safe listening

To protect your hearing, follow these instructions.

- Gradually increase the volume until you can hear it clearly and comfortably and without distortion.
- After setting the volume level, do not increase it after your ears have adjusted.
- Limit the amount of time listening to music at high volume.
- Avoid turning up the volume to block out noisy surroundings.
- Turn the volume down if you can't hear people speaking near you.

Warnings

- Do not use this product near water.
- Do not place this product on an unstable cart, stand or table. If the product falls, it could be seriously damaged.
- Slots and openings are provided for ventilation to ensure reliable operation of the product and to protect it from overheating. These openings must not be blocked or covered. The openings should never be blocked by placing the product on a bed, sofa, rug or other similar surface. This product should never be placed near or over a radiator or heat register, or in a built-in installation unless proper ventilation is provided.
- Never push objects of any kind into this product through cabinet slots as they may touch dangerous voltage points or short-out parts that could result in a fire or electric shock. Never spill liquid of any kind onto or into the product.
- To avoid damage of internal components and to prevent battery leakage, do not place the product on a vibrating surface.
- Never use it under sporting, exercising, or any vibrating environment which will probably cause unexpected short current or damage internal devices.
- The adapter is only used for this monitor, do not be used for other purposes.

Using electrical power

- This product should be operated from the type of power indicated on the marking label. If you are not sure of the type of power available, consult your dealer or local power company.
- Do not allow anything to rest on the power cord. Do not locate this product where people will walk on the cord.

- If an extension cord is used with this product, make sure that the total ampere rating of the equipment plugged into the extension cord does not exceed the extension cord ampere rating. Also, make sure that the total rating of all products plugged into the wall outlet does not exceed the fuse rating.
- Do not overload a power outlet, strip or receptacle by plugging in too many devices. The overall system load must not exceed 80% of the branch circuit rating. If power strips are used, the load should not exceed 80% of the power strip's input rating.
- This product's power cord is equipped with a three-wire grounded plug. The plug only fits in a grounded power outlet. Make sure the power outlet is properly grounded before inserting the power cord plug. Do not insert the plug into a non-grounded power outlet. Contact your electrician for details.



.....

Warning! The grounding pin is a safety feature. Using a power outlet that is not properly grounded may result in electric shock and/or injury.



.....

Note: The grounding pin also provides good protection from unexpected noise produced by other nearby electrical devices that may interfere with the performance of this product.

- Use the product only with the supplied power supply cord set. If you need to replace the power cord set, make sure that the new power cord meets the following requirements: detachable type, UL listed/CSA certified, type SPT-2, rated 7 A 125 V minimum, VDE approved or its equivalent, 4.6 meters (15 feet) maximum length.

Product servicing

Do not attempt to service this product yourself, as opening or removing covers may expose you to dangerous voltage points or other risks. Refer all servicing to qualified service personnel.

Unplug this product from the wall outlet and refer servicing to qualified service personnel when:

- the power cord or plug is damaged, cut or frayed
- liquid was spilled into the product
- the product was exposed to rain or water
- the product has been dropped or the case has been damaged
- the product exhibits a distinct change in performance, indicating a need for service
- the product does not operate normally after following the operating instructions



Note: Adjust only those controls that are covered by the operating instructions, since improper adjustment of other controls may result in damage and will often require extensive work by a qualified technician to restore the product to normal condition.

Potentially explosive environments

Switch off your device in any area with a potentially explosive atmosphere and obey all signs and instructions. Potentially explosive atmospheres include areas where you would normally be advised to turn off your vehicle engine. Sparks in such areas could cause an explosion or fire resulting in bodily injury or even death. Switch off the device near depots, storage and distribution areas; chemical plants; or where blasting operations are in progress. Areas with a potentially explosive atmosphere are often, but not always, marked. They include below deck on boats, chemical transfer or storage facilities, vehicles using liquefied petroleum gas (such as propane or butane), and areas where the air contains chemicals or particles such as grain, dust or metal powders.

Additional safety information

Your device and its enhancements may contain small parts. Keep them out of the reach of small children.

IT Equipment Recycling Information

Acer is strongly committed to environmental protection and views recycling, in the form of salvaging and disposal of used equipment, as one of the company's top priorities in minimizing the burden placed on the environment.

We at Acer are very conscious of the environmental effects of our business and strive to identify and provide the best working procedures to reduce the environmental impact of our products.

For more information and help when recycling, please go to this website:

<https://www.acer-group.com/sustainability/en/our-products-environment.html>

Visit www.acer-group.com for further information on the features and benefits of our other products.

Disposal instructions



Do not throw this electronic device into the trash when discarding. To minimize pollution and ensure utmost protection of the global environment, please recycle. For more information on the Waste from Electrical and Electronics Equipment (WEEE) regulations, visit <https://www.acer-group.com/sustainability/en/our-products-environment.html>

LCD pixel statement

The LCD unit is produced with high-precision manufacturing techniques. Nevertheless, some pixels may occasionally misfire or appear as black or red dots. This has no effect on the recorded image and does not constitute a malfunction.

This product has been shipped enabled for power management:

- Activate display's Sleep mode within 5 minutes of user inactivity.
- Wake the monitor when it is in Active Off mode, move the mouse or press any keyboard key.

Tips and information for comfortable use

Computer users may complain of eyestrain and headaches after prolonged use. Users are also at risk of physical injury after long hours of working in front of a computer. Long work periods, bad posture, poor work habits, stress, inadequate working conditions, personal health and other factors greatly increase the risk of physical injury.

Incorrect computer usage may lead to carpal tunnel syndrome, tendonitis, tenosynovitis or other musculoskeletal disorders. The following symptoms may appear in the hands, wrists, arms, shoulders, neck or back:

- numbness, or a burning or tingling sensation
- aching, soreness or tenderness
- pain, swelling or throbbing
- stiffness or tightness
- coldness or weakness

If you have these symptoms, or any other recurring or persistent discomfort and/or pain related to computer use, consult a physician immediately and inform your company's health and safety department.

The following section provides tips for more comfortable computer use.

Finding your comfort zone

Find your comfort zone by adjusting the viewing angle of the monitor, using a footrest, or raising your sitting height to achieve maximum comfort. Observe the following tips:

- refrain from staying too long in one fixed posture
- avoid slouching forward and/or leaning backward
- stand up and walk around regularly to remove the strain on your leg muscles

Taking care of your vision

Long viewing hours, wearing incorrect glasses or contact lenses, glare, excessive room lighting, poorly focused screens, very small typefaces and low-contrast displays could stress your eyes. The following sections provide suggestions on how to reduce eyestrain.

Eyes

- It is recommended to rest your eyes for 10 minutes every 40 minutes.
- Give your eyes regular breaks by looking away from the monitor and focusing on a distant point.
- Blink frequently to keep your eyes from drying out.

Display

- Keep your display clean.
- Keep your head at a higher level than the top edge of the display so your eyes point downward when looking at the middle of the display.
- Adjust the display brightness and/or contrast to a comfortable level for enhanced text readability and graphics clarity.
- Eliminate glare and reflections by:
 - placing your display in such a way that the side faces the window or any light source
 - minimizing room light by using drapes, shades or blinds
 - using a task light
 - changing the display's viewing angle
 - using a glare-reduction filter
 - using a display visor, such as a piece of cardboard extended from the display's top front edge
- Avoid adjusting your display to an awkward viewing angle.
- Avoid looking at bright light sources, such as open windows, for extended periods of time.

Developing good work habits

Develop the following work habits to make your computer use more relaxing and productive:

- Take short breaks regularly and often.
- Perform some stretching exercises.
- Breathe fresh air as often as possible.
- Exercise regularly and maintain a healthy body.



Acer Incorporated
8F, 88, Sec. 1, Xintai 5th Rd., Xizhi
New Taipei City 221, Taiwan

Declaration of Conformity

We,

Acer Incorporated
8F, 88, Sec. 1, Xintai 5th Rd., Xizhi, New Taipei City 221, Taiwan

And,

Acer Italy s.r.l.
Viale delle Industrie 1/A, 20020 Arese (MI), Italy
Tel: +39-02-939-921 ,Fax: +39-02 9399-2913
www.acer.it

Product:	LCD Monitor
Trade Name:	Acer
Model Number:	XR383CUR
SKU Number:	XR383CUR xxxxxx;
	("x" = 0~9, a~z, A~Z, or blank)

We, Acer Incorporated, hereby declare under our sole responsibility that the product described above is in conformity with the relevant Union harmonization legislations as below Directive and following harmonized standards and/or other relevant standards have been applied:

EMC Directive: 2014/30/EU

<input checked="" type="checkbox"/> EN 55032:2012/AC:2013 Class B	<input checked="" type="checkbox"/> EN 55035:2017
<input checked="" type="checkbox"/> EN 55032:2015+AC 2016 Class B	<input checked="" type="checkbox"/> EN 61000-3-3:2013
<input checked="" type="checkbox"/> EN 61000-3-2:2014 Class D	

LVD Directive: 2014/35/EU

<input checked="" type="checkbox"/> EN 62368-1: 2014+A11:2017

RoHS Directive: 2011/65/EU

<input checked="" type="checkbox"/> EN 50581:2012

ErP Directive: 2009/125/EC

<input checked="" type="checkbox"/> Regulation (EU) 2019/2021;EN50564:2011;EN62087
--

Year to begin affixing CE marking: 2021.

RU Jan / Sr. Manager
Acer Incorporated (Taipei, Taiwan)

Aug,30,2021

Date

acer

Acer America Corporation
333 West San Carlos St., San Jose
Suite 1500
CA 95110, U. S. A.
Tel : 254-298-4000
Fax : 254-298-4147
www.acer.com



Federal Communications Commission Supplier's Declaration of Conformity

This device complies with Part 15 of the FCC Rules. Operation is subject to the following two conditions: (1) this device may not cause harmful interference, and (2) this device must accept any interference received, including interference that may cause undesired operation.

The following local Manufacturer /Importer is responsible for this declaration:

Product:	LCD Monitor
Model Number:	XR383CUR
SKU Number:	XR383CUR xxxxxx ("x" = 0~9, a ~ z, A ~ Z, or blank)
Name of Responsible Party:	Acer America Corporation
Address of Responsible Party:	333 West San Carlos St. Suite 1500 San Jose, CA 95110 U. S. A.
Contact Person:	Acer Representative
Phone No.:	254-298-4000
Fax No.:	254-298-4147

Contents

Information for your safety and comfort	3
Safety instructions	3
Special notes on LCD monitors	3
Cleaning your monitor	3
Accessibility	4
Safe listening	4
Warnings	4
Using electrical power	4
Product servicing	5
Potentially explosive environments	6
Additional safety information	6
IT Equipment Recycling Information	6
Disposal instructions	6
LCD pixel statement	7
Tips and information for comfortable use	7
Finding your comfort zone	7
Taking care of your vision	8
Developing good work habits	8
Federal Communications Commission	10
Supplier's Declaration of Conformity	10
Unpacking	12
Attaching the Base	13
Connecting the adapter and AC Power cord	15
Power saving	15
Display Data Channel (DDC)	16
20-pin color display signal cable	16
19-pin color display signal cable	17
Standard timing table	18
Installation	19
Troubleshooting	31
HDMI/DP Mode (Optional)	31

Unpacking

Please check that the following items are present when you unpack the box, and save the packing materials in case you need to ship or transport the monitor in the future.

LCD monitor

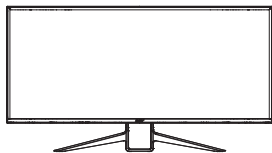

Quick start guide



AC Power cord

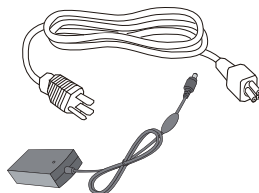

DP Cable
(Optional)

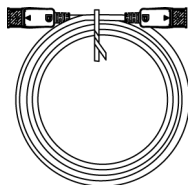

HDMI cable
(Optional)

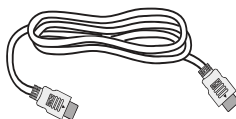

USB cable
(Optional)

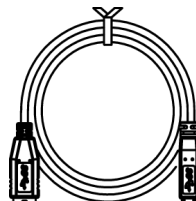

Type C-C cable (Optional)

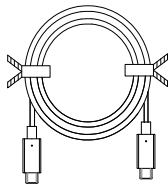

- **Height Adjustment**

After pressing the top of the monitor then you can adjust the height of the monitor.

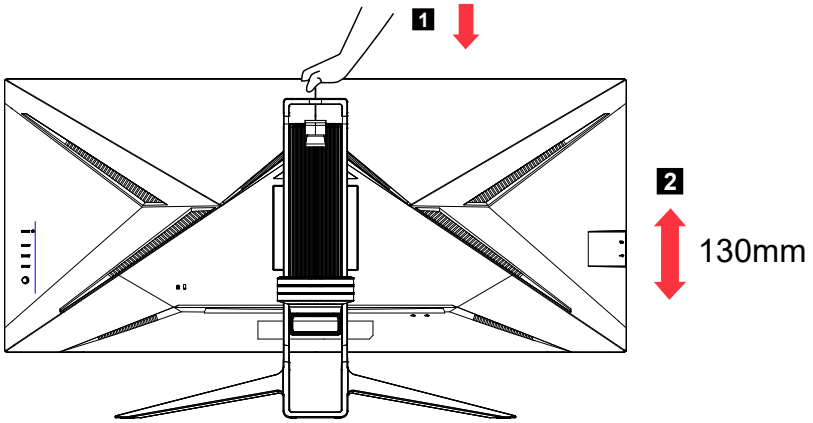

- **Tilt**

Please see the illustration below for an example of the tilt range.

Only at the highest point can 35 degrees of recline be offered for the angle of elevation.

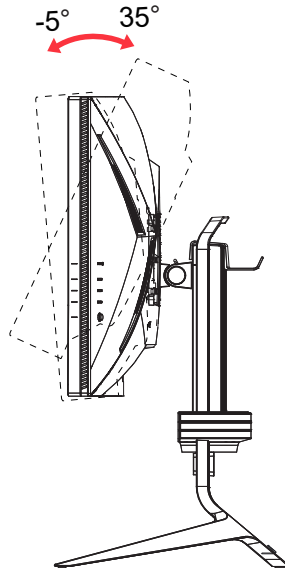

- **Swivel**

With the built-in pedestal, you can swivel the monitor for the most comfortable viewing angle.

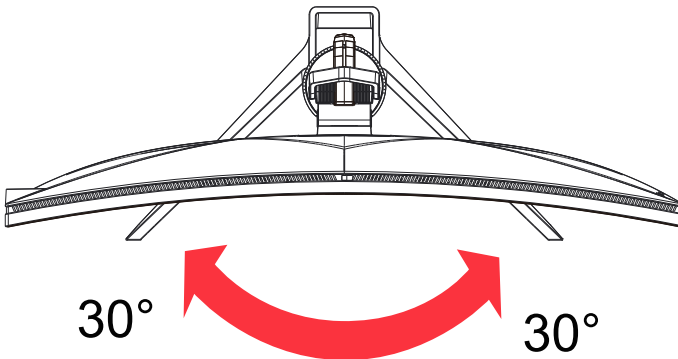

Connecting the adapter and AC Power cord

- Check first to make sure that the power cord you use is the correct type required for your area.
- The monitor has a universal power supply that allows operation in either 100/120 V AC or 220/240 V AC voltage area. No user-adjustment is required.
- Plug one end of the AC power cord to the Adapter, and plug the other end into an AC outlet.
- For units using 120 V AC:
Use a UL-listed cord set, type SVT wire and plug rated 10 A/125 V.
- For units using 220/240 V AC:
Use a cord set consisting of H05VV-F cord and plug rated 10 A/250 V. The cord set should have the appropriate safety approvals for the country in which the equipment will be installed.

Power saving

The monitor will be driven into "Power Saving" mode by the control signal from the display controller, as indicated by the amber-color power LED.

State	LED Light
ON	Blue
Power Saving Mode	Amber

The power saving states will be kept until a control signal has been detected or the keyboard or mouse is activated. The recovery time from Active OFF state back to ON state is around 3 seconds.

Display Data Channel (DDC)

To make installation easier, so long as your system supports the DDC protocol, the monitor is able to plug-and-play. The DDC is a communication protocol through which the monitor automatically informs the host system about its capabilities; for example, supported resolutions and corresponding timing. The monitor supports the DDC2B standard.

20-pin color display signal cable

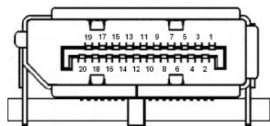

PIN No.	Description	PIN No.	Description
1	ML_Lane 0+	2	GND
3	ML_Lane 0-	4	ML_Lane 1+
5	GND	6	ML_Lane 1-
7	ML_Lane 2+	8	GND
9	ML_Lane 2-	10	ML_Lane 3+
11	GND	12	ML_Lane 3-
13	KONFIG1	14	CONFIG2
15	AUX CH+	16	GND
17	AUX CH-	18	Hot Plug
19	Return	20	DP_PWR

19-pin color display signal cable

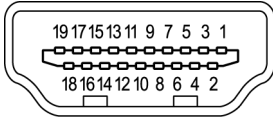

PIN No.	Description	PIN No.	Description
1	TMDS Data2+	2	TMDS Data2 Shield
3	TMDS Data2-	4	TMDS Data1+
5	TMDS Data1 Shield	6	TMDS Data1-
7	TMDS Data0+	8	TMDS Data0 Shield
9	TMDS Data0-	10	TMDS Clock+
11	TMDS Clock Shield	12	TMDS Clock-
13	CEC	14	Reserved (N.C. on device)
15	SCL	16	SDA
17	DDC/CEC Ground	18	+5V Power
19	Hot Plug Detect		

Standard timing table

VESA MODE			
MODE	Resolution		
1	VGA	640x480	60Hz
		640x480	72Hz
		640x480	75Hz
2	SVGA	800x600	56Hz
		800x600	60Hz
		800x600	72Hz
		800x600	75Hz
3	XGA	1024x768	60Hz
		1024x768	70Hz
		1024 X 768	75Hz
		1024 X 768	120Hz
		1152x864	75Hz
		1280x960	60Hz
		1280x720	60Hz
4	SXGA	1280x1024	60Hz
		1280 X 1024	75Hz
5	WXGA+	1440x900	60Hz
6	WSXGA+	1680x1050	60Hz
7	UXGA	1600X1200	60Hz
8	WUXGA	1920x1080	60Hz
		1920x1080	60Hz
		1920 x1080P	120Hz
9	QHD	2560*1440	120Hz
10	WQHD	3840*1600	60Hz
		3840*1600	120Hz
		3840*1600	144Hz (Recommend Resolution)
		3840*1600	165Hz (OVERCLOCK)

* Transmitting the WQHD 144/165Hz signal via one HDMI 2.1/ DP 1.4 port requires DSC (Display Stream Compression) functionality.

* XR383CUR can be overclocked to a higher refresh rate than advertised by the panel specification. This function can be used via the system control panel to set the maximum refresh rate.

Installation

1. Turn off your computer and unplug your computer's power cord.
2. Connect the signal cable to the HDMI (optional) and /or DP (optional) input socket of the monitor, and the HDMI (optional) and /or DP (optional) output socket of the graphics card on the computer.
3. USB Type C Cable (Optional, USB Type C input models only) Connect one end of the USB type C cable (optional) to your computer and connect the other end to your electric devices.
4. Connect the USB Cable(Optional)
Connect the USB 3.0 cable to port for fast charge.
Connect the USB 3.0/USB-B cable to port.
5. Insert the monitor power cable into the power port at the back of the monitor.
6. Plug the power cords of your computer and your monitor into a nearby electrical outlet.
7. Connecting HDMI/DP+USB-B to computer 1 and USB-C to computer 2 when Control up to 2 computers from a single set of keyboard and mouse connected to the monitor.

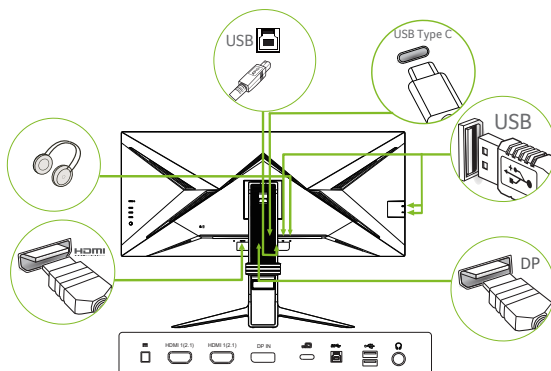

Note:



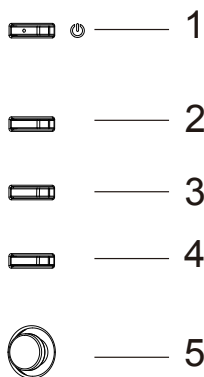

Audio output is only for audio output model. Please check user manual for more instruction.

If your computer USB-C do not have DP-Alt, pls connect HDMI/DP+USB-B to computer 1 and HDMI/DP+USB-C to computer 2.

User Controls



External controls

1	Power button	Turns the monitor on/off. Blue indicates power on. Amber indicates standby/ power saving mode/OSD locked.
2	Function key 	<ol style="list-style-type: none"> Press to view Main page. Press again to enter hotkey1 function. When the Function Menu is active, press this key to view the basic information for your monitor and current input or reset the custom color settings to the factory defaults.
3	Function key 	<ol style="list-style-type: none"> Press to view Main page. Press again to enter hotkey2 function. When the Function Menu is active, press this button to select select scenario mode or game mode.
4	Function key 	<ol style="list-style-type: none"> Press to view Main page. Press again to enter Input select function. When the Function Menu is active, this button will quit the OSD.
5	Function key 	<ol style="list-style-type: none"> Press to view Main page. Press again to enter next function in the Function Menu. The single toggle button on the backside of the Display bezel operates like a joystick. To move the cursor, simply toggle the button in four directions. Press the button to select desired option. Red indicates operable. Dark gray indicates inoperable.

AMD FreeSync Premium Pro:

It can allow a AMD FreeSync Premium Pro supported graphics source to dynamically adjust display refresh rate based on typical content frame rates for power efficient, virtually stutter free and low-latency display update.

KVM switch:

The built-in KVM switch allows you to control up to 2 computers from a single set of keyboard and mouse connected to the monitor.

Using the Shortcut Menu



Note: The following content is for general reference only. Actual product specifications may vary.

The OSD (On Screen Display) can be used to adjust the settings of your LCD monitor. Press the MENU key to open the OSD. You can use the OSD to adjust the picture quality, OSD position and general settings. For advanced settings, please refer to following page:

Main page

	<ol style="list-style-type: none"> Hot Key1 (Default is Modes) Modes, Brightness, Volume, Gamma, Contrast, Blue Light, Over Drive, VRB, PIP/BPB Hot Key2 (Default is Brightness) Modes, Brightness, Volume, Gamma, Contrast, Blue Light, Over Drive, VRB, PIP/BPB Input Switch Hot Key Main Menu Hot Key.
--	--

Hot key1 (Default: Standard mode)

To choose game mode (G1, G2, G3) which user-defined profile to use or scenario mode (User, Standard, ECO, Graphics, Movie)

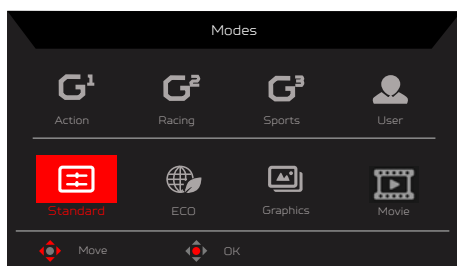

Hot key2 (Default: Brightness)

Open the Brightness control and select your preferred brightness setting. When you are done, press OK button to quit current page and store.

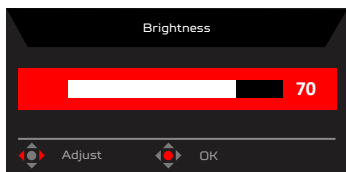





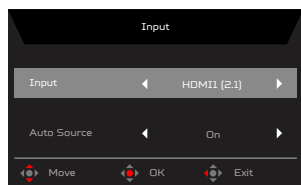

Input Switch Hot Key

Open the Input control and select HDMI1(2.1), HDMI2(2.1), DP, DP ALT or Auto Source. When you are done, press the left joystick to exit current page or press OK button into function control



Main Menu Hot Key

1. Press the MENU key to open the OSD.
2. Toggle the joystick  to the up  or down  to select Picture from the OSD. The toggle to the right to the function you wish to adjust and press the joystick to enter it.
3. Toggle the joystick  to the left  or right  to adjust the sliding scales or choose function.

Information Hot Key   : Show Monitor Information and Reset control function.

Modes Hot Key   : To change Modes Hot Key menu.

Exit Hot Key   : To exit current page and store.

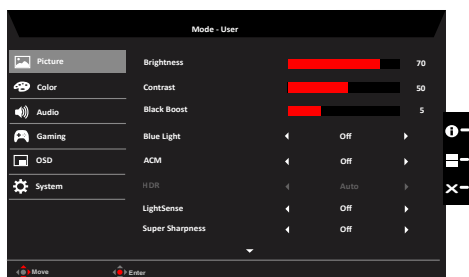

Main Menu

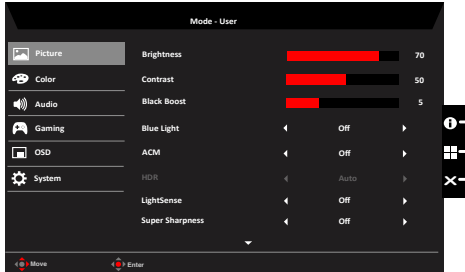

1. Press the MENU key to open the OSD.
2. Toggle the joystick to the up or down to select Picture from the OSD. Then toggle to the right to the function you wish to adjust and press the joystick to enter it.
3. Toggle to the left or right to adjust the sliding scales or choose function.
4. The Picture menu can be used to adjust the Brightness, Contrast, Black Boost, Blue Light, ACM, HDR, LightSense, Super Sharpness, Max Brightness.
5. Brightness: Adjust the brightness from 0 to 100.



Note: Adjusts the balance between light and dark shades.
Default Brightness will vary depending on the sales area.

6. Contrast: Adjust the contrast from 0 to 100.



Note: Sets the degree of difference between light and dark areas.

7. Black Boost: Adjust the black level from 0 to 10. Enhances shadows by increasing the brightness without changing lighter shades.



Note: If the image is very bright or has few shadow areas, adjusting this setting may not result in any noticeable changes to the image.

8. Blue Light: Filters out blue light to protect your eyes by adjusting how much blue light is shown --- Off, 80%, 70%, 60%, or 50%.



Note: Higher values allow more blue light through. For the best protection select a lower value. When "Blue Light" is on, Brightness & Contrast will show each level of "Blue Light" value.

9. ACM: Turn ACM on or off.



Note: Set to "On", will be based on the current screen to dynamic contrast adjustment.

10. HDR: MNT will automatically determine whether the signal source is HDR, Ex PC HDR, if it is in HDR format, the HDR function of Monitor can be turned on and the effect of Auto / HDR-600 can be selected.



Note:

1. When the signal source is HDR, Color Page, Modes and Color Space will be grayed out and can't be operated.
 2. When HDR = Auto or HDR-600, some parameters :(ACM, Gamma, Contrast, Blue Light, Black Boost...) functions is gray out and disable, and if you change other adjustable parameters, the "Modes" will not jump to "User" Mode.
11. LightSense: Light Sensor can choose: (Off, Level 1, Level 2 and Level 3), Off is default, Level 3 brightness automatically adjust the maximum range, Level 2 brightness automatically adjust the range is moderate, Level 1 brightness automatically adjust the minimum range.



Note: The following conditions the Light Sensor auto gray out and unavailable

After the following functions are enabled, the LightSense is grayed out and disabled.					
PC Content	HDR				
Color Space	sRGB	Rec.709	EBU	DCI	SMPTE-C
After the LightSense is started, the following functions will be grayed out and disabled.					
Function	ACM	Brightness	Blue Light	VRB	

12. Super Sharpness: Turn the Super Sharpness On or Off. Super Sharpness technology can simulate high-resolution images by boosting the pixel density of the original source to make images sharper and clearer.
13. Max Brightness: The default is Off, select On to compensate for higher brightness.

Color

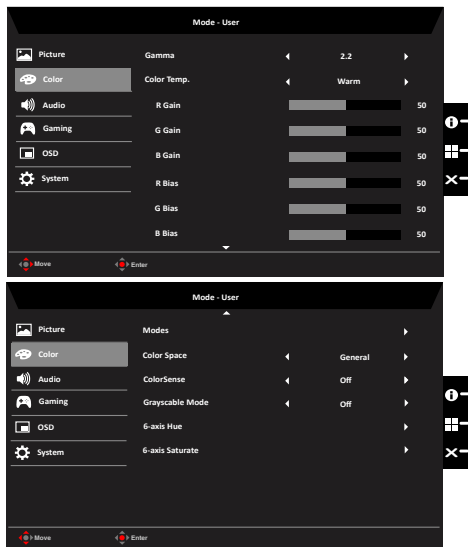

1. Press the MENU key to open the OSD.
2. Toggle the joystick to the up or down to select Color from the OSD. Then toggle to the right to the function you wish to adjust and press the joystick to enter it.
3. Toggle to the left or right to adjust the sliding scales or choose function.
4. The Color menu can be used to adjust the Gamma, Color Temp, Modes, Color Space, ColorSense, GrayScaler Mode, 6-Axis Hue, 6-Axis Saturate.
5. Gamma mode allows you to adjust the luminance tone. The default value is 2.2 (standard value for Windows). Adjust range are 1.8, 2.0, 2.2, 2.4 or 2.6
6. Color temperature: You can choose color temperature as warm, Normal, cool, Blue light or User.
 - Warm: Increases the color temperature. The screen appears warmer with a red/yellow tint. This is the default preset mode.
 - Normal: Loads the monitor's normal color settings.
 - Cool: Decreases the color temperature. The screen appears cooler with a blue tint.
 - Blue light: Decreases the level of blue light emitted from the screen to make viewing more comfortable for your eyes.
 - User: Allows you to manually adjust the color settings.
7. Modes: Open Modes Hot Key Menu. Detail rules please refer Modes Spec.

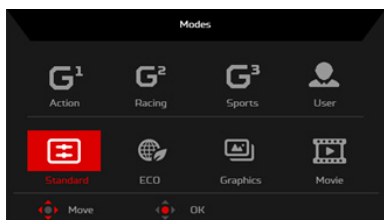

Action: For better color matching representation with the Action game or movie,

Users can modify some parameters and save them by themselves.

Racing: For better color matching representation with the Racing game or movie,
Users can modify some parameters and save them by themselves.

Sports: For better color matching representation with the Sports game or movie,
Users can modify some parameters and save them by themselves.

User: Applies a combination of picture settings defined by users.

Standard: For basic PC application (Default Setting).

ECO: For saving electricity with low power consumption by providing minimum brightness for all running programs.

Graphics: For better color matching representation with the graphics.

Movie: For better color matching representation with the movie. PC content is HDR, The Modes is gray out and unavailable.



Note: PC content is HDR, The Modes is gray out and unavailable.

8. Color Space: You can choose sRGB, Rec.709, EBU, DCI, SMPTE-C and General.



Note: Color Space = sRGB ~ General, The Modes = Standard.

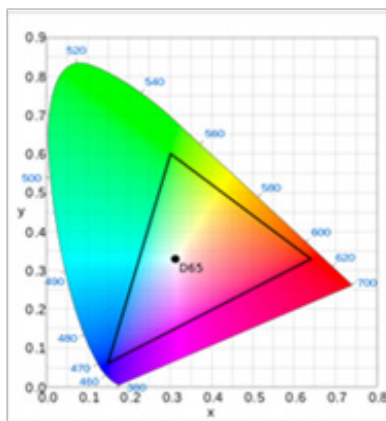
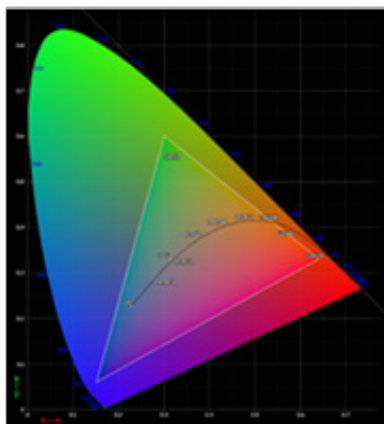

- CIE 1931 positive and negative error of 0.05.
 - PC Content is HDR, Modes is gray out and unavailable.
 - N/A means to follow the current parameter value (Ex. Standard parameter value).
 - Modes = (Action/Racing/Sports/User/Standard/ECO/Graphics/Movie) is selected; the color space is auto set to "General".
 - Color Space = (sRGB/Rec.709/EBU/DCI/SMPTE-C), If to adjust the parameter the Modes will not jump to User mode, but the Color Space = "General" except.
 - Color Space = (sRGB/Rec.709/EBU/DCI/SMPTE-C), Grayscale Mode is gray out and unavailable.
 - Color Space = (sRGB/Rec.709/EBU/DCI/SMPTE-C), 6-Axis Hue & Saturate is gray out and unavailable.
 - Color Space = (sRGB/Rec.709/EBU/DCI/SMPTE-C), (Light & Color) Sensor are gray out and unavailable.
9. ColorSense: Automatically adjust color temperature smoothly.



Note:

- PC is HDR, ColorSense is gray out and unavailable.
- ColorSense is On, Factory Menu can check the CT (Color Temp) Value.
- Color Space = (sRGB/Rec.709/EBU/DCI/SMPTE-C), does not support the ColorSense.
- ColorSense is on, the (Contrast, Color Temp, Low Blue Light, 6 axis Hue, 6 axis Saturate, Grayscale Mode) functions are gray out and unavailable.
- The following conditions the ColorSense auto gray out and unavailable:

After the following functions are enabled, the ColorSense is grayed out and disabled.						
PC Content	HDR					
Color Space	sRGB	Rec.709	EBU	DCI	SMPTE-C	
After the ColorSense is started, the following functions will be grayed out and disabled.						
Function	Contrast	Color Temp.	Blue Light	6-axis Hue	6-axis Saturate	Grayscale Mode

10. Grayscale Mode: To choose Grayscale mode.

- On: Color only black and white effect.
- Off: Normal color effect.



11. 6-axis Hue: Adjust the red Hue, Green Hue, Blue Hue, Yellow Hue, Magenta Hue, Cyan hue or Reset.



12. 6-axis Saturate: Adjust the Red Saturate, Green Saturate, Blue Saturate, Yellow Saturate, Magenta Saturate, Cyan Saturate or Reset.

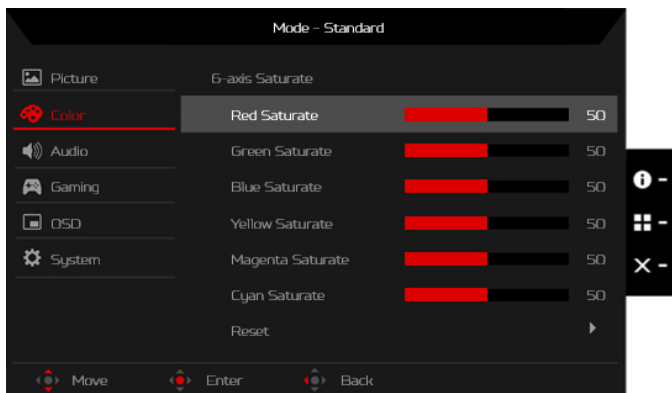

13.

14.

Audio

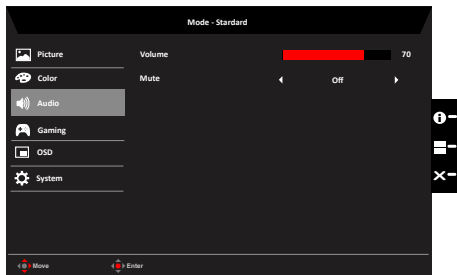

1. Press the MENU key to open the OSD.
2. Toggle the joystick to the up or down to select Audio from the OSD. Then toggle to the right to the function you wish to adjust and press the joystick to enter it.
3. Toggle to the left or right to adjust the sliding scales or choose function.
4. The Audio menu can be used to adjust the Volume, Mute.
5. Volume: Adjust the volume.
6. Mute: To choose mute on/off .

Gaming

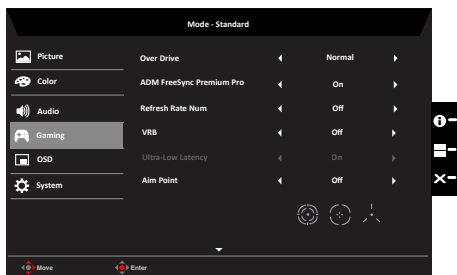

1. Press the MENU key to open the OSD.
2. Toggle the joystick to the up or down to select Gaming from the OSD. Then toggle to the right to the function you wish to adjust and press the joystick to enter it.
3. Toggle to the left or right to control functions.
4. The Gaming menu can be used to adjust the Gamma, AMD FreeSync Premium Pro, Refresh Rate Num, VRB, Ultra-Low Latency, Aim Point.
5. Over Drive: Select Off, Normal or Extreme.
6. AMD FreeSync Premium Pro: To control support AMD FreeSync Premium Pro or not, default is On.

**Note:**

1. If AMD FreeSync Premium Pro is "ON", then the Over Drive selection is set to "Normal" automatically.
2. If AMD FreeSync Premium Pro is "OFF", then the user can set Over Drive to either one of the three settings including: (a) Extreme (b) Normal (c) Off.

7. Refresh rate num: Display the panel's current refresh rate on the screen.



Note: If AMD FreeSync Premium Pro set "On" you can see the V Frequency to changes in the OSD.

8. VRB: To choose whether to support dynamic picture more clean control, default is Off.

**Note:**

- PC is HDR, VRB is gray out and unavailable.
- PIP/PBP mode and LightSense are not support VRB.
- VRB function does not affect the (Logo, Message and Input Icon) brightness.
- VRB set "Normal or Extreme", when to turn on FreeSync, will auto set VRB is "Off".
- VRB set "Normal or Extreme", when to adjustment (Brightness, Blue Light, ACM), will auto set VRB is "Off".
- VRB setting "Normal or Extreme", when detection of Input Timing <75Hz, will auto off the VRB and gray out to disable.
- VRB = (Normal or Extreme), because the IC control dynamic picture is cleaner, so the overall Brightness will be dark, "Extreme" will be darker than "Normal".

9. **Ultra-Low Latency:** Set to On to speed up the processing time of the display switching process.

**Note:**

- Ultra-Low Latency is not support PIP/PBP.
- Ultra-Low Latency is not support video interlace mode.
- Ultra-Low Latency is not supports V-Frequency below 48Hz.
- Ultra-Low Latency is not supports resolutions below 800x600.
- Ultra-Low Latency is support only Wide Mode = Full and gray out.
- AMD FreeSync Premium Pro is "Off", Ultra-Low Latency can control "On" or "Off".
- AMD FreeSync Premium Pro is "On", Ultra-Low Latency is auto setting to "On" and gray out.
- Detail function definition & information, please refer to Acer Ultra-Low Latency specification.

10. Aim point: Show an Aim point on the screen for shooting games.

**Note:**

If hot key meau or main menu is trigger the "Aim point" temporarily closed.

OSD

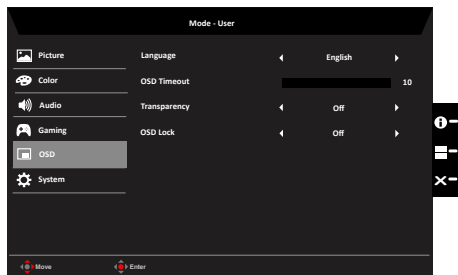

1. Press the MENU key to open the OSD.
2. Toggle the joystick to the up or down to select OSD from the OSD. Then toggle to the right to the function you wish to adjust and press the joystick to enter it.
3. Toggle to the left or right to adjust the sliding scales or choose function.
4. The OSD menu can be used to adjust the Language, OSD Timeout, Transparency, OSD Lock.
5. Language: Set the OSD menu language.
6. OSD timeout: Adjust the delay before turning off the OSD menu.
7. Transparency: Select the transparency when using gaming mode. The transparency can be 0% (OFF), 20%, 40%, 60%, or 80%.
8. OSD Lock: To choose OSD lock on/off.



Note:

OSD Locked:

- Set the OSD Lock to "On" by the OSD option and press "Enter" to execute the All Key lock function.
- The "OSD Locked" message will be displayed in the middle of the screen.
- LED lights will be changed from Blue Light to orange light.
- Press any Key screen to prompt "OSD Locked" message.

OSD Unlocked:

- In normal display condition to press the "Navi Key" in the middle of more than 3 seconds to trigger "OSD Unlock".
- The "OSD Unlock" message will be displayed in the middle of the screen.
- LED lights will be restored to Blue Light.

System

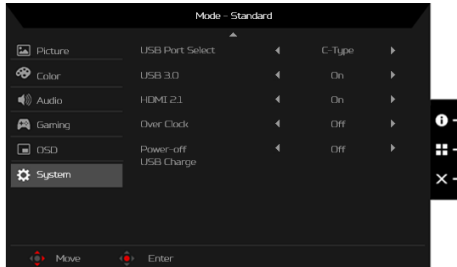
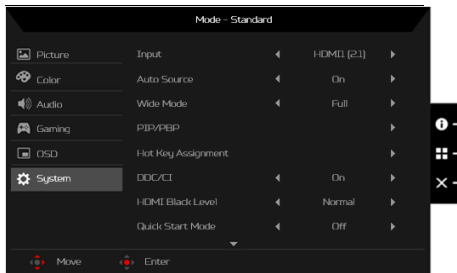

1. Press the MENU key to open the OSD.
2. Toggle the joystick to the up or down to select System from the OSD. Then toggle to the right to the function you wish to adjust and press the joystick to enter it.
3. Toggle to the left or right to control functions.
4. The System menu can be used to adjust the Input, Auto Source, Wide Mode, PIP/PBP, Hot Key Assignment, DDC/CI, HDMI Black Level, Quick Start Mode, USB Port Select, USB 3.0, HDMI2.1, Over Clock, Power-off USB Charge.
5. Input: Select the source from HDMI1(2.1), HDMI2(2.1), DP, DP ALT.
6. Auto Source: The default is "On", which can support auto search for signal source in order.



Note: Surround application must set Auto Source is "Off".

7. Wide mode: You can select which screen aspect you are using. The options are Aspect, Full, 1:1 and 21:9.
8. PIP/PBP:



Top Left



Top Right



Bottom Left



Bottom Right



PBP

PIP/PBP Hot Key

PBP Size: Choose support display the "Full" or "Aspect" effect.

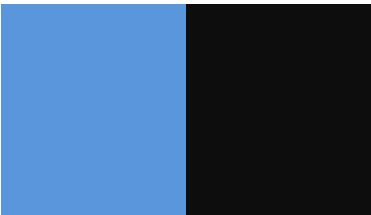

Full

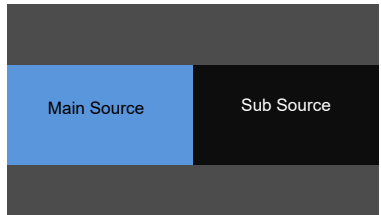

Aspect (Default)



-----**Note:**
PC is HDR, PIP/PBP is gray out and unavailable.

- PIP Large and PIP Small frame is white, PBP no border.
- PIP/PBP Hot Key is enabling, the default PIP window size is "PIP Large".
- PIP/PBP mode = PIP Large or PIP Small, the "Wide Mode" only supports main screen.

- PIP/PBP mode = PIP Large or PIP Small, (ACM/AMD FreeSync Premium Pro/Refresh Rate Num/VRB) functions is gray out and unavailable.
 - PIP/PBP mode = PBP, (ACM/Aim Point/AMD FreeSync Premium Pro/Refresh Rate Num/Wide Mode/VRB) functions is gray out and unavailable.
 - "Over scan" only support main screen on PIP mode, but if PIP/PBP mode = "PBP", both the main and sub screens are not support.
 - PIP/PBP mode only support HDMI 2.0.
9. Hot Key Assignment: Select the function of shortcut key 1 or shortcut key 2 (Modes, Brightness, Volume, Gamma, Contrast, Blue Light, Over Drive, VRB, PIP/PBP)



Note: Hot Key 1 and Hot Key 2 can't repeat the same function.

10. DDC/CI: Allows the monitor settings to be set through the software on the PC.



Note: DDC/CI, short for Display Data Channel/Command Interface, which allows monitor controls to be sent via software.

- DDC/CI, short for Display Data Channel/Command Interface, which allows monitor controls to be sent via software.
 - Widget tools must settings the DDC/CI to "On" can to work properly.
11. HDMI Black level: Select to set HDMI black level.
12. Quick start mode: Select Off or On. Turn on to speed up boot speed.
13. USB Port Select: Select the USB Port from B-Type and C-Type.
14. USB 3.0: Default is "On". It can control determine the USB bandwidth.
- USB 3.0 = "On" is Default.
Support DP ALT (2 Line).
DP ALT Support Max Resolution is 3840x1600-60Hz.
DP ALT Support Max Resolution is 3840x1600-144Hz (W/DSC).
 - USB 3.0 = "Off".
Support DP ALT (4 Line).
DP ALT support 3840x1600-144Hz.
 - Over Clock = "On".
DP ALT (2 Line W/DSC) Support Max Resolution is 3840x1600-165Hz.
DP ALT (4 Line) Support Max Resolution is 3840x1600-165Hz.
15. HDMI2.1: Default is "On", HDMI1 (2.1) & HDMI2 (2.1) can support max resolution 3840x1600-144Hz.
- HDMI 2.1 = "On" is Default.
HDMI Input can support max resolution is 3840x1600-144 Hz.
 - HDMI 2.1 = "Off".
HDMI Input can support max resolution 3840x1600-85 Hz.
 - Over Clock = On & HDMI2.1 = On.

HDMI Input can support max resolution is 3840x1600-165 Hz.

16. Over Clock: Default is "Off", can to controls the Over Clock is On to support HDMI/DP/ DP ALT.

- Over Clock = "Off" is Default.

HDMI1(2.1) & HDMI2(2.1) can support max resolution to 3840x1600-144Hz.

DP can support resolution to 3840x1600-144Hz.

DP ALT can support resolution to 3840-1600-144Hz.

- Over Clock = "On".

HDMI1(2.1) & HDMI2(2.1) can support max resolution to 3840x1600-165Hz.

DP can support resolution to 3840x1600-165Hz.

DP ALT can support resolution to 3840-1600-165Hz.

17. Power-off USB Charge



Note: Power-off USB Charge is set to off by default. Therefore, the sleep mode cannot be resumed under the USB Type-C input. The user needs to change the Power-off USB to on.

Setting the KVM

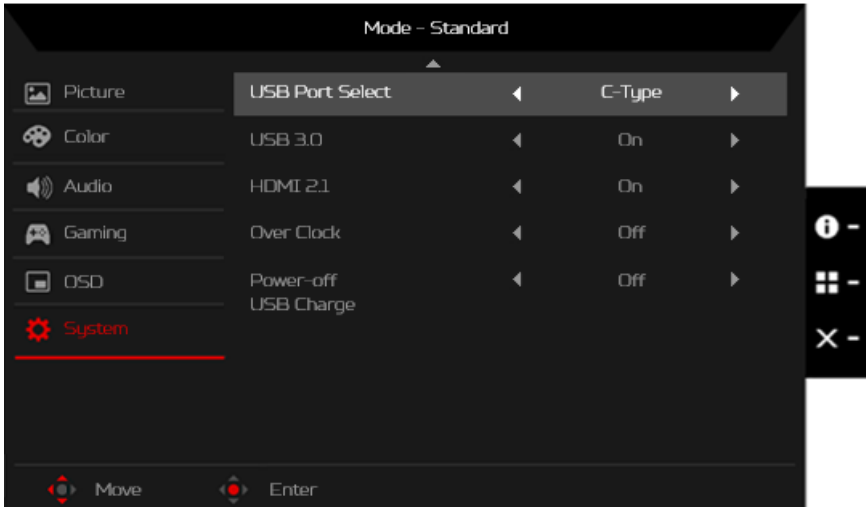

1. You can follow below instruction to set up KVM for your monitor:
 - Connect Type-C/USB-B to your computer
 - Select Type-C/USB-B of USB Port Select in the OSD
 - Suggest setup:

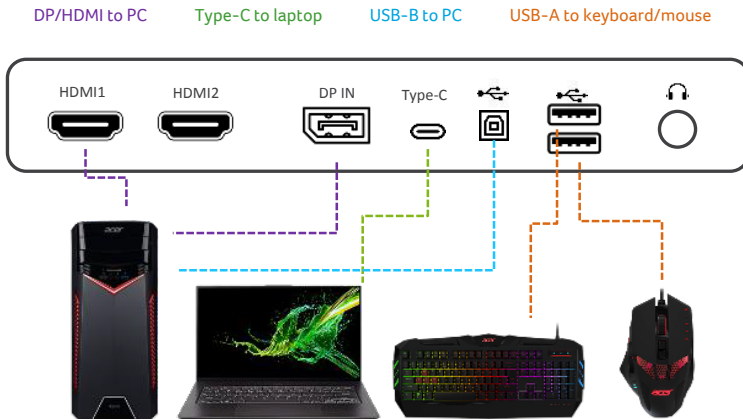

Note:

- When connecting two computers to the monitor, configure the USB settings from the OSD menu to share a single set of keyboard and mouse connected to the monitor between two computers.

Save Setting to...(User mode only)

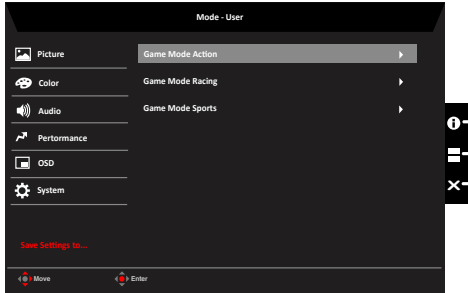

1. Press the MENU key to open the OSD.
2. Toggle the joystick to the up or down to select "Save Setting to..." from the OSD. Then toggle to the right to the function you wish to adjust and press the joystick to enter it.
3. Save Setting to Game mode: There are three user-defined profiles available. When you have decided what settings suit you, save them and system will be able to recall the settings in the future when you turn on gaming mode.

Troubleshooting

Before sending your LCD monitor for servicing, please check the troubleshooting list below to see if you can self-diagnose the problem.

HDMI/DP Mode (Optional)

Problem	LED status	Remedy
No picture visible	Blue	Using the OSD menu, adjust brightness and contrast to maximum or reset to their default setting.
	Off	Check the power switch. Check if the AC power cord is properly connected to the monitor.
	Amber	Check if the video signal cable is properly connected at the back of monitor. Check if the computer system is switched on and in power saving/standby mode. If OSD Lock is On, the LED status set Amber.

Note: Acer monitor is purposed for video and visual display of information obtained from electronic devices.

Regulatory Compliance

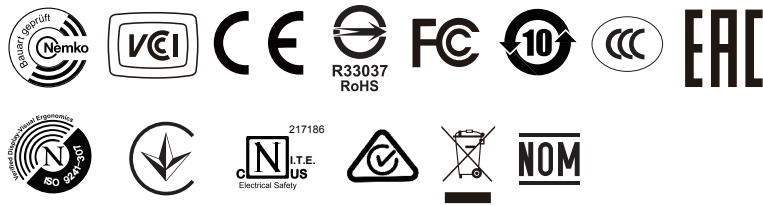

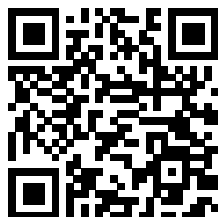

Product Information for EU Energy