

Honeywell

Dolphin™ 6500 Mobile Computer

with Windows® CE 5.0

User's Guide



Disclaimer

Honeywell International Inc. (“HII”) reserves the right to make changes in specifications and other information contained in this document without prior notice, and the reader should in all cases consult HII to determine whether any such changes have been made. The information in this publication does not represent a commitment on the part of HII.

HII shall not be liable for technical or editorial errors or omissions contained herein; nor for incidental or consequential damages resulting from the furnishing, performance, or use of this material.

This document contains proprietary information that is protected by copyright. All rights are reserved. No part of this document may be photocopied, reproduced, or translated into another language without the prior written consent of HII.

Web Address: www.honeywellaidc.com

Trademarks

Dolphin is a trademark or registered trademark of Hand Held Products, Inc. in the United States and/or other countries.

Microsoft, Windows, Windows Mobile, Windows CE, Windows NT, Windows 2000, Windows ME, Windows XP, ActiveSync, Outlook, and the Windows logo are trademarks or registered trademarks of Microsoft Corporation.

Other product names mentioned in this manual may be trademarks or registered trademarks of their respective companies and are the property of their respective owners.

Patents

For patent information, please refer to www.honeywellaidc.com/patents.

Other Trademarks

The Bluetooth trademarks are owned by Bluetooth SIG, Inc., U.S.A. and licensed to Honeywell International Inc.

©2010-2012 Honeywell International Inc. All rights reserved.





Table of Contents

Chapter 1 - Agency Approvals

Label Locations	1-1
Safety & RF Approvals by Country:	1-2
Dolphin RF Terminal—802.11b/g and/or Bluetooth	1-3

Chapter 2 - Getting Started

Out of the Box	2-1
LED Indicators	2-2
Desktop	2-3
Command Bar Icons	2-4

Chapter 3 - Terminal Hardware Overview

Standard Terminal Configurations	3-1
Front Panel Features	3-2
Display Backlight	3-3
Screen Backlight - Battery/External Power	3-3
Keyboard Backlight	3-3
Using Screen Protectors	3-3
Back Panel Features	3-8
Installing Memory Cards	3-9
Left Side Panel Features	3-10
Right Side Panel Features	3-10
Top Panel Features	3-10
Bottom Panel Features	3-11
Dolphin Peripherals/Accessories for the Dolphin 6500	3-11
USB Communication Cable for the Dolphin 6500	3-12
Battery Power	3-12
Resetting the Terminal	3-15
Soft Reset (Warm Boot)	3-15
Hard Reset (Cold Boot)	3-16
Suspend Mode	3-16
Changing the Memory Allocation	3-16
Care and Cleaning of the Dolphin Terminal	3-17

Chapter 4 - Using the Keypad

Overview	4-1
Navigation Keys	4-1
Basic Keys	4-2
Alpha/Numeric Modes	4-2
Alpha Indicators on the Number Keys	4-2
Function Key Combinations	4-3
CTRL Key Combinations	4-4
Program Buttons	4-5

Chapter 5 - Using the Image Engine

Overview.....	5-1
Available Image Engines	5-1
Depth of Field	5-1
Supported Bar Code Symbologies	5-2
Activating the Engine.....	5-3
Decoding	5-3
Capturing Images	5-5

Chapter 6 - Using the Laser Engine

Overview.....	6-1
Available Engines	6-1
Depth of Field - IS4813.....	6-1
Supported Bar Code Symbologies	6-1
Activating the Engine.....	6-2
Decoding a Bar Code	6-2

Chapter 7 - Communication

Communication Options	7-1
Installing Additional Software	7-1
Connecting the USB Charging/Communication Cable for the Dolphin 6500.....	7-2
Charging Terminal with USB Cable.....	7-2
ActiveSync Communication.....	7-3
Wireless Radios.....	7-6
Connecting the Terminal to a Wireless Network.....	7-6
WLAN (802.11b/g Radio)	7-6
Adding Programs from the Internet	7-7

Chapter 8 - Bluetooth Handler

Enabling the Bluetooth Radio	8-1
Connecting to Other Devices.....	8-1
Pairing Bluetooth Devices	8-1
Setting Up a Bluetooth Printer	8-1
Setting Up a Connection to a Mobile Phone.....	8-2

Chapter 9 - Dolphin HomeBase/eBase Device

Overview.....	9-1
Front Panel	9-2
Back Panel	9-3
Powering the Dolphin HomeBase Device.....	9-4
eBase Clamp-on Ferrite Core Installation	9-4
Charging the Main Battery.....	9-5
Charging a Spare Battery	9-6
Checking Battery Power	9-6
Technical Specifications	9-7

Chapter 10 - Dolphin QuadCharger Device

Overview.....	10-1
QuadCharger Device	10-1
Battery Charging.....	10-2
Recommendations for Storing Batteries.....	10-3
Troubleshooting.....	10-3
Technical Specifications.....	10-4

Chapter 11 - Dolphin 6500 Net Base Device

Overview.....	11-1
Parts and Functions.....	11-2
Front Panel	11-2
Back Panel	11-3
Bottom Panel	11-4
Power	11-4
Connecting Power to the Net Base.....	11-4
Charging the Main Battery.....	11-5
To Power a Terminal and Charge its Main Battery.....	11-5
Communication.....	11-5
Software Requirements	11-5
Connecting the Dolphin Terminal to the Net Base	11-5
Mounting the Net Base	11-6

Chapter 12 - Dolphin 6500 Slide-On Handle

Overview.....	12-1
Removing the Hand Strap	12-1
Installing the Handle/Removing the Handle.....	12-1

Chapter 13 - Customer Support

Technical Assistance.....	13-1
Product Service and Repair.....	13-1
Limited Warranty	13-1
Limited Warranty Duration.....	13-2
How to Extend Your Warranty	13-2



Agency Approvals

Label Locations

Dolphin 6500 mobile computers meet or exceed the requirements of all applicable standards organizations for safe operation. However, as with any electrical equipment, the best way to ensure safe operation is to operate them according to the agency guidelines that follow. Read these guidelines carefully before using your mobile computer.

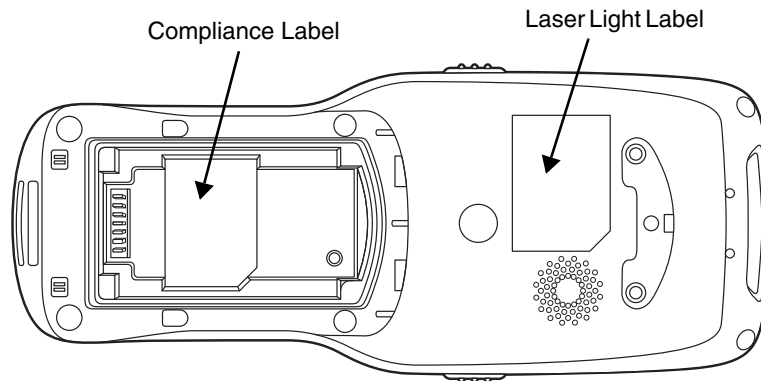

Laser Light Label

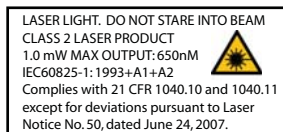

Safety & RF Approvals by Country:

Country	Safety	RF (Radio)
U.S.A.	UL60950-1	FCC Part 15, Sub part B, Sub part C
Canada*	C-UL CSA C22.2 No. 60950-1-03	ICES-003, RSS 210
European Community	IEC 60825-1:1993+A1:1997+A2:2001	EN55022 (CISPR 22) Class B EN55024:1998 EN300 328 EN301 489-1 EN301 489-7 EN301 489-17 IEC 62209-2
China	CCC	SRRC
Japan	PSE	AIRB
Australia	EN60950	AS/NZS4268
Brazil*		ANATEL
Mexico*	NOM-019	COFETEL
New Zealand	EN60950	AS/NZS4268

* Does not apply to IS4813 laser engine.

R&TTE Compliance Statement—802.11b/g and/or Bluetooth

Dolphin RF terminals are in conformity with all essential requirements of the R&TTE Directive (1999/5/EC).

This product is marked with **CE** 0983  in accordance with the Class II product requirements specified in the R&TTE Directive, 1999/5/EC. The equipment is intended for use throughout the European Community; PAN European Frequency Range: 2.402–2.480 GHz.

Restrictions for use in France are as follows:

- Indoor use: Maximum power (EIRP*) of 100 mW for the entire 2.400–2.4835 GHz
- Outdoor use: Maximum power (EIRP*) of 100 mW for the 2.400–2.454 GHz band & maximum power (EIRP*) of 10 mW for the 2.454–2.483 MHz band.

CE The CE Mark on the product indicates that the system has been tested to and conforms with the provisions noted within the 2004/108/EC Electromagnetic Compatibility Directive and the 2006/95/EC Low Voltage Directive. Honeywell shall not be liable for use of our product with equipment (i.e., power supplies, personal computers, etc.) that is not CE marked and does not comply with the Low Voltage Directive.

For further information, contact:

Honeywell Imaging & Mobility Europe BV
Nijverheidsweg 9
5627 BT Eindhoven
The Netherlands

Laser Safety Label

If the following label is attached to your product, it indicates the product contains an imager engine with a laser aimer (5300) or a laser engine (IS4813).

Laser Eye Safety Statement: This device has been tested in accordance with and complies with IEC60825-1: 1993+A1+A2 and 21 CFR 1040.10 and 1040.11, except for deviations pursuant to Laser Notice No. 50, dated June 24, 2007. **LASER LIGHT, DO NOT STARE INTO BEAM, CLASS 2 LASER PRODUCT, 1.0 mW MAX OUTPUT: 650nm.**

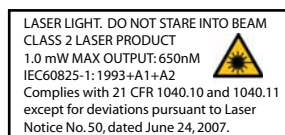

This class 2 laser product is in accordance with the requirements of IEC60825-1 Ed. 1.2 Clause 6.2(a).

Caution - use of controls or adjustments or performance of procedures other than those specified herein may result in hazardous radiation exposure.

LED Safety Statement

The LED output on this device has been tested in accordance with IEC60825-1 LED safety and certified to be under the limits of a Class 1 LED device.

CB Scheme

Certified to CB Scheme IEC 60950-1.

FCC RF Radiation Exposure Statement

This equipment complies with FCC RF radiation exposure limits set forth for an uncontrolled environment.

Dolphin RF Terminal—802.11b/g and/or Bluetooth

This device complies with Part 15 of the FCC Rules. Operation is subject to the following two conditions: (1) this device may not cause harmful interference, and (2) this device must accept any interference received, including interference that may cause undesired operation.

This equipment has been tested and found to comply with the limits for a Class B digital device pursuant to Part 15 of the FCC Rules. These limits are designed to provide reasonable protection against harmful interference in a residential installation. This equipment generates, uses, and can radiate radio frequency energy and, if not installed and used in accordance with the instructions, may cause harmful interference to radio communications. However, there is no guarantee that interference will not occur in a particular installation. If this equipment does cause harmful interference to radio or television reception, which can be determined by turning the equipment off and on, the user is encouraged to try to correct the interference by one or more of the following measures:

- Reorient or relocate the receiving antenna.
- Increase the separation between the equipment and receiver.
- Connect the equipment into an outlet on a circuit different from that to which the receiver is connected.
- Consult the dealer or an experienced radio/TV technician for help.

If necessary, the user should consult the dealer or an experienced radio/television technician for additional suggestions. The user may find the following booklet helpful: "Something About Interference." This is available at FCC local regional offices. Our company is not responsible for any radio or television interference caused by unauthorized modifications of this equipment or the substitution or attachment of connecting cables and equipment other than those specified by our company. The correction is the responsibility of the user. Use only shielded data cables with this system.

In accordance with FCC 15.21, changes or modifications not expressly approved by the party responsible for compliance could void the user's authority to operate the equipment.



This device and its antenna must not be co-located or operating in conjunction with any other antenna or transmitter. To maintain compliance with FCC RF exposure guidelines for body-worn operation, do not use accessories that contain metallic components.

CAUTION! Any changes or modifications not expressly approved by the grantee of this device could void the user's authority to operate the equipment.

Canadian Compliance

This Class B digital apparatus complies with Canadian ICES-003. Operation is subject to the following two conditions: (1) this device may not cause harmful interference, and (2) this device must accept any interference received, including interference that may cause undesired operation.

To prevent radio interference to the licensed service, this device is intended to be operated indoors and away from windows to provide maximum shielding. Equipment (or its transmit antenna) installed outdoors is subject to licensing.

Cet appareil numérique de la Classe B est conforme à la norme NMB-003 du Canada.

For European Community Users

Honeywell complies with Directive 2002/96/EC OF THE EUROPEAN PARLIAMENT AND OF THE COUNCIL of 27 January 2003 on waste electrical and electronic equipment (WEEE).

Waste Electrical and Electronic Equipment Information

This product has required the extraction and use of natural resources for its production. It may contain hazardous substances that could impact health and the environment, if not properly disposed.

In order to avoid the dissemination of those substances in our environment and to diminish the pressure on the natural resources, we encourage you to use the appropriate take-back systems for product disposal. Those systems will reuse or recycle most of the materials of the product you are disposing in a sound way.



The crossed out wheeled bin symbol informs you that the product should not be disposed of along with municipal waste and invites you to use the appropriate separate take-back systems for product disposal.

If you need more information on the collection, reuse, and recycling systems, contact your local or regional waste administration.

You may also contact your supplier for more information on the environmental performances of this product.

Getting Started

Out of the Box

Verify that your carton contains the following items:

- Dolphin 6500 mobile computer (the terminal)
- Main battery pack (3.7v, Li-Ion)
- AC power supply
- Localized plug adapters

Note: Be sure to keep the original packaging in case you need to return the Dolphin terminal for service; see [Product Service and Repair](#) on page 13-1.

Step 1. Install the Main Battery

The Dolphin 6500 is shipped with the battery packaged separate from the unit. Follow the steps below to install the main battery.

1. Release the strap making it convenient to reach the cover.
2. Remove the battery compartment cover by turning the cover's locks upward and removing the cover.
3. Insert the battery into the battery well with the labels facing upward.

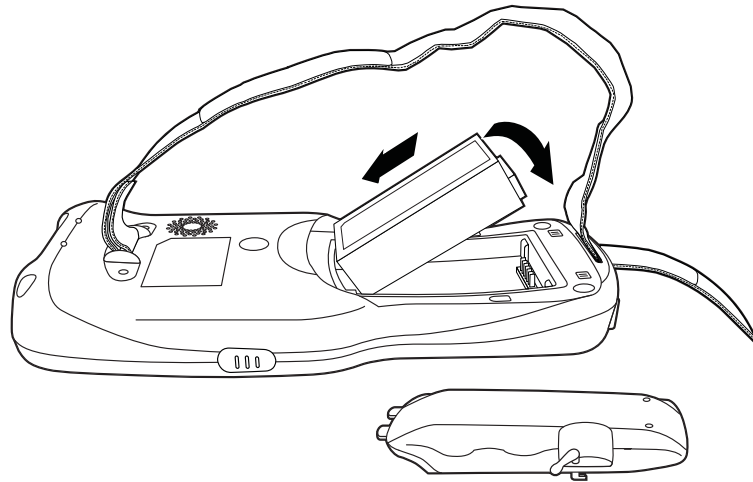

4. Replace the cover with a hinging motion and turn the locks downwards.

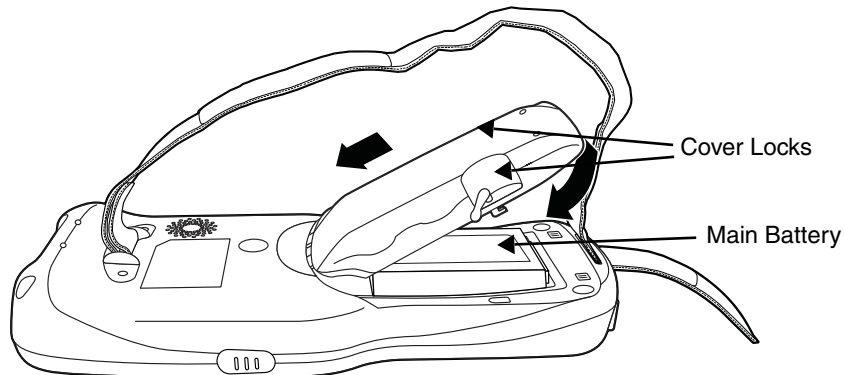

Note: The battery door must be installed prior to booting the unit.

5. Replace the hand strap.



We recommend use of Honeywell Li-Ion battery packs. Use of any non-Honeywell battery may result in damage not covered by the warranty.

Step 2. Charge the Batteries

Dolphin 6500s ship with both the main battery pack and internal backup battery significantly discharged of power. Charge the main battery pack with the Dolphin charging cable until the LED turns green (red while charging). The average charge time for a fully depleted main battery is 5 1/2 hours. It takes less time if the battery has some charge.

1. Attach the appropriate plug adapter to the plug of the power cable.*
2. Insert the plug into the appropriate power source.
3. Plug the Dolphin power cable into the **DC Power Jack** (see page 3-11) on the bottom end of the unit.

Note: If you remove the battery pack or it completely discharges, there is a 30 minute window in which to insert a charged battery pack before the backup battery completely discharges. If your backup battery completely discharges, the contents of the RAM memory will be lost. If your backup battery is less than fully charged, there is a proportionally smaller window of time available.

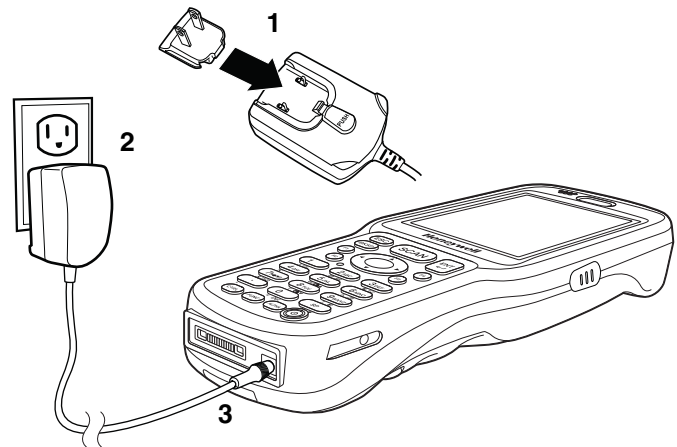

LED Indicators

Red LED On	Charging
Green LED On	Battery is fully charged



We recommend use of Honeywell peripherals, power cables, and power adapters. Use of any non-Honeywell peripherals, cables, or power adapters may cause damage not covered by the warranty. DO NOT attempt to charge damp/wet mobile computers or batteries. All components must be dry before connecting to an external power source.

*The power adapter on the power cable converts the voltage from the power source to 5 volts DC. Only power adapter cables from Honeywell convert the voltage appropriately. The power cable contains a plug adapter for each geography (US, UK, EU, etc.).

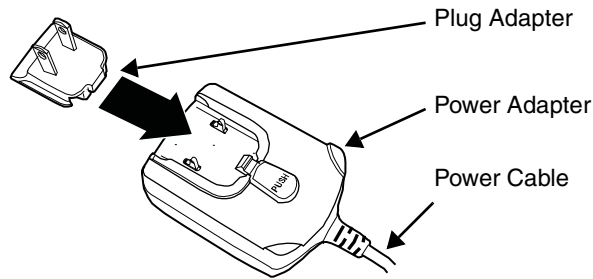

Step 3. Boot the Terminal

The terminal begins booting as soon as power is applied and runs by itself. Do NOT press any keys or interrupt the boot process.

When the boot process is complete, the Desktop appears, and the terminal is ready for use.

Desktop

Note: You can access the Desktop any time by tapping the Change Views icon in the command bar and selecting Desktop on the popup menu.

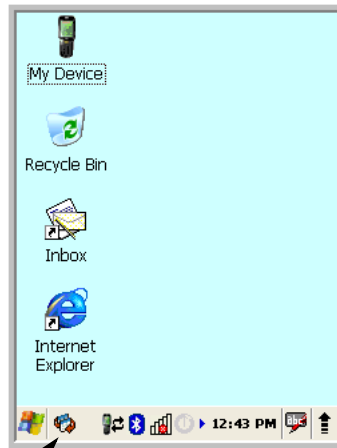

Tap to change views

Command Bar Icons

The command bar, located at the bottom of application screens, provides access to many system functions and programs.



Left and right arrows are used to scroll through additional icons

Icon	Meaning
	Opens the Start menu.
	Tap to change views between open applications or to return to the desktop.
	Accesses the Bluetooth radio. Double tap this icon to open the Bluetooth Handler (see page 8-1).
	Shows signal strength of WiFi radio. (A red X indicates it is not currently associated to an AP.)
	Double tap to configure your WLAN Secure Wireless Client. For complete configuration instructions, download the Honeywell Secure Wireless (SWC) Client User's Guide from www.honeywellaidc.com .
	Indicates Ethernet communications. When the terminal is undocked, no icon appears. When it is docked without a cable, the icon has a red X through it. When docked with a cable connected, this icon displays.
	Indicates that the USB communication cable is connected. Double tap to display USB status window.
	Indicates the status of battery power. Double tap to open the Power control panel setting.
	When this icon shows a red power plug, it indicates the device is using external power.
	Displays the current time. Double tap to change the time and date.
	28-key keypad - Indicates whether the keypad is standard alpha (uppercase and lowercase), all caps alpha, or in numeric mode. Press the ALPHA button on the keypad to switch modes. 52-key keypad - Press the SFT key twice in rapid succession to toggle between upper and lowercase as indicated by the icon. Pressing the SFT key once temporarily toggles for the next typed key and then reverts back. You can also change from upper/lowercase by selecting the "ABC"/"abc" indicator and selecting CAP on the keyboard that displays. Pressing a number key results in a number appearing in the application. Pressing SFT key once and typing a number on the keypad results in a special character appearing in the application.
	The up arrow allows you to turn the Wireless LAN and Bluetooth connection on or off. It also allows you to toggle between the Keyboard and Transcriber. When Keyboard is selected, a keyboard is displayed so you can tap text and number keys. Transcriber recognizes handwriting and symbols entered using the stylus.

Using the Stylus

The terminal comes with a stylus included in a loop on the hand strap. Use this stylus (or your finger) to select or enter information on the touch screen. The stylus functions as a mouse; generally, a tap is the same as a click.

Tap Tap the touch screen once or double tap to open menu items and select options.

Drag Hold the stylus on the screen and drag across the screen to select text and images.

Tap & hold Tap and hold the stylus on an item and a pop-up menu appears. On the pop-up menu, tap the action of the task you want to perform.



Use of objects, such as paper clips, pencils, or ink pens on the touch screen can damage the input panel and may cause damage not covered by the warranty.

For more information about the touch screen, see [Touch Screen Display](#) on page 3-2.

Selecting Programs

Tap **Start > Programs**. To open a program, tap the icon on the menu.

Pop-Up Menus

You can quickly choose an action for an item using the pop-up menus.

1. Tap and hold the stylus on the item name. The pop-up menu appears.
2. Lift the stylus and tap the action you want to perform.

The contents of pop-up menus change according to the program you are using.

Using Windows Explorer

Use Windows Explorer to navigate through the files on your system. On the desktop, double tap the **My Device** icon and Windows Explorer opens to the root level.

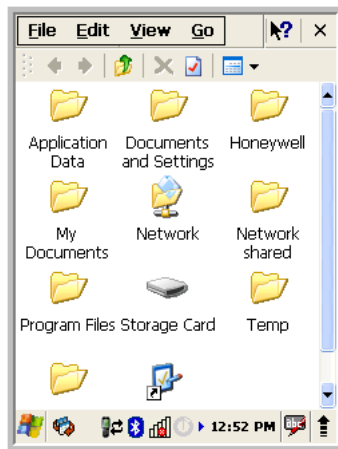

Move files by tapping and holding on the file, then tapping **Cut**, **Copy** or **Paste** on the pop-up menus that appear.

Terminal Hardware Overview

Dolphin 6500 terminals include a number of standard terminal configurations as well as charging and communication peripherals and accessories to maximize the efficiency of your application setting.

Standard Terminal Configurations

There are two standard Dolphin 6500 configurations: WPAN only and WPAN/WLAN. Both configurations include the following options; however, the WPAN/WLAN configuration has both a Bluetooth radio and an 802.11b/g radio.

Dolphin 6500 WPAN and WPAN/WLAN

- Microsoft Windows CE 5.0
- Marvell PXA 300 624MHz
- 128MB RAM X 128 MB (non-volatile) Memory
- 28-key numeric keypad (alpha shifted) and 52-key full alpha and numeric keypad
- 3.5" transfective active matrix 65k color LCD display with backlight, QVGA (240 x 320)
- Li-Ion battery: 3.7V / 3300mAh / 12.2 Wh
- 5300SR image engine with laser aiming or IS4813 laser engine
- (WPAN) - Bluetooth radio
- (WPAN/WLAN) - Bluetooth and 802.11b/g radio
- Dolphin power cable (included with each Dolphin 6500)

Front Panel Features

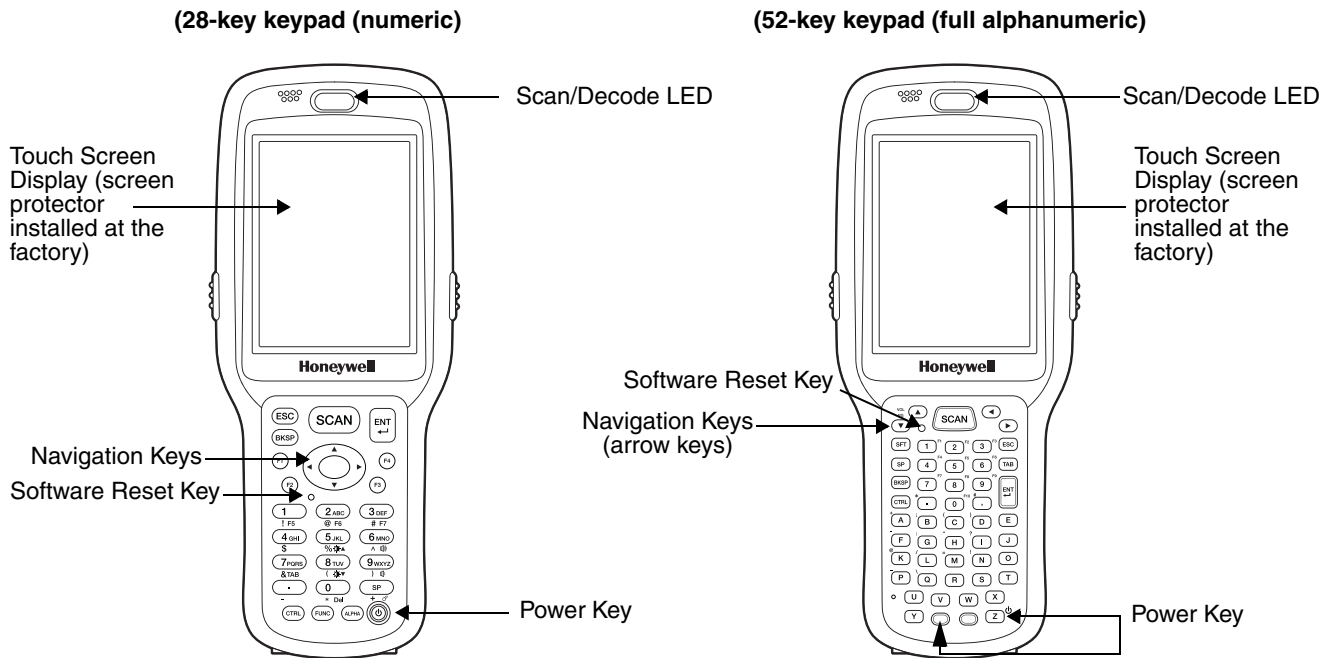

Scan/Decode LED

The LED lights red when you press the Scan trigger in scanning applications.
The LED lights green when a scanned bar code is successfully decoded.
The LED lights red while the main battery is charging.
The LED lights green when the main battery charging is completed.
The LED lights blue or red during soft and hard resets.
The LED is user-programmable.

Keypad

28-key numeric keypad (alpha shifted) and 52-key full alphanumeric keypads are available.

Microphone

The integrated microphone can be used for audio recording.

Touch Screen Display

The display is a 3.5" transfective active matrix, 65k color LCD display with a backlight, QVGA (240 x 320 resolution); see [Display Backlight](#) on page 3-3. The touch panel is a 4-wire analog resistive touch.



Dolphin 6500s ship with a screen protector already installed over the touch screen lens to help prevent damage to the touch screen. Do NOT remove this screen protector before initial use. Honeywell recommends using screen protectors, especially for applications that require high volume interfacing with the touch screen. For more information, see [Using Screen Protectors](#) on page 3-3. You can purchase additional screen protectors by contacting your Honeywell sales representative.

For touch screen input, use the stylus included with the terminal or your finger. The method you choose depends on which one is most appropriate for your application. While there is a great deal of variation in different applications, you generally achieve greater accuracy with the stylus for buttons or icons that are close together.

 *Use of objects, such as paper clips, pencils, or ink pens on the touch screen can damage the input panel and may cause damage not covered by the warranty.*

Display Backlight

The intensity of the backlight of the touch screen display may be changed, and the backlight may be programmed to turn off after the terminal has been idle for a specified period of time.

To adjust the intensity of the backlight while on battery power, tap **Start > Settings > Control Panel > double tap Backlight**.

Screen Backlight - Battery/External Power

Move the slider to adjust the screen backlight while on battery power.

You may turn the screen backlight off if the device is not used for a designated period of time by checking the option and designating the desired time period.

You may also turn on the screen backlight when a button is pressed or the screen is tapped by selecting the appropriate checkbox.

Note: Using the backlight option while on battery power substantially reduces battery life.

You may make the same changes when on external power by tapping the **External** tab.

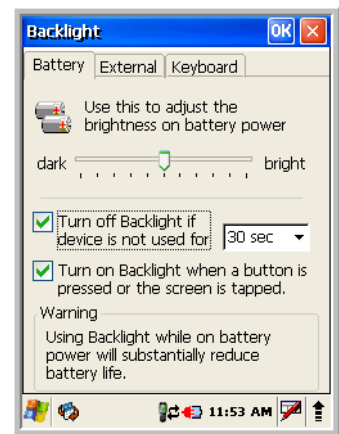

Keyboard Backlight

The intensity of the backlight of the keys on the keyboard may be changed and the backlight may be programmed to remain on for a specified period of time once a key is pressed.

To adjust the brightness of the keys, tap the **Keyboard** tab. Move the slider to adjust the backlight while on battery power.

To turn on the keyboard backlight, check the checkbox and change the duration of the backlight.

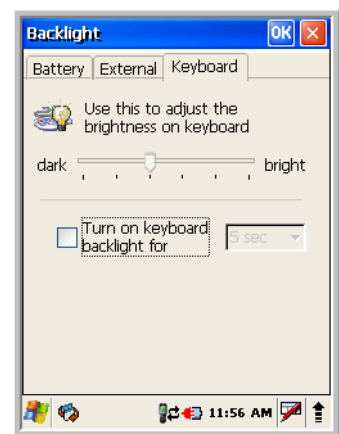

Using Screen Protectors

Honeywell defines proper use of the terminal touch panel display as using a screen protector and proper stylus. Screen protectors maintain the ongoing integrity (i.e., prevent scratching) of the touch panel, which is why their use is recommended for applications that require a high to medium level of interface with the touch panel.

Honeywell continues to advocate the use of screen protectors on all Dolphin terminals. We recommend implementing a screen protector replacement program to ensure that screen protectors are replaced periodically when signs of damage/wear are noticeable. For general use, we recommend replacing the screen protector every thirty (30) days. However, replacement cycles vary according to the average level of touch panel use in your application.

Replacement screen protectors can be purchased directly from Honeywell. Contact a Honeywell sales representative for details.

Honeywell also mandates use of a proper stylus, which is one that has a stylus tip radius of no less than 0.8mm. Use of the Honeywell stylus included with the terminal is recommended at all times.

Honeywell's warranty policy covers wear on the touch panel for the first 12 months provided that a screen protector is applied and an approved stylus is used for the 12-month duration covered by the warranty.

Removing the Screen Protector

Dolphin 6500s ship with a touch screen protector already installed. To replace the screen protector, you must remove the one already installed.

1. Press the red **Power** button to suspend the 28-key unit or press the **Blue** then **Z** (Power) keys to suspend the 52-key unit.
2. Using a strong, flat, plastic card (e.g., credit card) wedge the edge of the card under the existing screen protector. Catch the edge of the screen protector and pull it up and away from the touch panel.

Note: If you have one, you can also use the small plastic squeegees designed for touch panels.

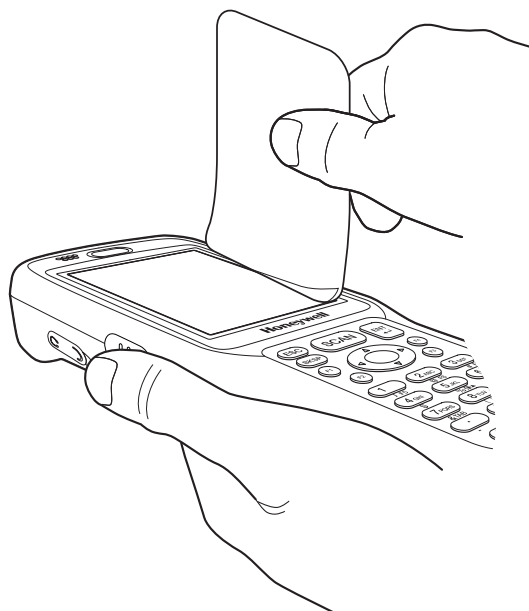

3. Wipe the screen with a clean, non-abrasive, lint-free cloth.

Note: Use ionized air, if available, to blow additional dirt or particles off the touch panel.

Installing Your Screen Protector

When installing a new screen protector, use a flat plastic card (e.g., credit card) to apply the screen protector smoothly and remove any air bubbles.

Note: If you have one, you can also use the small plastic squeegees designed for touch panels.

1. Press the red **Power** button to put the terminal in Suspend Mode on the 28-key Dolphin 6500 or press the **Blue** then **Z** (Power) keys on the 52-key Dolphin 6500.

-
2. Clean the touch panel thoroughly with a clean, non-abrasive, lint-free cloth. Make sure nothing is on the touch panel.
 3. Release the left edge of the backing paper on the screen protector.
 4. Align the exposed edge of the screen protector along the left edge of the touch panel. Make sure that it lies flush with edges of the touch panel.

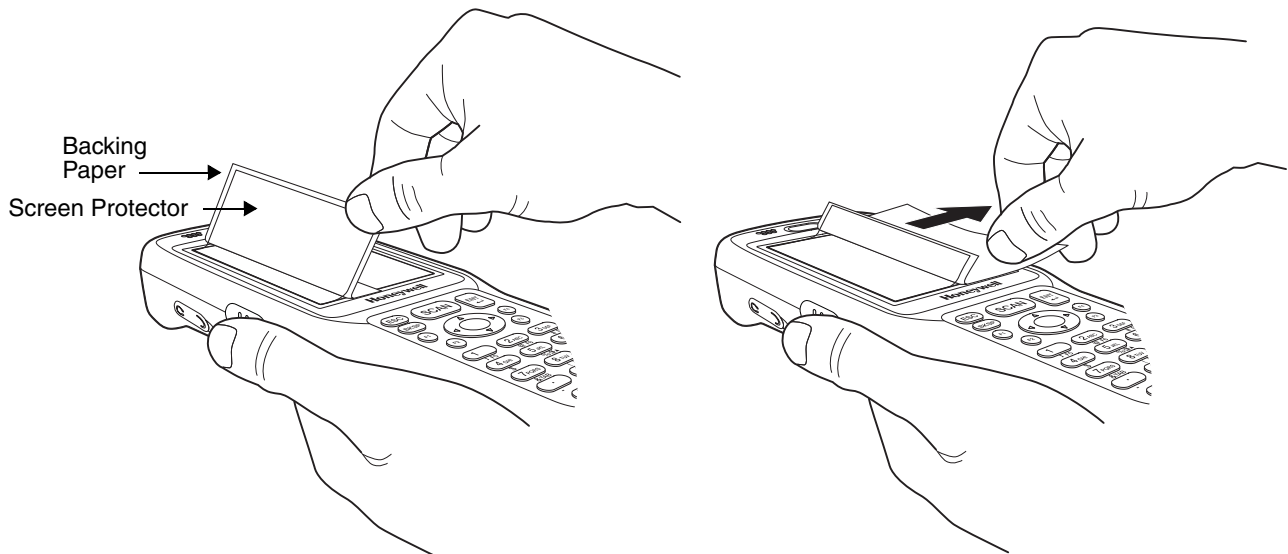

Note: To reposition the screen protector, lift up gently and reapply.

5. Use the card on top of the screen protector to smooth it out as you pull on the backing paper.

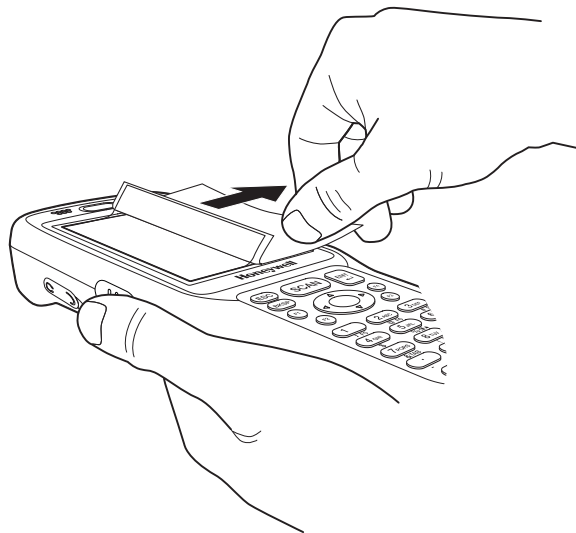

-
6. Pull smoothly and evenly from left to right until the screen protector is applied. Press gently but firmly. Use the card as necessary to smooth out any air pockets or bumps after application.

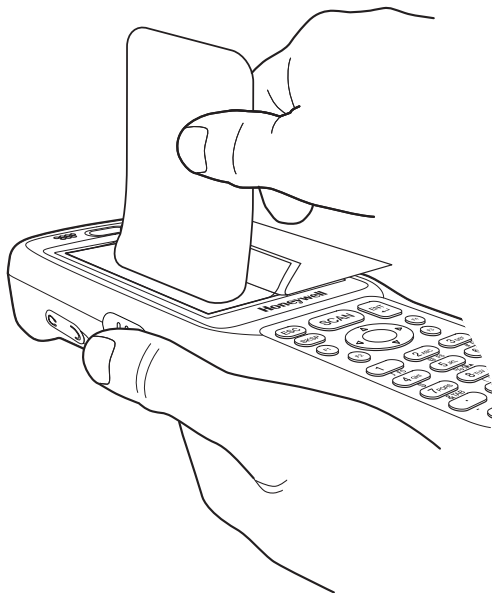

7. Press the **Power** key to wake the terminal and check the touch panel with the stylus.

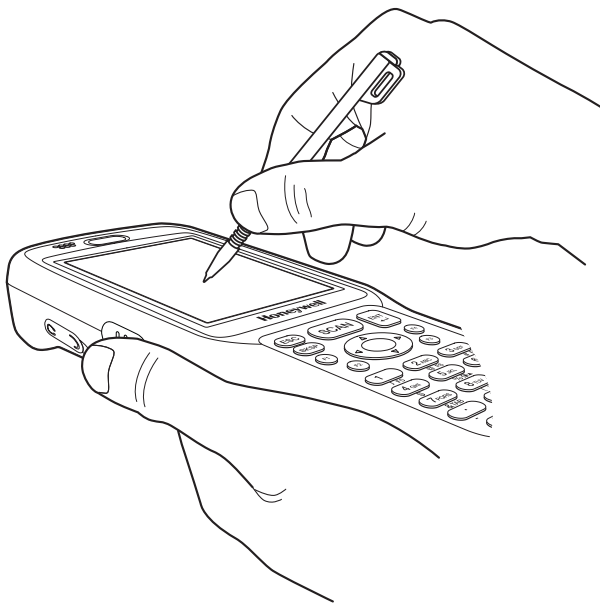

8. Verify that the screen accepts input from the stylus as usual. If not, re-apply the screen protector.
9. Press the red **Power** button to put the terminal back in Suspend Mode on the 28-key Dolphin 6500 or press the **Blue** then **Z** (Power) keys on the 52-key Dolphin 6500.
10. Clean the surface of the screen protector with a clean, non-abrasive, lint-free cloth.
11. Press the **Power** key to wake the terminal again.

-
12. For maximum performance, recalibrate the screen. Tap **Start** > **Settings** > **Control Panel** > double tap **Stylus** > **Calibration** tab.

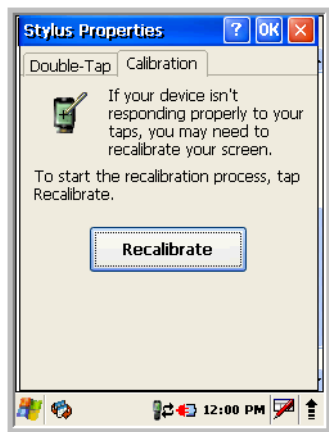

13. Tap **Recalibrate** and follow the instructions on the screen.

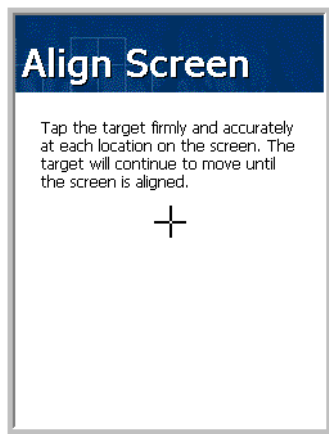

Back Panel Features

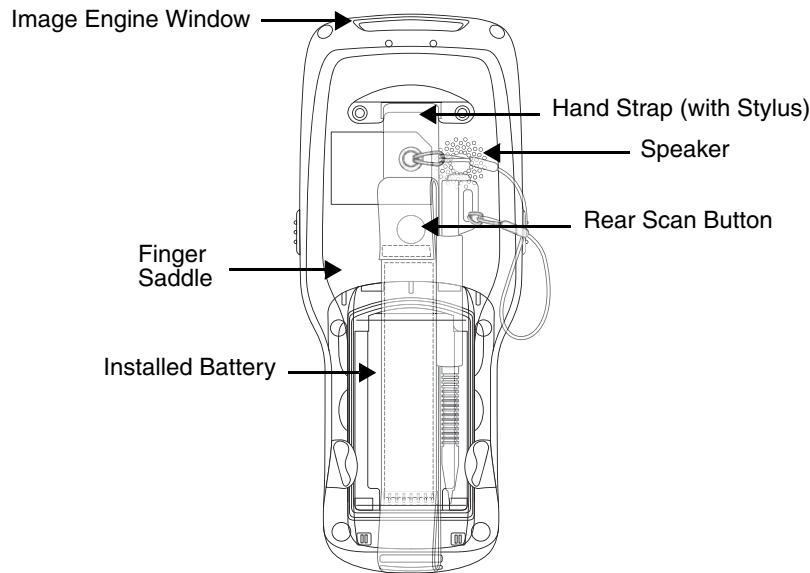

Hand Strap

The Dolphin 6500 comes with an adjustable, elastic hand strap. The strap is attached to the device with the two small screws. It is threaded through the slot on the bottom of the back of the unit.

Keep in mind that the hand strap covers the battery. When you want to replace the battery, you will need to adjust the hand strap accordingly.

Rear Scan Button

The Dolphin 6500 has a Scan button conveniently located on the back of the unit. This button works like the SCAN button located on the front of the unit. Pressing this button can also resume a suspended device.

Finger Saddle

This is a slightly depressed and angled area of the back housing that is designed to cradle or “saddle” your finger while holding the terminal. This unique ergonomic design makes the terminal comfortable to hold and helps prevent you from accidentally dropping the terminal.

Installed Battery

For information about installing the battery, see [Changing the Main Battery Pack](#) on page 3-13. For information about battery power, see [Battery Power](#) on page 3-12.

Speaker

The integrated speaker sounds audio signals as you scan bar code labels and enter data, but emits no ambient noise on system activity (i.e., processor, memory access, radio traffic, etc.). The speaker can also be used for playing sounds (e.g., WAV or MP3 files).

The speaker meets the following SPL levels at 40cm:

- 500Hz–67db
- 1KHz–72db

- 4KHz-72db

Stylus

Dolphin 6500 terminals ship with a stylus inserted in a loop on the hand strap. Store the stylus in the hand strap when you're not using it; see [Using the Stylus](#) on page 2-5.

Installing Memory Cards

The Dolphin 6500 supports Secure Digital (SD) memory cards from 512MB up to 8GB in capacity. The recommended SD cards are 2GB and 4GB ATP®-brand, which have been tested for reliability. You can purchase these SD cards by contacting your Honeywell sales representative.

To install an SD card:

1. Remove the battery door on the back of the unit.
2. Remove the battery.
3. Insert the SD card with the label facing upward by pressing down the small pin and sliding the SD card into the SD card connector until you feel it lock into position. The notch on the SD card should be in the upper-right hand corner.

Note: If your unit has trouble reading the SD card, the SD card may not have been inserted correctly. If depressing the small pin allows the card to eject, the card was not properly inserted and "locked in."

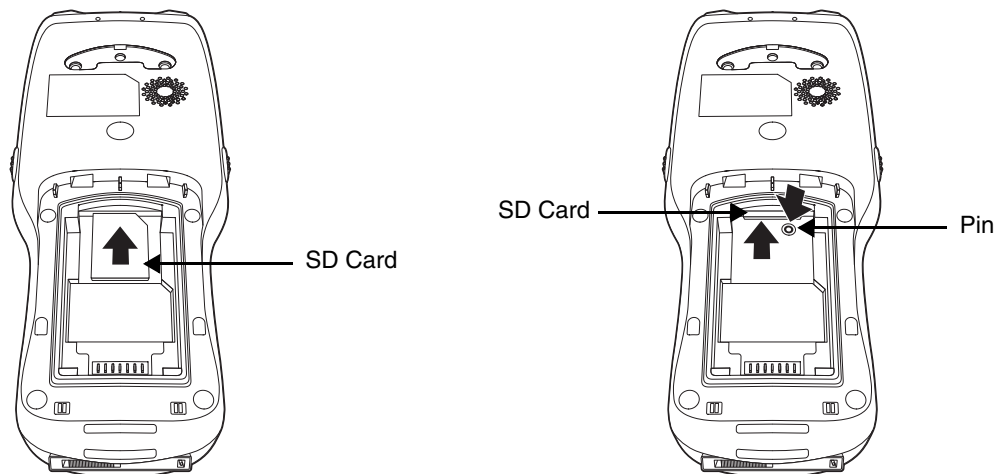

4. Replace the battery and battery door.
5. Tap the **Power** or **SCAN** key to resume operation.
6. To verify that the operating system recognizes the new memory card, open Windows Explorer and navigate to My Device\Storage Card.

To remove an SD card:

1. Remove the battery door on the back of the unit.
2. Remove the battery.
3. Press the SD card towards the front of the terminal until you hear a click to confirm that it has unlocked. The card will stop when it hits the pin.
4. Depress the small pin at the edge of the card. The card will pop out enough for you to grab its edge.

Left Side Panel Features

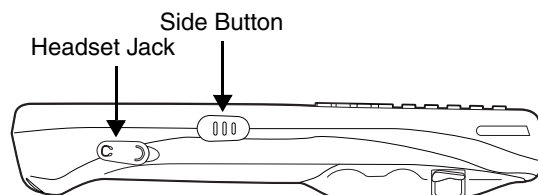

Side Button

There is a button like this on both side panels. You can use the Programs Buttons option in the Control Panel to change the functionality of the side buttons.

Headset Jack

The rubber door on the right side panel provides access to the headset jack. This is a 2.5mm audio jack that supports a headset with a mono speaker and microphone.

When closed, the side door seals the terminal from moisture and particle intrusion thus preserving the terminal's environmental rating.

Right Side Panel Features

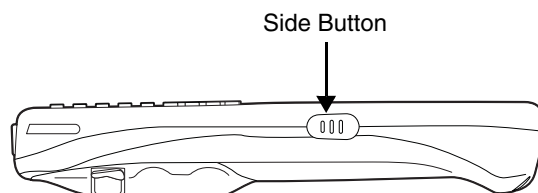

Side Button

There is a button like this on both side panels. You can use the Programs Buttons option in the Control Panel to change the functionality of the side buttons.

Top Panel Features

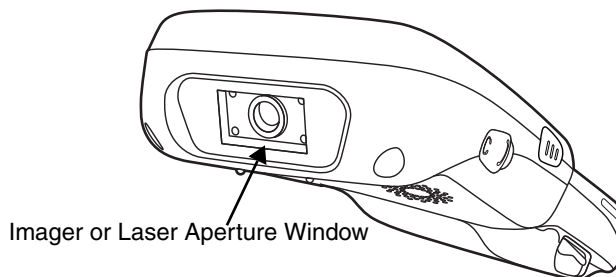

Imager or Laser Aperture Window

The angled image engine reads and decodes most popular bar code symbologies and takes images like a digital camera (imager engine only). For more information, see [Using the Image Engine](#) on page 5-1 or see [Using the Laser Engine](#) on page 6-1.

Bottom Panel Features

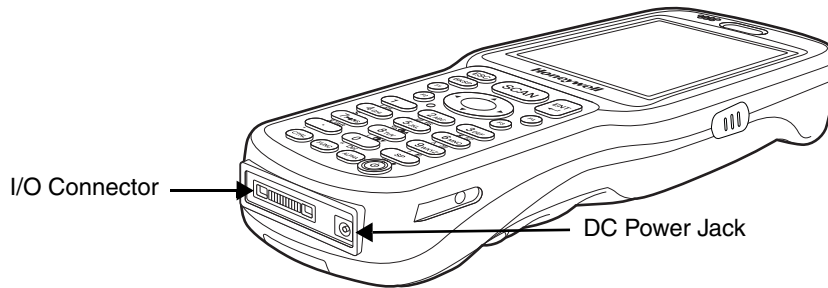

DC Power Jack

The DC power jack receives external power from the Dolphin power cable that is included in the box with the terminal. When connected to the Dolphin power cable, the terminal is powered and the main battery pack is charging.

I/O Connector

The I/O mechanical connector is designed to work exclusively with Dolphin 6500 peripherals and cables. This connector powers the terminal, charges the main battery, and facilitates communication. This connector supports full speed USB 1.1 communication (up to 12 Mbps) and RS-232 communications with a maximum speed of 115Kbps and seven baud rate settings.

Through this connector, you can communicate with a host workstation via Microsoft ActiveSync; see [ActiveSync Communication](#) on page 7-3

The I/O connector supports the following signals:

- DC IN
- Transmitted Data
- Request To Send
- USB Host +5V
- USB Host D+
- USB Host D-
- USB Host Detect
- Clear To Send
- Received Data
- GND
- RS-232 Shutdown
- USB Client D+
- USB Client D-
- USB Client +5V

Note: Signals referenced are for a DTE device.

Dolphin Peripherals/Accessories for the Dolphin 6500

The following items are sold separately and enhance your Dolphin 6500's capabilities.

Dolphin HomeBase™ Device

This charging and communication cradle supports USB and RS-232 communication, enabling your terminal to interface with the majority of enterprise systems. When a terminal is seated in a powered base, its main battery pack charges in an average of 5 1/2 hours for a fully depleted battery. It takes less time if the battery has some charge.

A spare battery may also be charged in the battery charging well behind the terminal.

For more information, see [Dolphin HomeBase/eBase Device](#) on page 9-1

Dolphin eBase™ Device

The Dolphin eBase is used to charge the main battery, to power the battery charging system in the terminal, and can be used to communicate data from the terminal to a PC/laptop via the Ethernet port.

A spare battery may also be charged in the battery charging well behind the terminal.

For more information, see [Dolphin HomeBase/eBase Device](#) on page 9-1

Dolphin QuadCharger™ Device

The Dolphin QuadCharger device, a four-slot charging station for Dolphin Li-Ion battery packs, can charge each battery in an average of 5 1/2 hours for a fully depleted battery. It takes less time if the battery has some charge.

For more information, see [Dolphin QuadCharger Device](#) on page 10-1.

USB Communication Cable for the Dolphin 6500

The USB Communication Cable for the 6500 is used when communicating between the terminal and a PC/laptop via the USB port. The cup-style 6500-USB cable slides onto the bottom of the device lining up with the connector. The cable unit includes an opening for the power cable. See [Connecting the USB Charging/Communication Cable for the Dolphin 6500](#) on page 7-2.

Li-Ion Battery Packs

The Li-Ion battery pack provides the main power supply for the terminal. For more information, see [Battery Power](#) on page 3-12.

For information on how to purchase these items, contact a Honeywell sales representative.

Battery Power

The intelligent battery technology inside the terminal features two types of battery power:

- The main battery pack on the back panel (see [Main Battery Pack](#) on page 3-13)
- The backup battery located inside the terminal (see [Internal Backup Battery](#) on page 3-15)

Both batteries work together to prevent data loss when the terminal is used over long periods of time.

Both batteries must be charged to full capacity before using the Dolphin 6500 for the first time!

Charge the main battery pack with the Dolphin charging cable until the LED turns green (red while charging). The average charge time for a fully depleted main battery is 5 1/2 hours. It takes less time if the battery has some charge.

Main Battery Pack

 We recommend use of Honeywell Li-Ion battery packs. Use of any non-Honeywell battery may result in damage not covered by the warranty.

The Dolphin 6500 has a Li-Ion 3.7V/3300 mAh/12.2 Wh battery pack.

The Li-Ion battery pack is the primary power source for the Dolphin terminal as well as the internal backup battery.

Changing the Main Battery Pack

Before installing a battery pack, press the **Power** button on the 28-key Dolphin 6500 or press the **Blue** then **Z (Power)** keys on the 52-key Dolphin 6500 to put the terminal in **Suspend Mode** (see page 3-16) so that operations are suspended before removing the main power source. The Dolphin 6500 is shipped with the battery separate from the unit. You will need to loosen the hand strap, remove the battery door, insert the battery, and replace the battery door. Refer to the instructions included in **Installing the Main Battery** section (page 2-1).

Note: The battery door must be installed prior to booting the unit.

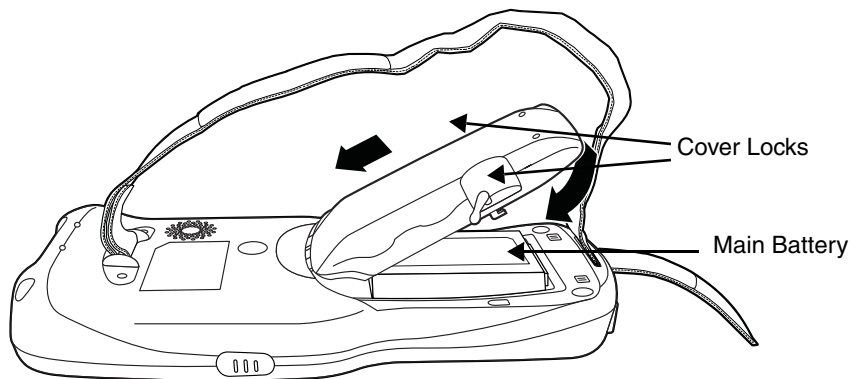

Charging Options

When the battery is installed in the terminal, you can use any of the peripherals listed below to charge the battery.

- **Dolphin HomeBase/eBase Device** (see page 9-1)
- **Dolphin Comm/Charge Cable**; **Connecting the USB Charging/Communication Cable for the Dolphin 6500** (see page 7-2) You may charge the device using the USB connection if you do not have a wall adapter. There are two options that allow either 100mA or 500mA of current over the USB connection. Access the option by selecting **Start > Settings > Control Panel > Power > USB Charging**.

To fully charge the Li-Ion battery before installing it in the terminal, use the

- **Dolphin QuadCharger Device** (see page 10-1) or insert the battery in the spare battery charging well in the back of either the Dolphin HomeBase or Dolphin eBase.

Charging Time

The 3300mAh battery pack charges to full capacity in an average of 5 1/2 hours for a fully depleted battery. It takes less time if the battery has some charge.

Managing Main Battery Power

Data and files saved on the Dolphin terminal may be stored in RAM memory; therefore, maintain a continuous power supply to the terminal to help prevent data loss. When you remove a battery pack, insert another charged battery pack in the Dolphin. If the main battery pack is low, insert the terminal into a charging peripheral to power the terminal and begin recharging the battery.

*Note: If the main battery is low and the terminal is in Suspend Mode, pressing the **Power** button does **not** wake the Dolphin 6500 terminal; you must first replace the discharged battery with a fully charged battery or apply A/C power to the terminal.*

Checking Battery Power

Power icons appear in the command bar at the bottom of the window. Double tap on the battery icon to open the Power Properties. The Battery tab opens displaying the charge status of both the main and backup batteries.

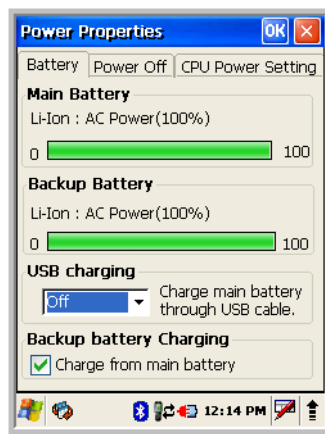

*Note: You can also check battery power by tapping **Start** > **Settings** > **Control Panel** > double tap **Power**.*

Storage Guidelines

To maintain optimal battery performance, follow these storage guidelines:

- Avoid storing batteries outside the specified range of -4 to 140° F (-20 to 40°C) or in extremely high humidity.
- For prolonged storage, it is recommended that the battery be at a 40% - 50% charge level, be removed from the device, and stored in a controlled temperature environment. Following these recommendations will maximize battery life.

Guidelines for Battery Pack Use and Disposal

The following are general guidelines for the safe use and disposal of batteries:

- We recommend use of Honeywell Li-Ion battery packs. Use of any non-Honeywell battery may pose a personal hazard to the user.
- DO NOT attempt to charge damp/wet mobile computers or batteries. All components must be dry before connecting to an external power source.
- Replace defective batteries immediately; using a defective battery could damage the Dolphin terminal.
- Never throw a used battery in the trash. It contains heavy metals and should be recycled according to local guidelines.
- Don't use a battery in any other manner outside its intended use in Dolphin terminals and peripherals.
- Don't short-circuit a battery or throw it into a fire; it can explode and cause severe personal injury.

-
- Excessive discharge damages a battery. Recharge the battery when your terminal indicates low battery power.
 - If you observe that the Honeywell battery supplied is physically damaged in some way, send it to Honeywell International Inc. or an authorized service center for inspection. Refer to the [Product Service and Repair](#) (page 13-1) section of this guide.
 - Although your battery can be recharged many times, it will eventually be depleted. Replace it after the battery is unable to hold an adequate charge.
 - If you are not sure the battery or charger is working properly, send it to Honeywell International or an authorized service center for inspection.

Internal Backup Battery

Located inside the terminal, the backup battery is a 3.7V Lithium Polymer battery.

The internal backup battery prevents the terminal from being reset when you remove the main battery pack. This backup battery retains RAM data and allows the real-time clock to remain operational for at least 30 minutes. If the terminal is left without the main battery pack for more than 30 minutes, the internal backup battery discharges and needs to be recharged to function according to specifications.

Note: Even if the internal backup battery fails, data and programs stored in Flash memory (\\Honeywell\AutoInstall) or on an optional SD card are not lost. However, the terminal automatically cold boots when you install a fully charged battery pack and you will need to reset the real-time clock.

Charging

The internal backup battery charges off the main battery pack and requires 2 hours charge time to backup RAM data for 30 minutes. You can begin using the Dolphin terminal after charging the main battery for an average of 5 1/2 hours for a fully depleted battery; however, the internal backup battery will continue to charge off the main battery. It takes less time to charge the main battery if the battery has some charge.

To ensure that the internal backup battery functions properly, maintain a consistent power supply for the first eight hours of terminal operation. This power supply can be external power (using a charging peripheral) or an installed, charged battery pack or a combination of both.

Charging Guidelines

Follow these guidelines to maximize the life of the Dolphin 6500's internal backup battery under normal usage conditions:

- Keep a charged Li-Ion battery pack in the Dolphin terminal.
- Keep the Dolphin terminal connected to a power source when the terminal is not in use.

Resetting the Terminal

Soft Reset: Using the stylus, press the **Reset** button. The screen turns white and the decode/scan LED flashes blue for approximately 10 seconds.

Hard Reset: 28-key: Press and hold the **Power** button and then using the stylus, press the **Reset** button.
52-key: Press and hold the **Blue** and **Z (Power)** buttons and then using the stylus, press the **Reset** button.
The screen turns white and the decode/scan LED flashes blue for approximately 18 seconds.

Soft Reset (Warm Boot)

A soft reset re-boots the terminal without losing RAM data, terminates all running applications, reloads the OS, and launches Autoinstall, which installs any CAB or REG files in the **\\Honeywell\AutoInstall** folder.

You would perform a soft reset 1) when the terminal fails to respond, 2) after installing software applications that require a reboot, 3) after making changes to certain system settings, or 4) to install new CAB or REG files.

The desktop appears when the Soft Reset is complete.

Hard Reset (Cold Boot)



A hard reset erases all of the data and applications stored in RAM memory, reloads the OS, resets the Real Time Clock (RTC), and launches Autoinstall, which installs any CAB or REG files in the \\Honeywell\\AutoInstall folder.

Hard resets automatically launch a soft reset as part of the boot process if there are CAB files present.

You would perform a Hard Reset (instead of a Soft Reset) when you want to ensure the RAM memory is also cleared. RAM memory stores settings for Internet Explorer, Outlook, and other Microsoft applications.

Note: Set the time and date after each hard reset to ensure that the system clock is accurate. Double-click the date on the command bar to open the Clock setting and set the time and date.

Suspend Mode

Suspend Mode suspends terminal operation. The terminal appears to be “off” when in Suspend Mode. The terminal is programmed to go into Suspend Mode automatically when inactive for a specified period of time. You can set this time period in the Power setting.

To suspend operation, press the red **Power** button to put the terminal in Suspend Mode on the 28-key Dolphin 6500 or press the **Blue** then **Z (Power)** keys on the 52-key Dolphin 6500. To wake the device, press the **Power** button. You may also press the front or rear scan keys to wake a suspended device.

Troubleshooting Suspend/Resume

If the terminal does not wake when you press the **Power** button on the 28-key Dolphin 6500 or press the **Blue** then **Z (Power)** keys on the 52-key Dolphin 6500, the main battery might be too low to resume operation. To check, remove the battery and install a fully charged battery or connect the terminal to a Dolphin charging peripheral.

Changing the Memory Allocation

You can adjust file storage vs. program memory in System Properties.

1. Tap **Start > Settings > Control Panel > System > Memory** tab.

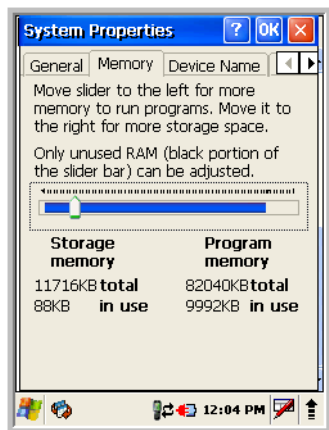

2. Move the slider to adjust the memory allocation and tap **OK**. The changes take effect immediately.

Care and Cleaning of the Dolphin Terminal

When needed, clean the image or laser engine window and the LCD display with a clean, non-abrasive, lint-free cloth. The terminal can be cleaned with a damp cloth.

Dolphin 6500 Technical Specifications

Operating System	Microsoft Windows CE 5.0
Development Environment	Honeywell SDK for Windows® CE 5.0
Application Software	Honeywell Power Tools and Demos
Processor	Marvell PXA 300 624MHz
Memory	128MB RAM X 128 MB Flash
Expansion Memory	SD Card (full size) with capacities up to 4G. Recommended brand is ATP.
Display	3.5 in. transfective active matrix 65K color LCD with backlight, QVGA (240 x 320)
Backlight	LED
Engine	5300SR 2D image engine with laser aimer or IS4813 1D laser engine
Keypad	28-key shifted alpha numeric keypad or 52-key full alpha and numeric keypad with backlit keys
Audio	Built-in microphone and speaker, stereo headset jack
Communication Interface	Full speed USB 1.1 (12Mbps) from cradle (or I/O cable); RS232 (115 Kbps) from cradle
Main Battery	Li-Ion battery 3.7V / 3300 mAh / 12.2 Wh (includes extended battery door)

Backup Battery	100mAh Li-Polymer Ion (5300SR) or 145mAh (IS4813)
Expected Hours of Operation	3300mAh battery pack: 12 hours (5300SR)/11 hours (IS4813) (with scan every 2 seconds) Battery life varies with application and use case.
Charging	5V/3A (5300SR) and 5V/2A (IS4813) input through bottom access or USB/Serial connector
Expected Charge Time	3300mAh - 5 1/2 hours for a fully depleted battery
Charging Peripherals	AC wall adapter and Charger (PSC11R-050)/Communication Cable HomeBase–single-bay terminal charge/communicate eBase–single-bay terminal charge/communicate (via Ethernet connection) Quad Charger–four-slot battery pack charger (DSA-0421S-03 1)
WPAN (standard)	Bluetooth Class II (10 m) v2.0 Enhanced Data Rate (EDR) with on-board antenna. BQB certified
WLAN (optional)	Dual Mode 802.11 b/g (11 Mbps/54 Mbps) with internal antenna
WLAN Security	WEP, 802.1x, LEAP, TKIP, MD5, EAP-TLS, EAP-TTLS, WPA-PSK, WPA v2.0, and PEAP
Operating Temperature	14° to 122°F (-10° to 50°C)
Charging Temperature	32° to 104°F (0° to 40°C)
Storage Temperature	-4° to 158°F (-20° to 70°C)
Humidity	95% humidity, non-condensing
Construction	High impact resistant PC/ABS housings Magnesium alloy internal chassis with component shock mounts
Drop	4 ft. (1.2m) multiple drops to concrete, all axis, across operating temperature range
Tumble	500 3.3 ft (1.0m) tumbles (1000 drops)
ESD	Air: ± 15k Vdc Direct: ± 8k Vdc
Environmental Sealing	IP54 rating
Dimensions	200 mm long x 83 mm wide x 42 mm deep (7.87" x 3.27" x 1.65") with extended battery and hand strap.
Weight	354 g (12.5 oz) with standard battery and hand strap 380 g (13.4 oz) with extended battery and hand strap
Scanner / Decode Capabilities	5300SR 2D Imager with Adaptus Technology and Laser Aimer. Decodes all standard 1D, 2D, Postal, and OCR codes. IS4813 1D laser scanner. Decodes all standard 1D codes.

Regulatory and Compliance	Safety: UL60950-1, cUL 60950, IEC 60825-1:1993+A1:1997+A2:2001, NOM-019, EN60950, CCC, PSE, EMC: FCC Part 15, Sub part B, Sub Part C, ICES-003, RSS 210, EN 55022 (CISPR 22) Class B, EN55024:1998, EN300 328, EN301 489-1, EN301 489-7, EN301 489-17, IEC 62209-2, SRRC, AIRB, ANATEL, AS/NZS4268, COFETEL
----------------------------------	--



Using the Keypad

Overview

The 28-key and 52-key keypads are as follows:

28-key keypad (numeric)

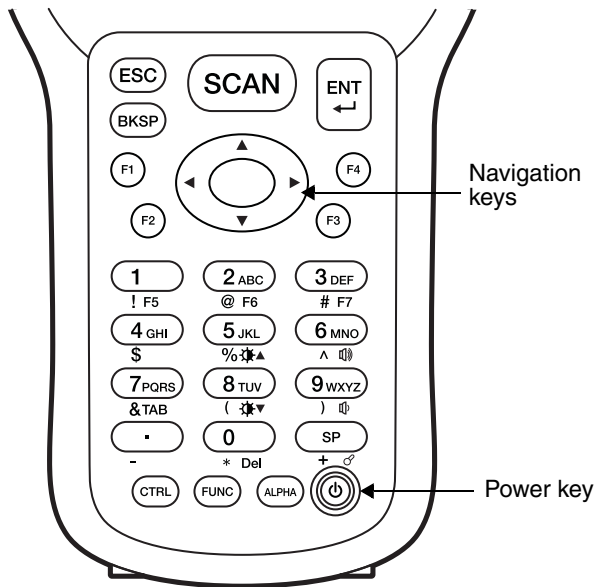

52-key keypad (full alphanumeric)

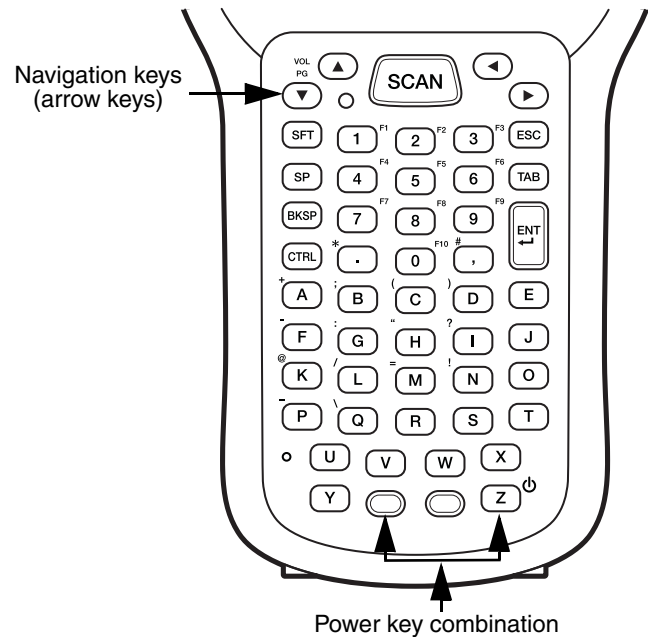

Navigation Keys

The navigation keys enable you to move the cursor up and down lines and from character to character.

Basic Keys

Name	Function
ALPHA (28-key) SFT (52-key)	Toggles the keyboard between alpha (upper and lowercase) and numeric modes on the 28-key keypad. The “ABC”/”abc” indicator on the command bar changes accordingly. Pressing SFT two times in rapid succession on a 52-key keypad toggles between upper and lowercase.
Backspace (BKSP)	Backspace moves the cursor back one space. If you are typing text, a character is deleted each time you press the backspace key.
Control (CTRL - 28-key) Blue key (52-key)	Modifies the next key pressed to type specific characters (e.g., pressing CTRL and a “2”, types an “@” sign on the 28-key keypad. Pressing the Blue key and a “k” types an “@” sign on the 52-key keypad.
Escape (ESC)	Cancels an action. For example, if you press the UP arrow on the command bar and then press the ESC key, the pop-up window disappears.
Enter (ENT)	Performs the same function as the Enter key on a workstation.
Power (Blue + Z - 52-key)	28 key: Power key suspends and resumes the terminal. 52 key: Blue + Z (Power) key suspends the terminal; just the Z (Power) key resumes the terminal.
Scan	Activates the image engine to scan a bar code or take an image.
Space (SP)	Moves the cursor one space forward. If you are typing text, it moves the text one space forward as well.

Alpha/Numeric Modes

28-key keypad: The keypad defaults to numeric mode. Use the **ALPHA** key to toggle between numeric and alpha modes. Pressing the **ALPHA** key locks the keypad in numeric mode, alpha mode (lowercase), or alpha mode (uppercase).

52-key keypad: The keypad is a full alpha and numeric keypad. Pressing the **SFT** key twice in rapid succession toggles between upper and lowercase.

The command bar on the screen displays an icon that indicates the alpha/numeric status of the keypad.



Alpha Indicators on the Number Keys

Each number key displays the characters typed when you press that key in alpha mode.

Note that when typing in alpha mode on the 28-key Dolphin 6500, you must use the same multi-press method you would use when typing letters on a phone keypad. Each key press types the next letter in the sequence as displayed by the alpha indicator.

Function Key Combinations

On the 28-key keypad, hold down the Function key (**FUNC**) and then press a key with the blue text/icons below it to perform specific functions.

28-key Key Combination	Function
FUNC + 1	F5
FUNC + 2	F6
FUNC + 3	F7
FUNC + 4	Toggle the wireless radio on and off
FUNC + 5	Increase screen brightness
FUNC + 6	Increase volume
FUNC + 7	Tab
FUNC + 8	Decrease screen brightness
FUNC + 9	Decrease volume
FUNC + .	Start menu
FUNC + 0	Delete
FUNC + SP	Align the screen (Press ESC to exit)

On the 52-key keypad, hold down the **Red** button and then press a key with the red text to the upper right of it to perform specific functions.

52-key Key Combination	Function
FUNC + 1	WordPad
FUNC + 2	Email
FUNC + 3	Windows Explorer
FUNC + 4	Internet Explorer
FUNC + 5	Pocket CMD
FUNC + 6	Control Panel
FUNC + 7	Transcriber
FUNC + 8	F8 - user programmable

52-key Key Combination	Function
FUNC + 9	F9 - user programmable
FUNC + 10	F10 - user programmable
FUNC PG	Page up or down - used in conjunction with Up and Down arrows

CTRL Key Combinations

On the 28-key keypad, hold down the Control key (**CTRL**) and then press a key with the red characters below it to type the desired character.

28-key Key Combination	Function
CTRL + 1	!
CTRL + 2	@
CTRL + 3	#
CTRL + 4	\$
CTRL + 5	%
CTRL + 6	^
CTRL + 7	&
CTRL + 8	(
CTRL + 9)
CTRL + .	- (minus)
CTRL + 0	*
CTRL + SP	+ (plus)

On the 52-key keypad, press the **Blue** button and then press a key with the blue text to the upper left of it to type the desired character. You will need to press the **Blue** key before each special character.

52-key Key Combination	Function
CTRL + A	+
CTRL + B	;
CTRL + C	(
CTRL + D)
CTRL + F	-

52-key Key Combination	Function
CTRL + G	:
CTRL + H	“
CTRL + I	?
CTRL + K	@
CTRL + L	/
CTRL + M	=
CTRL + N	!
CTRL + P	-
CTRL + Q	\
CTRL + U	Windows Explorer
CTRL + .	*
CTRL + ,	#
CTRL + VOL	Increase/decrease volume

Program Buttons

Buttons can be programmed to execute different functions using the Program Button program in the Control Panel. The following buttons on the 28-key keypad are programmed for the listed function.

Key Combination	Function
F1	WordPad
F2	Email
F3	Windows Explorer
F4	Internet Explorer



Using the Image Engine

Overview

The Dolphin 6500 houses a compact image engine using Adaptus™ Imaging Technology that instantly reads all popular 1D and 2D bar codes and supports omni-directional aiming and decoding. The image engine can also capture digital images, such as signatures and pictures.

Available Image Engines

Dolphin 6500s are equipped with 5300 Standard Range (5300SR) image engines.

Depth of Field

5300 Standard Range (5300SR)

	8.3 mil Linear	10 mil PDF417	13 mil UPC	15 mil Data Matrix	15 mil QR	35 mil MaxiCode
Working Range*:	(.020cm)	(.025cm)	(.033cm)	(.038cm)	(.038cm)	(.089cm)
Near	3.5 in. (8.9cm)	3.1 in. (7.9cm)	2.1 in. (5.3cm)	2.3 in. (5.8cm)	3.1 in. (7.9cm)	2.0 in. (5.1cm)
Far	7.6 in. (19.3cm)	9 in. (22.9cm)	13.2 in. (33.5cm)	10.2 in. (25.9cm)	8.8 in. (22.4cm)	13.0 in. (33cm)

*Data characterized at 23°C and 0 lux ambient light.

Supported Bar Code Symbologies

Symbology Type	Symbology Name
1D Symbologies	Codabar Code 3 of 9 Code 11 Code 32 Pharmaceutical (PARAF) Code 93 Code 128 EAN with Add-On EAN with Extended Coupon Code EAN-13 GS1 Databar Interleaved 2 of 5 Matrix 2 of 5 Plessey PosiCode Straight 2 of 5 IATA Straight 2 of 5 Industrial Telepen Trioptic Code GS1-128 UPC and UPC-A
2D Symbologies	Aztec Code 16K Composite Data Matrix Grid Matrix GS1 Databar Han Xin MaxiCode OCR PDF417 QR Code
Composite Codes	Aztec Mesa Codablock F EAN-UCC GS1 Databar-14
OCR	OCR-A OCR-B OCR-US Money Font
Postal Codes	Postnet and most international 4 state codes Australian Post British Post Canadian Post China Post Japanese Post KIX (Netherlands) Post Korea Post Planet Code

Activating the Engine

When a scanning application is open, press the Scan key to activate the image engine.

Using Demos

Dolphin Demos are software utilities loaded on all Dolphin terminals that demonstrate the advanced features of the terminal. There are two Demos that feature the image engine: Image Demo and Scan Demo.

To access these demos, tap **Start > Programs > Demos**.

- Select **Scan Demo** to verify decoding, or
- Select **Image Demo** to verify imaging (not available on device using the IS4813 laser engine).

For more information about Demos, refer to the Dolphin Demos User's Guide, which is available for download from www.honeywellaidc.com.

Decoding

The Dolphin terminal supports two types of image decoding: full-area imaging and Advanced Linear Decoding (ALD).

Full-area Imaging

Full-area imaging means that the Dolphin terminal supports omni-directional aiming, meaning that a positive read can be obtained from many positions. For details, see [Omni-Directional Scanning Positions](#) on page 5-4.

ALD

ALD provides fast reading of linear (1D) and stacked linear bar codes (PDF417). For the best read, the aiming pattern should be centered horizontally across the bar code. When ALD is enabled, the reader does not read matrix or postal codes.

To Decode a Bar Code

1. Tap **Start > Programs > Demos > Scan Demo**.
2. Position the Dolphin terminal over one of the sample bar codes on page 5-4. A range of 4-10 inches (10-25 cm) from the bar code is recommended.
3. Project the aiming brackets by pressing and holding the Scan key. The Scan LED lights red.
4. Center the aimer crosshair over the bar code. The aiming beam should be oriented in line with the bar code to achieve optimal decoding; [Omni-Directional Scanning Positions](#), page 5-4
5. When the bar code is successfully decoded, the decode LED lights green and the terminal beeps.

Sample Bar Codes

You can use the following bar codes to verify decoding:

Sample 128



Code 128

Sample PDF417



PDF417 Test Message

Omni-Directional Scanning Positions

The high-vis aiming pattern frames the bar code to provide you with the best scanning performance.

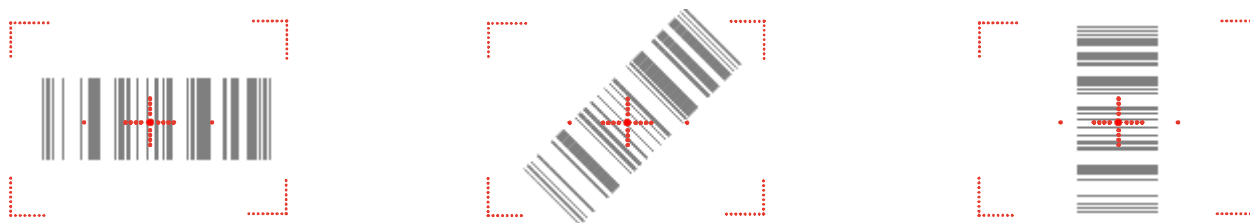

Note: To achieve the best read, the aiming beam should be centered horizontally across the bar code.

The aiming pattern is smaller when the terminal is held closer to the code and larger when the terminal is held farther from the code. Symbologies with smaller bars or elements (mil size) should be read closer to the unit whereas larger bars or elements (mil size) should be read farther from the unit.

Capturing Images

The image-capture process is an intuitive, split-second operation for experienced users. By following basic guidelines, however, new users can easily develop their own technique and, with practice, quickly learn to adapt to different application environments.

Image Preview

When the imaging process is initiated, the touch screen displays a preview of the object. This is a live video image of what the imager is currently viewing and has a slightly degraded appearance compared to the captured image. This is normal; the captured image has a higher resolution.

File Formats

The Dolphin terminal is capable of saving images in a number of industry-standard file formats (BMP, JPG and PNG). The default file format for images is a grayscale BMP.

File Size

Digital images have a maximum image size of 640 x 480 pixels and may have up to a 256 grayscale image definition. The image quality and related file size are determined by the data compression method used by the software application used to take the image. The average size of the image file is approximately 4-8K. However, the size of the image depends on image content; the more complex the content, the larger the file size.

Taking an Image

1. Tap **Start > Programs > Demos > Image Demo**.
2. Point the Dolphin terminal at the object.
3. Press the Scan key to activate the engine. The touch screen displays a preview of the object.
4. Adjust the terminal's position until the preview on the screen is as you want it to appear in the image.
5. Hold the terminal still and release the Scan key.
The touch screen flashes, and the captured image appears on the screen.
6. By default, the image is saved to the My Documents folder in My Device.
To save the image to another location, tap **File > Save As**.

High-Vis Aiming Pattern

If your Dolphin terminal is configured with the 5300SR imager, you can enable the aiming pattern for imaging in the Image Demo application.

1. Tap **Start > Programs > Demos > Imaging Demo > Setup menu > Aimer**.
2. The aiming pattern is now enabled for imaging.

Uploading Images

Image files can be transmitted to a host workstation via

- Microsoft ActiveSync and a Dolphin communication peripheral
- Wireless radio: 802.11b/g and/or Bluetooth



Using the Laser Engine

Overview

The Dolphin 6500 (IS4813 laser version) contains a laser diode that emits a beam toward an oscillating mirror that scans through the code and the reflected light is bounced off of two mirrors back to the collector. The 6500 Laser reads all popular 1D bar codes.

Available Engines

The Dolphin 6500 can be equipped with an IS4813 laser engine (depending on the configuration purchased).

Depth of Field - IS4813

	5.2 mil	7.5 mil	10.4 mil	13.0 mil	19.5 mil
Working Range*:	(25mm)	(114mm)	(160mm)	(204mm)	(225mm)
Near	2.75 in. (70mm)	2.25 in. (57mm)	2.00 in. (50mm)	2.00in. (50mm)	2.95 in. (75mm)
Far	3.75 in. (95mm)	6.75 in. (171mm)	8.25 in. (210mm)	10.00 in. (254mm)	11.81 in. (300mm)

*Data characterized at 25°C under typical indoor lighting.

Supported Bar Code Symbologies

Symbology Type	Symbology Name
1D Symbologies	China Post Codabar Codablock F Code 3 of 9 Code 11 Code 16 Code 32 Pharmaceutical (PARAF) Code 49 Code 93/93i Code 128 EAN-8 EAN-13 GS1 Composite GS1 Databar GS1 Databar Interim Coupon Bar Code GS1-128 ISBT 128 Interleaved 2 of 5 Korea Post Label Code Matrix 2 of 5 MSI Plessey PosiCode Straight 2 of 5 IATA Straight 2 of 5 Industrial TCIF Linked Code 39 (TLC39) Telepen Trioptic Code UPC, UPC-A, UPC-E

Activating the Engine

When a scanning application is open, press the Scan key to activate the laser engine.

Using Demos

Dolphin Demos are software utilities loaded on Dolphin terminals that demonstrate the advanced features of the terminal.

To access these demos, tap **Start > Programs > Demos**.

- Select **Scan Demo** to verify decoding, or

Decoding a Bar Code

1. Tap **Start > Programs > Demos > Scan Demo**.
2. Position the Dolphin terminal over one of the sample bar codes on page [6-2](#). A range of 4-10 inches (10-25 cm) from the bar code is recommended.
3. Project the aiming beam by pressing and holding the Scan key. The Scan LED lights red.
4. Center the aimer beam horizontally over the bar code and highlight all of the vertical bars of the bar code. The aiming pattern is smaller when the terminal is held closer to the code and larger when the terminal is held farther from the code. Symbologies with smaller bars or elements (mil size) should be read closer to the unit whereas larger bars or elements (mil size) should be read farther from the unit.
5. When the bar code is successfully decoded, the decode LED lights green and the terminal beeps.

Sample Bar Code

You can use the following bar code to verify decoding:



Code 128

The aiming pattern is smaller when the terminal is held closer to the code and larger when the terminal is held farther from the code. Symbologies with smaller bars or elements (mil size) should be read closer to the unit whereas larger bars or elements (mil size) should be read farther from the unit.

Communication Options

Dolphin terminals offer several communication options including Microsoft ActiveSync and wireless radios.

I/O Connector (Wired Communication)

The mechanical connector on the bottom panel (see [DC Power Jack](#) on page 3-11) connects the terminal to various Dolphin communication peripherals that connect to a host workstation via USB (1.1 or higher), thus enabling ActiveSync communication.

For more information, see [ActiveSync Communication](#) on page 7-3.

Wireless Radios (Wireless Communication)

Dolphin 6500s can be equipped with 802.11b/g and Bluetooth radios or just a Bluetooth radio.

For more information, see [Wireless Radios](#) on page 7-6.

Installing Additional Software

Dolphin terminals ship with the operating system, radio drivers, and custom Honeywell software already installed. These are the default programs that install when your terminal first boots up. You can install additional software programs on the terminal provided that the following parameters are met:

- the software program was created for a Windows CE device.
- the terminal has enough memory to store and run the program.
- the program has an EXE, CAB, or DLL extension.

When selecting programs, verify that the program and version of the program are designed for the Windows CE 5.0 and the terminal's processor. You can verify your processor by tapping **Start > Settings > Control Panel > System > General** tab. Make a note of the information in the **Processor** field.

To install additional software, you can use the communication options described in this chapter.

- [Adding Programs via ActiveSync](#), page 7-5.
- [Adding Programs from the Internet](#), page 7-7.

Connecting the USB Charging/Communication Cable for the Dolphin 6500

Slide the USB cable unit onto the bottom of the terminal lining up the terminal's I/O connector to the cable unit's connector to facilitate USB communication between the Dolphin terminal and the host workstation.

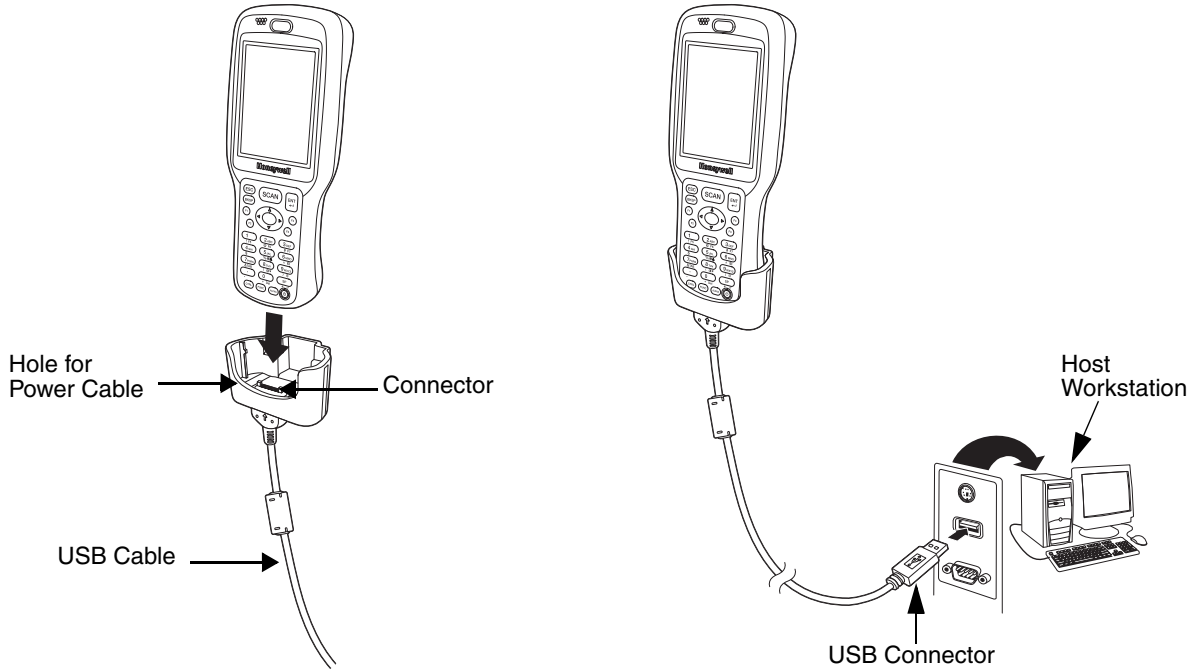

Charging Terminal with USB Cable

Not only can you communicate between the terminal and the host using the Dolphin Charging/Communication cable, but you can also trickle charge the terminal. To charge the main battery using the USB cable, select **Start > Settings > Control Panel > Battery > USB charging**. The default setting is Off. If you select the USB charging option, you can choose either 100mA or 500mA.

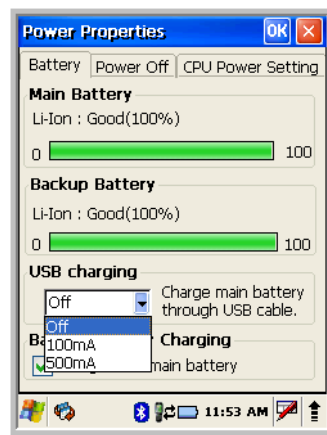

ActiveSync Communication

To synchronize, ActiveSync 4.1 or higher must be installed and configured for the appropriate communication type on the host workstation and the Dolphin terminal. Dolphin terminals ship with ActiveSync already installed. Therefore, if ActiveSync is already installed on the host workstation, you just need to connect the Dolphin terminal to the host workstation (via Dolphin peripheral) to initiate communication.

Note: You can download the most current version of ActiveSync from www.microsoft.com.



When communicating via ActiveSync, your terminal is designed to be connected to the host workstation with a Honeywell communication peripheral. We recommend use of Honeywell peripherals, power cables, and power adapters. Use of any non-Honeywell peripherals, cables, or power adapters may cause damage not covered by the warranty.

Communication Type

The Dolphin 6500 supports the following type of communication via ActiveSync through its **DC Power Jack** (see page 3-11) on the bottom panel:

USB

The USB cable and hardware peripherals allow the Dolphin terminal to communicate with a workstation through a USB port or to a network through a USB hub. The Dolphin terminal supports full-speed USB communication (USB 1.1); maximum data transfer rate is 12 Mbps. The Dolphin terminal defaults to USB communication out of the box.

Hardware Requirements for Setup

- Dolphin communication peripheral
- Dolphin power cable
- USB Cable (for USB communication)
- ActiveSync v4.1 or higher installed on the host workstation
- Windows 98 Second Edition, Windows Me, Windows 2000, Windows NT (4.0 SP6 or higher) or Windows XP computer.

Software Requirements for Communication

To sync successfully, ActiveSync must be configured for the same communication type on both the host workstation and the Dolphin terminal. ActiveSync must be setup on your workstation *before* you initiate synchronization from the terminal for the first time.

Setting Up the Host Workstation

Verify that ActiveSync is configured to use the appropriate communication type by clicking **File > Connection Settings**.

For USB communication, check **Allow USB connections**.

Setting Up the Dolphin Terminal

The Dolphin terminal defaults to USB communication out of the box. To verify and/or change the default setting, tap **Start > Settings > Control Panel > PC Connection**.

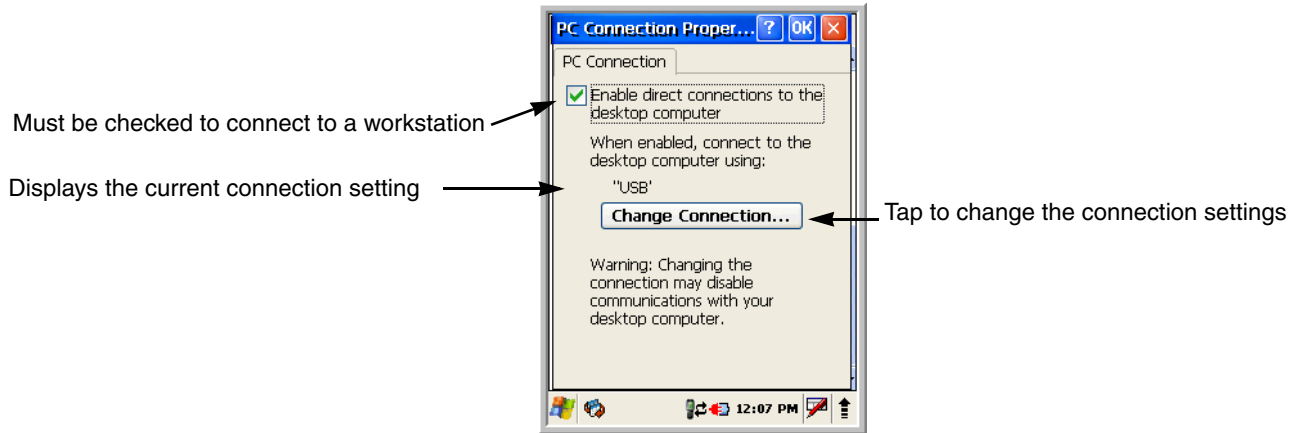

Tap **Change Connection** to change the current settings.

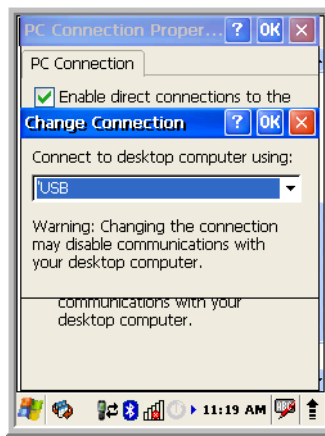

Connection Options **Select this option to ...**
'USB' Establish a USB connection.

Communicating with the Dolphin Terminal

After setting up both the workstation and the terminal, ActiveSync connection should be automatic.

1. Connect the Dolphin terminal to a communication peripheral, such as the Dolphin HomeBase.
2. The Dolphin terminal automatically opens ActiveSync to establish a connection.

Synchronizing with the Host Workstation

After setup, synchronization begins automatically whenever the terminal's mechanical connector connects to a Dolphin peripheral that is connected to a host workstation with ActiveSync installed.

Exploring the Terminal from the Workstation

When the terminal and desktop computer are connected, open the main ActiveSync window (on the desktop), and click **Explore**.

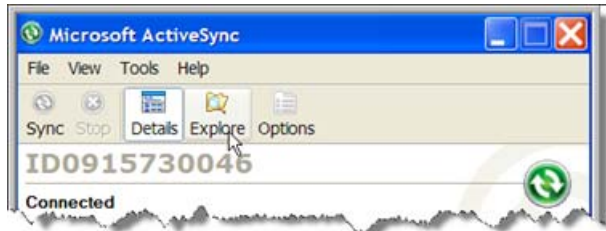

The Mobile Device folder opens in Windows Explorer.

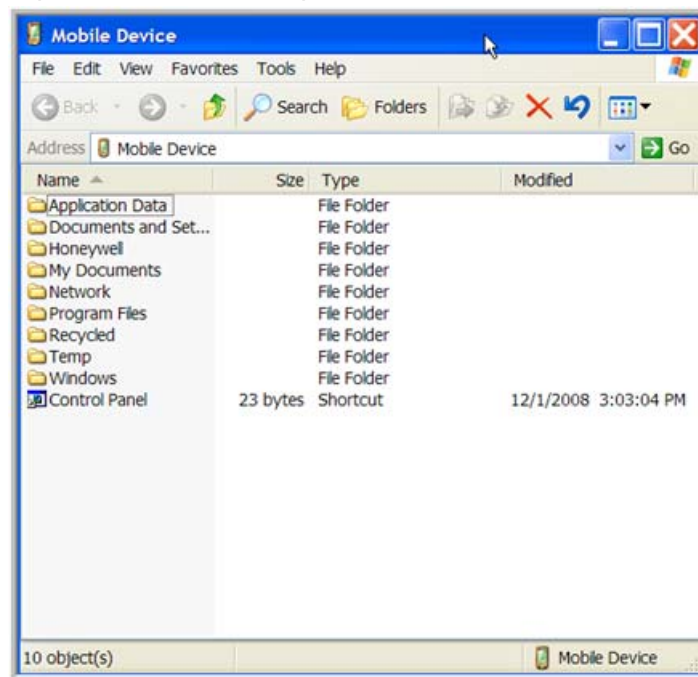

The Dolphin terminal is now treated as a mass storage device, and transferring files is as simple as dragging and dropping or copying and pasting as you would for moving files between folders on your hard drive.

Adding Programs via ActiveSync

 *When selecting programs, verify that the program and version of the program are designed for the Windows CE 5.0 and the terminal's processor. You can verify your processor by tapping Start > Settings > Control Panel > System > General tab. Make a note of the information in the Processor field.*

Generally, software for Windows CE devices must be installed to the host workstation first, then transferred to the Dolphin terminal.

1. Download the program to the workstation from either the Internet or the install CD. You may see a single *.exe or setup.exe file, a *.cab file, or *.dll. (There may also be several versions of files for different device types and processors.)
2. Read any installation instructions, Read Me files, or documentation that comes with the program. Many programs provide special installation instructions.
3. Connect the terminal to the workstation via a Dolphin communication peripheral.

If the File is an Installer

An installer program is one that installs to the workstation and the terminal simultaneously; one process installs to both devices.

1. On the workstation, double-click the *.exe or *.setup.exe file. The installation wizard begins.
2. Follow the directions on the workstation screen.
The installation process includes transferring the software to the terminal via ActiveSync.

If the File is Not an Installer

Some programs cannot be installed on workstations because they are designed exclusively for Windows CE devices. In these cases, the appropriate files must be stored on the host workstation and transferred to the terminal via ActiveSync Explore.

Note: You know that the program is not an installer because an error message stating that the program is valid but designed for a different type of computer appears when you try to install the program on the workstation.

1. If you cannot find any installation instructions for the program in the Read Me file or documentation, open **ActiveSync** on the workstation and click **Explore**.
2. On the workstation, navigate to the workstation folder containing the program file(s) and copy them to the **Program Files** folder on the terminal.
If you want the program to persist through hard resets, paste the program to the **Autoinstall** folder (\Honeywell\AutoInstall).
3. On the terminal Desktop, tap **My Device** and, in Windows Explorer, navigate to the folder where the program is located.
4. Double tap on the program file to install it.
If you copied the file to the **Autoinstall** folder, you can choose to install the program by performing a hard reset. The program installs as part of initialization.
5. After installation is complete, access the program by tapping **Start > Programs**, and the program appears on the Programs screen. Tap the icon to open the program.

Wireless Radios

There are two radio options: 802.11b/g and Bluetooth.

1. **802.11b/g** (WPAN/WLAN configuration): see [WLAN \(802.11b/g Radio\)](#), below.
2. **Bluetooth** (WPAN configuration): see [Bluetooth Handler](#) on page 8-1.

Connecting the Terminal to a Wireless Network

You connect the terminal to a wireless network through the on-board radio (802.11b/g and/or Bluetooth). Each radio has its own configuration program and requires specific information about the wireless network to connect. Successful connection depends on your network infrastructure about which you will need specific information from your network administrator.

WLAN (802.11b/g Radio)

Dolphin 6500s can have a 2.4 GHz 802.11b/g WLAN (Wireless Local Area Network) radio that uses Direct Sequence Spread Spectrum (DSSS) technology. The radio is interoperable with other 802.11b/g, Wi-Fi-compliant products including access points (APs), workstations via PC card adapters, and other wireless portable devices.

By default, the 802.11b/g radio is powered off (i.e., disabled) “out of the box.” To power it on (i.e., enable), press the vertical arrow (bottom, right corner of screen) and select **Turn Wireless LAN On**. The enable/disable state of the radio will survive subsequent soft and hard resets. The next step is to configure the connection parameters of the radio to connect to a wireless network.

Configuring the WLAN Radio

The WLAN radio is configured in the Honeywell WLAN Security Supplicant, which you access by double tapping the program icon in the command bar.

For complete configuration instructions, download the **Honeywell Secure Wireless (SWC) Client User’s Guide** from www.honeywellaidc.com. A link to this guide appears on the Dolphin 6500 product page.

Adding Programs from the Internet

When you have established a network connection (whether via Wireless LAN, Bluetooth, or ActiveSync, you can access the Internet and download additional software programs.

When selecting programs, verify that the program and version of the program are designed for Windows CE 5.0 and the terminal’s processor. You can verify your processor by tapping Start > Settings > Control Panel > System > General tab. Make a note of the information in the Processor field.

1. Open Internet Explorer and navigate to the program’s location. You may see a single *.exe or setup.exe file, or several versions of files for different device types and processors.
2. Select the program version that matches your Dolphin terminal and processor.
3. Read any installation instructions, Read Me files, or documentation that comes with the program. Many programs provide special installation instructions.
4. Download the program to the terminal directly from the Internet. You would normally store the program in the \Program Files folder unless another location is required by the program.
5. On the terminal, double tap the installer file; e.g., the *.exe file.
6. The installation wizard for the program begins.
7. Follow the directions on the screen to complete installation.



Bluetooth Handler

Bluetooth wireless technology is a short-range communications technology to connect portable and/or fixed devices while maintaining high levels of security.

Enabling the Bluetooth Radio

1. Select the **UP** arrow in the lower, right portion of the display.
2. Tap **Turn Bluetooth On**.

The Bluetooth icon appears in the task bar.

Connecting to Other Devices

Before connecting to another device, make sure that the Bluetooth connection on the other device is enabled.

1. Double tap on the Bluetooth icon in the task bar.

The Bluetooth Handler appears on the screen.

2. Tap **Scan Device**.

The available services of all devices / profiles in range display in the Bluetooth Handler.

Pairing Bluetooth Devices

Connecting Bluetooth devices usually requires that they be paired; the same passkey must be entered for each device. If you want to connect the Dolphin 6500 to a device without any input method (e.g., printers, headsets), refer to the user documentation that accompanied the device for pairing information.

1. Tap on the desired device / profile in the Bluetooth Handler.
2. Select **Trusted** from the drop down menu.

Once asked if you need to authenticate the device,

3. Tap on the **Yes** button.
4. Enter 4 random digits and tap **Yes**.
5. Enter the same digits on the other device when prompted.
6. After pairing, double tap on the selected device / profile and select **Active**.

Setting Up a Bluetooth Printer

1. Make sure that the Bluetooth printer is on and activated.
2. If not done so already, turn Bluetooth On (by selecting the vertical arrow on the Command Bar).
3. Tap **Serial** tab.
4. Tap **Scan Device**, which runs a Bluetooth Inquiry, then SDP Query.
5. If you see your Bluetooth printer device displayed, you can tap **Cancel** to stop the search.

OR

Wait until all Bluetooth devices in range have been scanned. Then the **Scan Dialog** window appears.

6. Scroll through the list until your Bluetooth printer device is found. You may single tap any device in the list to display its MAC address.
7. Highlight the Bluetooth printer device and tap the **Select** button.
8. When the COM port selection appears, select **COM7** and tap **OK**.
9. If successful, the COM port and MAC address of the device appears under the list of **Registered Bluetooth Virtual COM ports**.
10. Tap **OK** to exit the Bluetooth Handler.
11. One of the ways to test the connection to the printer is to follow the steps below:
 - a. Select **Start > Programs > Demos > Print Demo**.
 - b. Tap **Zebra (BT) Barcodes Print**.
 - c. If successful, the barcode prints.

Setting Up a Connection to a Mobile Phone

You can use a GSM mobile phone as a modem to connect to the Internet using GPRS (General Packet Radio Service) data connection.

Prior to connecting the Dolphin 6500 to a mobile phone, contact your mobile phone service provider about the GPRS configuration, coverage, and fees. Also consult the user documentation for your mobile phone to determine if your phone supports GPRS data transfer and if it has an available Bluetooth connection. If your phone supports 3G data transfer, you should be able to connect the Dolphin 6500 to your phone.

1. Determine if your phone is configured and connected to GPRS.
2. Activate your mobile phone's Bluetooth feature.
3. Select **Start > Settings > Network and Dial-up Connections**.
4. Double tap on **Make New Connections**.
5. Choose **Dial-up Connection** and select **Next**.
6. Select **Bluetooth**.
7. Select and activate the data modem service for your phone (refer to [Pairing Bluetooth Devices](#) (page 8-1) and press **OK**).
8. Select the data modem service from step 7 from the **Select a Modem:** drop down menu.
9. Enter a dial-up phone number. (Contact you mobile network services provider for additional information about connecting the Internet using your mobile phone.)
10. Tap **Finish**.

Dolphin HomeBase/eBase Device

Overview

Note: The information in this chapter applies to both the Dolphin HomeBase and Dolphin eBase devices unless otherwise indicated.

As the hub of your Dolphin 6500 system, the Dolphin HomeBase charging and communication cradle supports full-speed USB 1.1 and RS-232 communication with a workstation. The Dolphin eBase is identical to the Dolphin HomeBase except it supports Ethernet communication as well as USB 1.1, and RS-232.

Communication

The base can communicate via USB or serial RS-232 (or Ethernet for the eBase). Data transmission for USB is up to 12 Mbps. Data transmission for serial RS-232 is up to 115 Kbps.

These bases cannot be physically connected to each other—sometimes referred to as “daisy-chaining”—but can be networked together via serial or USB hubs.

Battery Charging

The base completes a full charge of a fully depleted main battery pack in an average of 5 1/2 hours. It takes less time if the battery has some charge.

In addition to charging, the base powers the terminal's intelligent battery charging system, which protects the battery from being damaged by overcharging. The terminal senses when a battery pack is fully charged and automatically turns off the charger. If the battery voltage drops below the charge threshold, the charger turns on again to maintain the battery at full capacity. As a result, Dolphin terminals may be stored in the base indefinitely without damage to the terminals, battery packs, or peripherals. For prolonged storage, see [Storage Guidelines](#) on page 3-14. The base can also charge a second battery while the terminal is positioned in the base. See [Charging a Spare Battery](#) on page 9-6.

Power Supply

The power cable that ships with each terminal also powers the base.



We recommend use of Honeywell peripherals, power cables, and power adapters. Use of any non-Honeywell peripherals, cables, or power adapters may cause damage not covered by the warranty.



We recommend use of Honeywell Li-Ion battery packs. Use of any non-Honeywell battery may result in damage not covered by the warranty. DO NOT attempt to charge damp/wet mobile computers or batteries. All components must be dry before connecting to an external power source.

Front Panel

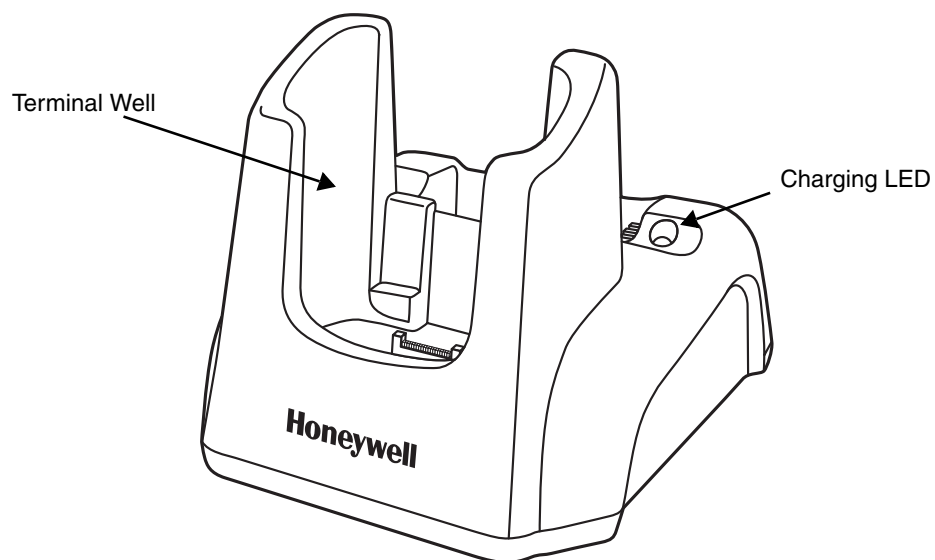

Terminal Well

Place the Dolphin terminal in the terminal well to communicate with a host device, power the terminal, and charge the terminal's battery. Make sure that the device is securely seated.

Rubber Feet

The bottom panel has four rubber feet to stabilize the unit on a flat surface. You can set the base on a dry, stable surface, such as a desktop or workbench near an electrical outlet.

Back Panel

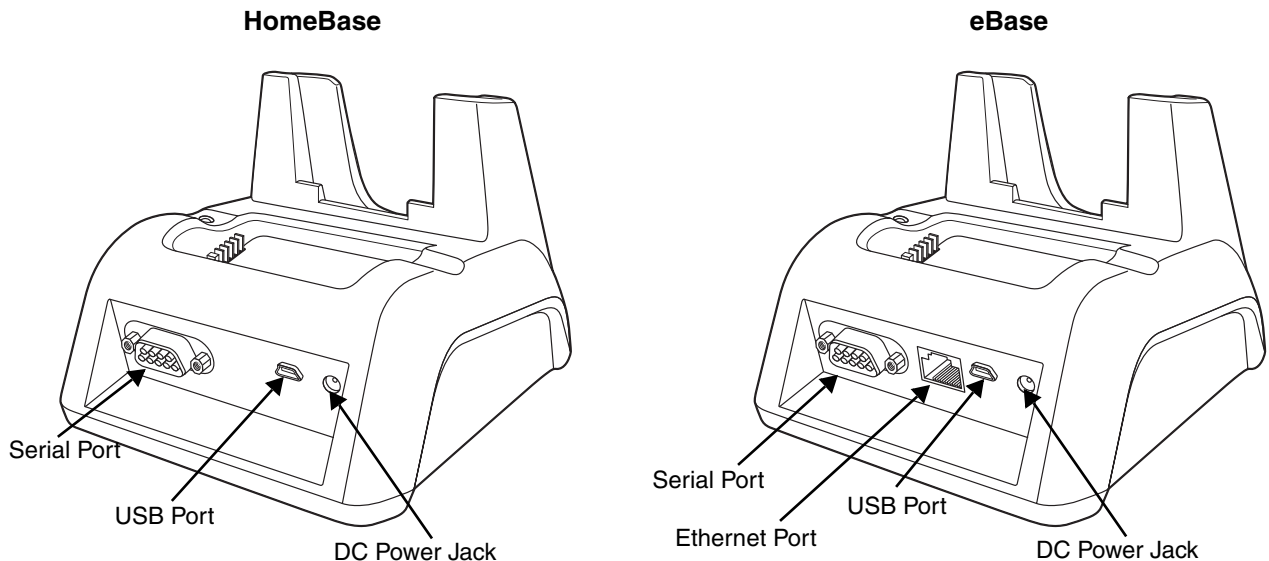

DC Power Jack

Connect the power cable to this power jack; see [Powering the Dolphin HomeBase Device](#) on page 9-4.

USB Port

The USB port is full-speed (v1.1). Using the USB cable, you can connect the base to a USB-compliant device to facilitate USB communication to and from the terminal. USB communication occurs through Microsoft ActiveSync (v.4.1 or higher). For more information about ActiveSync setup, see [ActiveSync Communication](#) on page 7-3.

Serial Port

The serial port supports serial communication between the terminal and another device. Note that the connector is a DB9 Male connector, requiring a female connector on the serial cable. The following four signals are supported:

- Transmitted Data
- Received Data
- Request to Send
- Clear to Send

Note: ActiveSync is not supported over the serial port.

Ethernet Port (eBase only)

Using an Ethernet cable, you can connect the eBase to an Ethernet-compliant device to facilitate Ethernet communication to and from the terminal. This equipment is for indoor use only. The communication wiring is limited to the inside of a building.

Powering the Dolphin HomeBase Device

The terminal requires 5 volts DC input for communication and battery charging; the power adapter on the power cable converts the voltage from the power source to 5 volts DC. Only power adapter cables from Honeywell convert the voltage appropriately.

The same power cable that ships with each terminal can be used to power the base. This cable contains a plug adapter for each geography (US, UK, EU, etc.).

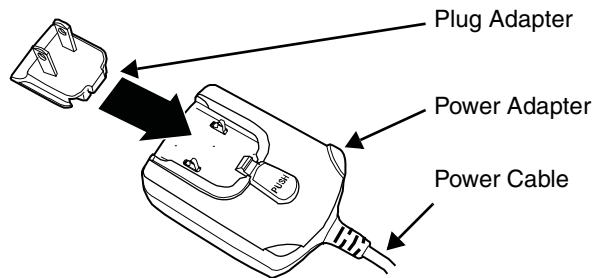

1. Attach the appropriate plug adapter to the power adapter.
2. Plug the power cable into the power source.
3. Plug the connector into the DC power jack on the back panel. The base is now powered.

When a terminal is properly seated, the base powers the terminal, charges the terminal's main battery pack, and launches ActiveSync (see [ActiveSync Communication](#) on page 7-3).

Honeywell recommends that you leave the base connected to its power source at all times, so that it is always ready to use.

eBase Clamp-on Ferrite Core Installation

We recommend that you install the clamp-on ferrite core included with your Dolphin® eBase on your Ethernet cable. *Installation of the ferrite is required to meet the declared FCC emission levels.*

The following illustration shows how to install the ferrite on the cable. It should be placed approximately 1.57 inches (40mm) from the RJ45 plug. The cable should be looped around the core, as shown.

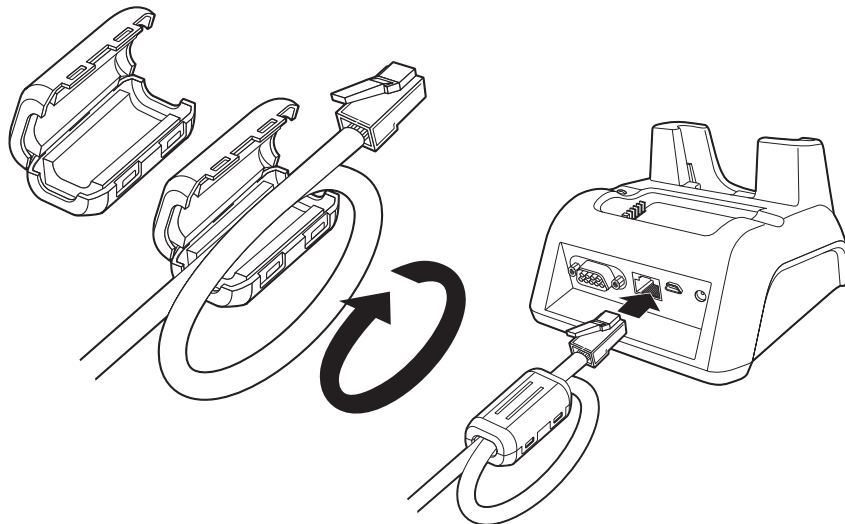

Charging the Main Battery

The base powers the terminal and fully charges its main battery pack in an average of 5 1/2 hours for a fully depleted battery. It takes less time if the battery has some charge.

As battery packs charge, the charging circuitry follows the two-step charging process (CC-CV) that is recommended for Li-Ion batteries. The process monitors changes in temperature, current, and voltage.

Inserting a Terminal

1. Install the battery pack in the terminal; see [Install the Main Battery](#) on page 2-1.
2. Power the base; see [Powering the Dolphin HomeBase Device](#) on page 9-4.
3. Slide the terminal into the terminal well making certain that the terminal is seated properly.
4. The battery pack begins charging.



Make sure the terminal is dry before placing it in the base.
Do NOT place a wet terminal in the base! Doing so may cause damage not covered by the warranty.

Charging a Spare Battery

The base can also charge a second battery while the terminal is positioned in the base. The second battery can be inserted in the battery charging well in back of the terminal connection. Place the battery in the well with the label facing up and toward the back of the unit. Angle the battery as shown. Once the connectors engage, the LED lights. If the LED is red, the unit is charging; if it is green, the charge is complete.

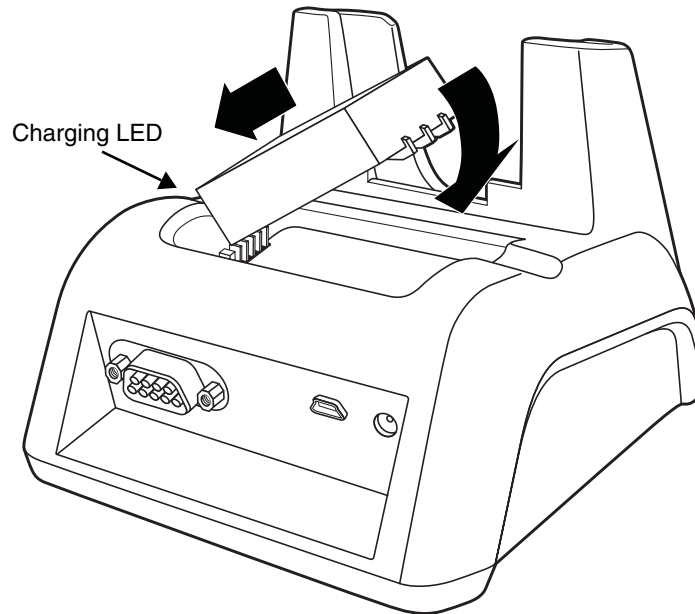

Checking Battery Power

To check battery power while the terminal is operating, tap **Start** > **Settings** > **Control Panel** > double tap **Power**.

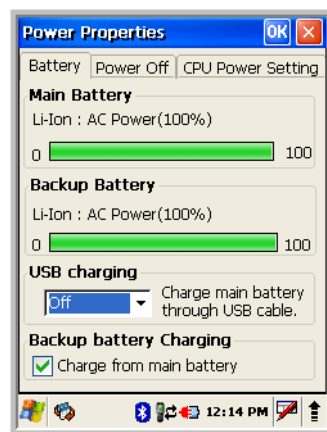

Technical Specifications

Structural	
Dimensions	5.3 in. high X 4.5 in. wide X 3.1 in. deep (13.5 cm. X 11.4 cm. X 7.9 cm.)
Weight	Dolphin HomeBase - 11.0 oz. (313g) Dolphin eBase - 11.3 oz (320g)
Material	Polycarbonate
Color	Black
Environmental	
Operating Temperature	14° to 122°F (-10° to +50°C)
Storage Temperature	-4° to 158°F (-20° to +70°C)
Charging Temperature	32° to 104°F (0° to 40°C)
Electrical Static Discharge	Air: ± 15k Vdc Direct: ± 8k Vdc
Humidity	90% relative humidity (non-condensing)
Power Supply	
Input (Universal) (from the power source)	100–240 Volts, 0.3 A 50–60Hz Included with Dolphin terminal
Output (to the base)	5 Volts DC, 2.0 A
Charging	
Standard Charge	3300mAh - 5 1/2 hours for a fully depleted battery
Max Charging Current	1.8A Max
Standby Current	<100mA
Status LED	Green: charged Red: charging
Communication	
Interface	USB Mini-B Male connector supports data transmission of up to 12 Mbps OR Standard DB9 serial connector supports data transmission up to 115 Kbps
Agency Approvals	
Power Supply:	UL listed TUV licensed Power Supply compliant to FCC part 15, Class B
Charging:	CE Marking (EMC) CISPR Pub 22
Fire Retardant:	UL 94-VO



Dolphin QuadCharger Device

Overview

The Dolphin QuadCharger device is a four-slot charging station that charges up to four Li-ion battery packs in an average of 5 1/2 hours for a fully depleted battery. It takes less time if the battery has some charge. For more details about charging, see [Battery Charging](#) on page 10-2.

 We recommend use of Honeywell peripherals, power cables, and power adapters. Use of any non-Honeywell peripherals, cables, or power adapters may cause damage not covered by the warranty.

 We recommend use of Honeywell Li-Ion battery packs. Use of any non-Honeywell battery may result in damage not covered by the warranty. **DO NOT** attempt to charge damp/wet mobile computers or batteries. All components must be dry before connecting to an external power source.

QuadCharger Device

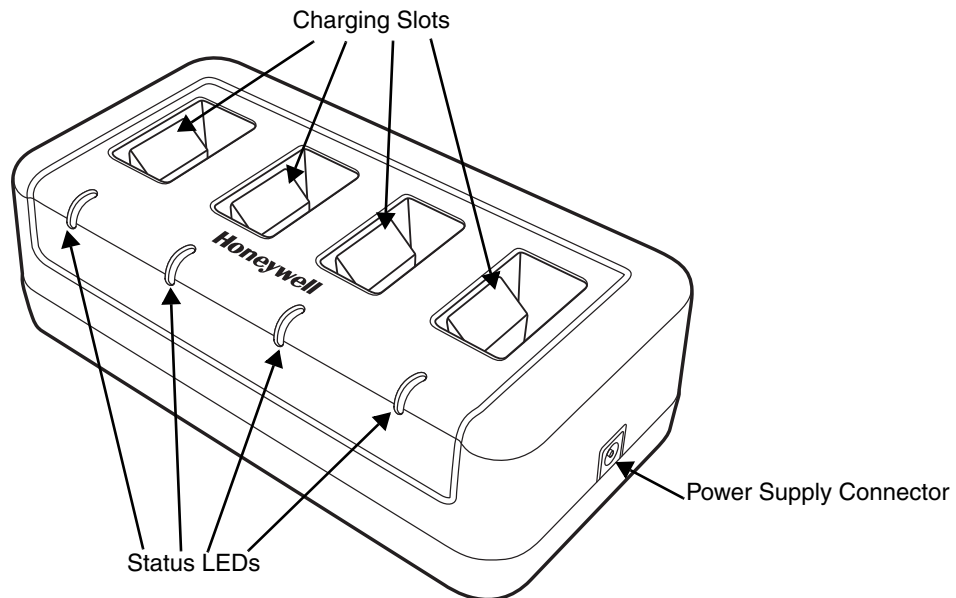

Charging Slots

The charger contains four charging slots. Each slot holds one battery. When a battery is placed in a slot, it immediately begins charging and its Status LED lights.

Status LEDs

A status LED is located at the end of each of the four battery slots. The color of the LED indicates the charge status of the battery in the slot.

Green The battery has completed its charge cycle and is ready for use.
Red The battery is charging.

Power Supply Connector

Use this connector to attach the power supply to the charger. The universal power supply accepts input voltages between 90–265 volts.

Battery Charging

Charging Process

This charger charges Dolphin 6500 Li-Ion 3300mAh packs in an average of 5 1/2 hours for a fully depleted battery. It takes less time if the battery has some charge. Each charging slot works independently of the other three. As battery packs charge, the charging circuitry follows the two-step charging process (CC-CV) that is recommended for Li-Ion batteries. The process monitors changes in temperature, current, and voltage.

Temperature

The six-hour charge time applies when batteries are charged within the recommended temperature range of 50° to 95° F (10° to 35°C). Temperature has a significant effect on charging. For best results, battery packs should be at room temperature before inserting in the charger.

 When the battery temperature exceeds 40°C, the charger may exceed the stated six-hour charge time. The charger stops charging if the battery temperature is greater than 40°C, but will begin charging again when the battery temperature is less than 40°C.

Charging Batteries

1. Supply the charger with power.
2. Insert batteries into the appropriate slots.
The Status LED for each slot turns red to indicate that the battery is properly seated and has begun a charge cycle.

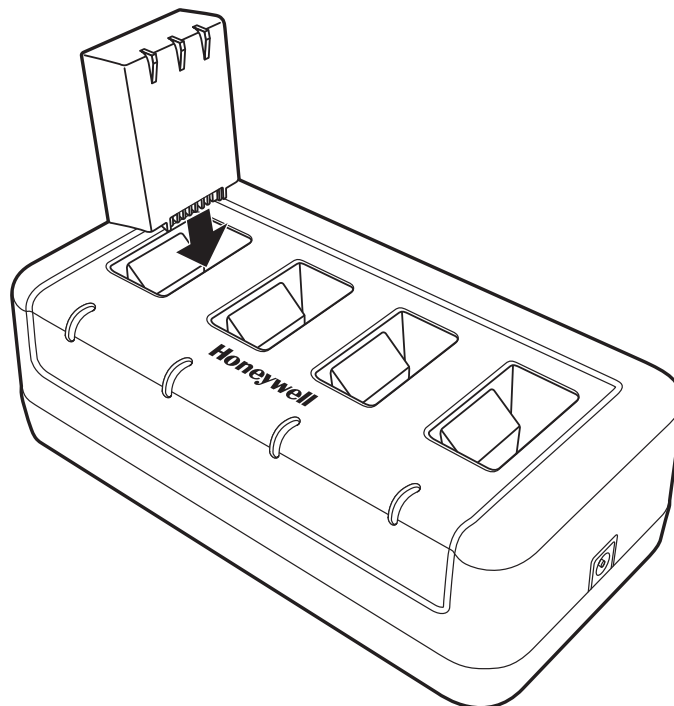

3. When the Status LED turns green, the battery in the slot has completed charging.

Recommendations for Storing Batteries

To maintain top performance from batteries, follow these storage guidelines:

- Avoid storing batteries outside of the specified temperature range of -4 to 104°F (-20 to 40°C) or in extremely high humidity.
- For prolonged storage, it is recommended that the battery be at a 40% - 50% charge level, be removed from the device, and stored in a controlled temperature environment. Following these recommendations will maximize battery life.

Troubleshooting

If you encounter problems with the charger, refer to chart below for possible solutions. If problems persist, contact [Technical Assistance](#) (see page 13-1).

Problem	Issue
The Status LED does not come on when I insert a battery pack into a slot.	Check the power connections to the device; make sure the battery pack is properly seated.

Technical Specifications

Structural	
Dimensions	7.3 in. long X 3.7 in. wide X 2.4 in. high (18.5 cm. X 9.4 cm. X 6.1 cm.)
Weight	11.5 oz. (325g)
Material	Case: Polycarbonate Color: Black
Capacity	Supports up to four Li-Ion battery packs
Environmental	
Operating Temperature	32° to 104°F (0° to 40°C)
Storage Temperature	-4° to +140°F (-20° to +60°C)
Charging Temperature	32° to 104°F (0° to 40°C)
Electrical Static Discharge	Air: ± 15k Vdc Direct: ± 8k Vdc
Humidity	90% relative humidity (non-condensing)
Power Supply	
Input (Universal)	100V-240V, 1.2 A 50-60Hz Included
Output	5Volts DC, 4.0 A
Charging	
Standard Charge	3300mAh - 5 /12 hours for a fully depleted battery
Status LEDs	Green: charged Red: charging
Agency Approvals	
Power Supply	UL listed TUV licensed Power Supply compliant to FCC part 15, Class B
Charging	CE Marking CISPR Pub 22
Fire Retardant	UL94 V-0

Dolphin 6500 Net Base Device

Overview

The Net Base enables up to four Dolphin 6500 mobile computers to communicate with a host device over an Ethernet network. In addition, the Net Base provides a second RJ45 Ethernet port for connection to an additional device such as a printer, workstation, eBase, or another Net Base.



We recommend use of Honeywell peripherals, power cables, and power adapters. Use of any non-Honeywell peripherals, cables, or power adapters may cause damage not covered by the warranty.

Unpacking the Net Base

Open the shipping box and inspect the package to see that the following standard items are included:

- One Dolphin Net Base Ethernet cradle
- One universal AC/DC power adapter for the Dolphin Net Base
- One power cord

You will also need to provide a standard CAT-5 Ethernet network cable. These items are needed to set up and operate the Net Base. If any items are missing or anything appears to be damaged, contact your Customer Account Representative.

Keep the original packaging in case you need to return the Net Base for service or to store the Net Base while not in use.

Charge Time

The base supplies power to the intelligent battery charging system in all Dolphin terminals, which senses when a full charge has been achieved and switches to a trickle charge to maintain the full charge.

As battery packs charge, the charging circuitry follows the two-step charging process (CC-CV) that is recommended for Li-ion batteries. The process monitors changes in temperature, current, and voltage. The main battery of each terminal charges in 4 hours for the standard 3.7V battery or 6 hours for the extended 3.7V battery.

Convenient Storage

Intelligent battery charging makes this base a safe and convenient storage receptacle for your Dolphin terminal.

Capacity

The base can hold up to 4 Dolphin terminals. Each charging well charges each terminal independently of the other wells.



We recommend use of Honeywell Li-ion battery packs. Use of any non-Honeywell battery may result in damage not covered by the warranty.



We recommend use of Honeywell peripherals, power cables, and power adapters. Use of any non-Honeywell peripherals, cables, or power adapters may cause damage not covered by the warranty.

Parts and Functions

Front Panel

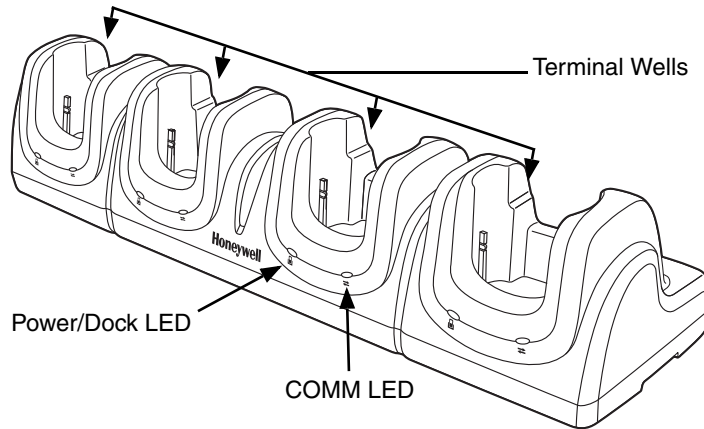

Terminal Wells

The Net Base contains four terminal wells. Each well has its own dedicated Power/Dock LED and COMM LED indicator.

Place the Dolphin terminal in any one of the four wells to communicate with a host device, power the terminal, and charge the installed battery pack. The Net Base completely charges the main battery in a Dolphin terminal in 4 hours for the standard 3.7V battery or 6 hours for the extended 3.7V battery.

Power/DOCK LED

Indicates if power is supplied to the Net Base and if a terminal is docked properly in the terminal well. Each terminal well has its own dedicated Dock LED.

This color means...

Red The Net Base has power but no terminal is docked.

Green The Net Base has power and the terminal is properly seated in the base.

COMM LED

The COMM LED indicates the status of connection and data transfer between the Dolphin terminal and the Net Base. Each terminal well has its own dedicated COMM LED.

When the Dolphin terminal is docked:

This color and status means...

Green Solid A connection has been established between the Dolphin terminal and the Net Base.

Green Flashing Data transfer in progress.

Note: The COMM LED does not necessarily indicate the Net Base and terminal are connected to a valid Ethernet link. For more information, see [RJ45 Ethernet Ports](#) on page 11-3.

Back Panel

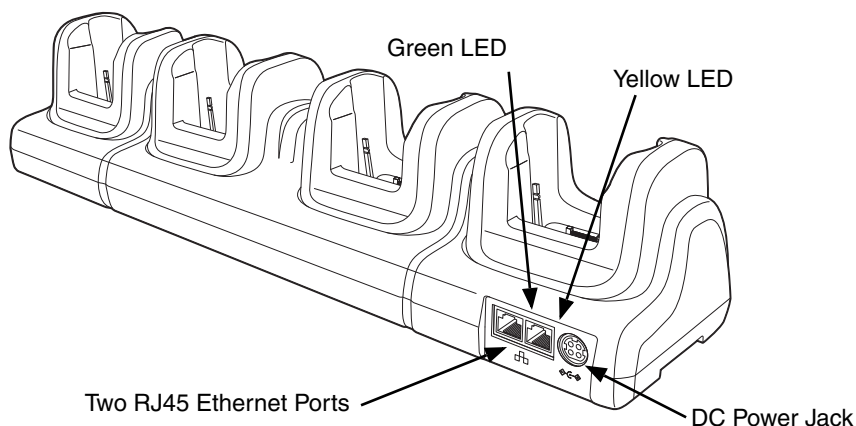

DC Power Jack

Use the power cable from Honeywell that comes with the Net Base to supply power to this power jack. For more information, see [Power](#) on page 11-4.

RJ45 Ethernet Ports

The Net Base contains two RJ45 Ethernet ports. You can connect the Net Base to an Ethernet-compliant device to facilitate Ethernet communication to and from the terminal by plugging a standard CAT-5 Ethernet cable into one of the two Ethernet ports provided. The second RJ45 Ethernet port can be used for connection to an additional device such as a printer, workstation, eBase, or another Net Base.

Note: The Net Base does not use a Spanning Tree Protocol (STP). When both RJ45 Ethernet ports are used, do not connect both Net Base interfaces to the same layer 2 LAN.

Each Ethernet port has a dedicated green and yellow status LED.

This color	and status	means...
Green	Flashing	Data transfer is in progress.
	Solid	A connection has been established between the Net Base and the Ethernet.
Yellow	Solid	Ethernet is connected at 100T.
	Off	Ethernet is connected at 10T.

Note: The terminal and Ethernet link must be set up properly to allow the terminal to communicate to other devices and/or the Internet. For more information, see [Connecting the Dolphin Terminal to the Net Base](#) on page 11-5.

Bottom Panel

For details on how to mount the Net Base, see [Mounting the Net Base](#) on page 11-6.

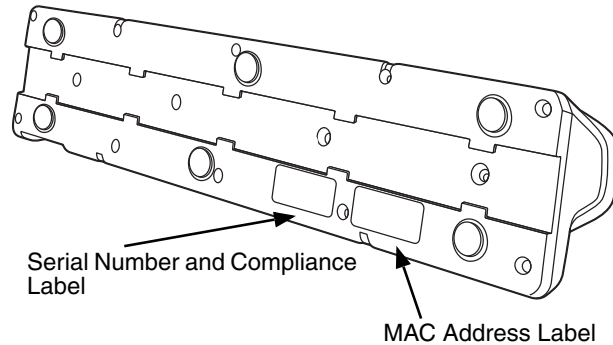

Power

The terminal requires 12 Volts DC input for communications and battery charging; the power adapter on the power cable converts the voltage from the power source to 12 volts DC. **Only** the Honeywell 12V/ 8.5A power supply provided with the Net Base converts the voltage appropriately. The operating temperature range is -10° to 50°C (14° to 122°F).

Honeywell recommends that you leave the Net Base connected to its power source at all times, so that it is always ready to use.



We recommend use of Honeywell peripherals, power cables, and power adapters. Use of any non-Honeywell peripherals, cables, or power adapters may cause damage not covered by the warranty.

Connecting Power to the Net Base

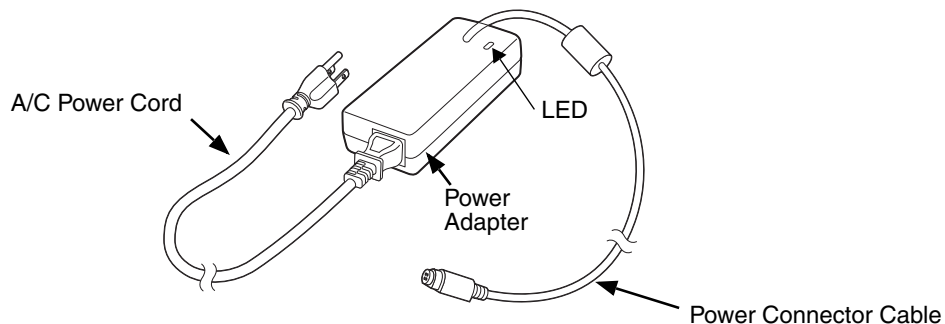

1. Plug the A/C power cord into the power adapter.
2. Plug the power connector cable into the power connector on the back of the Net Base.
3. Plug the A/C power cord into a standard wall outlet. The LED on the Power Adapter illuminates to indicate power.
4. All four Power/Dock LEDs illuminate solid red to indicate the base has power. Terminal wells with properly docked Dolphins indicate power with a green LED.
5. The base is ready to begin charging terminals.

Charging the Main Battery

The base provides power to the Dolphin terminals and allows the charging of the main batteries in the terminals. The main battery of each terminal charges in 4 hours for the standard 3.7V battery or 6 hours for the extended 3.7V battery. The intelligent battery charging system incorporated into all Dolphin terminals prevents overcharging, which means that Dolphin terminals may be stored in the base indefinitely without damage to the terminals, battery packs, or the base.

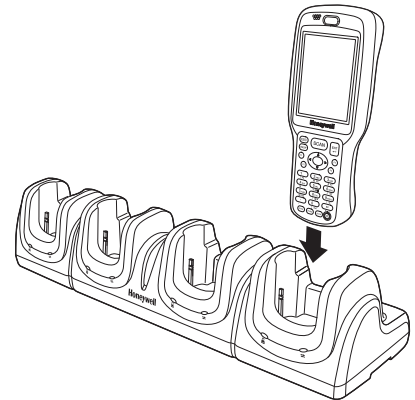

To Power a Terminal and Charge its Main Battery

1. Install the main battery pack in the terminal; see [Install the Main Battery](#) on page 2-1.
2. Verify the base has power. If the Power/Dock LEDs are not illuminated, see [Connecting Power to the Net Base](#) on page 11-4.
3. Slide the Dolphin terminal into one of the four terminal wells. The the Power/Dock LED for the well changes to green. Charging begins immediately if required by the Dolphin terminal.



Make sure the terminal is dry before placing it in the Net Base. Do NOT place a wet terminal in the Net Base! Doing so may cause damage not covered by the warranty.



We recommend use of Honeywell Li-Ion battery packs. Use of any non-Honeywell battery may result in damage not covered by the warranty.

Communication

Software Requirements

Before you connect the Dolphin terminal to the Net Base, make sure you have the most current software installed. To check the terminal's system information, tap **Start > Programs > Power Tools > SysInfo**.

- The Kernel version must be 28.04 or later in terminals running Windows Embedded Handheld 6.5 Classic.
- In terminals running Windows CE 5.0, the kernel version must be 23.08 Service Pack 8 or later.



Applications on the Dolphin Terminal

Applications running on the Dolphin terminal when it is connected to the Net Base should be designed specifically for a partially connected network. For more details, please refer to the *Best Practices for Partially Connected Networks* document available at www.honeywellaidc.com.

Connecting the Dolphin Terminal to the Net Base

By default, the Dolphin terminal is configured to obtain IP addresses automatically using a DHCP server. This means that in most cases, you would simply plug-and-play the unit.

1. Verify the base has power. If the Power/Dock LEDs are not illuminated, see [Connecting Power to the Net Base](#) on page 11-4.
2. Plug the CAT-5 Ethernet cable into one of the RJ45 connectors on the back of the Net Base.

-
3. Plug the Ethernet cable into the network.
 4. Insert the Dolphin into one of the terminal wells. The DOCK LED for the well changes from red to green and the connection icon on the Dolphin's title bar changes from  to .
 5. By default, the DHCP server assigns a unique IP address to each of the Dolphin terminals docked in the Net Base. This IP address can be used by any application on the Dolphin terminal.

Note: Instead of using the default for DHCP assigned IP addresses, the Dolphin terminal can use a statically assigned IP address. See standard Microsoft Windows Mobile documentation for how to assign a static IP address to a network adapter. In this case, set a static IP address for the adapter named "SMC95001 USB2.0 FAST Ethernet Drive".

Displaying the Net Base Terminal Well and Dolphin IP Address

Once the Dolphin terminal establishes communication, it uses the unique IP address assigned to the terminal well it is docked in on the Net Base. If four Dolphin terminals are successfully connected, then four different IP addresses are assigned to the adapter associated with the Dolphin terminal.

1. Tap **Start > Programs > Power Tools > Network Utilities > IPConfig**.
2. Change the **Adapter** to SMC95001.
3. On the Input tab, tap the **Display full configuration** button.
4. The Dolphin terminal retrieves and displays the IP configuration for the entire Dolphin terminal and the Net Base terminal well where the Dolphin is docked.
5. Locate the **IpAddress** field in the IP configuration list.

Mounting the Net Base

Set the Net Base on a dry, stable surface, such as a desktop or workbench near an electrical outlet. Be sure to provide enough workspace with good lighting for the user to view and operate the Dolphin terminal while it is in the Net Base. When choosing a location, bear in mind that the mounting location must allow users easy access to the terminal wells, the Ethernet ports, and the power jack.

Bottom Panel

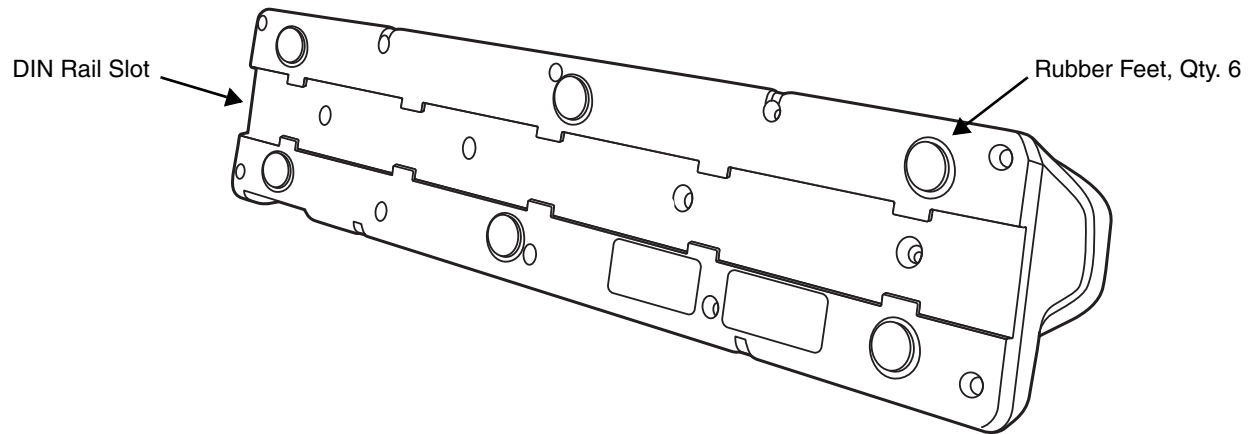

Desk Mounting

The DIN Rail (7.5 X 35 mm) slot on the bottom panel enables secure mounting on a horizontal surface.

Hardware Required

- 3/16 in. dia x 5/8 in. long pan head screw
- 1/2 in. OD x 7/32 in. ID x 3/64 in. thick
- 3/16 in. dia nut

Installing the DIN Rail

1. Slide the DIN Rail into the DIN Rail slot on the bottom panel of the base.

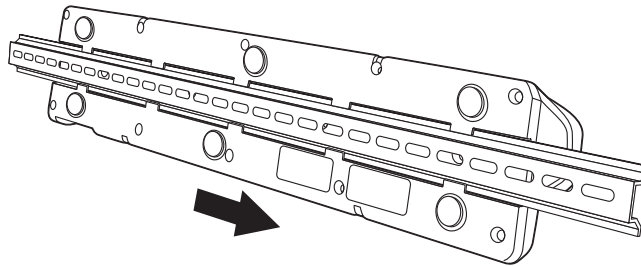

2. Turn the base and DIN Rail right side up.

-
- Then, using the appropriate nuts and bolts, secure the DIN Rail to a stable, flat horizontal surface.

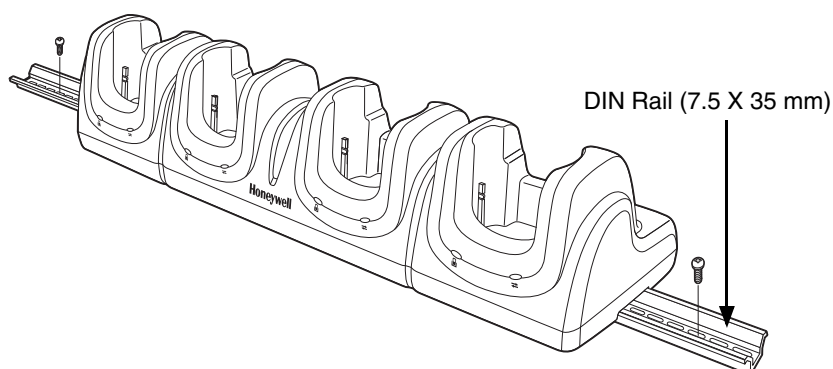

Wall Mounting

The optional wall mount bracket enables secure mounting of the base on a vertical surface. The wall mount bracket can be used in conjunction with the DIN rail but does not require the DIN Rail for use.

Hardware (Provided)

- M3 x 9 mm self-tapping screws, #2 Phillips, Qty. 4
- 3/8 in. x 4 in. round head toggle bolt, 2-5/8 in. usable length, Qty. 4
- 3/8 in. x 2 1/2 in. length Hex Head Lag Screw, Qty. 4

Tools Required

- Drill
- 7/8 in. Drill Bit (for hollow wall installations) or
1/4 in. Drill Bit (for wood stud installation)
- Phillips Screw Driver

Hollow Wall Installation

- Drill four pilot holes in the wall using a 7/8 in. drill bit.

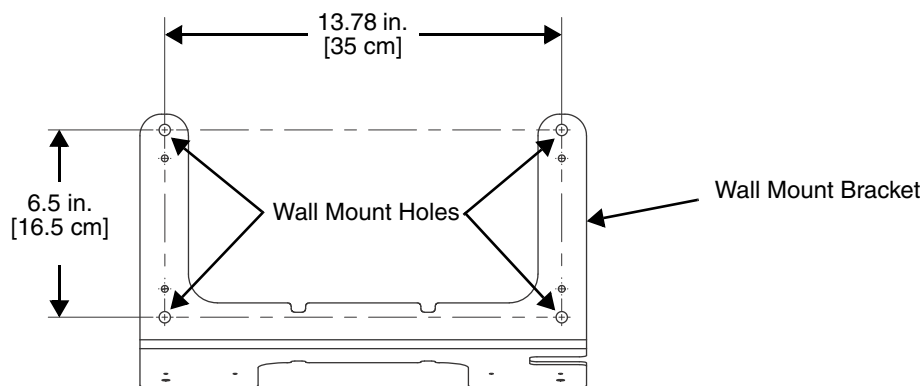

-
- Slide the bolt through the wall bracket, and thread the toggle nut onto the bolt.
 - Press the ends of the toggle nut together, and insert the bolt/nut into the pilot hole until the nut clears inside wall surface. The toggle nut should spring open preventing the screw from being removed.
 - Repeat steps 2 and 3 for each of the remaining mounting holes.
 - Tighten all four bolts to secure the bracket to the wall.
 - Once the bracket is installed, secure the base to the wall bracket, see [Securing the Base to the Wall Bracket](#) for detailed instructions.

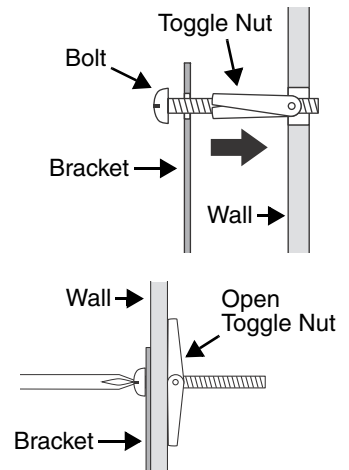

Wood Stud Installation

- Drill four pilot holes in the wall/wood stud using the 1/4 in. drill bit.
- Secure the bracket to the wall using the four Hex Head Lag Screws provided.
- Once the bracket is installed, secure the base to the wall bracket, [Securing the Base to the Wall Bracket](#) for detailed instructions.

Securing the Base to the Wall Bracket

You can secure the base to the wall bracket using the optional DIN rail.

Hardware Required

- DIN Rail, Qty. 1
- 3/16 in. dia x 5/8 in. long pan head screw, Qty. 2
- 1/2 in. OD x 7/32 in. ID x 3/64 in. thick washer, Qty. 2
- 3/16 in. dia nut, Qty. 2

- Position the DIN Rail on the wall bracket, as shown below.
- Slide the screw through the slot on the DIN Rail and the mounting hole in the bracket.

-
3. Slide the washer onto the screw and tighten the nut to secure the assembly.

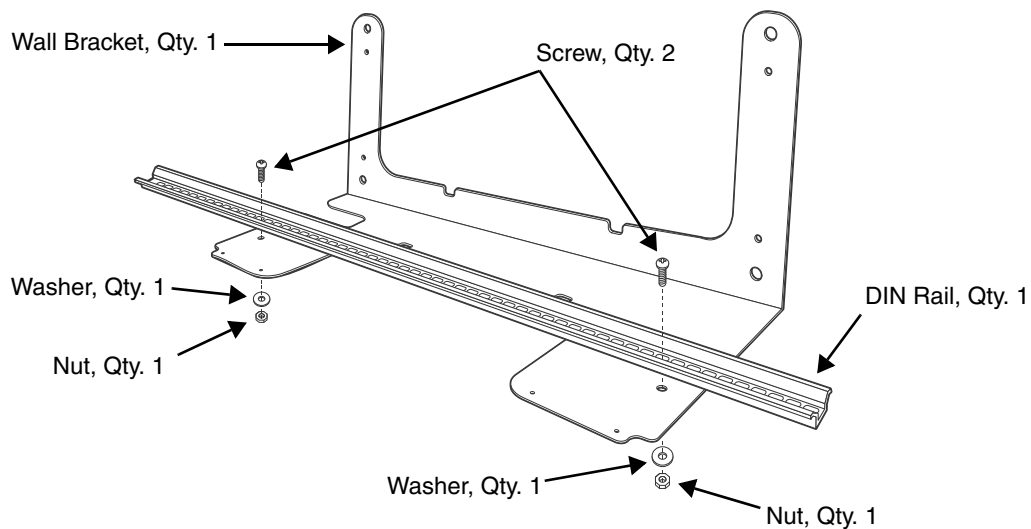

4. Remove the rubber feet on the bottom of the Net Base.
5. Slide the base onto the DIN Rail using the slot on the bottom of the base.

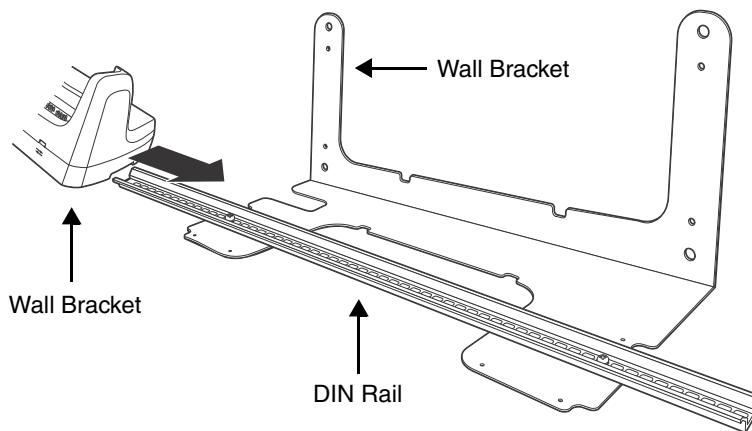

Dolphin 6500 Slide-On Handle

Overview

The optional slide-on handle provides a productivity-enhancing solution for applications that require high volume scanning, such as inventory management and stock replenishment.

Removing the Hand Strap

Prior to installing the Dolphin 6500 handle on the terminal, you must remove the hand strap.

1. Release the hook and loop portion of the strap and feed it through the opening at the bottom end of the terminal.
2. Remove the two screws that secure the top of the strap to the terminal.
3. Store the strap and screws for future use.

Installing the Handle/Removing the Handle

1. Place the terminal at an angle and snap it into place lining up the green buttons and headset jack on the sides of the terminal with the openings in the handle.
2. Using the attached screws, secure the handle to the terminal. The screws line up with the screw holes from the hand strap. To remove terminal, remove the screws and twist the terminal slightly and pull up.

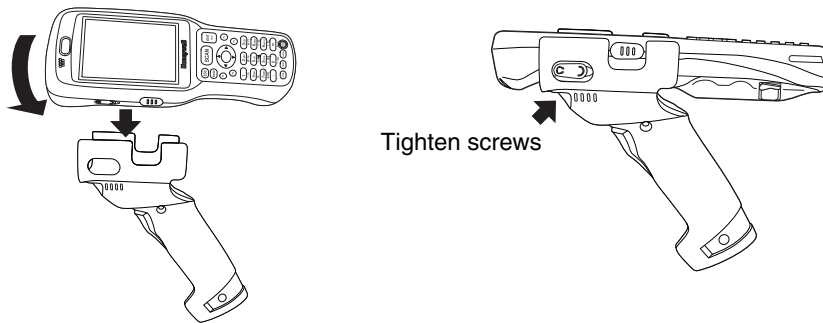



Customer Support

Technical Assistance

If you need assistance installing or troubleshooting your device, please contact us by using one of the methods below:

Knowledge Base: www.hsmknowledgebase.com

Our Knowledge Base provides thousands of immediate solutions. If the Knowledge Base cannot help, our Technical Support Portal (see below) provides an easy way to report your problem or ask your question.

Technical Support Portal: www.hsmsupportportal.com

The Technical Support Portal not only allows you to report your problem, but it also provides immediate solutions to your technical issues by searching our Knowledge Base. With the Portal, you can submit and track your questions online and send and receive attachments.

Web form: www.hsmcontactsupport.com

You can contact our technical support team directly by filling out our online support form. Enter your contact details and the description of the question/problem.

Telephone: www.honeywellaidc.com/locations

For our latest contact information, please check our website at the link above.

Product Service and Repair

Honeywell International Inc. provides service for all of its products through service centers throughout the world. To obtain warranty or non-warranty service, please visit www.honeywellaidc.com and select **Support > Contact Service and Repair** to see your region's instructions on how to obtain a Return Material Authorization number (RMA #). You should do this prior to returning the product.

Limited Warranty

Honeywell International Inc. ("HII") warrants its products and optional accessories to be free from defects in materials and workmanship and to conform to HII's published specifications applicable to the products purchased at the time of shipment. This warranty does not cover any HII product which is (i) improperly installed or used; (ii) damaged by accident or negligence, including failure to follow the proper maintenance, service, and cleaning schedule; or (iii) damaged as a result of (A) modification or alteration by the purchaser or other party, (B) excessive voltage or current supplied to or drawn from the interface connections, (C) static electricity or electro-static discharge, (D) operation under conditions beyond the specified operating parameters, or (E) repair or service of the product by anyone other than HII or its authorized representatives.

This warranty shall extend from the time of shipment for the duration published by HII for the product at the time of purchase ("Warranty Period"). Any defective product must be returned (at purchaser's expense) during the Warranty Period to HII factory or authorized service center for inspection. No product will be accepted by HII without a Return Materials Authorization, which may be obtained by contacting HII. In the event that the product is returned to HII or its authorized service center within the Warranty Period and HII determines to its satisfaction that the product is defective due to defects in materials or workmanship, HII, at its sole option, will either repair or replace the product without charge, except for return shipping to HII.

EXCEPT AS MAY BE OTHERWISE PROVIDED BY APPLICABLE LAW, THE FOREGOING WARRANTY IS IN LIEU OF ALL OTHER COVENANTS OR WARRANTIES, EITHER EXPRESSED OR IMPLIED, ORAL OR WRITTEN, INCLUDING, WITHOUT LIMITATION, ANY IMPLIED WARRANTIES OF MERCHANTABILITY OR FITNESS FOR A PARTICULAR PURPOSE, OR NON-INFRINGEMENT.

HII'S RESPONSIBILITY AND PURCHASER'S EXCLUSIVE REMEDY UNDER THIS WARRANTY IS LIMITED TO THE REPAIR OR REPLACEMENT OF THE DEFECTIVE PRODUCT WITH NEW OR REFURBISHED PARTS. IN NO EVENT SHALL HII BE LIABLE FOR INDIRECT, INCIDENTAL, OR CONSEQUENTIAL DAMAGES, AND, IN NO EVENT, SHALL ANY LIABILITY OF HII ARISING IN CONNECTION WITH ANY PRODUCT SOLD HEREUNDER (WHETHER SUCH LIABILITY ARISES FROM A CLAIM BASED ON CONTRACT, WARRANTY, TORT, OR OTHERWISE) EXCEED THE ACTUAL AMOUNT PAID TO HII FOR THE PRODUCT. THESE LIMITATIONS ON LIABILITY SHALL REMAIN IN FULL FORCE AND EFFECT EVEN WHEN HII MAY HAVE BEEN ADVISED OF THE POSSIBILITY OF SUCH INJURIES, LOSSES, OR DAMAGES. SOME STATES, PROVINCES, OR COUNTRIES DO NOT ALLOW THE EXCLUSION OR LIMITATIONS OF INCIDENTAL OR CONSEQUENTIAL DAMAGES, SO THE ABOVE LIMITATION OR EXCLUSION MAY NOT APPLY TO YOU.

All provisions of this Limited Warranty are separate and severable, which means that if any provision is held invalid and unenforceable, such determination shall not affect the validity of enforceability of the other provisions hereof. Use of any peripherals not provided by the manufacturer may result in damage not covered by this warranty. This includes but is not limited to: cables, power supplies, cradles, and docking stations. HII extends these warranties only to the first end-users of the products. These warranties are non-transferable.

Limited Warranty Duration

- The duration of the limited warranty for terminals with an integrated imager is one year.
- The duration of the limited warranty for touch screens is one year.
- The duration of the limited warranty for Dolphin HomeBase, Dolphin Mobile Mount, Dolphin ChargeBase, Dolphin Mobile Charger, and Dolphin QuadCharger is one year.
- The duration of the limited warranty for batteries is one year.
Use of any battery from a source other than Honeywell may result in damage not covered by the warranty. Batteries returned to Honeywell International Inc. in a reduced state may or may not be replaced under this warranty. Battery life will be greatly increased when following the battery instructions in this user's guide.

How to Extend Your Warranty

Honeywell International Inc. offers a variety of service plans on our hardware products. These agreements offer continued coverage for your equipment after the initial warranty expires. For more information, contact your Sales Representative, Customer Account Representative, or Product Service Marketing Manager from Honeywell International Inc., or your Authorized Reseller.



Honeywell Scanning & Mobility
9680 Old Bailes Road
Fort Mill, SC 29707

www.honeywellaidc.com