

# Dell EMC PowerEdge R6515

## Installation and Service Manual

## Notes, cautions, and warnings

 **NOTE:** A NOTE indicates important information that helps you make better use of your product.

 **CAUTION:** A CAUTION indicates either potential damage to hardware or loss of data and tells you how to avoid the problem.

 **WARNING:** A WARNING indicates a potential for property damage, personal injury, or death.

© 2019 Dell Inc. or its subsidiaries. All rights reserved. Dell, EMC, and other trademarks are trademarks of Dell Inc. or its subsidiaries. Other trademarks may be trademarks of their respective owners.

<b>1 About this document.....</b>	<b>7</b>
<b>2 PowerEdge R6515 system overview.....</b>	<b>8</b>
Front view of the system.....	8
Left control panel view.....	11
Right control panel view.....	12
Rear view of the system.....	12
Inside the system .....	14
Locating the Express Service Code and Service Tag.....	14
System information label.....	15
Rail sizing and rack compatibility matrix.....	19
<b>3 Initial system setup and configuration.....</b>	<b>20</b>
Setting up the system.....	20
iDRAC configuration.....	20
Options to set up iDRAC IP address.....	20
Options to log in to iDRAC.....	21
Resources to install operating system.....	21
Options to download firmware .....	22
Options to download and install OS drivers .....	22
Downloading drivers and firmware.....	22
<b>4 Pre-operating system management applications.....</b>	<b>24</b>
System Setup.....	24
System BIOS.....	25
iDRAC Settings utility.....	38
Device Settings.....	38
Dell Lifecycle Controller.....	38
Embedded system management.....	38
Boot Manager.....	39
PXE boot.....	39
<b>5 Installing and removing system components.....</b>	<b>40</b>
Safety instructions.....	40
Before working inside your system.....	40
After working inside your system.....	40
Recommended tools.....	41
Optional front bezel.....	41
Removing the front bezel.....	41
Installing the front bezel.....	42
System cover.....	43
Removing the system cover.....	43
Installing the system cover.....	44
Drive backplane cover.....	44

Removing the drive backplane cover.....	44
Installing the drive backplane cover.....	45
Air shroud.....	46
Removing the air shroud.....	46
Installing the air shroud.....	46
Cooling fan.....	47
Removing a cooling fan.....	47
Installing a cooling fan.....	48
Intrusion switch.....	49
Removing the intrusion switch.....	49
Installing the intrusion switch.....	49
Drives.....	50
Removing a drive blank.....	50
Installing a drive blank.....	51
Removing the drive carrier.....	51
Installing the drive carrier.....	52
Removing the drive from the drive carrier.....	53
Installing the drive into the drive carrier.....	54
Drive backplane.....	54
Drive backplane.....	54
Removing the backplane .....	55
Installing the drive backplane.....	56
Cable routing.....	58
System memory.....	59
System memory guidelines.....	59
General memory module installation guidelines.....	61
Removing a memory module.....	63
Installing a memory module.....	63
Processor and heat sink.....	64
Removing a heat sink.....	64
Removing the AMD processor.....	65
Installing the AMD processor.....	67
Installing the heat sink.....	69
Expansion cards and expansion card risers.....	71
Expansion card installation guidelines.....	71
Removing the expansion card risers.....	72
Installing the expansion card risers.....	74
Removing expansion card from the expansion card riser.....	75
Installing an expansion card into the expansion card riser.....	77
Micro SD card.....	79
Removing the MicroSD card.....	80
Installing the MicroSD card.....	80
M.2 SSD module.....	81
Removing the M.2 SSD module.....	81
Installing the M.2 SSD module.....	82
Optional IDSDM module.....	83
Removing the IDSDM module.....	83
Installing the IDSDM module.....	84
LOM riser card.....	85
Removing the LOM riser card.....	85

Installing the LOM riser card.....	87
Mini PERC card.....	89
Removing the mini PERC card.....	89
Installing the mini PERC card.....	90
System battery .....	91
Replacing the system battery.....	91
Optional internal USB memory key.....	93
Replacing optional internal USB memory key.....	93
VGA module.....	94
Removing the VGA module.....	94
Installing the VGA module.....	95
Optional optical drive.....	96
Removing the optical drive.....	96
Installing the optical drive.....	97
Power supply unit.....	98
Hot spare feature.....	98
Removing a power supply unit blank.....	99
Installing a power supply unit blank.....	99
Removing a power supply unit.....	100
Installing a power supply unit.....	100
Power interposer board.....	101
Removing the power interposer board.....	101
Installing the power interposer board.....	102
System board.....	103
Removing the system board.....	103
Installing the system board.....	104
Restoring Service Tag using Easy Restore.....	106
Trusted Platform Module.....	106
Upgrading the Trusted Platform Module.....	106
Initializing TPM for users.....	107
Initializing the TPM 1.2 for users.....	107
Initializing the TPM 2.0 for users.....	108
Control panel.....	108
Removing the left control panel.....	108
Installing the left control panel.....	109
Removing the right control panel.....	109
Installing the right control panel.....	110
<b>6 Jumpers and connectors.....</b>	<b>112</b>
System board connectors.....	112
System board jumper settings.....	113
Disabling a forgotten password.....	113
<b>7 Technical specifications.....</b>	<b>115</b>
Chassis dimensions.....	115
System weight.....	116
Processor specifications.....	116
PSU specifications.....	116
Supported operating systems.....	116

Cooling fans specifications.....	117
System battery specifications.....	117
Expansion card riser specifications.....	117
Memory specifications.....	117
Storage controller specifications.....	117
Drive specifications.....	118
Drives.....	118
Optical drives.....	118
Ports and connectors specifications.....	118
USB ports specifications.....	118
NIC ports specifications.....	118
Serial connector specifications.....	119
VGA ports specifications.....	119
IDSDM .....	119
Video specifications.....	119
Environmental specifications.....	120
Particulate and gaseous contamination specifications.....	121
Thermal restriction matrix.....	122
<b>8 System diagnostics and indicator codes.....</b>	<b>124</b>
Status LED indicators.....	124
System health and system ID indicator codes.....	125
iDRAC Quick Sync 2 indicator codes.....	126
iDRAC Direct LED indicator codes.....	127
LCD panel.....	127
Viewing Home screen.....	128
Setup menu.....	128
View menu.....	128
NIC indicator codes.....	129
Power supply unit indicator codes.....	129
Drive indicator codes.....	130
Using system diagnostics.....	131
Dell Embedded System Diagnostics.....	131
<b>9 Getting help.....</b>	<b>133</b>
Recycling or End-of-Life service information.....	133
Contacting Dell.....	133
Accessing system information by using QRL.....	133
Quick Resource Locator for PowerEdge R6515 system.....	134
Receiving automated support with SupportAssist .....	134
<b>10 Documentation resources.....</b>	<b>135</b>

# About this document

This document provides an overview about the system, information about installing and replacing components, technical specifications, diagnostic tools, and guidelines to be followed while installing certain components.

# PowerEdge R6515 system overview

The PowerEdge R6515 system is a 1U server that supports:

- One AMD EPYC 7002 series processor
- 16 DIMM slots
- Two redundant AC power supply units
- Up to 4 x 3.5-inch or 8 x 2.5-inch SAS or SATA drives or up to 10 x 2.5-inch drives (with 8 SAS/SATA/NVMe drives + 2 NVMe drives)

**NOTE:** For more information about how to hot swap NVMe PCIe SSD U.2 device, see the *Dell Express Flash NVMe PCIe SSD User's Guide* at [www.dell.com/support](http://www.dell.com/support) > Browse all Products > Data Center Infrastructure > Storage Adapters & Controllers > Dell PowerEdge Express Flash NVMe PCIe SSD > Documentation > Manuals and Documents.

**NOTE:** All instances of SAS, SATA drives are referred to as drives in this document, unless specified otherwise.

For more information about supported drives, see the [Drive specifications](#) section.

## Topics:

- [Front view of the system](#)
- [Rear view of the system](#)
- [Inside the system](#)
- [Locating the Express Service Code and Service Tag](#)
- [System information label](#)
- [Rail sizing and rack compatibility matrix](#)

## Front view of the system



Figure 1. Front view of 4 x 3.5-inch drive system

Table 1. Features available on the front of the system

Item	Ports, panels, and slots	Icon	Description
1	Left control panel	N/A	<p>Contains the system health, system ID, status LED, and the iDRAC Quick Sync 2 (wireless) indicator.</p> <p><b>NOTE:</b> The iDRAC Quick Sync 2 indicator is available only on certain configurations.</p> <ul style="list-style-type: none"> <li>• Status LED: Enables you to identify any failed hardware components. There are up to five status LEDs and an overall system health LED (Chassis health and system ID) bar. For more information, see the Status LED indicators section.</li> <li>• Quick Sync 2 (wireless): Indicates a Quick Sync enabled system. The Quick Sync feature is optional. This feature allows</li> </ul>



Item	Ports, panels, and slots	Icon	Description
			management of the system by using mobile devices called as OpenManage Mobile (OMM) feature. Using iDRAC Quick Sync 2 with OpenManage Mobile (OMM) aggregates hardware or firmware inventory and various system level diagnostic and error information that can be used in troubleshooting the system. For more information, see the <i>iDRAC User's Guide</i> available at <a href="http://www.dell.com/idracmanuals">www.dell.com/idracmanuals</a>
2	Optical drive (optional)	N/A	One optional slim SATA DVD-ROM drive or DVD+/-RW drive.
3	VGA port		Enables you to connect a display device to the system. For more information, see the <a href="#">VGA ports specifications</a> section.
4	Right control panel	N/A	Contains the power button, USB port, iDRAC Direct micro port, and the iDRAC Direct status LED.
5	Information tag		The Information tag is a slide-out label panel that contains system information such as Service Tag, NIC, MAC address, and so on. If you have opted for the secure default access to iDRAC, the Information tag also contains the iDRAC secure default password.
6	Drive (4)	N/A	Enables you to install drives that are supported on your system. For more information about drives, see the <a href="#">Drives</a> section.

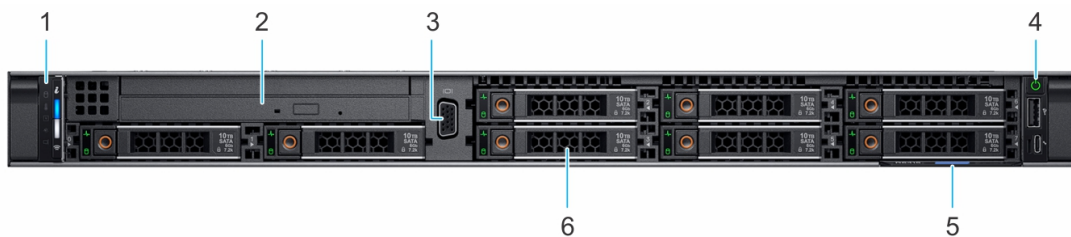

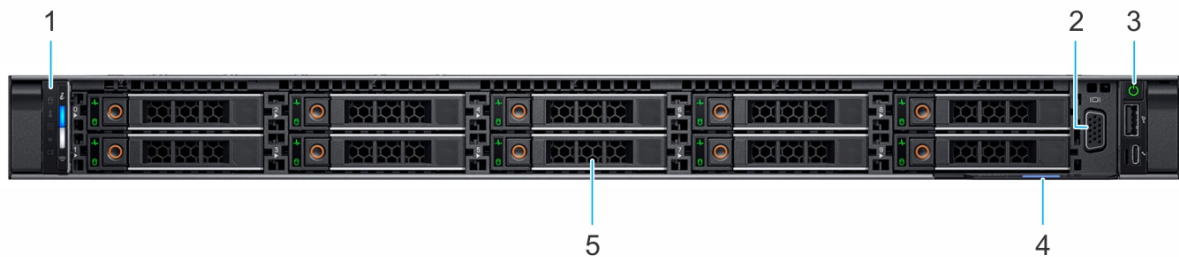

Figure 2. Front view of 8 x 2.5-inch drive system

Table 2. Features available on the front of the system

Item	Ports, panels, and slots	Icon	Description
1	Left control panel	N/A	Contains the system health, system ID, status LED, and the iDRAC Quick Sync 2 (wireless) indicator.  <b>i NOTE: The iDRAC Quick Sync 2 indicator is available only on certain configurations.</b> <ul style="list-style-type: none"> <li>Status LED: Enables you to identify any failed hardware components. There are up to five status LEDs and an overall system health LED (Chassis health and system ID) bar. For more information, see the Status LED indicators section.</li> <li>Quick Sync 2 (wireless): Indicates a Quick Sync enabled system. The Quick Sync feature is optional. This feature allows management of the system by using mobile devices called as OpenManage Mobile (OMM) feature. Using iDRAC Quick Sync 2 with OpenManage Mobile (OMM) aggregates hardware or firmware inventory and various system level diagnostic and error information that can be used in troubleshooting the system. For more information, see the <i>iDRAC User's Guide</i> available at <a href="http://www.dell.com/idracmanuals">www.dell.com/idracmanuals</a></li> </ul>
2	Optical drive (optional)	N/A	One optional slim SATA DVD-ROM drive or DVD+/-RW drive.
3	VGA port		Enables you to connect a display device to the system. For more information, see the <a href="#">VGA ports specifications</a> section.

Item	Ports, panels, and slots	Icon	Description
4	Right control panel	N/A	Contains the power button, USB port, iDRAC Direct micro port, and the iDRAC Direct status LED.
5	Information tag		The Information tag is a slide-out label panel that contains system information such as Service Tag, NIC, MAC address, and so on. If you have opted for the secure default access to iDRAC, the Information tag also contains the iDRAC secure default password.
6	Drive (8)	N/A	Enables you to install drives that are supported on your system. For more information about drives, see the <a href="#">Drives</a> section.



**Figure 3. Front view of 10 x 2.5-inch drive system**

**Table 3. Features available on the front of the system**

Item	Ports, panels, and slots	Icon	Description
1	Left control panel	N/A	Contains the system health, system ID, status LED, and the iDRAC Quick Sync 2 (wireless) indicator.  <b>NOTE: The iDRAC Quick Sync 2 indicator is available only on certain configurations.</b> <ul style="list-style-type: none"> <li>Status LED: Enables you to identify any failed hardware components. There are up to five status LEDs and an overall system health LED (Chassis health and system ID) bar. For more information, see the Status LED indicators section.</li> <li>Quick Sync 2 (wireless): Indicates a Quick Sync enabled system. The Quick Sync feature is optional. This feature allows management of the system by using mobile devices called as OpenManage Mobile (OMM) feature. Using iDRAC Quick Sync 2 with OpenManage Mobile (OMM) aggregates hardware or firmware inventory and various system level diagnostic and error information that can be used in troubleshooting the system. For more information, see the <i>iDRAC User's Guide</i> available at <a href="http://www.dell.com/idracmanuals">www.dell.com/idracmanuals</a></li> </ul>
2	VGA port		Enables you to connect a display device to the system. For more information, see the <a href="#">VGA ports specifications</a> section.
3	Right control panel	N/A	Contains the power button, USB port, iDRAC Direct micro port, and the iDRAC Direct status LED.
4	Information tag		The Information tag is a slide-out label panel that contains system information such as Service Tag, NIC, MAC address, and so on. If you have opted for the secure default access to iDRAC, the Information tag also contains the iDRAC secure default password.
5	Drive (10)	N/A	Enables you to install drives that are supported on your system. For more information about drives, see the <a href="#">Drives</a> section.

For more information about the ports, see the [Technical Specifications](#) section.

## Left control panel view

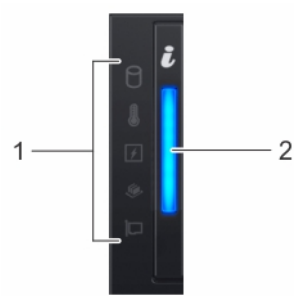

Figure 4. Left control panel without optional iDRAC Quick Sync 2.0 indicator

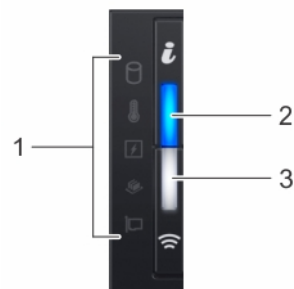

Figure 5. Left control panel with optional iDRAC Quick Sync 2.0 indicator

Table 4. Left control panel

Item	Indicator, button, or connector	Icon	Description
1	Status LED indicators	N/A	Indicates the status of the system. For more information, see the <a href="#">Status LED indicators</a> section.
2	System health and system ID indicator	<i>i</i>	Indicates the system health. For more information, see the <a href="#">System health and system ID indicator codes</a> section.
3	iDRAC Quick Sync 2 wireless indicator (optional)	📶	Indicates if the iDRAC Quick Sync 2 wireless option is activated. The Quick Sync 2 feature allows management of the system using mobile devices. This feature aggregates hardware/firmware inventory and various system level diagnostic/error information that can be used in troubleshooting the system. You can access system inventory, Dell Lifecycle Controller logs or system logs, system health status, and also configure iDRAC, BIOS, and networking parameters. You can also launch the virtual Keyboard, Video, and Mouse (KVM) viewer and virtual Kernel based Virtual Machine (KVM), on a supported mobile device. For more information, see the Integrated Dell Remote Access Controller User's Guide at <a href="http://www.dell.com/poweredge/manuals">www.dell.com/poweredge/manuals</a>

**NOTE:** For more information about the indicator codes, see the [System diagnostics and indicator codes](#) section.

## Right control panel view

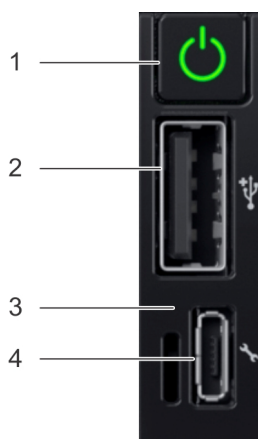

Figure 6. Right control panel

Table 5. Right control panel

Item	Indicator or button	Icon	Description
1	Power button		Indicates if the system is powered on or off. Press the power button to manually power on or off the system. <b>NOTE: Press the power button to gracefully shut down an ACPI-compliant operating system.</b>
2	USB 2.0-compliant port		The USB port is a 4-pin connector and 2.0-compliant. This port enables you to connect USB devices to the system.
3	iDRAC Direct LED indicator	N/A	The iDRAC Direct LED indicator lights up to indicate that the iDRAC Direct port is actively connected to a device.
4	iDRAC Direct port (Micro-AB USB)		The iDRAC Direct port (Micro-AB USB) enables you to access the iDRAC direct Micro-AB USB features. For more information, see the <a href="http://www.dell.com/idracmanuals">www.dell.com/idracmanuals</a> . <b>NOTE: You can configure iDRAC Direct by using a USB to micro USB (type AB) cable, which you can connect to your laptop or tablet. Cable length should not exceed 3 feet (0.91 meters). Performance could be affected by cable quality.</b>

**NOTE:** For more information on the ports, see the [Ports and connectors specifications](#) section.

## Rear view of the system

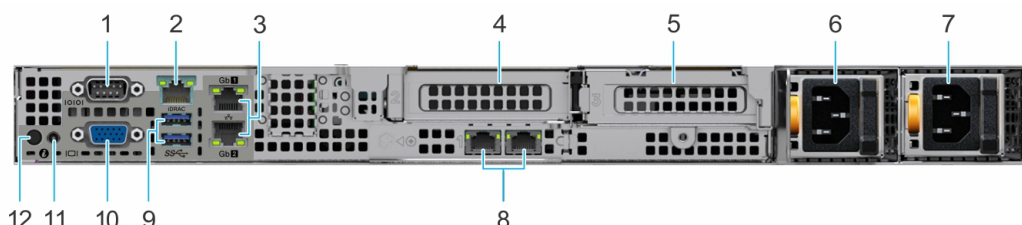







Figure 7. Rear view of the system

**Table 6. Rear view of the system**

Item	Ports, panels, or slots	Icon	Description
1	Serial port		Enables you to connect a serial device to the system. For more information, see the <a href="#">Technical Specifications</a> section.
2	iDRAC dedicated port		Enables you to remotely access iDRAC. For more information, see the iDRAC User's Guide at <a href="http://www.dell.com/poweredgemanuals">www.dell.com/poweredgemanuals</a> .
3	Ethernet ports (2)		The Ethernet ports that are integrated on the system board provide network connectivity. These NIC ports can also be shared with iDRAC when iDRAC network settings is set to shared mode. For more information about the supported configurations, see the <a href="#">Technical Specifications</a> section.
4	PCIe expansion card riser 1A (slot 2)	N/A	The expansion card riser enables you to connect PCI Express expansion cards. For more information on the expansion cards that are supported on your system, see <a href="#">Technical Specifications</a> section.
5	PCIe expansion card riser 2 (slot 3)	N/A	The expansion card riser enables you to connect PCI Express expansion cards. For more information on the expansion cards that are supported on your system, see <a href="#">Technical Specifications</a> section.
6	Power supply unit (PSU 1)	N/A	For more information about the PSU configurations, see the <a href="#">Technical Specifications</a> section.
7	Power supply unit (PSU 2)	N/A	For more information about the PSU configurations, see the <a href="#">Technical Specifications</a> section.
8	LOM Riser Ethernet port (2) (Optional)	N/A	The NIC ports that are integrated on the LAN on Motherboard (LOM) riser provide network connectivity. For more information about the supported configurations, see the <a href="#">Technical Specifications</a> section.
9	USB 3.0 port (2)		These USB ports support USB 3.0.
10	VGA port		Enables you to connect a display device to the system. For more information, see the <a href="#">Technical Specifications</a> section.
11	System status indicator cable port	N/A	Enables you to connect the status indicator cable and view system status when the CMA is installed.
12	System identification button		<p>Press the system ID button:</p> <ul style="list-style-type: none"> <li>To locate a particular system within a rack.</li> <li>To turn the system ID on or off.</li> </ul> <p>To reset iDRAC, press and hold the button for 16 seconds.</p> <p><b>NOTE:</b></p> <ul style="list-style-type: none"> <li>To reset iDRAC using system ID, ensure that the system ID button is enabled in the iDRAC setup.</li> <li>If the system stops responding during POST, press and hold the system ID button (for more than five seconds) to enter the BIOS progress mode.</li> </ul>

For more information about the ports and connectors, see the [Technical Specifications](#) section.

# Inside the system

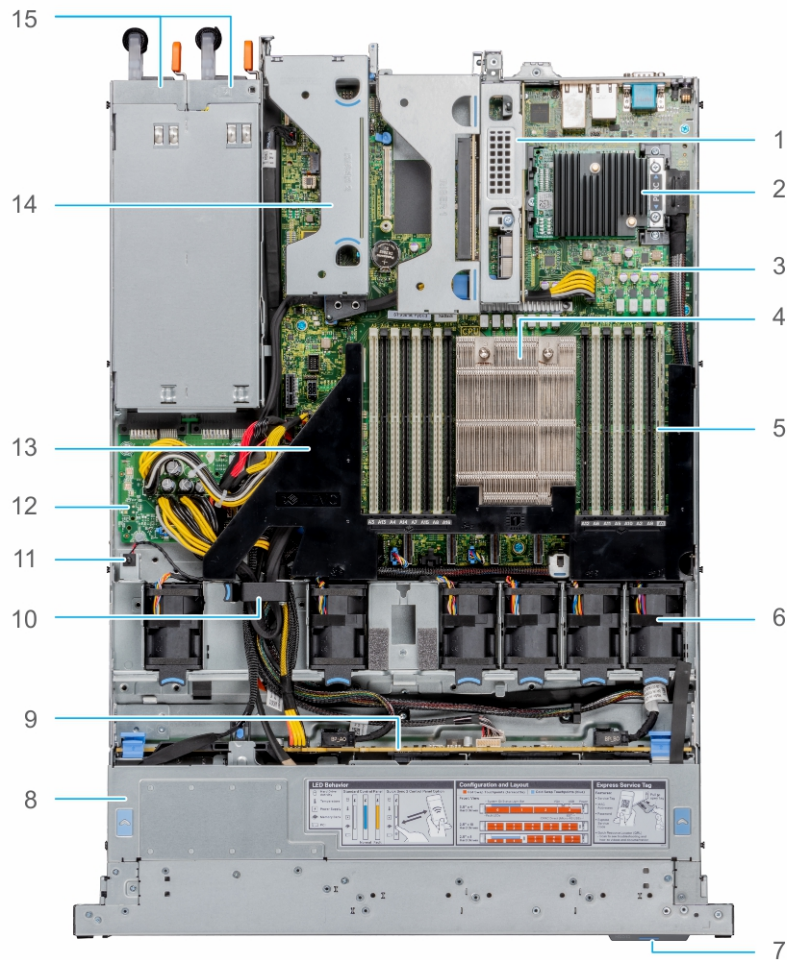

**Figure 8. Inside the system**

- |                        |                            |
|------------------------|----------------------------|
| 1. Riser 1A            | 2. Mini PERC card          |
| 3. System board        | 4. Heat sink               |
| 5. Memory module slots | 6. Fan                     |
| 7. Information tag     | 8. Backplane cover         |
| 9. Backplane           | 10. Cable retention latch  |
| 11. Intrusion switch   | 12. Power interposer board |
| 13. Air shroud         | 14. Riser 2                |
| 15. PSU 1 and PSU 2    |                            |

## Locating the Express Service Code and Service Tag

The unique Express Service Code and Service Tag is used to identify the system.

The information tag is located on the front of the system that includes system information such as Service Tag, Express Service Code, Manufacture date, NIC, MAC address, QRL label, and so on. If you have opted for the secure default access to iDRAC, the Information tag also contains the iDRAC secure default password. If you have opted for iDRAC Quick Sync 2, the Information tag also contains the OpenManage Mobile (OMM) label, where administrators can configure, monitor, and troubleshoot the PowerEdge servers.

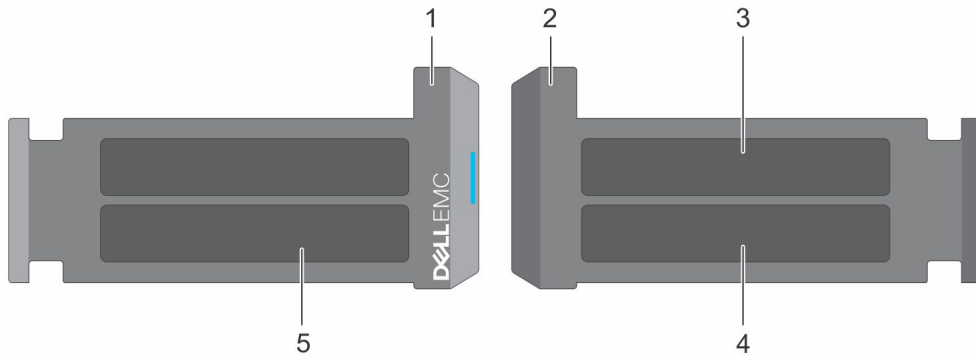

**Figure 9. Locating the Express Service Code and Service tag**

1. Information tag (front view)
2. Information tag (back view)
3. OpenManage Mobile (OMM) label
4. iDRAC MAC address and iDRAC secure password label
5. Service Tag, Express Service Code, QRL label

The Mini Enterprise Service Tag (MEST) label is located on the rear of the system that includes Service Tag (ST), Express Service Code (Exp Svc Code), and Manufacture Date (Mfg. Date). The Exp Svc Code is used by Dell EMC to route support calls to the appropriate personnel.

Alternatively, the Service Tag information is located on a label on left wall of the chassis.

## System information label

The system information label is located on back side of the system cover.

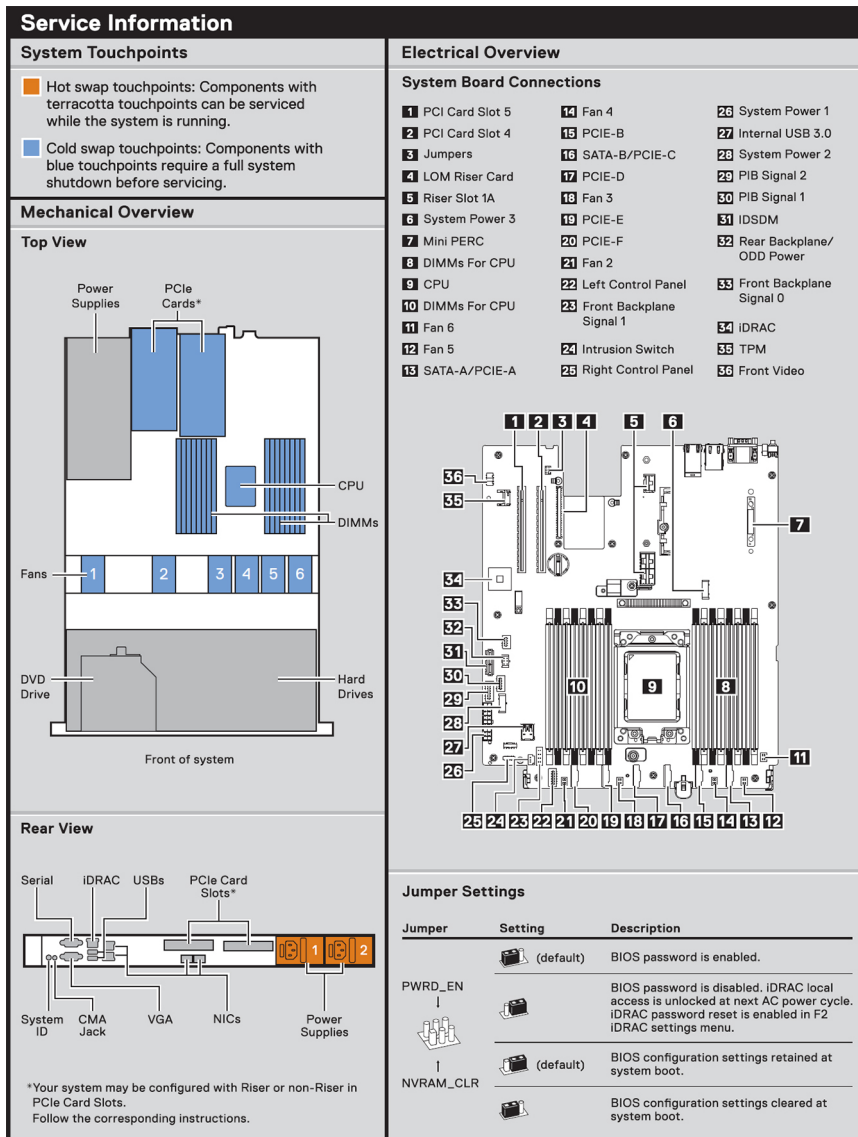

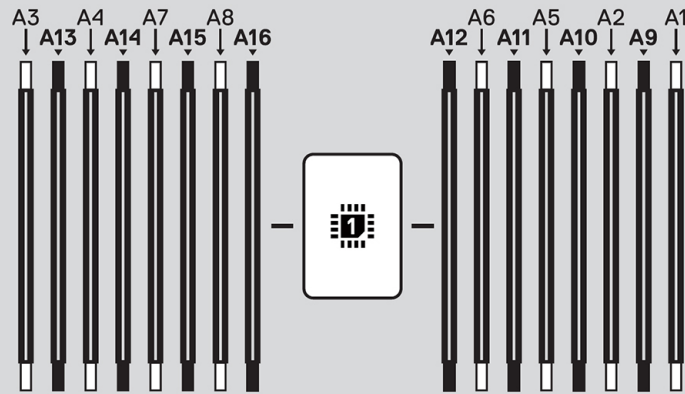

Figure 10. Service information



## Memory Information

 **Caution:** Memory (DIMMs) and CPUs may be hot during servicing.



### Memory Population

Configuration	Sequence
Memory-Optimized	1, 2, 3, 4, 5, 6, 7, 8, 9, 10, 11, 12, 13, 14, 15, 16

Latest population rules are documented in the *Installation and Service Manual*.

Figure 11. Memory information

**⚠ Caution:** Many repairs may only be done by a certified service technician. You should only perform troubleshooting and simple repairs as authorized in your product documentation, or as directed by the online or telephone service and support team. Damage due to servicing that is not authorized by Dell is not covered by your warranty. Read and follow the safety instructions that came with the product.

To learn more about this Dell product or to order additional or replacement parts, go to [Dell.com/support](http://Dell.com/support)

Copyright © 2019 Dell Inc. or its subsidiaries. All Rights Reserved. Rev A00. Label Part No. 5MTWC

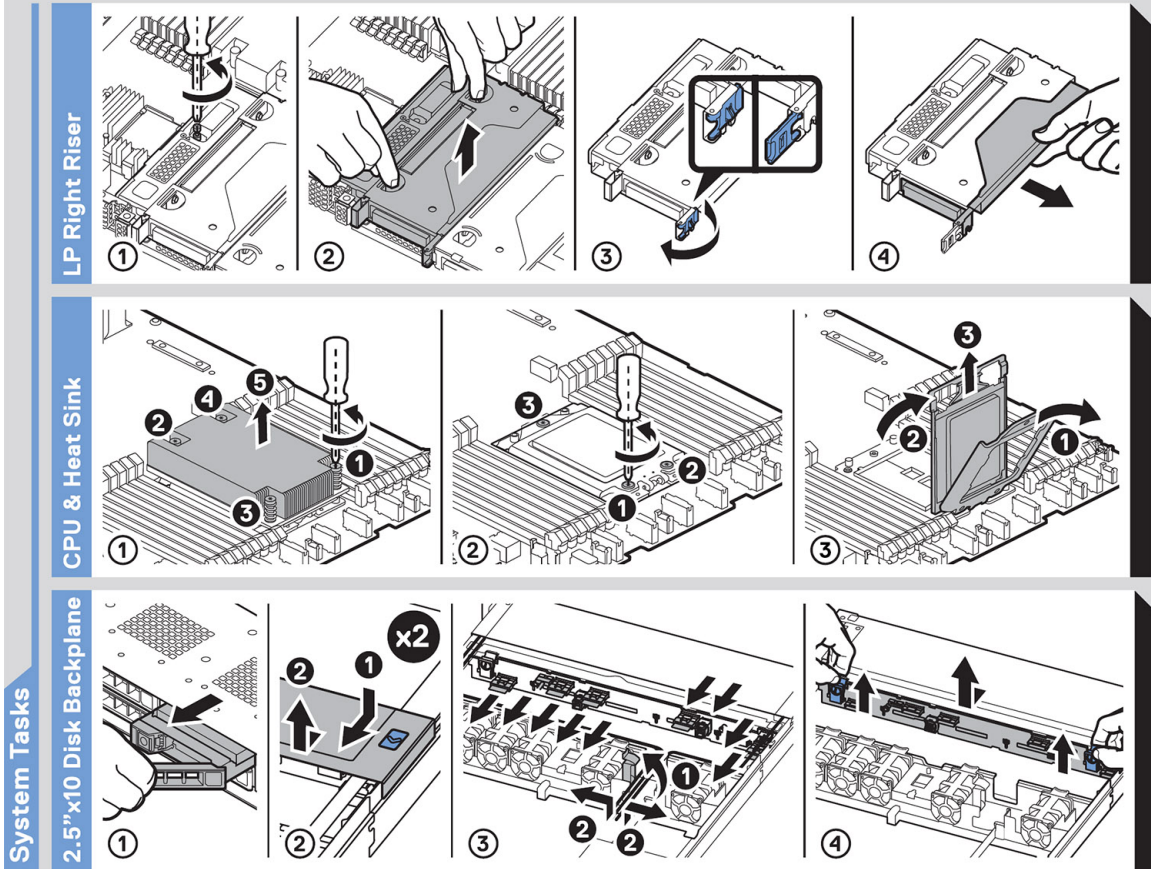

Figure 12. System tasks

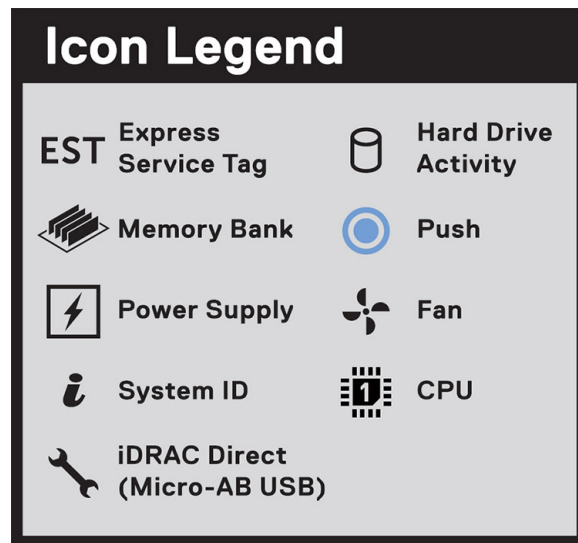

Figure 13. Icon Legend



Figure 14. R6515 QRL

## Rail sizing and rack compatibility matrix

For specific information about the rail solutions compatible with your system, refer to the *Dell EMC Enterprise Systems Rail Sizing and Rack Compatibility Matrix* available at [https://i.dell.com/sites/csdocuments/Business\\_solutions\\_engineering-Docs\\_Documents/en/rail-rack-matrix.pdf](https://i.dell.com/sites/csdocuments/Business_solutions_engineering-Docs_Documents/en/rail-rack-matrix.pdf).

The document provides the information listed below:

- Specific details about rail types and their functionalities
- Rail adjustability ranges for various rack mounting flange types
- Rail depth with and without cable management accessories
- Rack types supported for various rack mounting flange types

# Initial system setup and configuration

## Setting up the system

Perform the following steps to set up the system:

### Steps

1. Unpack the system.
2. Install the system into the rack. For more information about installing the system into the rack, see the *Rail Installation Guide* on the product page at [www.dell.com/poweredgemanuals](http://www.dell.com/poweredgemanuals).
3. Connect the peripherals to the system and the system to the electrical outlet.
4. Power on the system by pressing the power button.

For more information about setting up the system, see the *Getting Started Guide* that is shipped with your system.

## iDRAC configuration

The Integrated Dell Remote Access Controller (iDRAC) is designed to make you more productive as a system administrator and improve the overall availability of Dell EMC servers. iDRAC alerts you to system issues, helps you to perform remote management, and reduces the need for physical access to the system.



## Options to set up iDRAC IP address

To enable communication between your system and iDRAC, you must first configure the network settings based on your network infrastructure. The network settings option is set to **DHCP**, by default.

 **NOTE:** For static IP configuration, you must request for it at the time of purchase.

You can set up the iDRAC IP address using one of the following interfaces. For information about how to set up iDRAC IP address, see the documentation links provided in the table.

**Table 7. Interfaces to set up iDRAC IP address**

Interface	Documentation links
iDRAC Settings utility	<p><i>Integrated Dell Remote Access Controller User's Guide</i> at <a href="http://www.dell.com/idracmanuals">www.dell.com/idracmanuals</a> or for system specific <i>Integrated Dell Remote Access Controller User's Guide</i>, go to <a href="http://www.dell.com/poweredgemanuals">www.dell.com/poweredgemanuals</a> &gt; <b>Product Support</b> page of your system &gt; <b>Manuals &amp; documents</b>.</p> <p> <b>NOTE:</b> To determine the most recent iDRAC release for your platform and for latest documentation version, see KB article <a href="http://www.dell.com/support/article/sln308699">www.dell.com/support/article/sln308699</a>.</p>
OpenManage Deployment Toolkit	<p><i>OpenManage Deployment Toolkit User's Guide</i> at <a href="http://www.dell.com/openmanagemanuals">www.dell.com/openmanagemanuals</a> &gt; OpenManage Deployment Toolkit.</p>
Lifecycle Controller	<p><i>Lifecycle Controller User's Guide</i> at <a href="http://www.dell.com/idracmanuals">www.dell.com/idracmanuals</a> or for system specific <i>Lifecycle Controller User's Guide</i>, go to <a href="http://www.dell.com/poweredgemanuals">www.dell.com/poweredgemanuals</a> &gt; <b>Product Support</b> page of your system &gt; <b>Manuals &amp; documents</b>.</p> <p> <b>NOTE:</b> To determine the most recent iDRAC release for your platform and for latest documentation version, see KB article <a href="http://www.dell.com/support/article/sln308699">www.dell.com/support/article/sln308699</a>.</p>

Interface	Documentation links
Server LCD panel	<a href="#">LCD panel</a> section.
iDRAC Direct and Quick Sync 2 (optional)	<p><i>Integrated Dell Remote Access Controller User's Guide</i> at <a href="http://www.dell.com/idracmanuals">www.dell.com/idracmanuals</a> or for system specific <i>Integrated Dell Remote Access Controller User's Guide</i>, go to <a href="http://www.dell.com/poweredge manuals">www.dell.com/poweredge manuals</a> &gt; <b>Product Support</b> page of your system &gt; <b>Manuals &amp; documents</b>.</p> <p><b>NOTE:</b> To determine the most recent iDRAC release for your platform and for latest documentation version, see KB article <a href="http://www.dell.com/support/article/sln308699">www.dell.com/support/article/sln308699</a>.</p>

**NOTE:** To access iDRAC, ensure that you connect the ethernet cable to the iDRAC9 dedicated network port or use iDRAC Direct port by using the USB cable. You can also access iDRAC through the shared LOM mode, if you have opted for a system that has the shared LOM mode enabled.

## Options to log in to iDRAC

To log in into the iDRAC Web User Interface, open a browser and enter the address IP.

You can log in to iDRAC as:

- iDRAC user
- Microsoft Active Directory user
- Lightweight Directory Access Protocol (LDAP) user

In the login screen displayed, if you have opted for secure default access to iDRAC, enter the iDRAC secure default password available on back side of the Information Tag. If you have not opted for secure default access to iDRAC, enter the default user name and password – root and calvin. You can also log in by using your Single Sign-On or Smart Card.

**NOTE:** Ensure that you change the default user name and password after setting up the iDRAC IP address.

For more information about logging in to the iDRAC and iDRAC licenses, see the latest *Integrated Dell Remote Access Controller User's Guide* at [www.dell.com/idracmanuals](http://www.dell.com/idracmanuals).

**NOTE:** To determine the most recent iDRAC release for your platform and for latest documentation version, see KB article [www.dell.com/support/article/sln308699](http://www.dell.com/support/article/sln308699).

You can also access iDRAC using command-line protocol - RACADM. For more information, see the *iDRAC with Lifecycle Controller RACADM CLI Guide* available at [www.dell.com/idracmanuals](http://www.dell.com/idracmanuals)

You can also access iDRAC using automation tool - Redfish API. For more information, see the *iDRAC9 with Lifecycle Controller Redfish API Guide* available at [www.dell.com/idracmanuals](http://www.dell.com/idracmanuals)

## Resources to install operating system

If the system is shipped without an operating system, you can install a supported operating system by using one of the following resources. For information about how to install the operating system, see the documentation links provided in the table.

**Table 8. Resources to install the operating system**

Resource	Documentation links
iDRAC	<p><i>Integrated Dell Remote Access Controller User's Guide</i> at <a href="http://www.dell.com/idracmanuals">www.dell.com/idracmanuals</a> or for system specific <i>Integrated Dell Remote Access Controller User's Guide</i>, go to <a href="http://www.dell.com/poweredge manuals">www.dell.com/poweredge manuals</a> &gt; <b>Product Support</b> page of your system &gt; <b>Manuals &amp; documents</b>.</p> <p><b>NOTE:</b> To determine the most recent iDRAC release for your platform and for latest documentation version, see KB article at <a href="http://www.dell.com/support/article/sln308699">www.dell.com/support/article/sln308699</a>.</p>
Lifecycle Controller	<p><i>Lifecycle Controller User's Guide</i> at <a href="http://www.dell.com/idracmanuals">www.dell.com/idracmanuals</a> or for system specific <i>Lifecycle Controller User's Guide</i>, go to <a href="http://www.dell.com/poweredge manuals">www.dell.com/poweredge manuals</a> &gt; <b>Product Support</b> page of your system &gt; <b>Manuals &amp; documents</b>.</p>

Resource	Documentation links
	<b>i</b> <b>NOTE:</b> To determine the most recent iDRAC release for your platform and for latest documentation version, see KB article at <a href="http://www.dell.com/support/article/sln308699">www.dell.com/support/article/sln308699</a> .
OpenManage Deployment Toolkit	<a href="http://www.dell.com/openmanagemanuals">www.dell.com/openmanagemanuals</a> > OpenManage Deployment Toolkit
Dell certified VMware ESXi	<a href="http://www.dell.com/virtualizationsolutions">www.dell.com/virtualizationsolutions</a>

**i** **NOTE:** For more information about Installation and How-to videos for supported operating systems on PowerEdge systems see, [Supported Operating Systems for Dell EMC PowerEdge systems](#).

## Options to download firmware

You can download firmware from Dell support site. For information, see the [Downloading drivers and firmware](#) section.

You can also choose any one of the following options to download the firmware. For information about how to download the firmware, see the documentation links provided in the table.

**Table 9. Options to download firmware**

Option	Documentation link
Using Dell Remote Access Controller Lifecycle Controller (iDRAC with LC)	<a href="http://www.dell.com/idracmanuals">www.dell.com/idracmanuals</a>
Using Dell Repository Manager (DRM)	<a href="http://www.dell.com/openmanagemanuals">www.dell.com/openmanagemanuals</a> > Repository Manager
Using Dell Server Update Utility (SUU)	<a href="http://www.dell.com/openmanagemanuals">www.dell.com/openmanagemanuals</a> > Server Update Utility
Using Dell OpenManage Deployment Toolkit (DTK)	<a href="http://www.dell.com/openmanagemanuals">www.dell.com/openmanagemanuals</a> > OpenManage Deployment Toolkit
Using iDRAC virtual media	<a href="http://www.dell.com/idracmanuals">www.dell.com/idracmanuals</a>

## Options to download and install OS drivers

You can choose any one of the following options to download and install OS drivers. For information about how to download or install OS drivers, see the documentation links provided in the table.

**Table 10. Options to download and install OS drivers**

Option	Documentation
Dell EMC support site	<a href="#">Downloading drivers and firmware</a> section.
iDRAC virtual media	<i>Integrated Dell Remote Access Controller User's Guide</i> at <a href="http://www.dell.com/idracmanuals">www.dell.com/idracmanuals</a> or for system specific <i>Integrated Dell Remote Access Controller User's Guide</i> , go to <a href="http://www.dell.com/poweredgemanuals">www.dell.com/poweredgemanuals</a> > <b>Product Support</b> page of your system > <b>Manuals &amp; documents</b> . <b>i</b> <b>NOTE:</b> To determine the most recent iDRAC release for your platform and for latest documentation version, see <a href="http://www.dell.com/support/article/sln308699">www.dell.com/support/article/sln308699</a> .

## Downloading drivers and firmware

It is recommended that you download and install the latest BIOS, drivers, and systems management firmware on the system.

### Prerequisites

Ensure that you clear the web browser cache before downloading the drivers and firmware.

## Steps

1. Go to [www.dell.com/support/drivers](http://www.dell.com/support/drivers).
2. Enter the Service Tag of the system in the **Enter a Dell Service Tag, Dell EMC Product ID or Model** field, and then press Enter.  
 **NOTE: If you do not have the Service Tag, select Detect PC to automatically detect the Service Tag, or click Browse all products, and navigate to your product.**
3. On the displayed product page, click **Drivers & Downloads**.  
On the **Drivers & Downloads** page, all drivers that are applicable to the system are displayed.
4. Download the drivers to a USB drive, CD, or DVD.

# Pre-operating system management applications

You can manage basic settings and features of a system without booting to the operating system by using the system firmware.

## Options to manage the pre-operating system applications

You can use any one of the following options to manage the pre-operating system applications:

- System Setup
- Dell Lifecycle Controller
- Boot Manager
- Preboot Execution Environment (PXE)

### Topics:

- [System Setup](#)
- [Dell Lifecycle Controller](#)
- [Boot Manager](#)
- [PXE boot](#)

## System Setup

Using the **System Setup** option, you can configure the BIOS settings, iDRAC settings, and device settings of the system.

You can access system setup by using any one of the following interfaces:

- Graphical User interface — To access go to iDRAC Dashboard, click **Configuration**, and click **BIOS Settings**.
- Text browser — The browser is enabled by using Console Redirection.

To view **System Setup**, power on the system, press F2, and click **System Setup Main Menu**.

**NOTE:** If the operating system begins to load before you press F2, wait for the system to finish booting, and then restart the system and try again.

The **System Setup Main Menu** screen details are described as follows:

**Table 11. System Setup Main Menu**

Option	Description
<b>System BIOS</b>	Enables you to configure the BIOS settings.
<b>iDRAC Settings</b>	Enables you to configure the iDRAC settings.  The iDRAC settings utility is an interface to set up and configure the iDRAC parameters by using UEFI (Unified Extensible Firmware Interface). You can enable or disable various iDRAC parameters by using the iDRAC settings utility. For more information about this utility, see <i>Integrated Dell Remote Access Controller User's Guide</i> at <a href="http://www.dell.com/poweredgemanuals">www.dell.com/poweredgemanuals</a> .
<b>Device Settings</b>	Enabled you to configure device settings for devices such as storage controllers or network cards.



# System BIOS

To view the **System BIOS** screen, power on the system, press F2, and click **System Setup Main Menu > System BIOS**.

**Table 12. System BIOS details**

Option	Description
<b>System Information</b>	Provides information about the system such as the system model name, BIOS version, and Service Tag.
<b>Memory Settings</b>	Specifies information and options related to the installed memory.
<b>Processor Settings</b>	Specifies information and options related to the processor such as speed and cache size.
<b>SATA Settings</b>	Specifies options to enable or disable the integrated SATA controller and ports.
<b>NVMe Settings</b>	Specifies options to change the NVMe settings. If the system contains the NVMe drives that you want to configure in a RAID array, you must set both this field and the <b>Embedded SATA</b> field on the <b>SATA Settings</b> menu to <b>RAID</b> mode. You might also need to change the <b>Boot Mode</b> setting to <b>UEFI</b> . Otherwise, you should set this field to <b>Non-RAID</b> mode.
<b>Boot Settings</b>	Specifies options to specify the Boot mode (BIOS or UEFI). Enables you to modify UEFI and BIOS boot settings.
<b>Network Settings</b>	Specifies options to manage the UEFI network settings and boot protocols. Legacy network settings are managed from the <b>Device Settings</b> menu. <b>NOTE: Network Settings are not supported in BIOS boot mode.</b>
<b>Integrated Devices</b>	Specifies options to manage integrated device controllers and ports, specifies related features, and options.
<b>Serial Communication</b>	Specifies options to manage the serial ports, its related features, and options.
<b>System Profile Settings</b>	Specifies options to change the processor power management settings, memory frequency.
<b>System Security</b>	Specifies options to configure the system security settings, such as system password, setup password, Trusted Platform Module (TPM) security, and UEFI secure boot. It also manages the power button on the system
<b>Redundant OS Control</b>	Sets the redundant OS information for redundant OS control.
<b>Miscellaneous Settings</b>	Specifies options to change the system date and time.

## System Information

To view the **System Information** screen, power on the system, press F2, and click **System Setup Main Menu > System BIOS > System Information**.

**Table 13. System Information details**

Option	Description
<b>System Model Name</b>	Specifies the system model name.
<b>System BIOS Version</b>	Specifies the BIOS version installed on the system.
<b>System Service Tag</b>	Specifies the system Service Tag.
<b>System Manufacturer</b>	Specifies the name of the system manufacturer.
<b>System Manufacturer Contact Information</b>	Specifies the contact information of the system manufacturer.
<b>System CPLD Version</b>	Specifies the current version of the system complex programmable logic device (CPLD) firmware.
<b>UEFI Compliance Version</b>	Specifies the UEFI compliance level of the system firmware.

Option	Description
<b>AGESA Version</b>	Specifies the AGESA reference code version.
<b>SMU Version</b>	Specifies the SMU firmware version.
<b>DXIO Version</b>	Specifies the DXIO firmware version.

## Memory Settings

To view the **Memory Settings** screen, power on the system, press F2, and click **System Setup Main Menu > System BIOS > Memory Settings**.

Table 14. Memory Settings details

Option	Description
<b>System Memory Size</b>	Specifies the memory size in the system.
<b>System Memory Type</b>	Specifies the type of memory installed in the system.
<b>System Memory Speed</b>	Specifies the system memory speed.
<b>System Memory Voltage</b>	Specifies the system memory voltage.
<b>Video Memory</b>	Specifies the amount of video memory.
<b>System Memory Testing</b>	Specifies whether the system memory tests are run during system boot. The two options available are <b>Enabled</b> and <b>Disabled</b> . This option is set to <b>Disabled</b> by default.
<b>Memory Operating Mode</b>	Specifies the memory operating mode. The option is available and is set to <b>Optimizer Mode</b> , by default.
<b>Current State of Memory Operating Mode</b>	Specifies the current state of the memory operating mode.
<b>Opportunistic Self-Refresh</b>	Enables or disables opportunistic self-refresh feature. This option is set to <b>Disabled</b> by default.

## Processor Settings

To view the **Processor Settings** screen, power on the system, press F2, and click **System Setup Main Menu > System BIOS > Processor Settings**.

Table 15. Processor Settings details

Option	Description
<b>Logical Processor</b>	Each processor core supports up to two logical processors. If this option is set to <b>Enabled</b> , the BIOS displays all the logical processors. If this option is set to <b>Disabled</b> , the BIOS displays only one logical processor per core. This option is set to <b>Enabled</b> by default.
<b>Virtualization Technology</b>	Enables or disables the virtualization technology for the processor. This option is set to <b>Enabled</b> by default.
<b>IOMMU Support</b>	Enable or Disable IOMMU support. It is required to create IVRS ACPI table. This option is set to <b>Enabled</b> by default.
<b>L1 Stream HW Prefetcher</b>	Enables or disables the L1 stream hardware prefetcher. This option is set to <b>Enabled</b> by default.
<b>L2 Stream HW Prefetcher</b>	Enables or disables the L2 stream hardware prefetcher. This option is set to <b>Enabled</b> by default.
<b>MADT Core Enumeration</b>	Specifies the MADT Core Enumeration. This option is set to <b>Linear</b> by default.
<b>NUMA Nodes Per Socket</b>	Specifies the number of NUMA nodes per socket. This option is set to <b>1</b> by default.

Option	Description
CCX as NUMA Domain	Enables or disables the CCX as NUMA Domain. This option is set to <b>Disabled</b> by default.
Minimum SEV-ES ASID	Determines the number of Secure Encrypted Virtualization ES and non ES available Address Space IDs. This option is set to <b>1</b> by default.
x2APIC Mode	Enable or disable x2APIC mode. This option is set to <b>Enabled</b> by default.
Number of CCDs per Processor	Controls the number of enabled CCDs in each processor. This option is set to <b>All</b> by default.
Number of Cores per CCD	specifies the number of cores per CCD. This option is set to <b>All</b> by default.
Processor Core Speed	Specifies the maximum core frequency of the processor.
Processor n	<p> <b>NOTE: Depending on the number of CPUs, there might be up to n processors listed.</b></p> <p>The following settings are displayed for each processor installed in the system:</p>

Table 16. Processor n details

Option	Description
Family-Model-Stepping	Specifies the family, model, and stepping of the processor as defined by AMD.
Brand	Specifies the brand name.
Level 2 Cache	Specifies the total L2 cache.
Level 3 Cache	Specifies the total L3 cache.
Number of Cores	Specifies the number of cores per processor.
Microcode	Specifies the processor microcode version.

## SATA Settings

To view the **SATA Settings** screen, power on the system, press F2, and click **System Setup Main Menu > System BIOS > SATA Settings**.

Table 17. SATA Settings details

Option	Description
Embedded SATA	<p>Enables the embedded SATA option to be set to <b>Off, AHCI mode</b> , or <b>RAID modes</b>. This option is set to <b>AHCI Mode</b> by default.</p> <p> <b>NOTE:</b></p> <ol style="list-style-type: none"> <li><b>You might also need to change the Boot Mode setting to UEFI. Otherwise, you should set the field to Non-RAID mode.</b></li> <li><b>No ESXi and Ubuntu OS support under RAID mode.</b></li> </ol>
Security Freeze Lock	Sends <b>Security Freeze Lock</b> command to the embedded SATA drives during POST. This option is applicable only for AHCI Mode. This option is set to <b>Enabled</b> by default.
Write Cache	Enables or disables the command for the embedded SATA drives during POST. This option is set to <b>Disabled</b> by default.
Port n	<p>Sets the drive type of the selected device.</p> <p>For <b>AHCI Mode</b> or <b>RAID Mode</b>, BIOS support is always enabled.</p>

Option	Description								
	<p><b>Table 18. Port n</b></p> <table border="1"> <thead> <tr> <th>Options</th> <th>Descriptions</th> </tr> </thead> <tbody> <tr> <td><b>Model</b></td> <td>Specifies the drive model of the selected device.</td> </tr> <tr> <td><b>Drive Type</b></td> <td>Specifies the type of drive attached to the SATA port.</td> </tr> <tr> <td><b>Capacity</b></td> <td>Specifies the total capacity of the drive. This field is undefined for removable media devices such as optical drives.</td> </tr> </tbody> </table>	Options	Descriptions	<b>Model</b>	Specifies the drive model of the selected device.	<b>Drive Type</b>	Specifies the type of drive attached to the SATA port.	<b>Capacity</b>	Specifies the total capacity of the drive. This field is undefined for removable media devices such as optical drives.
Options	Descriptions								
<b>Model</b>	Specifies the drive model of the selected device.								
<b>Drive Type</b>	Specifies the type of drive attached to the SATA port.								
<b>Capacity</b>	Specifies the total capacity of the drive. This field is undefined for removable media devices such as optical drives.								

## NVMe Settings

This option sets the NVMe drive mode. If the system contains NVMe drives that you want to configure in a RAID array, you must set both this field and the Embedded SATA field on the SATA settings menu to RAID Mode. You may also need to change the Boot Mode setting to UEFI. The option is set to **Non-RAID** mode by default.

## Boot Settings

You can use the **Boot Settings** screen to set the boot mode to either **BIOS** or **UEFI**. It also enables you to specify the boot order.



- **UEFI:** The Unified Extensible Firmware Interface (UEFI) is a new interface between operating systems and platform firmware. The interface consists of data tables with platform related information, boot and runtime service calls that are available to the operating system and its loader. The following benefits are available when the **Boot Mode** is set to **UEFI**:
  - Support for drive partitions larger than 2 TB.
  - Enhanced security (e.g., UEFI Secure Boot).
  - Faster boot time.

 **NOTE: You must use only the UEFI boot mode in order to boot from NVMe drives.**

- **BIOS:** The **BIOS Boot Mode** is the legacy boot mode. It is maintained for backward compatibility.

To view the **Boot Settings** screen, power on the system, press F2, and click **System Setup Main Menu > System BIOS > Boot Settings**.

**Table 19. Boot Settings details**

Option	Description
<b>Boot Mode</b>	<p>Enables you to set the boot mode of the system. If the operating system supports UEFI, you can set this option to UEFI. Setting this field to BIOS allows compatibility with non-UEFI operating systems. This option is set to <b>UEFI</b> by default.</p> <p> <b>CAUTION: Switching the boot mode may prevent the system from booting if the operating system is not installed in the same boot mode.</b></p> <p> <b>NOTE: Setting this field to UEFI disables the BIOS Boot Settings menu.</b></p>
<b>Boot Sequence Retry</b>	Enables or disables the <b>Boot Sequence Retry</b> feature. If this option is set to <b>Enabled</b> and the system fails to boot, the system re-attempts the boot sequence after 30 seconds. This option is set to <b>Enabled</b> by default.
<b>Hard-disk Failover</b>	Enables or disables the Hard-disk failover. This option is set to <b>Disabled</b> by default.
<b>Generic USB Boot</b>	Enables or disables the generic USB boot placeholder. This option is set to <b>Disabled</b> by default.
<b>Hard-disk Drive Placeholder</b>	Enables or disables the Hard-disk drive placeholder. This option is set to <b>Disabled</b> by default.
<b>UEFI Boot Settings</b>	Specifies the UEFI boot sequence. Enables or disables UEFI Boot options.

Option	Description						
	<p><b>NOTE:</b> This option control the UEFI boot order. The first option in the list will be attempted first.</p> <p><b>Table 20. UEFI Boot Settings</b></p> <table border="1"> <thead> <tr> <th>Option</th> <th>Description</th> </tr> </thead> <tbody> <tr> <td><b>UEFI Boot Sequence</b></td> <td>Enables you to change the boot device order.</td> </tr> <tr> <td><b>Boot Options Enable/Disable</b></td> <td>Enables you to select the enabled or disabled boot devices</td> </tr> </tbody> </table>	Option	Description	<b>UEFI Boot Sequence</b>	Enables you to change the boot device order.	<b>Boot Options Enable/Disable</b>	Enables you to select the enabled or disabled boot devices
Option	Description						
<b>UEFI Boot Sequence</b>	Enables you to change the boot device order.						
<b>Boot Options Enable/Disable</b>	Enables you to select the enabled or disabled boot devices						

## Choosing system boot mode

System Setup enables you to specify one of the following boot modes for installing your operating system:

- UEFI boot mode (the default), is an enhanced 64-bit boot interface.

If you have configured your system to boot to UEFI mode, it replaces the system BIOS.

1. From the **System Setup Main Menu**, click **Boot Settings**, and select **Boot Mode**.
2. Select the UEFI boot mode you want the system to boot into.

**CAUTION:** Switching the boot mode may prevent the system from booting if the operating system is not installed in the same boot mode.

3. After the system boots in the specified boot mode, proceed to install your operating system from that mode.

**NOTE:** Operating systems must be UEFI-compatible to be installed from the UEFI boot mode. DOS and 32-bit operating systems do not support UEFI and can only be installed from the BIOS boot mode.

**NOTE:** For the latest information about supported operating systems, go to [www.dell.com/ossupport](http://www.dell.com/ossupport).

## Changing boot order

### About this task

You may have to change the boot order if you want to boot from a USB key or an optical drive. The following instructions may vary if you have selected **BIOS** for **Boot Mode**.

**NOTE:** Changing the drive boot sequence is only supported in BIOS boot mode.

### Steps

1. On the **System Setup Main Menu** screen, click **System BIOS** > **Boot Settings** > **UEFI Boot Settings** > **UEFI Boot Sequence**.
2. Use the arrow keys to select a boot device, and use the plus (+) and minus (-) sign keys to move the device down or up in the order.
3. Click **Exit**, and then click **Yes** to save the settings on exit.

**NOTE:** You can also enable or disable boot order devices as needed.

## Network Settings

To view the **Network Settings** screen, power on the system, press F2, and click **System Setup Main Menu** > **System BIOS** > **Network Settings**.

**NOTE:** For information about Linux network performance settings, see the *Linux Network Tuning Guide for AMD EPYC Processor Based Servers* at [AMD.com](http://AMD.com).

**NOTE:** Network Settings are not supported in BIOS boot mode.

**Table 21. Network Settings details**

Option	Description
<b>UEFI PXE Settings</b>	Enables you to control the configuration of the UEFI PXE device.

Option	Description
PXE Device n (n = 1 to 4)	Enables or disables the device. When enabled, a UEFI PXE boot option is created for the device.
PXE Device n Settings(n = 1 to 4)	Enables you to control the configuration of the PXE device.
UEFI HTTP Settings	Enables you to control the configuration of the UEFI HTTP device.
HTTP Device n (n = 1 to 4)	Enables or disables the device. When enabled, a UEFI HTTP boot option is created for the device.
HTTP Device n Settings (n = 1 to 4)	Enables you to control the configuration of the HTTP device.
UEFI iSCSI Settings	Enables you to control the configuration of the iSCSI device.

**Table 22. PXE Device n Settings details**

Option	Description
Interface	Specifies NIC interface used for the PXE device.
Protocol	Specifies Protocol used for PXE device. This option is set to <b>IPv4</b> or <b>IPv6</b> . This option is set to <b>IPv4</b> by default.
Vlan	Enables Vlan for PXE device. This option is set to <b>Enable</b> or <b>Disable</b> . This option is set to <b>Disable</b> by default.
Vlan ID	Shows the Vlan ID for the PXE device
Vlan Priority	Shows the Vlan Priority for the PXE device.

**Table 23. HTTP Device n Settings details**

Option	Description
Interface	Specifies NIC interface used for the HTTP device.
Protocol	Specifies Protocol used for HTTP device. This option is set to <b>IPv4</b> or <b>IPv6</b> . This option is set to <b>IPv4</b> by default.
Vlan	Enables Vlan for HTTP device. This option is set to <b>Enable</b> or <b>Disable</b> . This option is set to <b>Disable</b> by default.
Vlan ID	Shows the Vlan ID for the HTTP device
Vlan Priority	Shows the Vlan Priority for the HTTP device.
DHCP	Enables or disables DHCP for this HTTP device. This option is set to <b>Enable</b> by default.
IP Address	Specifies IP address for the HTTP device.
Subnet Mask	Specifies subnet mask for the HTTP device.
Gateway	Specifies gateway for the HTTP device.
DNS info via DHCP	Enables or disables DNS Information from DHCP. This option is set to <b>Enable</b> by default.
Primary DNS	Specifies the primary DNS server IP address for the HTTP Device.
Secondary DNS	Specifies the secondary DNS server IP address for the HTTP Device.
URI	Obtain URI from the DHCP server if not specified

**Table 24. UEFI iSCSI Settings screen details**

Option	Description
iSCSI Initiator Name	Specifies the name of the iSCSI initiator in IQN format.
iSCSI Device1	Enables or disables the iSCSI device. When disabled, a UEFI boot option is created for the iSCSI device automatically. This is set to <b>Disabled</b> by default.
iSCSI Device1 Settings	Enables you to control the configuration of the iSCSI device.

**Table 25. iSCSI Device1 Settings screen details**

Option	Description
<b>Connection 1</b>	Enables or disables the iSCSI connection. This option is set to <b>Disable</b> by default.
<b>Connection 2</b>	Enables or disables the iSCSI connection. This option is set to <b>Disable</b> by default.
<b>Connection 1 Settings</b>	Enables you to control the configuration for the iSCSI connection.
<b>Connection 2 Settings</b>	Enables you to control the configuration for the iSCSI connection.
<b>Connection Order</b>	Enables you to control the order for which the iSCSI connections will be attempted.

## Integrated Devices

To view the **Integrated Devices** screen, power on the system, press F2, and click **System Setup Main Menu > System BIOS > Integrated Devices**.

**Table 26. Integrated Devices details**

Option	Description
<b>User Accessible USB Ports</b>	<p>Configures the user accessible USB ports. Selecting <b>Only Back Ports On</b> disables the front USB ports; selecting <b>All Ports Off</b> disables all front and back USB ports; selecting <b>All Ports Off (Dynamic)</b> disables all front and back USB ports during POST. This option is set to <b>All Ports On</b> by default.</p> <p>When user accessible USB ports is set to <b>All Ports Off (Dynamic)</b> the <b>Enable Front Ports Only</b> option is enabled.</p> <ul style="list-style-type: none"> <li><b>Enable Front Ports Only:</b> Enables or disables the front USB ports during the OS runtime.</li> </ul> <p>The USB keyboard and mouse still function in certain USB ports during the boot process, depending on the selection. After the boot process is complete, the USB ports will be enabled or disabled as per the setting.</p>
<b>Internal USB Port</b>	Enables or disables the <b>Internal USB Port</b> . This option is set to <b>On</b> or <b>Off</b> . This option is set to <b>On</b> by default.
<b>iDRAC Direct USB Port</b>	The iDRAC Direct USB port is managed by iDRAC exclusively with no host visibility. This option is set to <b>ON</b> or <b>OFF</b> . When set to <b>OFF</b> , iDRAC does not detect any USB devices installed in this managed port. This option is set to <b>On</b> by default.
<b>Integrated RAID Controller</b>	Enables or disables the integrated RAID controller. This option is set to <b>Enabled</b> by default.
<b>Embedded NIC1 and NIC2</b>	Enables or disables the <b>Embedded NIC1 and NIC2</b> options. If set to <b>Disabled (OS)</b> , the NIC may still be available for shared network access by the embedded management controller. Configure the <b>Embedded NIC1 and NIC2</b> option by using the NIC management utilities of the system.
<b>Embedded Video Controller</b>	<p>Enables or disables the use of Embedded Video Controller as the primary display. When set to <b>Enabled</b>, the Embedded Video Controller will be the primary display even if add-in graphic cards are installed. When set to <b>Disabled</b>, an add-in graphics card will be used as the primary display. BIOS will output displays to both the primary add-in video and the embedded video during POST and pre-boot environment. The embedded video will then be disabled right before the operating system boots. This option is set to <b>Enabled</b> by default.</p> <p><b>NOTE:</b> When there are multiple add-in graphic cards installed in the system, the first card discovered during PCI enumeration is selected as the primary video. You might have to re-arrange the cards in the slots in order to control which card is the primary video.</p>
<b>Current State of Embedded Video Controller</b>	Displays the current state of the embedded video controller. The <b>Current State of Embedded Video Controller</b> option is a read-only field. If the Embedded Video Controller is the only display capability in the system (that is, no add-in graphics card

Option	Description
	is installed), then the Embedded Video Controller is automatically used as the primary display even if the <b>Embedded Video Controller</b> setting is set to <b>Disabled</b> .
<b>PCIe Preferred IO Device</b>	When set to <b>Enabled</b> , you can provide the Bus/device/function address (in decimal) to choose end device for preferred IO device. This option is set to <b>Disabled</b> by default.
<b>SR-IOV Global Enable</b>	Enables or disables the BIOS configuration of Single Root I/O Virtualization (SR-IOV) devices. This option is set to <b>Disabled</b> by default.
<b>Internal SD Card Port</b>	Enables or disables the internal SD card port of the Internal Dual SD Module (IDSMD). This option is set to <b>On</b> by default.
<b>Internal SD Card Redundancy</b>	Configures the redundancy mode of the Internal Dual SD Module (IDSMD). When set to <b>Mirror</b> Mode, data is written on both SD cards. After failure of either card and replacement of the failed card, the data of the active card is copied to the offline card during the system boot.  When Internal SD Card Redundancy is set to <b>Disabled</b> , only the primary SD card is visible to the OS. This option is set to <b>Mirror</b> by default.
<b>Internal SD Primary Card</b>	By default, the primary SD card is selected to be SD Card 1. If SD Card 1 is not present, then the controller selects SD Card 2 to be the primary SD card. This option is set to <b>SD Card 1</b> by default.
<b>OS Watchdog Timer</b>	If your system stops responding, this watchdog timer aids in the recovery of your operating system. When this option is set to <b>Enabled</b> , the operating system initializes the timer. When this option is set to <b>Disabled</b> (the default), the timer does not have any effect on the system.
<b>Memory Mapped I/O Limit</b>	Controls where MMIO is mapped. The <b>1 TB</b> option is designed for specific OS which cannot support MMIO over 1 TB. This option is set to <b>8 TB</b> by default. The default option is the maximum address that the system supports and recommended in most cases.
<b>Slot Disablement</b>	Enables or disables the available PCIe slots on your system. The slot disablement feature controls the configuration of the PCIe cards installed in the specified slot. Slots must be disabled only when the installed peripheral card prevents booting into the operating system or causes delays in system startup. If the slot is disabled, both the Option ROM and UEFI drivers are disabled. Only slots that are present on the system will be available for control.  <b>Slot n:</b> Enables or disables or only the boot driver is disabled for the PCIe slot n. This option is set to <b>Enabled</b> by default.
<b>Slot Bifurcation</b>	<b>Auto Discovery Bifurcation Settings</b> allows <b>Platform Default Bifurcation</b> and <b>Manual bifurcation Control</b> .  The default is set to <b>Platform Default Bifurcation</b> . The slot bifurcation field is accessible when set to <b>Manual bifurcation Control</b> and is grayed out when set to <b>Platform Default Bifurcation</b> .

## Serial Communication

To view the **Serial Communication** screen, power on the system, press F2, and click **System Setup Main Menu > System BIOS > Serial Communication**.

Table 27. Serial Communication details

Option	Description
<b>Serial Communication</b>	Selects serial communication devices (Serial Device 1 and Serial Device 2) in BIOS. BIOS console redirection can also be enabled, and the port address can be specified. This option is set to <b>Auto</b> by default.
<b>Serial Port Address</b>	Enables you to set the port address for serial devices. This option is set to <b>Serial Device1=COM2, Serial Device 2=COM1</b> by default.



Option	Description
	<p><b>NOTE:</b> You can use only <b>Serial Device 2</b> for the <b>Serial Over LAN (SOL)</b> feature. To use console redirection by SOL, configure the same port address for console redirection and the serial device.</p> <p><b>NOTE:</b> Every time the system boots, the BIOS syncs the serial MUX setting saved in iDRAC. The serial MUX setting can independently be changed in iDRAC. Loading the BIOS default settings from within the BIOS setup utility may not always revert the serial MUX setting to the default setting of <b>Serial Device 1</b>.</p>
<b>External Serial Connector</b>	<p>Enables you to associate the External Serial Connector to <b>Serial Device 1</b>, <b>Serial Device 2</b>, or the <b>Remote Access Device</b> by using this option. This option is set to <b>Serial Device 1</b> by default.</p> <p><b>NOTE:</b> Only <b>Serial Device 2</b> can be used for <b>Serial Over LAN (SOL)</b>. To use console redirection by SOL, configure the same port address for console redirection and the serial device.</p> <p><b>NOTE:</b> Every time the system boots, the BIOS syncs the serial MUX setting saved in iDRAC. The serial MUX setting can independently be changed in iDRAC. Loading the BIOS default settings from within the BIOS setup utility may not always revert this setting to the default setting of <b>Serial Device 1</b>.</p>
<b>Failsafe Baud Rate</b>	<p>Specifies the failsafe baud rate for console redirection. The BIOS attempts to determine the baud rate automatically. This failsafe baud rate is used only if the attempt fails, and the value must not be changed. This option is set to <b>115200</b> by default.</p>
<b>Remote Terminal Type</b>	<p>Sets the remote console terminal type. This option is set to <b>VT100/VT220</b> by default.</p>
<b>Redirection After Boot</b>	<p>Enables or disables the BIOS console redirection when the operating system is loaded. This option is set to <b>Enabled</b> by default.</p>

## System Profile Settings

To view the **System Profile Settings** screen, power on the system, press F2, and click **System Setup Main Menu > System BIOS > System Profile Settings**.

**Table 28. System Profile Settings details**

Option	Description
<b>System Profile</b>	<p>Sets the system profile. If you set the System Profile option to a mode other than <b>Custom</b>, the BIOS automatically sets the rest of the options. You can only change the rest of the options if the mode is set to <b>Custom</b>. This option is set to <b>Performance Per Watt (OS)</b> by default. Other options include <b>Performance</b> and <b>Custom</b>.</p> <p><b>NOTE:</b> All the parameters on the system profile setting screen are available only when the <b>System Profile</b> option is set to <b>Custom</b>.</p>
<b>CPU Power Management</b>	<p>Sets the CPU power management. This option is set to <b>OS DBPM</b> by default. Other option includes <b>Maximum Performance</b>.</p>
<b>Memory Frequency</b>	<p>Sets the speed of the system memory. You can select <b>Maximum Performance</b> or a specific speed. This option is set to <b>Maximum Performance</b> by default.</p>
<b>Turbo Boost</b>	<p>Enables or disables the processor to operate in the turbo boost mode. This option is set to <b>Enabled</b> by default.</p>
<b>C States</b>	<p>Enables or disables the processor to operate in all available power states. C States allow the processor to enter lower power states when idle. When set to <b>Enabled</b> (OS controlled) or when set to <b>Autonomous</b> (if hardware controlled is supported), the processor can operate in all available Power States to save power, but may increase memory latency and frequency jitter. This option is set to <b>Enabled</b> by default.</p>

Option	Description
<b>Write Data CRC</b>	When set to <b>Enabled</b> , DDR4 data bus issues are detected and corrected during 'write' operations. Two extra cycles are required for CRC bit generation which impacts the performance. Read-only unless System Profile is set to <b>Custom</b> . This option is set to <b>Disabled</b> by default.
<b>Memory Patrol Scrub</b>	Sets the memory patrol scrub mode. This option is set to <b>Standard</b> by default.
<b>Memory Refresh Rate</b>	Sets the memory refresh rate to either 1x or 2x. This option is set to <b>1x</b> by default.
<b>PCI ASPM L1 Link Power Management</b>	Enables or disables the PCI ASPM L1 Link Power Management. This option is set to <b>Enabled</b> by default.
<b>Determinism Slider</b>	Set the system determinism by <b>Power Determinism</b> or <b>Performance Determinism</b> . This option is set to <b>Power Determinism</b> by default.
<b>Efficiency Optimized Mode</b>	Efficiency Optimized Mode maximizes Performance-per-Watt by opportunistically reducing frequency/power. Enables or disables the Efficiency Optimized Mode.

## System Security

To view the **System Security** screen, power on the system, press F2, and click **System Setup Main Menu > System BIOS > System Security**.

**Table 29. System Security details**

Option	Description
<b>CPU AES-NI</b>	Improves the speed of applications by performing encryption and decryption by using the Advanced Encryption Standard Instruction Set (AES-NI). This option is set to <b>Enabled</b> by default.
<b>System Password</b>	Sets the system password. This option is set to <b>Enabled</b> by default and is read-only if the password jumper is not installed in the system.
<b>Setup Password</b>	Sets the setup password. This option is read-only if the password jumper is not installed in the system.
<b>Password Status</b>	Locks the system password. This option is set to <b>Unlocked</b> by default.

**Table 30. TPM 1.2 security information**

Option	Description
<b>TPM Security</b>	<p> <b>NOTE: The TPM menu is available only when the TPM module is installed.</b></p> <p>Enables you to control the reporting mode of the TPM. The <b>TPM Security</b> option is set to <b>Off</b> by default. You can only modify the TPM Status, and TPM Activation if the <b>TPM Status</b> field is set to either <b>On with Pre-boot Measurements</b> or <b>On without Pre-boot Measurements</b>.</p> <p>When TPM 1.2 is installed, the <b>TPM Security</b> option is set to <b>Off</b>, <b>On with Pre-boot Measurements</b>, or <b>On without Pre-boot Measurements</b>.</p> <p>When TPM 2.0 is installed, the <b>TPM Security</b> option is set to <b>On</b> or <b>Off</b>. This option is set to <b>Off</b> by default.</p>
<b>TPM Information</b>	Changes the operational state of the TPM. This option is set to <b>No Change</b> by default.
<b>TPM Firmware</b>	Indicates the firmware version of the TPM.
<b>TPM Status</b>	Specifies the TPM status.
<b>TPM Command</b>	Controls the Trusted Platform Module (TPM). When set to <b>None</b> , no command is sent to the TPM. When set to <b>Activate</b> , the TPM is enabled and activated. When set to <b>Deactivate</b> , the TPM is disabled and deactivated. When set to <b>Clear</b> , all the contents of the TPM are cleared. This option is set to <b>None</b> by default.

**Table 31. TPM 2.0 security information**

Option	Description
<b>TPM Information</b>	Changes the operational state of the TPM. This option is set to <b>No Change</b> by default.

Option	Description
<b>TPM Firmware</b>	Indicates the firmware version of the TPM.
<b>TPM Hierarchy</b>	<p>Enables, disables, or clears the storage and endorsement hierarchies. When set to <b>Enabled</b>, the storage and endorsement hierarchies can be used.</p> <p>When set to <b>Disabled</b>, the storage and endorsement hierarchies cannot be used.</p> <p>When set to <b>Clear</b>, the storage and endorsement hierarchies are cleared of any values, and then reset to <b>Enabled</b>.</p>

**Table 32. System Security details**

Option	Description								
<b>Power Button</b>	Enables or disables the power button on the front of the system. This option is set to <b>Enabled</b> by default.								
<b>AC Power Recovery</b>	Sets how the system behaves after AC power is restored to the system. This option is set to <b>Last</b> by default.								
<b>AC Power Recovery Delay</b>	Sets the time delay for the system to power up after AC power is restored to the system. This option is set to <b>Immediate</b> by default.								
<b>User Defined Delay (60 s to 600 s)</b>	Sets the <b>User Defined Delay</b> option when the <b>User Defined</b> option for <b>AC Power Recovery Delay</b> is selected.								
<b>UEFI Variable Access</b>	Provides varying degrees of securing UEFI variables. When set to <b>Standard</b> (the default), UEFI variables are accessible in the operating system per the UEFI specification. When set to <b>Controlled</b> , selected UEFI variables are protected in the environment and new UEFI boot entries are forced to be at the end of the current boot order.								
<b>Secure Boot</b>	Enables Secure Boot, where the BIOS authenticates each pre-boot image by using the certificates in the Secure Boot Policy. Secure Boot is set to <b>Disabled</b> by default.								
<b>Secure Boot Policy</b>	When Secure Boot policy is set to <b>Standard</b> , the BIOS uses the system manufacturer's key and certificates to authenticate pre-boot images. When Secure Boot policy is set to <b>Custom</b> , the BIOS uses the user-defined key and certificates. Secure Boot policy is set to <b>Standard</b> by default.								
<b>Secure Boot Mode</b>	<p>Configures how the BIOS uses the Secure Boot Policy Objects (PK, KEK, db, dbx).</p> <p>If the current mode is set to <b>Deployed Mode</b>, the available options are <b>User Mode</b> and <b>Deployed Mode</b>. If the current mode is set to <b>User Mode</b>, the available options are <b>User Mode</b>, <b>Audit Mode</b>, and <b>Deployed Mode</b>.</p> <p><b>Table 33. Secure Boot Mode</b></p> <table border="1"> <thead> <tr> <th>Options</th> <th>Descriptions</th> </tr> </thead> <tbody> <tr> <td><b>User Mode</b></td> <td> <p>In <b>User Mode</b>, PK must be installed, and BIOS performs signature verification on programmatic attempts to update policy objects.</p> <p>The BIOS allows unauthenticated programmatic transitions between modes.</p> </td> </tr> <tr> <td><b>Deployed Mode</b></td> <td> <p><b>Deployed Mode</b> is the most secure mode. In <b>Deployed Mode</b>, PK must be installed and the BIOS performs signature verification on programmatic attempts to update policy objects.</p> <p><b>Deployed Mode</b> restricts the programmatic mode transitions.</p> </td> </tr> <tr> <td><b>Audit Mode</b></td> <td> <p>In <b>Audit mode</b>, PK is not present. The BIOS does not authenticate programmatic updates to the policy objects, and transitions between modes. The BIOS performs a signature verification on pre-boot images and logs the results in the image Execution Information Table, but executes the images whether they pass or fail verification.</p> <p><b>Audit Mode</b> is useful for programmatic determination of a working set of policy objects.</p> </td> </tr> </tbody> </table>	Options	Descriptions	<b>User Mode</b>	<p>In <b>User Mode</b>, PK must be installed, and BIOS performs signature verification on programmatic attempts to update policy objects.</p> <p>The BIOS allows unauthenticated programmatic transitions between modes.</p>	<b>Deployed Mode</b>	<p><b>Deployed Mode</b> is the most secure mode. In <b>Deployed Mode</b>, PK must be installed and the BIOS performs signature verification on programmatic attempts to update policy objects.</p> <p><b>Deployed Mode</b> restricts the programmatic mode transitions.</p>	<b>Audit Mode</b>	<p>In <b>Audit mode</b>, PK is not present. The BIOS does not authenticate programmatic updates to the policy objects, and transitions between modes. The BIOS performs a signature verification on pre-boot images and logs the results in the image Execution Information Table, but executes the images whether they pass or fail verification.</p> <p><b>Audit Mode</b> is useful for programmatic determination of a working set of policy objects.</p>
Options	Descriptions								
<b>User Mode</b>	<p>In <b>User Mode</b>, PK must be installed, and BIOS performs signature verification on programmatic attempts to update policy objects.</p> <p>The BIOS allows unauthenticated programmatic transitions between modes.</p>								
<b>Deployed Mode</b>	<p><b>Deployed Mode</b> is the most secure mode. In <b>Deployed Mode</b>, PK must be installed and the BIOS performs signature verification on programmatic attempts to update policy objects.</p> <p><b>Deployed Mode</b> restricts the programmatic mode transitions.</p>								
<b>Audit Mode</b>	<p>In <b>Audit mode</b>, PK is not present. The BIOS does not authenticate programmatic updates to the policy objects, and transitions between modes. The BIOS performs a signature verification on pre-boot images and logs the results in the image Execution Information Table, but executes the images whether they pass or fail verification.</p> <p><b>Audit Mode</b> is useful for programmatic determination of a working set of policy objects.</p>								

Option	Description
<b>Secure Boot Policy Summary</b>	Specifies the list of certificates and hashes that secure boot uses to authenticate images.
<b>Secure Boot Custom Policy Settings</b>	Configures the Secure Boot Custom Policy. To enable this option, set the Secure Boot Policy to <b>Custom</b> option.

## Creating a system and setup password

### Prerequisites

Ensure that the password jumper is enabled. The password jumper enables or disables the system password and setup password features. For more information, see the System board jumper settings section.

**NOTE:** If the password jumper setting is disabled, the existing system password and setup password are deleted and you need not provide the system password to boot the system.

### Steps

- To enter System Setup, press F2 immediately after turning on or rebooting your system.
- On the **System Setup Main Menu** screen, click **System BIOS > System Security**.
- On the **System Security** screen, verify that **Password Status** is set to **Unlocked**.
- In the **System Password** field, type your system password, and press Enter or Tab.  
Use the following guidelines to assign the system password:
  - A password can have up to 32 characters.
A message prompts you to reenter the system password.
- Reenter the system password, and click **OK**.
- In the **Setup Password** field, type your setup password and press Enter or Tab.  
A message prompts you to reenter the setup password.
- Reenter the setup password, and click **OK**.
- Press Esc to return to the System BIOS screen. Press Esc again.  
A message prompts you to save the changes.

**NOTE:** Password protection does not take effect until the system reboots.

## Using your system password to secure your system

### About this task

If you have assigned a setup password, the system accepts your setup password as an alternate system password.

### Steps

- Turn on or reboot your system.
- Type the system password and press Enter.

### Next steps

When **Password Status** is set to **Locked**, type the system password and press Enter when prompted at reboot.

**NOTE:** If an incorrect system password is typed, the system displays a message and prompts you to reenter your password. You have three attempts to type the correct password. After the third unsuccessful attempt, the system displays an error message that the system has stopped functioning and must be turned off. Even after you turn off and restart the system, the error message is displayed until the correct password is entered.

## Deleting or changing system and setup password

### Prerequisites

**NOTE:** You cannot delete or change an existing system or setup password if the Password Status is set to Locked.

## Steps

1. To enter System Setup, press F2 immediately after turning on or restarting your system.
  2. On the **System Setup Main Menu** screen, click **System BIOS > System Security**.
  3. On the **System Security** screen, ensure that **Password Status** is set to **Unlocked**.
  4. In the **System Password** field, alter or delete the existing system password, and then press Enter or Tab.
  5. In the **Setup Password** field, alter or delete the existing setup password, and then press Enter or Tab.  
If you change the system and setup password, a message prompts you to reenter the new password. If you delete the system and setup password, a message prompts you to confirm the deletion.
  6. Press Esc to return to the **System BIOS** screen. Press Esc again, and a message prompts you to save the changes.
  7. Select **Setup Password**, change, or delete the existing setup password and press Enter or Tab.
- NOTE:** If you change the system password or setup password, a message prompts you to reenter the new password. If you delete the system password or setup password, a message prompts you to confirm the deletion.

## Operating with setup password enabled

If **Setup Password** is set to **Enabled**, type the correct setup password before modifying the system setup options.

If you do not type the correct password in three attempts, the system displays the following message:

```
Invalid Password! Number of unsuccessful password attempts: <x> System Halted! Must power down.
```

```
Password Invalid. Number of unsuccessful password attempts: <x> Maximum number of password attempts exceeded. System halted.
```

Even after you turn off and restart the system, the error message is displayed until the correct password is typed. The following options are exceptions:

- If **System Password** is not set to **Enabled** and is not locked through the **Password Status** option, you can assign a system password. For more information, see the System Security Settings screen section.
- You cannot disable or change an existing system password.

**NOTE:** You can use the password status option with the setup password option to protect the system password from unauthorized changes.

## Redundant OS Control

To view the **Redundant OS Control** screen, power on the system, press F2, and click **System Setup Main Menu > System BIOS > Redundant OS Control**.

Table 34. Redundant OS Control details

Option	Description
Redundant OS Location	Enables you to select a backup disk from the following devices: <ul style="list-style-type: none"><li>• <b>None</b></li><li>• <b>IDSDM</b></li><li>• <b>SATA Ports in AHCI mode</b></li><li>• <b>BOSS PCIe Cards (Internal M.2 Drives)</b></li><li>• <b>Internal USB</b></li></ul> <b>NOTE:</b> RAID configurations and NVMe cards not are included as BIOS does not have the ability to distinguish between individual drives in those configurations.
Redundant OS State	<b>NOTE:</b> This option is disabled if Redundant OS Location is set to None. When set to <b>Visible</b> , the backup disk is visible to the boot list and OS. When set to <b>Hidden</b> , the backup disk is disabled and is not visible to the boot list and OS. This option is set to <b>Visible</b> by default. <b>NOTE:</b> BIOS will disable the device in hardware, so it cannot be accessed by the OS.

Option	Description
Redundant OS Boot	<p><b>NOTE:</b> This option is disabled if Redundant OS Location is set to None or if Redundant OS State is set to Hidden.</p> <p>When set to <b>Enabled</b>, BIOS boots to the device specified in <b>Redundant OS Location</b>. When set to <b>Disabled</b>, BIOS preserves the current boot list settings. This option is set to <b>Enabled</b> by default.</p>

## Miscellaneous Settings

To view the **Miscellaneous Settings** screen, power on the system, press F2, and click **System Setup Main Menu > System BIOS > Miscellaneous Settings**.

**Table 35. Miscellaneous Settings details**

Option	Description
System Time	Enables you to set the time on the system.
System Date	Enables you to set the date on the system.
Asset Tag	Specifies the asset tag and enables you to modify it for security and tracking purposes.
Keyboard NumLock	Enables you to set whether the system boots with the NumLock enabled or disabled. This option is set to <b>On</b> by default. <b>NOTE:</b> This option does not apply to 84-key keyboards.
F1/F2 Prompt on Error	Enables or disables the F1/F2 prompt on error. This option is set to <b>Enabled</b> by default. The F1/F2 prompt also includes keyboard errors.
Load Legacy Video Option ROM	Enables or disables the Load Legacy Video Option ROM option. This option is set to <b>Disabled</b> by default.
Dell Wyse P25/P45 BIOS Access	Enables or disables the Dell Wyse P25/P45 BIOS Access. This option is set to <b>Enabled</b> by default.
Power Cycle Request	Enables or disables the Power Cycle Request. This option is set to <b>None</b> by default.

## iDRAC Settings utility

The iDRAC settings utility is an interface to set up and configure the iDRAC parameters by using UEFI. You can enable or disable various iDRAC parameters by using the iDRAC settings utility.

**NOTE:** Accessing some of the features on the iDRAC settings utility needs the iDRAC Enterprise License upgrade.

For more information about using iDRAC, see *Dell Integrated Dell Remote Access Controller User's Guide* at [www.dell.com/idracmanuals](http://www.dell.com/idracmanuals).

## Device Settings

**Device Settings** enables you to configure device parameters such as storage controllers or network cards.

## Dell Lifecycle Controller

Dell Lifecycle Controller (LC) provides advanced embedded systems management capabilities including system deployment, configuration, update, maintenance, and diagnosis. LC is delivered as part of the iDRAC out-of-band solution and Dell system embedded Unified Extensible Firmware Interface (UEFI) applications.

## Embedded system management

The Dell Lifecycle Controller provides advanced embedded system management throughout the lifecycle of the system. The Dell Lifecycle Controller is started during the boot sequence and functions independently of the operating system.

**NOTE:** Certain platform configurations may not support the full set of features provided by the Dell Lifecycle Controller.

For more information about setting up the Dell Lifecycle Controller, configuring hardware and firmware, and deploying the operating system, see the Dell Lifecycle Controller documentation at [www.dell.com/idracmanuals](http://www.dell.com/idracmanuals).

## Boot Manager

The **Boot Manager** option enables you to select boot options and diagnostic utilities.

To enter **Boot Manager**, power on the system and press F11.

**Table 36. Boot Manager details**

Option	Description
<b>Continue Normal Boot</b>	The system attempts to boot to devices starting with the first item in the boot order. If the boot attempt fails, the system continues with the next item in the boot order until the boot is successful or no more boot options are found.
<b>One-shot Boot Menu</b>	Enables you to access boot menu, where you can select a one-time boot device to boot from.
<b>Launch System Setup</b>	Enables you to access System Setup.
<b>Launch Lifecycle Controller</b>	Exits the Boot Manager and invokes the Dell Lifecycle Controller program.
<b>System Utilities</b>	Enables you to launch System Utilities menu such as Launch Diagnostics, BIOS update File Explorer, Reboot System.







## PXE boot

You can use the Preboot Execution Environment (PXE) option to boot and configure the networked systems remotely.

To access the **PXE boot** option, boot the system and then press F12 during POST instead of using standard Boot Sequence from BIOS Setup. It does not pull any menu or allows managing of network devices.

# Installing and removing system components

## Safety instructions

-  **NOTE:** To avoid injury, do not lift the system on your own, get others to assist you.
-  **WARNING:** Opening or removing the system cover while the system is powered on may expose you to a risk of electric shock.
-  **CAUTION:** Many repairs may only be done by a certified service technician. You should only perform troubleshooting and simple repairs as authorized in your product documentation, or as directed by the online or telephone service and support team. Damage due to servicing that is not authorized by Dell is not covered by your warranty. Read and follow the safety instructions that are shipped with your product.
-  **CAUTION:** To ensure proper operation and cooling, all bays in the system and system fans must be always populated with a component or a blank.
-  **NOTE:** It is recommended that you always use an antistatic mat and antistatic strap while working on components inside the system.
-  **NOTE:** While replacing the hot swappable PSU, after next server boot; the new PSU automatically updates to the same firmware and configuration of the replaced one. For more information about the Part replacement configuration, see the *Lifecycle Controller User's Guide* at [www.dell.com/idracmanuals](http://www.dell.com/idracmanuals)
-  **NOTE:** While replacing faulty storage controller/FC/NIC card with the same type of card, after you power on the system; the new card automatically updates to the same firmware and configuration of the faulty one. For more information about the Part replacement configuration, see the *Lifecycle Controller User's Guide* at [www.dell.com/idracmanuals](http://www.dell.com/idracmanuals)

## Before working inside your system

### Prerequisites

Follow the safety guidelines listed in [Safety instructions](#).

### Steps

1. Power off the system and all attached peripherals.
2. Disconnect the system from the electrical outlet, and disconnect the peripherals.
3. If applicable, remove the system from the rack.  
For more information, see the *Rail Installation Guide* at [www.dell.com/poweredgemanuals](http://www.dell.com/poweredgemanuals).
4. Remove the system cover.

## After working inside your system

### Prerequisites

Follow the safety guidelines listed in [Safety instructions](#).

### Steps

1. Replace the system cover.



2. If applicable, install the system into the rack.  
For more information, see the *Rail Installation Guide* at [www.dell.com/poweredgemanuals](http://www.dell.com/poweredgemanuals).
3. Reconnect the peripherals and connect the system to the electrical outlet, and then power on the system.

## Recommended tools

You need the following tools to perform the removal and installation procedures:

- Key to the bezel lock  
The key is required only if your system includes a bezel.
- Phillips #1 screwdriver
- Phillips #2 screwdriver
- Torx #T20 screwdriver
- 5mm hex nut screwdriver
- Plastic scribe
- 1/4 inch flat blade screwdriver
- Wrist grounding strap connected to the ground
- ESD mat

## Optional front bezel

 **NOTE:** LCD panel is optional on the front bezel. If the front bezel has an LCD panel, see [LCD panel](#) section.

## Removing the front bezel

The procedure to remove the front bezel with and without the LCD panel is the same.

### Prerequisites

1. Follow the safety guidelines listed in the [Safety instructions](#).
2. Keep the bezel key handy.

 **NOTE:** The bezel key is part of the LCD bezel package.

### Steps

1. Unlock the bezel.
2. Press the release button, and disengage the left end of the bezel.
3. Unhook the right end, and remove the bezel.



Figure 15. Removing the front bezel with the LCD panel

### Next steps

Replace the bezel.

## Installing the front bezel

The procedure to install the front bezel with and without the LCD panel is the same.

### Prerequisites

1. Follow the safety guidelines listed in the [Safety instructions](#).
2. Locate and remove the bezel key.

**NOTE:** The bezel key is part of the LCD bezel package.

### Steps

1. Align and insert the tabs on the bezel into the slots on the system.
2. Press the bezel until the release button clicks in place.
3. Lock the bezel.

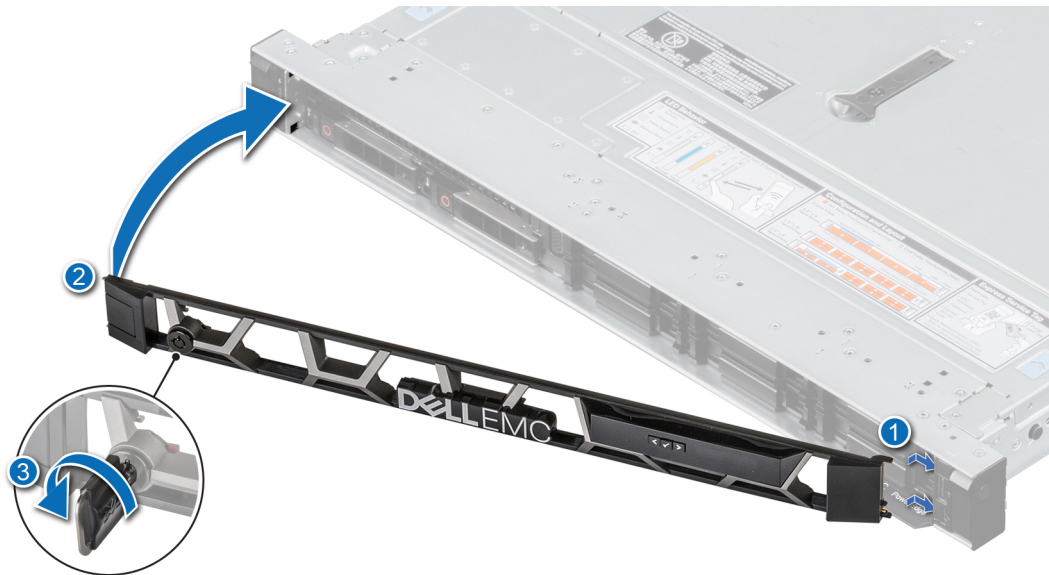

Figure 16. Installing the front bezel with the LCD panel

## System cover

### Removing the system cover

#### Prerequisites

1. Follow the safety guidelines listed in the [Safety instructions](#).
2. Power off the system, and any attached peripherals.
3. Disconnect the system from the electrical outlet and peripherals.

#### Steps

1. Use a 1/4 inch flat head or a Phillips #2 screwdriver to rotate the lock counterclockwise to the unlock position.
2. Lift the release latch until the system cover slides back.
3. Lift the cover from the system.



Figure 17. Removing the system cover

### Next steps

Replace the system cover.

## Installing the system cover

### Prerequisites

1. Follow the safety guidelines listed in the [Safety instructions](#).
2. Follow the procedure listed in [Before working inside your system](#).
3. Ensure that all internal cables are connected and routed properly, and no tools or extra parts are left inside the system.

### Steps

1. Align the tabs on the system cover with the guide slots on the system.
2. Close the system cover release latch.
3. Using a 1/4 inch flat head or Phillips #2 screwdriver, rotate the lock clockwise to the lock position.



Figure 18. Installing the system cover

### Next steps

Follow the procedure listed in [After working inside your system](#).

## Drive backplane cover

## Removing the drive backplane cover

### Prerequisites

1. Follow the safety guidelines listed in the [Safety instructions](#).
2. Follow the procedure listed in the [Before working inside your system](#).

### Steps

1. Slide the backplane cover in the direction of the arrows marked on the backplane cover.
2. Lift the backplane cover from the system.

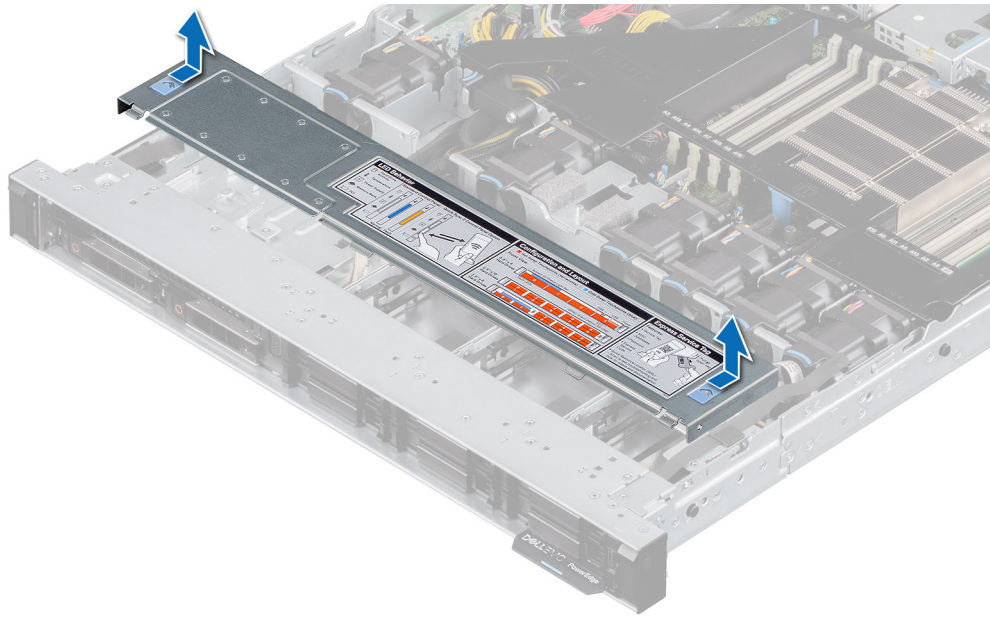

**Figure 19. Removing the drive backplane cover**

**Next steps**

Replace the backplane cover.

## Installing the drive backplane cover

**Prerequisites**

Follow the safety guidelines listed in the [Safety instructions](#).

**Steps**

1. Align the backplane cover with the guide slots on the system.
2. Slide the backplane cover toward the front of the system until the backplane cover fits into place.

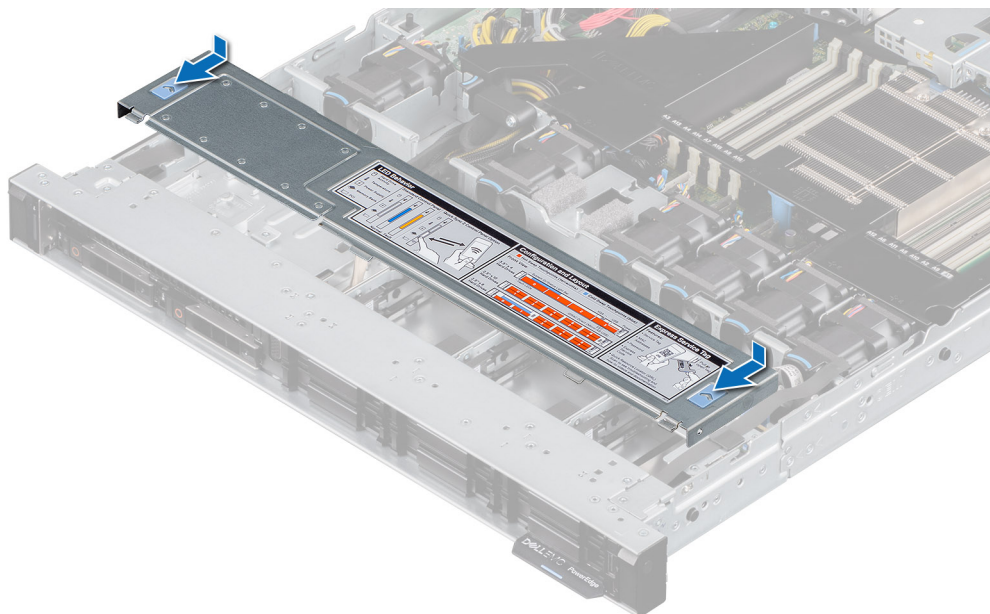

**Figure 20. Installing the drive backplane cover**

### Next steps

Follow the procedure listed in [After working inside your system](#).

## Air shroud

### Removing the air shroud

#### Prerequisites

**CAUTION:** Never operate your system with the air shroud removed. The system may get overheated quickly, resulting in shutdown of the system and loss of data.

1. Follow the safety guidelines listed in the [Safety instructions](#).
2. Follow the procedure listed in the [Before working inside your system](#).

#### Steps

Hold the air shroud touch points at both ends and lift the air shroud out of the system.

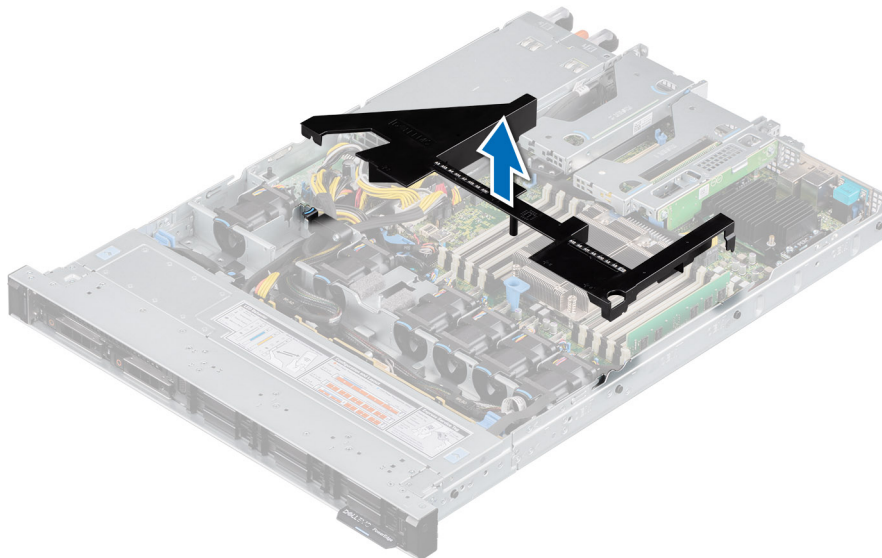

Figure 21. Removing the air shroud

### Next steps

Replace the air shroud.

## Installing the air shroud

#### Prerequisites

1. Follow the safety guidelines listed in the [Safety instructions](#).
2. Follow the procedure listed in the [Before working inside your system](#).

#### Steps

1. Align the slot on the air shroud with the standoff on the chassis.
2. Lower the air shroud into the system until it is firmly seated.

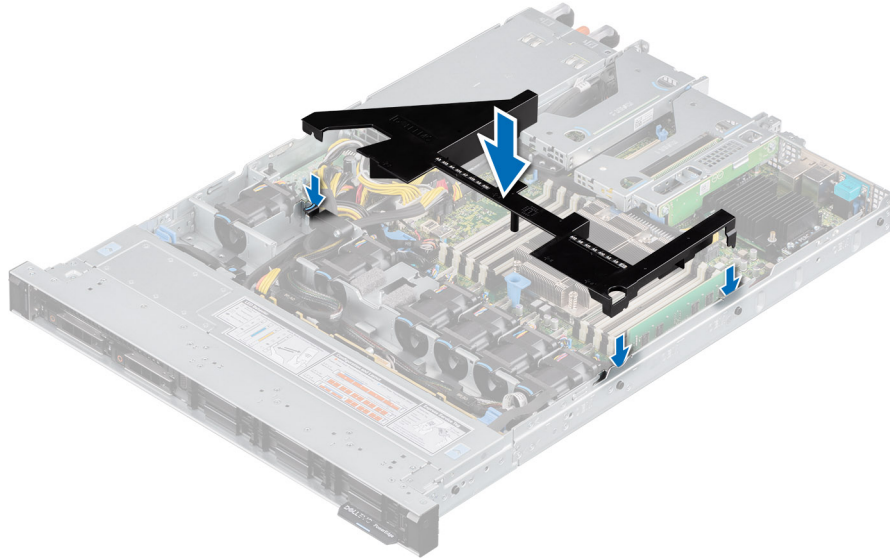

**Figure 22. Installing the air shroud**

### Next steps

Follow the procedure listed in [After working inside your system](#).

## Cooling fan

### Removing a cooling fan

#### Prerequisites

1. Follow the safety guidelines listed in the [Safety instructions](#).
2. Follow the procedure listed in the [Before working inside your system](#).
3. [Remove the air shroud](#).
4. Move the cables out of way to access the fan cable connector on the system board.

**NOTE:** Observe the fan cable routing or make a note on the fan cable routing.

#### Steps

1. Disconnect the cooling fan cable connected to the system board connector.
2. Holding the blue tab, lift the cooling fan out of the fan cage.

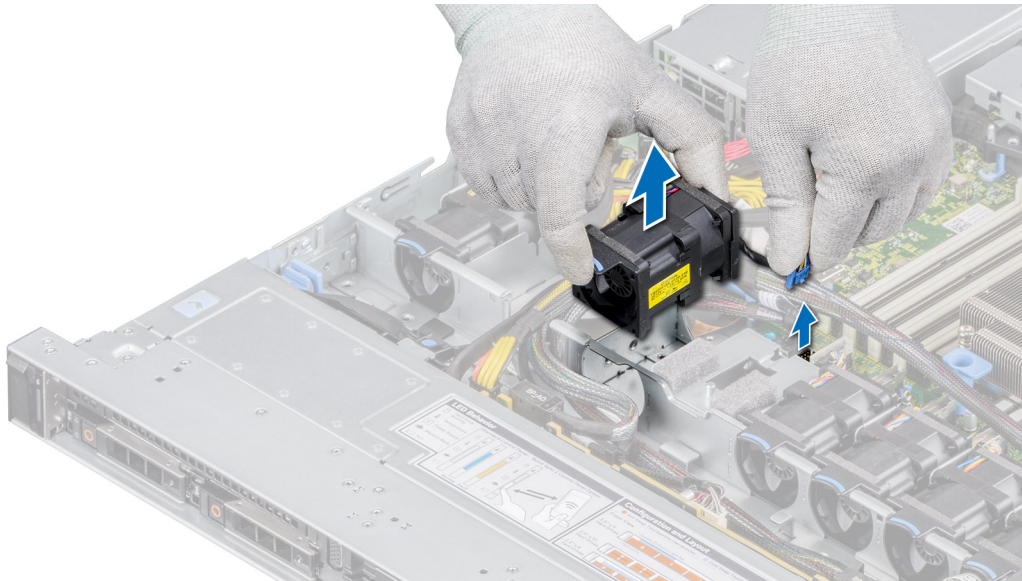

**Figure 23. Removing a cooling fan**

#### **Next steps**

[Replace a fan.](#)

## **Installing a cooling fan**

#### **Prerequisites**

1. Follow the safety guidelines listed in the [Safety instructions](#).
2. Follow the procedure listed in the [Before working inside your system](#).

#### **Steps**

1. Lower the cooling fan into the cage until it is seated firmly.
2. Route the cable properly to prevent the cable from being pinched or crimped.
3. Press the release tabs on the fan cable connector and connect the cable to the system board.

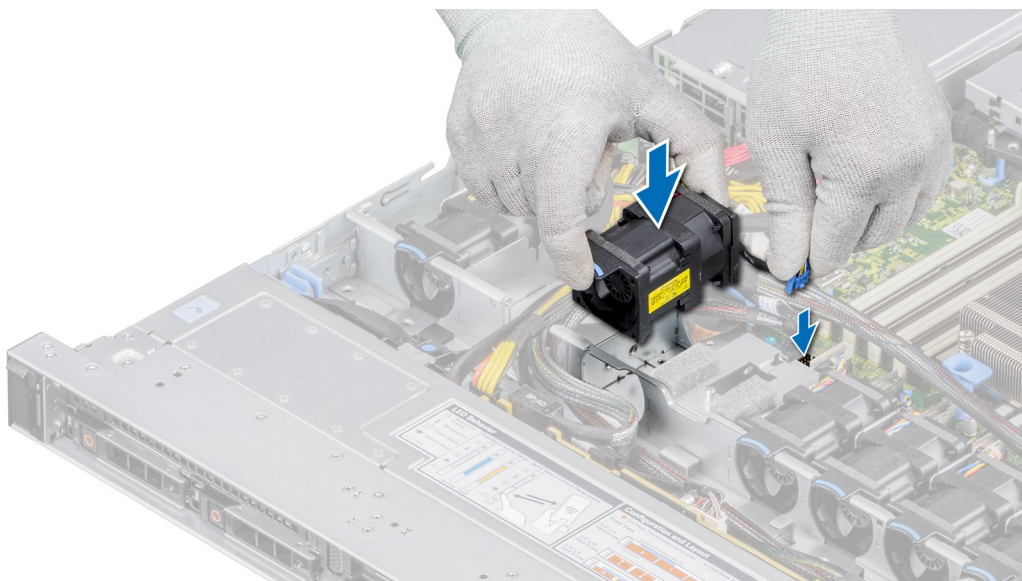

**Figure 24. Installing a cooling fan**



### Next steps

1. [Install the air shroud.](#)
2. Follow the procedure listed in [After working inside your system.](#)

## Intrusion switch

### Removing the intrusion switch

#### Prerequisites

1. Follow the safety guidelines listed in the [Safety instructions.](#)
2. Follow the procedure listed in the [Before working inside your system.](#)
3. [Remove the air shroud.](#)
4. Keep the plastic scribe ready.

#### Steps

1. Disconnect and remove the intrusion switch cable from the connector on the system board.  
Observe the routing of the cable as you remove it from the system.
2. Using a plastic scribe, slide the intrusion switch out of the intrusion switch slot.

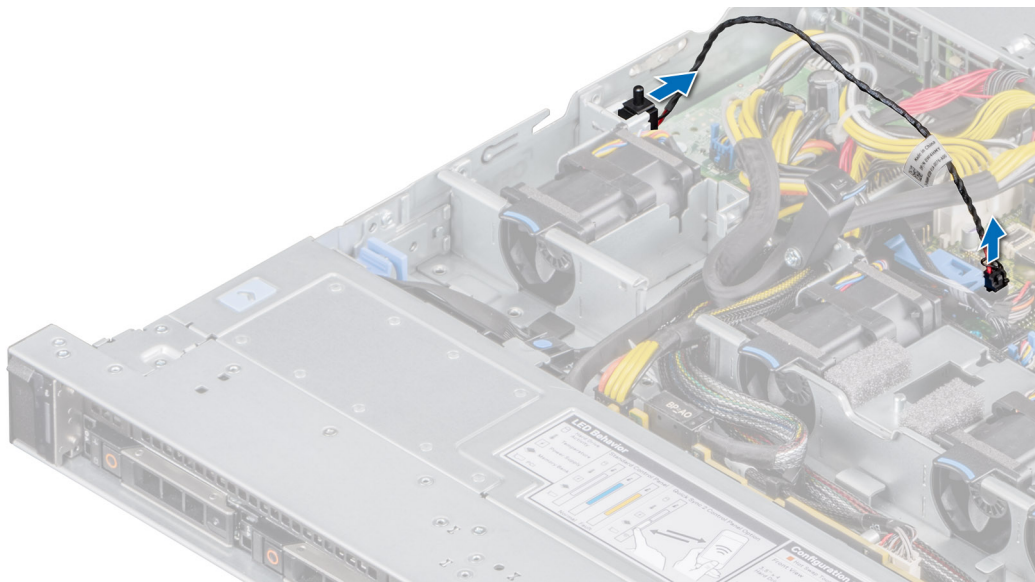

**Figure 25. Removing the intrusion switch**

### Next steps

[Replace the intrusion switch.](#)

## Installing the intrusion switch

#### Prerequisites

1. Follow the safety guidelines listed in the [Safety instructions.](#)
2. Follow the procedure listed in the [Before working inside your system.](#)

#### Steps

1. Align and slide the intrusion switch in the slot until it is firmly seated in the slot on the system.

**NOTE:** Route the cable properly when you replace it to prevent the cable from being pinched or crimped.

2. Connect the intrusion switch cable to the connector on the system board.

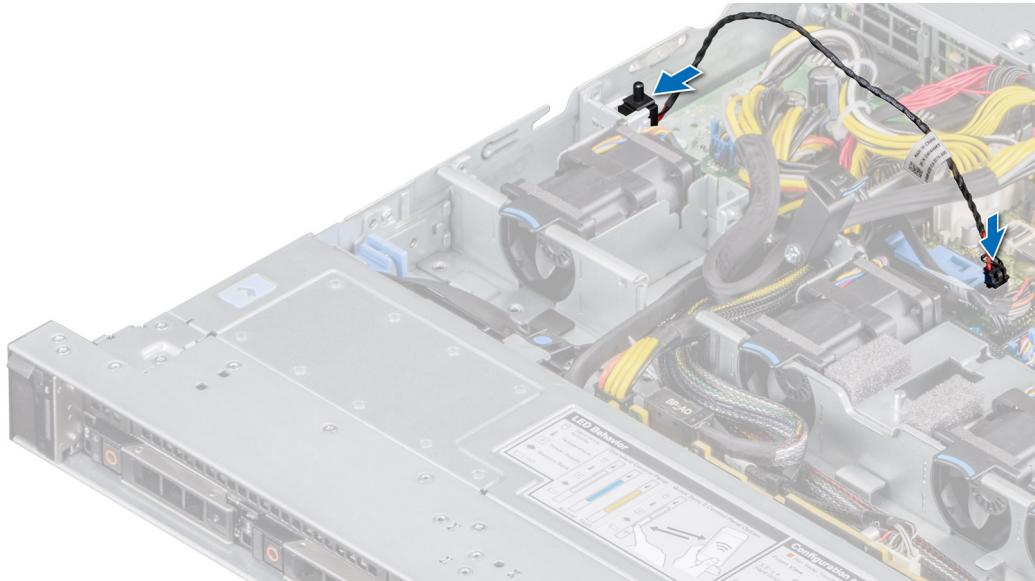

Figure 26. Installing the intrusion switch

#### Next steps

1. Install the air shroud.
2. Follow the procedure listed in [After working inside your system](#).

## Drives

### Removing a drive blank

#### Prerequisites

1. Follow the safety guidelines listed in the [Safety instructions](#).
2. If installed, [remove the front bezel](#).

**CAUTION:** To maintain proper system cooling, drive blanks must be installed in all empty drive slots.

#### Steps

Press the release button, and slide the drive blank out of the drive slot.

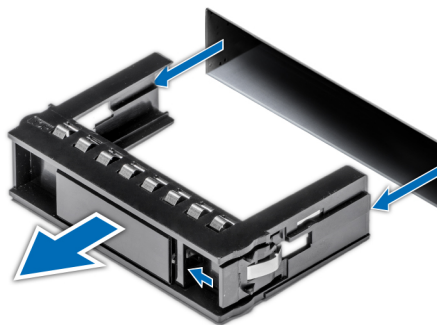

Figure 27. Removing a drive blank

### Next steps

Installing a drive or replace the drive blank.

## Installing a drive blank

### Prerequisites

1. Follow the safety guidelines listed in the [Safety instructions](#).
2. If installed, [remove the front bezel](#).

### Steps

Insert the drive blank into the drive slot until the release button clicks into place.

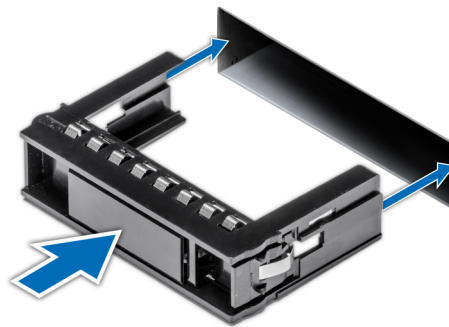

Figure 28. Installing a drive blank

### Next steps

If removed, [install the front bezel](#).

## Removing the drive carrier

### Prerequisites

1. Follow the safety guidelines listed in the [Safety instructions](#).
2. If installed, [remove the front bezel](#).
3. Using the management software, prepare the drive for removal.

If the drive is online, the green activity or fault indicator blinks while the drive is powering off. When the drive indicators are off, the drive is ready for removal. For more information, see the documentation for the storage controller.

**CAUTION:** Before attempting to remove or install a drive while the system is running, see the documentation for the storage controller card to ensure that the host adapter is configured correctly to support drive removal and insertion.

**CAUTION:** To prevent data loss, ensure that your operating system supports drive installation. See the documentation supplied with your operating system.

### Steps

1. Press the release button to open the drive carrier release handle.
2. Holding the drive carrier release handle, slide the drive carrier out of the drive slot.



Figure 29. Removing a drive carrier

### Next steps

Install a [drive carrier](#) or [drive blank](#).

## Installing the drive carrier

### Prerequisites

- CAUTION:** Before removing or installing a drive while the system is running, see the documentation for the storage controller card to ensure that the host adapter is configured correctly to support drive removal and insertion.
- CAUTION:** Combining SAS and SATA drives in the same RAID volume is not supported.
- CAUTION:** When installing a drive, ensure that the adjacent drives are fully installed. Inserting a drive carrier and attempting to lock its handle next to a partially installed carrier can damage the partially installed carrier's shield spring and make it unusable.
- CAUTION:** To prevent data loss, ensure that your operating system supports hot-swap drive installation. See the documentation supplied with your operating system.
- CAUTION:** When a replacement hot swappable drive is installed and the system is powered on, the drive automatically begins to rebuild. Ensure that the replacement drive is blank or contains data that you wish to overwrite. Any data on the replacement drive is immediately lost after the drive is installed.
- NOTE:** Ensure that the drive carrier's release handle is in the open position before inserting the carrier into the slot.

1. Follow the safety guidelines listed in the [Safety instructions](#).
2. If installed, [remove the front bezel](#).
3. Remove the drive carrier or remove the drive blank when you want to assemble the drives in to the system.

### Steps

1. Slide the drive carrier into the drive slot.
2. Close the drive carrier release handle to lock the drive in place.



**Figure 30. Installing a drive carrier**

**Next steps**

If removed, [install the front bezel](#).

## Removing the drive from the drive carrier

**Prerequisites**

1. Follow the safety guidelines listed in the [Safety instructions](#).
2. If installed, [remove the front bezel](#).

**Steps**

1. Using a Phillips #1 screwdriver, remove the screws from the slide rails on the drive carrier.
2. Lift the drive out of the drive carrier.



**Figure 31. Removing the drive from the drive carrier**

### Next steps

Install the drive into the drive carrier.

## Installing the drive into the drive carrier

### Prerequisites

1. Follow the safety guidelines listed in the [Safety instructions](#).
2. If installed, [remove the front bezel](#).
3. Remove the drive blank.

**NOTE:** When installing a drive into the drive carrier, ensure that the screws are torqued to 4 in-lbs.

### Steps

1. Insert the drive into the drive carrier with the drive connector facing towards the rear of the carrier.
2. Align the screw holes on the drive with the screws holes on the drive carrier.
3. Using a Phillips #1 screwdriver, secure the drive to the drive carrier with the screws.

**NOTE:** When installing a drive into the drive carrier, ensure that the screws are torqued to 4 in-pounds.



Figure 32. Installing a drive into the drive carrier

### Next steps

1. [Install the drive carrier](#).
2. If removed, [install the front bezel](#).

## Drive backplane

### Drive backplane

Depending on your system configuration, the drive backplanes supported are listed here:

Table 37. Supported backplane options

System	Supported hard drives options
PowerEdge R6515	3.5 inch (x4) SAS, SATA backplane

System	Supported hard drives options
	2.5 inch (x8) SAS or SATA backplane
	2.5 inch (x10) SAS, SATA or NVMe backplane

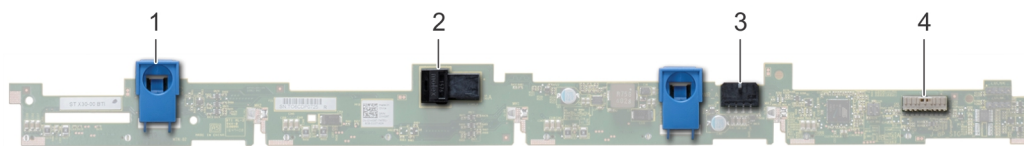

**Figure 33. 4 x 3.5-drive backplane**

1. release tab
2. SAS\_A connector on the backplane
3. backplane power cable

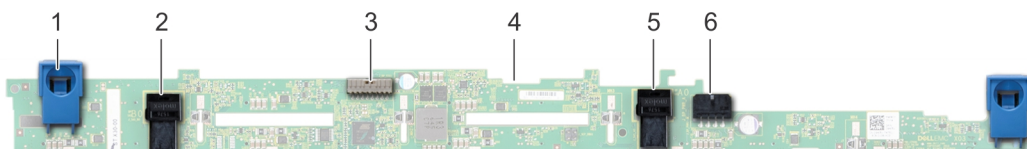

**Figure 34. 8 x 2.5-drive backplane**

1. release tab
2. SATA\_A cable connector
3. backplane signal cable
4. backplane
5. SATA\_B cable connector
6. backplane power cable



**Figure 35. 10 x 2.5-SAS, SATA or NVMe drive backplane**

1. B0 NVMe cable connector
2. I2C cable connector
3. A0 NVMe cable connector
4. SAS/SATA cable connector
5. B1 NVMe cable connector
6. A1 NVMe cable connector
7. SAS/SATA cable connector
8. A2 NVMe cable connector
9. backplane power connector

## Removing the backplane

### Prerequisites

**CAUTION:** To prevent damage to the drives and backplane, remove the drives from the system before removing the backplane.

**CAUTION:** Note the number of each drive and temporarily label them before you remove the drive so that you can reinstall them in the same location.

**NOTE:** The procedure to remove the backplane is similar for all backplane configurations.

1. Follow the safety guidelines listed in the [Safety instructions](#).
2. Follow the procedure listed in the [Before working inside your system](#).
3. [Remove the air shroud](#).
4. Remove the backplane cover.
5. Remove all the drives.

6. Disconnect the VGA cable from the system board.  
**NOTE:** Observe the routing of the cable as you remove it from the system.
7. If installed, disconnect the optical drive signal and power cables from the drive.

### Steps

1. Press the blue release tabs to disengage the drive backplane from the hooks on the system.
2. Lift the drive backplane out of the system.  
**NOTE:** To avoid damaging the backplane, ensure that you move the control panel cables from the cable routing clips before removing the backplane.

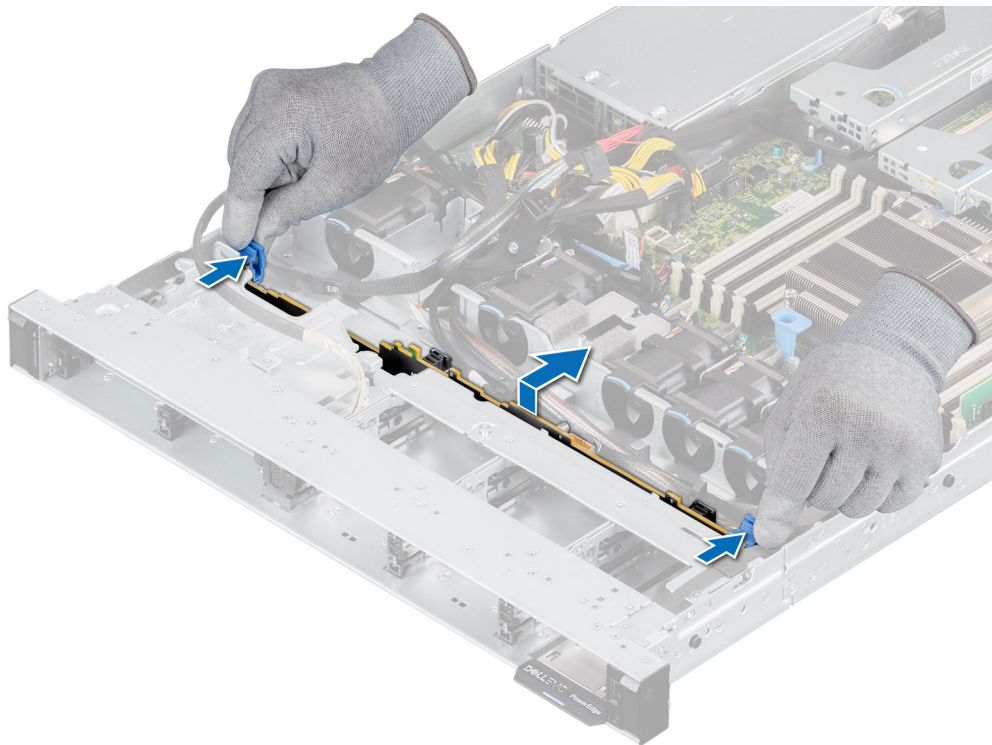

Figure 36. Removing the backplane

### Next steps

Replace the drive backplane.

## Installing the drive backplane

### Prerequisites

1. Follow the safety guidelines listed in the [Safety instructions](#).
2. Follow the procedure listed in the [Before working inside your system](#).
3. [Remove the air shroud](#).
4. Remove the backplane cover.
5. Remove all the drives.  
**NOTE:** To avoid damaging the backplane, ensure to move the control panel cables from the cable routing clips before removing the backplane.  
**NOTE:** Route the cable properly when you replace it to prevent the cable from being pinched or crimped.

### Steps

1. Use the hooks on the system as guides to align the slots on the backplane with the guides on the system.



2. Insert the backplane into the guides and lower the backplane until the blue release tabs click into place.

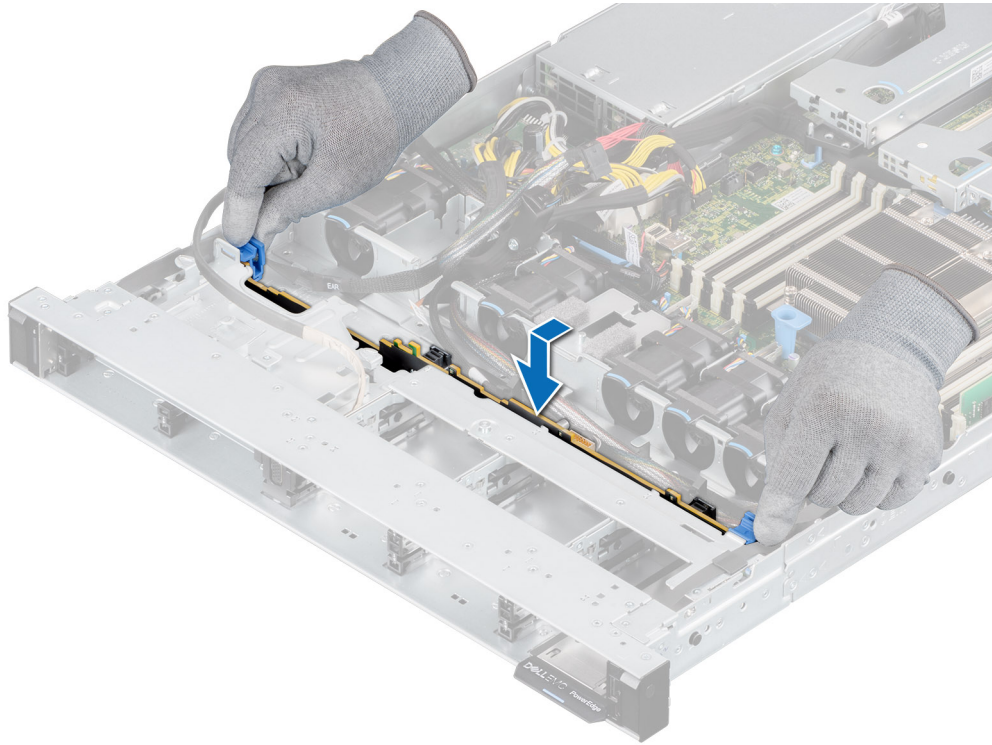

**Figure 37. Installing the drive backplane**

#### **Next steps**

1. Reconnect the VGA cable to the system board.
2. If disconnected, reconnect the optical drive power and signal cables to the drive.
3. Reconnect all the disconnected cables to the backplane.
4. Install all the drives.
5. Install the backplane cover.
6. [Install the air shroud.](#)
7. Follow the procedure listed in [After working inside your system.](#)

# Cable routing

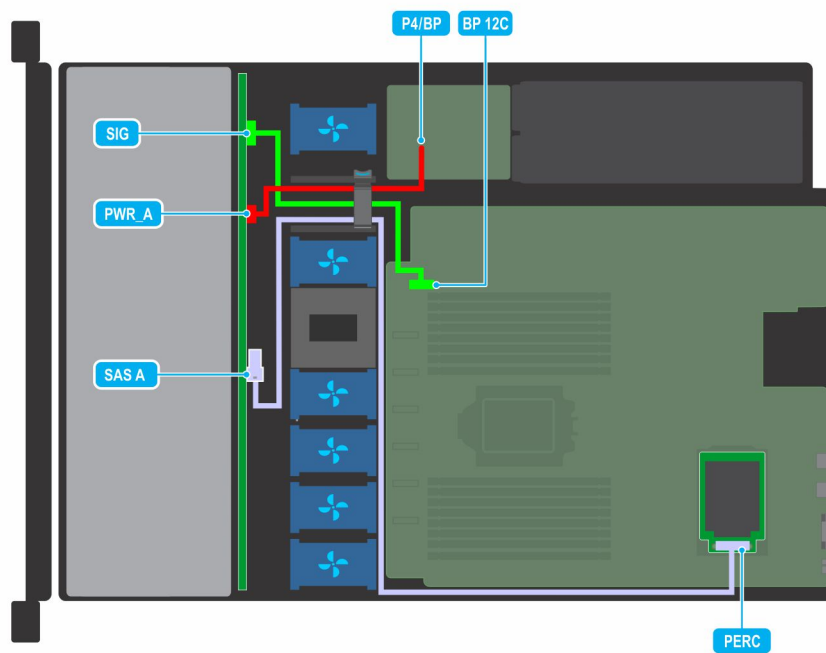

Figure 38. Cable routing - 4 x 3.5-inch drive backplane to the mini-PERC card

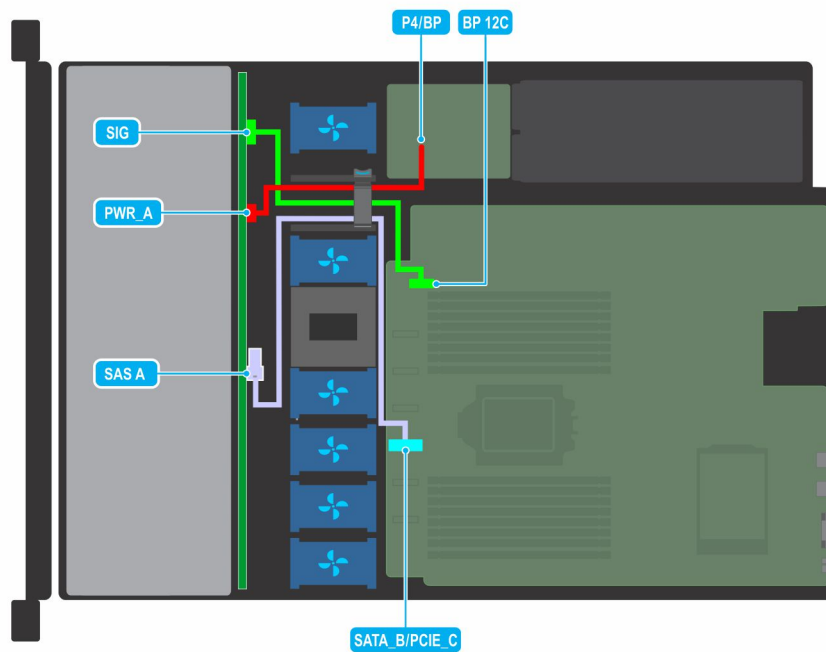

Figure 39. Cable routing - 4 x 3.5-inch drive backplane to the onboard controller

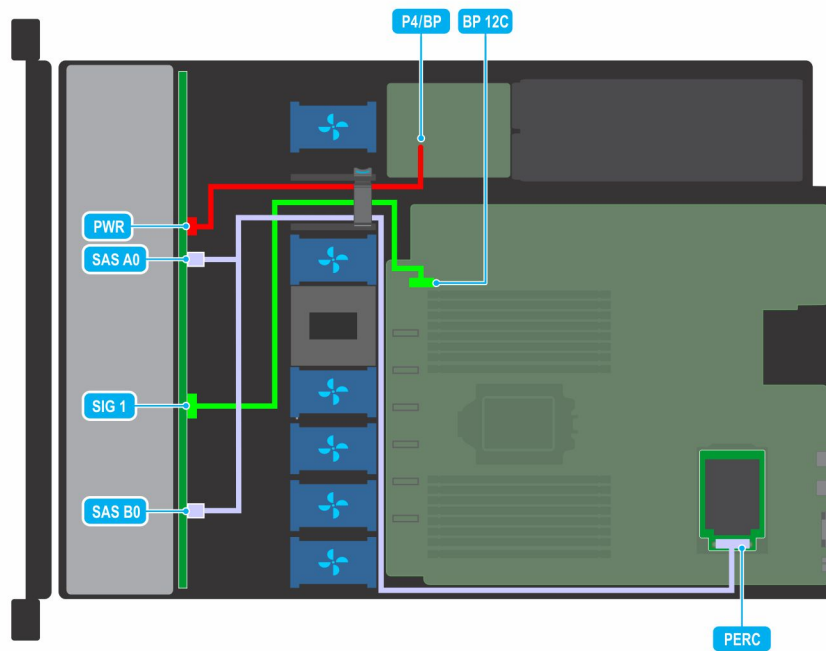

Figure 40. Cable routing - 8 x 2.5-inch drive backplane to the mini-PERC card

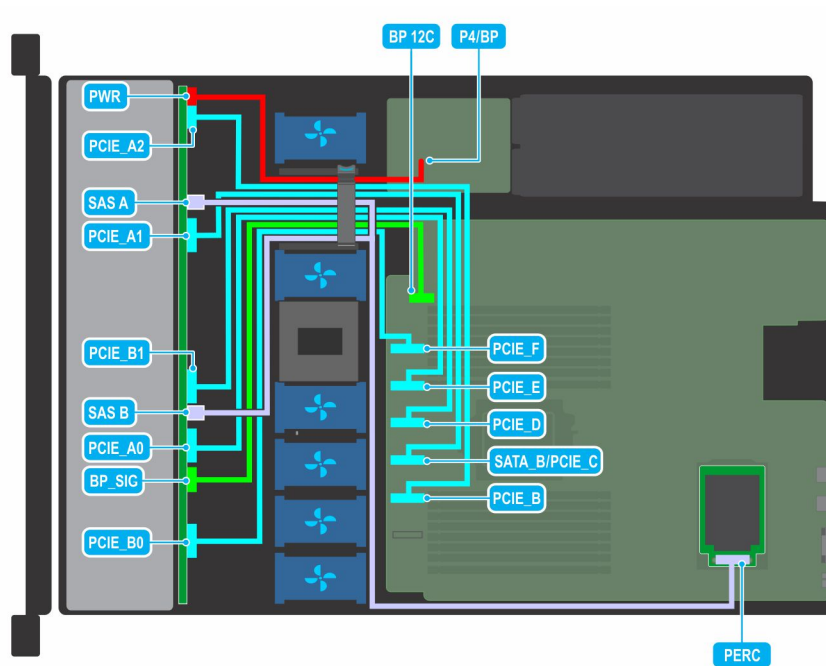

Figure 41. Cable routing - 10 x 2.5-inch drive backplane to the onboard controller (NVMe)

## System memory

### System memory guidelines

The PowerEdge R6515 system supports DDR4 registered DIMMs (RDIMMs) and load reduced DIMMs (LRDIMMs). System memory holds the instructions that are executed by the processor.

Your system memory is organized into eight channels per processor (two memory sockets per channel) for a total of 16 memory sockets per processor. In each channel, the 1st socket is marked white and the 2nd socket black.

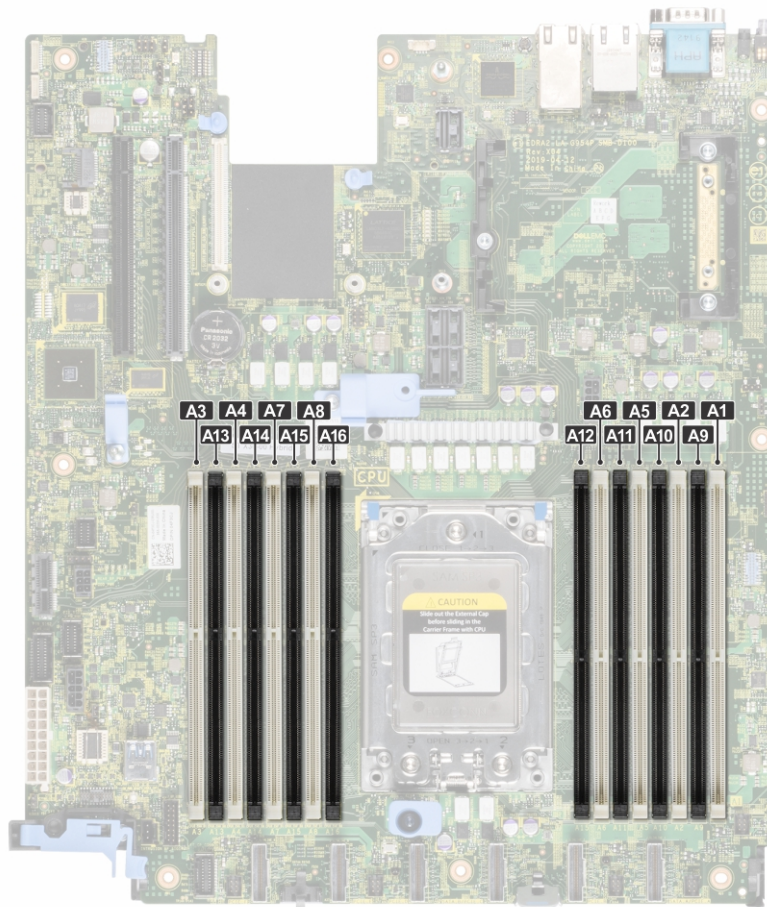

**Figure 42. Memory socket location**

Memory channels are organized as follows:

**Table 38. Memory channels**

Processor	Channel A	Channel B	Channel C	Channel D	Channel E	Channel F	Channel G	Channel H
AMD Processor	Slots 6 and 12	Slots 5 and 11	Slots 2 and 10	Slots 1 and 9	Slots 8 and 16	Slots 7 and 15	Slots 4 and 14	Slots 3 and 13

**Table 39. Supported memory matrix**

DIMM type	Rank type	Capacity	DIMM rated voltage and speed	Operating Speed	
				1 DIMMs per Channel (DPC)	2 DIMMs per Channel (DPC)
RDIMM	1R	8 GB	DDR4 (1.2V), 3200 MT/s	3200 MT/s	2933 MT/s
	2R	16 GB, 32 GB, 64 GB	DDR4 (1.2V), 3200 MT/s	3200 MT/s	2933 MT/s
LRDIMM	8R	128 GB	DDR4 (1.2V), 2666 MT/s	2666 MT/s	2666 MT/s

# General memory module installation guidelines

To ensure optimal performance of your system, observe the following general guidelines when configuring your system memory. If your system's memory configurations fail to observe these guidelines, your system might not boot, stop responding during memory configuration, or operate with reduced memory. This section provides information on the memory population rules and about the non-uniform memory access (NUMA) for single or dual processor system.

The memory bus may operate at speeds of 3200 MT/s, 2933 MT/s, or 2666 MT/s depending on the following factors:

- System profile selected (for example, Performance Optimized, or Custom [can be run at high speed or lower])
- Maximum supported DIMM speed of the processors
- Maximum supported speed of the DIMMs

**NOTE: MT/s indicates DIMM speed in MegaTransfers per second.**

The system supports Flexible Memory Configuration, enabling the system to be configured and run in any valid chipset architectural configuration. The following are the recommended guidelines for installing memory modules:

- All DIMMs must be DDR4.
- Mixing of memory module capacities in a system is not supported.
- If memory modules with different speeds are installed, they operate at the speed of the slowest installed memory module(s).
- Populate memory module sockets only if a processor is installed.
  - For single-processor systems, sockets A1 to A16 are available.
  - In Optimizer Mode, the DRAM controllers operate independently in the 64-bit mode and provide optimized memory performance.

**Table 40. Memory population rules**

Processor	Configuration	Memory population	Memory population information
Single processor	Optimizer (Independent channel) population order	1, 2, 3, 4, 5, 6, 7, 8, 9, 10, 11, 12, 13, 14, 15, 16	Odd amount of DIMMs per processor allowed.

- Populate all the sockets with white release tabs first, followed by the black release tabs.
- Unbalanced or odd memory configuration results in a performance loss and system may not identify the memory modules being installed, so always populate memory channels identically with identical electrical specification DIMMs for best performance.
- Minimum recommended configuration is to populate four identical electrical specifications memory modules per processor. AMD recommends limiting processors in that system to 32 cores or less.
- Populate eight identical electrical specification memory modules per processor (one DIMM per channel) at a time to maximize performance.

## Non-uniform memory access (NUMA)

Non-uniform memory access (NUMA) is a memory design used in multi-processing, where the memory access time depends on the memory location relative to the processor. In NUMA, a processor can access its own local memory faster than the non-local memory.

NUMA nodes per socket (NPS)

NUMA nodes per socket (NPS) is a new feature added that allows you to configure the memory NUMA domains per socket. The configuration can consist of one whole domain (NPS1), two domains (NPS2), or four domains (NPS4). In the case of a two-socket platform, an additional NPS profile is available to have whole system memory to be mapped as single NUMA domain (NPS0).

In the processors, each physical processor package contains multiple processor cores that are grouped together into core complexes and core complex dies. A core complex (CCX) consists of maximum four processor cores and an L3 cache memory. A core complex die (CCD) contains two CCXs. The physical processor package contains maximum eight core CCDs. A max CCD x CCX x Core processor will have 64 cores. The BIOS setup allows for the selection of an NPS profile based on down core profile and by processor SKU.

**Table 41. NPS options per processor SKU or down core configuration**

Cores	CCDs x CCXs x Cores/CCX	NPSx options - Single processor
64	8x2x4	4, 2, 1
48	6x2x4	2, 1
32	4x2x4	4, 2, 1
24	3x2x4	1

Cores	CCDs x CCXs x Cores/CCX	NPSx options - Single processor
16	2x2x4	2, 1
16	4x2x2	4, 2, 1
8	4x2x1	4, 2, 1
8	2x2x2	2, 1

**NOTE:** If the system configuration does not support an NPS profile, the options are not displayed until the configuration changes.

**NOTE:** If there is a memory training failure, configuration change, or processor swap that no longer supports a specific NPS profile, an error message is displayed at the end of POST and logged in the LifeCycle Controller.

Interleaving option

Based on the NPSx selection, the PSP firmware selects the corresponding preferred memory interleaving. If the memory configuration does not allow the preferred option (Example: a channel is not populated or one or more DIMMs on a channel does not initialize or train properly), the pre-BIOS firmware selects the corresponding alternate memory interleaving option.

**Table 42. Interleaving Options Based on NPSx**

NPSx	Preferred	Alternate
4	2-channel	None
2	4-channel	2-channel
1	8-channel	4-channel, 2-channel

Two channel interleaving (per quadrant) - NPS4 and fallback for NPS2/1/0

- This interleaves two channels in each quadrant.
- Does not require the memory to be equal on both channels of a quadrant. Any non-symmetrical DIMM is stacked on top.
- Any quadrant where one of the two channels is not populated is not interleaved.
- There is no alternate, as all configurations can be mapped into this mode.

Four channel interleaving (per half-socket) - NPS2

- This interleaves the four channels on the left or right half of a socket. As an alternative option from NPS1 only, the four channels {CS A, B, C, D} may be interleaved.
- Requires all four channels to be populated with equal size memory.
- There is no requirement that the two halves have equal size memory with respect to each other.
- The system has support for one half to have no memory.

Eight channel interleaving (per socket) - NPS1

- This interleaves eight channels in a socket.

**NOTE:** {CS A, B, C, D} and {CS E, F, G, H} is only recommended as a memory population if all eight channels are populated as NPS2.

**NOTE:** It is recommended that all channels must be populated (CS A, B, C, D, E, F, G, H) for NPS1, but NPS1 does support a 4 channel configuration of (CS C, D, G, H) but does not have optimal performance.

- Requires all populated channels in a socket to have equal size memory.
- Single processor system creates a single NUMA node for the system, the SRAT and SLIT table are not required.

CCX/Last-Level Cache (LLC) as NUMA domains

In addition to selecting the number of NUMA domains via NPS option, the processor allows for making memory per CCX as NUMA domain. In the processor each CCD has a maximum of two CCXs with each CCX having a shared last-level cache (LLC, or L3 cache) for all cores. The CCX as NUMA domain option allows for each LLC to be configured as a NUMA domain so that for certain workloads pinning execution to a single NUMA domain can be done.

The total amount of memory for each default NUMA node is divided by the number of CCXs within each CCD and distributed equally to each new per-CCX. The max number of NUMA domains generated will based on how many CCD and CCX are fused for that processor SKU.

# Removing a memory module

## Prerequisites

1. Follow the safety guidelines listed in the [Safety instructions](#).
2. Follow the procedure listed in the [Before working inside your system](#).
3. [Remove the air shroud](#).

**⚠ WARNING:** The memory modules are hot to touch for some time after the system has been powered off. Allow the memory modules to cool before handling them.

## Steps

1. Locate the appropriate memory module socket.
2. To release the memory module from the socket, simultaneously press the ejectors on both ends of the memory module socket to fully open.

**⚠ CAUTION:** Handle each memory module only by the card edges, ensuring not to touch the middle of the memory module or metallic contacts.

3. Lift the memory module away from the system.

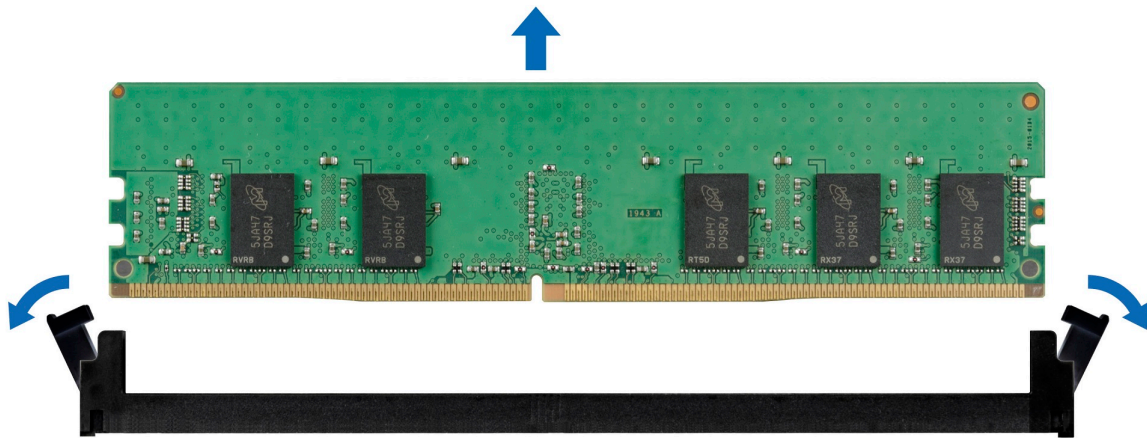

Figure 43. Removing a memory module

## Next steps

[Replace the memory module.](#)

# Installing a memory module

## Prerequisites

1. Follow the safety guidelines listed in the [Safety instructions](#).
2. Follow the procedure listed in the [Before working inside your system](#).
3. [Remove the air shroud](#).

## Steps

1. Locate the appropriate memory module socket.

**⚠ CAUTION:** Handle each memory module only by the card edges, ensuring not to touch the middle of the memory module or metallic contacts.

2. If a memory module is installed in the socket, remove it.

**i NOTE:** Ensure the socket ejector latches are fully open, before installing the memory module.

3. Align the edge connector of the memory module with the alignment key of the memory module socket, and insert the memory module in the socket.

**CAUTION:** To prevent damage to the memory module or the memory module socket during installation, do not bend or flex the memory module; insert both ends of the memory module simultaneously.

**NOTE:** The memory module socket has an alignment key that enables you to install the memory module in the socket in only one orientation.

**CAUTION:** Do not apply pressure at the center of the memory module; apply pressure at both ends of the memory module evenly.

4. Press the memory module with your thumbs until the ejectors firmly click into place. When the memory module is properly seated in the socket, the levers on the memory module socket align with the levers on the other sockets that have memory modules installed.

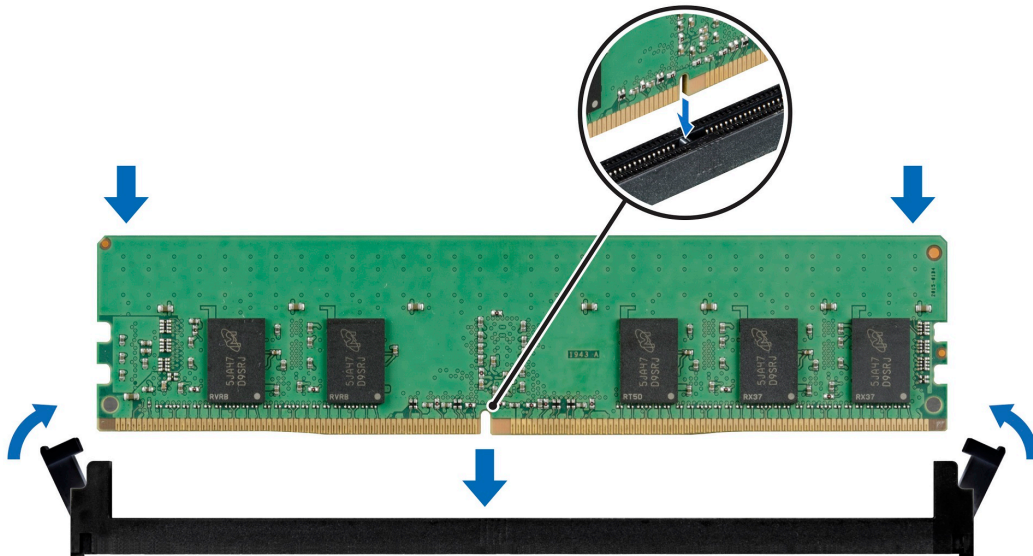

Figure 44. Installing a memory module

#### Next steps

1. [Install the air shroud.](#)
2. Follow the procedure listed in [After working inside your system.](#)
3. To verify if the memory module has been installed properly, press F2 and navigate to **System Setup Main Menu > System BIOS > Memory Settings**. In the **Memory Settings** screen, the System Memory Size must reflect the updated capacity of the installed memory.
4. If the System Memory Size is incorrect, one or more of the memory modules may not be installed properly. Ensure that the memory modules are firmly seated in their sockets.
5. Run the system memory test in system diagnostics.

## Processor and heat sink

### Removing a heat sink

#### Prerequisites

1. Follow the safety guidelines listed in the [Safety instructions.](#)
  2. Follow the procedure listed in the [Before working inside your system.](#)
  3. [Remove the air shroud.](#)
- NOTE:** The heat sink and processor are too hot to touch for some time after the system has been powered down. Allow the heat sink and processor to cool down before handling them.



## Steps

1. Using a Torx #T20 screwdriver, loosen the captive screws in the order mentioned on the heat sink:

**NOTE:** The captive screw numbers are marked on the heat sink.

- a) Partially loosen the captive screws 1 and 2 (approximately 3 turns).
  - b) Partially loosen the captive screws 3 and 4 (approximately 3 turns).
  - c) Loosen the captive screws 1 and 2 completely.
  - d) Loosen the captive screws 3 and 4 completely.
2. Lift the heat sink from the system.

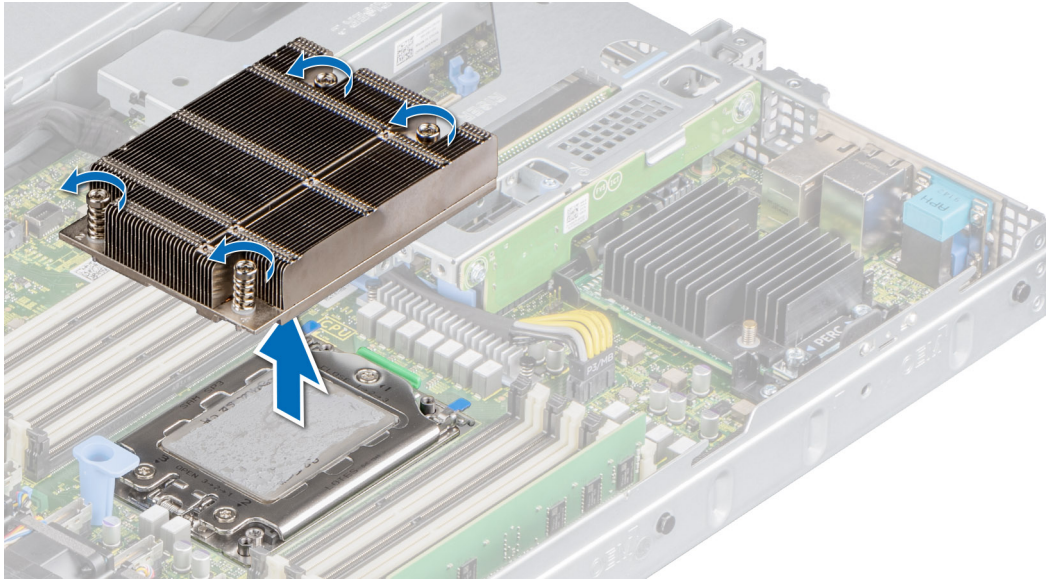

Figure 45. Removing a heat sink

## Next steps

If you are removing a faulty heat sink, replace the heat sink, if not, remove the processor.

# Removing the AMD processor

## Prerequisites

**WARNING:** The heat sink may be hot to touch for some time after the system has been powered off. Allow the heat sink to cool before removing it.

1. Follow the safety guidelines listed in the [Safety instructions](#).
2. Follow the procedure listed in the [Before working inside your system](#).
3. [Remove the air shroud](#).
4. [Remove the heat sink](#).

**CAUTION:** You may find the CMOS battery loss or CMOS checksum error displayed during the first instance of powering on the system after the processor or system board replacement which is expected. To fix this, simply go to setup option to configure the system settings.

## Steps

1. Using a Torx #T20 screwdriver, loosen the screws to release the force plate. The sequence to loosen the screws is 3, 2, and 1.

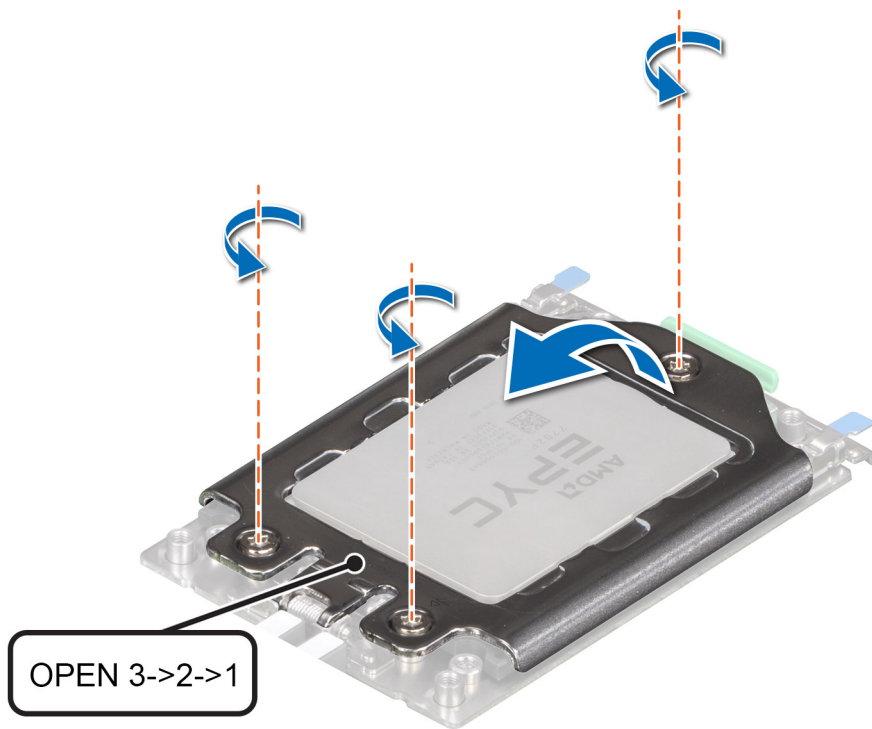

**Figure 46. Removing screws on the force plate**

2. Release the processor socket rail frame by lifting up the blue latches.

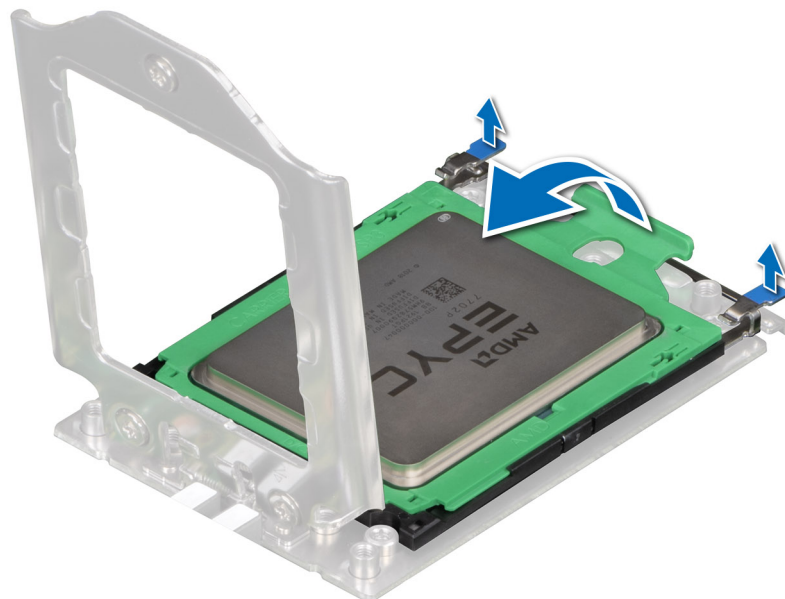

**Figure 47. Lifting the rail frame**

3. Holding the blue tab on the processor tray, slide the tray out of the rail frame.

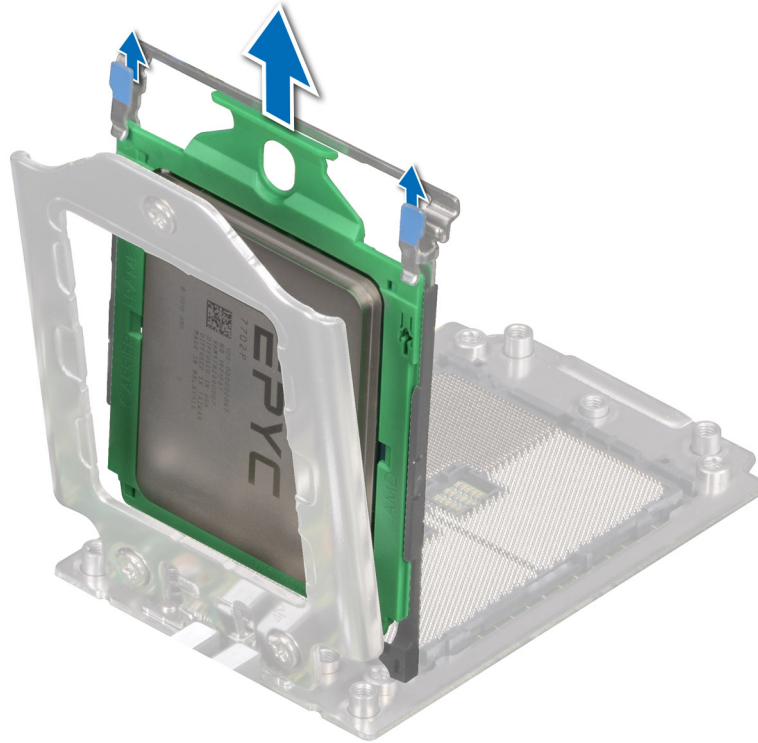

**Figure 48. Removing the processor tray**

**Next steps**

Replace the AMD processor.

## Installing the AMD processor

**Prerequisites**

1. Follow the safety guidelines listed in the [Safety instructions](#).
2. Follow the procedure listed in [Before working inside your system](#).

**Steps**

1. Holding the blue tab on the processor tray, slide the tray into the processor socket rail frame until firmly seated.

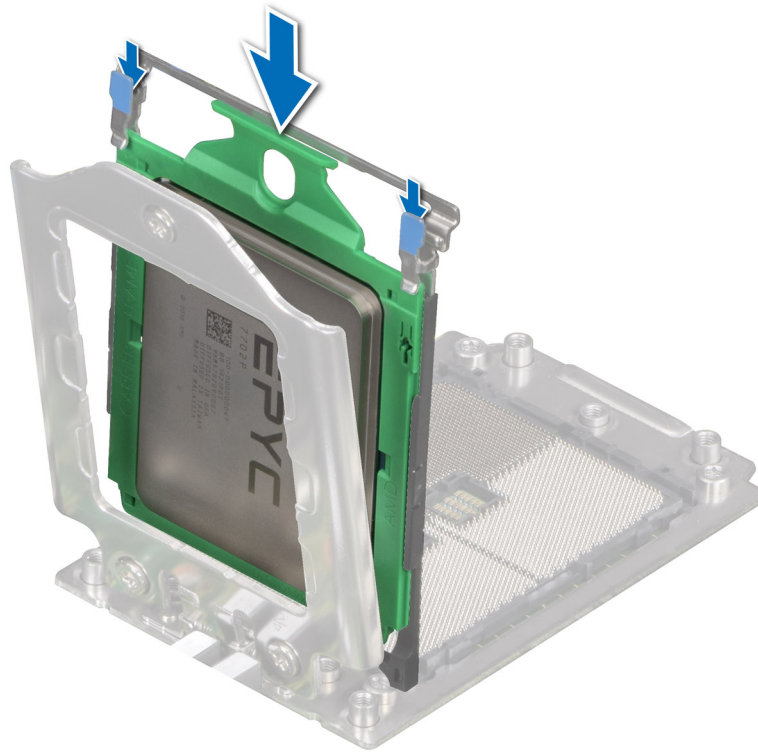

**Figure 49. Placing the processor tray into the rail frame**

2. Push the rail frame down until the blue latches lock into place.

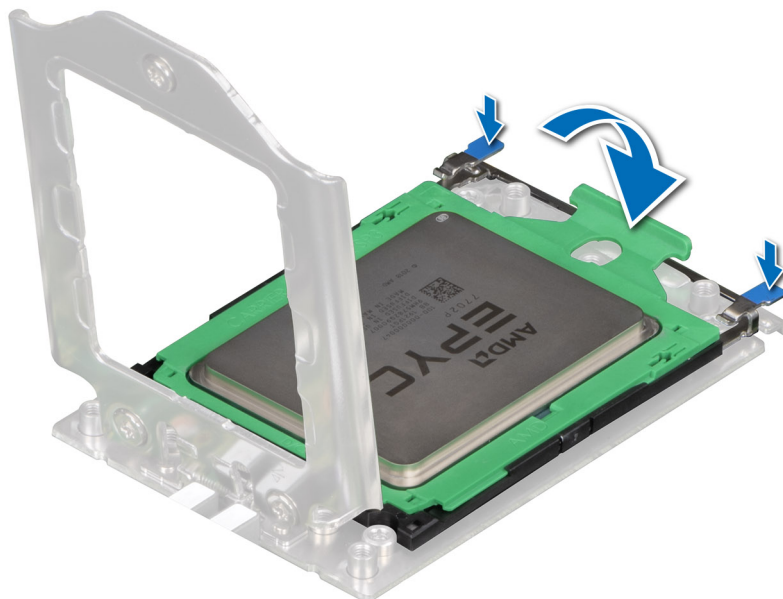

**Figure 50. Closing the rail frame**

3. Secure the force plate to the processor socket base by tightening the screws in the sequence 1, 2, and 3. When all three screws are fully threaded, the socket is then actuated. The three screws are tightened to a torque value of  $12.0 \pm 1.0$  lbf-in.

**NOTE:** Press the force plate while tightening the screws to avoid tilting of the processor cover out of the processor socket.

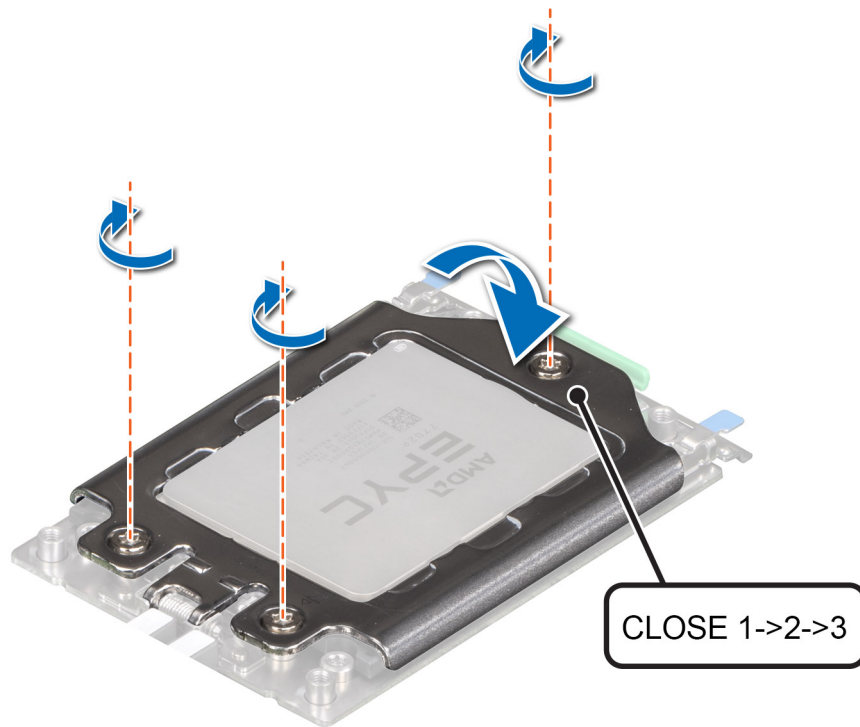

**Figure 51. Securing the force plate**

#### Next steps

1. [Install the heat sink.](#)
2. [Install the air shroud.](#)
3. Follow the procedure listed in [After working inside your system.](#)

## Installing the heat sink

#### Prerequisites

Never remove the heat sink from a processor unless you intend to replace the processor or system board. The heat sink is necessary to maintain proper thermal conditions.

1. Follow the safety guidelines listed in the [Safety instructions.](#)
2. Follow the procedure listed in the [Before working inside your system.](#)
3. [Remove the air shroud.](#)
4. If installed, remove the processor dust cover.

#### Steps

1. If you are using an existing heat sink, remove the thermal grease on the heat sink by using a clean lint-free cloth.

**NOTE:** For a new heat sink, the thermal paste is pre-applied to the heat sink. Remove the protective cover and install the heat sink.

2. Use the thermal grease syringe included with your processor kit to apply the grease in a thin spiral on the top of the processor.

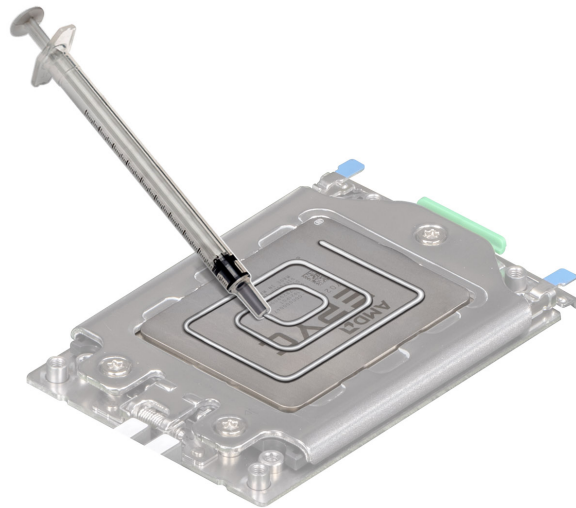

**CAUTION:** Applying too much thermal grease can result in excess grease coming in contact with and contaminating the processor socket.

**NOTE:** The thermal grease syringe is intended for single use only. Dispose of the syringe after you use it.

- Align the heat sink with the screw holes on the processor plate. The captive screws on the heat sink should align with the screw holes on the processor plate.
- Using a Torx #T20 screwdriver, tighten the captive screws in the order mentioned below:

**NOTE:** The captive screw numbers are marked on the heat sink.

- Partially tighten the captive screws 1 and 2 (approximately 3 turns).
- Partially tighten the captive screws 3 and 4 (approximately 3 turns).
- Tighten the captive screws 1 and 2 completely.
- Tighten the captive screws 3 and 4 completely.

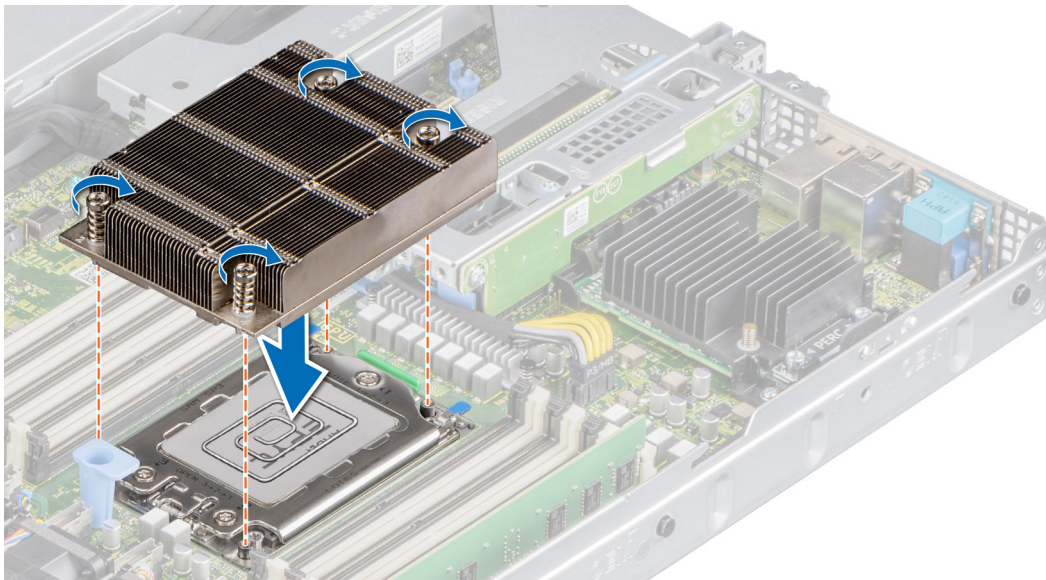

**Figure 52. Installing the heat sink**

#### Next steps

- Install the air shroud.
- Follow the procedure listed in the [After working inside your system](#).

# Expansion cards and expansion card risers

**NOTE:** A system event entry is logged in the iDRAC Lifecycle Controller if an expansion card riser is not supported or missing. It does not prevent your system from turning on. However, if a F1/F2 pause occurs with an error message, see *Troubleshooting expansion cards* section in the *Dell EMC PowerEdge Servers Troubleshooting Guide* at [www.dell.com/poweredgemanuals](http://www.dell.com/poweredgemanuals).

## Expansion card installation guidelines

The following table describes the supported expansion cards:

**Table 43. Expansion card riser configurations**

Expansion card riser	PCIe slots on the riser	Processor connection	Height	Length	Slot width
No riser	Slot 1	Processor 1	-	-	x8
Riser 1A	Slot 2	Processor 1	Low Profile	Half Length	x16
Riser 2	Slot 3	Processor 1	Low Profile	Half Length	x16

**NOTE:** The expansion-card slots are not hot-swappable.

The following table provides guidelines for installing expansion cards to ensure proper cooling and mechanical fit. The expansion cards with the highest priority should be installed first using the slot priority indicated. All the other expansion cards should be installed in the card priority and slot priority order.

**Table 44. No riser configuration (Slot 1)**

Card type	Slot priority	Maximum number of cards
PERC9 (H330, HBA 330, H730P)	Internal Slot	1
PERC10 (H740P)	Internal Slot	1
LOM Riser (1G/10G/25G)	1	1

**Table 45. Riser configuration (include slots 1 and 2)**

Card type	Slot priority	Maximum number of cards
PERC9 (H330, HBA 330, H730P)	Internal Slot	1
PERC10 (H740P)	Internal Slot	1
NVME PCIE SSD	2	1
Broadcom (1G DP/1G QP)	2	1
Broadcom (10G DP)	2	1
Broadcom (25G DP)	2	1
Intel 10G (BaseT DP/QP)	2	1
Intel 10G (SFP+ DP/QP)	2	1
Intel 1G (DP/QP)	2	1
Emulex (FC32 2P)	2	1
Emulex (FC16 1P)/(FC16 2P)	2	1
Emulex (FC8 SC)/(FC8 DLC)	2	1

Card type	Slot priority	Maximum number of cards
Mellanox 10G, CXP DP SFP	2	1
Mellanox 25G, CX4LX DP SFP	2	1
Qlogic 10G BASET DP	2	1
Qlogic 10G SFP+ DP	2	1
Qlogic 25G SFP DP	2	1
Qlogic (FC8 DCL)	2	1
Qlogic (FC16 SP/DP)	2	1
Qlogic (FC32 DP)	2	1
LOM Riser ( 2x1G)/(2x10G)/(2x25G)	1	1

**Table 46. Riser configuration (include slots 1,2, and 3)**

Card type	Slot priority	Maximum number of cards
PERC9 (H330, HBA 330, H730P)	Internal Slot	1
PERC10 (H740P)	Internal Slot	1
NVME PCIE SSD	2,3	2
Broadcom (1G DP/1G QP)	2,3	2
Broadcom (10G DP)	2,3	2
Broadcom (25G DP)	2,3	2
Intel 10G (BaseT DP/QP)	2,3	2
Intel 10G (SFP+ DP/QP)	2,3	2
Intel 1G (DP/QP)	2,3	2
Emulex (FC32 2P)	2,3	2
Emulex (FC16 1P)/(FC16 2P)	2,3	2
Emulex (FC8 SC)/(FC8 DLC)	2,3	1
Mellanox 10G, CXP DP SFP	2,3	2
Mellanox 25G, CX4LX DP SFP	2,3	2
Qlogic 10G BASET DP	2,3	2
Qlogic 10G SFP+ DP	2,3	2
Qlogic 25G SFP DP	2,3	2
Qlogic (FC8 DCL)	2,3	2
Qlogic (FC16 SP/DP)	2,3	2
Qlogic (FC32)	2,3	2
LOM Riser ( 2x1G)/(2x10G)/(2x25G)	1	1

## Removing the expansion card risers

### Prerequisites

1. Follow the safety guidelines listed in the [Safety instructions](#).
2. Follow the procedure listed in the [Before working inside your system](#).



3. Remove the air shroud.
4. Disconnect any cables connected to the expansion card.

**Steps**

Hold the touch points, and lift the expansion card riser from the riser connector on the system board.



Figure 53. Removing the low profile left riser

- ⓘ **NOTE:** For low profile riser right, first loosen the captive screw and then holding the touch points lift the riser away from the system.
- ⓘ **NOTE:** The numbers on the image does not depict the exact steps. The numbers are just for representation of sequence.

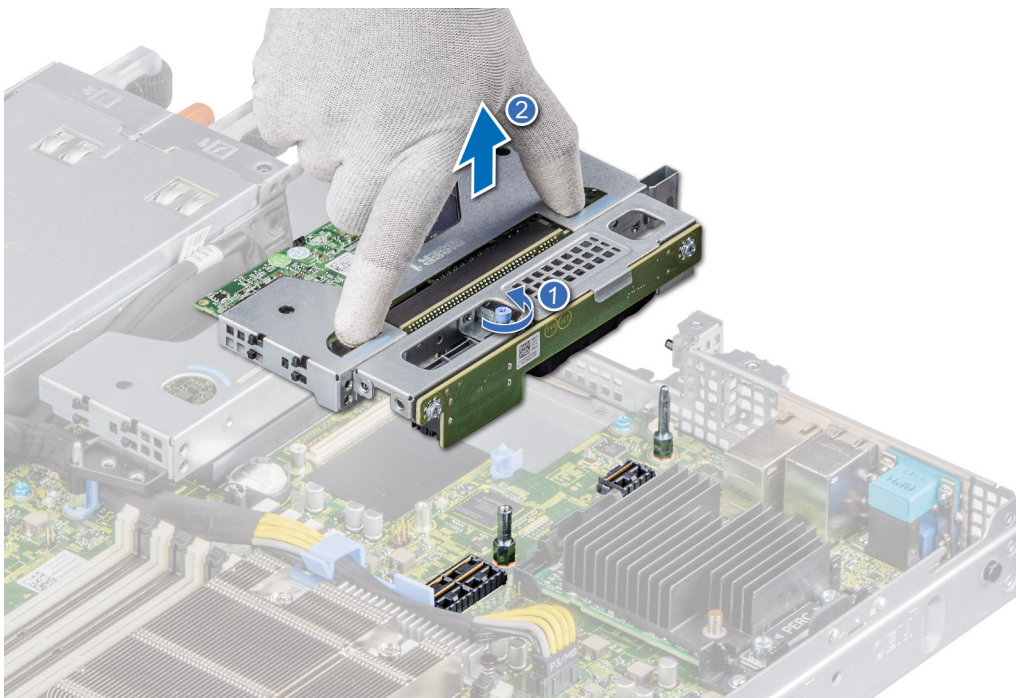

Figure 54. Removing the low profile right riser

## Next steps

Replace the expansion card riser.

# Installing the expansion card risers

## Prerequisites

1. Follow the safety guidelines listed in the [Safety instructions](#).
2. Follow the procedure listed in the [Before working inside your system](#).
3. If removed, install the expansion cards into the expansion card risers.

## Steps

1. Holding the touch points, align the expansion card riser with the connector and the riser guide pin on the system board.
2. Lower the expansion card riser into place until the expansion card riser connector is fully seated in the connector.

**NOTE:** The numbers on the image does not depict the exact steps. The numbers are just for representation of sequence.



Figure 55. Installing the low profile left riser

**NOTE:** For low profile riser right, tighten the captive screw to secure the riser to the system board.

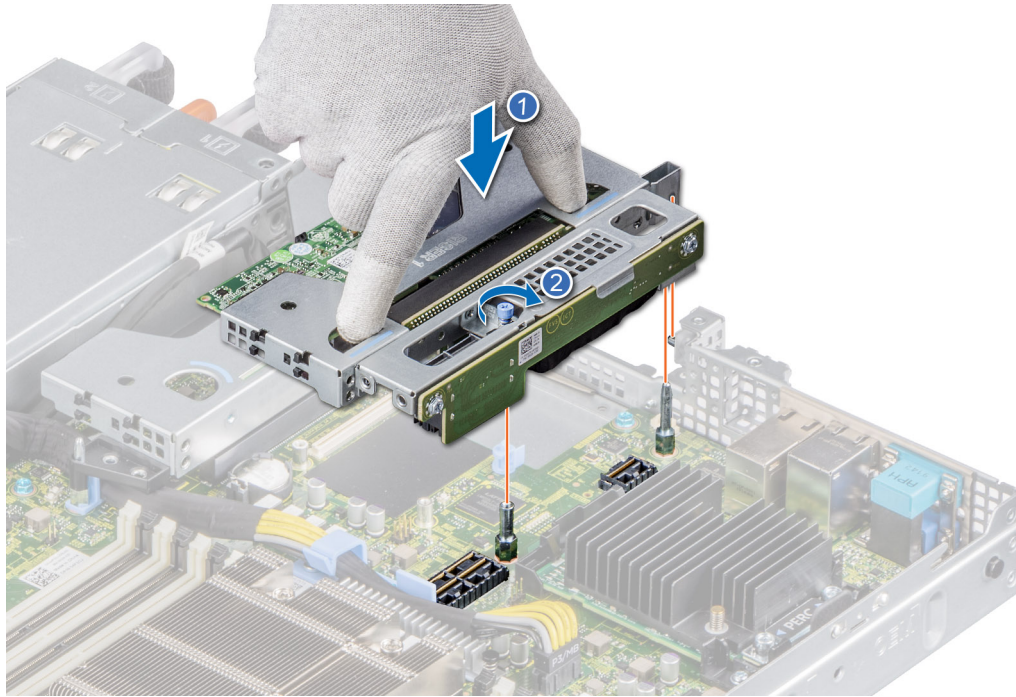

**Figure 56. Installing the low profile right riser**

#### Next steps

1. If required, re-connect the cables to the expansion card.
2. [Install the air shroud.](#)
3. Follow the procedure listed in [After working inside your system.](#)
4. Install any device drivers required for the card as described in the documentation for the card.

## Removing expansion card from the expansion card riser

#### Prerequisites

1. Follow the safety guidelines listed in the [Safety instructions.](#)
2. Follow the procedure listed in the [Before working inside your system.](#)
3. [Remove the air shroud.](#)
4. If applicable, disconnect the cables from the expansion card.

#### Steps

1. Pull and lift up the expansion card retention latch lock to open.
2. Hold the expansion card by its edges and pull the card until the card edge connector disengages from the expansion card connector on the riser.



**NOTE:** The numbers on the image does not depict the exact steps. The numbers are just for representation of sequence.

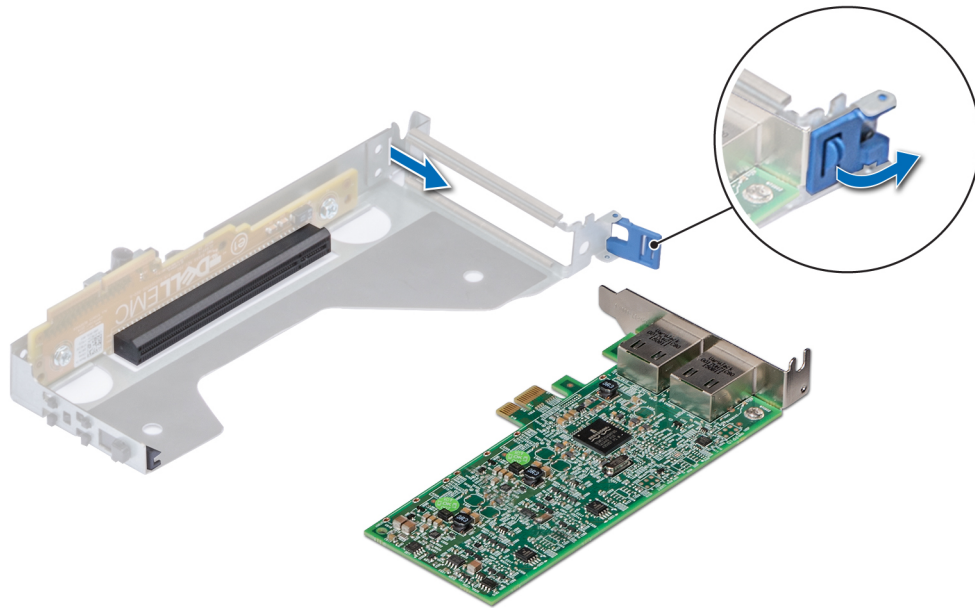

Figure 57. Removing an expansion card from the low profile left riser

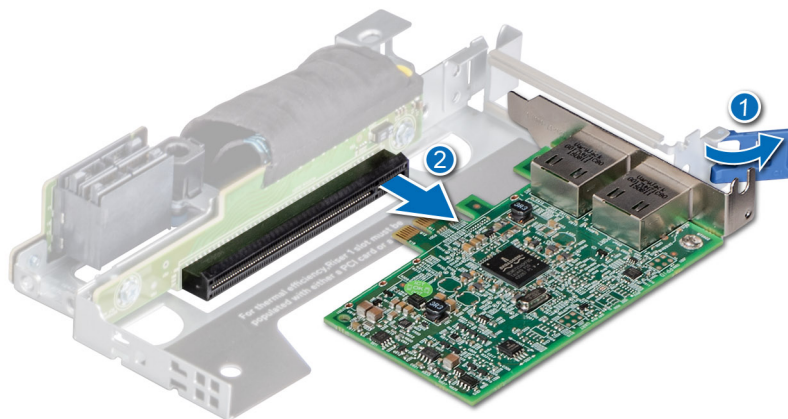

Figure 58. Removing an expansion card from the low profile right riser

3. If the expansion card is not going to be replaced, install a filler bracket and close the card retention latch.

**NOTE:** You must install a filler bracket over an empty expansion card slot to maintain Federal Communications Commission (FCC) certification of the system. The brackets also keep dust and dirt out of the system and aid in proper cooling and airflow inside the system.

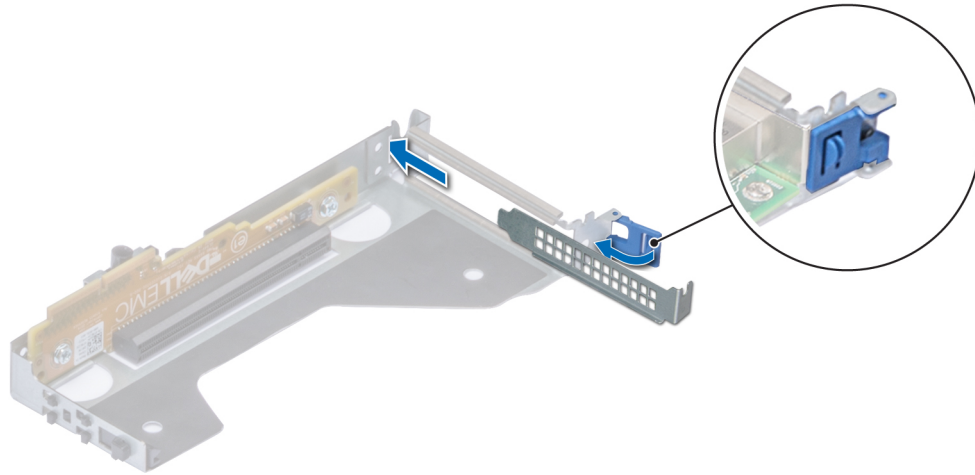

Figure 59. Installing filler bracket in the low profile left riser

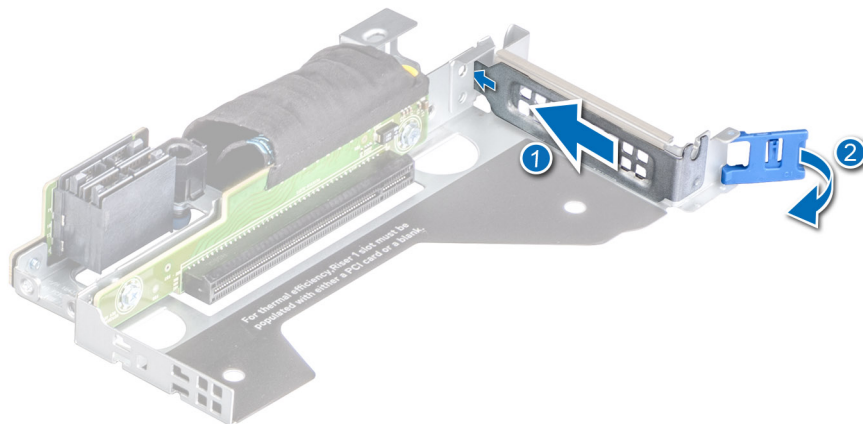

Figure 60. Installing filler bracket in the low profile right riser

### Next steps

If applicable, install an expansion card into the expansion card riser.

## Installing an expansion card into the expansion card riser

### Prerequisites

1. Follow the safety guidelines listed in the [Safety instructions](#).
2. Follow the procedure listed in the [Before working inside your system](#).
3. If installing a new expansion card, unpack it and prepare the card for installation.

**NOTE:** For instructions, see the documentation accompanying the card.

### Steps

1. Pull and lift up the expansion card retention latch lock to open.

2. If installed, remove the filler bracket.

**NOTE:** Store the filler bracket for future use. Filler brackets must be installed in empty expansion card slots to maintain Federal Communications Commission (FCC) certification of the system. The brackets also keep dust and dirt out of the system and aid in proper cooling and airflow inside the system.

**NOTE:** The numbers on the image does not depict the exact steps. The numbers are just for representation of sequence.

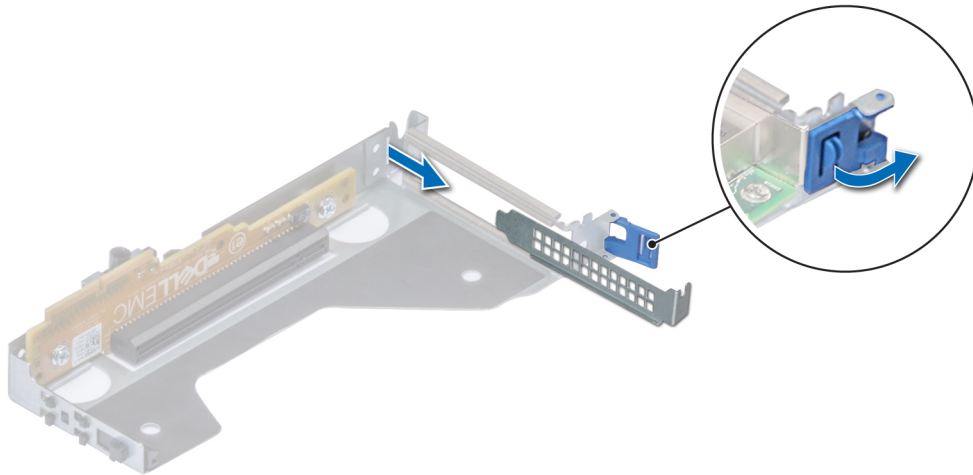

Figure 61. Removing a filler bracket from a low profile left riser

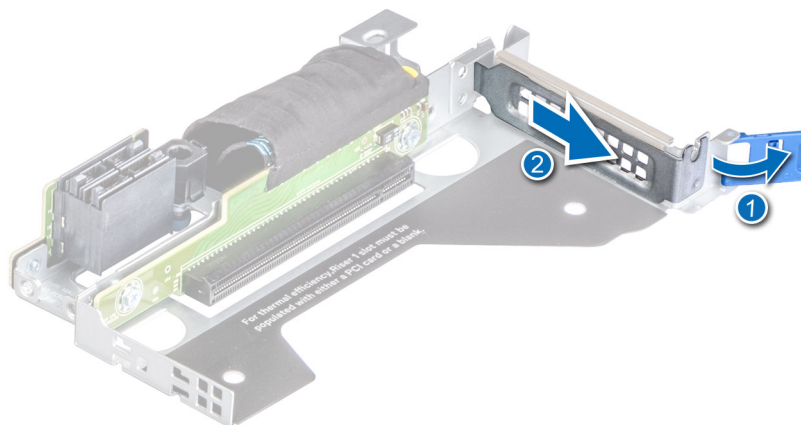

Figure 62. Removing a filler bracket from a low profile right riser

3. Hold the card by the edges, and align the card edge connector with the expansion card connector on the riser.
4. Insert the card edge connector firmly into the expansion card connector until the card is fully seated.
5. Close the expansion card retention latch.

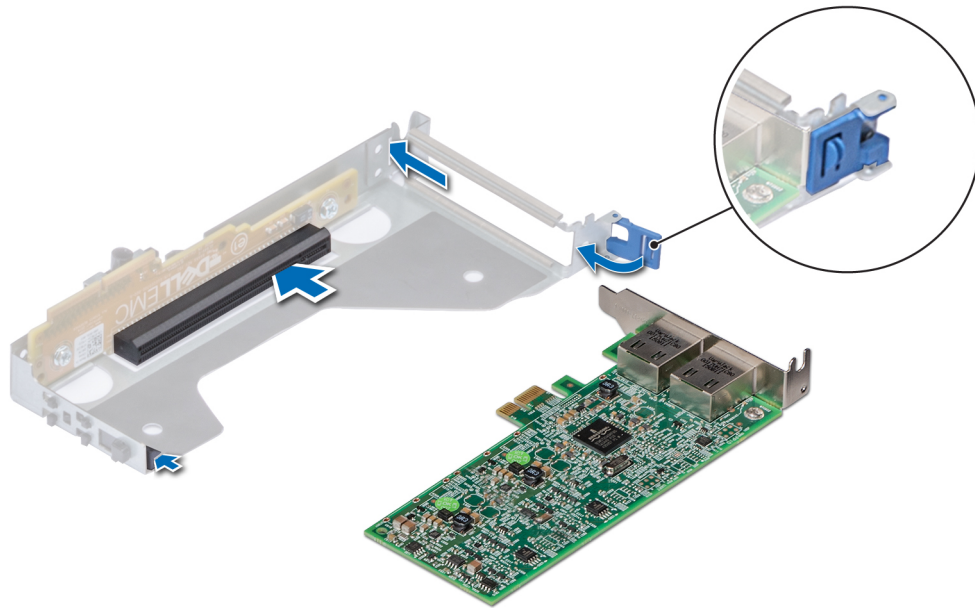

Figure 63. Installing an expansion card into a low profile left riser

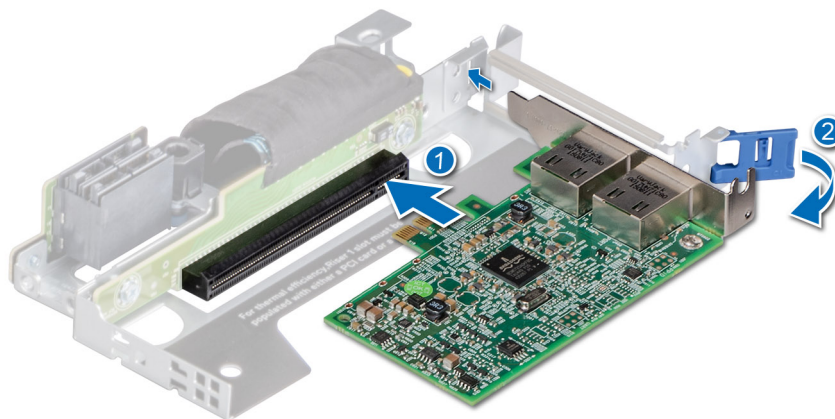

Figure 64. Installing an expansion card into a low profile right riser

#### Next steps

1. If applicable, connect the cables to the expansion card.
2. [Install the air shroud.](#)
3. Follow the procedure listed in [After working inside your system.](#)
4. Install any device drivers required for the card as described in the documentation for the card.

**NOTE:** While replacing faulty storage controller/FC/NIC card with the same type of card, after you power on the system; the new card automatically updates to the same firmware and configuration of the faulty one. For more information about the Part replacement configuration, see the *Lifecycle Controller User's Guide* at [www.dell.com/idracmanuals](http://www.dell.com/idracmanuals)

## Micro SD card

# Removing the MicroSD card

## Prerequisites

1. Follow the safety guidelines listed in the [Safety instructions](#).
2. Follow the procedure listed in the [Before working inside your system](#).
3. [Remove the air shroud](#).
4. [Remove the IDSDM module](#).

## Steps

1. Locate the MicroSD card slot on the IDSDM module, and press the card to partially release it from the slot. For more information on the slot location, see System board jumpers and connectors section.
2. Hold the MicroSD card and remove it from the slot..

**i** **NOTE:** Temporarily label each MicroSD card with its corresponding slot number after removal.

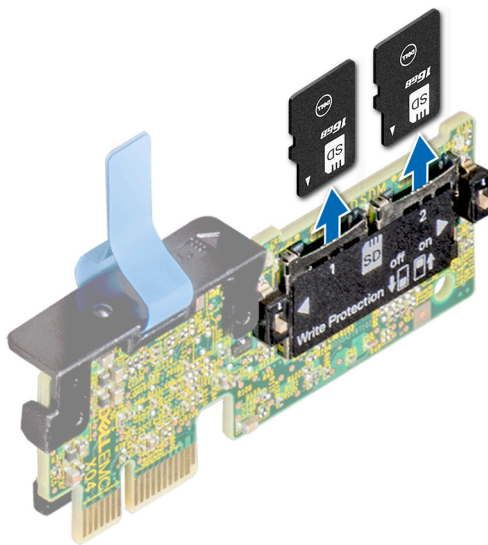

Figure 65. Removing the MicroSD card

## Next steps

Install the MicroSD cards.

# Installing the MicroSD card

## Prerequisites

1. Follow the safety guidelines listed in the [Safety instructions](#).
2. Follow the procedure listed in [Before working inside your system](#).
3. [Remove the air shroud](#).

**i** **NOTE:** To use an MicroSD card with your system, ensure that the Internal SD Card Port is enabled in System Setup.

**i** **NOTE:** Ensure that you install the MicroSD cards into the same slots based on the labels you had marked on the cards during removal.

## Steps

1. Locate the MicroSD card slot on the IDSDM module. Orient the MicroSD card appropriately and insert the contact-pin end of the card into the slot. To locate IDSDM, see the System board jumpers and connectors section.



**NOTE:** The slot is keyed to ensure correct insertion of the card.

2. Press the card into the slot to lock it into place.

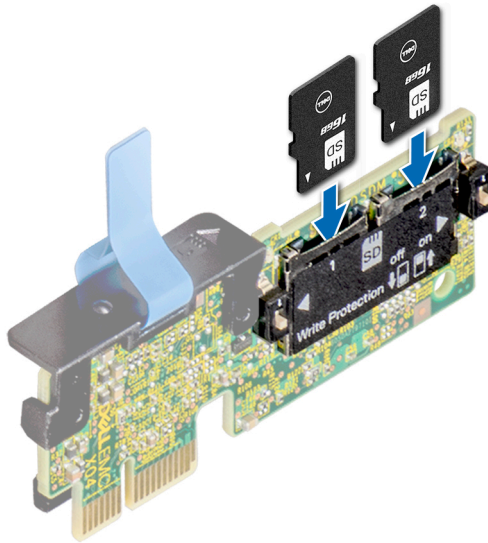

**Figure 66. Installing the MicroSD card**

#### Next steps

1. Install the IDSDM module.
2. Install the air shroud.
3. Follow the procedure listed in the [After working inside your system](#).

## M.2 SSD module

### Removing the M.2 SSD module

#### Prerequisites

1. Follow the safety guidelines listed in the [Safety instructions](#).
2. Follow the procedure listed in the [Before working inside your system](#).
3. [Remove the air shroud](#).
4. Remove the BOSS card.

**NOTE:** The procedure to remove the BOSS card is similar to removing an expansion card.

#### Steps

1. Using the Phillips #1 screwdriver, remove the screws securing the M.2 SSD module to the BOSS card.
2. Pull the M.2 SSD module to disconnect from the connector on the BOSS card.

**NOTE:** The numbers on the image does not depict the exact steps. The numbers are just for representation of sequence.

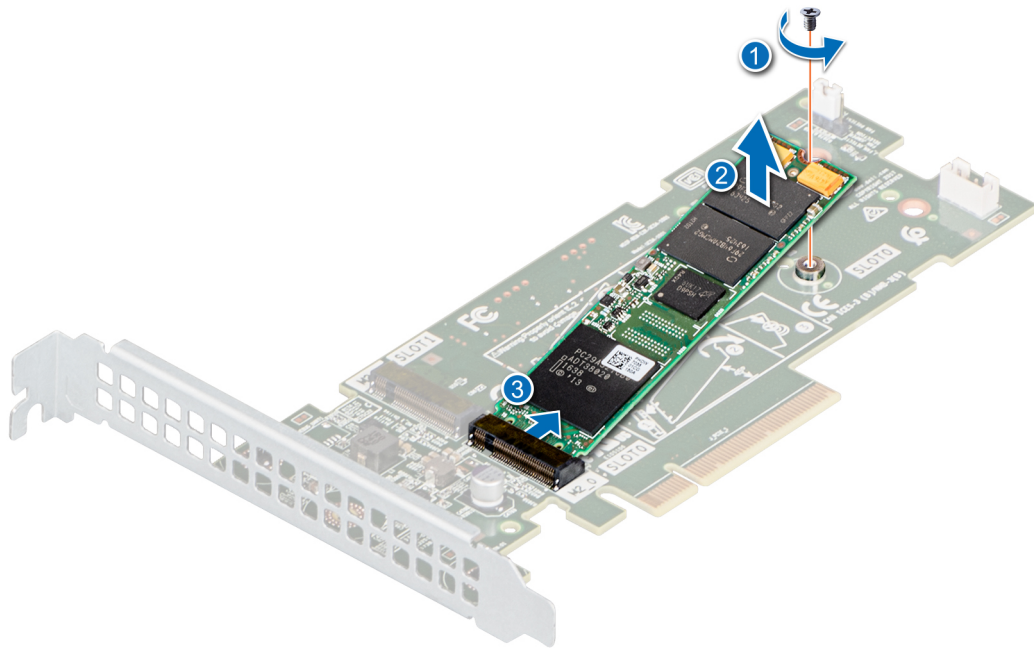

Figure 67. Removing the M.2 SSD module

#### Next steps

Replace the M.2 SSD module.

## Installing the M.2 SSD module

#### Prerequisites

1. Follow the safety guidelines listed in the [Safety instructions](#).
2. Follow the procedure listed in the [Before working inside your system](#).
3. [Remove the air shroud](#).
4. Remove the BOSS card.

**NOTE:** The procedure to remove the BOSS card is similar to the removing an expansion card.

#### Steps

1. Align the M.2 SSD module at an angle with the connector on the BOSS card.
2. Insert the M.2 SSD module until it is firmly seated in the BOSS card connector.
3. Using the Phillips #1 screwdriver, secure the M.2 SSD module on the BOSS card with the screw.

**NOTE:** The numbers on the image does not depict the exact steps. The numbers are just for representation of sequence.

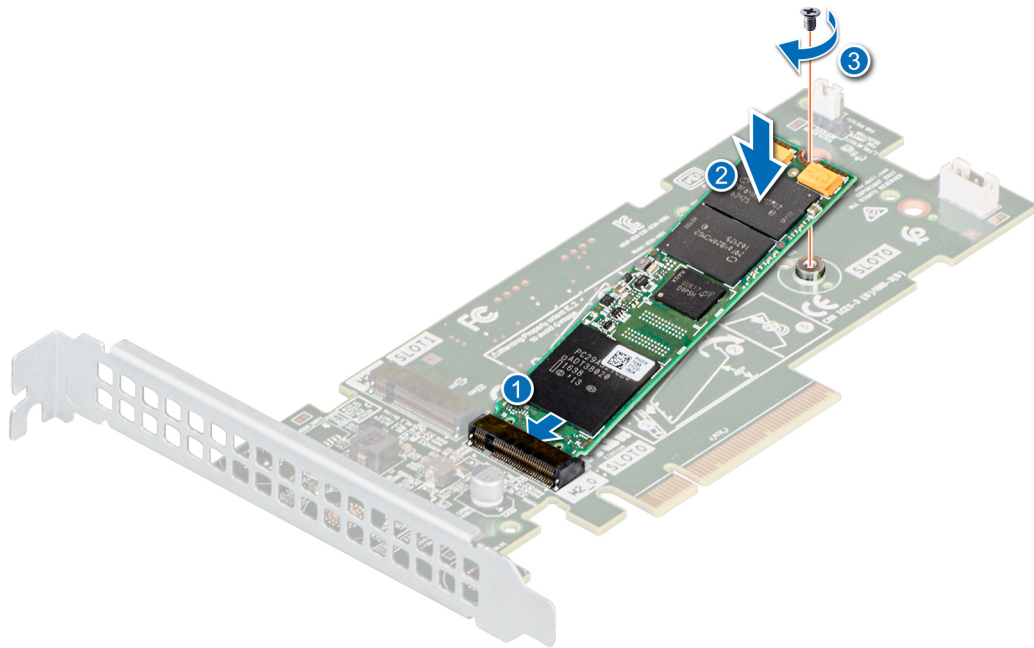

Figure 68. Installing the M.2 SSD module

#### Next steps

1. Install the BOSS card.  
**i** **NOTE:** The procedure to install the BOSS card is similar to removing an expansion card.
2. Install the air shroud.
3. Follow the procedure listed in the [After working inside your system](#).

## Optional IDSDM module

### Removing the IDSDM module

#### Prerequisites

1. Follow the safety guidelines listed in the [Safety instructions](#).
2. Follow the procedure listed in the [Before working inside your system](#).
3. [Remove the air shroud](#).
4. If you are replacing the IDSDM card, remove the MicroSD cards.  
**i** **NOTE:** Temporarily label each SD card with its corresponding slot number before removal. Reinstall the SD cards into the corresponding slots.

#### Steps

Holding the pull tab, lift the IDSDM card out of the system.

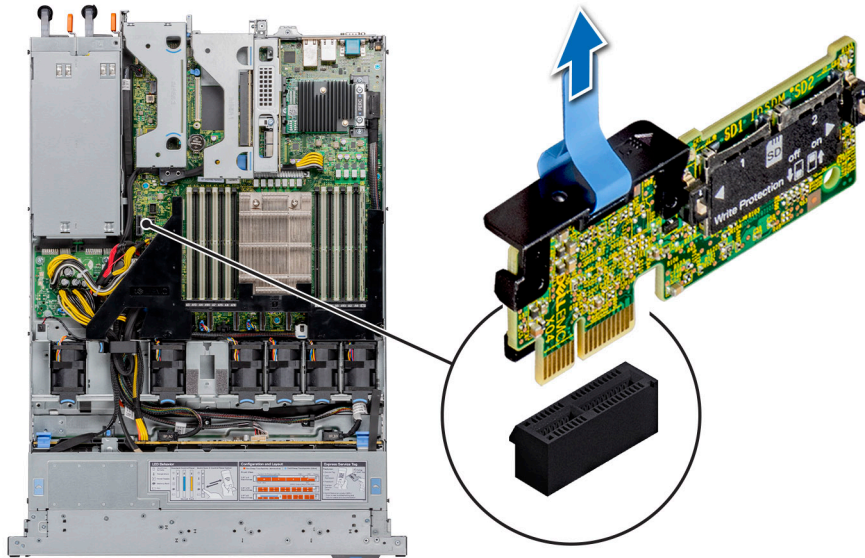

**Figure 69. Removing the IDSDM module**

**Next steps**

Replace the IDSDM module.

## Installing the IDSDM module

**Prerequisites**

1. Follow the safety guidelines listed in the [Safety instructions](#).
2. Follow the procedure listed in the [Before working inside your system](#).
3. [Remove the air shroud](#).

**Steps**

1. Locate the IDSDM connector on the system board.  
To locate IDSDM, see the System board jumpers and connectors section.
2. Align IDSDM module with the connector on the system board.
3. Push IDSDM module until it is firmly seated in the connector on the system board.

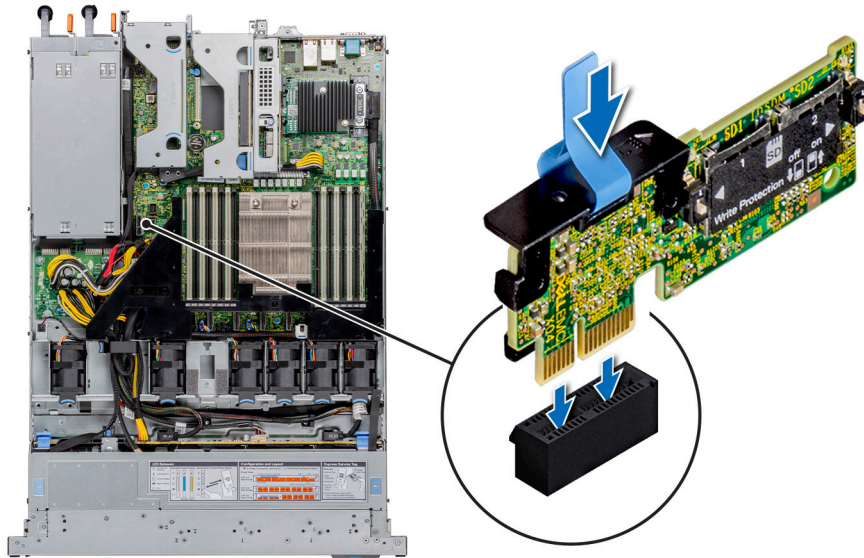

**Figure 70. Installing the IDSDM module**

#### Next steps

1. [Install the MicroSD cards.](#)  
**i** **NOTE:** Reinstall the MicroSD cards into the same slots based on the labels you had marked on the cards during removal.
2. [Install the air shroud.](#)
3. Follow the procedure listed in the [After working inside your system.](#)

## LOM riser card

### Removing the LOM riser card

#### Prerequisites

1. Follow the safety guidelines listed in the [Safety instructions.](#)
2. Follow the procedure listed in the [Before working inside your system.](#)
3. [Remove the air shroud.](#)
4. If installed, remove the risers.

#### Steps

1. Using a Phillips #2 screwdriver, remove the screws that secure the LAN on Motherboard (LOM) riser card to the system board.
2. Push apart the two blue plastic clips securing the LOM riser card to release the riser.
3. Holding the LOM riser card by the edges, lift to disconnect the card from the connector on the system board.
4. Slide the LOM riser card towards the front of the system until the Ethernet connectors or the SFP+ are clear of the slot in the back panel.

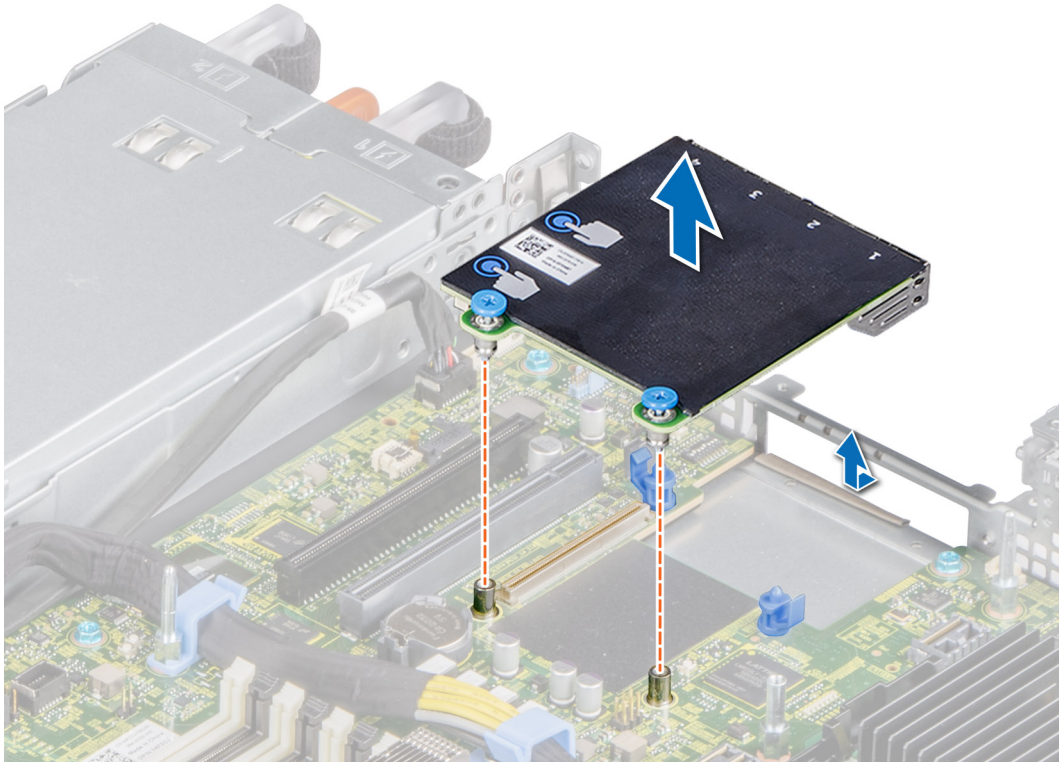

**Figure 71. Removing the LOM riser card**

5. Lift the LOM riser card out of the system.
6. Remove the LOM bracket.
  - a) Using the Phillips #2 screwdriver, remove the screw that secures the bracket to the chassis.
  - b) Slide the bracket out of the slot on the chassis.

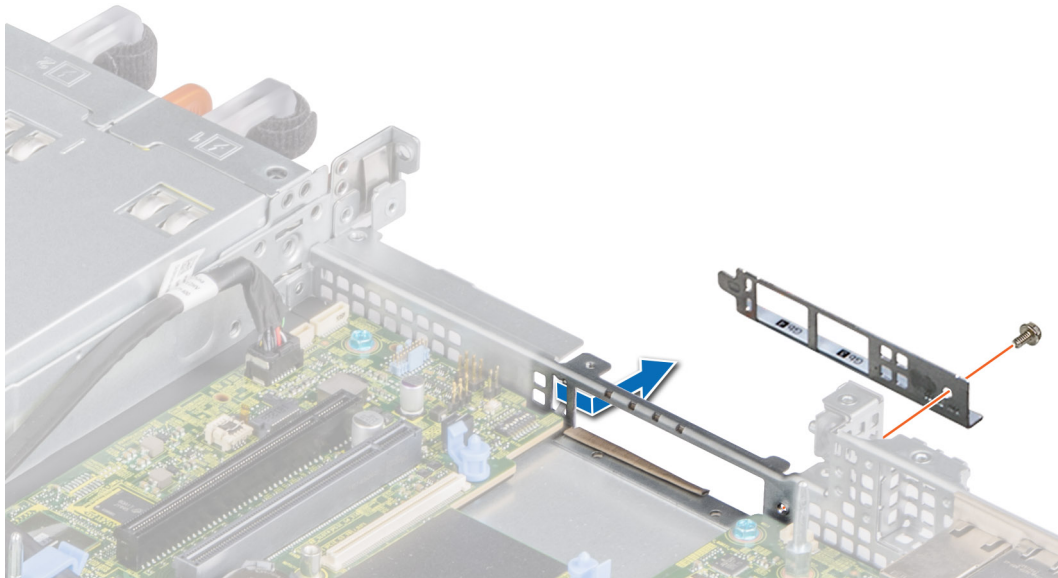

**Figure 72. Removing the LOM riser bracket**

7. If the LOM riser is not being replaced immediately, install the LOM filler bracket.
  - a) Insert and slide the filler into the slot on the chassis.
  - b) Using the Phillips #2 screwdriver, secure the filler bracket to the chassis with a screw.

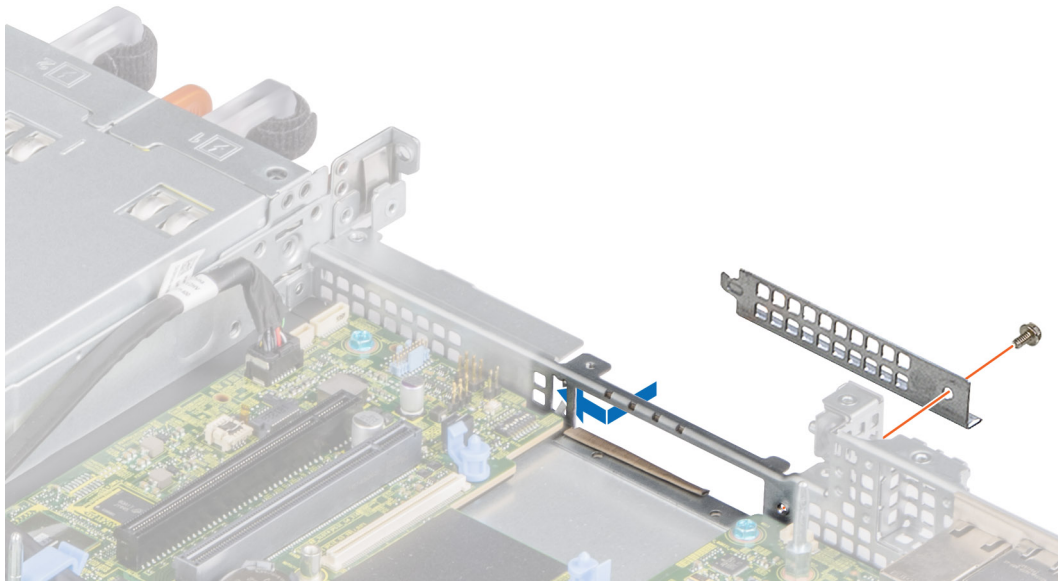

**Figure 73. Installing the LOM filler bracket**

### Next steps

Replace the LOM riser card.

## Installing the LOM riser card

### Prerequisites

1. Follow the safety guidelines listed in the [Safety instructions](#).
2. Follow the procedure listed in the [Before working inside your system](#).
3. [Remove the air shroud](#).
4. If installed, remove the risers.

### Steps

1. Remove the LOM filler bracket.
  - a) Using the Phillips #2 screwdriver, remove the screw that secures the bracket to the system.
  - b) Slide the bracket out of the slot on the system.

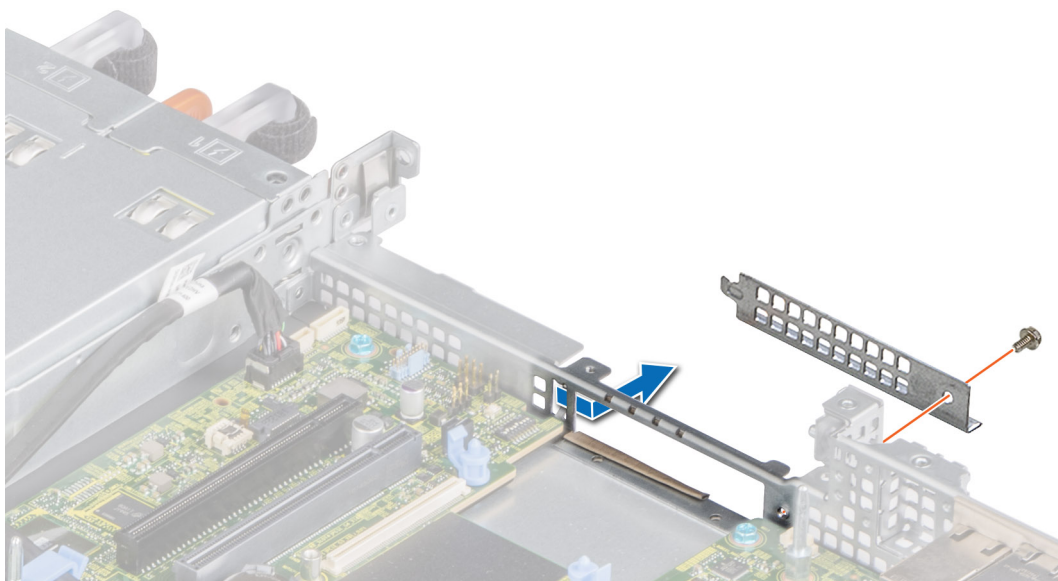

**Figure 74. Removing the LOM filler bracket**

2. Install the LOM bracket.
  - a) Insert and slide the LOM bracket into the slot on the system.
  - b) Using the Phillips #2 screwdriver, secure the bracket to the system with a screw

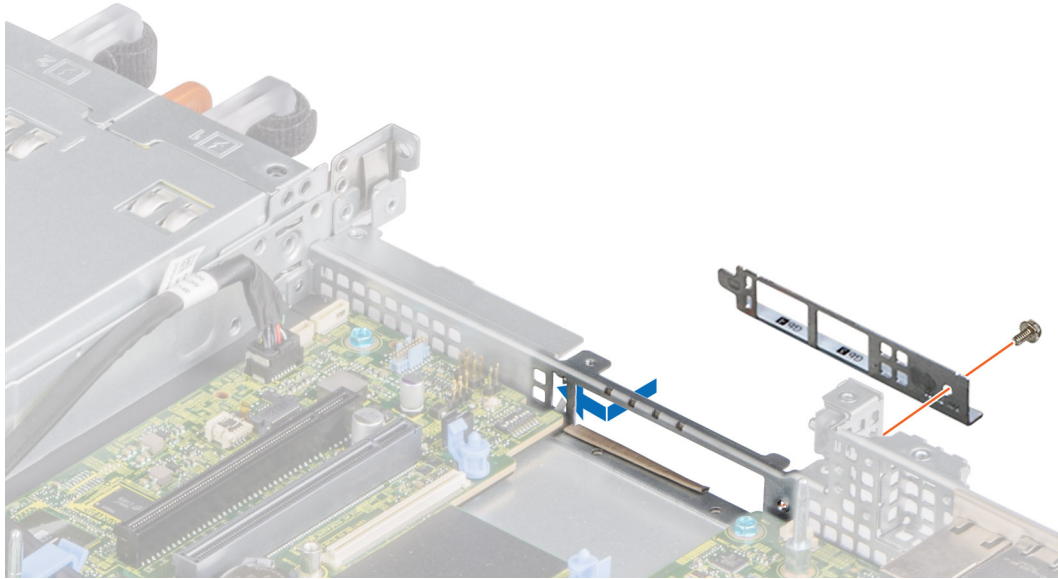

**Figure 75. Installing the LOM riser bracket**

3. Orient the LOM riser card to fit the Ethernet connectors or the SFP+ through the slot of the bracket.
4. Press the LOM riser card until the card is firmly seated on the system board connector and the two blue plastic clips to secure the LOM riser card in place.
5. Using a Phillips #2 screwdriver, secure the LOM riser card to the system board with screws.

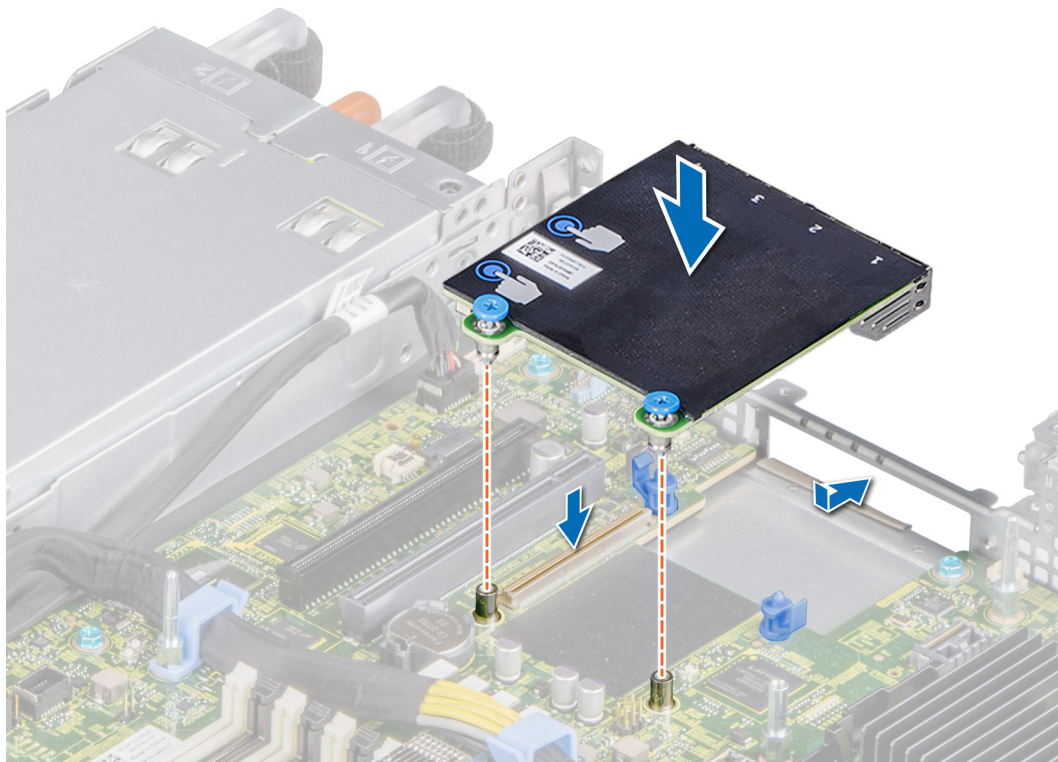

**Figure 76. Installing the LOM riser card**

#### Next steps

1. If removed, install the risers.
2. [Install the air shroud.](#)



3. Follow the procedure listed in [After working inside your system](#).

**i** **NOTE:** While replacing faulty storage controller/FC/NIC card with the same type of card, after you power on the system; the new card automatically updates to the same firmware and configuration of the faulty one. For more information about the Part replacement configuration, see the *Lifecycle Controller User's Guide* at [www.dell.com/idracmanuals](http://www.dell.com/idracmanuals)

## Mini PERC card

### Removing the mini PERC card

#### Prerequisites

1. Follow the safety guidelines listed in the [Safety instructions](#).
2. Follow the procedure listed in the [Before working inside your system](#).
3. [Remove the air shroud](#).
4. If installed, remove the risers..

#### Steps

1. Using a Phillips #2 screwdriver, loosen the screws that secure the cable to the mini PERC card.
2. Holding the tab, lift the cable to disconnect from the mini PERC card.

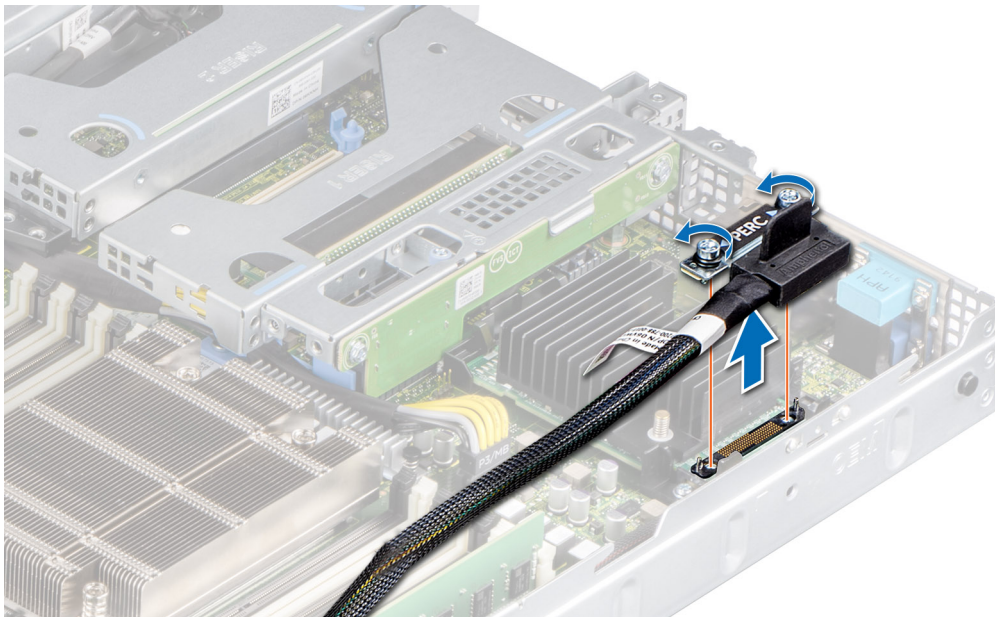

**Figure 77. Removing the mini PERC card cable**

3. Slide out the mini PERC card to disengage from the card holder on the system board.
4. Lift the mini PERC card out of the system.

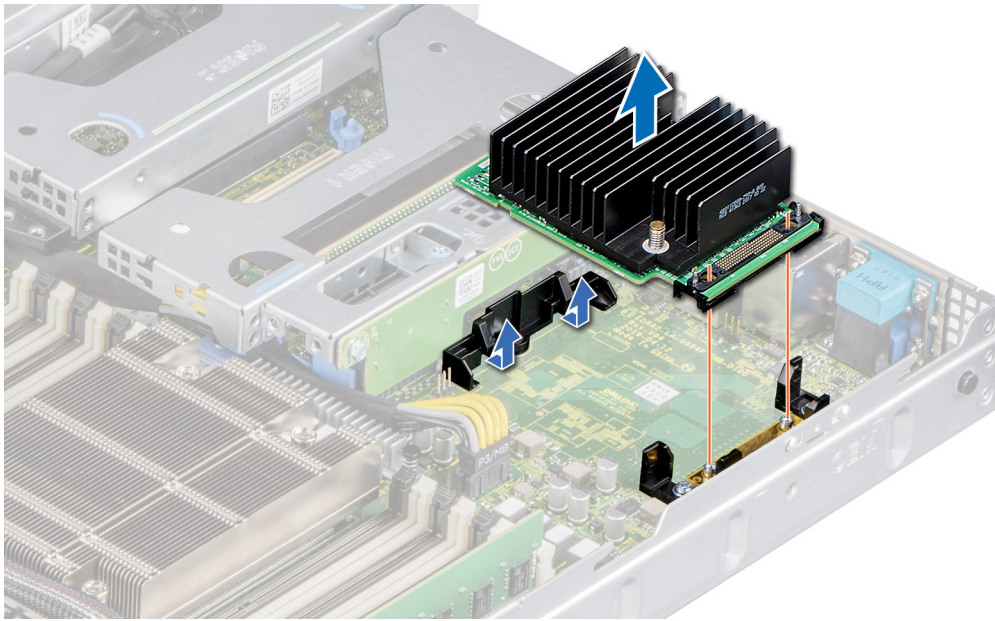

**Figure 78. Removing the mini PERC card**

**Next steps**

Replace the mini PERC card.

## Installing the mini PERC card

**Prerequisites**

1. Follow the safety guidelines listed in the [Safety instructions](#).
2. Follow the procedure listed in [Before working inside your system](#).

**Steps**

1. Angle the mini PERC card to engage with the mini PERC card holder on the system board.
2. Lower the mini PERC card into place until the mini PERC card is firmly seated on the card holder.

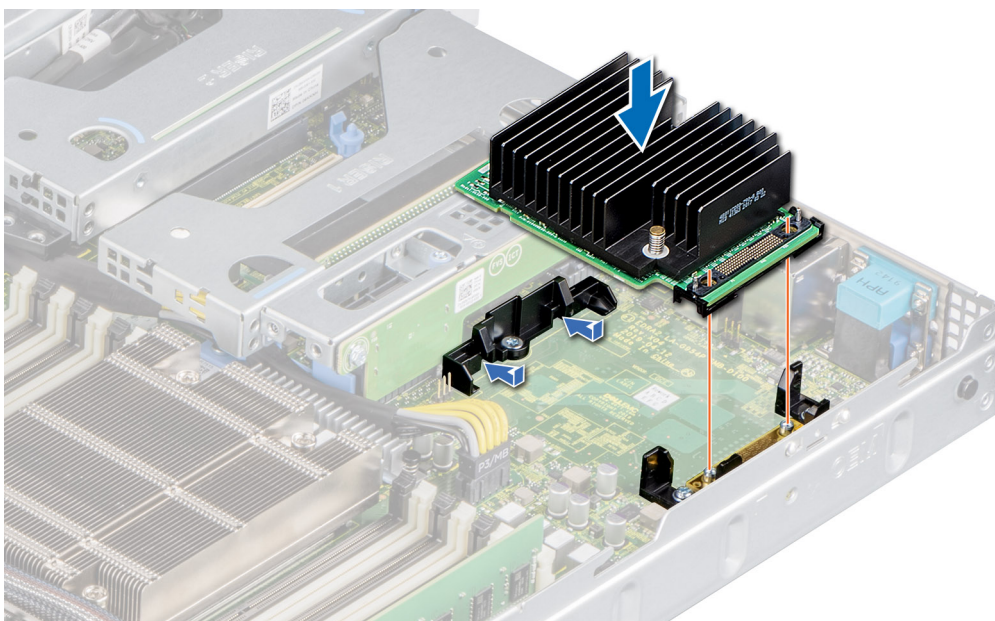

**Figure 79. Installing the mini PERC card**

3. Align the screws on the cable with the screw holes on the mini PERC card.
4. Using a Phillips #2 screwdriver, secure the cable to the mini PERC card with the screws.

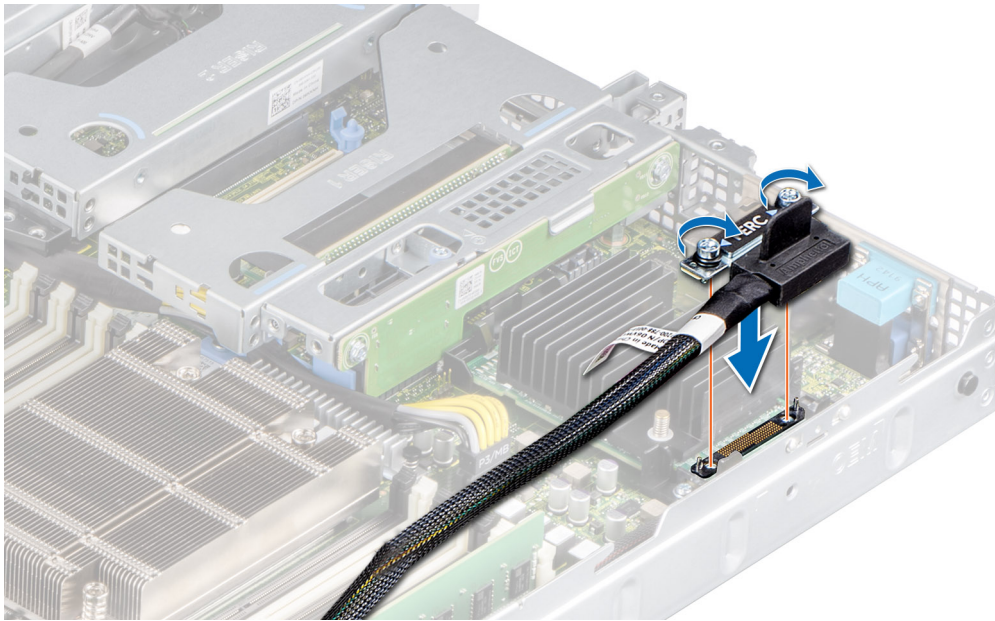

Figure 80. Installing the mini PERC card cable

#### Next steps

1. If removed, [install the expansion card risers](#).
2. [Install the air shroud](#).
3. Follow the procedure listed in the [After working inside your system](#).

**NOTE:** While replacing faulty storage controller/FC/NIC card with the same type of card, after you power on the system; the new card automatically updates to the same firmware and configuration of the faulty one. For more information about the Part replacement configuration, see the *Lifecycle Controller User's Guide* at [www.dell.com/idracmanuals](http://www.dell.com/idracmanuals)

## System battery

### Replacing the system battery

#### Prerequisites

**WARNING:** There is a danger of a new battery exploding if it is incorrectly installed. Replace the battery only with the same or equivalent type recommended by the manufacturer. Discard used batteries according to the manufacturer's instructions. See the Safety instructions. that came with your system for more information..

1. Follow the safety guidelines listed in the [Safety instructions](#).
2. Follow the procedure listed in the [Before working inside your system](#).
3. If applicable, disconnect the power or data cables from the expansion card(s).
4. [Remove the LOM riser card](#).

#### Steps

1. To remove the battery:
  - a) Use a plastic scribe to pry out the system battery.

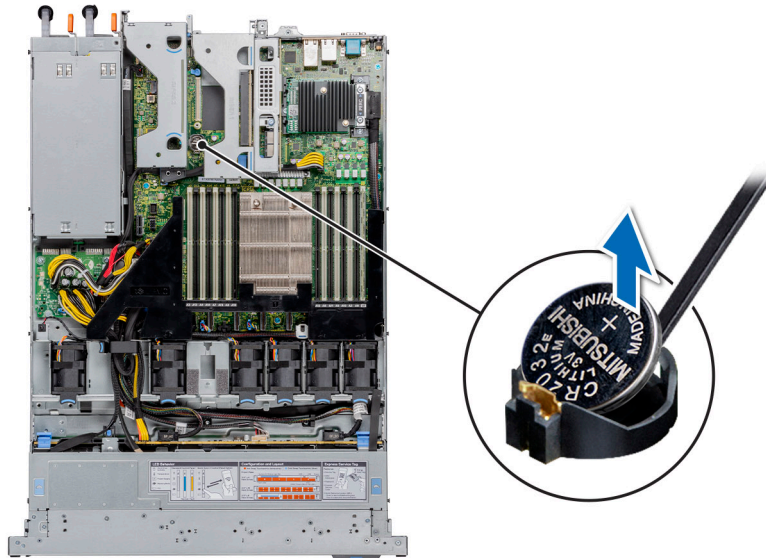

**Figure 81. Removing the system battery**

**CAUTION:** To avoid damage to the battery connector, you must firmly support the connector while installing or removing a battery.

2. To install a new system battery: To install a new system battery,
  - a) Hold the battery with the positive side facing up and slide it under the securing tabs.
  - b) Press the battery into the connector until it snaps into place.

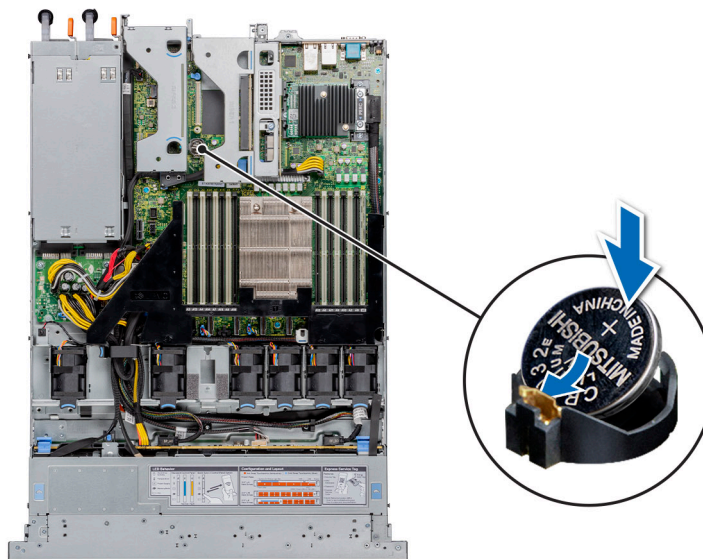

**Figure 82. Installing the system battery**

**Next steps**

1. Install the LOM riser card.
2. If applicable, connect the cables to the expansion card(s).
3. Follow the procedure listed in the [After working inside your system](#).
4. Confirm that the battery is operating properly, by performing the following steps:
  - a. Enter the System Setup, while booting, by pressing F2.
  - b. Enter the correct time and date in the System Setup **Time** and **Date** fields.
  - c. **Exit** the System Setup.

- d. To test the newly installed battery, remove the system from the enclosure for at least an hour.
- e. Reinstall the system into the enclosure after an hour.
- f. Enter the System Setup and if the time and date are still incorrect, see [Getting help](#) section.

## Optional internal USB memory key

**NOTE:** To locate the internal USB port on the system board, see the [System board jumpers and connectors](#) section.

## Replacing optional internal USB memory key

### Prerequisites

**CAUTION:** To avoid interference with other components in the server, the maximum permissible dimensions of the USB memory key are 15.9 mm wide x 57.15 mm long x 7.9 mm high.

1. Follow the safety guidelines listed in the [Safety instructions](#).
2. Follow the procedure listed in the [Before working inside your system](#).
3. [Remove the air shroud](#).

### Steps

1. Locate the USB port or USB memory key on the system board.  
To locate the internal USB port on the system board, see the [System board jumpers and connectors](#) section.
2. If installed, remove the USB memory key from the USB port.

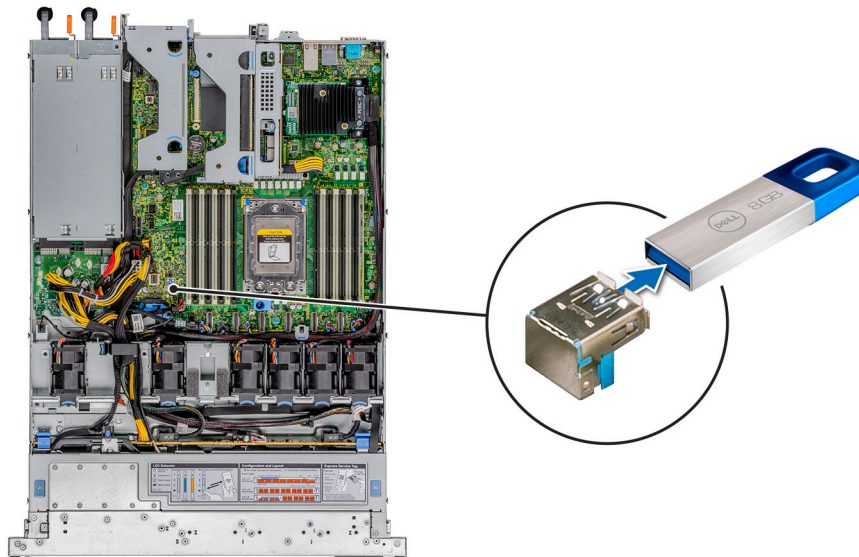

**Figure 83. Removing the USB memory key**

3. Insert the replacement USB memory key into the USB port.

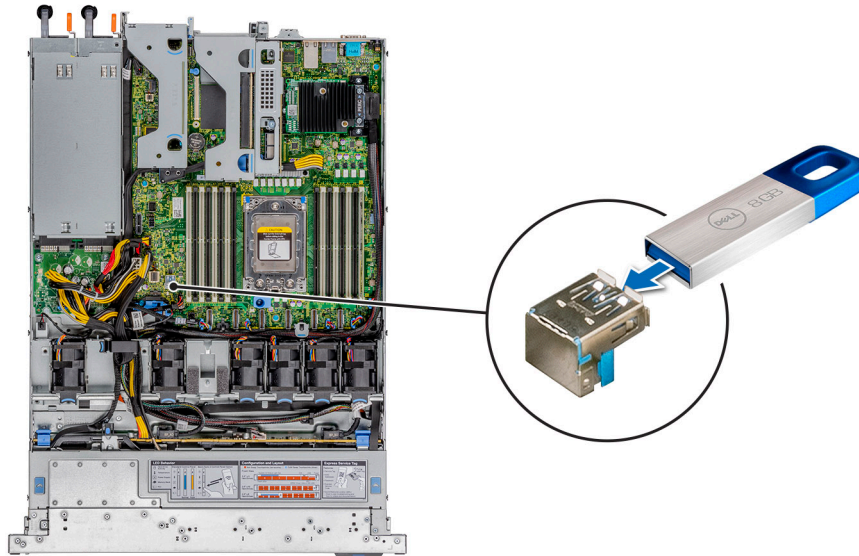

**Figure 84. Installing the USB memory key**

#### Next steps

1. [Install the air shroud.](#)
2. Follow the procedure listed in [After working inside your system.](#)
3. While booting, press F2 to enter **System Setup** and verify that the system detects the USB memory key.

## VGA module

### Removing the VGA module

#### Prerequisites

1. Follow the safety guidelines listed in the [Safety instructions.](#)
2. Follow the procedure listed in the [Before working inside your system.](#)
3. [Remove the front bezel.](#)
4. [Remove the backplane cover.](#)
5. [Remove the air shroud.](#)
6. Disconnect the VGA cable from the VGA connector on the system board. For locating the connector, see the [System board jumpers and connectors](#) section.

**NOTE:** Ensure that you note the routing of the cables as you remove them from the system board. Route the cable properly when you replace it to prevent the cable from being pinched or crimped

#### Steps

1. Using Phillips #1 screwdriver, remove the screw on the VGA module.
2. Slide the module out of the system.

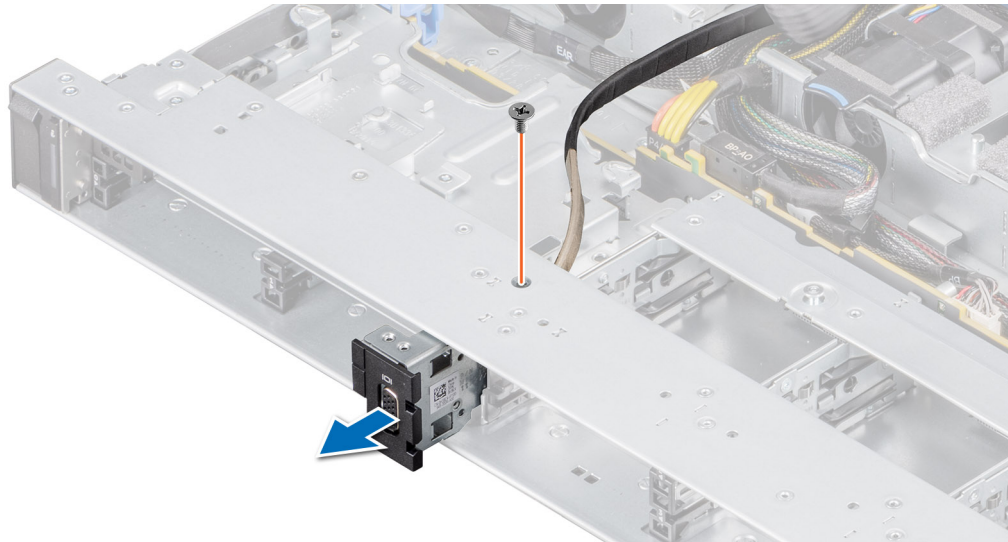

**Figure 85. Removing the VGA module**

### Next steps

Install the VGA module.

## Installing the VGA module

### Prerequisites

1. Follow the safety guidelines listed in the [Safety instructions](#).
2. Follow the procedure listed in the [Before working inside your system](#).
3. [Remove the front bezel](#).
4. [Remove the backplane cover](#).
5. [Remove the air shroud](#).

**NOTE:** Ensure that you note the routing of the cables as you remove them from the system board. Route the cable properly when you replace it to prevent the cable from being pinched or crimped

### Steps

1. Route the VGA cable through the VGA module slot on the front of the system and slide the VGA module into the slot.
2. Align the hole on the module with the screw hole on the system.
3. Using the Phillips #1 screwdriver, secure the VGA module to the system with the screw.

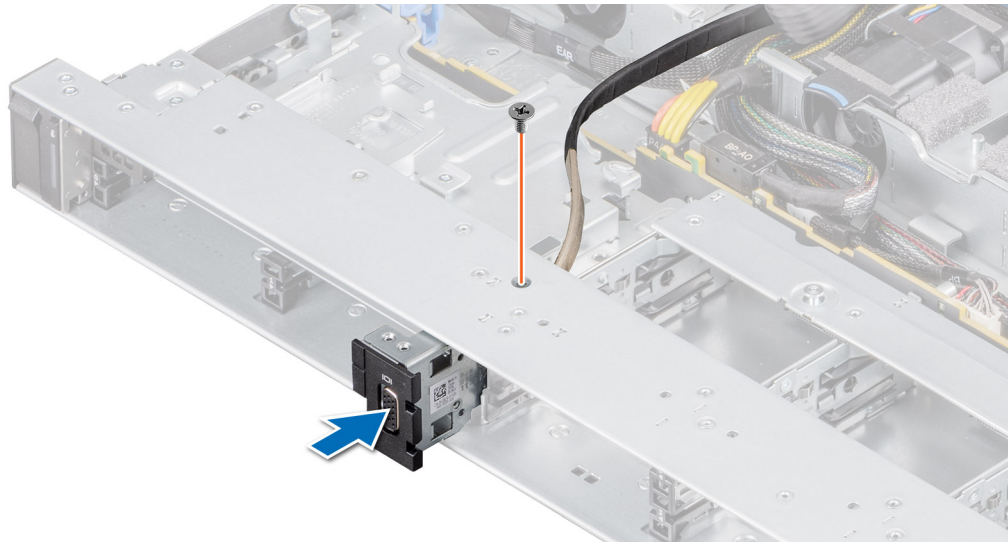

**Figure 86. Installing the VGA module**

#### Next steps

1. Route the VGA cable and connect it to the VGA connector on the system board. For locating the connector, see the [System board jumpers and connectors](#) section.
2. [Install the air shroud.](#)
3. [Install the backplane cover.](#)
4. [Install the front bezel.](#)
5. Follow the procedure listed in the [After working inside your system.](#)

## Optional optical drive

### Removing the optical drive

The procedure for removing an optical drive and optical drive blank is the same.

#### Prerequisites

1. Follow the safety guidelines listed in the [Safety instructions.](#)
2. Follow the procedure listed in the [Before working inside your system.](#)
3. If installed, [remove the front bezel.](#)

#### Steps

1. Disconnect the power and data cables from the connectors on the optical drive.

**NOTE:** Observe the routing of the cable as you remove it from the system.

2. To release the optical drive, press the release tab and push the drive towards the front of the system.
3. Slide the optical drive out of the system.



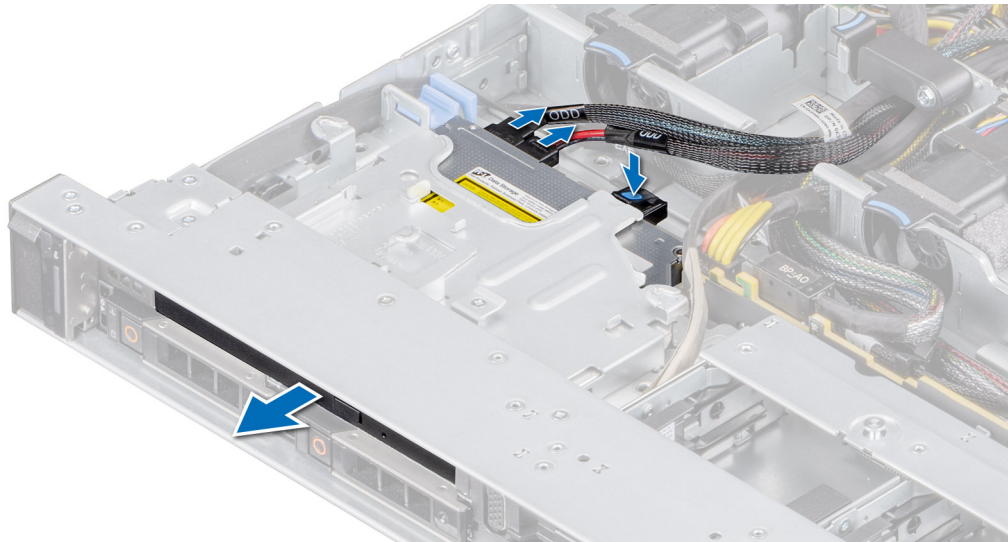

**Figure 87. Removing the optical drive**

### Next steps

Replace the optical drive or Install an optical blank.

#### **NOTE:**

**Blanks must be installed on empty optical drive slot to maintain FCC certification of the system. The blank also keep dust and dirt out of the system and aid in proper cooling and airflow inside the system.**

## Installing the optical drive

The procedure for installing an optical drive and optical drive blank.

### Prerequisites

1. Follow the safety guidelines listed in the [Safety instructions](#).
2. Follow the procedure listed in the [Before working inside your system](#).
3. If applicable, [remove the backplane cover](#).
4. If installed, remove the optical drive blank by pressing the blue release tab at the back of the blank and pushing the blank out of the system.

**NOTE:** Route the cable properly when you replace it to prevent the cable from being pinched or crimped.

### Steps

1. Insert the optical drive until the blue release tab locks in the slot on the system.
2. Align the optical drive with the optical drive slot on the front of the system.

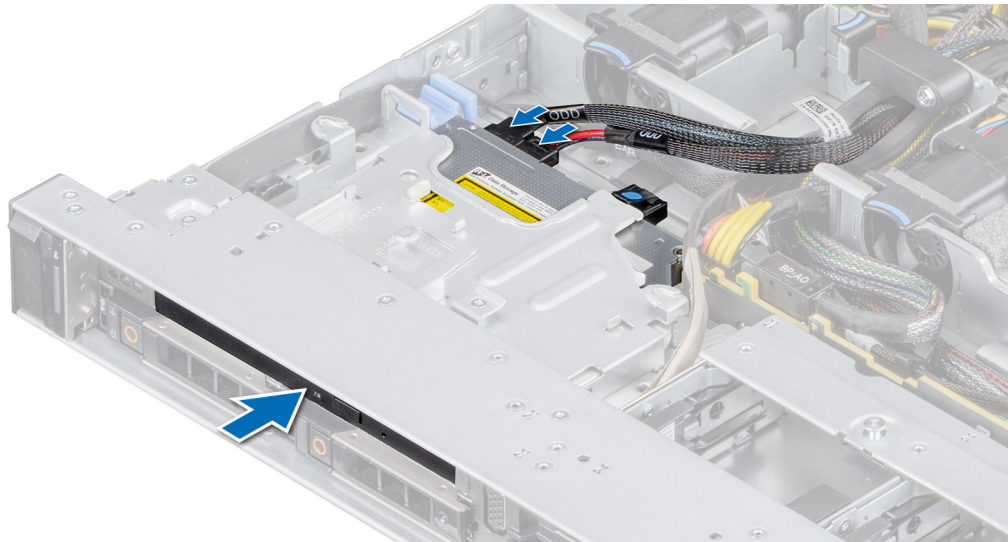

**Figure 88. Installing the optical drive**

**NOTE:**

**Route the cable properly to prevent the cable from being pinched or crimped.**

3. Connect the power and data cables to the connectors on the system board.

**Next steps**

1. If removed, [install the front bezel](#).
2. Follow the procedure listed in [After working inside your system](#).

## Power supply unit

**NOTE:** While replacing the hot swappable PSU, after next server boot; the new PSU automatically updates to the same firmware and configuration of the replaced one. For more information about the Part replacement configuration, see the *Lifecycle Controller User's Guide* at [www.dell.com/idracmanuals](http://www.dell.com/idracmanuals)

## Hot spare feature

Your system supports the hot spare feature that significantly reduces the power overhead associated with power supply unit (PSU) redundancy.

When the hot spare feature is enabled, one of the redundant PSUs is switched to the sleep state. The active PSU supports 100 percent of the system load, thus operating at higher efficiency. The PSU in the sleep state monitors output voltage of the active PSU. If the output voltage of the active PSU drops, the PSU in the sleep state returns to an active output state.

If having both PSUs active is more efficient than having one PSU in the sleep state, the active PSU can also activate the sleeping PSU.

The default PSU settings are as follows:

- If the load on the active PSU is more than 50 percent of PSU rated power wattage, then the redundant PSU is switched to the active state.
- If the load on the active PSU falls below 20 percent of PSU rated power wattage, then the redundant PSU is switched to the sleep state.

You can configure the hot spare feature by using the iDRAC settings. For more information, see the *iDRAC User's Guide* available at [www.dell.com/poweredgemanuals](http://www.dell.com/poweredgemanuals).

# Removing a power supply unit blank

## Prerequisites

Follow the safety guidelines listed in the [Safety instructions](#).

## Steps

Pull the blank out of the system.

**CAUTION:** To ensure proper system cooling, the PSU blank must be installed in the second PSU bay in a non-redundant configuration. Remove the PSU blank only if you are installing a second PSU.

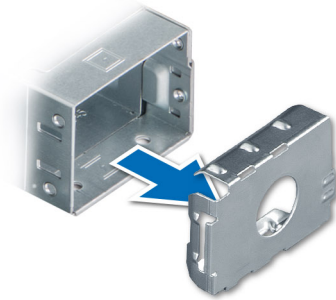

Figure 89. Removing a power supply unit blank

## Next steps

Replace the [PSU](#) or [PSU blank](#).

# Installing a power supply unit blank

## Prerequisites

1. Follow the safety guidelines listed in the [Safety instructions](#).

**NOTE:** Install the power supply unit (PSU) blank only in the second PSU bay.

2. [Remove the PSU](#).

## Steps

Align the PSU blank with the PSU bay and push it into the PSU bay until it clicks into place.

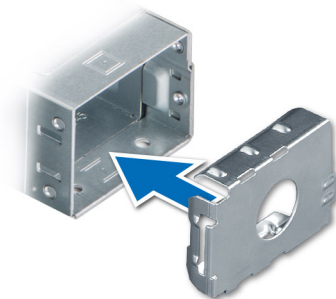

Figure 90. Installing a power supply unit blank

# Removing a power supply unit

## Prerequisites

**CAUTION:** The system requires one power supply unit (PSU) for normal operation. On power-redundant systems, remove and replace only one PSU at a time in a system that is powered on.

1. Follow the safety guidelines listed in the [Safety instructions](#).
2. Disconnect the power cable from the power outlet and from the PSU you intend to remove.
3. Remove the cable from the strap on the PSU handle.
4. Unlatch and lift the optional cable management arm if it interferes with the PSU removal.

For information about the cable management arm, see the system's rack documentation at [www.dell.com/poweredge manuals](http://www.dell.com/poweredge manuals).

## Steps

Press the release latch, and holding the PSU handle slide the PSU out of the PSU bay.

**NOTE:** The numbers on the image does not depict the exact steps. The numbers are just for representation of sequence.



Figure 91. Removing a power supply unit

## Next steps

Replace the PSU or install the PSU blank.

# Installing a power supply unit

## Prerequisites

1. Follow the safety guidelines listed in the [Safety instructions](#).
2. For systems that support redundant PSU, ensure that both the PSUs are of the same type and have the same maximum output power.

**NOTE:** The maximum output power (shown in watts) is listed on the PSU label.

3. Remove the PSU blank.

## Steps

Slide the PSU into the PSU bay until the release latch snaps into place.

**NOTE:** The numbers on the image does not depict the exact steps. The numbers are just for representation of sequence.



**Figure 92. Installing a power supply unit**

#### Next steps

1. If you have unlatched the cable management arm, relatch it. For information about the cable management arm, see the system's rack documentation at [www.dell.com/poweredgemanuals](http://www.dell.com/poweredgemanuals).
2. Connect the power cable to the PSU, and plug the cable into a power outlet.

**CAUTION:** When connecting the power cable to the PSU, secure the cable to the PSU with the strap.

**NOTE:** When installing, hot swapping, or hot adding a new PSU, wait for 15 seconds for the system to recognize the PSU and determine its status. The PSU redundancy may not occur until discovery is complete. The PSU status indicator turns green to indicate that the PSU is functioning properly.

**NOTE:** While replacing the hot swappable PSU, after next server boot; the new PSU automatically updates to the same firmware and configuration of the replaced one. For more information about the Part replacement configuration, see the *Lifecycle Controller User's Guide* at [www.dell.com/idracmanuals](http://www.dell.com/idracmanuals)

## Power interposer board

### Removing the power interposer board

#### Prerequisites

1. Follow the safety guidelines listed in the [Safety instructions](#).
2. Follow the procedure listed in the [Before working inside your system](#).
3. [Remove the air shroud](#).
4. Remove the [PSU](#) or [PSU blank](#).

#### Steps

1. Using a Phillips #2 screwdriver, remove the screws securing the power interposer board (PIB) to the system.

**NOTE:** Observe the routing of the cable as you remove it from the system.

2. Press the blue release latch on the PIB to release it from the hook on the PSU cage.

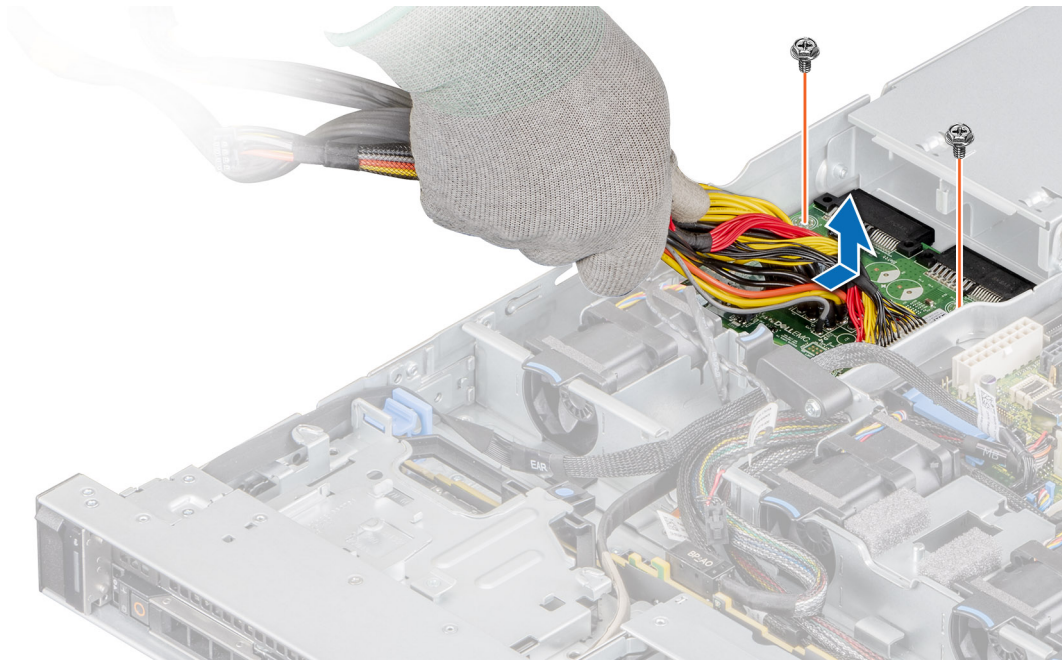

**Figure 93. Removing the power interposer board**

3. Lift the PIB away from the system.

#### **Next steps**

Replace the power interposer board.

## **Installing the power interposer board**

#### **Prerequisites**

1. Follow the safety guidelines listed in the [Safety instructions](#).
2. Follow the procedure listed in the [Before working inside your system](#).

#### **Steps**

1. Align the slots on the PIB with the hook on the PSU cage and slide it into place.
2. Using Phillips #2 screwdriver, tighten the screws to secure the PIB to the system.

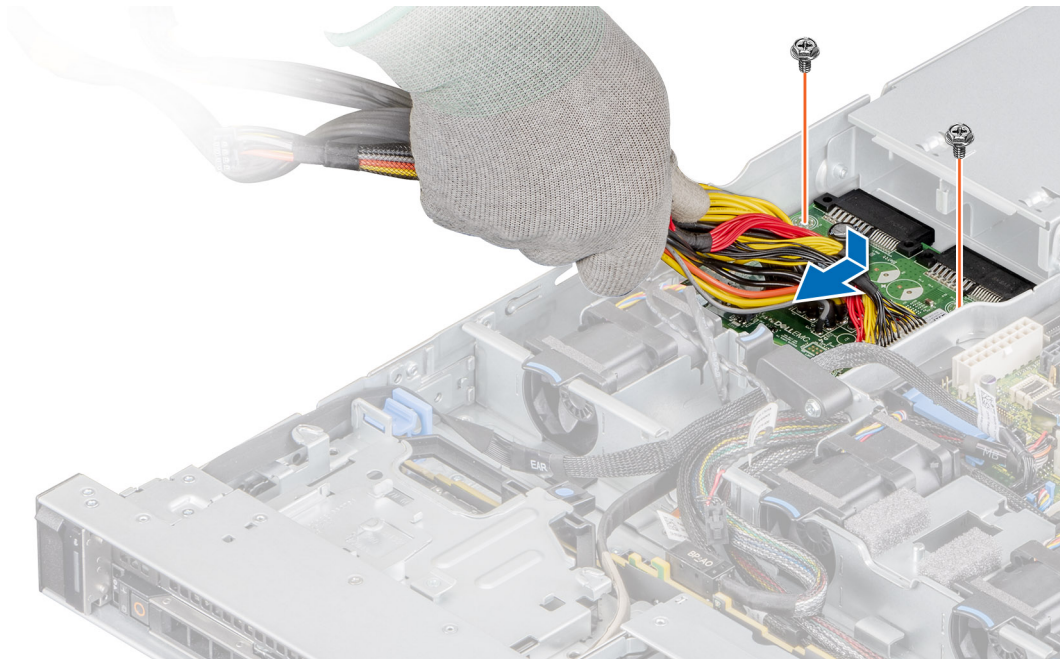

**Figure 94. Installing the power interposer board**

3. Route the cables and connect it to the system board.

#### Next steps

1. [Install the PSU.](#)
2. [Install the air shroud.](#)
3. Follow the procedure listed in [After working inside your system.](#)

## System board

### Removing the system board

#### Prerequisites

**CAUTION:** If you are using the Trusted Platform Module (TPM) with an encryption key, you may be prompted to create a recovery key during program or System Setup. Be sure to create and safely store this recovery key. If you replace this system board, you must supply the recovery key when you restart your system or program before you can access the encrypted data on your drives.

1. Follow the safety guidelines listed in the [Safety instructions.](#)
2. Follow the procedure listed in the [Before working inside your system.](#)
3. Remove the following components:
  - a. [Air shroud](#)
  - b. [Expansion cards](#)
  - c. [Expansion card risers](#)
  - d. [Mini PERC card](#)
  - e. [IDSDM module](#)
  - f. [Internal USB key \(if installed\)](#)
  - g. [Processor](#)
  - h. [Heat sink](#)
  - i. [Memory modules](#)
  - j. [LOM riser card](#)
  - k. Disconnect all cables from the system board.

**CAUTION:** Take care not to damage the system identification button while removing the system board from the system.

### Steps

1. Using a Phillips #2 screwdriver, remove the screws securing the system board to the chassis.
2. Using the system board holder, slightly lift the system board, and then slide it toward the front of the chassis.
3. Lift the system board out of the chassis.

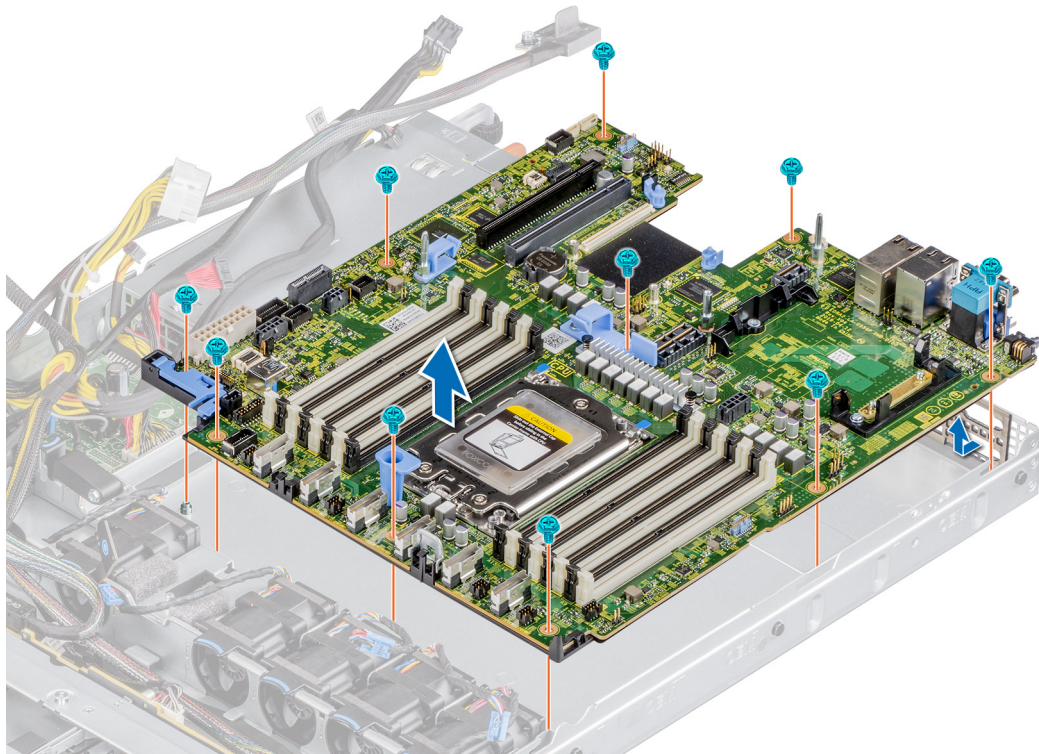

Figure 95. Removing the system board

### Next steps

Install the system board.

## Installing the system board

### Prerequisites

**NOTE:** Before replacing the system board, replace the old iDRAC MAC address label in the Information tag with the iDRAC MAC address label of the replacement system board

1. Follow the safety guidelines listed in the [Safety instructions](#).
2. Follow the procedure listed in [Before working inside your system](#).
3. If you are replacing the system board, remove all the components that are listed in the [removing the system board](#) section.

### Steps

1. Unpack the new system board assembly.

**CAUTION:** Do not lift the system board by holding a memory module, processor, or other components.

**CAUTION:** Take care not to damage the system identification button while placing the system board into the chassis.

2. Holding the system board holder, lower the system board it into the system.
3. Incline the system board at an angle and align the connectors with the slots on the rear of the chassis.



- Slide the system board towards the rear of the chassis until the connectors are firmly seated in the slots.
- Using a Phillips #2 screwdriver, fasten the screws that secure the system board to the chassis.

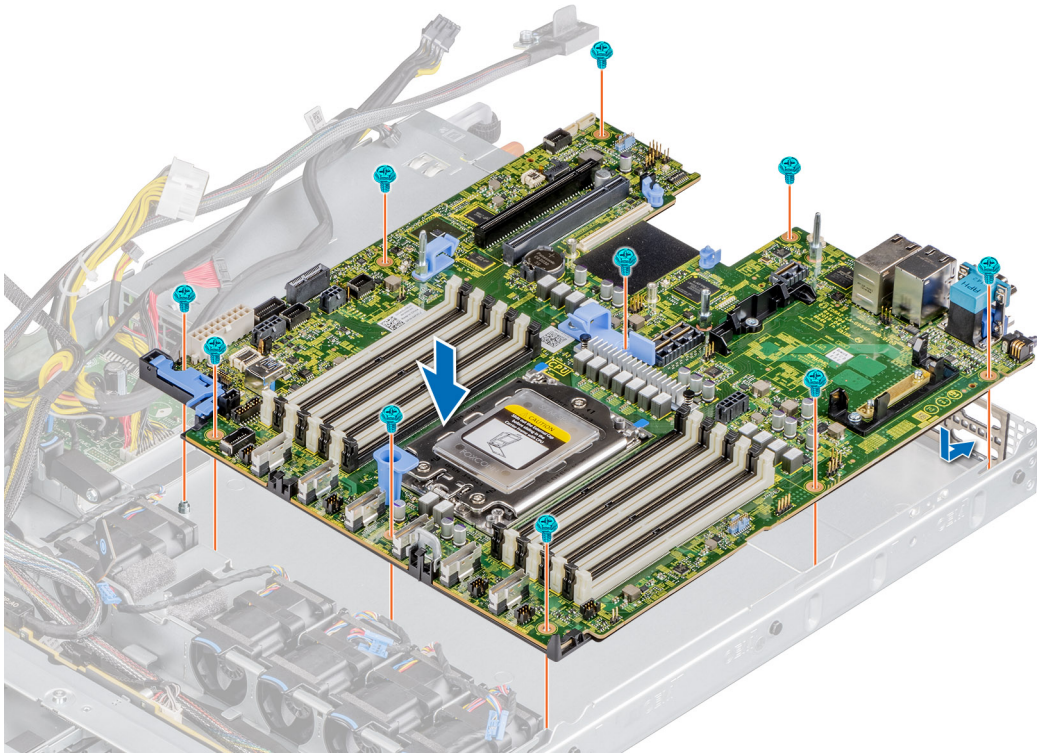

**Figure 96. Installing the system board**

#### Next steps

- Replace the following components:
  - Trusted Platform Module (TPM)  
**NOTE:** The TPM Module must be replaced only while installing new system board.
  - Mini PERC card
  - IDSDM module
  - Expansion cards
  - Expansion card risers
  - Processor
  - Heat sink
  - Memory modules
  - LOM riser card
  - Air shroud
- Reconnect all cables to the system board.  
**NOTE:** Ensure that the cables inside the system are routed along the chassis wall and secured using the cable securing bracket.
- Ensure that you perform the following steps:
  - Use the Easy Restore feature to restore the Service Tag. See the [Restoring the system by using the Easy Restore feature](#) section.
  - If the service tag is not backed up in the backup flash device, enter the system service tag manually. See the [Manually update the Service Tag by using System Setup](#) section.
  - Update the BIOS and iDRAC versions.  
Re-enable the Trusted Platform Module (TPM). See the [Upgrading the Trusted Platform Module](#) section.
- If you are not using Easy restore, import your new or existing iDRAC Enterprise license. For more information, see the *iDRAC User's Guide* available at [www.dell.com/idracmanuals](http://www.dell.com/idracmanuals).
- Follow the procedure listed in [After working inside your system](#).

# Restoring Service Tag using Easy Restore

The Easy Restore feature allows you to restore your Service Tag, iDRAC license, UEFI configuration, and the system configuration data after replacing the system board. All data is backed up in a backup Flash drive device automatically. If BIOS detects a new system board, and the Service Tag in the backup Flash drive device is different, BIOS prompts the user to restore the backup information.

## About this task

Below is a list of options available:

1. Restore the Service Tag, license, and diagnostics information, press **Y**.
2. Navigate to the Lifecycle Controller based restore options, press **N**.
3. Restore data from a previously created **Hardware Server Profile**, press **F10**.

 **NOTE:** When the restore process is complete, BIOS prompts to restore the system configuration data.

4. To restore the system configuration data, press **Y**
5. To use the default configuration settings, press **N**

 **NOTE:** After the restore process is complete, system reboots.

 **NOTE:** If restoring the Service Tag is successful, you can check the Service Tag information in the System Information screen and compare it with the Service Tag on the system.

## Manually updating Service Tag

After replacing a system board, if Easy Restore fails, follow this process to manually enter the Service Tag, using **System Setup**.

## About this task

If you know the system Service Tag, use the **System Setup** menu to enter the Service Tag.

## Steps

1. Turn on the system.
2. To enter the **System Setup**, press **F2**.
3. Click **Service Tag Settings**.
4. Enter the Service Tag.

 **NOTE:** You can enter the Service Tag only when the Service Tag field is empty. Ensure that you enter the correct Service Tag. After the Service Tag is entered, it cannot be updated or changed.

5. Click **OK**.

# Trusted Platform Module

## Upgrading the Trusted Platform Module

### Prerequisites

 **NOTE:**

- Ensure that your operating system supports the version of the TPM module being installed.
- Ensure that you download and install the latest BIOS firmware on your system.
- Ensure that the BIOS is configured to enable UEFI boot mode.

## About this task

 **CAUTION:** Once the TPM plug-in module is installed, it is cryptographically bound to that specific system board. Any attempt to remove an installed TPM plug-in module breaks the cryptographic binding, the removed TPM cannot be reinstalled or installed on another system board.

## Removing the TPM

### Steps

1. Locate the TPM connector on the system board.
2. Press to hold the module down and remove the screw using the security Torx 8-bit shipped with the TPM module.
3. Slide the TPM module out from its connector.
4. Push the plastic rivet away from the TPM connector and rotate it 90° counterclockwise to release it from the system board.
5. Pull the plastic rivet out of its slot on the system board.

## Installing the TPM

### Steps

1. To install the TPM, align the edge connectors on the TPM with the slot on the TPM connector.
2. Insert the TPM into the TPM connector such that the plastic rivet aligns with the slot on the system board.
3. Press the plastic rivet until the rivet snaps into place.
4. Replace the screw that secures the TPM to the system board.

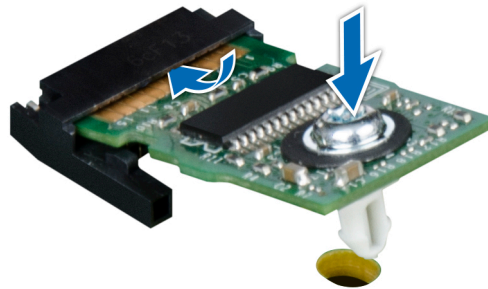

Figure 97. Installing the TPM

## Initializing TPM for users

### Steps

1. Initialize the TPM.  
For more information, see [Initializing the TPM for users](#).
2. The **TPM Status** changes to **Enabled, Activated**.

## Initializing the TPM 1.2 for users

### Steps

1. While booting your system, press F2 to enter System Setup.
2. On the **System Setup Main Menu** screen, click **System BIOS > System Security Settings**.
3. From the **TPM Security** option, select **On with Preboot Measurements**.
4. From the **TPM Command** option, select **Activate**.
5. Save the settings.
6. Restart your system.

# Initializing the TPM 2.0 for users

## Steps

1. While booting your system, press F2 to enter System Setup.
2. On the **System Setup Main Menu** screen, click **System BIOS > System Security Settings**.
3. From the **TPM Security** option, select **On**.
4. Save the settings.
5. Restart your system.

# Control panel

## Removing the left control panel

### Prerequisites

1. Follow the safety guidelines listed in the [Safety instructions](#).
2. Follow the procedure listed in the [Before working inside your system](#).
3. If applicable, [remove the backplane cover](#)
4. [Remove the air shroud](#).

### Steps

1. Disconnect the control panel cable from the system board connector.

**NOTE:** Observe the routing of the cable as you remove it from the system.

2. Using a Phillips #1 screwdriver, remove the screws that secure the cable cover to the system.
3. Using the Phillips #1 screwdriver, remove the screws that secure the left control panel assembly to the system.
4. Hold the left control panel assembly and remove it from the system.

**NOTE:** The numbers on the image does not depict the exact steps. The numbers are just for representation of sequence.

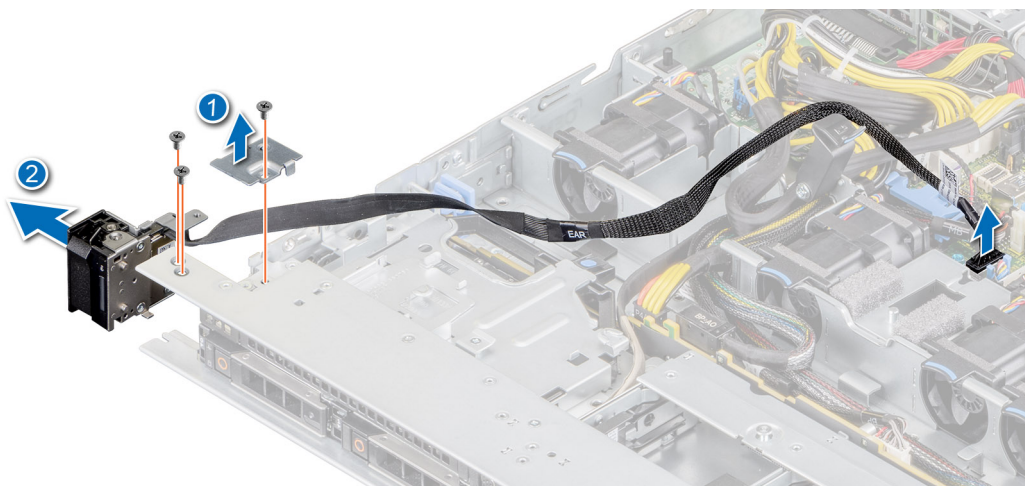

**Figure 98. Removing the left control panel**

### Next steps

[Replace the left control panel.](#)

# Installing the left control panel

## Prerequisites

1. Follow the safety guidelines listed in the [Safety instructions](#).
2. Follow the procedure listed in the [Before working inside your system](#).

## Steps

1. Route the control panel cable through the side wall and the guide slots in the system and connector on system board.

**NOTE:** Route the cable properly to prevent the cable from being pinched or crimped.

2. Align and insert the left control panel assembly in the slot on the system.
3. Using the Phillips #1 screwdriver, tighten the screws that secure the left control panel assembly.
4. Using the Phillips #1 screwdriver, tighten the screws to secure the cable cover to the system.

**NOTE:** The numbers on the image does not depict the exact steps. The numbers are just for representation of sequence.

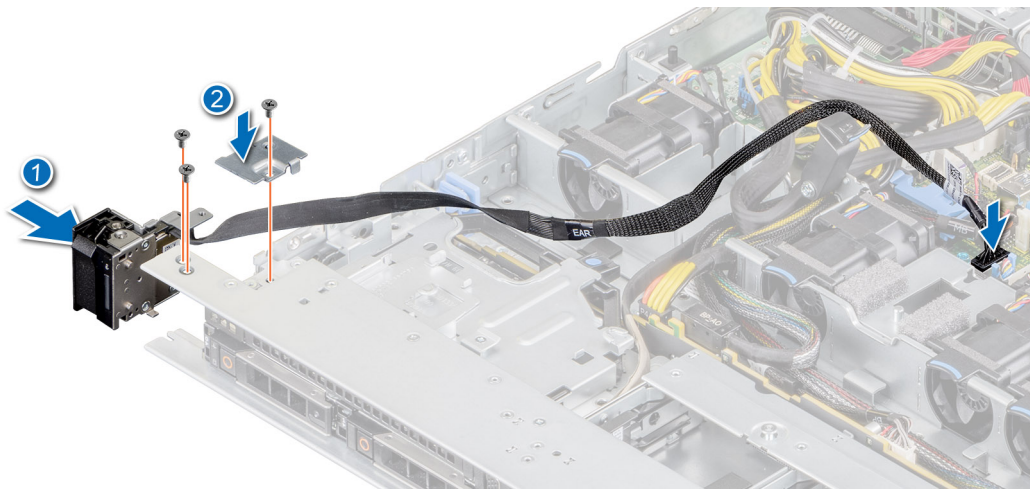

Figure 99. Installing the left control panel

## Next steps

1. [Replace the air shroud](#).
2. [Install the backplane cover](#)
3. Close and secure the cable guiding latch.
4. Follow the procedure listed in the [After working inside your system](#).

# Removing the right control panel

## Prerequisites

1. Follow the safety guidelines listed in the [Safety instructions](#).
2. Follow the procedure listed in the [Before working inside your system](#).
3. If applicable, [remove the backplane cover](#)
4. [Remove the air shroud](#).
5. Lift the cable guiding latch.

## Steps

1. Using the Phillips #1 screwdriver, remove the screws that secure the cable cover and lift the cover away from the system.

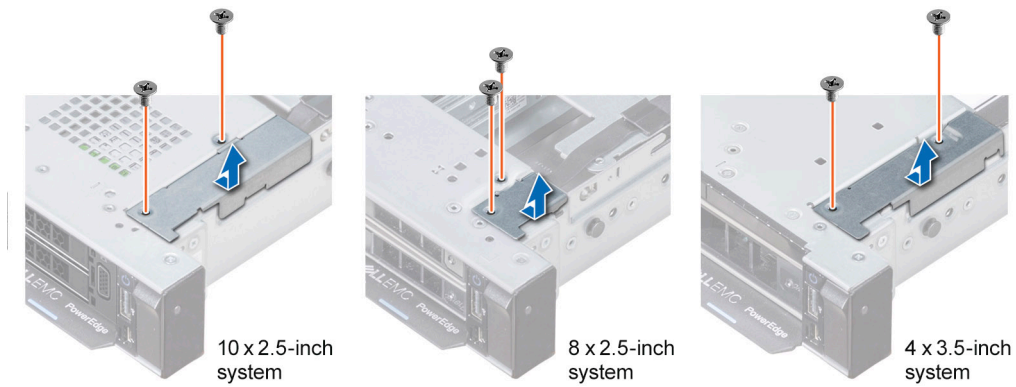
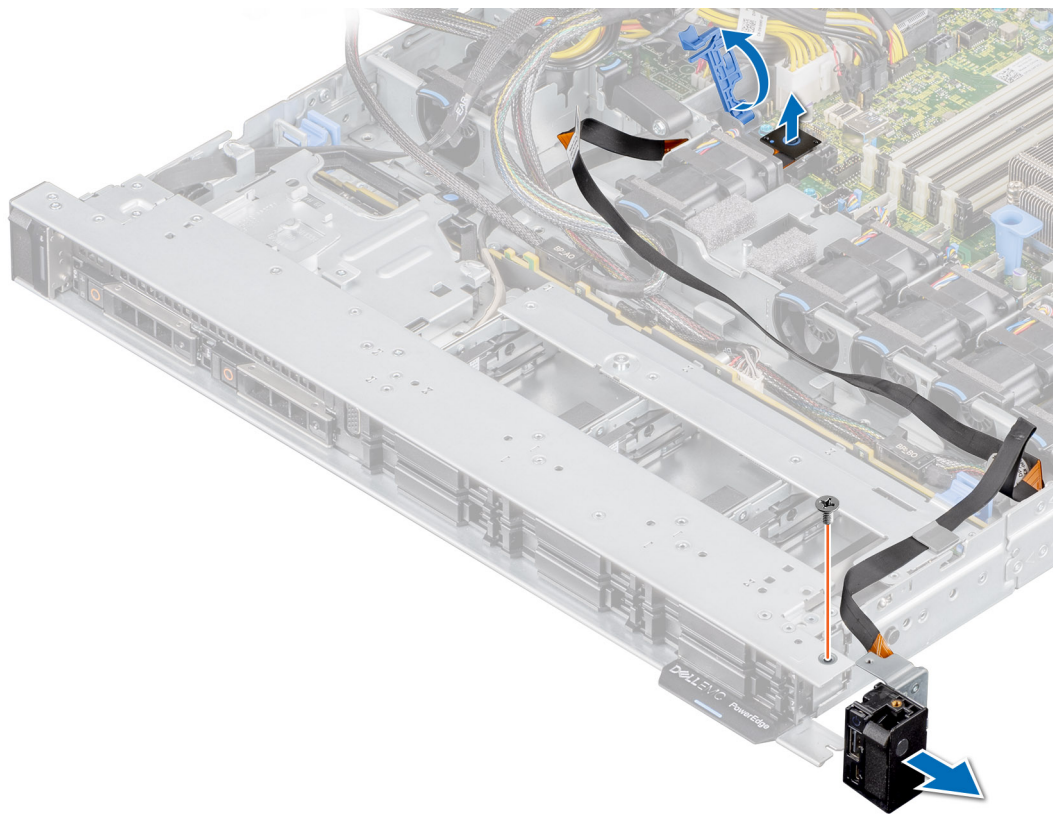

**Figure 100. Removing the cable cover**

2. Lift open the cable latch and disconnect the control panel cable from the connector on the system board.

**NOTE:** Observe the routing of the cable as you remove it from the system.

3. Using the Phillips #1 screwdriver, remove the screws that secure the right control panel assembly.
4. Hold the right control panel assembly and remove it from the system.



**Figure 101. Removing the right control panel**

#### Next steps

Replace the right control panel.

## Installing the right control panel

#### Prerequisites

1. Follow the safety guidelines listed in the [Safety instructions](#).
2. Follow the procedure listed in the [Before working inside your system](#).

## Steps

1. Route the control panel cable and VGA cable through the side wall of the system.

**NOTE:** Route the cable properly to prevent the cable from being pinched or crimped.

2. Align and insert the right control panel assembly in the slot on the system.
3. Connect the control panel cable to the connector system board and secure it using cable latch.
4. Using the Phillips #1 screwdriver, tighten the screws that secure the right control panel assembly.

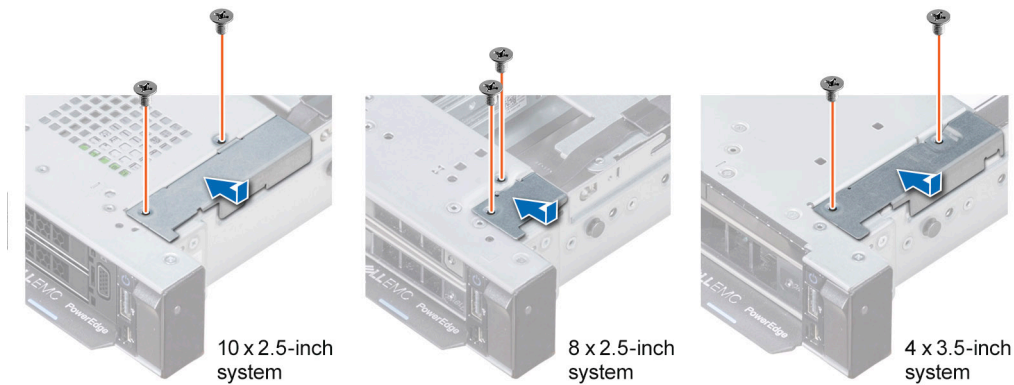

**Figure 102. Installing the cable cover**

5. Connect the control panel cable to the system board and secure it using cable latch.
6. Install the cable cover and secure it in place with screws, using a Phillips #1 screwdriver.

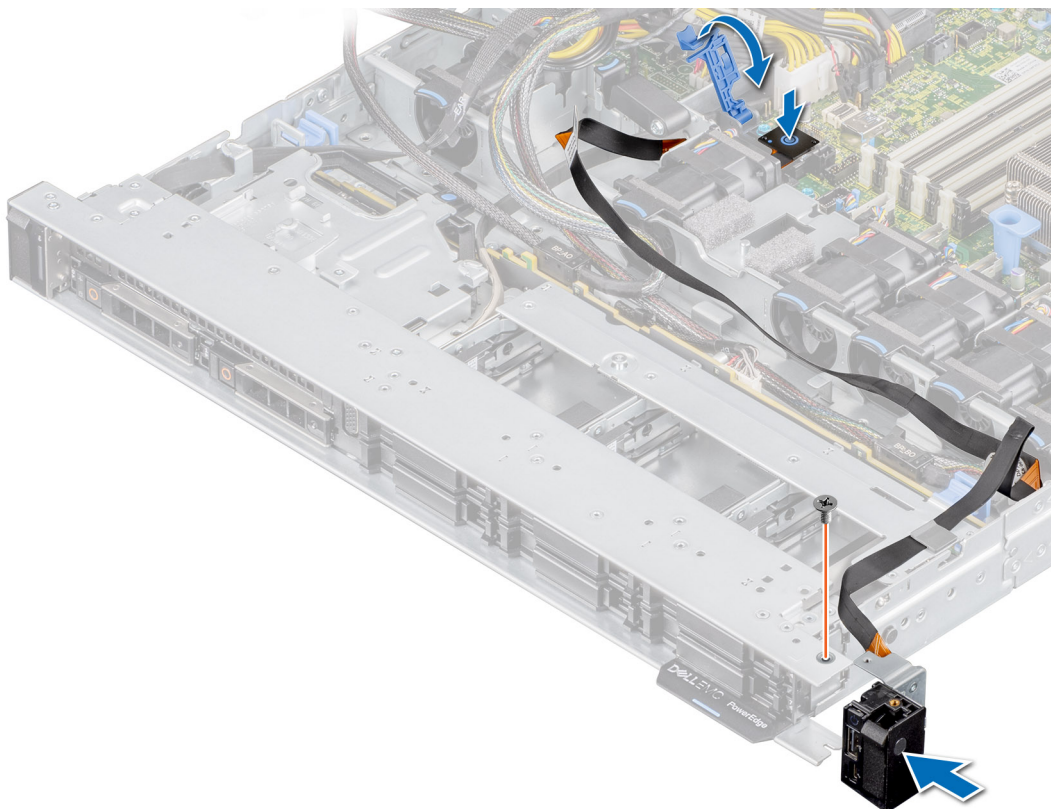

**Figure 103. Installing the right control panel**

## Next steps

1. [Replace the air shroud.](#)
2. [Install the backplane cover](#)
3. Close and secure the cable guiding latch.
4. Follow the procedure listed in the [After working inside your system.](#)

# Jumpers and connectors

This topic provides some basic and specific information about jumpers and switches. It also describes the connectors on the various boards in the system. Jumpers on the system board help to disable the system and reset the passwords. To install components and cables correctly, you must know the connectors on the system board.

## Topics:

- [System board connectors](#)
- [System board jumper settings](#)
- [Disabling a forgotten password](#)

## System board connectors

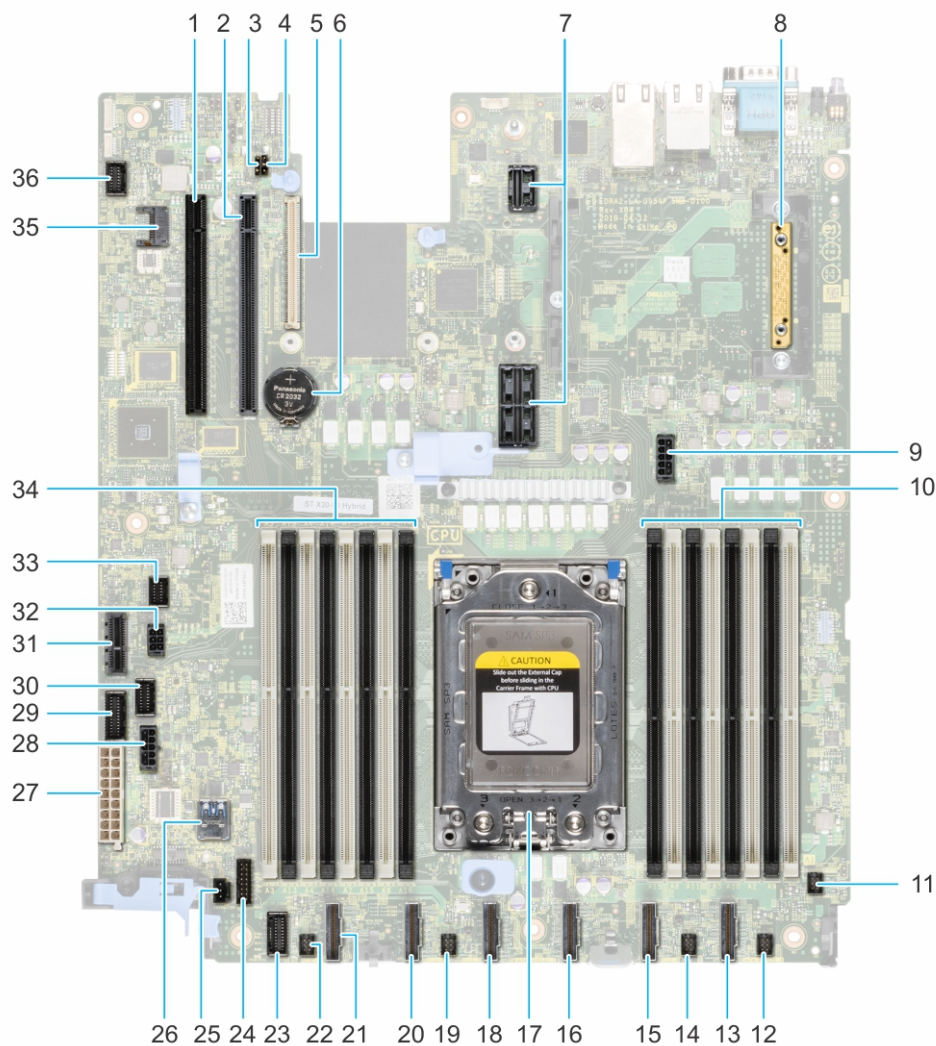

**Figure 104. System board connectors**

1. PCI card Slot 5

2. PCI card Slot 4







- |                              |                               |
|------------------------------|-------------------------------|
| 3. PWRD_EN (Jumpers)         | 4. NVRAM_CLR (Jumpers)        |
| 5. LOM riser card            | 6. Battery                    |
| 7. Riser slot 1A             | 8. Mini PERC                  |
| 9. System power 3            | 10. DIMMS for processor       |
| 11. Fan 6                    | 12. Fan 5                     |
| 13. SATA_A/PCIE_A            | 14. Fan 4                     |
| 15. PCIE-B                   | 16. SATA_B/PCIE_C             |
| 17. Processor                | 18. PCIE-D                    |
| 19. Fan 3                    | 20. PCIE-E                    |
| 21. PCIE-F                   | 22. Fan 2                     |
| 23. Left control panel       | 24. Front backplane signal 1  |
| 25. Intrusion switch         | 26. Internal USB 3.0          |
| 27. System power 1           | 28. System power 2            |
| 29. PIB signal 2             | 30. PIB signal 1              |
| 31. IDSDM                    | 32. Rear backplane/ ODD power |
| 33. Front backplane signal 0 | 34. DIMMS for processor       |
| 35. TPM                      | 36. Front video               |

## System board jumper settings

For information about resetting the password jumper to disable a password, see the [Disabling a forgotten password](#) section.

**Table 47. System board jumper settings**

Jumper	Setting	Description
PWRD_EN	 (default)	The BIOS password feature is enabled.
		The BIOS password feature is disabled. The BIOS password is now disabled and you are not allowed to set a new password.
NVRAM_CLR	 (default)	The BIOS configuration settings are retained at system boot.
		The BIOS configuration settings are cleared at system boot.

**CAUTION:** Be careful when changing the BIOS settings. The BIOS interface is designed for advanced users. Any change in the setting could prevent your system from starting correctly and you might have potential loss of data.

## Disabling a forgotten password

The software security features of the system include a system password and a setup password. The password jumper enables or disables password features and clears any password(s) currently in use.

### Prerequisites

**CAUTION:** Many repairs may only be done by a certified service technician. You should only perform troubleshooting and simple repairs as authorized in your product documentation, or as directed by the online or telephone service and support team. Damage due to servicing that is not authorized by Dell is not covered by your warranty. Read and follow the safety instructions that are shipped with your product.

### Steps

1. Power off the system, and all the attached peripherals, and disconnect the system from the electrical outlet.
2. Remove the system cover.
3. Move the jumper on the system board from pins 2 and 4 to pins 4 and 6.
4. Replace the system cover.

**NOTE:** The existing passwords are not disabled (erased) until the system boots with the jumper on pins 4 and 6. However, before you assign a new system and/or setup password, you must move the jumper back to pins 2 and 4.

**NOTE:** If you assign a new system and/or setup password with the jumper on pins 4 and 6, the system disables the new password(s) the next time it boots.

5. Reconnect the system and all the attached peripherals.
6. Power off the system.
7. Remove the system cover.
8. Move the jumper on the system board from pins 4 and 6 to pins 2 and 4.
9. Replace the system cover.
10. Reconnect the system to the electrical outlet and power on the system, and all the attached peripherals.
11. Assign a new system and/or setup password.

# Technical specifications

The technical and environmental specifications of your system are outlined in this section.

## Topics:

- Chassis dimensions
- System weight
- Processor specifications
- PSU specifications
- Supported operating systems
- Cooling fans specifications
- System battery specifications
- Expansion card riser specifications
- Memory specifications
- Storage controller specifications
- Drive specifications
- Ports and connectors specifications
- Video specifications
- Environmental specifications

## Chassis dimensions

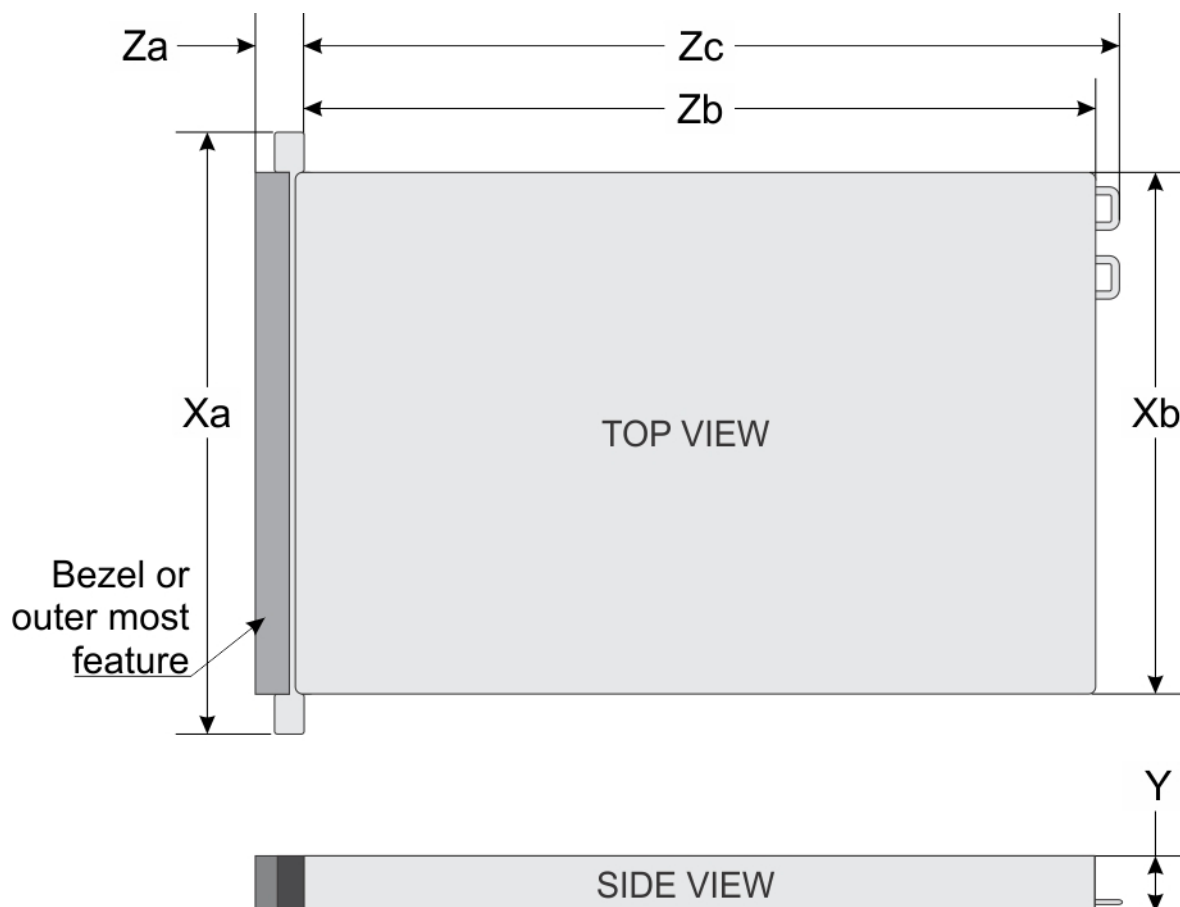

Figure 105. Chassis dimensions

**Table 48. PowerEdge R6515 chassis dimensions**

System configurations	Xa	Xb	Y	Za	Zb*	Zc
4 x 3.5-inches or 10 x 2.5-inches	482.0 mm (18.97 inches)	434.0 mm (17.08 inches)	42.8 mm (1.68 inches)	With bezel: 35.84 mm (1.4 inches)  Without bezel: 22.0 mm (0.87 inches)	657.25 mm (25.87 inches)	692.62 mm (27.26 inches)
8 x 2.5-inches	482.0 mm (18.97 inches)	434.0 mm (17.08 inches)	42.8 mm (1.68 inches)	With bezel: 35.84 mm (1.4 inches)  Without bezel: 22.0 mm (0.87 inches)	606.47 mm (23.87 inches)	641.85 mm (25.26 inches)

**NOTE:** \* Zb goes to the nominal rear wall external surface where the motherboard I/O connectors reside.

## System weight

**Table 49. PowerEdge R6515 system weight**

System configuration	Maximum weight (with all drives)
4 x 3.5-inch configuration	16.75 kg (36.92 lb)
8 x 2.5-inch configuration	15.6 kg (34.39 lb)
10 x 2.5-inch configuration	15.8 kg (34.83 lb)

## Processor specifications

**Table 50. PowerEdge R6515 processor specifications**

Supported processor	Number of processors supported
AMD EYPC 7002 series processor	One

## PSU specifications

**Table 51. PowerEdge R6515 PSU specifications**

PSU	Class	Heat dissipation (maximum)	Frequency	Voltage	Current
550 W AC	Platinum	2107 BTU/hr	50/60 Hz	100-240 V AC, autoranging	7.4 A - 3.7 A

**NOTE:** This system is also designed to connect to the IT power systems with a phase-to-phase voltage not exceeding 230 V.

**NOTE:** When selecting or upgrading the system configuration, to ensure optimum power utilization, verify the system power consumption with the Dell Energy Smart Solution Advisor available at [Dell.com/ESSA](http://Dell.com/ESSA).

## Supported operating systems

The PowerEdge R6515 supports the following operating systems:

- Canonical Ubuntu Server LTS
- Microsoft Windows Server with Hyper-V
- Red Hat Enterprise Linux
- SUSE Linux Enterprise Server
- VMware ESXi

For more information about the specific versions and additions, see <https://www.dell.com/support/home/Drivers/SupportedOS/poweredge-r6515>.

## Cooling fans specifications

The PowerEdge R6515 system supports both the Standard fan (STD fan) and High Performance fan (HPR fan) and requires all six fans to be installed.

**NOTE: Mixing of STD and HPR fans is not supported.**

**NOTE: The STD and HPR fans installation depends on the system configuration. For more information about the fan support configuration or matrix, see [Thermal restriction matrix](#).**

## System battery specifications

The PowerEdge R6515 system supports CR 2032 3.0-V lithium coin cell system battery.

## Expansion card riser specifications

The PowerEdge R6515 system supports up to two PCI express (PCIe) expansion cards:

**Table 52. Expansion card slots supported on the system board**

PCIe slot	Riser	PCIe slot height	PCIe slot length	Slot width
Slot 2	Riser 1A	Low-profile	Half-length	x16 (Gen 3)
Slot 3	Riser 2	Low-profile	Half-length	x16 (Gen 4)

## Memory specifications

The PowerEdge R6515 system supports the following memory specifications for optimized operation.

**Table 53. Memory specifications**

DIMM type	DIMM rank	DIMM capacity	Minimum RAM	Maximum RAM
RDIMM	Single rank	8 GB	8 GB	128 GB
	Dual rank	16 GB	16 GB	256 GB
		32 GB	32 GB	512 GB
		64 GB	64 GB	1 TB
3DS LRDIMM	Octa rank	128 GB	128 GB	2 TB

**Table 54. Memory module sockets**

Memory module sockets	Speed
Sixteen 288-pin	3200 MT/s, 2933 MT/s, 2666 MT/s

## Storage controller specifications

The PowerEdge R6515 system supports the following controller cards:

**Table 55. PowerEdge R6515 system controller cards**

Internal controllers	External controllers
<ul style="list-style-type: none"> <li>· PERC H740P</li> <li>· PERC H730P</li> <li>· PERC H330</li> <li>· S150</li> <li>· HBA330</li> <li>· Boot Optimized Storage Subsystem (BOSS-S1): HWRAID 2 x M.2 SSDs</li> </ul>	<ul style="list-style-type: none"> <li>· 12Gbps SAS Ext. HBA</li> <li>· H840</li> </ul>

## Drive specifications

### Drives

The PowerEdge R6515 system supports up to 4 x 3.5-inch or 8 x 2.5-inch SAS or SATA drives or up to 10 x 2.5-inch drives (with 8 SAS/SATA/NVMe drives + 2 NVMe drives) .

**NOTE:** For more information about how to hot swap NVMe PCIe SSD U.2 device, see the *Dell Express Flash NVMe PCIe SSD User's Guide* at [www.dell.com/support](http://www.dell.com/support) > Browse all Products > Data Center Infrastructure > Storage Adapters & Controllers > Dell PowerEdge Express Flash NVMe PCIe SSD > Documentation > Manuals and Documents.

### Optical drives

The PowerEdge R6515 system supports the following optical drives.

**Table 56. Supported optical drive type**

Supported drive type	Supported number of drives
Dedicated SATA DVD-ROM drive or DVD +/-RW drive	One

## Ports and connectors specifications

### USB ports specifications

**Table 57. PowerEdge R6515 system USB specifications**

Front		Rear		Internal	
USB port type	No. of ports	USB port type	No. of ports	USB port type	No. of ports
USB 2.0-compliant port	One	USB 3.0-compliant ports	Two	Internal USB 3.0-compliant port	One
Micro USB 2.0-compliant port for iDRAC Direct	One				

**NOTE:** The micro USB 2.0 compliant port can only be used as an iDRAC Direct or a management port.

### NIC ports specifications

The PowerEdge R6515 system supports up to two 10/100/1000 Mbps Network Interface Controller (NIC) ports that are located on the back panel. The system also supports LAN on Motherboard (LOM) on an optional riser card.

You can install one LOM riser card. The supported LOM riser options are:

- 2 x 1 Gb Base-T
- 2 x 10Gb Base-T
- 2 x 10Gb SPF+
- 2 x 25Gb SPF+

**NOTE:**

- You can install up to two PCIe add-on NIC cards.
- For information about Linux network performance settings, see the *Linux Network Tuning Guide for AMD EPYC Processor Based Servers* at [AMD.com](https://www.amd.com)

## Serial connector specifications

The PowerEdge R6515 system supports one serial connector on the back panel, which is a 9-pin connector, Data Terminal Equipment (DTE), 16550-compliant.

## VGA ports specifications

The PowerEdge R6515 system supports two 15-pin VGA ports one each on the front and back panels.

## IDSDM

The PowerEdge R6515 system supports Internal Dual SD module (IDSDM) with the below storage capacity:

- 16 GB
- 32 GB
- 64 GB

**NOTE:** One IDSDM card slot is dedicated for redundancy.

**NOTE:** Use Dell EMC branded microSD cards that are associated with the IDSDM configured systems.

## Video specifications

The PowerEdge R6515 system supports integrated Matrox G200eR2 graphics controller with 16 MB of video frame buffer.

**Table 58. Supported front video resolution options**

Resolution	Refresh rate (Hz)	Color depth (bits)
1024 x 768	60	8, 16, 32
1280 x 800	60	8, 16, 32
1280 x 1024	60	8, 16, 32
1360 x 768	60	8, 16, 32
1440 x 900	60	8, 16, 32

**Table 59. Supported rear video resolution options**

Resolution	Refresh rate (Hz)	Color depth (bits)
1024 x 768	60	8, 16, 32
1280 x 800	60	8, 16, 32
1280 x 1024	60	8, 16, 32
1360 x 768	60	8, 16, 32
1440 x 900	60	8, 16, 32

Resolution	Refresh rate (Hz)	Color depth (bits)
1600 x 900	60	8, 16, 32
1600 x 1200	60	8, 16, 32
1680 x 1050	60	8, 16, 32
1920 x 1080	60	8, 16, 32
1920 x 1200	60	8, 16, 32

## Environmental specifications

**NOTE:** For additional information about environmental certifications, refer to the *Product Environmental Datasheet* located with the Manuals & Documents on [www.dell.com/support](http://www.dell.com/support).

### Operational climatic range category A2

Table 60. Operational climatic range category A2

Allowable continuous operations	
Temperature ranges for altitude $\leq 900$ meters ( $\leq 2,953$ feet)	10 to 35°C (50 to 95°F) with no direct sunlight on the platform
Humidity percent ranges (Non-condensing at all times)	8% RH with -12°C minimum dew point to 80% RH with 21°C (69.8°F) maximum dew point
Operational altitude de-rating	Maximum temperature is reduced by 1°C/300 meters (1.8°F/984 feet) above 900 meters (2,953 feet)

### Operational climatic range category A3

Table 61. Operational climatic range category A3

Allowable continuous operations	
Temperature ranges for altitude $\leq 900$ meters ( $\leq 2,953$ feet)	5 to 40°C (41 to 104°F) with no direct sunlight on the platform
Humidity percent ranges (Non-condensing at all times)	8% RH with -12°C minimum dew point to 85% RH with 24°C (75.2°F) maximum dew point
Operational altitude de-rating	Maximum temperature is reduced by 1°C/175 meters (1.8°F/574 feet) above 900 meters (2,953 feet)

## Thermal restriction for ASHRAE A3/Fresh air environment

- CPU TDP equal or greater than 180 W are not supported.
- 128 GB or greater capacity LRDIMMs are not supported.
- Redundant power supply configuration is required, but PSU failure is not supported
- Non-Dell qualified peripheral cards greater than 25 W are not supported.
- GPU card is not supported.
- PCIe SSD is not supported.



# Shared requirements across all categories

**Table 62. Shared requirements across all categories**

Allowable operations	
Maximum temperature gradient (applies to both operation and non-operation)	20°C in an hour* (36°F in an hour) and 5°C in 15 minutes (9°F in 15 minutes), 5°C in an hour* (9°F in an hour) for tape hardware
Non-operational temperature limits	-40 to 65°C (-40 to 149°F)
Non-operational humidity limits	5% to 95% RH with 27°C (80.6°F) maximum dew point
Maximum non-operational altitude	12,000 meters (39,370 feet)
Maximum operational altitude	3,048 meters (10,000 feet)

\*: Per ASHRAE thermal guidelines, these are not instantaneous rates of temperature change.

**Table 63. Maximum vibration specifications**

Maximum vibration	Specifications
Operating	0.26 G <sub>rms</sub> at 5 Hz to 350 Hz (all operation orientations)
Storage	1.88 G <sub>rms</sub> at 10 Hz to 500 Hz for 15 minutes (all six sides tested)

**Table 64. Maximum shock pulse specifications**

Maximum shock pulse	Specifications
Operating	24 executed shock pulses in the positive and negative x, y, and z axis of 6 G for up to 11 ms. (4 pulse on each side of the system)
Storage	Six consecutively executed shock pulses in the positive and negative x, y, and z axis (one pulse on each side of the system) of 71 G for up to 2 ms.

## Particulate and gaseous contamination specifications

The following table defines the limitations that help avoid any damages to the IT equipment and/or, or both failure from particulate and gaseous contamination. If the levels of particulate or gaseous pollution exceed the specified limitations and results in equipment damage or failure, you must rectify the environmental conditions. Remediation of environmental conditions is the responsibility of the customer.

**Table 65. Particulate contamination specifications**

Particulate contamination	Specifications
Air filtration	<p>Data center air filtration as defined by ISO Class 8 per ISO 14644-1 with a 95% upper confidence limit.</p> <ul style="list-style-type: none"> <li><b>i</b> <b>NOTE:</b> This condition applies to data center environments only. Air filtration requirements do not apply to IT equipment designed to be used outside a data center, in environments such as an office or factory floor.</li> <li><b>i</b> <b>NOTE:</b> Air entering the data center must have MERV11 or MERV13 filtration.</li> <li><b>i</b> <b>NOTE:</b> Air filtering can also be accomplished by filtering room air with MERV8 filter per ANSI/ASHARE Standard 127.</li> </ul>
Conductive dust	Air must be free of conductive dust, zinc whiskers, or other conductive particles.

Particulate contamination	Specifications
	<p><b>i</b> NOTE: This condition applies to data center and non-data center environments.</p> <p><b>i</b> NOTE: Common sources of conductive dust include manufacturing processes, and zinc whiskers from the plating on the bottom of raised floor tiles.</p>
Corrosive dust	<ul style="list-style-type: none"> <li>Air must be free of corrosive dust.</li> <li>Residual dust present in the air must have a deliquescent point less than 60% relative humidity.</li> </ul> <p><b>i</b> NOTE: This condition applies to data center and non-data center environments.</p>

**Table 66. Gaseous contamination specifications**

Gaseous contamination	Specifications
Copper Coupon Corrosion rate	<300 Å/month per Class G1 as defined by ANSI/ISA71.04-2013
Silver Coupon Corrosion rate	<200 Å/month as defined by ANSI/ISA71.04-2013

**i** NOTE: Maximum corrosive contaminant levels measured at ≤50% relative humidity.

## Thermal restriction matrix

**Table 67. Thermal restriction matrix for processor and fans**

Features, processor type and specifications		Configuration type, fan type and ambient temperature support		
Storage configuration		4 x 3.5-inch drives	8 x 2.5-inch drives	10 x 2.5-inch drives (NVMe)
		Fan type: Standard fan (STD fan)/ Performance fan (HPR fan)		
TDP (W)	Processor heat sink (1U): Standard heat sink (STD HSK/ Performance heat sink (HPR HSK)	Ambient = 35°C	Ambient = 35°C	Ambient = 30°C
225	HPR HSK	Yes (HPR fan)	Yes (HPR fan)	Yes (HPR fan)
200	HPR HSK	Yes (STD fan)	Yes (STD fan)	Yes (HPR fan)
180	HPR HSK	Yes (STD fan)	Yes (STD fan)	Yes (HPR fan)
155	STD HSK	Yes (STD fan)	Yes (STD fan)	Yes (HPR fan)

**Table 68. Thermal restriction matrix for T4 GPGPU**

Riser configurations	Configuration type and ambient temperature support		
	4 x 3.5-inch drives	8 x 2.5-inch drives	10 x 2.5-inch drives (NVMe)
	Fan type: Performance fan (HPR fan)		
	Ambient = 30°C		
Slot 2	HPR fan	HPR fan	NA
Slot 3	HPR fan	HPR fan	HPR fan + NVMe drives from slot 6 to 9 + drives from slot 0 to 5

## Other thermal restrictions

1. SolarFlare, Mellanox CX4/CX5/CX6, P4800 AIC can only support up to 35°C ambient.
2. Mellanox CX6 on 10x2.5-inch configuration can only support on slot 3.
3. 25G OCP card does not support with 128 GB LRDIMM on 10x2.5-inch configuration.
4. HPR fan is required with 128 GB LRDIMM.
5. T4 GPGPU does not support with 128 GB LRDIMM.

# System diagnostics and indicator codes

The diagnostic indicators on the system front panel display system status during system startup.

## Topics:

- Status LED indicators
- System health and system ID indicator codes
- iDRAC Quick Sync 2 indicator codes
- iDRAC Direct LED indicator codes
- LCD panel
- NIC indicator codes
- Power supply unit indicator codes
- Drive indicator codes
- Using system diagnostics

## Status LED indicators

**NOTE:** The indicators display solid amber if any error occurs.

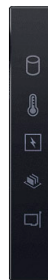







Figure 106. Status LED indicators

Table 69. Status LED indicators and descriptions

Icon	Description	Condition	Corrective action
	Drive indicator	The indicator turns solid amber if there is a drive error.	<ul style="list-style-type: none"> <li>• Check the System Event Log to determine if the drive has an error.</li> <li>• Run the appropriate Online Diagnostics test. Restart the system and run embedded diagnostics (ePSA).</li> <li>• If the drives are configured in a RAID array, restart the system, and enter the host adapter configuration utility program.</li> </ul>
	Temperature indicator	The indicator turns solid amber if the system experiences a thermal error (for example, the ambient temperature is out of range or there is a fan failure).	<p>Ensure that none of the following conditions exist:</p> <ul style="list-style-type: none"> <li>• A cooling fan has been removed or has failed.</li> <li>• System cover, air shroud, memory module blank, or back filler bracket is removed.</li> <li>• Ambient temperature is too high.</li> <li>• External airflow is obstructed.</li> </ul> <p>If the problem persists, see the <a href="#">Getting help</a> section.</p>

Icon	Description	Condition	Corrective action
	Electrical indicator	The indicator turns solid amber if the system experiences an electrical error (for example, voltage out of range, or a failed power supply unit (PSU) or voltage regulator).	Check the System Event Log or system messages for the specific issue. If it is due to a problem with the PSU, check the LED on the PSU. Reseat the PSU.  If the problem persists, see the <a href="#">Getting help</a> section.
	Memory indicator	The indicator turns solid amber if a memory error occurs.	Check the System Event Log or system messages for the location of the failed memory. Reseat the memory module.  If the problem persists, see the <a href="#">Getting help</a> section.
	PCIe indicator	The indicator turns solid amber if a PCIe card experiences an error.	Restart the system. Update any required drivers for the PCIe card. Reinstall the card.  If the problem persists, see the <a href="#">Getting help</a> section.  <b>NOTE:</b> For more information about the supported PCIe cards, see the <a href="#">Expansion card installation guidelines</a> section.

## System health and system ID indicator codes

The system health and system ID indicator is located on the left control panel of the system.



Figure 107. System health and system ID indicator



Figure 108. System health and system ID indicator

**Table 70. System health and system ID indicator codes**

System health and system ID indicator code	Condition
Solid blue	Indicates that the system is powered on, is healthy, and system ID mode is not active. Press the system health and system ID button to switch to system ID mode.
Blinking blue	Indicates that the system ID mode is active. Press the system health and system ID button to switch to system health mode.
Solid amber	Indicates that the system is in fail-safe mode. If the problem persists, see the Getting help section.
Blinking amber	Indicates that the system is experiencing a fault. Check the System Event Log for specific error messages. For information about the event and error messages generated by the system firmware and agents that monitor system components, see the Error Code Lookup page at <a href="http://qrl.dell.com">qrl.dell.com</a>

## iDRAC Quick Sync 2 indicator codes

iDRAC Quick Sync 2 module (optional) is located on the left control panel of the system.



**Table 71. iDRAC Quick Sync 2 indicators and descriptions**

iDRAC Quick Sync 2 indicator code	Condition	Corrective action
Off (default state)	Indicates that the iDRAC Quick Sync 2 feature is powered off. Press the iDRAC Quick Sync 2 button to power on the iDRAC Quick Sync 2 feature.	If the LED fails to power on, reseal the left control panel flex cable and check. If the problem persists, see the <a href="#">Getting help</a> section.
Solid white	Indicates that iDRAC Quick Sync 2 is ready to communicate. Press the iDRAC Quick Sync 2 button to power off.	If the LED fails to power off, restart the system. If the problem persists, see the <a href="#">Getting help</a> section.
Blinks white rapidly	Indicates data transfer activity.	If the indicator continues to blink indefinitely, see the <a href="#">Getting help</a> section.
Blinks white slowly	Indicates that firmware update is in progress.	If the indicator continues to blink indefinitely, see the <a href="#">Getting help</a> section.
Blinks white five times rapidly and then powers off	Indicates that the iDRAC Quick Sync 2 feature is disabled.	Check if iDRAC Quick Sync 2 feature is configured to be disabled by iDRAC. If the problem persists, see the <a href="#">Getting help</a> section. <a href="http://www.dell.com/poweredgemanuals">www.dell.com/poweredgemanuals</a> or <i>Dell OpenManage Server Administrator User's Guide</i> at <a href="http://www.dell.com/openmanagemanuals">www.dell.com/openmanagemanuals</a> .
Solid amber	Indicates that the system is in fail-safe mode.	Restart the system. If the problem persists, see the <a href="#">Getting help</a> section.
Blinking amber	Indicates that the iDRAC Quick Sync 2 hardware is not responding properly.	Restart the system. If the problem persists, see the <a href="#">Getting help</a> section.

# iDRAC Direct LED indicator codes

The iDRAC Direct LED indicator lights up to indicate that the port is connected and is being used as a part of the iDRAC subsystem.

You can configure iDRAC Direct by using a USB to micro USB (type AB) cable, which you can connect to your laptop or tablet. Cable length should not exceed 3 feet (0.91 meters). Performance could be affected by cable quality. The following table describes iDRAC Direct activity when the iDRAC Direct port is active:

**Table 72. iDRAC Direct LED indicator codes**

iDRAC Direct LED indicator code	Condition
Solid green for two seconds	Indicates that the laptop or tablet is connected.
Blinking green (on for two seconds and off for two seconds)	Indicates that the laptop or tablet connected is recognized.
Powers off	Indicates that the laptop or tablet is unplugged.

## LCD panel

The LCD panel provides system information, status, and error messages to indicate if the system is functioning correctly or requires attention. The LCD panel is used to configure or view the iDRAC IP address of the system. For information about the event and error messages generated by the system firmware and agents that monitor system components, see the Error Code Lookup page at [qrl.dell.com](http://qrl.dell.com).

The LCD panel is available only on the optional front bezel. The optional front bezel is hot pluggable.

The status and conditions of the LCD panel are outlined here:

- The LCD backlight is white during normal operating conditions.
- If there is an issue, the LCD backlight turns amber and displays an error code followed by descriptive text.
- **NOTE: If the system is connected to a power source and an error is detected, the LCD turns amber regardless of whether the system is powered on or off.**
- When the system powers off and there are no errors, the LCD enters the standby mode after five minutes of inactivity. Press any button on the LCD to power it on.
- If the LCD panel stops responding, remove the bezel and reinstall it.  
If the problem persists, see [Getting help](#).
- The LCD backlight remains off if LCD messaging is powered off using the iDRAC utility, the LCD panel, or other tools.

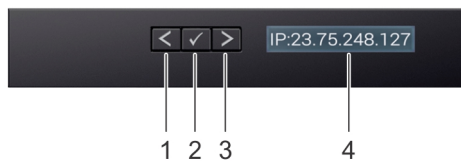

**Figure 109. LCD panel features**

**Table 73. LCD panel features**



Item	Button or display	Description
1	Left	Moves the cursor back in one-step increments.
2	Select	Selects the menu item highlighted by the cursor.
3	Right	Moves the cursor forward in one-step increments. During message scrolling: <ul style="list-style-type: none"> <li>• Press and hold the right button to increase scrolling speed.</li> <li>• Release the button to stop.</li> </ul>

Item	Button or display	Description
		 <b>NOTE: The display stops scrolling when the button is released. After 45 seconds of inactivity, the display starts scrolling.</b>
4	LCD display	Displays the system information, status, and error messages or iDRAC IP address.

## Viewing Home screen

The **Home** screen displays user-configurable information about the system. This screen is displayed during normal system operation when there are no status messages or errors. When the system turns off and there are no errors, LCD enters the standby mode after five minutes of inactivity. Press any button on the LCD to turn it on.

### Steps

1. To view the **Home** screen, press one of the three navigation buttons (Select, Left, or Right).
2. To navigate to the **Home** screen from another menu, complete the following steps:
  - a) Press and hold the navigation button till the up arrow  is displayed.
  - b) Navigate to the **Home** icon  using the up arrow .
  - c) Select the **Home** icon.
  - d) On the **Home** screen, press the **Select** button to enter the main menu.

## Setup menu

 **NOTE: When you select an option in the Setup menu, you must confirm the option before proceeding to the next action.**

Table 74. Setup menu

Option	Description
iDRAC	Select <b>DHCP</b> or <b>Static IP</b> to configure the network mode. If <b>Static IP</b> is selected, the available fields are <b>IP</b> , <b>Subnet (Sub)</b> , and <b>Gateway (Gtw)</b> . Select <b>Setup DNS</b> to enable DNS and to view domain addresses. Two separate DNS entries are available.
Set error	Select <b>SEL</b> to view LCD error messages in a format that matches the IPMI description in the SEL. This enables you to match an LCD message with an SEL entry.  Select <b>Simple</b> to view LCD error messages in a simplified user-friendly description. For information about the event and error messages generated by the system firmware and agents that monitor system components, see the Error Code Lookup page at <a href="http://qrl.dell.com">qrl.dell.com</a> .
Set home	Select the default information to be displayed on the <b>Home</b> screen. See View menu section for the options and option items that can be set as the default on the <b>Home</b> screen.

## View menu

 **NOTE: When you select an option in the View menu, you must confirm the option before proceeding to the next action.**

Table 75. View menu

Option	Description
iDRAC IP	Displays the <b>IPv4</b> or <b>IPv6</b> addresses for iDRAC9. Addresses include <b>DNS (Primary and Secondary)</b> , <b>Gateway</b> , <b>IP</b> , and <b>Subnet</b> (IPv6 does not have Subnet).
MAC	Displays the MAC addresses for <b>iDRAC</b> , <b>iSCSI</b> , or <b>Network</b> devices.
Name	Displays the name of the <b>Host</b> , <b>Model</b> , or <b>User String</b> for the system.
Number	Displays the <b>Asset tag</b> or the <b>Service tag</b> for the system.



Option	Description
<b>Power</b>	Displays the power output of the system in BTU/hr or Watts. The display format can be configured in the <b>Set home</b> submenu of the <b>Setup</b> menu.
<b>Temperature</b>	Displays the temperature of the system in Celsius or Fahrenheit. The display format can be configured in the <b>Set home</b> submenu of the <b>Setup</b> menu.

## NIC indicator codes

Each NIC on the back of the system has indicators that provide information about the activity and link status. The activity LED indicator indicates if data is flowing through the NIC, and the link LED indicator indicates the speed of the connected network.

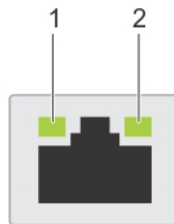

**Figure 110. NIC indicator codes**

1. Link LED indicator
2. Activity LED indicator

**Table 76. NIC indicator codes**

NIC indicator codes	Condition
Link and activity indicators are off.	Indicates that the NIC is not connected to the network.
Link indicator is green, and activity indicator is blinking green.	Indicates that the NIC is connected to a valid network at its maximum port speed, and data is being sent or received.
Link indicator is amber, and activity indicator is blinking green.	Indicates that the NIC is connected to a valid network at less than its maximum port speed, and data is being sent or received.
Link indicator is green, and activity indicator is off.	Indicates that the NIC is connected to a valid network at its maximum port speed, and data is not being sent or received.
Link indicator is amber, and activity indicator is off.	Indicates that the NIC is connected to a valid network at less than its maximum port speed, and data is not being sent or received.
Link indicator is blinking green, and activity is off.	Indicates that the NIC identify is enabled through the NIC configuration utility.

## Power supply unit indicator codes

AC power supply units (PSUs) have an illuminated translucent handle that serves as an indicator. The indicator shows if power is present or if a power fault has occurred.



**Figure 111. AC PSU status indicator**

1. AC PSU status indicator/handle

**Table 77. AC PSU status indicator codes**

Power indicator codes	Condition
Green	Indicates that a valid power source is connected to the PSU and the PSU is operational.
Blinking amber	Indicates an issue with the PSU.
Not powered on	Indicates that the power is not connected to the PSU.
Blinking green	Indicates that the firmware of the PSU is being updated. <b>⚠ CAUTION: Do not disconnect the power cord or unplug the PSU when updating firmware. If firmware update is interrupted, the PSUs do not function.</b>
Blinking green and powers off	When hot-plugging a PSU, it blinks green five times at a rate of 4 Hz and powers off. This indicates a PSU mismatch due to efficiency, feature set, health status, or supported voltage. <b>⚠ CAUTION: If two PSUs are installed, both the PSUs must have the same type of label; for example, Extended Power Performance (EPP) label. Mixing PSUs from previous generations of PowerEdge servers is not supported, even if the PSUs have the same power rating. This results in a PSU mismatch condition or failure to power on the system.</b> <b>⚠ CAUTION: If two PSUs are used, they must be of the same type and have the same maximum output power.</b> <b>⚠ CAUTION: When correcting a PSU mismatch, replace the PSU with the blinking indicator. Swapping the PSU to make a matched pair can result in an error condition and an unexpected system shutdown. To change from a high output configuration to a low output configuration or vice versa, you must power off the system.</b> <b>⚠ CAUTION: AC PSUs support both 240 V and 120 V input voltages with the exception of Titanium PSUs, which support only 240 V. When two identical PSUs receive different input voltages, they can output different wattages, and trigger a mismatch.</b>

## Drive indicator codes

The LEDs on the drive carrier indicates the state of each drive. Each drive carrier has two LEDs: an activity LED (green) and a status LED (bicolor, green/amber). The activity LED blinks whenever the drive is accessed.



**Figure 112. Drive indicators**

1. Drive activity LED indicator
2. Drive status LED indicator
3. Drive capacity label

**ⓘ NOTE: If the drive is in the Advanced Host Controller Interface (AHCI) mode, the status LED indicator does not power on.**

**ⓘ NOTE: Drive status indicator behavior is managed by Storage Spaces Direct. Not all drive status indicators may be used.**

**Table 78. Drive indicator codes**

Drive status indicator code	Condition
Blinks green twice per second	Indicates that the drive is being identified or preparing for removal.

Drive status indicator code	Condition
Off	Indicates that the drive is ready for removal. <b>i</b> <b>NOTE: The drive status indicator remains off until all drives are initialized after the system is powered on. Drives are not ready for removal during this time.</b>
Blinks green, amber, and then powers off	Indicates that there is an expected drive failure.
Blinks amber four times per second	Indicates that the drive has failed.
Blinks green slowly	Indicates that the drive is rebuilding.
Solid green	Indicates that the drive is online.
Blinks green for three seconds, amber for three seconds, and then powers off after six seconds	Indicates that the rebuild has stopped.

## Using system diagnostics

If you experience an issue with the system, run the system diagnostics before contacting Dell for technical assistance. The purpose of running system diagnostics is to test the system hardware without using additional equipment or risking data loss. If you are unable to fix the issue yourself, service and support personnel can use the diagnostics results to help you solve the issue.

## Dell Embedded System Diagnostics

**i** **NOTE: The Dell Embedded System Diagnostics is also known as Enhanced Pre-boot System Assessment (ePSA) diagnostics.**

The Embedded System Diagnostics provide a set of options for particular device groups or devices allowing you to:

- Run tests automatically or in an interactive mode
- Repeat tests
- Display or save test results
- Run thorough tests to introduce additional test options to provide extra information about the failed device(s)
- View status messages that inform you if tests are completed successfully
- View error messages that inform you of issues encountered during testing

## Running the Embedded System Diagnostics from the Dell Lifecycle Controller

### Steps

1. As the system boots, press F10.
2. Select **Hardware Diagnostics** → **Run Hardware Diagnostics**.  
The **ePSA Pre-boot System Assessment** window is displayed, listing all devices detected in the system. The diagnostics starts executing the tests on all the detected devices.

## Running the Embedded System Diagnostics from Boot Manager

Run the Embedded System Diagnostics (ePSA) if your system does not boot.

### Steps

1. When the system is booting, press F11.
2. Use the up arrow and down arrow keys to select **System Utilities** > **Launch Diagnostics**.
3. Alternatively, when the system is booting, press F10, select **Hardware Diagnostics** > **Run Hardware Diagnostics**.  
The **ePSA Pre-boot System Assessment** window is displayed, listing all devices detected in the system. The diagnostics starts executing the tests on all the detected devices.

## System diagnostic controls

Table 79. System diagnostic controls

Menu	Description
<b>Configuration</b>	Displays the configuration and status information of all detected devices.
<b>Results</b>	Displays the results of all tests that are run.
<b>System health</b>	Provides the current overview of the system performance.
<b>Event log</b>	Displays a time-stamped log of the results of all tests run on the system. This is displayed if at least one event description is recorded.

# Getting help

## Topics:

- [Recycling or End-of-Life service information](#)
- [Contacting Dell](#)
- [Accessing system information by using QRL](#)
- [Receiving automated support with SupportAssist](#)

## Recycling or End-of-Life service information

Take back and recycling services are offered for this product in certain countries. If you want to dispose of system components, visit [www.dell.com/recyclingworldwide](http://www.dell.com/recyclingworldwide) and select the relevant country.

## Contacting Dell

Dell provides online and telephone based support and service options. If you do not have an active internet connection, you can find Dell contact information on your purchase invoice, packing slip, bill or Dell product catalog. The availability of services varies depending on the country and product, and some services may not be available in your area. To contact Dell for sales, technical assistance, or customer service issues:

### Steps

1. Go to [www.dell.com/support/home](http://www.dell.com/support/home)
2. Select your country from the drop-down menu on the lower right corner of the page.
3. For customized support:
  - a) Enter the system Service Tag in the **Enter a Service Tag, Serial Number, Service Request, Model, or Keyword** field.
  - b) Click **Submit**.  
The support page that lists the various support categories is displayed.
4. For general support:
  - a) Select your product category.
  - b) Select your product segment.
  - c) Select your product.  
The support page that lists the various support categories is displayed.
5. For contact details of Dell Global Technical Support:
  - a) Click [Global Technical Support](#)
  - b) The **Contact Technical Support** page is displayed with details to call, chat, or e-mail the Dell Global Technical Support team.

## Accessing system information by using QRL

You can use the Quick Resource Locator (QRL) located on the information tag in the front of the R6515 system, to access information about Dell EMC PowerEdge R6515. The QRL is located on the top of the system cover.

### Prerequisites

Ensure that your smartphone or tablet has the QR code scanner installed.

The QRL includes the following information about your system:

- How-to videos
- Reference materials, including the Installation and Service Manual, LCD diagnostics, and mechanical overview
- The system service tag to quickly access the specific hardware configuration and warranty information
- A direct link to Dell to contact technical assistance and sales teams

## Steps

1. Go to [www.dell.com/qrl](http://www.dell.com/qrl) and navigate to your specific product or
2. Use your smartphone or tablet to scan the model-specific Quick Resource (QR) code on your system or in the Quick Resource Locator section.

## Quick Resource Locator for PowerEdge R6515 system



Figure 113. Quick Resource Locator for PowerEdge R6515 system

## Receiving automated support with SupportAssist

Dell EMC SupportAssist is an optional Dell EMC Services offering that automates technical support for your Dell EMC server, storage, and networking devices. By installing and setting up a SupportAssist application in your IT environment, you can receive the following benefits:

- **Automated issue detection** — SupportAssist monitors your Dell EMC devices and automatically detects hardware issues, both proactively and predictively.
- **Automated case creation** — When an issue is detected, SupportAssist automatically opens a support case with Dell EMC Technical Support.
- **Automated diagnostic collection** — SupportAssist automatically collects system state information from your devices and uploads it securely to Dell EMC. This information is used by Dell EMC Technical Support to troubleshoot the issue.
- **Proactive contact** — A Dell EMC Technical Support agent contacts you about the support case and helps you resolve the issue.

The available benefits vary depending on the Dell EMC Service entitlement purchased for your device. For more information about SupportAssist, go to [www.dell.com/supportassist](http://www.dell.com/supportassist).

## Documentation resources

This section provides information about the documentation resources for your system.

To view the document that is listed in the documentation resources table:

- From the Dell EMC support site:
  1. Click the documentation link that is provided in the Location column in the table.
  2. Click the required product or product version.
  3. On the Product Support page, click **Manuals & documents**.
- Using search engines:
  - Type the name and version of the document in the search box.

**NOTE:** To locate the product name and model, see the front of your system.

**Table 80. Additional documentation resources for your system**

Task	Document	Location
Setting up your system	For more information about installing and securing the system into a rack, see the Rail Installation Guide included with your rail solution.  For information about setting up your system, see the <i>Getting Started Guide</i> document that is shipped with your system.	<a href="http://www.dell.com/poweredgemanuals">www.dell.com/poweredgemanuals</a>
Configuring your system	For information about the iDRAC features, configuring and logging in to iDRAC, and managing your system remotely, see the Integrated Dell Remote Access Controller User's Guide.  For information about understanding Remote Access Controller Admin (RACADM) subcommands and supported RACADM interfaces, see the RACADM CLI Guide for iDRAC.  For information about Redfish and its protocol, supported schema, and Redfish Eventing implemented in iDRAC, see the Redfish API Guide.  For information about iDRAC property database group and object descriptions, see the Attribute Registry Guide.  For information about Intel QuickAssist Technology, see the Integrated Dell Remote Access Controller User's Guide.	<a href="http://www.dell.com/poweredgemanuals">www.dell.com/poweredgemanuals</a>
	For information about earlier versions of the iDRAC documents.  To identify the version of iDRAC available on your system, on the iDRAC web interface, click <b>? &gt; About</b> .	<a href="http://www.dell.com/idracmanuals">www.dell.com/idracmanuals</a>
	For information about installing the operating system, see the operating system documentation.	<a href="http://www.dell.com/operatingsystemmanuals">www.dell.com/operatingsystemmanuals</a>
	For information about updating drivers and firmware, see the Methods to download firmware and drivers section in this document.	<a href="http://www.dell.com/support/drivers">www.dell.com/support/drivers</a>

<b>Task</b>	<b>Document</b>	<b>Location</b>
Managing your system	For information about systems management software offered by Dell, see the Dell OpenManage Systems Management Overview Guide.	<a href="http://www.dell.com/poweredgemanuals">www.dell.com/poweredgemanuals</a>
	For information about setting up, using, and troubleshooting OpenManage, see the Dell OpenManage Server Administrator User's Guide.	<a href="http://www.dell.com/openmanagemanuals">www.dell.com/openmanagemanuals</a> > OpenManage Server Administrator
	For information about installing, using, and troubleshooting Dell OpenManage Essentials, see the Dell OpenManage Essentials User's Guide.	<a href="http://www.dell.com/openmanagemanuals">www.dell.com/openmanagemanuals</a> > OpenManage Essentials
	For information about installing and using Dell SupportAssist, see the Dell EMC SupportAssist Enterprise User's Guide.	<a href="http://www.dell.com/serviceabilitytools">www.dell.com/serviceabilitytools</a>
	For information about partner programs enterprise systems management, see the OpenManage Connections Enterprise Systems Management documents.	<a href="http://www.dell.com/openmanagemanuals">www.dell.com/openmanagemanuals</a>
Working with the Dell PowerEdge RAID controllers	For information about understanding the features of the Dell PowerEdge RAID controllers (PERC), Software RAID controllers, or BOSS card and deploying the cards, see the Storage controller documentation.	<a href="http://www.dell.com/storagecontrollermanuals">www.dell.com/storagecontrollermanuals</a>
Understanding event and error messages	For information about the event and error messages generated by the system firmware and agents that monitor system components, see the Error Code Lookup.	<a href="http://www.dell.com/qrl">www.dell.com/qrl</a>
Troubleshooting your system	For information about identifying and troubleshooting the PowerEdge server issues, see the Server Troubleshooting Guide.	<a href="http://www.dell.com/poweredgemanuals">www.dell.com/poweredgemanuals</a>