



eTILE

WT15M-FW

**Commercial All In One PC
Technical Manual**



Disposal Instruction (US)

For better protection of our earth, please don't throw this electronic device into municipal trash bin when discarding. To minimize pollution and ensure utmost protection of the global environment, please recycle the product. For more information about the collection and recycling of Waste Electrical and Electronic Equipment (WEEE), you are invited to visit our homepage at www.aopen.com under "Green Products"

廃棄上の指示

より良い地球保護のために、電子機器を廃棄処分にする時は、ゴミ箱に捨てないで下さい。汚染を最小限に抑え、地球環境の最大限の保護のために、製品をリサイクルして下さい。廃電気電子機器（WEEE）の回収とリサイクルについての情報は、弊社ホームページwww.aopen.comの“Green Products”（環境に優しい製品）をご覧ください。

廢棄及回收處理

為了保護環境，請勿將本產品作為一般廢棄物處理。為減少環境污染，維護地球資源，本產品報廢時，請回收本產品。

Instruktion til bortskaffelse (Danish)

Af hensyn til vores miljø bedes De ikke bortskaffe denne elektroniske enhed i en almindelig affaldsspand. For at mindske forurening og sikre beskyttelse af miljøet bedes De genbruge produktet. For yderligere information vedrørende indsamling og genbrug af elektronik-affald (Waste Electrical and Electronic Equipment (WEEE)) er De velkommen til at besøge vores website www.aopen.com og læse nærmere under "Green Products".

Verwijderingsinstructie (Dutch)

Om mogelijke schade aan het milieu of de menselijke gezondheid door ongecontroleerde afvalverwijdering te voorkomen, moet u dit elektronisch product scheiden van andere soorten afval en op een verantwoorde manier recyclen. Verwijder dit product dan ook alstublieft niet samen met ander huishoudelijk afval. Voor meer informatie over de verzameling en recycling van elektrisch afval en elektronische apparatuur (WEEE), nodigen we u uit om onze homepage te bezoeken www.aopen.com onder "Green Products".

Instruction de Disposition (French)

Pour une meilleure protection de la terre, ne jetez pas ce dispositif électronique dans la poubelle municipale lors de la disposition. Pour éliminer la pollution et assurer la plus grande protection de l'environnement global, réutilisez s'il vous plaît le produit. Pour plus d'informations sur la gestion des déchets d'Equipements Electriques et Electroniques (DEEE ou WEEE), vous êtes invité à visiter notre site à www.aopen.com sous " Green Products".

Entsorgungsanleitung (German)

Zum besseren Schutze unseres Planeten, schmeissen Sie elektrische Geräte bitte nicht in öffentliche Mülleimer. Zur Verringerung der Verschmutzung und zur Sicherstellung grösstmöglichen Schutzes der Umwelt recyceln Sie bitte das Produkt. Für mehr Informationen zum Sammeln und Recyceln von elektrischen und elektronischen Müll (WEEE) besuchen Sie bitte unsere Homepage unter www.aopen.com unter dem Punkt "Green Products".

Istruzioni per lo smaltimento (Italian)

Per una migliore salvaguardia del nostro pianeta, si prega di non gettare questo dispositivo elettronico nei normali rifiuti al momento dell'eliminazione. Per ridurre al minimo l'inquinamento ed assicurare la massima protezione dell'ambiente, si prega di riciclare il prodotto. Per maggiori informazioni riguardanti la raccolta ed il riciclaggio delle apparecchiature elettriche ed elettroniche residue (WEEE), siete invitati a visitare la nostra homepage www.aopen.com alla voce "Green Products".

Instruksjoner for Resirkulering og Oppsamling (Norwegian)

For å beskytte vår planet, kast ikke dette elektroniske utstyret sammen med vanlig avfall. For å beskytte vår natur og miljø, vennligst resirkuler dette produktet. For mer informasjon om oppsamling og resirkulering i henhold til Waste Electrical and Electronic Equipment (WEEE), se vår hjemmeside på www.aopen.com under "Green Products".

Programa de Tratamento de Resíduos de Equipamentos Eléctricos e Electrónicos (Portugese)

Para melhor protecção ambiental do nosso planeta terra, não coloque o dispositivo electrónico no receptáculo de lixo municipal. Para minimizar a poluição e garantir protecção máxima do ambiente global, recicle o produto. Para mais informações sobre acerca da recolha e reciclagem de Equipamento Eléctrico e Electrónico (WEEE), convidamos-lhe a visitar nossa página na Internet em www.aopen.com sobre "Green Products".

Instrucciones para depositar los productos electrónicos (Spanish)

Para proteger mejor el medio ambiente, por favor, no deposite los productos electrónicos en los contenedores de basura tradicionales. Para reducir la contaminación y proteger el medio ambiente se recomienda que los recicle. Para más información acerca de dónde depositar y cómo reciclar Equipos Electrónicos y Desperdicios Electrónicos (WEEE), por favor, visite la página web www.aopen.com y entre en la sección Productos Ecológicos ("Green Products").

Kassering (Swedish)

För att bättre värna om vår jord bör denna elektroniska utrustning ej kasseras tillsammans med vanligt avfall. För att minimera mängden föroreningar och så långt som möjligt skydda den globala miljön bör produkten återvinnas.

För vidare information om insamling och återvinning av uttjänta elektriska och elektroniska produkter (Waste Electrical and Electronic Equipment, WEEE), besök avsnittet "Green Products" på vår hemsida, www.aopen.com.

Copyright

Copyright of this publication belongs to AOpen Inc. AOpen reserves the right to change the content of this publication without obligation to notify any party of such changes or revisions. No part of this publication may be reproduced, transcribed, transmitted, translated into any language, stored in a retrieval system in any form or by any means electronically, mechanically, optically without the prior written permission of this company.

Disclaimer

AOpen makes no warranties or representations, either expressed or implied, with respect to the content herein and specifically disclaims any warranties, merchantability of fitness for any particular purpose.

AOpen and AOpen logos used herein are registered trademarks of AOpen Inc. All other brand names and trademarks are owned by their respective owners.

**Copyright © 2011 by AOpen Inc.
All rights reserved.**

**AOpen Inc.
<http://www.aopen.com.tw>**

Safety Instructions

1. Please read these safety instructions carefully.
2. Please keep this User's Manual for later reference.
3. Please disconnect this equipment from connector before cleaning. Don't use liquid or sprayed detergent for cleaning. Use moisture sheet or cloth for cleaning.
4. Make sure the equipment is connected to the power source with the correct voltage, frequency, and ampere.
5. All cautions and warnings on the equipment should be noted.
6. Never pour any liquid into opening; this could cause fire or electrical shock.
7. Never open the equipment. For safety reason, the equipment should only be opened by qualified service personnel.
8. If one of the following situations arises, get the equipment checked by a service personnel :
 - a. Liquid has penetrated into the equipment.
 - b. The equipment has been exposed to moisture.
 - c. The equipment has not work well or you can not get it work according to user's manual.
 - d. The equipment has dropped and damaged.
 - e. If the equipment has obvious sign of breakage.
9. Ambient operation temperature: less than 35 degrees C.
10. Caution on use of battery: Use the battery recommended by the manufacturer or the same type of battery installed by the manufacturer. If incorrect battery is used, it may cause explosion or fire hazard. Recycle or discard used batteries according the manufacturer's instruction or your local authority.
11. Wall Mounting Holder need to use UL 1678 approved product.

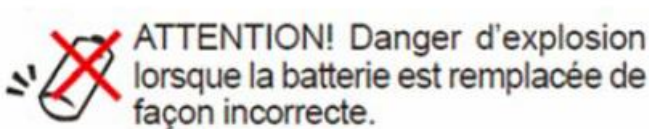

FCC notice

This device has been tested and found to comply with the limits for a Class B digital device pursuant to Part 15 of the FCC Rules. These limits are designed to provide reasonable protection against harmful interference in a residential installation. This device generates, uses, and can radiate radio frequency energy and, if not installed and used in accordance with the instructions, may cause harmful interference to radio communications.

However, there is no guarantee that interference will not occur in a particular installation. If this device does cause harmful interference to radio or television reception, which can be determined by turning the device off and on, the user is encouraged to try to correct the interference by one or more of the following measures:

- Reorient or relocate the receiving antenna.

- Increase the separation between the device and receiver.

- Connect the device into an outlet on a circuit different from that to which the receiver is connected.

- Consult the dealer or an experienced radio/television technician for help.

Notice: Shielded cables

All connections to other computing devices must be made using shielded cables to maintain compliance with FCC regulations.

Notice: Peripheral devices

Only peripherals (input/output devices, terminals, printers, etc.) certified to comply with Class B limits may be attached to this equipment. Operation with non-certified peripherals is likely to result in interference to radio and TV reception.

Caution

Changes or modifications not expressly approved by the manufacturer could void the user's authority, which is granted by the Federal Communications Commission, to operate this computer.

Operation conditions

This device complies with Part 15 of the FCC Rules. Operation is subject to the following two conditions: (1) this device may not cause harmful interference, and (2) this device must accept any interference received, including interference that may cause undesired operation.

Notice: Canadian users

This Class B digital apparatus complies with Canadian ICES-003

Table of Contents

1. Packing List.....	11
1-1. Standard Accessories	11
2. System View	12
2-1. Front View	12
2-2. Rear View.....	12
2-3. I/O ports.....	13
2-4. Dimension	13
3. System Assembly	14
3-1. SSD Replacement	14
3-2. RAM Replacement.....	16
3-3. Power Adapter Replacement	17
3-4. Wireless LAN Installation.....	17
4. Peripheral Installation.....	18
4-1. Wall Mount Kit Assembly.....	18
4-2. Other VESA-bracket support.....	19
5. Specification.....	20

6. RS232 Setting	22
Appendix A: Drivers Installation.....	24
Appendix B: Trouble Shooting	25

The logos of Adobe and Acrobat are the registered trademarks of Adobe Systems Incorporated.

The logos of AMD, Athlon, and Duron are the registered trademarks of Advanced Micro Devices, Inc.

The logos of Intel, Intel Celeron and Pentium II&III are the registered trademarks of Intel Corporation.

The logos of nVidia are the registered trademarks of nVidia Corporation.

The logos of Microsoft, Windows are the registered trademarks of Microsoft Corporation in America and other countries.

All the titles of the products and the trademarks mentioned in this manual are for the purpose of illustrative conveniences and are possessed by their respective firms.

We regret not informing about any changes in usage standards and other related information. AOpen Company reserves the right of altering or modifying the content of this manual. In case of any mistakes or incorrect descriptions, which include those on the products, AOpen makes no guarantee or commitments.

This document is based on the copyright laws in order to protect our company and reserve all rights.

Under no circumstances are any types of duplicating and loading this brochure in any databases and media permitted except the permission signed on formal document by AOpen Company.

1996-2008 Copyrights, AOpen Ltd. All rights reserved.

<http://www.aopen.com>

1. Packing List

1-1. Standard Accessories

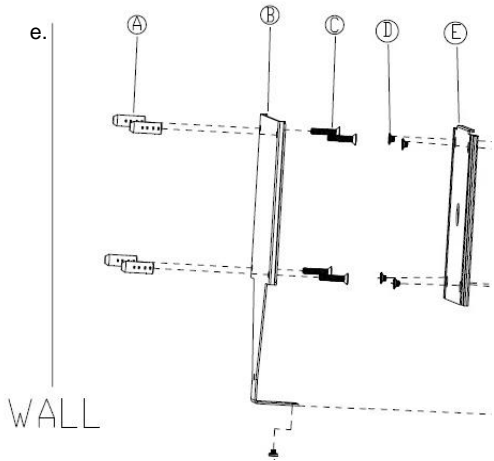
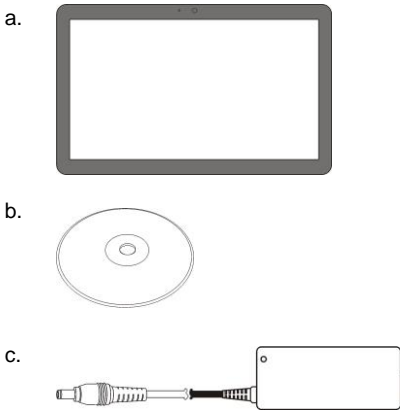

- a. System
- b. Utility and Driver
- c. Power adapter (90W)
- d. Power cord
- e. Ultra Slim Wall Mount (Option)

Notice:

The pictures may look slightly different from the product you purchased, due to our constant product improvement effort.

2. System View

2-1. Front View



2-2. Rear View



2-3. I/O ports

Caution: When you install devices or cables, please removed DC jack at first to prevent inadvertently switched to cause system boot/ damage to system/electric shock. The HDMI connector is output port, not input.

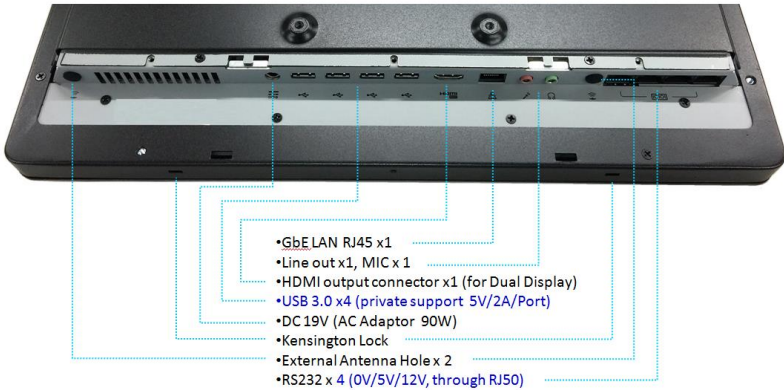

2-4. Dimension

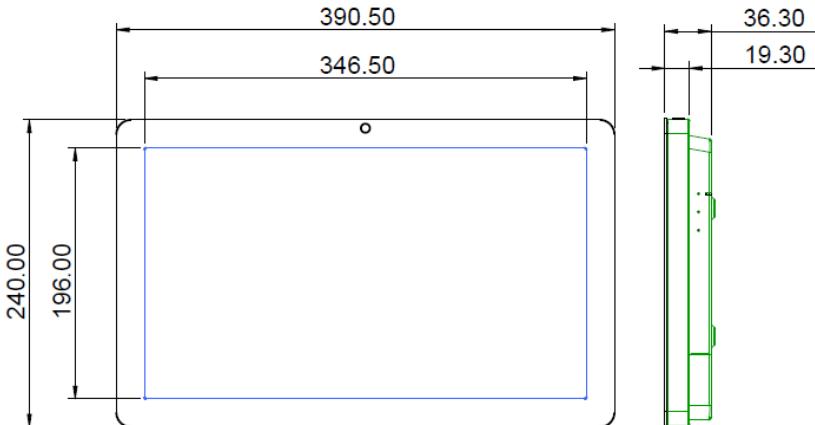

3. System Assembly

Please remove all screws of rear cover

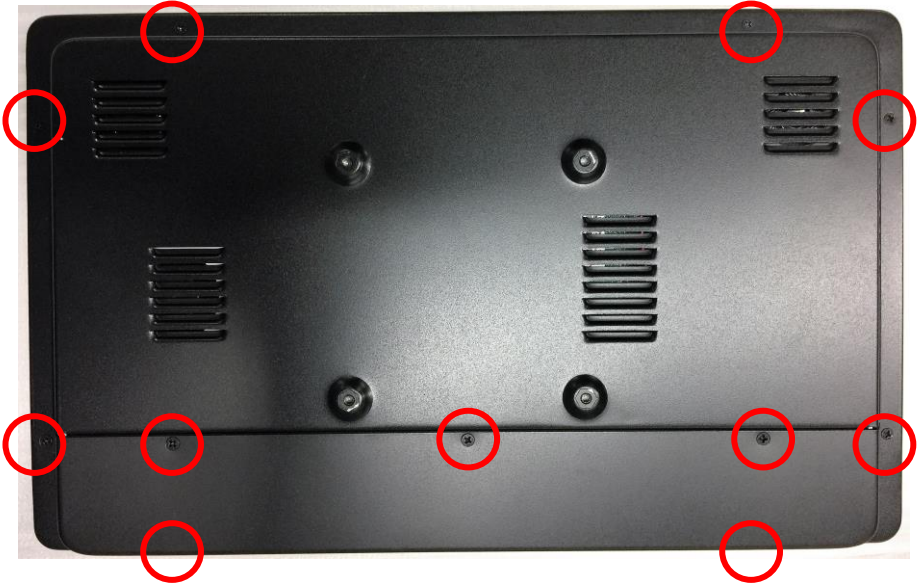

3-1. SSD Replacement

1. Rear view after taking off rear cover

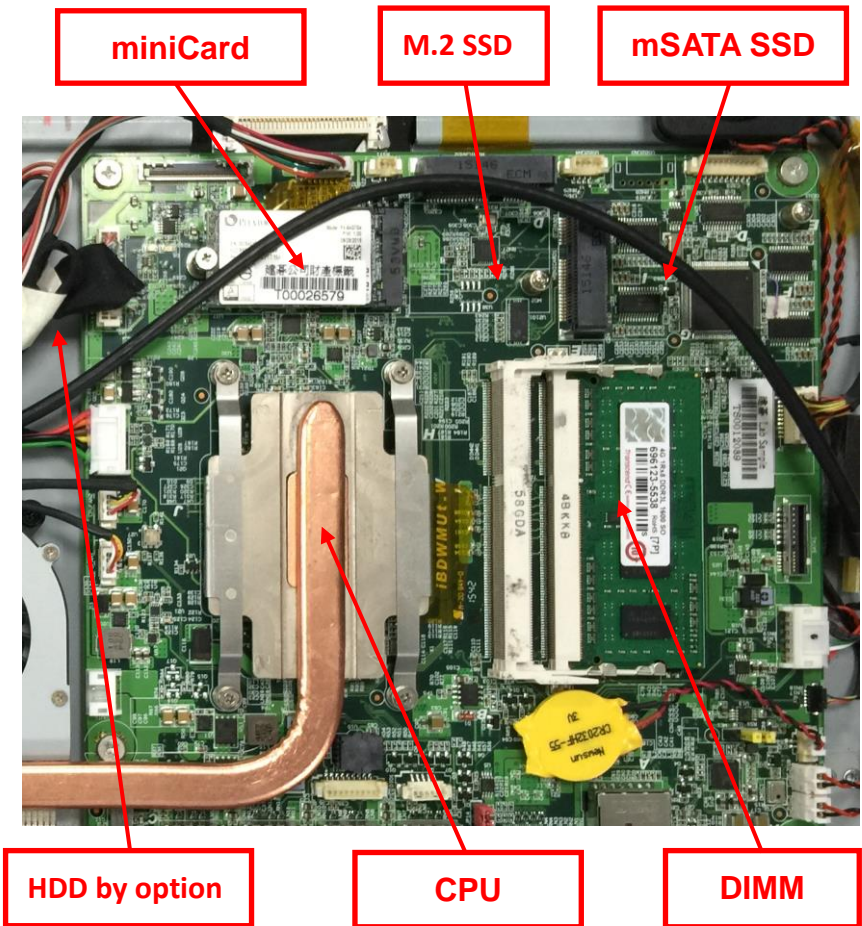

3-2. RAM Replacement

Opening the Rear Cover

Please open the rear cover first then remove and replace the RAM module.

You can refer to the motherboard layout to find the memory compartment.

Swapping a RAM Module

2. Use both fingers to pull the ejector clips out of the sides of the module.
3. Slide the memory module out of the memory slot.

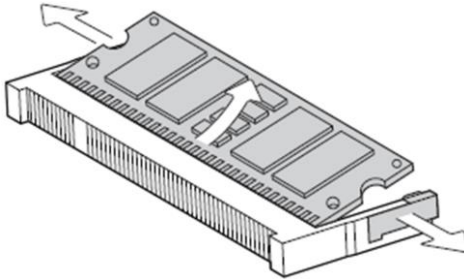

Installing a RAM Module

4. Slide the memory module into the memory slot and press down until the ejector clips click in place.

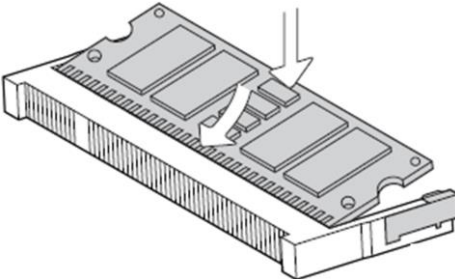

3-3. Power Adapter Replacement

1. Please turn off the system
2. Disconnect the power cable from the I/O panel (DC IN), then can swap the adapter

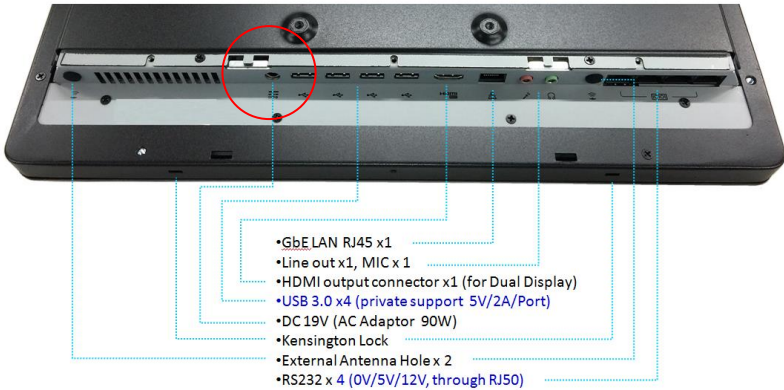

3-4. Wireless LAN Installation

To external antenna

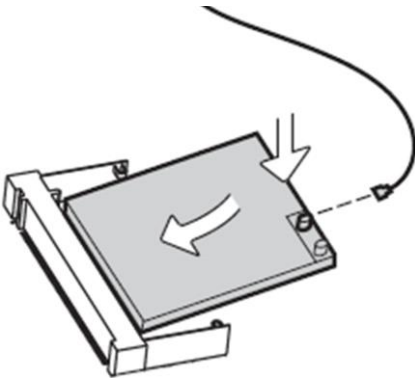

4. Peripheral Installation

4-1. Wall Mount Kit Assembly

1. Drilling the wall, and put into the plastic seat as A
2. Screw wall-mount bracket and plastic seat as C.
3. Screw VESA bracket on system by special VESA screws as D
4. Lift the system to align the VESA bracket into the wall-mount bracket, and make sure they are well assembled
5. Screw bottom screw to fix system on wall-mount bracket

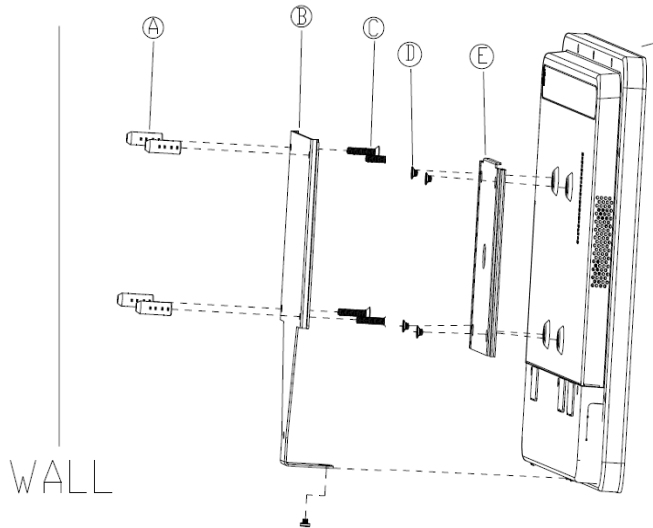

4-2. Other VESA-bracket support

The system support standard 100x100mm VESA mount, so other VESA mount bracket followed this standard spec can be assembled. Please use the system attached VESA screw - M4, otherwise will be broken system's VESA screw hole.

5. Specification

CPU

BGA type for Intel Core i7/i5/i3 28W Mobile Broadwell CPU

MEMORY

SO-DIMM DDR3L x 2 (max. support 16G)

Low voltage version, 1.35V

GRAPHICS

Integrated Intel® CPU (Intel HD 5500/6000, based on CPU)

LAN

Intel WGI218LM

Audio

Realtek ALC269-VC

Mini-Card slot (Option)

x2 (support mSATA x1)

Storage

mSATA SSD / M.2 SSD / SATA HDD

SYSTEM BIOS

AMI BIOS

Touch Panel

Win 7 Premium above support 10 Fingers (PCT Multi Touch)

Surface Pencil Hardness $\geq 7H$ per ASTM D 3363.

Durability Characteristics

Pen Hitting: more than 100,000,000 times.(Loading 180g)

AHVA Panel 15.6”(1920x1080 400cd/m²) LED Back Light

Another SPEC

Standard VESA Screw Hole (100x100mm), Screw L=3mm

Build-in 2W Stereo Speaker

Build-in internal Mono MIC

Watchdog Timer: (1sec ~255sec)

System Build-in Embedded Antenna

No support Monitor OSD function

Optional Wireless KIT

Side I/O – with cover

RS232 Port x4 (Through RJ50 type, Power 12V/5V/1A, Default Disable)

USB 3.0 x4 (private support 5V/2A/Port)

GbE LAN RJ45 *1

Line out x1

MIC in x1

DC 19V (AC Adaptor 90W)

HDMI output connector x1 (for Dual Display)

Dimension / Weight

390.5x240x36.5mm (WxHxD) 3.7Kg

6. RS232 Setting

7. Open back cover and find it.

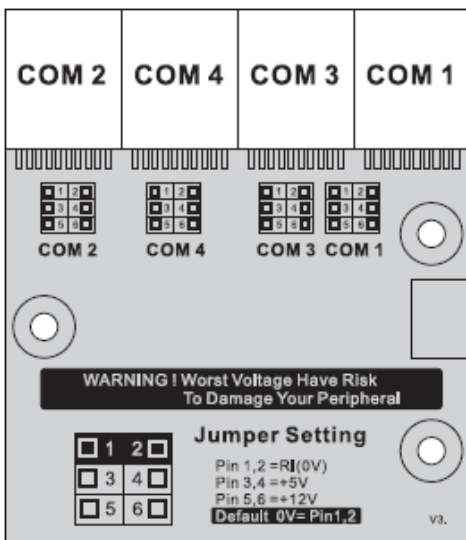
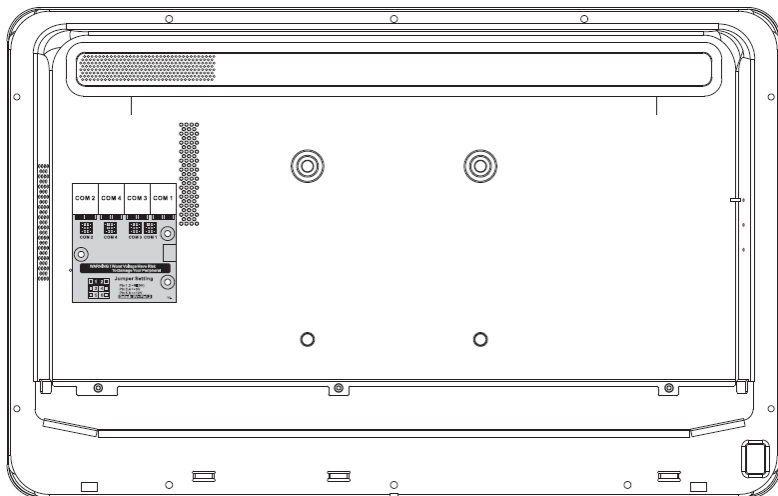

DB9 Pin	RS_232	RJ45 Pin
1	DCD#	2
2	RX#	4
3	TX#	6
4	DTR#	8
5	GND	9
6	DSR#	3
7	RTS#	5
8	CTS#	7
9	RI#	10
---	---	1

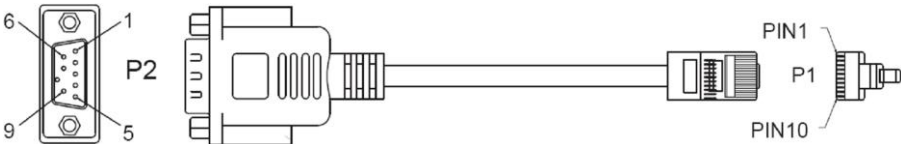

RS232 Pin Definition

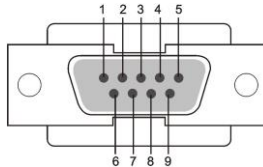

Pin	Signal	Pin	Signal
1	Data Carrier Detect	6	Data Set Ready
2	Received Data	7	Request to Send
3	Transmitted Data	8	Clear to Send
4	Data Terminal Ready	9	Ring Indicator
5	Signal Ground		

Appendix A: Drivers Installation

The shipping package includes a Driver CD in which you can find every individual driver and utility that enables you to install the drivers on the system.

Please insert the Driver CD into the drive and double click on the “index.htm” to select the models. You can refer to the drivers installation guide for each driver in the “Driver/Manual List”.



Appendix B: Trouble Shotting

No screen

1. Check system power line is connected
2. Please press power knob again to turn on system (please check the power led at right rear side is turned on)

Motherboard

Can't boot on

1. Check the power led at right rear side is turned on, but still no booting screen after 3 minutes.
2. Remove power line, after 1 min, connecting power line and power on system again. If still no booting after 10~30 sec, please contact with Service guys.

Only the blinking cursor at the upper left of the screen

If blinking cursor is kept after 3 minutes, it might be Motherboard issue. Please contact with Service guys.

Hardware Issue

Please clean out the visual dirty of appearance

DRAM issue

1. Connection is loose, please reinsert DRAM again
2. COMS setting is wrong, please reset as default value
3. DRAM performance is getting worse by time. Please swap a new one.

HDD issue

Please reboot from other booting device. If system is booting without any problem, it shows the hard drive may be crashed. Please swap a new one.

System crash issue

1. The additional peripheral may be over loading for adapter, and this will cause system to turn on or turn off sometime. Please check by removing additional peripheral.
2. If thermal air hole is blocked, it will cause the system can't drop out heated air flow, and then system will be crashed. Please keep clean area over 25.4mm(1 inch) around system air hole.