

Mobile Printer
SM-T300I SERIES

Hardware Manual



star 

Federal Communications Commission
Radio Frequency Interference Statement

This device complies with part 15 of the FCC Rules and Industry Canada licence-exempt RSS standard(s).

Operation is subject to the following two conditions:

- (1) This device may not cause harmful interference, and
- (2) this device must accept any interference received, including interference that may cause undesired operation.

Le présent appareil est conforme aux CNR d'Industrie Canada applicables aux appareils radio exempts de licence. L'exploitation est autorisée aux deux conditions suivantes :

- (1) l'appareil ne doit pas produire de brouillage, et
- (2) l'utilisateur de l'appareil doit accepter tout brouillage radioélectrique subi, même si le brouillage est susceptible d'en compromettre le fonctionnement.

FCC WARNING:

Changes or modifications not expressly approved by the party responsible for compliance could void the user's authority to operate the equipment.

For compliance with the Federal Noise Interference Standard, this equipment requires a shielded cable. For RF interference suppression, if a ferrite core is provided with this device, affix it to the interface cable.

NOTE:

This equipment has been tested and found to comply with the limits for a Class B digital device, pursuant to part 15 of the FCC Rules. These limits are designed to provide reasonable protection against harmful interference in a residential installation. This equipment generates, uses and can radiate radio frequency energy and, if not installed and used in accordance with the instructions, may cause harmful interference to radio communications. However, there is no guarantee that interference will not occur in a particular installation. If this equipment does cause harmful interference to radio or television reception, which can be determined by turning the equipment off and on, the user is encouraged to try to correct the interference by one or more of the following measures:

- Reorient or relocate the receiving antenna.
- Increase the separation between the equipment and receiver.
- Connect the equipment into an outlet on a circuit different from that to which the receiver is connected.
- Consult the dealer or an experienced radio/ TV technician for help.

CAN ICES-3 (B) / NMB-3 (B)

This equipment complies with FCC/IC radiation exposure limits set forth for an uncontrolled environment and meets the FCC radio frequency (RF) Exposure Guidelines in Supplement C to OET65 and RSS-102 of the IC radio frequency (RF) Exposure rules. This equipment has very low levels of RF energy that it deemed to comply without maximum permissive exposure evaluation(MPE). But it is desirable that it should be installed and operated keeping the radiator at least 20cm or more away from person's body (excluding extremities: hands, wrists, feet and ankles).

Cet équipement est conforme aux limites d'exposition aux rayonnements énoncées pour un environnement non contrôlé et respecte les règles radioélectriques (RF) de la FCC lignes directrices d'exposition dans le Supplément C à OET65 et d'exposition aux fréquences radioélectriques (RF) CNR-102 de l'IC. Cet équipement émet une énergie RF très faible qui est considérée conforme sans évaluation de l'exposition maximale autorisée. Cependant, cet équipement doit être installé et utilisé en gardant une distance de 20 cm ou plus entre le dispositif rayonnant et le corps (à l'exception des extrémités : mains, poignets, pieds et chevilles).

English:	Hereby, STAR MICRONICS CO.,LTD. declares that this Wireless Device is in compliance with the essential requirements and other relevant provisions of Directive 2014/53/EU.	Slovensky: [Slovak]	STAR MICRONICS CO.,LTD. týmto vyhlasuje, že Wireless Device spĺňa základné požiadavky a všetky príslušné ustanovenia Smernice 2014/53/EÚ.
Deutsch: [German]	Hiermit erklärt STAR MICRONICS CO.,LTD., dass sich das Gerät Wireless Device in Übereinstimmung mit den grundlegenden Anforderungen und den übrigen einschlägigen Bestimmungen der Richtlinie 2014/53/EU befindet.	Slovensko: [Slovenian]	STAR MICRONICS CO.,LTD. izjavlja, da je ta Wireless Device v skladu z bistvenimi zahtevami in ostalimi relevantnimi določili direktive 2014/53/EU.
Svenska: [Swedish]	Härmed intygar STAR MICRONICS CO.,LTD. att denna Wireless Device står i överensstämmelse med de väsentliga egenskapskrav och övriga relevanta bestämmelser som framgår av direktiv 2014/53/EU.	Česky: [Czech]	STAR MICRONICS CO.,LTD. tímto prohlašuje, že tento Wireless Device je ve shodě se základními požadavky a dalšími příslušnými ustanoveními směrnice 2014/53/EU.
Español: [Spanish]	Por medio de la presente STAR MICRONICS CO.,LTD. declara que el Wireless Device cumple con los requisitos esenciales y cualesquiera otras disposiciones aplicables o exigibles de la Directiva 2014/53/UE.	Magyar: [Hungarian]	Alulírott, STAR MICRONICS CO.,LTD. nyilatkozom, hogy a Wireless Device megfelel a vonatkozó alapvető követelményeknek és az 2014/53/EU irányelv egyéb előírásainak.
Português: [Portuguese]	STAR MICRONICS CO.,LTD. declara que este Wireless Device está conforme com os requisitos essenciais e outras disposições da Directiva 2014/53/UE.	Български: [Bulgarian]	това Безжично устройство е в съответствие със задължителните изисквания и другите приложими разпоредби на Директива 2014/53/ЕС.
Français: [French]	Par la présente STAR MICRONICS CO.,LTD. déclare que l'appareil Wireless Device est conforme aux exigences essentielles et aux autres dispositions pertinentes de la directive 2014/53/UE.	Polski: [Polish]	Niniejszym STAR MICRONICS CO.,LTD. oświadczam, że Wireless Device jest zgodny z zasadniczymi wymogami oraz pozostałymi stosownymi postanowieniami Dyrektywy 2014/53/UE.
Suomi: [Finnish]	STAR MICRONICS CO.,LTD. vakuuttaa täten että Wireless Device tyyppinen laite on direktiivin 2014/53/EU oleellisten vaatimusten ja sitä koskevien direktiivin muiden ehtojen mukainen.	Malti: [Maltese]	Hawnhekk, STAR MICRONICS CO.,LTD., jiddikjara li dan Wireless Device jikkonforma mal-ħtiġijiet essenzjali u ma provvedimenti oħrajn relevanti li hemm fid-Dirrettiva 2014/53/UE.
Italiano: [Italian]	Con la presente STAR MICRONICS CO.,LTD. dichiara che questo Wireless Device è conforme ai requisiti essenziali ed alle altre disposizioni pertinenti stabilite dalla direttiva 2014/53/UE.	Latviski: [Latvian]	Ar šo STAR MICRONICS CO.,LTD. deklarē, ka Wireless Device atbilst Direktīvas 2014/53/ES būtiskajām prasībām un citiem ar to saistītajiem noteikumiem.
Dansk: [Danish]	Undertegnede STAR MICRONICS CO.,LTD. erklærer herved, at følgende udstyr Wireless Device overholder de væsentlige krav og øvrige relevante krav i direktiv 2014/53/EU.	Lietuvių: [Lithuanian]	Šiuo STAR MICRONICS CO.,LTD. deklaruoją, kad šis Wireless Device atitinka esminius reikalavimus ir kitas 2014/53/ES Direktyvos nuostatas.
Nederlands: [Dutch]	Hierbij verklaart STAR MICRONICS CO.,LTD. dat het toestel Wireless Device in overeenstemming is met de essentiële eisen en de andere relevante bepalingen van richtlijn 2014/53/EU.	Norsk: [Norwegian]	STAR MICRONICS CO.,LTD. erklærer herved at utstyret Wireless Device er i samsvar med de grunnleggende krav og øvrige relevante krav i direktiv 2014/53/EC.
Eesti: [Estonian]	Käesolevaga kinnitab STAR MICRONICS CO.,LTD. seadme Wireless Device vastavust direktiivi 2014/53/EL põhinõuetele ja nimetatud direktiivist tulenevatele teistele asjakohastele sätetele.	Română: [Romanian]	Prin prezenta STAR MICRONICS CO., LTD. declară că acest dispozitiv este conform cu cerințele esențiale și alte prevederi relevante ale directivei 2014/53/UE.
Ελληνική: [Greek]	ΜΕ ΤΗΝ ΠΑΡΟΥΣΑ STAR MICRONICS CO.,LTD. ΔΗΛΩΝΕΙ ΟΤΙ Wireless Device ΣΥΜΜΟΡΦΩΝΕΤΑΙ ΠΡΟΣ ΤΙΣ ΟΥΣΙΩΔΕΙΣ ΑΠΑΙΤΗΣΕΙΣ ΚΑΙ ΤΙΣ ΛΟΙΠΕΣ ΣΧΕΤΙΚΕΣ ΔΙΑΤΑΞΕΙΣ ΤΗΣ ΟΔΗΓΙΑΣ 2014/53/ΕΕ.	Hrvatski: [Croatian]	Ovime Star Micronics CO., LTD. izjavljuje da je bežični uređaj u skladu s osnovnim zahtjevima i drugim važnim odredbama direktive 2014/53/EU.

Italy: The public use is subject to general authorisation by the respective service provider.

Norway: This subsection does not apply for the geographical area within a radius of 20 km from the centre of Ny-Alesund.



STAR MICRONICS CO.,LTD. Head Office
20-10 Nakayoshida, Suruga-ku, Shizuoka-shi, Shizuoka, 422-8654, Japan
Tel. + 81-54-263-1111 Fax. + 81-54-263-1057

STAR Quality Technical Center
18-12 Nakayoshida, Suruga-ku, Shizuoka-shi, Shizuoka, 422-8001, Japan
Tel. + 81-54-263-1303 Fax. + 81-54-263-6650

Declaration of Conformity

Application of Council Directive(s)

1999/5/EC of 9 Mar. 1999

2011/65/EU of 8 Jun 2011

Standard(s) to which Conformity is Declared

RADIO : **EN 300 328 V1.7.1**

EMC : **EN 301 489-1 V1.9.2**

EN 301 489-17 V2.1.1

EN 55022:2010

EN 55024:2010

SAFETY : **EN60950-1: 2006 / +A12: 2011**

EN 62479: 2010

ENVIRONMENT: **EN 50581: 2012**

Manufacturer's Name **Star Micronics Co.,Ltd.**

Manufacturer's Address **20-10 Nakayoshida, Suruga-ku, Shizuoka-shi,
Shizuoka 422-8654 Japan**

Importer's Name **Star Micronics Europe Ltd.**

Importer's Address **Star House, Peregrine Business Park, Gomm Road,
High Wycombe, Bucks. HP13 7DL, U.K.**

Type of Equipment **Thermal Printer**

Model Name **WSP-i350**

Ref. R&TTE Radio Report No. **ETLE121213.1451-01**

Ref. R&TTE EMC Report No. **ETLE121213.1448, ETLE121213.1449**

Ref. Safety Report No. **ETLS121213.0175, ETLE121213.1451-01**

Ref. Environ. Report No. **WSP-i350-RoHS-01**

I, the undersigned, hereby declare that the equipment specified above conforms to the above Directive(s) and Standard(s).

Place High Wycombe - U.K.  (Signature)

Date Apr. 01, 2013 David Pearce (Full Name)

Year of 1st CE mark '10 Technical Manager (Position)

Trademark acknowledgments

SM-T300I : Star Micronics Co., Ltd.

Notice

- All rights reserved. Reproduction of any part of this manual in any form whatsoever, without STAR's express permission is forbidden.
- The contents of this manual are subject to change without notice.
- All efforts have been made to ensure the accuracy of the contents of this manual at the time of going to press. However, should any errors be detected, STAR would greatly appreciate being informed of them.
- The above notwithstanding, STAR can assume no responsibility for any errors in this manual.
- iPad, iPhone, iPod touch and Retina are trademarks of Apple Inc., registered in the U.S. and other countries. iPad Air, iPad mini and Lightning are trademarks of Apple Inc. IOS is a trademark or registered trademark of Cisco in the U.S. and other countries and is used under license.
- Android is a trademark of Google Inc.
- Windows is registered trademarks of Microsoft Corporation.
- The Bluetooth® word mark and logos are registered trademarks owned by Bluetooth SIG, Inc.

Caution Symbol



This symbol is placed near the thermal head to indicate that it may be hot. Never touch the thermal head immediately after the printer has been used. Let the thermal head cool for a few minutes before touching it.



This symbol is placed near the thermal head to indicate that it is easily damaged. Observe the precautions for handling electrostatic sensitive devices.

Safety Precautions

Please be sure to read

To use this product in safety, please follow the precautions given below.

WARNING

- ✓ If you notice smoke, a strange smell, or a strange sound, turn off the power immediately, and remove the battery pack and battery charger. Then contact a Star Micronics dealer.
- ✓ If any foreign material (metal scraps, water, or other fluid) enters the printer, immediately turn off the printer and remove the battery charger and/or battery pack. Then, contact your dealer for advice. Continued use of the printer could result in a fire.
- ✓ Never attempt to repair the printer yourself. Also do not disassemble or modify the product.
Doing so could lead to injury, fire, or electric shock.
- ✓ Do not touch the tear bar.
 - There is a tear bar inside the paper outlet slot. Not only should you not put your hand in the paper outlet slot while printing is in progress, never put your hand into the outlet even when printing is not in progress.
 - The printer cover can be opened when replacing the paper. However, since the tear bar is on the inside of the printer cover, be careful not to place your face or hands too close to the tear bar.
- ✓ During and immediately after printing, the area around the thermal head is very hot.
Do not touch it, as you could be burned.
- ✓ If any battery fluid gets on your skin or clothing, immediately wash the affected area with fresh water. Otherwise, skin damage may result.
- ✓ The battery pack may be hot immediately after the product has been used.

■ Using the Printer

- ✓ Some semiconductors can be damaged by static electricity.
Be sure to turn off the printer when inserting or removing the battery pack.
- ✓ Do not drop the printer or hit it against a hard object.
- ✓ Do not open the printer cover while the printer is printing.
- ✓ Before you open the printer cover, make sure that printing data is not being sent to the printer.
- ✓ Do not unplug or plug in a communication cable while the printer is printing or during communication.
- ✓ Do not touch a communication connector while the printer is printing.
- ✓ Turn off the printer when you are not using it.
- ✓ When the printer is used in a low temperature environment or when a PIN pad or other device that needs electricity is connected to the printer, the battery's performance will be diminished, and the amount of time that you can use the printer for may be reduced.
- ✓ Do not pull out paper while the printer cover is closed.
- ✓ The heating element and the driver IC of the thermal head are easily damaged. Do not touch them with metal objects, sandpaper, etc.
- ✓ Printing quality may suffer if the thermal head heating element becomes soiled by being touched with your hands. Do not touch the thermal head heating element.
- ✓ There is a risk of damage to the driver IC of the thermal head from static electricity.
Never directly touch the IC.
- ✓ Do not operate the printer if there is moisture on the front surface of the head from condensation, etc.

■ Thermal Paper Handling

- ✓ Only use thermal paper with the designated specifications.
The printing quality and working life of the thermal head cannot be guaranteed if any paper other than that recommended is used. In particular, paper containing [Na⁺, K⁺, Cl⁻] may drastically reduce the working life of the thermal head. Please exercise caution.
- ✓ Store the thermal paper in a cool, dry, dark location.
- ✓ Do not rub the thermal paper with a hard object.
- ✓ Do not leave the thermal paper in contact with plastic film, an eraser, or adhesive tape for a long period of time.
- ✓ Do not stack the thermal paper on fresh diazo copies or wet-type copies.
- ✓ Do not use chemical glue on the thermal paper.
- ✓ Do not use thermal paper that has been stored for a long period of time.

■ Operating Environment for the Printer

Before actually unpacking the printer, you should take a few minutes to think about where you plan to use it. Remember the following points when doing this.

- ✓ Do not use the printer in an environment in which it will be subject to strong shaking while it is printing.
- ✓ Be careful to ensure that the printer is not exposed to direct sunlight.
The appropriate environment for using the printer is described below.
Temperature: -10°C to 50°C
Humidity: 30 % RH to 80 % RH (no condensation)
- ✓ Do not place the printer near a copying machine or other device that produces a strong electromagnetic field.
- ✓ Keep the printer sufficiently removed from heaters and other sources of heat.
- ✓ Use the printer in a clean, low-humidity environment that is free from dust.
- ✓ Avoid using the printer in high-humidity rooms.
- ✓ We recommend that you unplug the printer from the power outlet whenever you do not plan to use it for long periods. Because of this, you should locate the printer so that the power outlet it is plugged into is nearby and easy to access.

■ Printer Maintenance

Please perform the following maintenance every 6 months.

- ✓ Thermal head
Dip a cotton swab in an alcohol solvent (ethanol, methanol, or isopropyl alcohol), and clean the heating area of the head.
- ✓ Platen
While turning the platen, use a soft, dry cloth to lightly rub the entire surface of the platen and remove any foreign objects.
- ✓ Paper storage unit and the surrounding area
Remove any dirt, dust, pieces of paper, etc., from the paper storage unit.
- ✓ Card reader
Regularly blow air onto the card reader to remove any dust from the card slot.

■ Using a Magnetic Card

- ✓ Do not bring magnets near the card, and do not store the card near a device that produces a magnetic field (such as a mobile phone, speaker, or TV).
If you do so, the data on the card may be deleted.
- ✓ Do not leave the card in a high-temperature environment (such as the dashboard of a car).
If you do so, the card may bend.
- ✓ Do not touch the card with dirty or wet hands. Also, do not attach adhesive tape or glue to the card.
Failing to follow the above precautions could cause the card to stop working properly.

Table of Contents

1. Product Overview	1
1.1 Printer & Accessories	2
1.2 External Appearance and Part Names	3
2. Setup	4
2.1 Battery Pack	4
2.1.1 Inserting into the Printer or the Battery Holder	4
2.1.2 Charging the Battery	5
2.2 Bluetooth	8
2.2.1 Pairing	8
2.2.2 Auto Connection Function (only for iOS*)	9
2.3 Loading Paper	10
2.4 Belt Clip	12
2.4.1 Attaching to the Printer	12
2.4.2 Using the Belt Clip	12
3. Printer Features	13
3.1 Control Panel	13
3.1.1 Button	13
3.1.2 Panel Lamp	13
3.1.3 LCD	13
3.2 Self Test	14
3.2.1 Self Test Procedure	14
3.2.2 Printing the Bluetooth Device Name and MAC Address	14
3.3 Memory Switch Setting (By the buttons on the printer.)	15
3.4 HEX Dump Mode	22
3.5 Instruction for Auto Power Down(Sleep) Mode	23
3.6 Card Reading (Only for Model with Card Reader)	24
4. Paper	25
4.1 Paper Specifications	25
4.2 Recommended Paper (Common thermal roll paper)	25
4.3 Printing Range	25
5. General Specifications	26
6. Version History	28

This manual supports the following firmware version.

Firmware Version:	Ver 4.0 or later
-------------------	------------------

Refer to the appropriate hardware manual which supports the firmware version of your printer.

The firmware version can be confirmed by the self-test. (refer to [3.2 Self Test] of page 14)

1. Product Overview

This printer is perfect for mobile banking systems, retail, POS (point of sale) terminals and other forms of mobile computing.

► The characteristics of this printer are listed below:

- Pocket size (120 ×130.5 × 58.3 mm) <Model without Card Reader>
- Extremely light and mobile (442 g)
- Up to 13 hours of battery-powered operation (12 receipts per hour / Auto Power Down Mode)
- International Splash/Dust Proof "IP54" Certified
- 1.5m Drop Resistance (Tough Rubber Type Case Design)
*Our test procedure, Not guarantee
- Support High Quality Print Mode (Double-Stroke Mode)
- Very silent printing thru direct thermal printing method
- High speed (75 mm/sec, max.)
- Standard-equipped dual interface (RS-232C serial interface and Bluetooth Ver. 2.1 + EDR interface)
- Support for secure Bluetooth communications
Support for Bluetooth Security Mode 3 (PINs of up to 16 digits in length)
Non-discoverable mode can be offered (Factory option)
- Support Magnetic Stripe Reader <Model with Card Reader>
- Support Graphic LCD(128×32 dots) with Blue LED Backlight
- Belt Clip as a standard accessory
- Support text and graphic printing
- Bit-Image(Logo) Store Function "Use Logo Store Tool to store a logo."
- Drop-in design that makes it easy to load paper
- A printer cover that can be opened with the touch of a button
- Printer cover open sensor & Paper-out sensor
- Flow control : Software (XON/XOFF)
※ Hardware flow control not supported in printer
- **Apple Certified to print directly from iOS devices over Bluetooth**
- **Easy set-up to switch from printing directly from iOS to Android devices (Operating systems except Mac OS switch automatically)**

1.1 Printer & Accessories

The printer is packaged with the following accessories.

If any of these accessories is broken or missing, please contact the dealer that you bought the product.

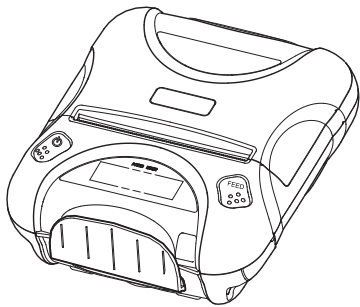

Printer

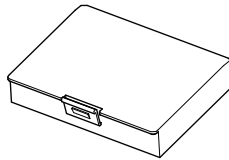

Battery Pack

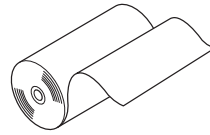

Printer paper sample



Belt Clip

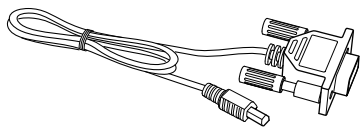

Serial Communication Cable

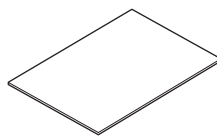

Safety Instruction Sheet

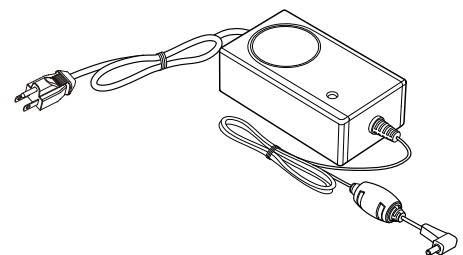

Battery Charger

► The optional items for this printer are listed below.

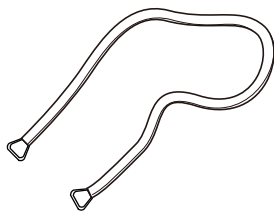

Shoulder Strap

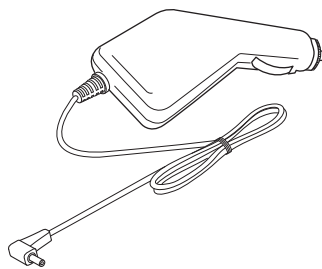

Car Charger

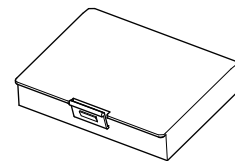

Extra Battery Pack

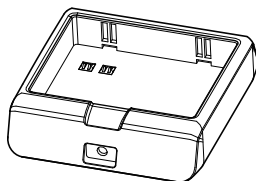

Battery Holder

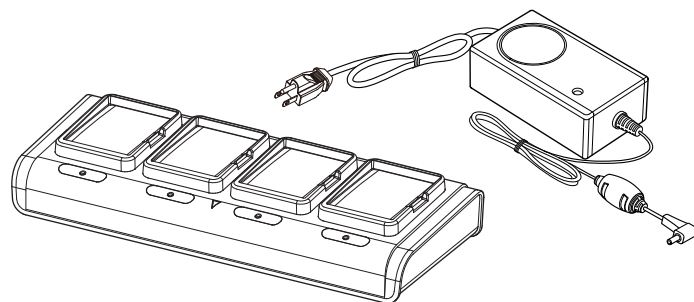

4 Unit Battery Charger (Special Battery Charger + 4 Unit Holder)

1.2 External Appearance and Part Names

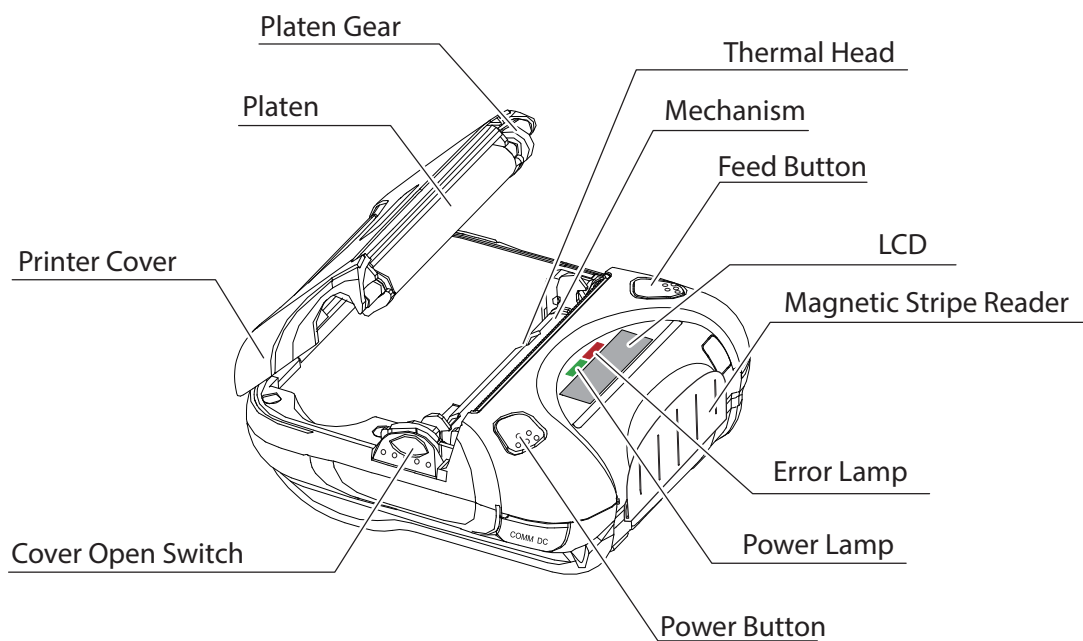

※ Remove the films if you do not need them.

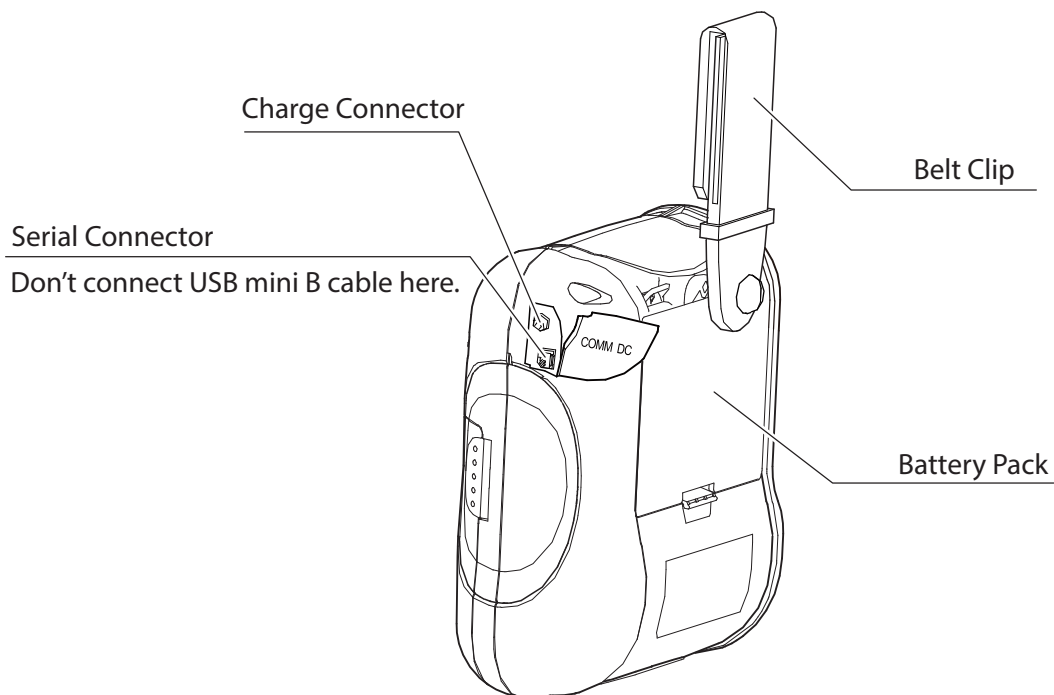

2. Setup

2.1 Battery Pack

2.1.1 Inserting into the Printer or the Battery Holder

1. Make sure that the printer has been turned off before you insert or remove the battery pack.
2. Insert the battery pack into the back of the printer as in the figure shown below, following the direction of the arrow.

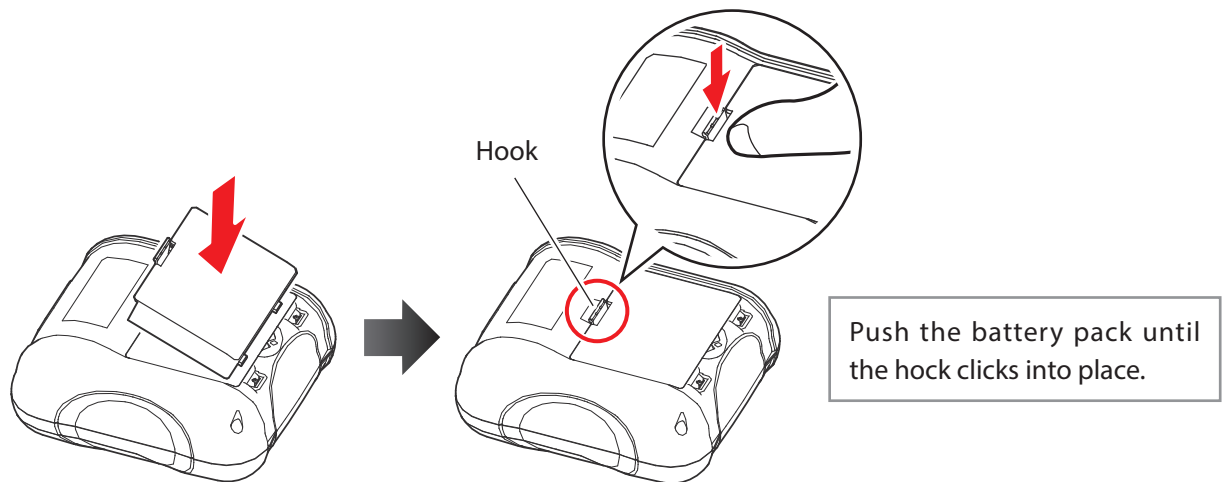

3. To remove the battery back, pull back the hook, and use the opposite procedure from the one you used to insert the battery pack.
4. The battery pack install into External Battery Cradle.
Insert the battery pack in the direction of the arrow.

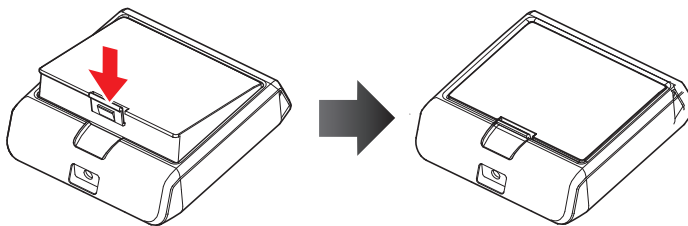

2.1.2 Charging the Battery

Insert the battery pack into the printer to charge it.

Insert the battery charger cable into the printer's power inlet for charging.

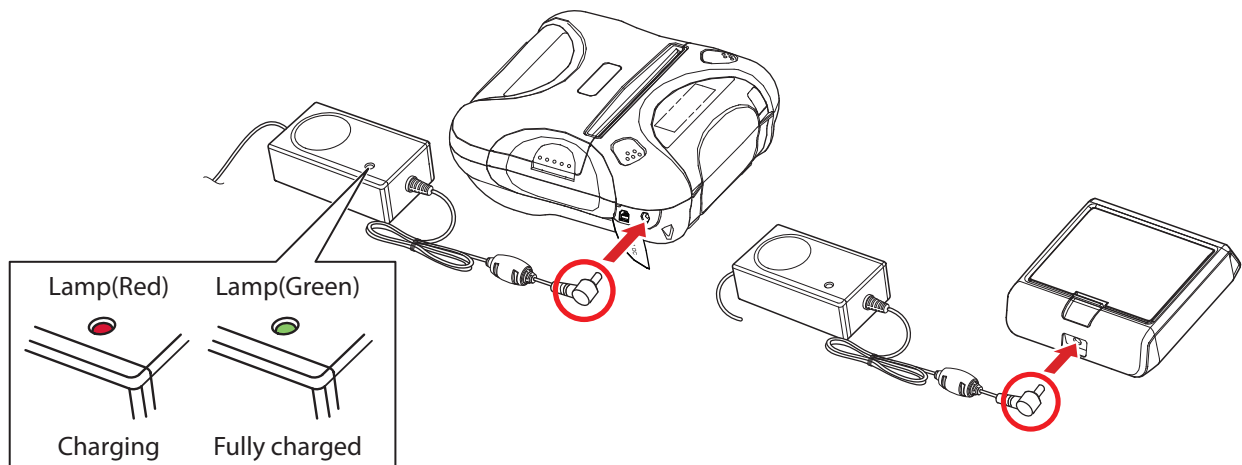

Note: When the battery charger is connected to the printer without the battery pack, the printer turns on but cannot print.

⚠ Notes about the Battery Pack

► General Battery Characteristics

- The battery is a consumable and its performance over time will gradually decrease.
- While not in use, the battery will slowly discharge itself.
Prepare a battery pack that has been charged relatively recently (1 to 2 days earlier).
- To ensure that the battery lasts for a long time, we recommend that you turn off the printer whenever possible.
- When used at low temperatures, battery performance will temporarily decline. Be sure to have a fully-charged spare battery standing by if the printer will operate in a cold environment.

► Charging the Battery Pack

- The battery pack can be charged at ambient temperatures between 0 and 40°C.
- The time required to charge the battery pack varies depending on the voltage and the ambient temperature.
Normally, it takes 4 to 5 hours to charge the battery pack.
- It will take longer to charge the battery pack if you print while charging the battery pack.
- Do not remove the battery pack while it is being charged.
- Fully charge the battery prior to using the printer. Otherwise, the performance of the battery may be affected.
- There is no need to completely discharge or use up a rechargeable lithium ion battery before re-charging it.
- It is normal for the battery pack to be hot after it has finished charging or been used.
- Do not recharge a battery pack that has just been fully charged.

► Battery Pack Life

- The battery can be charged approximately 500 times in the normal temperature range without losing performance. If an extreme decline in the running time of the battery is noticed, the battery is reaching the end of its usable life. It is recommended to replace the old battery with a new one.

► Notes about Using the Battery Pack

- Only use a designated battery pack.
- Only use the designated battery charging method.
You cannot use a battery charger other than the designated battery charger.
- Do not throw the battery into a fire, place it near a flame or heating device, or leave it in a hot environment (under direct sunlight, in a car, etc.).
- Do not use a battery pack that has been dropped or subjected to a shock in some other way.
- Do not disassemble or modify the battery pack.
- Do not short the terminals of the battery pack or get it wet.
Do not place the battery pack in a bag with a small metal object (such as a key).
- If any battery fluid gets on your skin or clothing, immediately wash the affected area with fresh water. Otherwise, skin damage may result.

► Notes about Storing the Battery Pack

- The characteristics of the battery pack may degrade if you store it in a charged state for a long period of time. If you do not intend to use the battery pack for a while, charge it to approximately 50 %, and then remove it from the printer.
- If you do not intend to use the battery pack for a long time, be sure to remove it from the printer, and do not leave it connected to a battery pack holder for external charging.
- Keep the battery out of the reach of children. In addition, be careful that children do not remove the battery.
- Store the battery pack in a cool place.
 - * We recommend that you store the battery pack in a dry area with an ambient temperature of 15 to 25 °C.
 - * Avoid storing the battery in locations with high or extremely low temperatures.

⚠ Make sure to follow the instructions below to prevent the battery from permanent damage.

- If you do not intend to use the battery pack for a long period of time, charge it to approximately 50 %, and then remove it from the printer.
- During storage, charge the battery pack to approximately 50 % every 3 months.
- When the remaining battery level is low, charge the battery as soon as possible.
- If the printer turns off due to insufficient battery remaining, make sure to recharge the battery within 15 days.

► **Battery Disposal and Recycling**

A lithium-ion battery is used to power this device. Since the disposal process of batteries varies from country to country, refer to the appropriate measures mandating the disposal method of the country in which this device is used.

< For U.S.A. and Canada >

	<p>Lithium-Ion batteries are recyclable. You can help preserve our environment by re-turning your used rechargeable batteries to the collection and recycling location nearest you. For more information regarding recycling of rechargeable batteries, call toll free 1-800-822-8837, or visit http://www.rbrc.org/</p>
---	---

2.2 Bluetooth

2.2.1 Pairing

1. Press and hold POWER button for approx. 5 seconds, and printer is turned on. Then, it is ready to pair with another Bluetooth device.

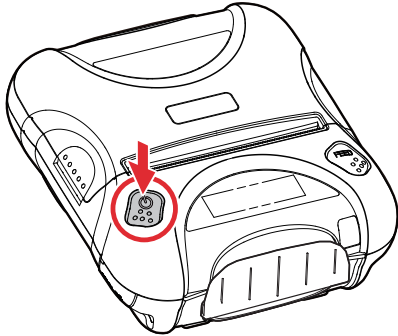

2. On the host device, tap [Settings]. Set [Bluetooth] to ON. Select "Star Micronics".

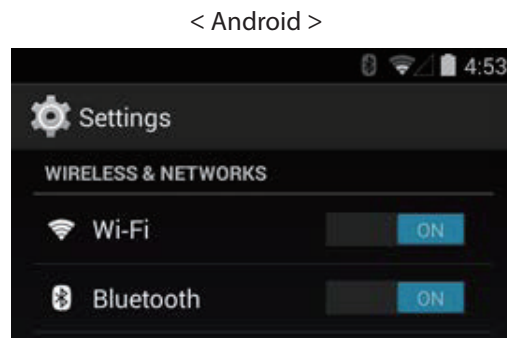
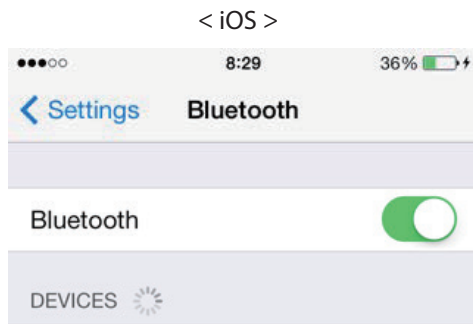

3. If necessary, enter the following information into the terminal that you are using.

PIN: 1234 (default)
Device name: Star Micronics (default)

CAUTION

- 1) *For security purposes, we recommend that you change the PIN.
The following utility is required to change the PIN.
Tool name: **Star_Bluetooth_Utility.exe** (for Windows)
Star Setting Utility (for iOS, Android)
To obtain this utility, please contact with our dealer
For instructions on how to use this utility, please refer to the *Bluetooth Setting Utility Software Manual*.*
- 2) *If the quantity of data which is printed at once is more than 1M byte on Bluetooth communication, it would cause the buffer to overflow and the data to get damaged.*
- 3) *For instructions on how to connect with a host device, please refer to your host device user manual.*



You can test the connectivity with a host device by using StarIO SDK Application which is available on Apple Store and Google play.

2.2.2 Auto Connection Function (only for iOS*)

When the Bluetooth connection with your iOS device(*1 is disconnected, it is required to establish a connection by tapping the printer you want to use on the Bluetooth setting screen. This Re Connection Specification is exactly based on the iOS specifications, and this specification is different from other OS such as Android.

The auto connection eliminates this configuration process and automatically sends a request for connection to the iOS terminal (Host) that the printer previously connected.

See the table below for details of Auto Connection setting.

	Auto Connection OFF	Auto Connection ON (Default)
How to re-connect	Turn the printer on and tap the printer name on the Bluetooth setting screen of the iOS device.	After powered on, the printer automatically connects to the Host that it previously connected.
How to change the Host	Turn the printer on and tap the printer name on the Bluetooth setting screen of the iOS device you want to use.	Turn the "Bluetooth" function off on the Bluetooth setting screen of the host that the printer is currently connected, and then tap the printer name on the Bluetooth setting screen of the iOS device you want to use.
Use case	A printer is shared with the multiple host devices.	A printer is always used with one host device only.

The ON/OFF switching of the auto connection can be performed by operating the printer panel or using the Star Bluetooth utility in "StarPRNT Intelligence".

For more details on the switching method, refer to "3-3. Memory Switch Setting".

(*): This function is only valid with iOS devices or when the printer is set to [Bluetooth(Auto)]. This function will be invalid regardless of the settings when the printer is set to [Bluetooth(Mac)], or if you are using a non-iOS device.

(*1: For example, iPhone, iPad and iPod

2.3 Loading Paper

Refer to chapter 4, "Paper" (p. 23), to select roll paper that conforms to the specifications.

1. Turn on the printer.
2. Put your finger on the switch for opening the cover, and then open and raise the printer cover.

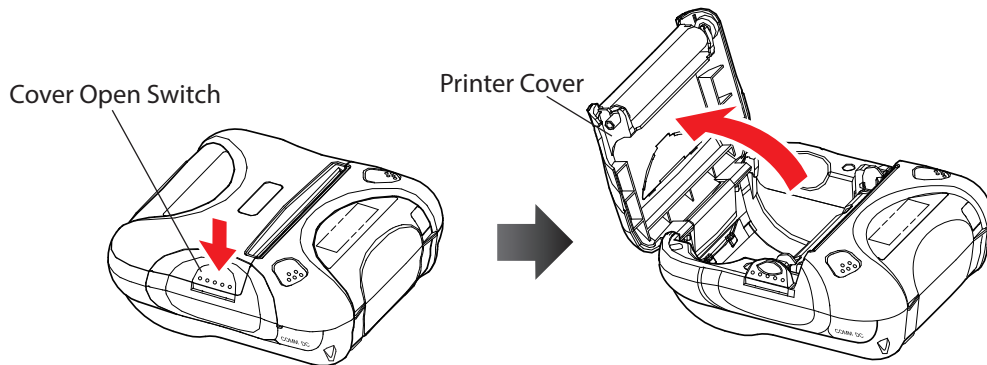

3. Load the roll paper in the orientation shown in the figure below, and then pull the end of the roll straight toward you.

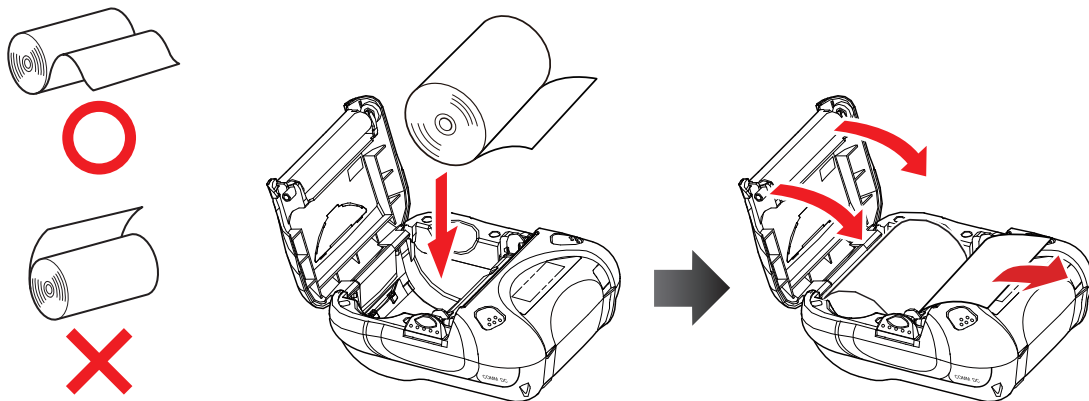

4. Press down on both sides of the printer cover to close it firmly.
When you close the printer cover, make sure that it is closed on both sides.
5. Use the tear bar to cut the extra paper.

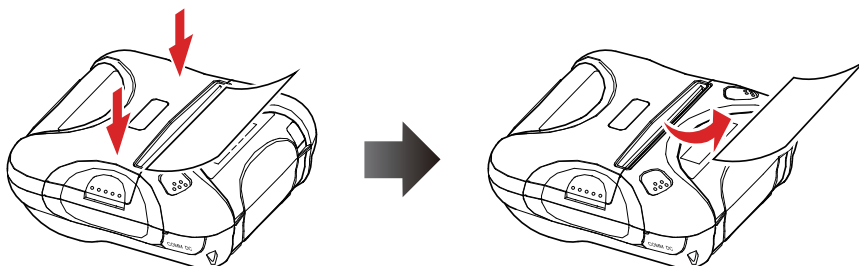

⚠ CAUTION

When the paper is jammed, be sure to open the printer cover before removing the jammed paper.

Do not under any circumstances try to pull out the jammed paper forcefully while the printer cover is closed. Doing so may damage parts of the printer.

Caution Symbol



This symbol is placed near the thermal head to indicate that it may be hot.

Never touch the thermal head immediately after the printer has been used. Also, even when the thermal head is not hot, do not touch it, because static electricity can damage the devices inside the thermal head.

WARNING

1) Do not touch the tear bar.

- There is a tear bar inside the paper outlet slot. Not only should you not put your hand in the paper outlet slot while printing is in progress, never put your hand into the outlet even when printing is not in progress.*
- The paper cover can be opened when replacing the paper. However, since the tear bar is on the inside of the paper cover, be careful not to place your face or hands too close to the tear bar.*

2) During and immediately after printing, the area around the thermal head is very hot. Do not touch it, as you could be burned.

2.4 Belt Clip

2.4.1 Attaching to the Printer

Follow the procedure below to attach the belt clip to the printer.

1. Make sure that you are attaching the belt clip in the right orientation, then screw the screw that comes with the belt clip into the designated screw hole to attach the belt clip to the printer.
2. Use a coin to firmly screw in the screw.

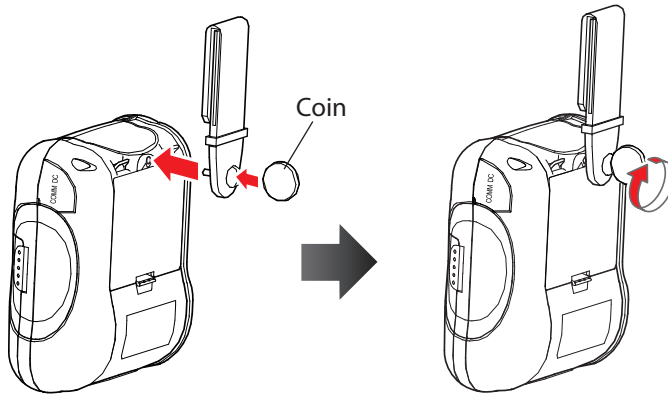

2.4.2 Using the Belt Clip

When the printer is attached to your belt, you can use it like the picture below.

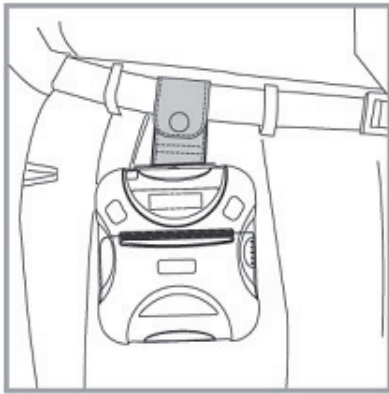

Hold the printer firmly with your hand when you swipe a magnetic stripe card or cut paper. If it is not held firmly, you may fail to read card data or cannot cut paper smoothly with the tear bar.

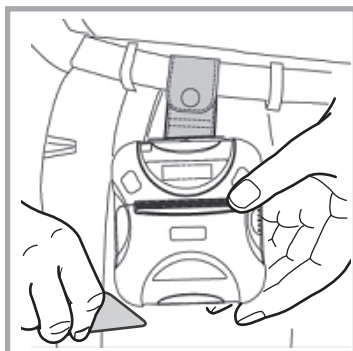

3. Printer Features

3.1 Control Panel

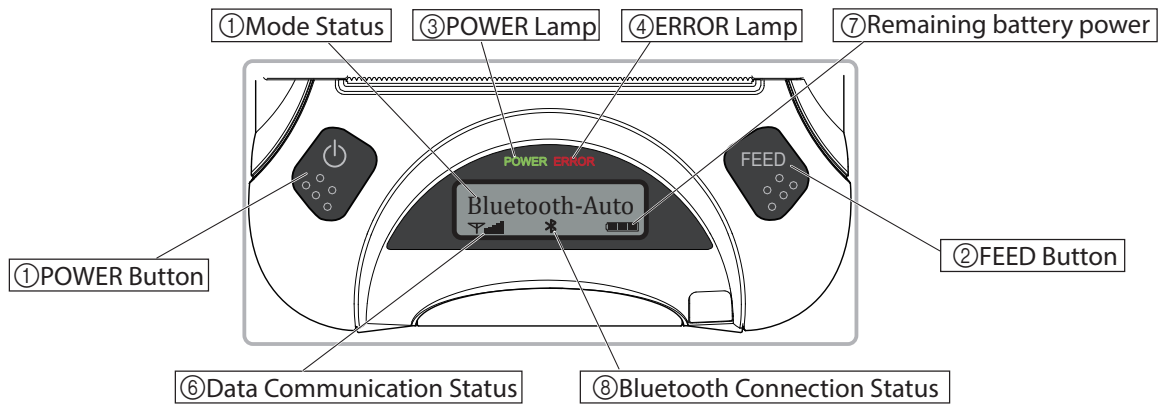

3.1.1 Button

- ① POWER Button :
Pressing and holding the POWER button for 5 seconds or more will turn the power on or off.
- ② FEED Button :
When the printer is on, pressing and holding the FEED button for 1 second or more feeds a paper.
- ◆ Pressing the ①POWER button and ②FEED button simultaneously enables you to change the printer mode setting. The buttons are also used to change the mode and change over the setting contents.(For more details on the mode setting, refer to "3.3. Memory Switch Setting".)

3.1.2 Panel Lamp

- ③ POWER (Green) : Printer is ON and ready to receive data.
When the memory switch is set, it indicates the printer mode to be set by flashing by a predetermined number of cycles.
- ④ ERROR (Red) : Indicates an error has occurred.
When the memory switch is set, it indicates the current setting contents by flashing by a predetermined number of cycles.

3.1.3 LCD

- 1) The 128 × 32 dot display shows alphanumeric characters.
- 2) Content
 - ⑤ Mode/Status : Indicates the currently specified printer mode or error status.
 - ⑥ Data communication status : ... The image shown on the left indicates that the data communication status is good.
 - ⑦ Remaining battery power : ... There is sufficient remaining battery power.
 ... The remaining battery power is low. Please charge the battery pack. (*)
 ... The remaining battery power is extremely low. Stop using the printer immediately, and charge the battery pack. (*)
Note*)If you continue printing at the low remaining battery power status, the printer cannot feed paper properly and may print with condensed (narrow) line spacing.
 - ⑧ Bluetooth connection status : ... iOS → Always turns on during Bluetooth pairing.
 Android / Windows → Only turns on when communication occurs during Bluetooth pairing.

3.2 Self Test

You can use a self test to check the printer's settings.

Before you start the self test, make sure that roll paper has been properly loaded into the printer.

3.2.1 Self Test Procedure

1. Turn the printer power by holding down the FEED button and the POWER button simultaneously for 5 seconds or more.
2. The printer will print the current printer status, including the firmware version, communication mode, and print settings.
3. The self test will finish automatically. The printer will be ready to receive data after the self test finishes.

Note: If the firmware version is 3.0 or lower, the "EMULATION" setting will not be printed by this self test procedure. Please use the instructions in section 3.2.2 to perform a self test.

3.2.2 Printing the Bluetooth Device Name and MAC Address

1. Follow the procedure in section 3.2.1 to start a self test.
2. Before the self test finishes, press and hold FEED button and MODE button at the same time.
3. The printer will print the Bluetooth device name and MAC address (the contents up to the memory switch setting information in case of the StarLine mode), and the self test will finish automatically. The printer will be ready to receive data after the self test finishes.

Emulation : ESC/POS
Communication Port : Bluetooth(Auto)

```
*** SM-T3011(RX) ***
PRINTER STATUS
[Ver : ]

PORT = Bluetooth(Auto)
SERIAL = 57600 BPS
8 DATA BIT
NO PARITY
1 STOP BIT

EMULATION = ESC/POS
DENSITY = MEDIUM
QUALITY = LOW
MARK = NO USE
SENSOR = LOW(204)
PMDN = NO USE
AUTO CONNECTION = ON
```



Get Users manual



BD Name:
BD Addr:



Self test information

Bluetooth device name and MAC address

Memory switch setting information

Emulation : StarPRNT
Communication Port : Bluetooth(Auto)

```
*** SM-T3011(RX) ***
PRINTER STATUS
[Ver : ]

PORT = Bluetooth(Auto)
SERIAL = 57600 BPS
8 DATA BIT
NO PARITY
1 STOP BIT

EMULATION = StarPRNT
DENSITY = MEDIUM
QUALITY = LOW
MARK = NO USE
SENSOR = LOW(204)
PMDN = NO USE
AUTO CONNECTION = ON
```



Get Users manual



www.startronics.com/support

BD Name:
BD Addr:
IUS Port Name:





```
-- Memory switch --
FEDCB9876543210 HEX.
<0> 000000000000 8010
<1> 000000000000 0000
<2> 000000000000 0000
<3> 000000000000 0000
<7> 000000000000 0000
<B> 000000000000 0000

-- Memory switch Detail --
<0>F = Emulation: StarPRNT
<0>5 = Shift-JIS: Valid
<0>4 = Character Mode: Japan
<1>4 = Zero Style: Normal Zero
<2>D = Adjust Ladder Bar: Yes
<2>5,4= Print Speed: Normal
<2>2-0= Print Density: Standard
```

Differs depending on the version.
3.0 or older : Star Line
3.1 or later : StarPRNT

3.3 Memory Switch Setting (By the buttons on the printer.)

For details on the printer settings, refer to [Setting Table] of Page 18.

The setting change by memory switch is enable before shipment.

The setting change by memory switch is the following steps.

1. Turn on the printer power by pressing and holding down the FEED button and the POWER button simultaneously for 5 seconds or more. The printer will perform self printing.

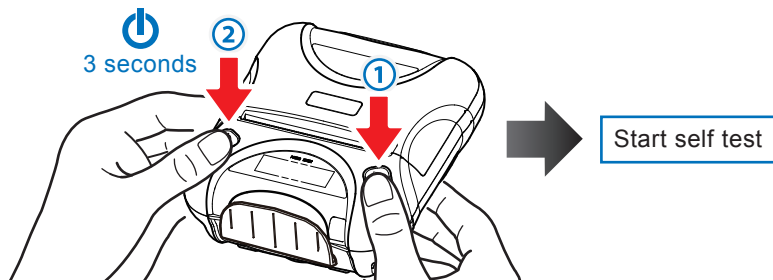

2. The printer prints out the contents up to the QR code in case of the ESC/POS mode or the contents up to the memory switch setting information in case of the StarLine mode. Then, release the POWER button and the FEED button, and press the POWER and FEED buttons simultaneously within 2 seconds. Hold down both buttons for 2 seconds or more and release the buttons.

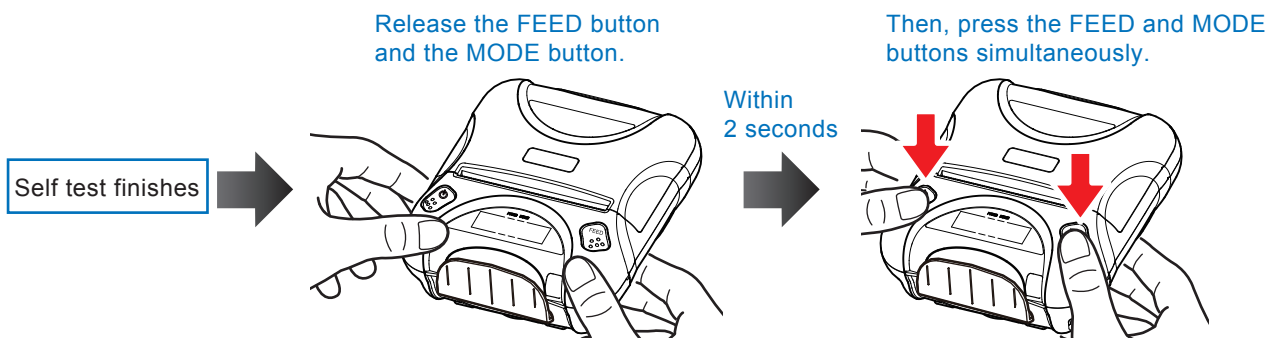

3. If the printer prints out "Memory SW setting = Disabled", the setting change by memory switch is enabled.

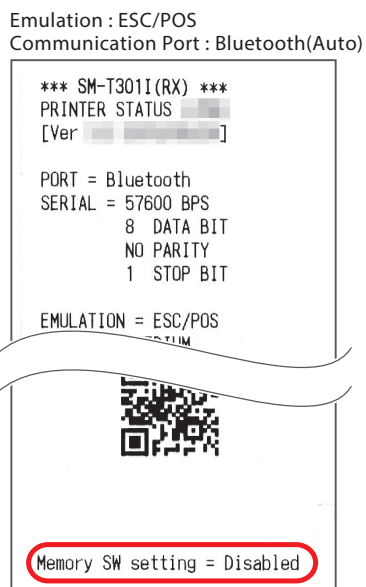

* When the above steps 1 to 4 are performed while the setting change by memory switch is disabled, the printer prints out "Memory SW setting = Enabled" and the setting change by memory switch is disabled.

Change the Memory switch by following operations.

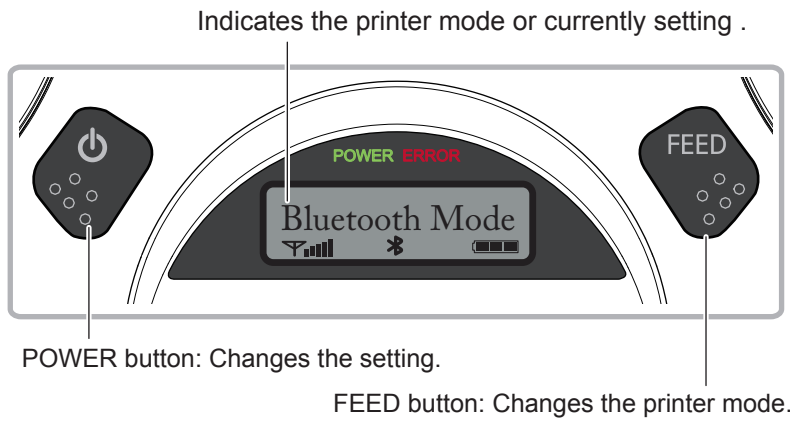

1. Press and hold POWER for approx. 3 seconds, and printer is turned on.

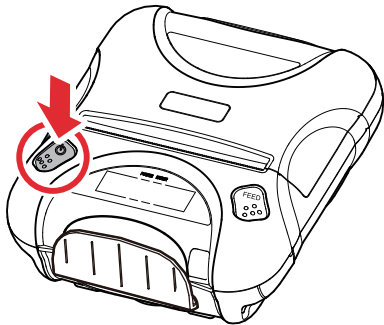

2. To put the printer into Memory Switch Setting mode, press and hold both the POWER & FEED buttons for 3 seconds. After the ERROR LED flashes five (5) times, you can configure the settings. Release the buttons after you surely confirm the LED flashes five (5) times, to get a printer into the setting mode.

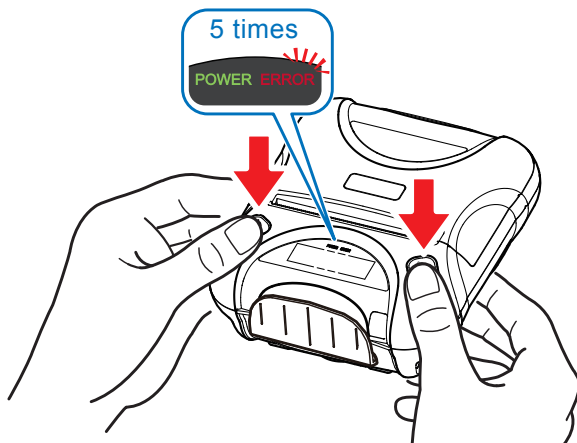

⚠ CAUTION

*Before changing the memory switch settings, make sure that the communication with a host device is disconnected.
When the printer is under the Bluetooth communication with a host device, it cannot enter the Memory Switch Setting mode.*

3. To switch the printer mode , press FEED button.
4. If the current printer mode does not need to be changed, press FEED button again and switch the printer mode. To change the setting, press POWER button.

*** Example:**

When you want to change the settings of the printer mode as shown below,

<Before> Bluetooth-Auto / 9600 BPS / 8 DATA BIT / NO PARITY / 1 STOP BIT / DENSITY LOW /
LOW QUALITY / MARK NO USE / SENSOR LOW / PWDN1min Sleep

<After> Bluetooth-Mac / 9600 BPS / 7 DDATA BIT / EVEN PARITY / 1 STOP BIT / DENSITY LOW /
HIGH QUALITY / MARK NO USE / SENSOR HIGH / PWDN1min Sleep

- ① Press and hold the POWER & FEED buttons for 3 seconds. After the ERROR LED flashes five times, you can configure the settings.
Press the POWER button twice and the connection mode will be changed to "Bluetooth-Mac".
Display: Bluetooth-Auto → UART Mode → Bluetooth-Mac
- ② Press the FEED button once and then you can change the baud rate setting.
- ③ When the baud rate does not need to be changed, press the FEED button once again and you can change the data bit setting. Press the POWER button once and the data bit will change to "7 bit".
Display: 8 DATA BIT → 7 DATA BIT
- ④ Press the FEED button once and then you can change the baud rate setting.
Press the POWER button twice and the parity bit will be changed to "EVEN PARITY".
Display: NO PARITY → ODD PARITY → EVEN PARITY
- ⑤ Press the FEED button once and then you can change the stop bit setting.
When the stop bit does not need to be changed, press the FEED button once again and you can change the print density setting.
- ⑥ When the print density does not need to be changed, press the FEED button once again and you can change the print quality setting.
Display: LOW QUALITY g HIGH QUALITY

5. After you have configured all of the settings, press and release FEED and MODE at the same time. The new settings will be printed.

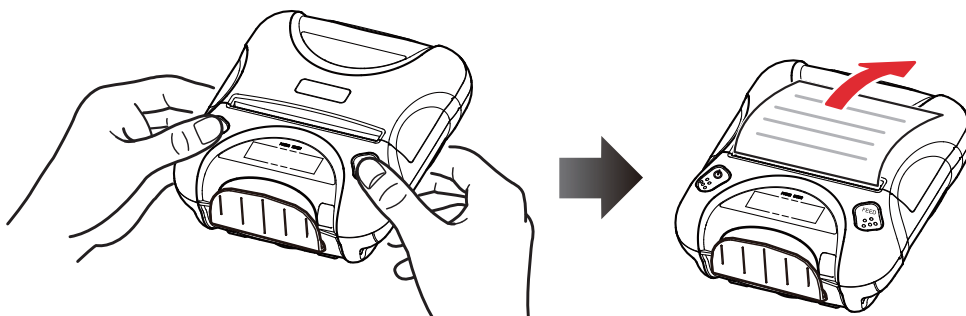

If the settings were not configured correctly, follow the above procedure to configure the settings again.

[Setting Table]

Note : To change the memory switch setting of the table below, use the buttons on the printer or the StarPRNT Intelligence application that can be downloaded from our web site.

	Printer Mode	Setting	Display
1	Communication Port *1)	RS-232C	UART Mode
		Bluetooth(Mac)	Bluetooth-Mac
		Bluetooth(Auto) *	Bluetooth-Auto
2	Baud Rate	9600 bps	9600 BPS
		19200 bps	19200 BPS
		38400 bps	38400 BPS
		57600 bps *	57600 BPS
		115200 bps	115200 BPS
3	Data Bit	7 Data bit	7 DATA BIT
		8 Data bit *	8 DATA BIT
4	Parity Bit	No Parity *	NO PARITY
		Odd Parity	ODD PARITY
		Even Parity	EVEN PARITY
5	Stop Bit	1 Stop bit *	1 STOP BIT
		2 Stop bit	2 STOP BIT
6	Print Density	Density Low	DENSITY LOW
		Density Medium *	DENSITY MEDIUM
		Density High	DENSITY HIGH
7	Print Quality	Low (75mm/s) *	LOW QUALITY
		High (50mm/s)	HIGH QUALITY
8	Black Mark Sensor	No use *	MARK NO USE
		Use	MARK USE
9	Black Mark Sensor Sensitivity	Low *	SENSOR LOW (167)
		Medium 1	SENSOR MEDIUM1 (282)
		Medium 2	SENSOR MEDIUM2 (397)
		High	SENSOR HIGH (512)
10	Power Down	No use *	PWDN NO USE
		1 Minute Sleep	PWDN 1 mim Slp *2)
		2 Minute Sleep	PWDN 2 mim Slp *2)
		3 Minute Sleep	PWDN 3 mim Slp *2)
		4 Minute Sleep	PWDN 4 mim SIP *2)
		5 Minute Sleep	PWDN 5 mim Slp *2)
		1 Minute Power Off	PWDN 1 mim Off
		2 Minute Power Off	PWDN 2 mim Off
		3 Minute Power Off	PWDN 3 mim Off
		4 Minute Power Off	PWDN 4 mim Off
5 Minute Power Off	PWDN 5 mim Off		
11	Auto Connection	ON *	AUTO CONN ON
		OFF	AUTO CONN OFF

*: Default

Refer to the next page for *1 and *2.

❖1) Communication mode

It is possible to change the communication mode setting between Bluetooth and serial. Please see below for details to select the proper communication mode for your application.

RS-232C:

The display shows [UART Mode]. At the RS-232C mode, the printer can communicate with a device using the serial communication cable supplied with the printer. When you connect the serial cable, the printer is automatically switched to serial communication from Bluetooth communication.

Bluetooth(Mac):

[Bluetooth(Mac)] is printed when a self test is executed.

At the Bluetooth(Mac) mode, the printer can communicate with Mac, Android device and Windows over Bluetooth.

Bluetooth (Auto):

[Bluetooth (Auto)] is printed when a self test is executed.

When using the printer with an iOS, Android, or Windows device, you can use Bluetooth without manually switching the Bluetooth mode.

Note: If you used an iOS device before an Android device, the auto connection function for iOS prevents the Android device from connecting to the printer.

Make sure to turn off Bluetooth on your iOS device, or delete the device.

❖2) Auto sleep function at iOS mode [Bluetooth(Auto)]

At iOS mode [Bluetooth(Auto)], set the Auto sleep mode to "NO USE" or Auto OFF mode.

When the printer wakes from the sleep mode, it cannot connect with the iOS device properly due to the iOS specifications. Therefore, it is impossible to use the Auto sleep function when the Communication mode of the printer is set to iOS mode [Bluetooth(Auto)].

◆ Simple method of switching over between Bluetooth (Auto) and Bluetooth(Mac) communication modes

Press and hold the MODE button and the FEED button for at least five seconds until ERROR LED flashes five times.

Continuously hold down the MODE button and the FEED button even until the buzzer sounds twice. The Bluetooth communication mode switches.

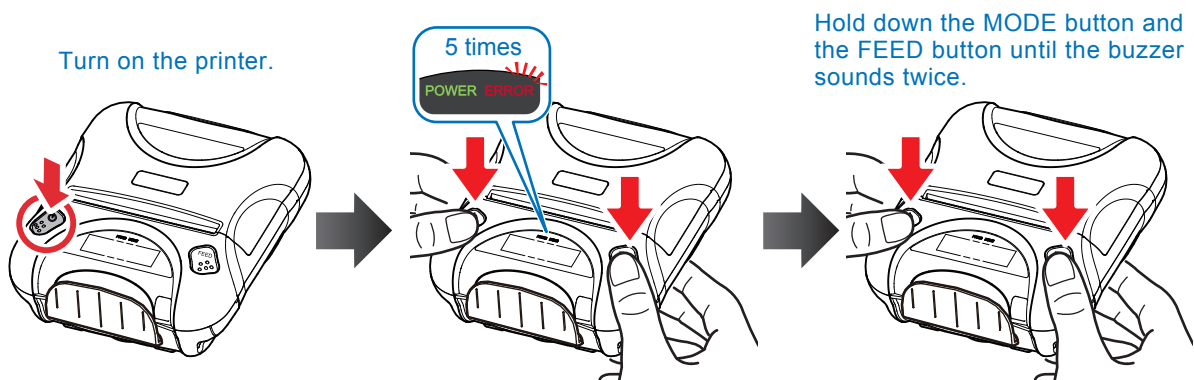

◆ Simple method of switching over between ESC/POS and StarPRNT emulation modes

1. Turn the printer power and open the printer cover.

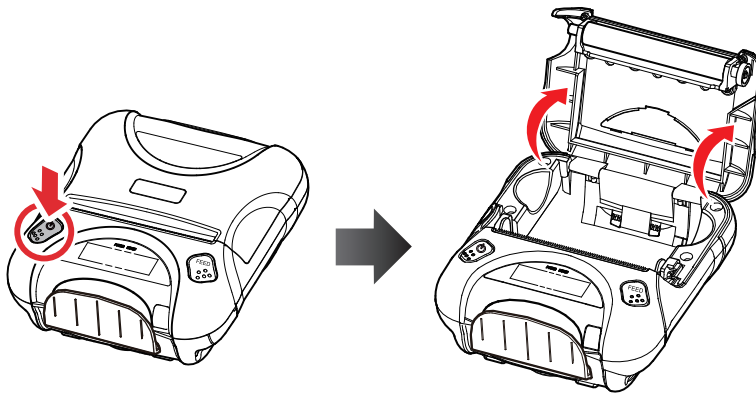

2. Press and hold the MODE button and the FEED button simultaneously. As soon as the ERROR lamp flashes five times, release the buttons. The emulation switchover takes place automatically.

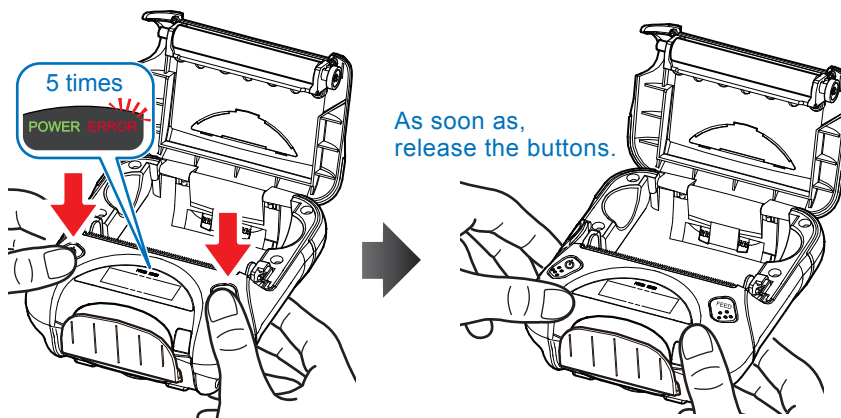

3. After setting a paper, close the printer cover. The set emulation mode is printed out.

ESC/POS mode: EMU = ESC/POS

StarPRNT mode: EMU = StarPRNT

If the emulation mode is not switched correctly, repeat the above steps 1 to 3.

At that time, in step 2, make sure not to release the buttons until the lamp completes the 5th flash.

4. Please reboot the printer after switching the emulation between StarPRNT and ESC/POS.

*It will be valid after rebooting the printer.

◆ Initialization of memory switch setting (factory setting)

To initialize the memory switch setting that has been changed, follow the steps below.

1. Turn the printer power and open the printer cover.
2. Press and hold the POWER button and the FEED button simultaneously and allow the ERROR lamp to flash five times. Continuously hold the buttons until the buzzer sounds five times. The POWER lamp and the ERROR lamp flash and the memory switch is initialized to the factory setting.

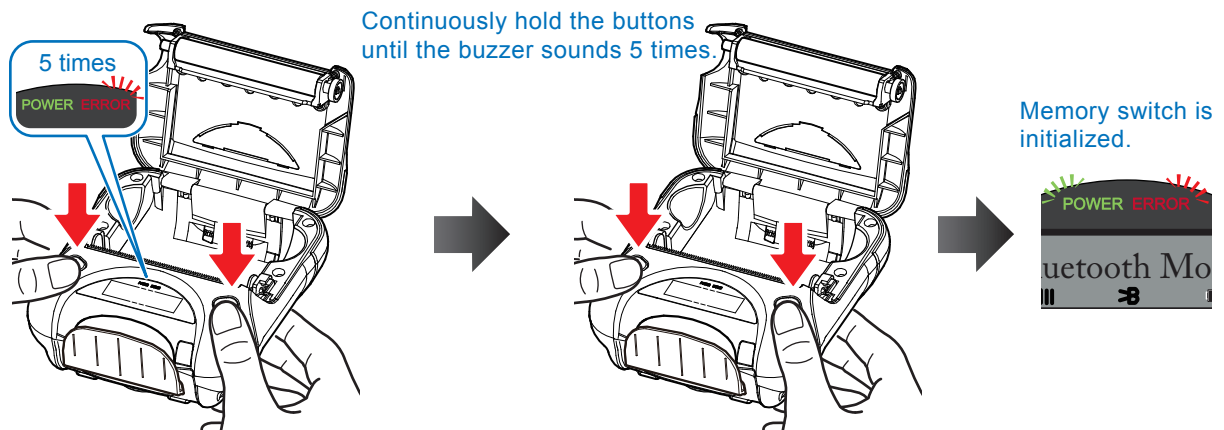

3. Set a paper and close the printer cover. The printer prints out "Memory SW was initialized."

3.4 HEX Dump Mode

All data sent from a host device is printed by hexadecimal codes.

This mode can be used to check if a program to be sent to the printer is coded correctly.

Follow the steps below.

1. While the printer cover is open, turn on the printer power by pressing and holding the FEED button and the MODE button simultaneously for five seconds or more.

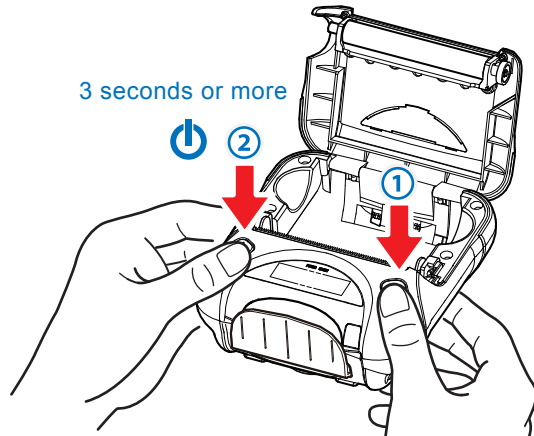

2. After the POWER lamp and ERROR lamp flash alternately, the buzzer sounds and only the ERROR lamp flashes continuously. Then, release the buttons and immediately press and hold the MODE button and the FEED button for three seconds or more, and release the buttons.

POWER lamp and ERROR lamp flash alternately.



Buzzer sounds.

Only the ERROR lamp flashes continuously.

As soon as the ERROR lamp flashes, release the buttons.

Immediately press and hold the both buttons for 3 seconds or more.

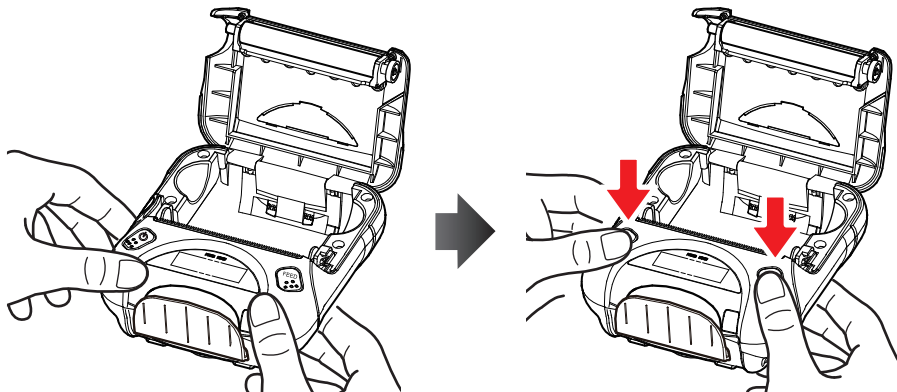

3. Set a paper and close the printer cover. The printer prints out "*** Hex Dump Printing ***" and enters the HEX dump mode.
4. To exit the HEX dump mode, turn off the printer power.

3.5 Instruction for Auto Power Down(Sleep) Mode

The printer in the Power Down(Sleep) Mode will recover to the Print Ready Mode when receiving commands or button operations.

However, print data received while shifting from the Sleep Mode to the print Ready Mode (for approx. 1 sec.) is discarded and cannot be printed.

Therefore, if the printer is in the Sleep Mode, please be sure to recover it to the Print Ready Mode before sending print data.

[How to Recover to Print Ready Mode & How to Check]

1) Send the Status command (DLE EOT EOT) and try to resend it until the printer receives the returned status value (any value from 30H to 37H). (*1)

Or

2) Press the FEED button or the MODE button (the Power button for SM-T300 series) and confirm that the Power lamp (Green LED) is turned on.

(*1: When the status value is not returned in the above 1) method, it is possible that the printer is turned off by the Power OFF mode. In this case, turn the printer on manually.

◆ Auto Power Down at iOS mode [Bluetooth(Auto)]

At iOS mode [Bluetooth(Auto)] , set the Auto sleep mode to "NO USE" or Auto OFF mode.

When the printer wakes from the sleep mode, it cannot connect with the iOS device properly due to the iOS specifications. Therefore, it is impossible to use the Auto Power Down when the Communication mode of the printer is set to iOS mode [Bluetooth(Auto)].

3.6 Card Reading (Only for Model with Card Reader)

Please keep the following points in mind when reading a card.

- Swipe the card with its magnetic stripe side towards the printer.
- Hold the card in the center as illustrated below and swipe it straight at a steady speed in the directions of arrows. You can swipe the card in either direction to read the data.

Be sure to hold the printer firmly with your hand while swiping.

If you hold the corner of the card, it is difficult to swipe it straight so that you may fail to read the card data. So hold the card in the center when you swipe the card.

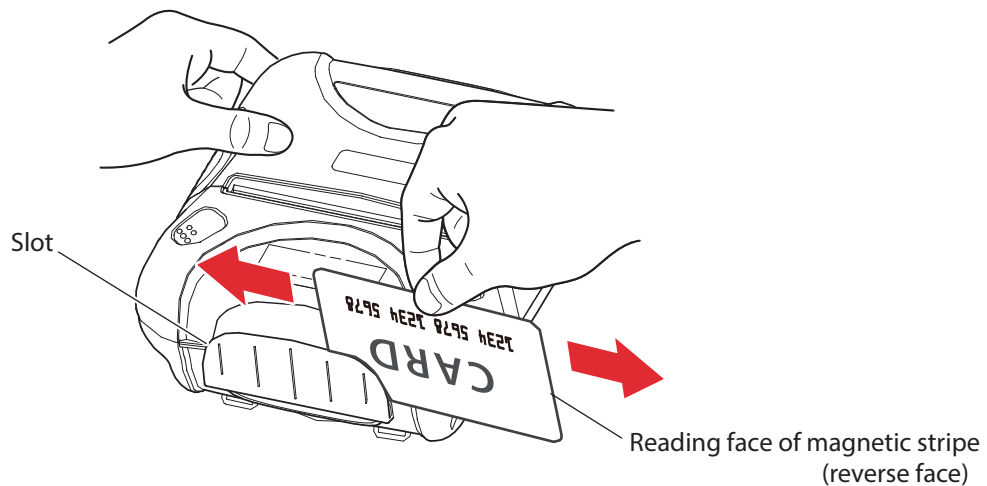

- A buzzer will sound once when a card is successfully read. When the printer fails to read the card, the buzzer will sound three times. Check the orientation of the card, and slide it through the reader slot again.

4. Paper

4.1 Paper Specifications

Type : Thermal Paper
Paper width : 80 mm
Paper thickness : $65 \pm 5 \mu m$
Outer diameter : $\varnothing 50$ mm or less
Inner diameter : $\varnothing 12$ mm or more
Recording side : Outside of roll

4.2 Recommended Paper (Common thermal roll paper)

Manufacturer	Product Name
Mitsubishi Paper Mills Limited	P220AG
Oji Paper Co., Ltd.	PD450
	PD160R
APPLETON	Alpha 800-2.4
KANZAKI (Oji Paper USA)	P-350

4.3 Printing Range

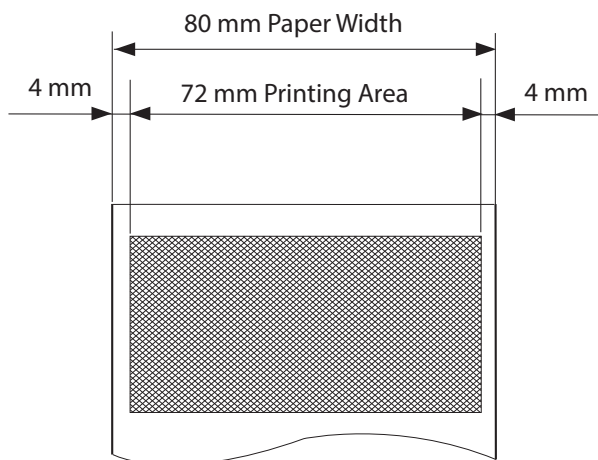

⚠ CAUTION

- 1) Do not use roll paper whose end is glued to its core, because the printer will be unable to properly detect the end of the paper. Also, we recommend that you use roll paper that has a roll end mark at its end.
- 2) Chemicals and oil may cause the roll paper to change color or cause the printed characters to become lighter.
- 3) The roll paper starts changing color at approximately 70°C.
Please be aware that the roll paper can be affected by heat, humidity, and direct sunlight.
- 4) The roll paper may change color if you scratch it with your fingernail, a hard piece of metal, etc.

5. General Specifications

Item	Specifications		
Printing method	Direct line thermal printing		
Characters per line	Maximum 64 cpl		
Character size	Alphanumeric characters: 9 X 24 dots, 12 X 24 dots, and 9 X 17 dots Japanese characters: 24 X 24 dots		
Character types	Alphanumeric characters, expanded graphic characters, JIS Level-1 Kanji Set, JIS Level-2 Kanji Set, and special characters		
Dot density	203 dpi (8 dots/mm)		
Printing width	72mm, 576 dots		
Print speed	75 mm/s (max)		
Interface	Bluetooth	Bluetooth Spec.	Bluetooth V2.1+EDR / Class 2 (10 m)
		Frequency Range	2.4 GHz ISM BAND
		Data Transmission Rate	57600 bps Fixed
		Data bit	8 Data bit Fixed
		Parity bit	No Parity Fixed.
		Stop bit	1 Stop bit Fixed.
		SSP	Incompatible
	RS-232C & Bluetooth Ver 2.1+EDR		
Emulation	ESC/POS, Firmware version 3.0 or older : Star Line / 3.1 or later : StarPRNT		
Roll paper	Thermal roll paper (80 mm wide with a diameter of Φ 50 mm)		
Barcode	1D: JAN, EAN, UPC, ITF, Code39, Code93, Code128, CODABAR(NW-7), GS1 Barcode(StarPRNT only) 2D: PDF417, QR Code, DATA Matrix(ESC/POS only), GS1 2Dcode(StarPRNT only), GS1 Conposite(StarPRNT only)		
Receive buffer size	1M bytes *1)		
MSR	SM-T300i : Not Supported MSR SM-T301i : ISO 7810 / 7811 / 7812 1st and 2nd Track Reading		
LCD	128x32 Dots FSTN (Blue LED Backlight)		
Battery pack	Rechargeable 7.4V DC 1800mAh		
Battery operating time	Approximately 11 hour printing (12 receipts per hour) Approximately 13 hour printing (12 receipts per hour / auto power down mode)		
Battery charger	Input: 100 to 250 V AC, 50 to 60 Hz Output:8.4 VDC/0.8 A, Time required for full charge: 4 h		
Environmental Requirements	Temperature *2)	-10 °C to 50 °C (for operation) -20 °C to 60 °C (for storage)	
	Humidity	30% to 80% (for operation) 10% to 90% (for storage)	
Print head life	Approximately 50 km		
Drop resistance	1.5 m / 1.2 m (Model with Card Reader) *Our test procedure, Not guarantee.		
Dust protected, Splash proof	IP54 Certified		

*1) If the quantity of data which is printed at once is more than 1M byte on Bluetooth communication, it would cause the buffer to overflow and the data to get damaged.

*2) Under 0°C, please change Density mode and Quality mode of the memory switch settings to both "High".
If you want to print a delicate pattern like Barcode printing, please use the printer over 0°C.

■ Dimensions

External Dimensions : 120 mm (W) × 130.5 mm (D) × 58.3 mm (H) <Model without Card Reader>

120 mm (W) × 132.2 mm (D) × 58.3 mm (H) <Model with Card Reader>

Weight : 442 g (Including Battery Pack)

Body Color : Gray

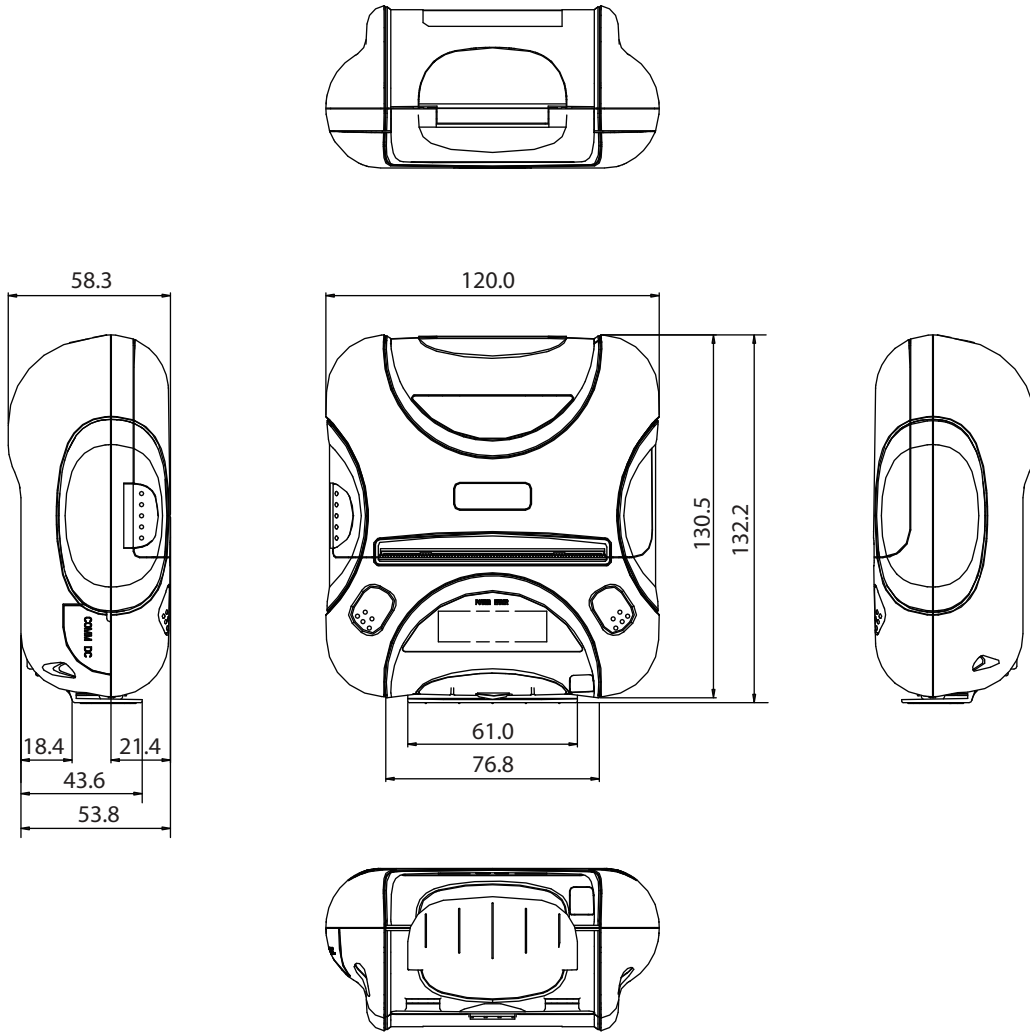



URL: <http://www.starmicronics.com/support/>

Rev. 1.4