

**Canon**

**EOS  
REBEL T8i  
EOS 850D**



Advanced User Guide

**E**

# Contents

---

Introduction. . . . .	9
Package Contents. . . . .	10
Instruction Manuals. . . . .	11
Quick Start Guide. . . . .	12
About This Guide. . . . .	16
Compatible Cards. . . . .	18
Safety Instructions. . . . .	19
Handling Precautions. . . . .	22
Part Names. . . . .	24
Software. . . . .	35
Preparation and Basic Operations. . . . .	39
Charging the Battery. . . . .	40
Inserting/Removing Batteries. . . . .	43
Inserting/Removing Cards. . . . .	46
Using the Screen. . . . .	50
Turning on the Power. . . . .	52
Attaching/Detaching Lenses. . . . .	55
Basic Operations. . . . .	59
Setting the Screen Display Level. . . . .	72
Menu Operations and Settings. . . . .	83
Quick Control. . . . .	90
Touch-Screen Operation. . . . .	97
Viewing the Screen as You Shoot (Live View Shooting). . . . .	99
Shooting Selfies (Self Portrait). . . . .	103
Basic Zone. . . . .	105
Fully Automatic Shooting (Scene Intelligent Auto). . . . .	106
Special Scene Mode. . . . .	117
Portrait Mode. . . . .	120
Smooth Skin Mode. . . . .	121
Group Photo Mode. . . . .	122

Landscape Mode.....	123
Close-up Mode.....	124
Sports Mode.....	125
Kids Mode.....	126
Food Mode.....	128
Candlelight Mode.....	129
Night Portrait Mode.....	130
Handheld Night Scene Mode.....	132
HDR Backlight Control Mode.....	134
Creative Filters Mode.....	135
<b>Creative Zone.....</b>	<b>141</b>
Program AE Mode (P).....	142
Shutter-Priority AE Mode (Tv).....	145
Aperture-Priority AE Mode (Av).....	148
Manual Exposure Mode (M).....	152
Long (Bulb) Exposures.....	156
Mirror Lockup.....	158
<b>AF, Drive, and Exposure Settings.....</b>	<b>160</b>
AF Operation.....	161
Selecting the AF Area and AF Point (Viewfinder Shooting).....	168
Selecting the AF Methods (Live View Shooting).....	176
Manual Focus.....	188
Drive Mode.....	193
Using the Self-Timer.....	195
Remote Control Shooting.....	197
Metering Mode.....	199
Exposure Compensation.....	201
Exposure Lock (AE Lock).....	203
<b>Flash Photography.....</b>	<b>205</b>
Shooting With the Built-in Flash.....	206
Flash Function Settings.....	211
Shooting With External Flash Units.....	228

Wireless Flash Photography Using Optical Transmission. . . . .	230
Easy Wireless Flash. . . . .	233
Custom Wireless Flash. . . . .	239
<b>Shooting and Recording. . . . .</b>	<b>253</b>
<b>Still Photo Shooting. . . . .</b>	<b>254</b>
Tab Menus: Still Photo Shooting (Viewfinder Shooting). . . . .	255
Tab Menus: Still Photo Shooting (Live View Shooting). . . . .	259
Image Quality. . . . .	263
Still Image Aspect Ratio. . . . .	267
Image Review Time. . . . .	269
Shutter Release Without Card. . . . .	270
Lens Aberration Correction. . . . .	271
Exposure Compensation/AEB Setting. . . . .	278
ISO Speed Settings (Still Photos). . . . .	280
Auto Lighting Optimizer. . . . .	285
Highlight Tone Priority. . . . .	287
Metering Timer (Live View Shooting). . . . .	288
White Balance Settings. . . . .	289
White Balance Correction. . . . .	296
Color Space. . . . .	299
Picture Style Selection. . . . .	300
Picture Style Customization. . . . .	304
Picture Style Registration. . . . .	309
Noise Reduction Features. . . . .	312
Appending Dust Delete Data. . . . .	316
Anti-Flicker Shooting. . . . .	321
Continuous AF (Live View Shooting). . . . .	323
Lens Electronic MF. . . . .	324
AF-Assist Beam Firing. . . . .	325
General Still Photo Shooting Precautions. . . . .	327
<b>Movie Recording. . . . .</b>	<b>331</b>
Tab Menus: Movie Recording. . . . .	332

Movie Recording. . . . .	335
HDR Movies. . . . .	345
Creative Filters. . . . .	347
Movie Recording Size. . . . .	352
Digital Zoom. . . . .	359
Movie Self-Timer. . . . .	361
Sound Recording. . . . .	362
Movie Digital IS. . . . .	365
Time-Lapse Movies. . . . .	367
Video Snapshots. . . . .	378
Movie Servo AF. . . . .	386
Other Menu Functions. . . . .	388
General Movie Recording Precautions. . . . .	393
Playback. . . . .	395
Tab Menus: Playback. . . . .	397
Image Playback. . . . .	400
Index Display (Multiple-Image Display). . . . .	403
Magnified Image Display. . . . .	408
Movie Playback. . . . .	410
Editing a Movie's First and Last Scenes. . . . .	414
Frame Extraction from 4K Movies or 4K Time-Lapse Movies. . . . .	417
Playback on a TV Set. . . . .	420
Protecting Images. . . . .	422
Rotating Still Photos. . . . .	426
Changing Movie Orientation Information. . . . .	428
Erasing Images. . . . .	430
Print Ordering (DPOF). . . . .	437
Photobook Set-up. . . . .	443
Creative Filters. . . . .	448
RAW Image Processing. . . . .	452
Creative Assist. . . . .	461
Quick Control RAW Processing. . . . .	464
Red-Eye Correction. . . . .	465

Creating Albums. . . . .	467
Cropping. . . . .	471
Resizing. . . . .	474
Rating Images. . . . .	476
Slide Show. . . . .	482
Setting Image Search Conditions. . . . .	486
Browsing Images with the Main Dial. . . . .	489
Histogram. . . . .	491
AF Point Display. . . . .	494
Resuming from Previous Playback. . . . .	495
HDMI HDR Output. . . . .	496
<b>Wireless Features. . . . .</b>	<b>497</b>
Tab Menus: Wireless Settings. . . . .	498
Wi-Fi/Bluetooth Connection. . . . .	500
Connecting to a Smartphone. . . . .	502
Connecting to a Computer via Wi-Fi. . . . .	543
Connecting to a Printer via Wi-Fi. . . . .	554
Sending Images to a Web Service. . . . .	568
Wi-Fi Connection via Access Points. . . . .	584
Connecting to a Wireless Remote Control. . . . .	592
Reconnecting via Wi-Fi. . . . .	596
Registering Multiple Connection Settings. . . . .	598
Wi-Fi Settings. . . . .	599
Bluetooth Settings. . . . .	600
Nickname. . . . .	601
GPS Device Settings. . . . .	602
Changing or Deleting Connection Settings. . . . .	607
Airplane Mode. . . . .	609
Clearing Wireless Communication Settings to Default. . . . .	610
View Info Screen. . . . .	611
Virtual Keyboard Operations. . . . .	612
Responding to Error Messages. . . . .	613
Wireless Communication Function Precautions. . . . .	621

Security	625
Checking Network Settings	626
Wireless Communication Status	627
<b>Set-up</b>	<b>629</b>
Tab Menus: Set-up	630
Selecting a Folder	635
File Numbering	638
Auto Rotate	643
Adding Orientation Information to Movies	645
Formatting	646
Auto Power Off	649
Display Brightness	650
Screen Off/On	651
Date/Time/Zone	652
Language	657
Video System	658
Touch Control	659
Beeps	660
Battery Information	661
Sensor Cleaning	663
Viewfinder Display	667
INFO Button Display Options	670
Grid Display When Shooting	672
Shutter Button Function for Movies	674
Switching AF Point Selection and AE Lock Buttons	676
HDMI Resolution	677
Multi-Function Lock	678
Custom Functions (C.Fn)	680
Clearing Settings	692
Copyright Information	694
Other Information	697
<b>My Menu</b>	<b>698</b>

Tab Menus: My Menu. . . . .	699
Registering My Menu. . . . .	700
Reference. . . . .	706
Importing Images to a Computer. . . . .	707
Household Power Outlet Accessory. . . . .	709
Troubleshooting Guide. . . . .	711
Error Codes. . . . .	727
System Map. . . . .	728
ISO Speed in Movie Recording. . . . .	730
Information Display. . . . .	731
AF Sensor. . . . .	745
Compatible Lenses and Autofocusing (Viewfinder Shooting). . . . .	746
Specifications. . . . .	761
Trademarks and Licensing. . . . .	773



# Introduction

---

## Before starting to shoot, be sure to read the following

To avoid shooting problems and accidents, first read the [Safety Instructions](#) and [Handling Precautions](#). Also read this Advanced User Guide carefully to ensure that you use the camera correctly.

## Take some test shots, and understand about product liability

After shooting, play images back and check whether they have been properly recorded. If the camera or memory card is faulty and the images cannot be recorded or downloaded to a computer, Canon cannot be held liable for any loss or inconvenience caused.

## Copyrights

Copyright laws in some countries prohibit the unauthorized use of images recorded with the camera (or music/images with music transferred to the memory card) for purposes other than personal enjoyment. Also be aware that certain public performances, exhibitions, etc. may prohibit photography even for private enjoyment.

- [Package Contents](#)
- [Instruction Manuals](#)
- [Quick Start Guide](#)
- [About This Guide](#)
- [Compatible Cards](#)
- [Safety Instructions](#)
- [Handling Precautions](#)
- [Part Names](#)
- [Software](#)

## Package Contents

---

Before use, make sure the following items are included in the package. If anything is missing, contact your dealer.

---



**Camera**  
(with eyecup and body cap)



**Battery Pack LP-E17**  
(with protective cover)



**Battery Charger LC-E17/LC-E17E\***

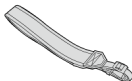

**Strap**

\* Battery Charger LC-E17 or LC-E17E is provided. (The LC-E17E comes with a power cord.)

- The camera does not come with a memory card (📁), interface cable, or HDMI cable.
- If you purchased a Lens Kit, check that the lenses are included.
- Be careful not to lose any of these items.

### ⚠ Caution

- When you need Lens Instruction Manuals, download them from the Canon website (📄). The Lens Instruction Manuals (PDF files) are for lenses sold individually. Note that when purchasing the Lens Kit, some of the accessories included with the lens may not match those listed in the Lens Instruction Manual.



The Instruction Manual included with the camera provides basic instructions for the camera and Wi-Fi functions.

- **Advanced User Guide**

Complete instructions are provided in this Advanced User Guide. For the latest Advanced User Guide, refer to the following website.  
<https://cam.start.canon/C002/>



- **Lens/Software Instruction Manual**

Download from the following website.  
<https://cam.start.canon/>



 **Note**

- Select [: **Manual/software URL**] to display the QR code on the camera screen.

## Quick Start Guide

### 1. Insert the battery (🔋).

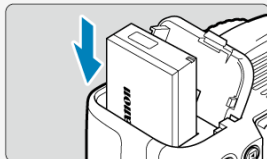

- Upon purchase, charge the battery to start using (🔋).

### 2. Insert the card (💳).

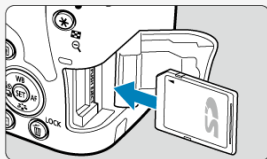
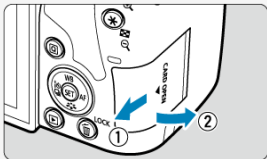

- With the card's label facing toward the back of the camera, insert it into the card slot.

### 3. Attach the lens (🔗).

White index

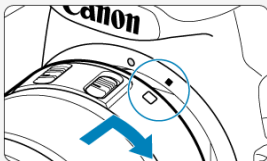

Red index

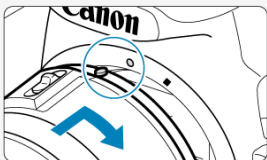

- Align the mount indexes on the lens and camera (red or white) to attach the lens.

### 4. Set the lens's focus mode switch to < AF > (🔗).

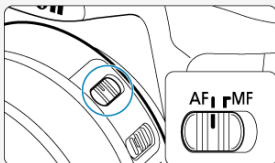

5. Set the power switch to <ON>, then set the Mode dial to <A+> (📷, 📷).

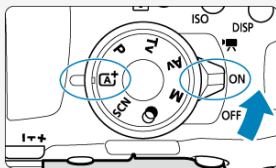

- All the necessary camera settings will be set automatically.

6. Flip out the screen (📷).

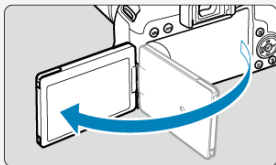

- When the [Date/Time/Zone] setting screen is displayed, see page [Date/Time/Zone](#).

7. Focus on the subject (📷).

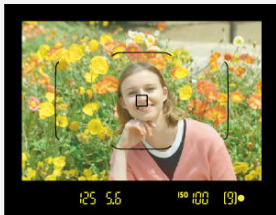

- Look through the viewfinder and center the subject on the screen.
- Press the shutter button halfway, and the camera will focus on the subject.
- If <🔦> blinks in the viewfinder, manually raise the built-in flash.

## 8. Take the picture (📷).



- Press the shutter button completely to take the picture.

## 9. Review the picture.



- The image just captured will be displayed for approx. 2 sec. on the screen (📷).
  - To display the image again, press the < ▶ > button (📷).
- 
- To shoot while looking at the screen, see [Viewing the Screen as You Shoot \(Live View Shooting\)](#).

## About This Guide







---

 [Icons in This Guide](#)







 [Basic Assumptions for Operational Instructions and Sample Photos](#)

### Icons in This Guide

---

	Indicates the Main dial.
	Indicates the Quick control dial.
	Indicates the direction to press the Quick control dial.
	Indicates the Set button.
	Indicates the Quick Control button.
	Indicates the duration (in * seconds) of the operation for the button you pressed, as timed after you release the button.

- In addition to the above, the icons and symbols used on the camera's buttons and displayed on the screen are also used in this manual when discussing relevant operations and functionality.

	☆ to the right of page titles indicates functions only available in Creative Zone modes (< <b>P</b> >, < <b>Tv</b> >, < <b>Av</b> >, or < <b>M</b> >) or for manual exposure movie recording.
	Links to pages with related topics.
	Warning to prevent shooting problems.
	Supplemental information.
	Tips or advice for better shooting.
	Troubleshooting advice.



## Basic Assumptions for Operational Instructions and Sample Photos

---

- Before following any instructions, make sure the power switch is set to < ON > and the Multi-function lock feature is off (🔒, 🔒).
- It is assumed that all the menu settings and Custom Functions are set to their defaults.
- Screen shots in this guide show the default menu settings for NTSC regions (North America, Japan, South Korea, Mexico, etc.) as an example. Default menu settings for Europe, Russia, China, Australia, etc. will be for PAL.
- Illustrations in this guide show the camera with the EF-S18-55mm lens attached as an example.
- The sample photos displayed on the camera and used in this guide are for instructional purposes only.

## Compatible Cards

---

The following cards can be used with the camera regardless of capacity. **If the card is new or was previously formatted (initialized) by another camera or computer, format the card with this camera (🔗).**

- **SD/SDHC/SDXC memory cards**

UHS-I cards supported.

### Cards That Can Record Movies

---

When recording movies, use a high-capacity card with ample performance (fast enough writing and reading speeds) for the movie recording size. For details, see [Cards That Can Record Movies](#).



In this guide, “card” refers to SD memory cards, SDHC memory cards, and SDXC memory cards.

\* **A card is not included.** Please purchase it separately.

## Safety Instructions

---

Be sure to read these instructions in order to operate the product safely.  
Follow these instructions to prevent injury or harm to the operator of the product or others.



**WARNING:** Denotes the risk of serious injury or death.

- Keep the product out of the reach of young children.

A strap wrapped around a person's neck may result in strangulation.

The parts or provided items of cameras or accessories are dangerous if swallowed. If swallowed, seek immediate medical assistance.

The battery is dangerous if swallowed. If swallowed, seek immediate medical assistance.

- Use only power sources specified in this instruction manual for use with the product.
- Do not disassemble or modify the product.
- Do not expose the product to strong shocks or vibration.
- Do not touch any exposed internal parts.
- Stop using the product in any case of unusual circumstances such as the presence of smoke or a strange smell.
- Do not use organic solvents such as alcohol, benzene or paint thinner to clean the product.
- Do not get the product wet. Do not insert foreign objects or liquids into the product.
- Do not use the product where flammable gases may be present.

This may cause electric shock, explosion or fire.

- Do not leave a lens or a camera/camcorder with a lens attached, exposed without the lens cap attached.

The lens may concentrate the light and cause fire.

- For products featuring a viewfinder, do not look through the viewfinder at strong light sources such as the sun on a bright day or lasers and other strong artificial light sources.

This may harm your vision.

- Do not touch the product connected to a power outlet during lightning storms.

This may cause electric shock.

- Observe the following instructions when using commercially available batteries or provided battery packs.
  - Use batteries/battery packs only with their specified product.
  - Do not heat batteries/battery packs or expose them to fire.
  - Do not charge batteries/battery packs using non-authorized battery chargers.
  - Do not expose the terminals to dirt or let them come into contact with metallic pins or other metal objects.
  - Do not use leaking batteries/battery packs.
  - When disposing of batteries/battery packs, insulate the terminals with tape or other means.

This may cause electric shock, explosion or fire.

If a battery/battery pack leaks and the material contacts your skin or clothing, flush the exposed area thoroughly with running water. In case of eye contact, flush thoroughly with copious amounts of clean running water and seek immediate medical assistance.

- Observe the following instructions when using a battery charger.
  - Periodically remove any dust buildup from the power plug and power outlet using a dry cloth.
  - Do not plug in or unplug the product with wet hands.
  - Do not use the product if the power plug is not fully inserted into the power outlet.
  - Do not expose the power plug and terminals to dirt or let them come into contact with metallic pins or other metal objects.
- Do not place heavy objects on the power cord. Do not damage, break or modify the power cord.
- Do not wrap the product in cloth or other materials when in use or shortly after use when the product is still warm in temperature.
- Do not unplug the product by pulling the power cord.
- Do not leave the product connected to a power source for long periods of time.
- Do not charge batteries/battery packs at temperatures outside the range of 5 – 40 °C (41 – 104 °F).

This may cause electric shock, explosion or fire.

- Do not allow the product to maintain contact with the same area of skin for extended periods of time during use.

This may result in low-temperature contact burns, including skin redness and blistering, even if the product does not feel hot. The use of a tripod or similar equipment is recommended when using the product in hot places and for people with circulation problems or less sensitive skin.

- Follow any indications to turn off the product in places where its use is forbidden. Not doing so may cause other equipment to malfunction due to the effect of electromagnetic waves and even result in accidents.



## CAUTION:

Denotes the risk of injury.

- Do not fire the flash near the eyes.

It may hurt the eyes.

- Do not look at the screen or through the viewfinder for prolonged periods of time.

This may induce symptoms similar to motion sickness. In such a case, stop using the product immediately and rest for a while before resuming use.

- Flash emits high temperatures when fired. Keep fingers, any other part of your body, and objects away from the flash unit while taking pictures.

This may cause burns or malfunction of the flash.

- Do not leave the product in places exposed to extremely high or low temperatures.

The product may become extremely hot/cold and cause burns or injury when touched.

- Strap is intended for use on the body only. Hanging the strap with any product attached on a hook or other object may damage the product. Also, do not shake the product or expose the product to strong impacts.

- Do not apply strong pressure on the lens or allow an object to hit it.

This may cause injury or damage to the product.

- Only mount the product on a tripod that is sufficiently sturdy.

- Do not carry the product when it is mounted on a tripod.

This may cause injury or may result in an accident.

- Do not touch any parts inside the product.

This may cause injury.

- If any abnormal skin reaction or irritation occurs during or following the use of this product, refrain from further use and get medical advice/attention.

# Handling Precautions

---

## Camera care

- This camera is a precision instrument. Do not drop it or subject it to physical shock.
- The camera is not waterproof and cannot be used underwater. If the camera gets wet, contact a Canon Service Center immediately. Wipe off any water droplets with a dry and clean cloth. If the camera has been exposed to salty air, wipe it with a clean, well-wrung wet cloth.
- Never leave the camera near anything having a strong magnetic field such as a magnet or electric motor. Also, avoid using or leaving the camera near anything emitting strong radio waves, such as a large antenna. Strong magnetic fields can cause camera malfunction or destroy image data.
- Do not leave the camera in excessive heat, such as in a car in direct sunlight. High temperatures can cause the camera to malfunction.
- The camera contains precision electronic circuitry. Never attempt to disassemble the camera yourself.
- Do not block the mirror operation with your finger, etc. Doing so may cause a malfunction.
- Use only a commercially available blower to blow away dust when it adheres to the lens, viewfinder, mirror, focusing screen, etc. Do not use cleaners that contain organic solvents to clean the camera body or lens. For stubborn dirt, take the camera to the nearest Canon Service Center.
- Do not touch the camera's electrical contacts with your fingers. This is to prevent the contacts from corroding. Corroded contacts can cause camera malfunction.
- If the camera is suddenly brought in from the cold into a warm room, condensation may form on the camera and internal parts. To prevent condensation, first put the camera in a sealed plastic bag and let it adjust to the warmer temperature before taking it out of the bag.
- If condensation forms on the camera, do not use the camera. This is to avoid damaging the camera. If there is condensation, remove the lens, card and battery from the camera, and wait until condensation has evaporated before using the camera.
- If the camera will not be used for an extended period, remove the battery and store the camera in a cool, dry, well-ventilated location. Even while the camera is in storage, press the shutter button a few times once in a while to check that the camera is still working.
- Avoid storing the camera where there are chemicals that result in rust and corrosion such as in a chemical lab.
- If the camera has not been used for an extended period, test all its functions before using it. If you have not used the camera for some time or if there is an important shoot such as a foreign trip coming up, have the camera checked by your nearest Canon Service Center or check the camera yourself and make sure it is working properly.
- The camera may become hot after repeated continuous shooting, Live View shooting, or movie shooting over an extended period. This is not a malfunction.
- If there is a bright light source inside or outside the image area, ghosting may occur.

## Screen

- Although the screen is manufactured with very high precision technology with over 99.99% effective pixels, 0.01% or fewer of the pixels may be dead, and there may also be spots of black, red, or other colors. This is not a malfunction. They do not affect the images recorded.
- If the screen is left on for a prolonged period, screen burn-in may occur where you see remnants of what was displayed. However, this is only temporary and will disappear when the camera is left unused for a few days.
- The screen display may seem slightly slow in low temperatures or may look black in high temperatures. It will return to normal at room temperature.

## Cards

To protect the card and its recorded data, note the following:

- Do not drop, bend, or wet the card. Do not subject it to excessive force, physical shock, or vibration.
- Do not touch the card's electronic contacts with your fingers or anything metallic.
- Do not affix any stickers, etc. on the card.
- Do not store or use the card near anything that has a strong magnetic field, such as a television, speakers, or magnets. Also avoid places prone to having static electricity.
- Do not leave the card in direct sunlight or near a heat source.
- Store the card in a case.
- Do not store the card in hot, dusty, or humid locations.

## Smudges on the image sensor

Besides dust entering the camera from outside, in rare cases, lubricant from the camera's internal parts may adhere to the front of the sensor. If smudges are visible on images, have the sensor cleaned by a Canon Service Center.

## Lens





- After detaching the lens from the camera, put down the lens with the rear end up and attach the rear lens cap to avoid scratching the lens surface and electrical contacts (1).

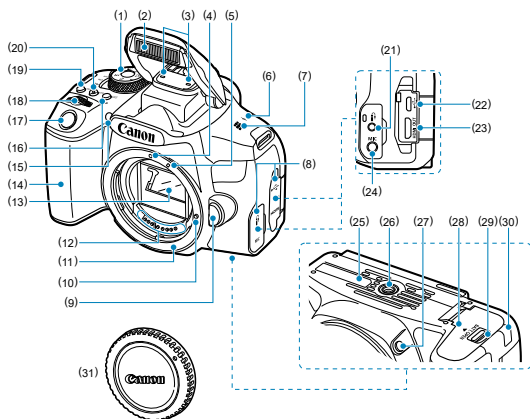









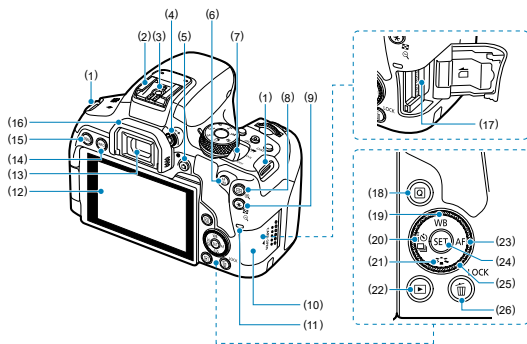













## Part Names





- 
- (1) Mode dial
  - (2) Built-in flash/AF-assist beam emitter
  - (3) Microphone
  - (4) EF lens mount index
  - (5) EF-S lens mount index
  - (6) <  > Focal plane mark
  - (7) Speaker
  - (8) Terminal cover
  - (9) Lens release button
  - (10) Lens lock pin
  - (11) Lens mount
  - (12) Contacts
  - (13) Mirror
  - (14) Grip
  - (15) Red-eye reduction/Self-timer lamp
  - (16) <  > AF area/AF method selection button
  - (17) Shutter button
  - (18) <  > Main dial
  - (19) < **DISP** > Display button
  - (20) < **ISO** > ISO speed setting button
  - (21) <  > Remote control terminal
  - (22) <  > Digital terminal
  - (23) < **HDMI OUT** > HDMI mini OUT terminal
  - (24) < **MIC** > External microphone IN terminal
  - (25) Serial number
  - (26) Tripod socket
  - (27) Depth-of-field preview button
  - (28) Battery compartment cover
  - (29) Battery compartment cover lock
  - (30) DC cord hole
  - (31) Body cap
-



- 
- (1) Strap mount
- 
- (2) Hot shoe
- 
- (3) Flash sync contacts
- 
- (4) Dioptic adjustment knob
- 
- (5)  > Live View shooting/Movie shooting button  
Switches from viewfinder display to Live View display. Recording is possible when the power switch is set to .
- 
- (6)  > AF start button
- 
- (7) Power switch
- 
- (8)  > AF point selection/ > Magnify button
- 
- (9)  > AE lock/FE lock/ > Index/Reduce button
- 
- (10) Card slot cover
- 
- (11) Access lamp
- 
- (12) Screen
- 
- (13) Viewfinder eyepiece
- 
- (14)  > Info button
- 
- (15)  > Menu button
- 
- (16) Eyecup
- 
- (17) Card slot
- 
- (18)  > Quick Control button
- 
- (19)  /  > Up/White balance selection button
- 
- (20)  /  > Left/Self-timer/Drive mode selection button
- 
- (21)  /  > Down/Picture Style selection button
- 
- (22)  > Playback button
- 
- (23)  /  > Right/AF operation selection button
- 
- (24)  > Setting button
- 
- (25)  > Quick control dial
- 
- (26)  > Erase/<LOCK> Lock button
-

## Viewfinder information display

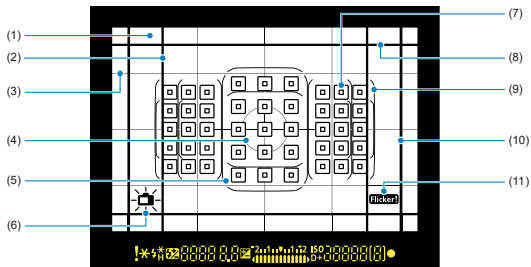

- (1) Focusing screen
- (2) Aspect ratio line (1:1)
- (3) Grid
- (4) Spot metering circle
- (5) Large Zone AF frame
- (6) Electronic level
- (7) <□> AF point  
<▣> Spot AF point
- (8) Aspect ratio line (16:9)
- (9) Area AF frame
- (10) Aspect ratio line (4:3)
- (11) < Flicker! > Flicker detection

\* The display will show only the settings currently applied.

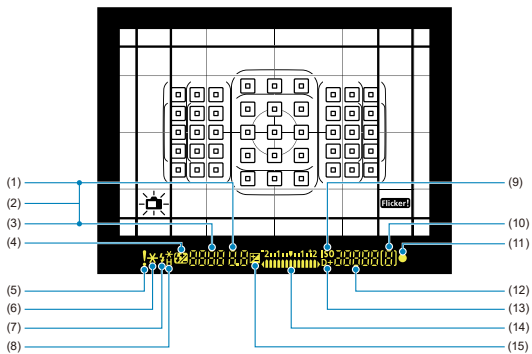

- 
- (1) Aperture value
- 
- (2) AF point selection  
([ ] AF, SEL [ ], SEL AF)
- 
- (3) Shutter speed  
Bulb (**buLb**)  
FE lock (**FEL**)  
Busy/Charging the built-in flash (**buSY**)  
Multi-function lock warning (L)  
No card warning (**Card**)  
Card full warning (**FuLL**)  
Card error warning (**Card**)  
Error codes (**Err**)  
AI Bounce mode active (A1\_b)
- 
- (4) < [ ] > Flash exposure compensation
- 
- (5) < ! > Warning icon
- 
- (6) < \* > AE lock  
AEB in progress
- 
- (7) < [ ] > Warning to use flash (blinking)  
Flash ready (on)  
FE lock out of range warning (blinking)
- 
- (8) < [ ] \* > FE lock  
FEB in progress  
< [ ] H > High-speed sync
- 
- (9) < ISO > ISO speed
- 
- (10) Maximum burst
- 
- (11) < ● > Focus indicator
- 
- (12) ISO speed
- 
- (13) < D+ > Highlight tone priority
- 
- (14) Exposure level indicator  
Exposure compensation amount  
AEB range  
Red-eye reduction lamp ON
- 
- (15) < [ ] > Exposure compensation
-

## Mode dial

The Mode Dial includes the Basic Zone modes and Creative Zone modes.





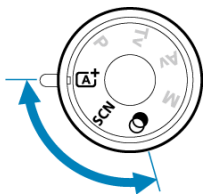







### (1) Basic Zone

All you do is press the shutter button. The camera sets everything to suit the subject or scene for shooting.













**A<sup>+</sup>**: Scene Intelligent Auto (🔗)

**SCN** : Special scene (🔗)

	<a href="#">Portrait</a>		<a href="#">Kids</a>
	<a href="#">Smooth skin</a>		<a href="#">Food</a>
	<a href="#">Group Photo</a>		<a href="#">Candlelight</a>
	<a href="#">Landscape</a>		<a href="#">Night Portrait</a>
	<a href="#">Close-up</a>		<a href="#">Handheld Night Scene</a>
	<a href="#">Sports</a>		<a href="#">HDR Backlight Control</a>

**🔗**: Creative filters (🔗)

	<a href="#">Grainy B/W</a>		<a href="#">Miniature effect</a>
	<a href="#">Soft focus</a>		<a href="#">HDR art standard</a>
	<a href="#">Fish-eye effect</a>		<a href="#">HDR art vivid</a>
	<a href="#">Water painting effect</a>		<a href="#">HDR art bold</a>
	<a href="#">Toy camera effect</a>		<a href="#">HDR art embossed</a>

## (2) Creative Zone

These modes give you more control for shooting various subjects as desired.

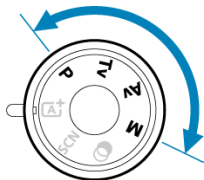

<b>P</b>	<a href="#">Program AE (P)</a>
<b>Tv</b>	<a href="#">Shutter priority AE (Tv)</a>
<b>Av</b>	<a href="#">Aperture priority AE (Av)</a>
<b>M</b>	<a href="#">Manual exposure (M)</a>

## Battery Charger LC-E17

Charger for Battery Pack LP-E17 (🔋).

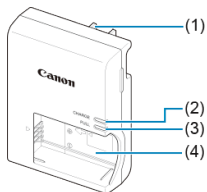

- |     |                   |
|-----|-------------------|
| (1) | Power plug        |
| (2) | Charge lamp       |
| (3) | Full-charge lamp  |
| (4) | Battery pack slot |



## Battery Charger LC-E17E

Charger for Battery Pack LP-E17 (🔗).

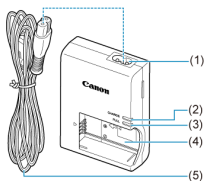

---

(1) Power cord socket

---

(2) Charge lamp

---

(3) Full-charge lamp

---

(4) Battery pack slot

---

(5) Power cord

---

## Attaching the Strap

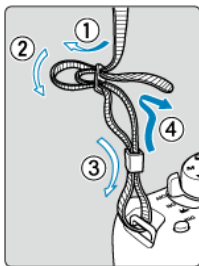

Pass the end of the strap through the camera's strap mount eyelet from the bottom. Then pass it through the strap's buckle as shown in the illustration. Pull the strap to take up any slack and make sure the strap will not loosen from the buckle.

# Software

---

[✔ Software Overview](#)

[✔ Downloading and Installing EOS Software or Other Dedicated Software](#)

[✔ Downloading the Software Instruction Manual](#)

## Software Overview

---

This section summarizes software used with EOS cameras. Note that downloading and installing the software requires an internet connection. The software cannot be downloaded or installed in environments without an internet connection.

### EOS Utility

Enables you to transfer your captured still photos and movies from the camera to a connected computer, set various camera settings from the computer, and shoot remotely from the computer. Also, you can copy background music tracks, such as EOS Sample Music\*, to the card.

\* You can use the background music as the soundtrack for a video snapshot album, movie, or slide show played back with your camera.

### Digital Photo Professional

Software recommended for users who shoot RAW images. Enables image viewing, editing, printing, and more.

### Picture Style Editor

Enables you to edit existing Picture Styles or create and save original Picture Style files. This software is for users who are familiar with image processing.

## Downloading and Installing EOS Software or Other Dedicated Software

---

Always install the latest version of the software.

Update any previous versions that are installed by overwriting them with the latest version.

### Caution

- Do not connect the camera to a computer before you install the software. The software will not be installed correctly.
- The software cannot be installed unless the computer is connected to the internet.
- Previous versions cannot display images from this camera correctly. Also, processing RAW images from this camera is not possible.

## 1. Download the software.

- Connect to the internet from a computer and access the following Canon website.

<https://cam.start.canon/>



- Enter the serial number on the bottom of the camera, then download the software.
- Decompress it on the computer.

- **For Windows**

Click the displayed installer file to start the installer.

- **For macOS**

A dmg file will be created and displayed. Follow the steps below to startup the installer.

1. Double-click the dmg file.

- A drive icon and installer file will appear on the desktop. If the installer file does not appear, double-click the drive icon to display it.

2. Double-click the installer file.

- The installer starts.

## 2. Follow the on-screen instructions to install the software.

## Downloading the Software Instruction Manual

---

Software Instruction Manuals (PDF files) can be downloaded from the Canon website to your computer.

- **Software Instruction Manual download site**

<https://cam.start.canon/>



# Preparation and Basic Operations

---

This chapter describes preparatory steps before you start shooting and the basic camera operations.

- [Charging the Battery](#)
- [Inserting/Removing Batteries](#)
- [Inserting/Removing Cards](#)
- [Using the Screen](#)
- [Turning on the Power](#)
- [Attaching/Detaching Lenses](#)
- [Basic Operations](#)
- [Setting the Screen Display Level](#)
- [Menu Operations and Settings](#)
- [Quick Control](#)
- [Touch-Screen Operation](#)
- [Viewing the Screen as You Shoot \(Live View Shooting\)](#)
- [Shooting Selfies \(Self Portrait\)](#)

## Charging the Battery

---

1. Detach the protective cover provided with the battery.

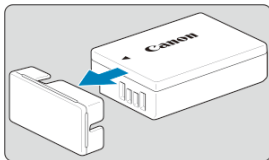

2. Fully insert the battery into the charger.

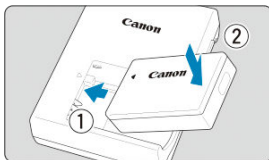

- Do the opposite to remove the battery.



### 3. Recharge the battery.

#### LC-E17

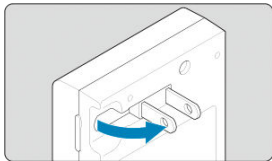

- As shown by the arrow, flip out the battery charger's prongs and insert the prongs into a power outlet.

#### LC-E17E

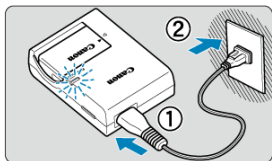

- Connect the power cord to the charger and insert the plug into a power outlet.

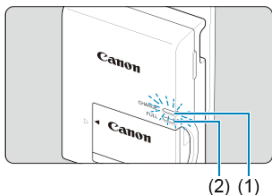

- Charging starts automatically and the charge lamp (1) lights up in orange.
- When the battery is fully charged, the full-charge lamp (2) will light up in green.
- **It takes approx. 2 hr. to fully charge a completely exhausted battery at room temperature (23°C/73°F).**  
The time required to charge the battery will vary greatly depending on the ambient temperature and the battery's remaining capacity.
- For safety reasons, charging in low temperatures (5–10°C/41–50°F) will take longer (up to approx. 4 hr.).

- **Upon purchase, the battery is not fully charged.**  
Charge the battery before use.
- **Charge the battery on the day before or on the day it is to be used.**  
Charged batteries gradually lose their charge, even when they are not used.
- **After charging the battery, remove it and disconnect the charger from the power outlet.**
- **When not using the camera, remove the battery.**  
If the battery is left in the camera for a prolonged period, a small amount of power current will keep being released, resulting in excess discharge and shorter battery life. Store the battery with the protective cover attached. Storing the battery when it is fully charged may lower the battery performance.
- **The battery charger can also be used in foreign countries.**  
The battery charger is compatible with a 100 V AC to 240 V AC 50/60 Hz power source. If necessary, attach a commercially available plug adapter for the respective country or region. Do not attach any portable voltage transformer to the battery charger. Doing so may damage the battery charger.
- **If the battery becomes exhausted quickly even after having been fully charged, the battery has reached the end of its service life.**  
Check the battery's recharge performance (🔋) and purchase a new battery.

 **Caution**

- After disconnecting the charger's power plug, do not touch the prongs for approx. 5 sec.
- The provided charger cannot charge any battery other than Battery Pack LP-E17.

## Inserting/Removing Batteries

---

 [Insertion](#)

 [Removal](#)

Insert a fully charged Battery Pack LP-E17 into the camera.

**Viewfinder brightness increases when a battery is inserted and decreases after removal. Without a battery, viewfinder display is blurry and focusing is not possible.**

---

### Insertion

---

1. Slide the battery compartment cover lock and open the cover.



2. Insert the battery.

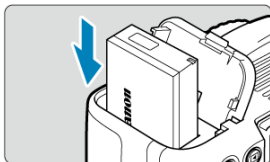

- Insert the end with the electrical contacts.
- Insert the battery until it locks in place.

### 3. Close the cover.



- Press the cover until it snaps shut.

#### ⚠ Caution

- You cannot use batteries other than the Battery Pack LP-E17.

### 1. Open the cover and remove the battery.

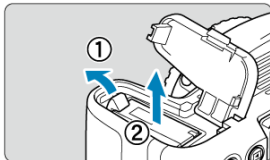

- Press the battery lock lever as shown by the arrow and remove the battery.
- To prevent short-circuits, always attach the included protective cover (🔒) to the battery.

## Inserting/Removing Cards

---

- ☑ [Insertion](#)
- ☑ [Formatting the Card](#)
- ☑ [Removal](#)

The captured images are recorded onto the card.

---

### Insertion

---

1. Slide the cover to open it.

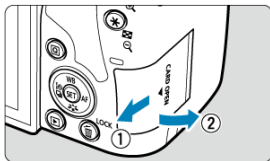

2. Insert the card.

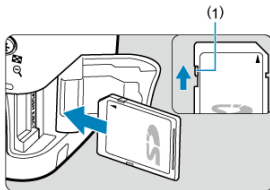

- As shown by the illustration, face the card's label side toward you and insert it until it clicks in place.

#### ⚠ Caution

- Make sure the card's write-protect switch (1) is set upward to enable writing and erasing.

### 3. Close the cover.

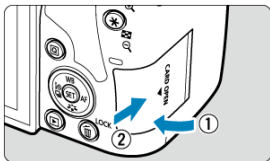

- Close the cover and slide it in the direction shown by the arrows until it snaps shut.

## Formatting the Card

If the card is new or was previously formatted (initialized) by another camera or computer, format the card with this camera (📷).

### 1. Open the cover.

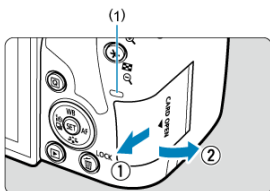

- Set the power switch to < OFF >.
- Check that the access lamp (1) is off, then open the cover.
- If [Saving...] is displayed on the screen, close the cover.

### 2. Remove the card.

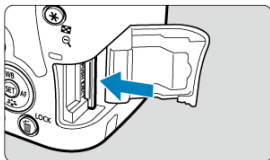

- Gently push in the card, then let it go to eject.

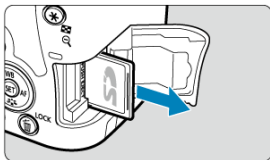

- Pull the card straight out, then close the cover.





## Note

- The number of available shots varies depending on the remaining capacity of the card, the settings of image quality, ISO speed, etc.
- Setting [📷: **Release shutter without card**] to [Disable] will prevent you from forgetting to insert a card (🔗).



## Caution

- **When the access lamp is lit or blinking, it indicates that images are being written to, read from, or erased from the card, or data is being transferred. Do not open the card slot cover during this time. To avoid corrupting image data or damaging cards or the camera, never do any of the following while the access lamp is lit or blinking.**
  - Removing the card.
  - Removing the battery.
  - Shaking or striking the camera.
  - Unplugging or plugging in a power cord  
(when using optional [Household Power Outlet Accessory](#)).
- If the card already contains recorded images, the image number may not start from 0001 (🔗).
- If a card-related error message is displayed on the screen, remove and reinsert the card. If the error persists, use a different card.  
If you can transfer images on the card to a computer, transfer all the images and then format the card with the camera (🔗). The card may then return to normal.
- Do not touch the card's contacts with your fingers or metal objects. Do not expose the contacts to dust or water. If smudges adhere to the contacts, contact failure may result.
- Multimedia cards (MMC) cannot be used. (Card error will be displayed.)

## Using the Screen

---

You can change the direction and angle of the screen.

---

### 1. Flip out the screen.

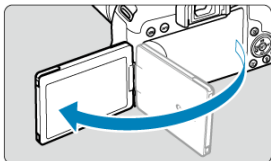

### 2. Rotate the screen.

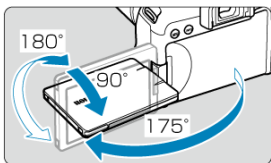

- When the screen is out, you can tilt it up or down or rotate it to face the subject.
- Indicated angles are only approximate.

### 3. Face it toward you.

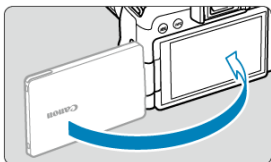

- Normally, use the camera with the screen facing you.

 **Caution**

- Avoid forcing the screen into position as you rotate it, which puts undue pressure on the hinge.
- When a cable is connected to a camera terminal, the rotation angle range of the flipped-out screen will be limited.

 **Note**

- Keep the screen closed and facing the camera body when the camera is not in use.

## Turning on the Power

---

[Setting the Date, Time, and Time Zone](#)

[Changing the Interface Language](#)

[Automatic Sensor Cleaning](#)

[Battery Level Indicator](#)

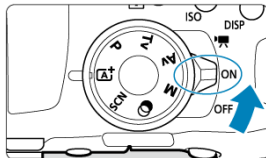

● <  >

The camera turns on. You can record movies ().

● < ON >

The camera turns on. You can shoot still photos.

● < OFF >

The camera is turned off and does not function. Set the power switch to this position when not using the camera.

## Setting the Date, Time, and Time Zone

---

If you turn on the camera and the **[Date/Time/Zone]** setting screen appears, see [Date/Time/Zone](#) to set the date, time, and time zone.



## Changing the Interface Language

---

To change the interface language, see [Language](#).

## Automatic Sensor Cleaning

---

- Whenever the power switch is set to < ON > or < OFF >, the sensor is cleaned automatically (which may make a faint sound). During the sensor cleaning, the screen will display [].
- If you repeatedly turn the power switch to < ON > or < OFF > within a short time period, the [] icon may not be displayed, but this does not indicate the camera is malfunctioning.



### Note

- If you set the power switch to < OFF > while an image is being recorded to the card, [**Saving...**] will be displayed and the power will turn off after the recording finishes.

## Battery Level Indicator

When the power switch is set to < ON >, the battery level will be indicated.

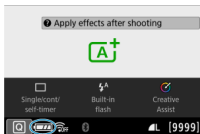

	Battery level is sufficient.
	Battery level is low, but the camera can still be used.
	Battery will be exhausted soon (blinks).
	Charge the battery.

### Caution

- Doing any of the following will exhaust the battery faster:
  - Pressing the shutter button halfway for a prolonged period.
  - Activating the AF frequently without taking a picture.
  - Using the lens's Image Stabilizer.
  - Using the Wi-Fi function or Bluetooth function.
  - Using the screen frequently.
- Fewer shots may be available under certain shooting conditions.
- The lens operation is powered by the camera's battery. Certain lenses may exhaust the battery faster than others.
- In low ambient temperatures, shooting may not be possible even with a sufficient battery level.

### Note

- See [ **Battery info.**] to check the battery status ().

## Attaching/Detaching Lenses

---

[Attaching a Lens](#)

[Detaching a Lens](#)

The camera can be used with all Canon EF and EF-S lenses. **The camera cannot be used with RF or EF-M lenses.**

---

### Attaching a Lens

---

#### 1. Remove the caps.

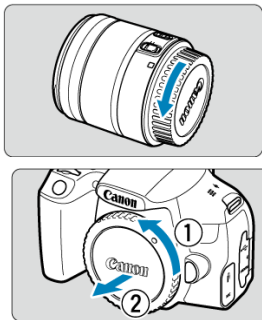

- Remove the rear lens cap and the body cap by turning them as shown by the arrows.

## 2. Attach the lens.

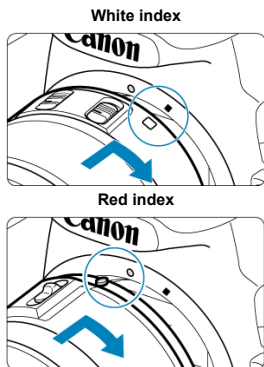

- Align the white or red mount index on the lens with the corresponding mount index on the camera and turn the lens as shown by the arrow until it clicks into place.

## 3. Set the lens's focus mode switch to < AF >.

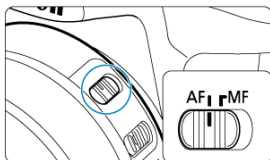

- < AF > stands for autofocus.
- < MF > stands for manual focus. Autofocus will not operate.

## 4. Remove the front lens cap.



## Detaching a Lens

1. While pressing the lens release button, turn the lens as shown by the arrow.

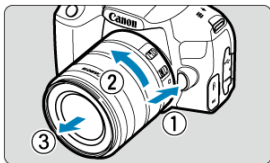

- Turn the lens until it stops, then detach it.
- Attach the rear lens cap to the detached lens.

### Caution

- Do not look at the sun directly through any lens. Doing so may cause loss of vision.
- When attaching or detaching a lens, set the camera's power switch to **<OFF>**.
- If the front part (focusing ring) of the lens rotates during autofocus, do not touch the rotating part.

### Note

- For instructions on how to use the lens, refer to the Lens Instruction Manual (📖).

#### Shooting angle of view

Because the image area is smaller than 35mm film format, the effective angle of view corresponds to approx. 1.6 times the lens's indicated focal length.



- (1) Image area (approx.) (22.3×14.8 mm/0.88×0.59 in.)  
(2) 35mm film format (36×24 mm/1.42×0.94 in.)

#### **Tips for avoiding smudges and dust**

- When changing lenses, do it quickly in a place with minimal dust.
- When storing the camera without a lens attached, be sure to attach the body cap to the camera.
- Remove dust on the body cap before attaching it.

## Basic Operations

---

- [Adjusting the Viewfinder](#)
- [Holding the Camera](#)
- [Shutter Button](#)
- [Main Dial](#)
- [Quick Control Dial](#)
- [AF Start Button](#)☆
- [LOCK Button](#)
- [INFO Button](#)
- [DISP Button](#)

### Adjusting the Viewfinder

---

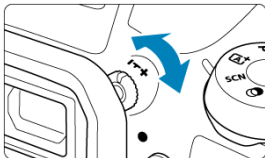

- Turn the dioptic adjustment knob left or right so that the AF points in the viewfinder look sharp.
- If the knob is difficult to turn, remove the eyecup.

#### Note

- If the camera's dioptic adjustment still cannot provide a sharp viewfinder image, using E series Dioptic Adjustment Lenses (sold separately) is recommended.

## Holding the Camera

To obtain sharp images, hold the camera still to minimize camera shake.

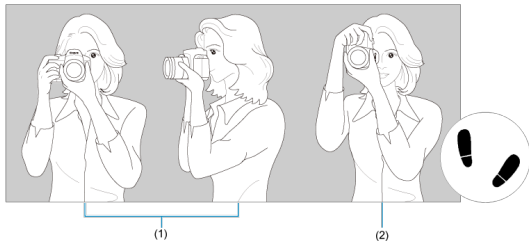

(1) Horizontal shooting

(2) Vertical shooting

1. With your right hand, hold the camera firmly by the camera grip.
2. With your left hand, support the lens from below.
3. Rest your right index finger lightly on the shutter button.
4. Rest your arms and elbows lightly against the front of your body.
5. To maintain a stable stance, place one foot slightly ahead of the other.
6. Hold the camera near your face and look through the viewfinder.



### Note

- To shoot while looking at the screen, see [Viewing the Screen as You Shoot \(Live View Shooting\)](#).

## Shutter Button

The shutter button has two steps. You can press the shutter button halfway. Then you can further press the shutter button completely.

### Pressing halfway



This activates autofocus and the automatic exposure system that sets the shutter speed and aperture value.

The exposure value (shutter speed and aperture value) is displayed in the viewfinder for approx. 4 sec. (metering timer/4).

### Pressing completely



This releases the shutter and takes the picture.

### ● Preventing camera shake

“Camera shake” refers to movement of the camera in your hands at the moment of exposure, which may cause overall blurriness in the picture. To prevent camera shake, note the following:

- Hold the camera still, as shown in [Holding the Camera](#).
- Press the shutter button halfway to autofocus, then slowly press the shutter button completely.





#### Note

- The camera will still pause before taking a picture if you press the shutter button completely without pressing it halfway first, or if you press the shutter button halfway and immediately press it completely.
- Even during menu display or image playback, you can return to shooting standby by pressing the shutter button halfway.

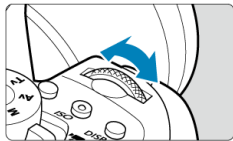
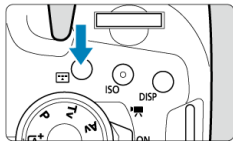
(1) After pressing a button, turn the <  > dial.





When you press a button such as <  > or < ISO >, the respective function remains selectable for approx. 6 sec. (Ⓜ6). During this time, you can turn the <  > dial to adjust the setting.

When the timer ends or if you press the shutter button halfway, the camera will go back to shooting standby.

- Used for operations such as selection of the AF area, AF point, or AF operation, or the ISO speed, drive mode, or Picture Style.

### Note

- Can be used even when the multi-function lock is engaged ().

(2) Turn only the <  > dial.

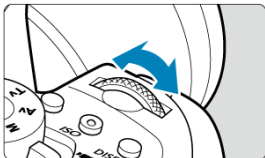



Turn the <  > dial while looking at the viewfinder.

- Used for operations such as setting the shutter speed and aperture value.

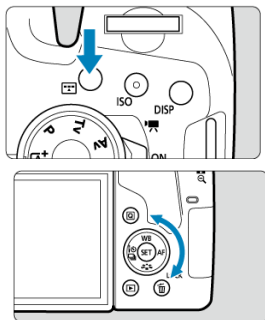

(1) After pressing a button, turn the <  > dial.



When you press a button such as <  > or < ISO >, the respective function remains selectable for approx. 6 sec. (Ⓜ6). During this time, you can turn the <  > dial to adjust the setting.

When the timer ends or if you press the shutter button halfway, the camera will go back to shooting standby.

- Used for operations such as selection of the AF area, AF point, or AF operation, or the ISO speed, drive mode, white balance, or Picture Style.



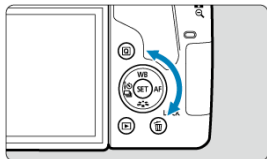

### Note

- Can be used even when the multi-function lock is engaged (🔒).

**(2) Turn only the <  dial.**



Turn the <  dial while looking at the viewfinder.

- Use this dial to set the exposure compensation amount, the aperture value setting for manual exposures, etc.
- Turning the Quick control dial is one way to choose setting items, switch images, and perform other operations. Additionally, you can perform most of the operations that are possible with the <  > <  > <  > <  > keys.

In still photo shooting, has the same effect as pressing the shutter button halfway in Creative Zone modes (📷).

In movie recording as well, enables autofocusing in Creative Zone modes.

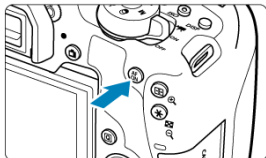

## LOCK Button

With [**☛**: Multi function lock] configured (**☑**), you can press the <LOCK> button to prevent unintended settings changes caused by accidentally operating the <⚙️> or <⏸️> dials or touching the touch-screen panel.

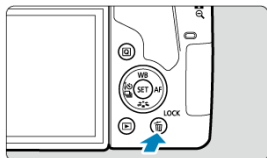

### Note

- Attempting to use any locked camera controls after you have pressed the <LOCK> button will cause <L> to appear in the viewfinder and [**LOCK**] on the Quick Control screen (**☑**).
- By default, the <⏸️> dial will be locked when the multi-function lock switch is in the lock position.

## INFO Button

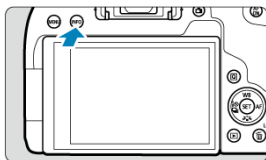

Each press of the <INFO> button changes the information shown. The following sample screens are for still photos.

When the Quick Control screen is displayed, you can press the <Q> button and configure shooting functions directly (🔗).

### In viewfinder shooting

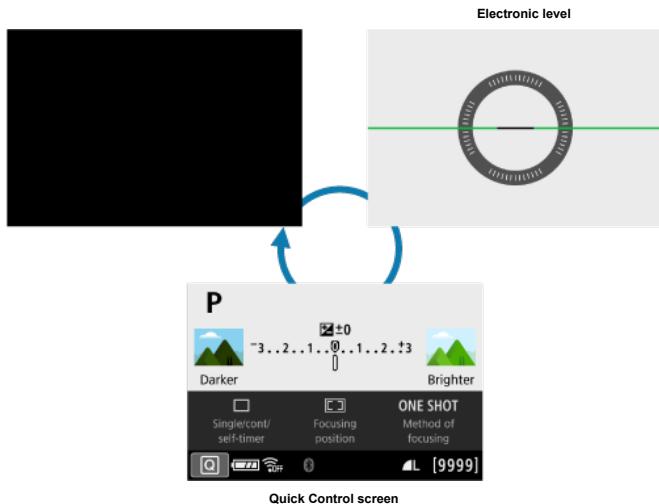

## In Live View shooting

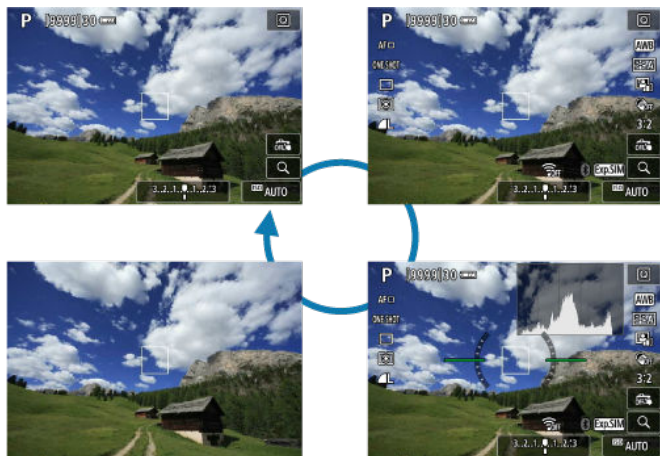

## DISP Button

---

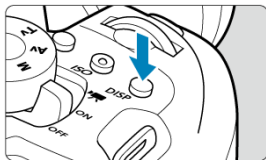

In viewfinder shooting, you can activate and deactivate screen display by pressing the <DISP> button.

# Setting the Screen Display Level

---

- ☑ [Shooting Screen](#)
- ☑ [Menu Display](#)
- ☑ [Shooting Mode Guide](#)
- ☑ [Feature Guide](#)

You can set how information is displayed on the screen according to your preference. Change the settings as necessary.

---

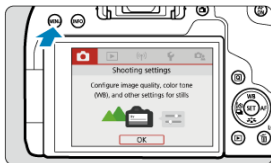

## 1. Display the main tabs.

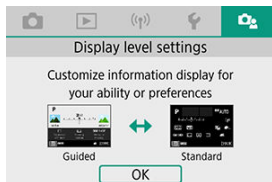

- Press the **< MENU >** button to display the menu screen.

## 2. Select the [📷] tab.



- Turn the **<  >** dial or press **< ◀ > ▶ >** on the **<  >** dial to select the **[📷]** tab, then press **<  >**.



## Shooting Screen

You can select **[Standard]** or **[Guided]** (user-friendly) for the Quick Control screen in viewfinder shooting. By default, it is set to **[Guided]**.

### 1. Select [ : Shooting screen].

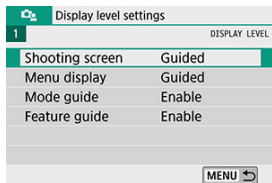

### 2. Select the display type.

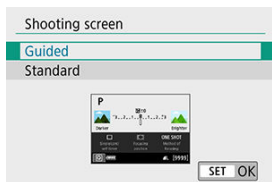

## Sample screens

### < >: Guided

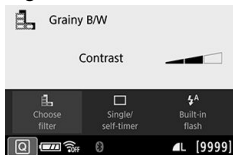

### < >: Standard

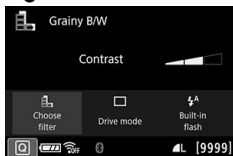

### < **Av** >: Guided



### < **Av** >: Standard

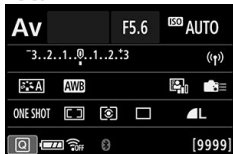

#### Note

- In Creative Zone modes, when **[Guided]** is set, only the functions particular to the set shooting mode are displayed on the Quick Control screen. Note that items that cannot be set from the Quick Control screen when **[Guided]** is selected can be set via the menu screen (.

## Menu Display

You can select the display type from **[Standard]** or **[Guided]**. If you set **[Guided]**, main tab descriptions are provided when you press the <MENU> button. If you set **[Standard]**, you proceed directly to the menu screen when you press the <MENU> button. By default, it is set to **[Guided]**.

### 1. Select [: Menu display].

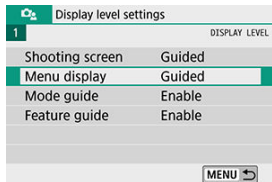

### 2. Select the display type.

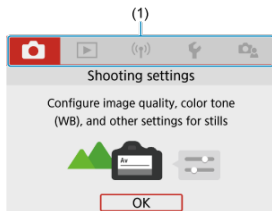
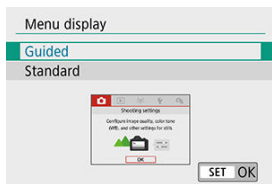

(1) Main tabs



#### Note

- The [★] tab (My Menu tab) is not displayed when [Guided] is set. To set My Menu (🔒), change the menu display level to [Standard].

## Shooting Mode Guide

A brief description of the shooting mode can be displayed when you switch shooting modes. By default, it is set to **[Enable]**.

### 1. Select [Mode guide].

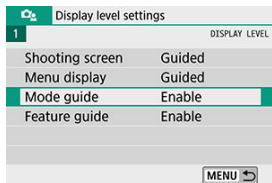

### 2. Select [Enable].

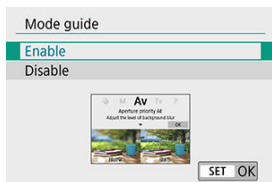

### 3. Turn the Mode dial.

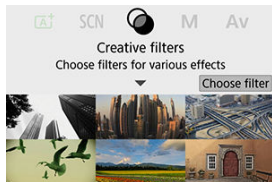

- A description of the selected shooting mode will appear.

#### 4. Press <▼>.

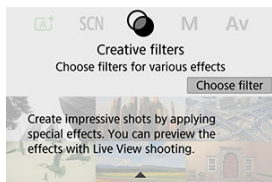

- The rest of the description will appear.
- To clear the mode guide, press <⊙SET>.
- In < **SCN** > or < ⊙ > mode, the shooting mode selection screen is displayed.

## Feature Guide

A brief description of functions and items can be displayed when you use Quick Control or menu settings. By default, it is set to **[Enable]**.

### 1. Select [: Feature guide].

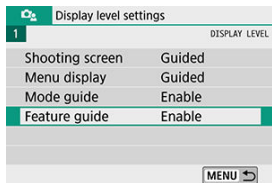

### 2. Select [Enable].

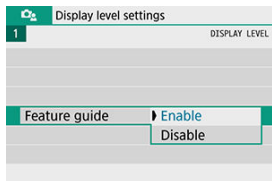

## Sample screens

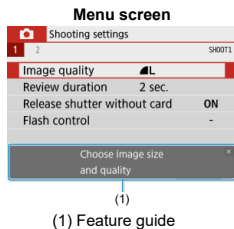
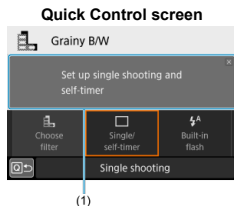



### Note

- To clear a description, either tap it or continue performing operations.



## Shooting tips

With [: **Shooting screen**] set to [**Guided**] () , shooting tips are displayed if the camera anticipates any of the following situations under the current camera settings. In Basic Zone modes, shooting tips appear regardless of the [: **Shooting screen**] setting.

- You want to blur the background further (when you have set the lowest aperture value in < **Av** > mode).
- The image is likely to be overexposed.
- The image is likely to be underexposed.
- Camera shake is likely to occur (only in Basic Zone modes).

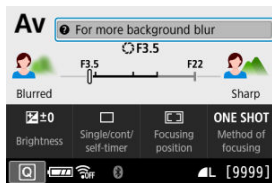

### 1. Tap the area within the frame.

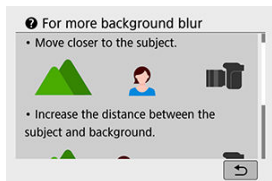

- The shooting tips will appear.

### 2. Check the shooting tips.



- Long tips can be scrolled by tapping on the screen.
- You can also scroll by turning the <  > dial or pressing the <  > <  > keys.

### 3. Tap [↩].

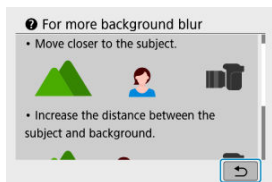

- Shooting tips will disappear, and the screen in step 1 will reappear.
- You can also hide the shooting tips by pressing < (SET) >.

#### ⚠ Caution

- Shooting tips are not displayed when touch operations are disabled.

## Menu Operations and Settings

---

[Menu Screen](#)

[Menu Setting Procedure](#)

[Dimmed Menu Items](#)

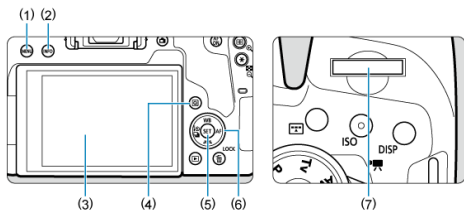

---

(1) < MENU > button

---

(2) < INFO > button

---

(3) Screen

---

(4) < Q > button

---

(5) < SET > button

---

(6) <  > Quick control dial

---

(7) <  > Main dial

---

## Menu Screen

The menu tabs and items displayed vary depending on the shooting mode.

### Basic Zone

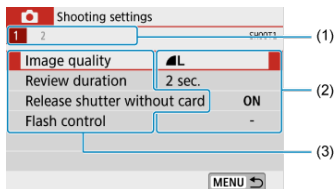

### Movie recording

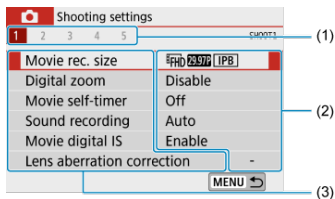

### Creative Zone

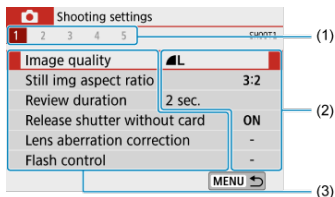

(1) Secondary tabs

(2) Menu settings

(3) Menu items

When set to [📷: Menu display: Guided]

### 1. Display the main tabs.

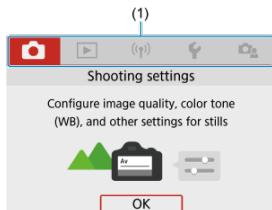

- When you press the < MENU > button, the main tabs (1) and a description of the selected tab will appear.

### 2. Select a main tab.

- Each time you turn the < 🌓 > dial, the main tab (group of functions) will switch.
- You can also switch between main tabs by pressing the < [Q] > or < INFO > button.

### 3. Display the menu screen.

- Press < [SET] > to display the menu screen.
- To return to the main tab screen, press the < MENU > button.

#### 4. Select a secondary tab.

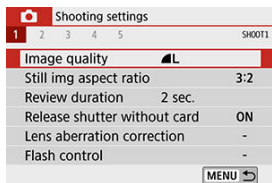

- Turn the <  > dial to select a secondary tab.

#### 5. Select an item.

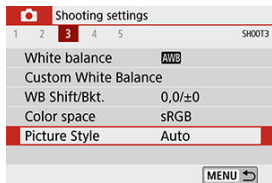

- Turn the <  > dial to select an item, then press <  >.

#### 6. Select an option.

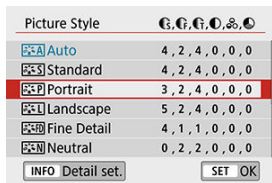

- Turn the <  > dial to select an option.
- The current setting is indicated in blue.

## 7. Set an option.

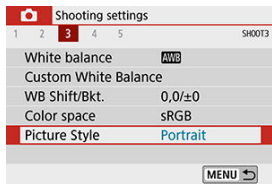

- Press < **SET** > to set it.
- If you change the setting from the default, it will be indicated in blue (available only for the menu items under the **[CAMERA]** tab).

## 8. Exit the setting.

- Press the < **MENU** > button twice to exit the menu and return to shooting standby.

### Note

- The description of menu functions hereafter assumes that the menu screen is displayed.
- Menu operations are also possible by tapping the menu screen or using the < **▲** > < **▼** > < **◀** > < **▶** > keys.
- To cancel the operation, press the < **MENU** > button.

## When set to [📷: Menu display: Standard]

### 1. Display the menu screen.

- Press the < MENU > button to display the menu screen.

### 2. Select a tab.

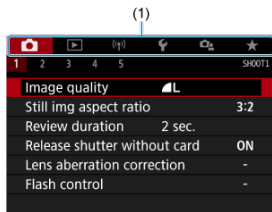

- Each time you press the < [Q] > or < INFO > button, the main tab (1) will switch.
- Turn the < [DIAL] > dial to select a secondary tab.
- After this, operations are the same as when set to [📷: Menu display: Guided]. See [When \[📷: Menu display: Guided\] is Set](#), starting with step 5.
- To exit the setting, press the < MENU > button once.



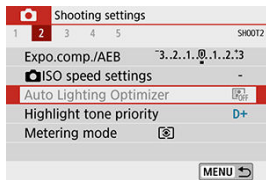

## Dimmed Menu Items

Example: When [Highlight tone priority] has been set

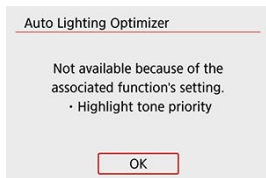

Dimmed menu items cannot be set. The menu item is dimmed if another function setting is overriding it.





You can see the overriding function by selecting the dimmed menu item and pressing <  >.

If you cancel the overriding function's setting, the dimmed menu item will become settable.

### Caution

- You may not be able to see the overriding function for certain dimmed menu items.

### Note

- With [Clear all camera settings] under [: Clear settings], you can reset the menu functions to the default settings ().

## Quick Control

---

- [In Viewfinder Shooting](#)
- [In Live View Shooting/Movie Recording](#)
- [During Playback](#)

You can directly select and set the settings displayed on the screen.

---

### In Viewfinder Shooting

---

1. Press the **< Q >** button (⌚10).

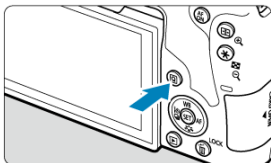

## 2. Select a setting item.

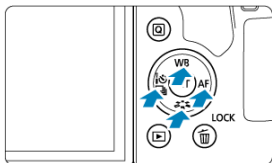

- Press the <▲> <▼> <◀> <▶> keys for selection.

### Creative Zone

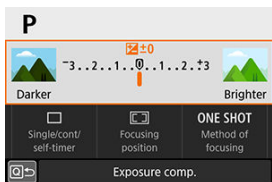

- Press <SET>.
- Some items can be set by turning the <⚙️> or <⌚> dial without pressing <SET>.

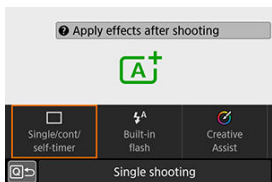

### Basic Zone

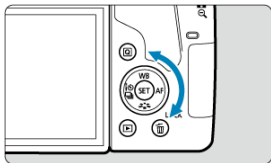
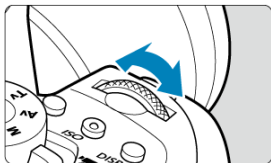

- Press <SET>.
- Some items can be set by turning the <⚙️> or <⌚> dial without pressing <SET>.

### 3. Select an option.



- Turn the <  > or <  > dial to adjust the setting. Some items are set by pressing a button after this.
- Press <  > to return to the previous screen.

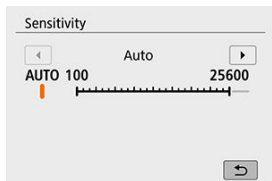

- To access the corresponding setting screen from the Quick Control screen, press the <ISO> button, then adjust the setting by turning the < [ ] > or < [ ] > dial.

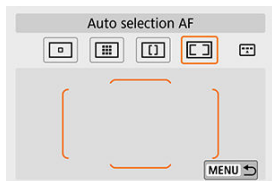

- If you have selected [ [ ] ], press the < [ ] > button to adjust the setting. To exit the setting, press the < MENU > button.

1. Press the **< Q >** button (ⓘ10).
2. Select a setting item.



- Press the **< ▲ >** **< ▼ >** keys for selection.
3. Select an option.
    - Turn the **< [Sun] >** or **< [Globe] >** dial to adjust the setting. Some items are set by pressing a button after this.
    - Press the **< Q >** button to return to the previous screen.

1. Press the **< Q >** button.
2. Select a setting item.

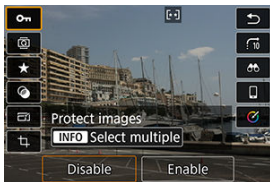





- Press the **< ▲ >** **< ▼ >** keys for selection.

3. Select an option.



- Turn the **< [Sun] >** or **< [Moon] >** dial to adjust the setting. Some items are set by pressing a button after this.
- Configure items labeled with a **[SET]** icon on the bottom of the screen by pressing **< [SET] >**.
- To cancel this operation, press the **< MENU >** button.
- Press the **< Q >** button to return to the previous screen.

### Caution

- For image rotation, set **[⚙: Auto rotate]** to **[On   ]**. When **[⚙: Auto rotate]** is set to **[On ]** or **[Off]**, images will be tagged with your selected **[ Rotate stills]** option but not rotated on the camera.



#### Note

- Pressing the <  > button during index display will switch to single-image display and show the Quick Control screen. Pressing the <  > button again will return to the index display.
- For images from other cameras, available options may be restricted.



# Touch-Screen Operation

☑ [Tapping](#)

☑ [Dragging](#)

## Tapping

### Sample screens (Quick Control)

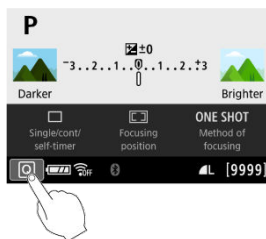

- Use your finger to tap (touch briefly and then remove your finger from) the screen.
- For example, when you tap [Q], the Quick Control screen appears. By tapping [Q↵], you can return to the preceding screen.

#### Note

- If [🔊: Beep] is set to [Touch 🔊], the beep will not sound for touch operations (🔊).
- Responsiveness to touch operations can be adjusted in [🔊: Touch control] (🔊).

## Dragging

---

### Sample screen (Menu screen)

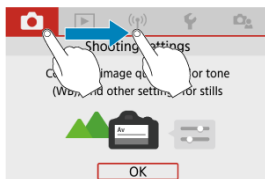

- Slide your finger while touching the screen.

## Viewing the Screen as You Shoot (Live View Shooting)

---

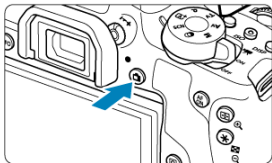

### 1. Display the Live View image.

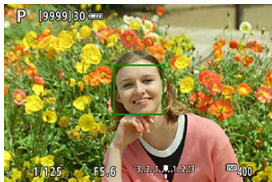

- Press the  button.
- Live View images are displayed nearly as bright as your shots.

### 2. Focus on the subject.





- Press the shutter button halfway to focus.
- If  blinks, manually raise the built-in flash.
- You can also tap the screen to select the face or subject ().

### 3. Take the picture.

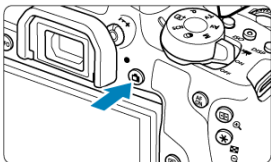

- Press the shutter button completely.



- Press the <  > button to exit Live View shooting.

## Shooting with the Touch Shutter

Just by tapping the screen, you can focus and take the picture automatically.

### 1. Enable the Touch Shutter.

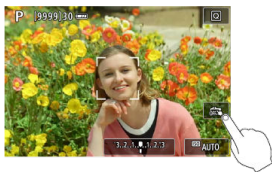



- Tap on the screen's bottom right. Each time you tap the icon, it will toggle between and .
- (Touch Shutter: Enable)  
The camera will focus on the spot you tap on, then the picture will be taken.
- (Touch Shutter: Disable)  
You can tap on a spot to perform focusing on the spot. Press the shutter button completely to take the picture.

### 2. Tap the screen to shoot.





- Tap the face or subject on the screen. On the point you tap, the camera will focus (Touch AF) with the AF method that was set ().
- When is set, the AF point turns green when focus is achieved, then the picture is taken automatically.
- If focus is not achieved, the AF point turns orange and the picture cannot be taken. Tap on the face or subject on the screen again.

### Caution

- The camera shoots in single shooting mode regardless of the drive mode setting.
- Tapping the screen focuses with **[One-Shot AF]** regardless of the AF operation setting.
- Tapping the screen in magnified view will not focus or take the picture.
- Regardless of where you tap with **[Fish-eye effect]** set in <  > mode, the camera focuses using the AF point in the center of the screen.
- Touch Shutter has no effect with **[Miniature effect]** set in <  > mode.
- If you shoot with : **Review duration** set to **[Hold]**, you can press the shutter button halfway to take the next shot.

### Note

- In bulb exposures () , tap once to start exposure and again to stop the bulb exposure. Be careful not to shake the camera when tapping the screen.
- The self-timer lamp () does not blink when the screen is facing toward the front of the camera in **[Self Portrait]** mode.

## Shooting Selfies (Self Portrait)

---

The Self Portrait mode processes the image to suit human subjects. Before shooting, you can also specify background blurring, brightness, and skin smoothing.

---

1. Face the screen toward the front of the camera.

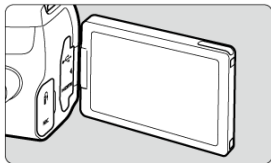

2. Tap  on the screen.



- Tap  on the screen to activate [Self Portrait] mode.

3. Set the Self Portrait settings.



- Tap a function (1) to select it, then set the effect.

## 4. Take the picture.

### When using the Touch Shutter:

- Tap  (2) and set to  (Touch Shutter: Enable) .

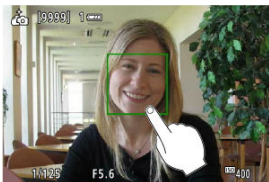

- Tap the spot where you want to focus, then take the picture.



### When using the shutter button:

- Press the shutter button halfway to focus, then press it completely to take the picture.

#### Caution

- After the camera achieves focus, do not change the distance between you and the camera until the picture is taken.
- Be careful not to drop the camera.
- Flash photography is not possible. Try to prevent camera shake when shooting in low-light conditions.

#### Note

- The camera exits **[Self Portrait]** mode when you set the power switch to **< OFF >** or do any of the following operations.
  - Tapping  on the screen.
  - Rotating the screen back to its original position.
  - Pressing the **<  >** button.
- The self-timer lamp  does not blink when the screen is facing toward the front of the camera in **[Self Portrait]** mode.



## Basic Zone

---

This chapter describes how to use the Basic Zone modes on the Mode dial for best results. With Basic Zone modes, all you do is point and shoot, and the camera sets everything automatically.

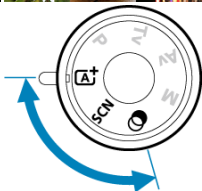
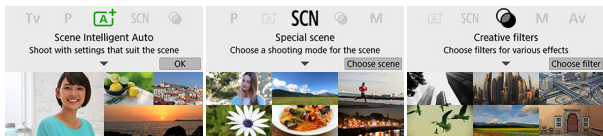

- [Fully Automatic Shooting \(Scene Intelligent Auto\)](#)
- [Special Scene Mode](#)
- [Portrait Mode](#)
- [Smooth Skin Mode](#)
- [Group Photo Mode](#)
- [Landscape Mode](#)
- [Close-up Mode](#)
- [Sports Mode](#)
- [Kids Mode](#)
- [Food Mode](#)
- [Candlelight Mode](#)
- [Night Portrait Mode](#)
- [Handheld Night Scene Mode](#)
- [HDR Backlight Control Mode](#)
- [Creative Filters Mode](#)

# Fully Automatic Shooting (Scene Intelligent Auto)

- ☑ [Recomposing the Shots](#)
- ☑ [Shooting Moving Subjects](#)
- ☑ [Scene Icons](#)
- ☑ [Adjusting Settings](#)
- ☑ [Shooting with Effects Applied \(Creative Assist\)](#)

< **A+** > is a fully automatic mode. The camera analyzes the scene and sets the optimum settings automatically. It can also adjust focus automatically on either the still or moving subject by detecting the motion of the subject (📷).

---

1. Set the Mode dial to < **A+** >.

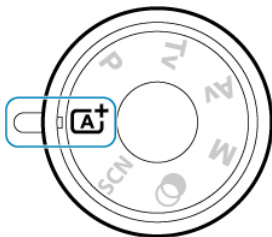

2. Press < **SET** >.

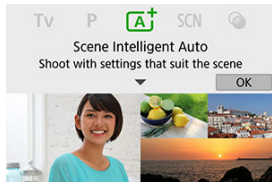

- Read the message and select [OK].

### 3. Aim the camera at what you will shoot (the subject).

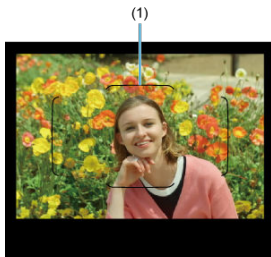

- Essentially, the camera focuses on the closest subject.
- In viewfinder shooting, you can assist with focusing by centering the Area AF frame (1) over the subject.
- In Live View shooting, when a frame (AF point) appears on the screen, aim it over the subject.

## 4. Focus on the subject.

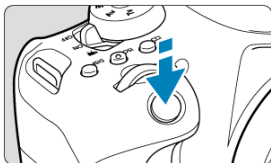

- Press the shutter button halfway to focus.  
If < lightning bolt icon > blinks, manually raise the built-in flash.

### In viewfinder shooting

- When achieving focus, the AF point that has achieved focus will be displayed. At the same time, the beeper will sound and the focus indicator < solid black circle > in the viewfinder will light up. In low light, the AF point(s) will light up briefly in red.
- Under low light, the AF-assist beam (continuous flash) fires automatically as needed when the built-in flash is raised.

### In Live View shooting

- Once the subject is in focus, that AF point turns green and the camera beeps.
- The AF point in focus on a moving subject turns blue and tracks subject movement.

## 5. Take the picture.



- Press the shutter button completely to take the picture.
- The image just captured will be displayed for approx. 2 sec. on the screen.
- To retract the built-in flash, push it down with your fingers.

### ! Caution

- Subject movement (whether subjects are still or moving) may not be detected correctly for some subject or shooting conditions.

### 📄 Note

- The < **A+** > mode makes the colors look more impressive in nature, outdoor, and sunset scenes. If you do not obtain the desired color tones, change the mode to a Creative Zone mode (📷) and select a Picture Style other than [S-A], then shoot again (📷).

## 💡 Minimizing Blurred Photos

- Be careful about camera shake in handheld shots. To avoid camera shake, consider using a tripod. Use a sturdy tripod that can bear the weight of the shooting equipment. Attach the camera securely to the tripod.
- Using a remote switch (sold separately, 📷) or a wireless remote control (sold separately, 📷) is recommended.

## ? FAQ

---

- **Focusing is not possible (indicated by a blinking < ● > in the viewfinder, in viewfinder shooting, or by an orange AF point in Live View shooting).**  
Aim the AF point over an area with good contrast, then press the shutter button halfway (📷). If you are too close to the subject, move away and shoot again.
- **Multiple AF points are displayed simultaneously.**  
Focus has been achieved at all those points.
- **Pressing the shutter button halfway does not focus on the subject.**  
If the focus mode switch on the lens is set to < MF >, set it to < AF >.
- **The shutter speed display is blinking.**  
Since it is too dark, taking the picture may result in a blurred subject due to camera shake. Using a tripod, the built-in flash, or an external flash (📷) is recommended.
- **Pictures are too dark.**  
Raise the built-in flash in advance to enable automatic flash firing, in case subjects in daytime shots are backlit, or when shooting under low light.
- **The built-in flash fired repeatedly when raised while shooting under low light.**  
To make autofocusing easier, the built-in flash may fire repeatedly when you press the shutter button halfway (📷).
- **Pictures taken with flash are too bright.**  
Pictures may be bright (overexposed) if you shoot subjects at close range in flash photography. Move away from the subject and shoot again.
- **The bottom part of pictures taken with flash is unnaturally dark.**  
Shooting subjects that are too close may make the shadow of the lens visible in your shots. Move away from the subject and shoot again. If you are using a lens hood, try removing it before shooting.

 **Note**

Note the following if you are not using the built-in flash.

- Under low light where camera shake tends to occur, the viewfinder's shutter speed display will blink. Hold the camera steady or use a tripod. When using a zoom lens, you can reduce the blur caused by camera shake by setting the lens to the wide-angle end.
- When shooting portraits under low light, tell subjects to stay still until you have finished shooting. Any movement as you shoot will make the person look blurry in the picture.

## Recomposing the Shots



Depending on the scene, positioning the subject toward the left or right to include a balanced background will result in a picture with better perspective. Pressing the shutter button halfway to focus on a still subject will lock the focus on that subject. Recompose the shot while keeping the shutter button pressed halfway, and then press the shutter button completely to take the picture. This is called "focus lock."

 **Note**

- In Live View shooting, the camera continues to focus on any faces initially detected and focused on, even if you recompose the shot.

## Shooting Moving Subjects

---



Pressing the shutter button halfway tracks moving subjects to keep them in focus. Keep the subject in the Area AF frame (in viewfinder shooting) or on the screen (in Live View shooting) as you hold down the shutter button halfway, and at the decisive moment, press the shutter button completely.

## Scene Icons

---



The camera detects the scene type and sets everything automatically to suit the scene. In Live View shooting, an icon representing the type of scene detected appears in the upper left of the screen (👤).



## Adjusting Settings

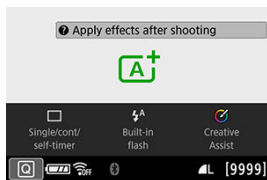

In viewfinder shooting, you can adjust drive mode, built-in flash firing, and Creative Assist settings by pressing the < Q > button.



In Live View shooting, you can adjust built-in flash firing, drive mode, image quality, Touch Shutter, and Creative Assist settings by tapping icons.

## Shooting with Effects Applied (Creative Assist)

1. Press the **< Q >** button.

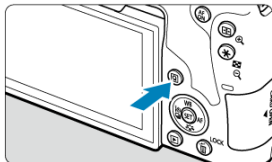

- In viewfinder shooting, use the **< ◀ > ▶ >** keys to select [**Creative Assist**].



### Note

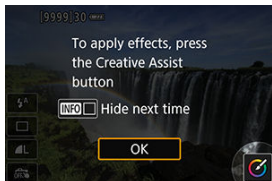

- In viewfinder shooting, you can also press the **< ISO >** button and select [**Creative Assist**].



- In Live View shooting, read the message and select [**OK**].

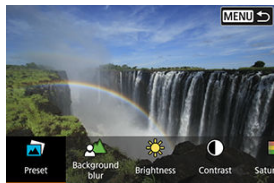



## 2. Select an effect.



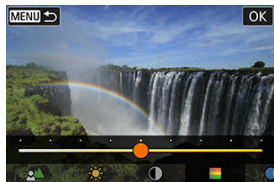







- Use the <  > or <  > dial to select an effect, then press <  >.

## 3. Select the effect level and other details.



- Turn the <  > or <  > dial to set it, then press <  >.
- To reset the setting, press the <  > button, then select [OK].

## Creative Assist effects

-  **Preset**  
Select one of the preset effects.  
Note that **[Saturation]**, **[Color tone 1]**, and **[Color tone 2]** are not available with **[B&W]**.
-  **Background blur**  
Adjust background blur. Choose higher values to make backgrounds sharper. To blur the background, choose lower values. **[Auto]** adjusts background blurring to match the brightness. Depending on lens brightness (f/number), some positions may not be available.
-  **Brightness**  
Adjust image brightness.
-  **Contrast**  
Adjust contrast.
-  **Saturation**  
Adjust the vividness of colors.
-  **Color tone 1**  
Adjust amber/blue color tone.
-  **Color tone 2**  
Adjust green/magenta color tone.
-  **Monochrome**  
Set the toning effect for monochrome shooting.

### Note

- **[Background blur]** is not available when the flash is used.
- These settings are reset when you switch shooting modes or set the power switch to **< OFF >**. To save the settings, set : **Retain Creative Assist data** to **[Enable]**.

## Saving effects

To save the current setting to the camera, press the **< INFO >** button on the **[Creative Assist]** setting screen, then select **[OK]**. Up to three presets can be saved as **[USER\*]**. After three have been saved, an existing **[USER\*]** preset must be overwritten to save a new one.

## Special Scene Mode

---

The camera will automatically choose the appropriate settings when you select a shooting mode for your subject or scene.

\* < **SCN** > stands for Special Scene.

---

1. Set the Mode dial to < **SCN** >.

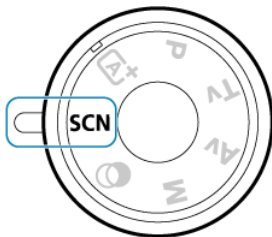

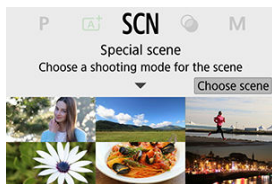

2. Press < **SET** >.



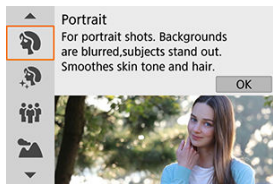





### 3. Select a shooting mode.















- Turn the <  > or <  > dial to select the desired shooting mode, then press <  >.

#### Note

- When [: **Mode guide**] is set to [**Disable**], after step 1, press the <  > button, use the <  > <  > keys to select [**Choose scene**], turn the <  > or <  > dial to select a shooting mode, then press <  >.

## Available Shooting Modes in <SCN> Mode

Shooting Mode			
	<a href="#">Portrait</a>		<a href="#">Kids</a>
	<a href="#">Smooth skin</a>		<a href="#">Food</a>
	<a href="#">Group Photo</a>		<a href="#">Candlelight</a>
	<a href="#">Landscape</a>		<a href="#">Night Portrait</a>
	<a href="#">Close-up</a>		<a href="#">Handheld Night Scene</a>
	<a href="#">Sports</a>		<a href="#">HDR Backlight Control</a>

### Note

- Live View shooting is not available in  mode.

## Portrait Mode

---

The [P] (Portrait) mode blurs the background to make the human subject stand out. It also makes skin tones and hair look softer.

---

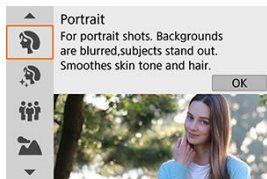

### Shooting tips

---

- **Select the location where the distance between the subject and the background is the farthest.**

The further the distance between the subject and background, the more blurred the background will look. The subject will also stand out better against an uncluttered dark background.

- **Use a telephoto lens.**

If you have a zoom lens, use the telephoto end to fill the frame with the subject from the waist up.

- **Focus on the face.**

As you focus before shooting, make sure that an AF point is displayed on the face (in viewfinder shooting), or that the AF point on the face is green (in Live View shooting).

When shooting close-ups of the face in Live View shooting, you can set [📷: Eye Detection AF] to [Enable] to shoot with the subject's eyes in focus.

- **Shoot continuously.**

The default setting is [📷] (Low speed continuous). If you keep holding down the shutter button, you can shoot continuously to capture changes in the subject's facial expression and pose.



## Smooth Skin Mode

---

Use [  ] (Smooth skin) mode to make skin look more attractive. Image processing makes skin look smoother.

---

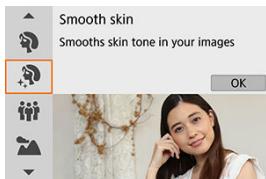

### Shooting tips

---

- **Enable the camera to detect faces.**

Frames are displayed around any main subjects detected for skin smoothing. For more effective skin smoothing, you can move closer to or farther from the subject so that the frame is displayed on the subject's face.

- **Focus on the face.**

As you focus before shooting, make sure that an AF point is displayed on the face (in viewfinder shooting), or that the AF point on the face is green (in Live View shooting).

When shooting close-ups of the face in Live View shooting, you can set [  : Eye Detection AF ] to [Enable] to shoot with the subject's eyes in focus.

#### Caution

- Areas other than people's skin may be modified, depending on the shooting conditions.

## Group Photo Mode

---

Use the  (Group Photo) mode to shoot group photos. You can take a picture in which both the people in the front and people in the back are all in focus.

---

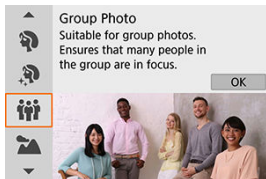

### Shooting tips

---

- **Use a wide-angle lens.**

When using a zoom lens, use the wide-angle end to make it easy to get all the people in the group in focus at once, from the front row to the back. Also, if you place a little distance between the camera and the subjects (so that the subjects' entire bodies are in the shot), the focus range increases in depth.

- **Take multiple shots of the group.**

It is recommended to shoot multiple photos in case some people close their eyes.

#### Caution

- The angle of view changes slightly, due to distortion correction.
- Depending on the shooting conditions, focus may not be attained for everyone from the front to the back of the image.

#### Note

- Using a tripod is recommended when shooting indoors or under low light.

## Landscape Mode

---

Use the [🏞️] (Landscape) mode for expansive scenery or to have everything in focus from near to far. For vivid blues and greens, and sharp and crisp images.

---

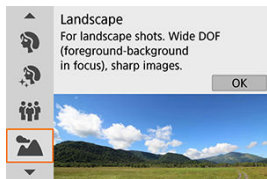

### 💡 Shooting tips

---

- **With a zoom lens, use the wide-angle end.**  
When using a zoom lens, set the lens to the wide-angle end to make the objects near and far in focus. It also adds breadth to landscapes.
- **Keep the camera steady when shooting night scenes.**  
Using a tripod is recommended.

#### ⚠️ Caution

- The built-in flash will not fire, even if it is raised when you shoot.
- Speedlites will not fire either, if used.

## Close-up Mode

---



When you want to shoot flowers or small things up close, use the  (Close-up) mode. To make small things appear much larger, use a macro lens (sold separately).

---



### Shooting tips

---

- **Use a simple background.**  
A simple background makes small objects such as flowers stand out better.
- **Move in as close as possible to the subject.**  
Check the lens for its minimum focusing distance. The lens minimum focusing distance is measured from the <  > (focal plane) mark on the top of the camera to the subject. Focusing is not possible if you are too close.
- **With a zoom lens, use the telephoto end.**  
If you have a zoom lens, using the telephoto end will make the subject look larger.
- **When  blinks**  
Manually raise the built-in flash.

## Sports Mode

---

Use the [🏃] (Sports) mode to shoot a moving subject, such as a running person or a moving vehicle.

---

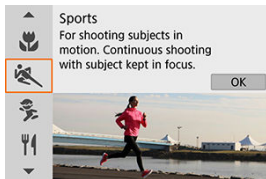

### Shooting tips

---

- **Use a telephoto lens.**

Use of a telephoto lens is recommended to enable shooting from a distance.

- **Track the subject with the Area AF frame.**

In viewfinder shooting, aim the Area AF frame over the subject and press the shutter button halfway to start focusing. During autofocus, the beeper will continue beeping softly. If focus cannot be achieved, the focus indicator < ● > will blink.

In Live View shooting, an Area AF frame appears after you press the shutter button halfway. Once the subject is in focus, the AF point turns blue.

- **Shoot continuously.**

The default setting is [📷H] (High speed continuous). At the decisive moment, press the shutter button completely to take the picture. To track the subject and capture changes as it moves, keep holding down the shutter button to shoot continuously.

#### Caution

- Under low light where camera shake tends to occur, the shutter speed value in the lower left will blink. Hold the camera steady and shoot.
- Using a flash will decrease the continuous shooting speed.

## Kids Mode

To photograph the children running around, use the [👦] (Kids) mode. Skin tones will look healthy.



## Shooting tips

---

- **Track the subject with the Area AF frame.**

In viewfinder shooting, aim the Area AF frame (1) over the subject and press the shutter button halfway to start focusing. During autofocus, the beeper will continue beeping softly. If focus cannot be achieved, the focus indicator < ● > will blink.

In Live View shooting, an Area AF frame (2) appears after you press the shutter button halfway. Once the subject is in focus, the AF point turns blue.

- **Shoot continuously.**

The default setting is [] (High speed continuous). At the decisive moment, press the shutter button completely to take the picture. To track the subject and capture changes in facial expression and movement, keep holding down the shutter button to shoot continuously.

- **When [] blinks**

Manually raise the built-in flash.

### Caution

- Continuous shooting speed is slower when a flash fires during continuous Live View shooting. The camera keeps shooting at the lower continuous shooting speed even after the flash stops firing.

## Food Mode

---

When you want to take pictures of food, use the [🍴] (Food) mode. The photo will look bright and appetizing. Also, the reddish tinge due to the light source will be suppressed in the pictures taken under tungsten lights, etc.

---

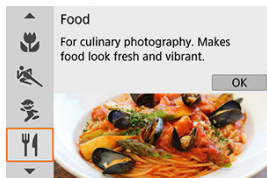

### Shooting tips

---

- **Change the color tone.**

You can change [Color tone]. To increase the food's reddish tinge, set it toward [Warm tone] (red). Set it toward [Cool tone] (blue) if it looks too red.

#### Caution

- The warm color cast of subjects may fade.
- When multiple light sources are included in the scene, the warm color cast of the picture may not be reduced.
- If you use a flash, [Color tone] will be set to default.
- If there are people in the picture, the skin tone may not be reproduced properly.



## Candlelight Mode

When you want to photograph a person in candlelight, use the **[Candlelight]** (Candlelight) mode. The atmosphere of candlelight is reflected in the color tones of the picture.

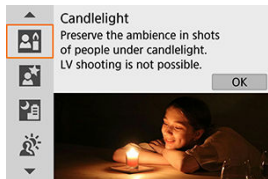

### Shooting tips

- **Use the center AF point to focus.**

Aim the center AF point in the viewfinder on the subject, then shoot.

- **Prevent camera shake if the numeric display (shutter speed) in the viewfinder blinks.**

Under low light where camera shake tends to occur, the viewfinder's shutter speed display will blink. When using a zoom lens, consider zooming out and either holding the camera steady or using a tripod. When using a zoom lens, you can reduce the blur caused by camera shake by setting the lens to the wide-angle end.

- **Change the color tone.**

You can change **[Color tone]**. To increase the candlelight's reddish tinge, set toward **[Warm tone]** (red), or set toward **[Cool tone]** (blue) if it looks too red.

- **Adjust brightness.**

You can change **[Brightness]**. To brighten the image, set toward +, or set toward – if the image is too bright.

#### Caution

- Live View shooting is not possible.
- The flash will not fire. However, raising the flash beforehand is recommended, to enable firing of the AF-assist beam .

#### Note

- The AF method is set to **[1-point AF]** and cannot be changed.

## Night Portrait Mode

When you want to photograph people at night and obtain a natural-looking night scene in the background, use the  (Night Portrait) mode. **Note that shooting in this mode requires the built-in flash or a Speedlite.** Using a tripod is recommended.

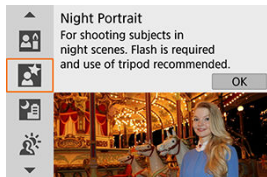

### Shooting tips

- **Use a wide-angle lens and a tripod.**

When using a zoom lens, use the wide-angle end to obtain a wide night view. Because camera shake occurs in handheld shooting, using a tripod is also recommended.

- **Check the image brightness.**

It is recommended to play back the captured image on location to check the image brightness. If the subject looks dark, move nearer and shoot again.

- **Also shoot in other shooting modes.**

Consider also shooting in  and  mode, because shots are more likely to be blurry.

#### Caution

- Tell subjects to remain still for a moment after the flash fires.
- During Live View shooting, achieving focus may be difficult when the face of the subject looks dark. In this case, set the lens's focus mode switch to **<MF>** and focus manually.
- When you shoot a night scene with Live View shooting, achieving focus with AF may be difficult if point sources of light are found in the AF point. In this case, set the lens's focus mode switch to **<MF>** and focus manually.
- The Live View image displayed will not look exactly the same as the actual captured image.



#### Note

- If you use the self-timer together with a flash, the self-timer lamp will light up briefly after the picture is taken.

## Handheld Night Scene Mode

---

The [P] (Handheld Night Scene) mode enables you to shoot night scenes even in handheld shooting. In this shooting mode, four shots are taken consecutively for each picture, and the resulting image with reduced camera shake is recorded.

---

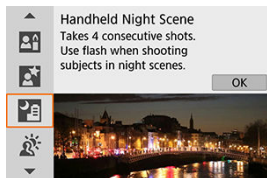

### Shooting tips

---

- **Hold the camera steady.**

Keep your elbows close to your body to hold the camera steady (📷). In this mode, four shots are aligned and merged into a single image, but if there is significant misalignment in any of the four shots due to camera shake, they may not align properly in the final image.

- **For portraits, use flash.**

If your shots will include people, use the built-in flash or a Speedlite. For nicer portraits, flash is used for the first shot. Tell the subject not to move until all four consecutive shots are taken.

## Caution

- Compared to other shooting modes, the image area will be smaller.
- RAW image quality cannot be set.
- When you shoot a night scene with Live View shooting, achieving focus with AF may be difficult if point sources of light are found in the AF point. In this case, set the lens's focus mode switch to **< MF >** and focus manually.
- The Live View image displayed will not look exactly the same as the actual captured image.
- If you use a flash and the subject is close, overexposure may result.
- If you use a flash for a night scene with limited lighting, the shots may not align correctly, which may result in a blurry picture.
- If you use a flash with a human subject close to the background that is also illuminated by the flash, the shots may not align correctly. This may result in a blurry picture. Unnatural shadows and unsuitable colors may also appear.
- Flash coverage angle with a Speedlite:
  - When using a Speedlite with automatic flash coverage setting, the zoom position will be fixed to the wide (wide-angle) end regardless of the lens's zoom position.
  - When using a Speedlite requiring manual flash coverage setting, set the flash head to the normal position.
- If you shoot a moving subject, the subject's movement may leave afterimages or the surrounding area of the subject may become dark.
- The image alignment may not function properly with repetitive patterns (lattice, stripes, etc.), flat or single-tone images, or images significantly misaligned due to camera shake.
- It takes some time to record images to the card since they are merged after shooting. **"buSY"** and **"BUSY"** appear in the viewfinder and on the screen, respectively, as images are processed, and shooting is not possible until processing is finished.

## HDR Backlight Control Mode

When shooting a scene having both the bright and dark areas, use the [HDR] (HDR Backlight Control) mode. When you take one picture in this mode, three consecutive shots are taken at different exposures. This results in one image, with a wide tonal range, that has minimized the clipped shadows caused by backlighting.

\* HDR stands for High Dynamic Range.

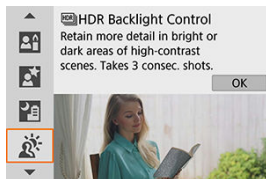

### Shooting tips

#### ● Hold the camera steady.

Keep your elbows close to your body to hold the camera steady (📷). In this mode, three shots are aligned and merged into a single image. However, if there is significant misalignment in any of the three shots due to camera shake, they may not align properly in the final image.

#### ⚠ Caution

- Compared to other shooting modes, the image area will be smaller.
- RAW image quality cannot be set.
- Flash photography is not possible.
- Note that the image may not be rendered with a smooth gradation and may look irregular or have significant noise.
- HDR Backlight Control may not be effective for excessively backlit scenes or extremely high-contrast scenes.
- When shooting subjects that are sufficiently bright as they are, for example for normally lit scenes, the image may look unnatural due to the HDR effect.
- If you shoot a moving subject, the subject's movement may leave afterimages or the surrounding area of the subject may become dark.
- The image alignment may not function properly with repetitive patterns (lattice, stripes, etc.), flat or single-tone images, or images significantly misaligned due to camera shake.
- It takes some time to record images to the card since they are merged after shooting. "buSY" and "BUSY" appear in the viewfinder and on the screen, respectively, as images are processed, and shooting is not possible until processing is finished.

## Creative Filters Mode

---

[Creative Filter Characteristics](#)

[Adjusting the Miniature Effect](#)

You can shoot with filter effects applied. In Live View shooting, you can preview filter effects before shooting.

---

1. Set the Mode dial to <img alt="Creative Filter Mode icon" data-bbox="445 285 475 305"/>.

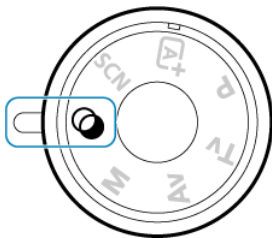

2. Display the Live View image.



- Press the <img alt="Live View button icon" data-bbox="385 760 405 780"/> button to display the Live View image.

### 3. Select [Creative filters] with Quick Control.

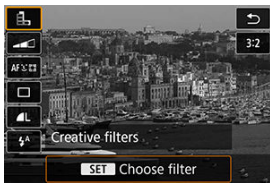

- Press the < Q > button (⌚10).
- Use the < ▲ > < ▼ > keys to select the icon in the upper left, then press < SET >.

### 4. Select a filter effect.

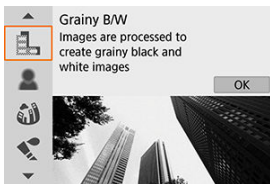

- Turn the < [Filter icon] > or < [Filter icon] > dial to select a filter effect (⌚11), then press < SET >.
- The image is shown with the filter effect applied.









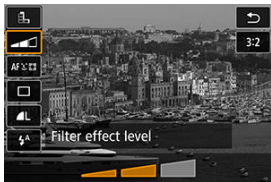

#### Note

- If you do not want the Live View image to be displayed when setting functions, press the < Q > button after step 1 and select [Choose filter].









## 5. Adjust the effect and shoot.



- Press the < **Q** > button and select an icon below [**Creative filters**] (except , , , , or ).
- Turn the <  > or <  > dial to adjust the effect, then press < **SET** >.

### Caution









- RAW and RAW+JPEG are not available. When RAW image quality is set, images are captured with  image quality. When RAW+JPEG image quality is set, images are captured with the specified JPEG image quality.
- Continuous shooting is not available when [, , , , , or ] is set.

### Note

#### In Live View shooting

- With Grainy B/W, the grainy preview will differ somewhat from the appearance of your shots.
- With Soft focus or Miniature effect options, the soft focus preview may differ somewhat from the appearance of your shots.
- No histogram is displayed.
- A magnified view is not available.
- In Live View shooting in Creative Zone modes, some Creative filter settings are available from the Quick Control screen.





## Creative Filter Characteristics

-  **Grainy B/W**  
Makes the image grainy and black and white. By adjusting the contrast, you can change the black-and-white effect.
-  **Soft focus**  
Gives the image a soft look. By adjusting the blur, you can change the degree of softness.
-  **Fish-eye effect**  
Gives the effect of a fish-eye lens. The image will have barrel distortion. Depending on the level of this filter effect, the area trimmed along the periphery of the image changes. Also, because this filter effect magnifies the center of the image, the apparent resolution at the center may degrade depending on the number of recorded pixels, so set the filter effect while checking the resulting image. One AF point is used, fixed at the center.
-  **Water painting effect**  
Makes the photo look like a watercolor painting with soft colors. By adjusting the effect, you can change the color density. Note that night scenes or dark scenes may not be rendered with a smooth gradation and may look irregular or have significant noise.
-  **Toy camera effect**  
Shifts colors to those typical of toy cameras and darkens the four corners of the image. Color tone options can be used to change the color cast.
-  **Miniature effect**  
Creates a diorama effect.  
Shooting under the default setting will keep the center looking sharp.  
In Live View shooting, you can move the area that looks sharp (the scene frame) as described in [Miniature Effect Operations](#). [**1-point AF**] is used as the AF method. Shooting with the AF point and scene frame aligned is recommended.  
In viewfinder shooting, aim the center AF point shown in the viewfinder on the subject, then shoot.
-  **HDR art standard**  
Photos retain more detail in highlights and shadows. With reduced contrast and flatter gradation, the finish resembles a painting. The subject outlines will have bright (or dark) edges.
-  **HDR art vivid**  
The colors are more saturated than with [**HDR art standard**], and the low contrast and flat gradation create a graphic art effect.
-  **HDR art bold**  
The colors are the most saturated, making the subject pop out, and the picture looks like an oil painting.

●  **HDR art embossed**









The color saturation, brightness, contrast and gradation are decreased to make the picture look flat, so that the picture looks faded and old. The subject outlines will have bright (or dark) edges.

 **Caution**

    **precautions**

- Compared to other shooting modes, the image area will be smaller.
- Live View previews of the filter effects will not look exactly the same as your shots.
- If you shoot a moving subject, the subject's movement may leave afterimages, or the surrounding area of the subject may become dark.
- The image alignment may not function properly with repetitive patterns (lattice, stripes, etc.), flat or single-tone images, or images significantly misaligned due to camera shake.
- Be careful about camera shake in handheld shots.
- Subjects such as the sky or white walls may not be rendered with smooth gradation and may have noise or irregular exposure or colors.
- Shooting under fluorescent or LED lighting may result in unnatural color reproduction of the illuminated areas.
- It takes some time to record images to the card since they are merged after shooting. "buSY" and "BUSY" appear in the viewfinder and on the screen, respectively, as images are processed, and shooting is not possible until processing is finished.
- Flash photography is not possible. However, raising the flash beforehand is recommended, to enable firing of the AF-assist beam ().

 **Note**

- With    , you can shoot high dynamic range photos that retain detail in highlights and shadows of high-contrast scenes. Three consecutive images are captured at different brightnesses each time you shoot and used to create a single image. See the precautions for    .









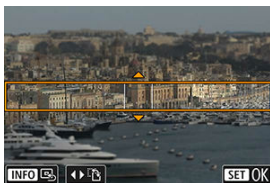

### 1. Move the AF point.



- Move the AF point to the position to focus on.

### 2. Move the scene frame and shoot.



- Move the scene frame if the AF point is outside of it, so that the AF point is aligned with it.
- To make the scene frame movable (displayed in orange), press the  button or tap  in the lower right of the screen. By tapping , you can also switch between vertical and horizontal scene frame orientation. Switching scene frame orientation is also possible with the   keys when in horizontal orientation and   keys when in vertical orientation.
- Turn the  or  dial to move the scene frame. To center the scene frame again, press the  button.
- To confirm the position of the scene frame, press .

## Creative Zone

Creative Zone modes give you the freedom to shoot in a variety of ways by setting your preferred shutter speed, aperture value, exposure, and more.

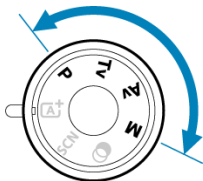

- To clear the shooting mode description displayed when you turn the Mode dial, press <SET> (☑).

### Note

- Make sure the Multi-function lock feature is off (☑).

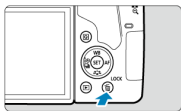

- [Program AE Mode \(P\)](#)
- [Shutter-Priority AE Mode \(Tv\)](#)
- [Aperture-Priority AE Mode \(Av\)](#)
- [Manual Exposure Mode \(M\)](#)
- [Long \(Bulb\) Exposures](#)
- [Mirror Lockup](#)

## Program AE Mode (P)

---

The camera automatically sets the shutter speed and aperture value to suit the subject's brightness.

\* <P> stands for Program.

\* AE stands for Auto Exposure.

---

1. Set the Mode dial to <P>.

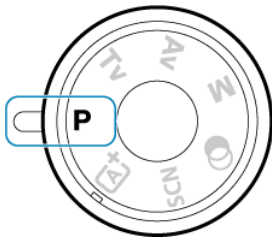

2. Focus on the subject.

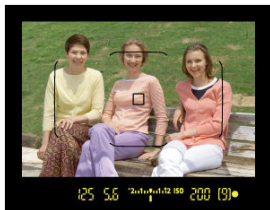

- As you look through the viewfinder, aim the AF point over the subject, then press the shutter button halfway.
- After the camera focuses, the focus indicator <●> in the lower right of the viewfinder lights up (in One-Shot AF mode).
- The shutter speed and aperture value will be set automatically and displayed in the viewfinder.

### 3. Check the display.



- Standard exposure is available unless the shutter speed and aperture value are blinking.

### 4. Take the picture.

- Compose the shot and press the shutter button completely.

#### Caution



- If the "30" shutter speed and the lowest f/number blink, it indicates underexposure. Increase the ISO speed or use flash.



- If the "4000" shutter speed and the highest f/number blink, it indicates overexposure. Lower the ISO speed or use an ND filter (sold separately) to reduce the amount of light entering the lens.

 **Note****Differences between <P> and <A+> modes**

- In <A+> mode, many functions, such as the AF method and metering mode, are set automatically to prevent spoiled shots. The functions you can set are limited. On the other hand, with <P> mode, only the shutter speed and aperture value are set automatically. You can freely set the AF method, metering mode, and other functions.

**Program shift**

- With Program AE, you can freely change the combination (program) of shutter speed and aperture value set by the camera while maintaining the same exposure. This is called Program shift.
- With Program shift, you can press the shutter button halfway, then turn the <PROGRAM> dial until the desired shutter speed or aperture value is displayed.
- Program shift is canceled automatically after the picture is taken.
- Program shift cannot be used with flash.



## Shutter-Priority AE Mode (Tv)

---

In this mode, you set the shutter speed and the camera automatically sets the aperture value to obtain the standard exposure matching the brightness of the subject. A faster shutter speed can freeze the action of a moving subject. A slower shutter speed can create a blurred effect, giving the impression of motion.

\* < **Tv** > stands for Time value.



Blurred motion  
(Slow shutter speed: 1/30 sec.)



Frozen motion  
(Fast shutter speed: 1/2000 sec.)

- 
1. Set the Mode dial to < **Tv** >.

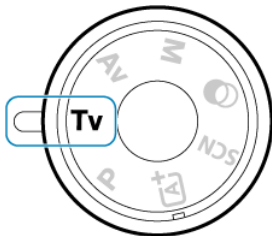

## 2. Set the desired shutter speed.

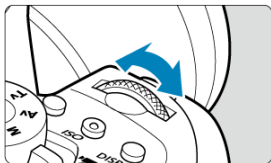

- Set with the <  > dial.

## 3. Focus on the subject.

- Press the shutter button halfway.

## 4. Check the display and shoot.

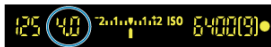

- As long as the aperture value is not blinking, the standard exposure will be obtained.

### Caution



- If the lowest aperture value blinks, it indicates underexposure.  
Turn the <  > dial to set a slower shutter speed until the aperture value stops blinking or set a higher ISO speed.



- If the highest aperture value blinks, it indicates overexposure.  
Turn the <  > dial to set a faster shutter speed until the aperture value stops blinking, or set a lower ISO speed.



## Note

### Shutter speed display

- Shutter speeds are indicated on the screen as a fraction but abbreviated in the viewfinder, where only the denominator is indicated. For example, "125" in the viewfinder stands for 1/125 sec. Additionally, "0"5" indicates 0.5 sec. and "15", 15 sec.

## Aperture-Priority AE Mode (Av)

---

In this mode, you set the desired aperture value and the camera sets the shutter speed automatically to obtain the standard exposure matching the subject brightness. A higher f/number (smaller aperture hole) will make more of the foreground and background fall within acceptable focus. On the other hand, a lower f/number (larger aperture hole) will make less of the foreground and background fall within acceptable focus.

\* < **Av** > stands for Aperture value (aperture opening).

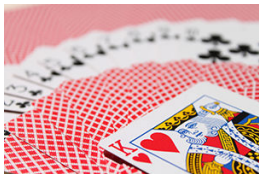

Blurred background  
(With a low aperture f/number: f/5.6)



Sharp foreground and background  
(With a high aperture f/number: f/32)

1. Set the Mode dial to <Av>.

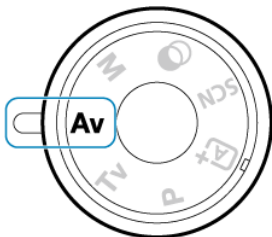

2. Set the desired aperture value.

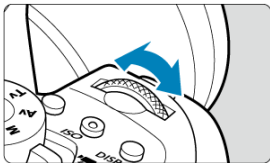

- Set with the < aperture > dial.

3. Focus on the subject.

- Press the shutter button halfway.

4. Check the display and shoot.

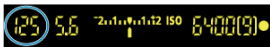

- As long as the shutter speed is not blinking, the standard exposure will be obtained.

 Caution



- If the "30" shutter speed blinks, it indicates underexposure. Turn the <  > dial to decrease the aperture value (open the aperture) until the shutter speed blinking stops or set a higher ISO speed.



- If the "4000" shutter speed blinks, it indicates overexposure. Turn the <  > dial to increase aperture value (close the aperture) until the shutter speed blinking stops or set a lower ISO speed.

 Note

**Aperture value display**

- The higher the f/number, the smaller the aperture opening will be. The f/number displayed varies depending on the lens. If no lens is attached to the camera, "00" will be displayed for the aperture.

## Depth-of-Field Preview

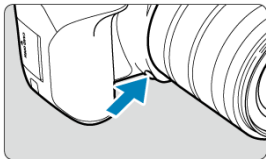

Press the depth-of-field preview button to stop down the lens to the current aperture value and check the area in focus (depth of field).



### Note

- The larger the aperture value, the wider the area (from the foreground to the background) in focus, but the darker the viewfinder display.
- The depth-of-field effect is readily apparent on the Live View image as you change the aperture value and press the depth-of-field preview button (📷).
- Exposure is locked (AE lock) as you hold down the depth-of-field preview button.

## Manual Exposure Mode (M)

---

In this mode, you set both the shutter speed and aperture value as desired. To determine the exposure, refer to the exposure level indicator in the viewfinder or use a commercially available exposure meter.

\* <M> stands for Manual.

---

1. Set the Mode dial to <M>.

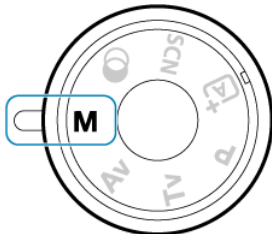



2. Set the ISO speed.

- With ISO Auto, you can set exposure compensation (☑).

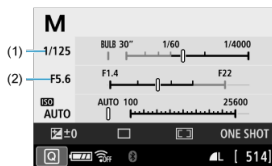
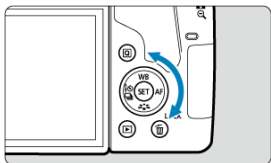
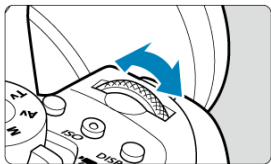

### 3. Set the shutter speed and aperture value.



- To set the shutter speed (1), turn the <  > dial, and to set the aperture value (2), turn the <  > dial.

## 4. Focus on the subject.

- Press the shutter button halfway.

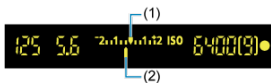

- (1) Standard exposure index  
(2) Exposure level mark

- The exposure setting will be displayed in the viewfinder.
- Check the exposure level mark <█> to see how far the current exposure level is from the standard exposure level.

## 5. Set the exposure and take the picture.

- Check the exposure level indicator and set the desired shutter speed and aperture value.
- <◀> or <▶> is shown at the ends of the exposure level indicator if the exposure level exceeds  $\pm 3$  stops (or in the viewfinder,  $\pm 2$  stops) from standard exposure.

## Exposure Compensation with ISO Auto

If the ISO speed is set to "A" (AUTO) for manual exposure shooting, you can set exposure compensation (☑) as follows:

- [📷: **Expo.comp./AEB**]
- By holding down <SET> and turning the <☀> dial when [SET] in the [13: **Custom Controls**] setting of [🔧: **Custom Functions(C.Fn)**] is set to [☑] **Expo comp (hold btn, turn ☀)**.
- Quick Control screen

### ! Caution

- Exposure may not be as expected when ISO Auto is set, because the ISO speed is adjusted to ensure standard exposure for your specified shutter speed and aperture value. In this case, set the exposure compensation.
- Exposure compensation is not applied in flash photography with ISO Auto, even if you have set an exposure compensation amount.

### 📄 Note

- To enable Auto Lighting Optimizer to be specified in <M> mode as well, clear the [✓] mark for [Disable during man expo] in [📷: **Auto Lighting Optimizer**] (☑).
- When ISO Auto is set, you can press the <✳> button to lock the ISO speed.
- If you press the <✳> button and recompose the shot, you can see the exposure level difference on the exposure level indicator compared to when the <✳> button was pressed.
- Any existing exposure compensation amount is maintained if you switch to <M> mode with ISO Auto after using exposure compensation in <P>, <Tv>, or <Av> mode (☑).
- To coordinate exposure compensation in 1/2-stop increments with ISO speed set in 1/3-stop increments when [1: **Exposure level increments**] in [🔧: **Custom Functions(C.Fn)**] is set to [1:1/2-stop] and used with ISO Auto, exposure compensation is further adjusted by adjusting shutter speed. However, the shutter speed displayed will not change.

## Long (Bulb) Exposures

---

In this mode, the shutter stays open as long as you hold down the shutter button completely, and closes when you let go of the shutter button. Use bulb exposures for night scenes, fireworks, astrophotography, and other subjects requiring long exposures.

---

1. Set the Mode dial to **<M>**.

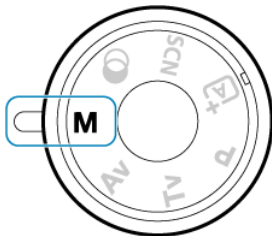

2. Set the shutter speed to **[BULB]**.

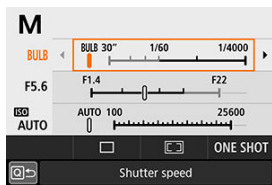

- Turn the **<  >** dial to the left to set **[BULB]**.

3. Take the picture.

- The exposure will continue for as long as you keep the shutter button pressed completely.
- The elapsed exposure time will be displayed on the screen.

## Caution

- Do not point the camera toward an intense light source, such as the sun or an intense artificial light source. Doing so may damage the image sensor or the camera's internal components.
- Long bulb exposures produce more noise in the image than usual.
- If ISO Auto is set, ISO 400 will be set (🔗).
- When shooting bulb exposures with both the self-timer and mirror lockup, keep pressing the shutter button completely until shooting is finished (when the self-timer and bulb exposure time have elapsed). No shot will be taken if you release the shutter button during self-timer countdown, although a shutter-release sound will be played.

## Note

- With [: **Long exp. noise reduction**], you can reduce the noise generated during long exposures (🔗).
- Using a tripod is recommended for bulb exposures. You can also use mirror lockup (🔗).
- You can shoot bulb exposures by using Remote Switch RS-60E3 (sold separately, 🔗).
- You can also shoot bulb exposures by using Wireless Remote Control BR-E1 (sold separately, 🔗). When you press the remote controller's release (transmit) button, the bulb exposure will start immediately or 2 sec. later. Press the button again to stop the bulb exposure.

# Mirror Lockup

---

You can use the mirror lockup function to prevent the disturbing mechanical vibrations (mirror shock) when shooting with super telephoto lenses or shooting close-ups (macro photography).

---

## 1. Configure the mirror lockup setting.

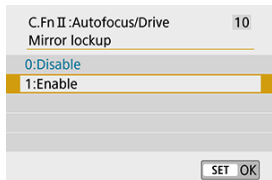

- Set [10: Mirror lockup] in [C.Fn: Custom Functions(C.Fn)] to [1:Enable] (☑).

## 2. Focus on the subject, then press the shutter button completely.



- The mirror will swing up.

## 3. Press the shutter button completely again.

- The picture is taken and the mirror goes back down.
- After taking the picture, set [Mirror lockup] to [0:Disable].

## Shooting tips

- **Also set the self-timer to [Ⓢ10] or [Ⓢ2].**

When you press the shutter button completely, the mirror locks up. The picture will be then taken 10 sec. or 2 sec. later.

- **Shoot remotely.**

Since you do not touch the camera when the picture is taken, remote control shooting together with mirror lockup can further reduce the camera vibration blur (📷).

With Wireless Remote Control BR-E1 (sold separately) set to the 2 sec. delay, press the release button to lock up the mirror, and the picture will be taken 2 sec. after the mirror lockup.

With Remote Switch RS-60E3 (sold separately), press the release button completely to lock up the mirror, and press it completely again to take the picture.

### Caution

- Do not point the camera toward an intense light source, such as the sun or an intense artificial light source. Doing so may damage the image sensor or the camera's internal components.
- In very bright light, such as at the beach or a ski slope on a sunny day, take the picture promptly after mirror lockup is stabilized.
- When shooting with mirror lockup, if you use both the self-timer and bulb exposures, keep pressing the shutter button completely (for self-timer delay time + bulb exposure time). No shot will be taken if you release the shutter button during self-timer countdown, although a shutter-release sound will be played.
- During mirror lockup, shooting function settings, menu operations, etc. are disabled.
- When you use flash, the red-eye reduction lamp will not light up.

### Note

- Even if you set the drive mode to [📷H], [📷], or [ⓈC], the camera will still shoot in the single shooting mode.
- When [📷: High ISO speed NR] is set to [Multi Shot Noise Reduction], four consecutive shots will be taken for a single picture regardless of the [Mirror lockup] setting.
- If approx. 30 sec. elapse after the mirror has locked up, it will go back down automatically. Pressing the shutter button completely locks up the mirror again.
- When shooting with mirror lockup, using a tripod and Wireless Remote Control BR-E1 (sold separately, 📷) or Remote Switch RS-60E3 (sold separately, 📷) is recommended.

## AF, Drive, and Exposure Settings

---

This chapter describes how to configure AF, drive mode, metering mode, and related settings.

### Caution

- < AF > stands for autofocus. < MF > stands for manual focus.

- [AF Operation](#)
- [Selecting the AF Area and AF Point \(Viewfinder Shooting\)](#)
- [Selecting the AF Methods \(Live View Shooting\)](#)
- [Manual Focus](#)
- [Drive Mode](#)
- [Using the Self-Timer](#)
- [Remote Control Shooting](#)
- [Metering Mode](#) ☆
- [Exposure Compensation](#) ☆
- [Exposure Lock \(AE Lock\)](#) ☆



## AF Operation

---

- ☑ [One-Shot AF for Still Subjects](#) ☆
- ☑ [AI Servo AF \(Viewfinder Shooting\) or Servo AF \(Live View Shooting\) for Moving Subjects](#)
- ☑ [AI Focus AF \(Viewfinder Shooting\) for Automatic Switching of AF Operation](#)
- ☑ [AF-Assist Beam](#)
- ☑ [AF Points Lighting Up in Red \(Viewfinder Shooting\)](#)

You can select the AF operation characteristics to suit the shooting conditions or subject. In Basic Zone modes, the optimum AF operation is set automatically for the respective shooting mode.

---

1. Set the lens's focus mode switch to <AF>.

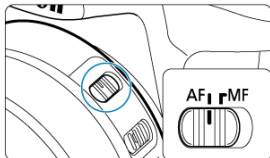

2. Turn the Mode dial to a Creative Zone.

3. Press the <AF> button.

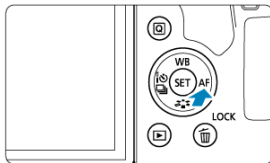

#### 4. Select the AF operation.

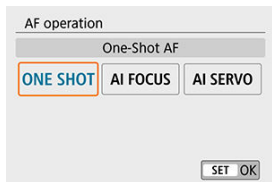

- Press the <◀▶>> keys.

**ONE SHOT:** One-Shot AF

**AI FOCUS:** AI Focus AF

**AI SERVO:** AI Servo AF

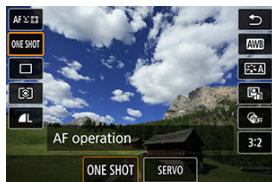

- In Live View shooting, press the <Q> button, then select [AF operation].

**ONE SHOT:** One-Shot AF

**SERVO:** Servo AF

#### Note

- AF is also possible by pressing the <AF ON> button.

This AF operation is suited for still subjects. When you press the shutter button halfway, the camera will focus only once.

### ● Viewfinder shooting

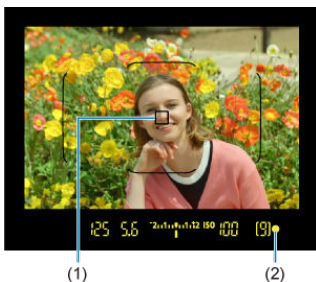

- Once a subject is in focus, the focusing AF point (1) is displayed, the focus indicator < ● > (2) in the viewfinder lights up, and the camera beeps. The focus indicator < ● > blinks if the camera cannot focus.
- With evaluative metering (☑), the exposure value is set as soon as a subject is in focus.

### ● Live View shooting

- Once a subject is in focus, the focusing AF point turns green and the camera beeps. If focus is not achieved, the AF point will turn orange.

#### Note

- If [🔊: Beep] is set to [Disable], the beeper will not sound when focus is achieved.
- The focus remains locked while you hold down the shutter button halfway, allowing you to recompose the image before taking the picture. This is called "focus lock."
- See [Lens Electronic MF](#) when using a lens that supports electronic manual focusing.

## AI Servo AF (Viewfinder Shooting) or Servo AF (Live View Shooting) for Moving Subjects

---

This AF operation is suited for moving subjects. While you hold down the shutter button halfway, the camera will keep focusing on the subject continuously.

### ● AI Servo AF (viewfinder shooting)

- Once a subject is in focus, the focusing AF point is displayed. The focus indicator < ● > in the viewfinder does not light up when subjects are in focus.

### ● Servo AF (Live View shooting)

- Once a subject is in focus, the focusing AF point turns blue.



#### Note

- The beeper will not sound even when focus is achieved.
- The exposure is set at the moment the picture is taken.

## AI Focus AF (Viewfinder Shooting) for Automatic Switching of AF Operation

AF operation automatically switches from [One-Shot AF] to [AI Servo AF] based on subject status.

- After the camera uses [One-Shot AF] to focus on a subject, if it detects subject movement, a change in distance, or similar changes, it switches to [AI Servo AF] and continues to track the moving subject.



### Note

- The camera continues beeping quietly when subjects are in focus using the servo.
- The focus indicator < ● > in the viewfinder does not light up when subjects are in focus using the servo.
- Shooting with the focus locked is not possible when the servo is used.
- In <  > mode in Live View shooting, [AI Focus AF] is used to focus. Note that [Servo AF] is used to focus on moving subjects. When focus is achieved, the AF point will turn blue. Note that the camera does not switch to [Servo AF] if the subject moves during continuous shooting.

## AF-Assist Beam

---

In viewfinder shooting, the built-in flash or a Speedlite can emit an AF-assist beam to make autofocus easier under low light or in other conditions where autofocus is difficult.

- With the built-in flash, the AF-assist beam fires as needed after you raise the flash and press the shutter button halfway.
- With a Speedlite, configure the setting on the Speedlite as needed.

### Caution

- The flash does not emit an AF-assist beam when AF operation is set to **[AI Servo AF]**.

### Note

- To disable AF-assist beam firing, set : **AF-assist beam firing** to **[Disable]**.

## AF Points Lighting Up in Red (Viewfinder Shooting)

---

The AF points light up in red when focus is achieved in low-light conditions or on a dark subject. You can disable lighting up in Creative Zone modes ([☑](#)).

## Selecting the AF Area and AF Point (Viewfinder Shooting)

---

- [AF Area Selection Mode](#)
- [Selecting the AF Area Selection Mode](#)
- [Selecting the AF Point or Zone Manually](#)
- [Meaning of Lit or Blinking AF Points](#)
- [Shooting Conditions That Make Focusing Difficult](#)

The number of available AF points, the focusing patterns, and the Area AF frame shape vary by lens. For details, refer to [Compatible Lenses and Autofocusing \(Viewfinder Shooting\)](#).

---

### AF Area Selection Mode

---

Four AF area selection modes are available. For instructions on choosing a mode, see [Selecting the AF Area Selection Mode](#).

#### Manual selection: 1 pt AF

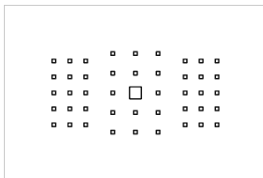

The camera focuses using a single AF point.



## Manual select.:Zone AF

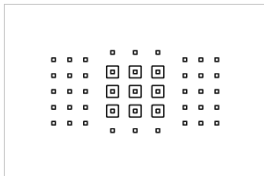

- The camera focuses in a zone consisting of nine AF points. Subjects are easier to acquire than with 1-point AF.
- Generally focuses on the nearest subject. Note that any detected faces are given priority in focusing.
- With [**AI Servo AF**], focusing continues as long as subjects can be tracked within the zone.

## Manual select.:Large Zone AF

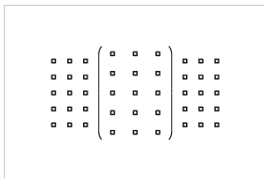

- The AF area is divided into three focusing zones (left, center, and right) for focusing.
- Subjects are easier to acquire than with Zone AF.
- Generally focuses on the nearest subject. Note that any detected faces are given priority in focusing.
- With [**AI Servo AF**], focusing continues as long as subjects can be tracked within the large zone.

## Auto selection AF

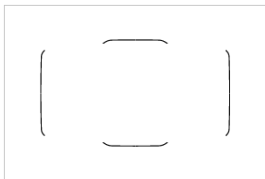



- The Area AF frame (entire AF area) is used to focus.
- With [**One-Shot AF**], generally focuses on the nearest subject. Note that any detected faces are given priority in focusing.
- With [**AI Servo AF**], focusing continues as long as the Area AF frame can track the subject.

### Caution

- AF points may not track subjects under some shooting conditions when [**AI Servo AF**] is used with [**Manual select.:Zone AF**], [**Manual select.:Large Zone AF**], or [**Auto selection AF**].
- Focusing may be difficult when using a peripheral AF point or a wide-angle or telephoto lens. In such a case, use the center AF point or an AF point close to the center.
- When the AF point(s) light up, part or all of the viewfinder may light up in red, which is a characteristic of AF point display.
- In low temperatures, the AF point display may be difficult to see or have a slower tracking response due to the nature of the AF point display device (using liquid crystal).

## Selecting the AF Area Selection Mode

1. Press the  or  button (Ⓞ6).

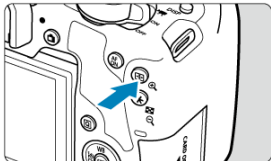



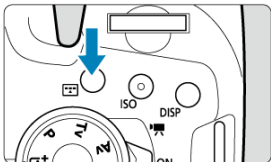



2. Press the  button.





- Each time you press the  button, the AF area selection mode changes.

### Note

- The AF area selection mode can be selected in Creative Zone modes by pressing the  or  button, then turning the  dial when [7: **AF area selection method**] in [ **Custom Functions(C.Fn)**] is set to [1:→**Main Dial**] ().

## Selecting the AF Point or Zone Manually

1. Press the  or  button (Ⓔ6).

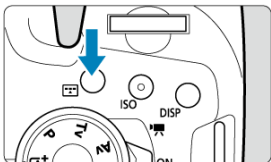
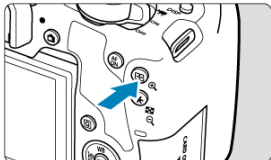

## 2. Select an AF point or zone.

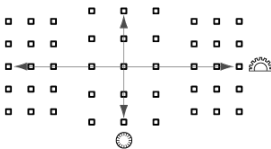
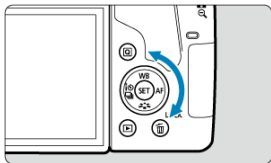
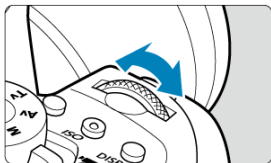



- To select AF points horizontally and vertically, you can turn the < gear > dial and < dial > dial, respectively.
- Turning the < gear > or < dial > dial switches zones (or cycles through Zone AF zones) in Zone AF and Large Zone AF modes.

### Note

- When you keep holding down the < Q > button and turn the < gear > dial, you can select an AF point vertically.
- The following information is displayed in the viewfinder when you press the < AF-ON > or < AF-ON > button.
  - Manual select.:Zone AF, Manual select.:Large Zone AF, Auto selection AF:  
[ ] AF
  - Manual selection:1 pt AF: SEL [ ] (center), SEL AF (off center)

## Meaning of Lit or Blinking AF Points

---

Pressing the <  > or <  > button lights up the AF points that are cross-type AF points for high-precision autofocusing. The blinking AF points are horizontal-line or vertical-line sensitive.

## Shooting Conditions That Make Focusing Difficult

- Subjects with very low contrast.  
(Example: Blue skies, solid-color flat surfaces, etc.)
- Subjects in very low light.
- Strongly backlit or reflective subjects.  
(Example: Cars with highly reflective surfaces, etc.)
- Near and distant subjects positioned close to an AF point.  
(Example: Animals in cages, etc.)
- Light source such as dots of light positioned close to an AF point.  
(Example: Night scenes, etc.)
- Subjects with repetitive patterns.  
(Example: Skyscraper windows, computer keyboards, etc.)
- Subjects with finer patterns than an AF point.  
(Example: Faces or flowers as small as or smaller than an AF point, etc.)

In such cases, focus in either of the following two ways.

1. With **[One-Shot AF]**, focus on an object at the same distance as the subject and lock the focus, then recompose the shot (📷).
2. Set the lens's focus mode switch to <MF> and focus manually (📷).

### Note

- Depending on the subject, focus can be achieved by slightly recomposing the shot and performing AF operation again.

## Selecting the AF Methods (Live View Shooting)

---

- [AF Method](#)
- [Selecting the AF Method](#)
- [Magnified View](#)
- [AF Shooting Tips](#)
- [Shooting Conditions That Make Focusing Difficult](#)
- [AF Range](#)

### AF Method

---

#### +Tracking



The camera detects and focuses on people's faces. An AF point [ ] appears over any face detected, which is then tracked.  
If no face is detected, the entire AF area is used for focusing.

#### Spot AF



The camera focuses in a narrower area than [1-point AF].



## □: 1-point AF



The camera focuses using a single AF point [□].

## [ ]: Zone AF



Focuses in a wide Zone AF frame, which makes it easier to acquire subjects than with **[1-point AF]**.

Prioritizes focusing on the nearest subject. Faces of any people in the Zone AF frame are also given priority in focusing.

AF points in focus are displayed with < □ >.

## Selecting the AF Method

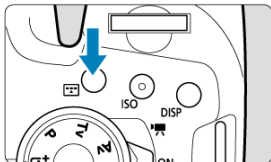

1. Press the  button.



2. Select the AF method.





- Each time you press the  button, the AF method changes.

Shooting settings					
1	2	3	4	5	SHOOT5
AF method	AF 				
Eye Detection AF	Disable				
Continuous AF	Disable				
Lens electronic MF	⊕-OFF				
AF-assist beam firing	ON				
MF peaking settings	-				
MENU 					

- You can also make your selection from [: AF method].



### Note

- In  mode, [+Tracking] is set automatically.
- Regarding the Touch Shutter (AF and shutter release by touch operation), see [Shooting with the Touch Shutter](#).

## AF+Tracking:



The camera detects and focuses on people's faces. If a face moves, the AF point  also moves to track the face.

You can set **[Eye Detection AF]** to **[Enable]** to shoot with the subject's eyes in focus .

\* These instructions apply to the camera with AF operation set to **[One-Shot AF]** . With **[Servo AF]**  set, the AF point will turn blue when focus is achieved.

### 1. Check the AF point.



- An AF point  appears over any face detected.
- If  is displayed, you can use the < ◀ > < ▶ > keys to choose a face to focus on.
- Press <  > to move the AF point to the face of the person in the center of the screen.

## 2. Focus and take the picture.

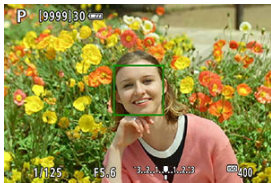
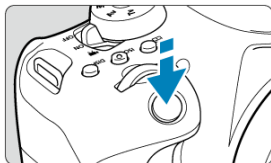

- Once you press the shutter button halfway and the subject is in focus, the AF point turns green and the camera beeps. An orange AF point indicates that the camera could not focus on subjects.

### Tapping a face for focus

Tapping a face or subject to focus on changes the AF point to  and focuses where you tap.

Even if the face or subject moves on the screen, the AF point  moves to track it.

#### Caution

- If the subject's face is significantly out of focus, face detection will not be possible. Adjust the focus manually () so that the face can be detected, then perform AF.
- An object other than a human face may be detected as a face.
- Face detection will not work if the face is very small or large in the picture, too bright or too dark, or partially hidden.
- AF cannot detect subjects or people's faces at the edges of the screen. Recompose the shot to center the subject or bring the subject closer to the center.

#### Note

- The active  may cover only a part of the face, not the whole face.
- The size of the AF point changes depending on the subject.

## Spot AF/1-point AF/Zone AF

You can manually set the AF point or Zone AF frame. Here, 1-point AF screens are used as an example.

### 1. Check the AF point.



(1)

- The AF point (1) will appear. With Zone AF, the Zone AF frame is displayed.

### 2. Move the AF point.



- Use the <▲> <▼> <◀> <▶> keys to move the AF point to where you want to focus (but note that with some lenses, it may not move to the edge of the screen).  
You can also tap the screen to move the AF point.  
To center the AF point or Zone AF frame, press <SET> >.
- You can also center the AF point by tapping <□> >.

### 3. Focus and take the picture.

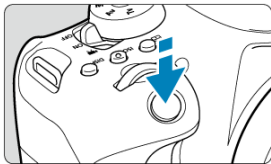

- Aim the AF point over the subject and press the shutter button halfway. When focus is achieved, the AF point will turn green and the beeper will sound. If focus is not achieved, the AF point will turn orange.

#### ⚠ Caution

- AF points may not track subjects under some shooting conditions when **[Servo AF]** is used with Zone AF.
- Focusing may be difficult when using a peripheral AF point. In this case, select an AF point in the center.

## Eye Detection AF

With the AF method set to [**L**+Tracking], you can shoot with the subject's eyes in focus.

### 1. Select [**L**: Eye Detection AF].

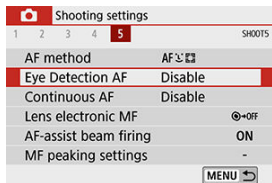

### 2. Select [Enable].

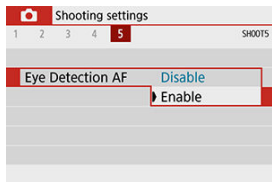

### 3. Aim the camera at the subject.



- An AF point is displayed around their eye.
- You can tap the screen to select an eye for focus. The entire face is selected when you tap other facial features, such as their nose or mouth. Eyes to focus on are selected automatically.
- When [◀ ▶] is displayed, you can choose an eye or face to focus on with the <◀> <▶> keys, depending on the [Eye Detection AF] setting.

### 4. Take the picture.

#### ⚠ Caution



- Subject eyes may not be detected correctly, depending on the subject and shooting conditions.

#### 📄 Note

- To switch to [Eye Detection AF: Disable] without using menu operations, press the < [ ] > button and then the < INFO > button. To switch to [Eye Detection AF: Enable], press the < INFO > button again.



## Magnified View

To check the focus when the AF method is other than [**L**+Tracking], magnify display by approx. 5× or 10× by pressing the <  > button (or tapping ).

- Magnification is centered on the AF point for [**Spot AF**] or [**1-point AF**] and on the Zone AF frame for [**Zone AF**].
- Autofocusing is performed with magnified display if you press the shutter button halfway when set to [**Spot AF**], and [**1-point AF**]. When set to AF methods other than [**Spot AF**] and [**1-point AF**], autofocusing is performed after restoring normal display.
- With Servo AF, if you press the shutter button halfway in the magnified view, the camera will return to the normal view for focusing.

### Caution

- If focusing is difficult in the magnified view, return to the normal view and perform AF.
- If you perform AF in the normal view and then use the magnified view, accurate focus may not be achieved.
- AF speed differs between the normal view and magnified view.
- Continuous AF and Movie Servo AF are not available when display is magnified.
- With the magnified view, achieving focus becomes more difficult due to camera shake. Using a tripod is recommended.

## AF Shooting Tips

---

- Even when focus is achieved, pressing the shutter button halfway will focus again.
- Image brightness may change during autofocusing.
- Depending on the subject and shooting conditions, it may take longer to focus, or the continuous shooting speed may decrease.
- If the light source changes as you shoot, the screen may flicker, and focusing may be difficult. In this case, restart the camera and resume shooting with AF under the light source you will use.
- If focusing is not possible with AF, focus manually (☑).
- For subjects at the edge of the screen that are slightly out of focus, try centering the subject (or AF point, or Zone AF frame) to bring them into focus, then recompose the shot before shooting.
- With certain lenses, it may take more time to achieve focus with autofocus, or accurate focusing may not be achieved.

## Shooting Conditions That Make Focusing Difficult

---

- Subjects with low contrast, such as a blue sky or flat surfaces in solid colors, or other cases when highlight or shadow details are clipped.
- Subjects in low light.
- Stripes and other patterns where there is contrast only in the horizontal direction.
- Subjects with repetitive patterns (Example: Skyscraper windows, computer keyboards, etc.).
- Fine lines and subject outlines.
- Under a light source whose brightness, color, or pattern keeps changing.
- Night scenes or points of light.
- The image flickers under fluorescent or LED lighting.
- Extremely small subjects.
- Subjects at the edge of the screen.
- Strongly backlit or reflective subjects (Example: Car with a highly reflective body, etc.).
- Near and distant subjects covered by an AF point (Example: Animal in a cage, etc.).
- Subjects that keep moving within the AF point and will not stay still due to camera shake or subject blur.
- Performing AF when the subject is very far out of focus.
- Soft focus effect is applied with a soft focus lens.
- A special effect filter is used.
- Noise (dots of light, banding, etc.) appears on the screen during AF.

## AF Range

---

The available autofocus range varies depending on the lens used and aspect ratio and whether you are using features such as Movie digital IS.

# Manual Focus

---

- [Viewfinder Shooting](#)
- [Live View Shooting](#)
- [Setting MF Peaking \(Outline Emphasis\)](#)

If focus cannot be achieved with autofocus, follow the procedure below to focus manually.

---

## Viewfinder Shooting

---

1. Set the lens's focus mode switch to <MF>.

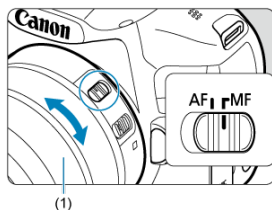

2. Focus on the subject.

- Turn the lens focusing ring (1) until the subject looks sharp in the viewfinder.

### Note

- The focus indicator <●> is lit when subjects are in focus as you press the shutter button halfway in manual focusing.
- With Automatic selection AF, when the center AF point achieves focus, the focus indicator <●> will light up.

## Live View Shooting

You can magnify the image when focusing.

1. Set the lens's focus mode switch to <MF>.

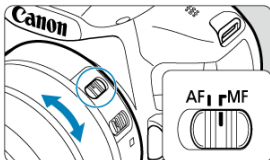

- Turn the lens focusing ring to focus roughly.

2. Magnify the image.

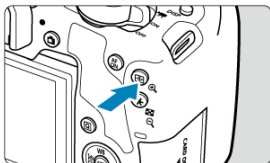

- Each press of the <Q> button switches from normal display to 5× to 10× display.

### 3. Move the magnified area.



- Use the <▲> <▼> <◀> <▶> keys to move the magnified area into position for focusing.
- To center the magnified area, press <SET>.

### 4. Focus manually.

- While looking at the magnified image, turn the lens focusing ring to focus.
- After achieving focus, press the <M> button to return to the normal view.

#### Note

- In magnified view, the exposure is locked.
- You can use the Touch Shutter to take a picture during normal display.

## Setting MF Peaking (Outline Emphasis)

In Live View shooting, edges of subjects in focus can be displayed in color to make focusing easier. You can set the outline color and adjust the sensitivity (level) of edge detection (except in < **A**+ > mode).

### 1. Select [**MF peaking settings**].

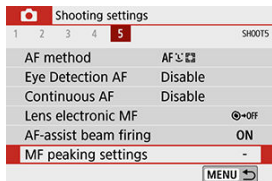

### 2. Select [**Peaking**].

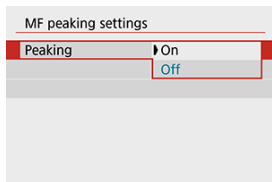

- Select [**On**].

### 3. Set the level and color.

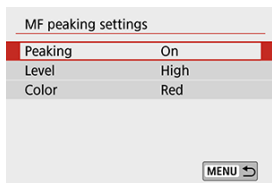

- Set it as necessary.

 **Caution**

- Peaking display is not shown during magnified display.
- During HDMI output, peaking display is not shown on equipment connected via HDMI.
- MF peaking may be hard to discern at high ISO speeds, especially when ISO expansion is set. If necessary, lower the ISO speed or set **[Peaking]** to **[Off]**.

 **Note**

- Peaking display shown on the screen is not recorded in images.



## Drive Mode





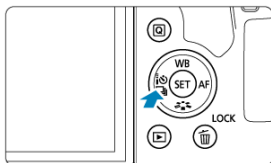

---

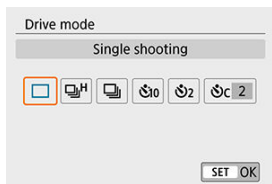
1. Press the  button.









2. Select the drive mode.



-  **Single shooting**  
When you press the shutter button completely, only one shot will be taken.
-  **High speed continuous**  
When you hold down the shutter button completely, you can shoot continuously at **max. approx. 7.0 shots/sec.** (**Live View shooting: max. approx. 7.5 shots/sec.**) while you keep holding it down. When the AF operation is set to **[Servo AF]** in Live View shooting, the continuous shooting speed will be **max. approx. 4.5 shots/sec.**
-  **Low speed continuous/Continuous shooting**  
When you hold down the shutter button completely, you can shoot continuously at **max. approx. 3.0 shots/sec.** while you keep holding it down.
-  **Self-timer: 10 sec/remote control**
-  **Self-timer: 2 sec/remote control**
-  **Self-timer: Continuous**  
For self-timer shooting, see [Using the Self-Timer](#). For remote control shooting, see [Remote Control Shooting](#).

 Caution

- The maximum continuous shooting speed for <  H > (  ) is the value in continuous shooting under these conditions: shooting with a fully charged Battery Pack LP-E17 at a 1/1000 sec. or faster shutter speed and maximum aperture value (depending on the lens), Image Stabilizer off (depending on the lens), at room temperature (23°C/73°F), with flicker reduction disabled.
- The continuous shooting speed for <  H > may become slower depending on factors such as temperature, battery level, flicker reduction, shutter speed, aperture value, subject conditions, brightness, AF operation, lens, live view shooting, built-in flash use, and shooting function settings.
- With [  : Anti-flicker shoot.] set to [Enable] (  ), shooting under flickering light may decrease the maximum continuous shooting speed. Also, the continuous shooting interval may become irregular and the release time lag may become longer.
- With AI Servo AF/Servo AF, the maximum continuous shooting speed may become slower depending on the subject conditions and the lens used.
- If the battery temperature is low due to a low ambient temperature, the maximum continuous shooting speed may become slower.
- When internal memory becomes full during continuous shooting, the continuous shooting speed may drop off because shooting will be temporarily disabled (  ).

## Using the Self-Timer

1. Press the  $\langle \text{[i]}\text{[t]} \rangle$  button.

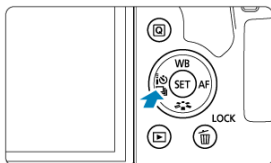

2. Select the self-timer.

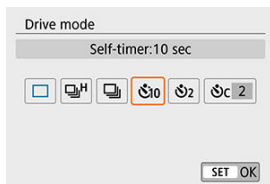

- $\text{[i]}\text{[t]}\text{[t]}\text{[t]}$ : Shoot in 10 sec.  
Remote control shooting is also possible (☑).
- $\text{[i]}\text{[t]}\text{[t]}$ : Shoot in 2 sec.  
Remote control shooting is also possible (☑).
- $\text{[i]}\text{[t]}\text{[c]}$ : Shoot continuously in 10 sec. for the specified number of shots  
Press the  $\langle \blacktriangle \rangle$   $\langle \blacktriangledown \rangle$  keys to set the number of multiple shots (2 to 10) to be taken with the self-timer. Remote control shooting is not possible.
- $\text{[i]}\text{[t]}\text{[t]}$  and  $\text{[i]}\text{[t]}\text{[t]}\text{[2]}$  icons are displayed when the camera is paired with a wireless remote control (sold separately, ☑).

### 3. Take the picture.



- Focus on the subject, then press the shutter button completely.
- To check operation, look at the self-timer lamp, listen for beeps, or watch the countdown in seconds on the screen.
- The self-timer lamp blinks faster approx. 2 sec. before the shot.

#### ⚠ Caution

- With [ⓈC], the shooting interval may become longer under some shooting conditions, depending on image quality, use of flash, and other factors.
- Light that enters the viewfinder may prevent suitable exposure.

#### 📄 Note

- [Ⓢ2] can be used to start shooting without touching the camera and avoid camera shake when it is mounted on a tripod for still-life or long exposure shots.
- After taking self-timer shots, playing back the image (📄) to check focus and exposure is recommended.
- When using the self-timer to shoot yourself, use focus lock (🔒) on an object at the same distance as where you will stand.
- To cancel the self-timer, either tap the screen or press < (SET) >.
- If remote control shooting is enabled, the auto power off will take effect in approx. 2 min. even if [🔌: Auto power off] is set to 1 min. or less.

## Remote Control Shooting

---

 [Wireless Remote Control BR-E1](#)



 [Remote Switch RS-60E3](#)

You can shoot remotely by using an optional Wireless Remote Control BR-E1, which pairs via Bluetooth.

---

### Wireless Remote Control BR-E1

---

You can shoot remotely up to approx. 5 meters/16.4 feet away from the camera. After pairing the camera and BR-E1 () , set the drive mode to [] (). For operation procedures, refer to the BR-E1 instruction manual.



#### Note

- Auto power off time may be extended when the camera is set for remote control shooting.
- The remote control can also be used for movie recording ().

## Remote Switch RS-60E3

---



Once connected to the camera, the switch enables you to shoot remotely over a wired connection.

For operation procedures, refer to the RS-60E3 instruction manual.

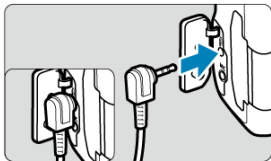
1. **Open the terminal cover.**



2. **Connect the plug to the remote control terminal.**

Four methods (metering modes) to measure the subject's brightness are provided. Normally, evaluative metering is recommended. In Basic Zone modes, evaluative metering is set automatically. (In the < SCN :  > and <  :  > modes, center-weighted average metering is set.)

## 1. Select [: Metering mode].

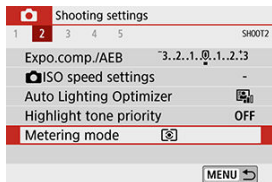

## 2. Select an item.

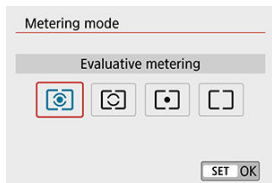

- : **Evaluative metering**

General-purpose metering mode suited even for backlit subjects. The camera adjusts the exposure automatically to suit the scene.

- : **Partial metering**

Effective when the background is much brighter than the subject due to backlighting, etc. Covers approx. 6.5% of the area at the center of the screen in viewfinder shooting or approx. 5.8% in Live View shooting.





- : **Spot metering**

Effective when metering a specific part of the subject. Covers approx. 2.0% of the area at the center of the screen in viewfinder shooting or approx. 2.9% in Live View shooting. The spot metering circle will be displayed in the viewfinder.

- : **Center-weighted average**

The metering across the screen is averaged, with the center of the screen weighted more heavily.

 **Caution**

- With  (Evaluative metering), holding down the shutter button halfway locks the exposure value (AE lock) after the camera focuses with [**One-Shot AF**]. With  (Partial metering),  (Spot metering), or  (Center-weighted average), exposure is set at the moment the picture is taken (without locking the exposure value when the shutter button is pressed halfway).



Exposure compensation can brighten (increased exposure) or darken (decreased exposure) the standard exposure set by the camera.

Exposure compensation is available in <P>, <Tv>, <Av>, and <M> modes. For details on exposure compensation when <M> mode and ISO Auto are both set, see [Exposure Compensation with ISO Auto](#).

---

## 1. Check the exposure.

- Press the shutter button halfway and check the exposure level indicator.

## 2. Set the compensation amount.

Increased exposure, to brighten images



Decreased exposure, to darken images





- Set with the <◉> dial.
- The exposure compensation range is  $\pm 3$  stops in Live View shooting, movie recording, and when [📷: Shooting screen] is set to [Guided].
- The exposure compensation range is  $\pm 5$  stops in viewfinder shooting when [📷: Shooting screen] is set to [Standard].
- The exposure compensation amount displayed in the viewfinder goes up to only  $\pm 2$  stops.







## 3. Take the picture.

- To cancel exposure compensation, set the exposure level <█> to the standard exposure index <█>.

## Caution

- If [: **Auto Lighting Optimizer**] () is set to any setting other than [**Disable**], the image may still look bright even if a decreased exposure compensation for a darker image is set.

## Note

- Setting the power switch to < **OFF** > clears any compensation amount that was set. To retain the setting even after the power switch is set to < **OFF** >, set [**5: Exposure comp. auto cancel**] in [: **Custom Functions(C.Fn)**] to [**1:Disable**].
- [] or [] is shown at the ends of the exposure level indicator if the exposure compensation amount exceeds  $\pm 3$  stops (or in the viewfinder,  $\pm 2$  stops).
- To set compensation beyond  $\pm 2$  stops, consider using the Quick Control () screen or [: **Exposure comp./AEB setting**] () .

You can lock the exposure when you want to set the focus and exposure separately or when you are to take multiple shots at the same exposure setting. Press the < \* > button to lock the exposure, then recompose and take the picture. It is effective for shooting backlit subjects, etc.

---

## 1. Focus on the subject.

- Press the shutter button halfway.

## 2. Press the < \* > button (ⓘ4).

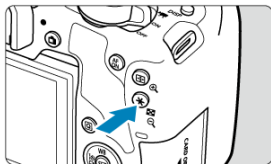



- A [\*] icon is displayed in the viewfinder or on the screen, indicating that the exposure is locked (AE lock).
- Each time you press the < \* > button, the current exposure setting is locked.





## 3. Recompose and take the picture.

- When you are to take more pictures while maintaining the AE lock, keep holding down the < \* > button and press the shutter button to take another picture.

## Caution

- If [: **Auto Lighting Optimizer**] () is set to any setting other than [**Disable**], the image may still look bright even if a decreased exposure compensation for a darker image is set.

## AE Lock Effects

Metering mode (  )	AF Point Selection (  ,  )	
	Automatic Selection	Manual Selection
	Exposure value centered on the AF point in focus is locked.	Exposure value centered on the selected AF point is locked.
	AE lock is applied at the center AF point.	

\* When  is set and the lens's focus mode switch is set to **MF**, AE lock is applied with the exposure value weighted on the center AF point.

## Note

- AE lock is not possible with bulb exposures.

# Flash Photography

---

This chapter describes how to shoot with the built-in flash or an external flash (EL/EX series Speedlites).

- ☆ to the right of page titles indicates functions only available in Creative Zone modes (<P>, <Tv>, <Av>, or <M>).

## Caution

- Flash cannot be used while you are recording movies.
- AEB is not available in flash photography.

- [Shooting With the Built-in Flash](#)
- [Flash Function Settings](#)
- [Shooting With External Flash Units](#) ☆
- [Wireless Flash Photography Using Optical Transmission](#) ☆
- [Easy Wireless Flash](#) ☆
- [Custom Wireless Flash](#) ☆

## Shooting With the Built-in Flash

---

- [☑ Approximate Built-in Flash Range](#)
- [☑ Shutter Speed and Aperture Value in Flash Photography](#)
- [☑ Shooting With FE Lock](#) ☆

Using the built-in flash is recommended when the [⚡] icon appears in the viewfinder or on the screen, when subjects in daytime shots are backlit, or when shooting under low light.

---

### 1. Manually raise the flash.

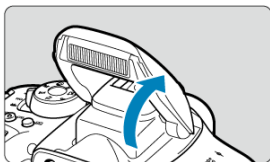

- In Creative Zone modes, shooting with flash is possible whenever the flash is raised.
- While the flash is charging, “buSY” is displayed in the viewfinder, and [BUSY] is displayed on the screen.

### 2. Press the shutter button halfway.

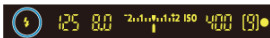

- Confirm that a [⚡] icon appears in the viewfinder or on the screen.

### 3. Take the picture.



- When focus is achieved and you press the shutter button completely, the flash will fire at all times.
- To retract the built-in flash after shooting, push it down with your fingers until it clicks into place.

### Shooting tips

- **In bright light, decrease the ISO speed.**

If the exposure setting in the viewfinder blinks, decrease the ISO speed.

- **Detach the lens hood. Do not get too close to the subject.**

If the lens has a hood attached or you are too close to the subject, the bottom of the picture may look dark due to the obstructed flash light. For important shots, play back the image and check to make sure the picture does not look unnaturally dark at the bottom part.

## Approximate Built-in Flash Range

(approx. range in meters/feet)

ISO Speed (☑)	EF-S18-55mm f/4-5.6 IS STM	
	Wide-Angle End	Telephoto End
	f/4	f/5.6
100	1.0 – 3.0 / 3.3 – 9.8	1.0 – 2.1 / 3.3 – 7.0
1600	1.5 – 12.0 / 4.9 – 39.4	1.1 – 8.6 / 3.5 – 28.1
25600	6.0 – 48.0 / 19.8 – 157.4	4.3 – 34.3 / 14.1 – 112.5

\* Rounded to the nearest tenth.

\* It may not be possible to obtain standard exposure when shooting distant subjects at high ISO speeds, or under certain subject conditions.

## Shutter Speed and Aperture Value in Flash Photography

Shooting Mode	Shutter Speed	Aperture Value
<b>P</b>	Auto (1/200–30 sec.)*	Automatically set
<b>Tv</b>	Manual (1/200–30 sec.)	Automatically set
<b>Av</b>	Auto (1/200–30 sec.)*	Manually set
<b>M</b>	Manual (1/200–30 sec.)	Manually set

\* When [Slow synchro] under [Flash control] is set to [1/200-30sec. auto].

### Caution

- Do not use the built-in flash unless it is fully raised.
- The bottom of images may be dark if light from the built-in flash is obstructed by a lens hood, or by a subject that is too close.

### Note

- If the bottom of images is dark when you use super telephoto or large-diameter lenses, consider using an external Speedlite (sold separately, )



The background or other factors may make subjects brighter or darker in flash photography with subjects near the edge of the screen. In this case, use FE lock. After setting the flash output for the appropriate subject brightness, you can recompose (put the subject toward the side) and shoot. This feature can also be used with a Canon EL/EX series Speedlite.

\* FE stands for Flash Exposure.

### 1. Manually raise the flash.



- Press the shutter button halfway and look in the viewfinder to check that the [⚡] icon is lit.

### 2. Focus on the subject.



# Flash Function Settings

---

- [Flash Firing](#)
- [E-TTL II Metering](#) ☆
- [Red-Eye Reduction](#)
- [Slow Synchro](#) ☆
- [Built-in Flash Settings](#) ☆
- [External Flash Function Settings](#) ☆
- [External Flash Custom Function Settings](#) ☆
- [Clear Flash Settings/Clear All Speedlite Custom Functions](#) ☆

Functions of the built-in flash or external EL/EX series Speedlites can be set from menu screens on the camera.

Before setting functions of external Speedlites, attach the Speedlite and turn it on.

For details on external Speedlite functions, refer to the Speedlite's instruction manual.

---

## 1. Select [Flash control].

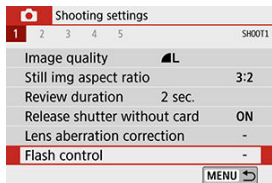

## 2. Select an option.

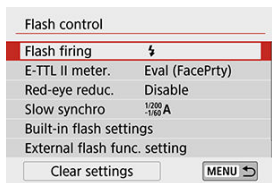

## Flash Firing

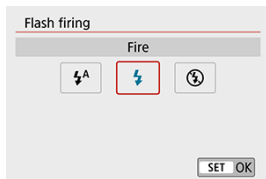

- Set to [⚡A] (in Basic Zone or <P> modes) to have the flash fire automatically, based on shooting conditions.
- Set to [⚡] to have the flash always fire when you shoot.
- Select [⚡/] (in Creative Zone modes) to keep the flash off, or if you will use the AF-assist beam.

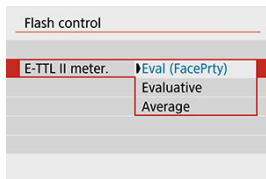

- Set to **[Eval (FacePrty)]** for flash metering suitable for shots of people. Continuous shooting speed for [C] will become slower than when **[Evaluative]** or **[Average]** is selected.
- Set to **[Evaluative]** for flash metering that emphasizes firing in continuous shooting.
- If **[Average]** is set, the flash exposure will be averaged for the entire metered scene.

#### ⚠ Caution

- Even with the camera set to **[Eval (FacePrty)]**, results may not be as expected, depending on the shooting conditions and subject.

## Red-Eye Reduction

---

Set to **[Enable]** to reduce red-eye by firing the red-eye reduction lamp before firing the flash.

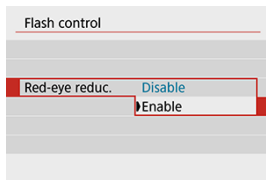

You can set the flash-sync speed for flash photography in < **Av** > mode or < **P** > mode.

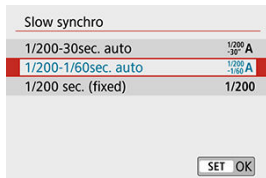

- [<sup>1/200</sup><sub>-36</sub> A] 1/200-30sec. auto**

The flash sync speed is set automatically within a range of 1/200 sec. to 30 sec. to suit the scene's brightness. Slow-sync shooting is used in low-light locations (under some shooting conditions), and shutter speed is automatically lowered.
- [<sup>1/200</sup><sub>-1/60</sub> A] 1/200-1/60sec. auto**

Prevents a slow shutter speed from being set automatically in low-light conditions. It is effective for preventing subject blur and camera shake. However, while the subject will be properly exposed with the flash, the background may come out dark.
- [1/200] 1/200 sec. (fixed)**

The shutter speed is fixed at 1/200 sec, which is more effective in preventing subject blur and camera shake than with **[1/200-1/60sec. auto]**. However, in low light, the subject's background will come out darker than with **[1/200-1/60sec. auto]**.

### Caution

- To use slow-sync shooting in < **Av** > or < **P** > mode, set to **[1/200-30sec. auto]**.



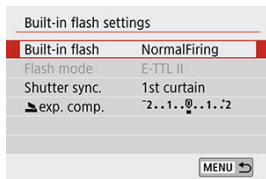

## Flash mode

Set to **[E-TTL II]** to shoot in E-TTL II/E-TTL fully automatic flash mode. To enable **[Flash mode]**, select **[CustWireless]** in **[Built-in flash]**.

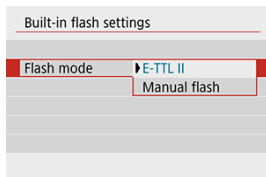

Set to **[Manual flash]** to specify your preferred flash output manually.

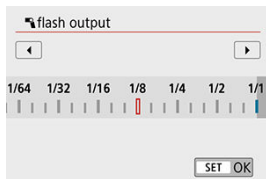

## Shutter sync.

Normally, set this to **[1st curtain]** so that the flash fires immediately after the shooting starts. Set to **[2nd curtain]** and use low shutter speeds for natural-looking shots of subject motion trails, such as car headlights.

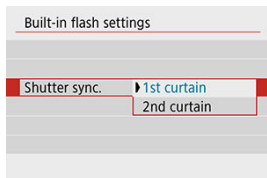

### ⚠ Caution

- When shooting with **[2nd curtain]**, set a slow shutter speed of 1/80 sec. or slower. If the shutter speed exceeds 1/80 sec., first-curtain synchronization is used automatically even if **[2nd curtain]** is set.

## exp. comp. ☆

Set the flash exposure compensation if the brightness of the subject does not come out as desired (so you want to adjust the flash output) in flash photography. You can set the flash exposure compensation up to  $\pm 2$  stops in 1/3-stop increments.

### 1. Select [exp. comp.].

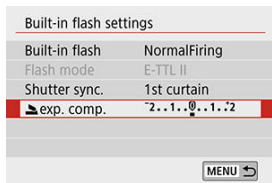

### 2. Set the compensation amount.

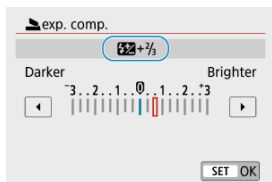

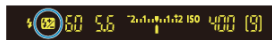

- If the exposure is too dark, press the < ► > key (for increased exposure).
- If the exposure is too bright, press the < ◀ > key (for decreased exposure).



- When you press the shutter button halfway, the < lightning bolt with plus > icon will appear in the viewfinder.
- **After taking the picture, cancel the flash exposure compensation by setting it back to 0.**

### Caution

- If [: **Auto Lighting Optimizer**] () is set to any setting other than [**Disable**], the image may still look bright even if a decreased flash exposure compensation is set.
- If flash exposure compensation is set with a Speedlite (sold separately, ), you cannot set the flash exposure compensation with the camera (Quick Control or External flash func. setting). Note that the Speedlite's setting overrides the camera's if both are set at the same time.

### Note

- The exposure compensation amount will remain in effect even after you set the power switch to < **OFF** >.

## Wireless func.

See [Wireless Flash Photography Using Optical Transmission](#) if you will use the sender function of the built-in flash in optical wireless shooting. Refer to the instruction manual of the external flash unit if you will use the sender function of the external flash in radio or optical wireless shooting.

The information displayed, position of display, and available options vary depending on the Speedlite model, its Custom Function settings, the flash mode, and other factors. Refer to the instruction manual of your flash unit for details on its functions.

### Sample display

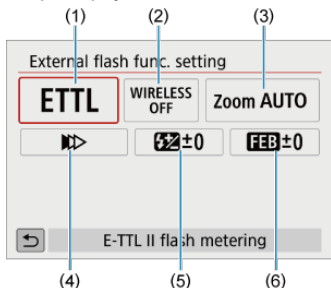

- (1) Flash mode
- (2) Wireless func./Firing ratio control
- (3) Flash zoom (flash coverage)
- (4) Shutter synchronization
- (5) Flash exposure compensation
- (6) Flash exposure bracketing

### Caution

- Functions are limited when using EX series Speedlites that are not compatible with flash function settings.

## Flash mode

You can select the flash mode to suit your desired flash photography.

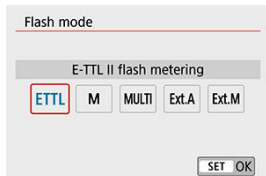

- **[E-TTL II]** is the standard mode of EL/EX-series Speedlites that support autoexposure flash photography.
- **[Manual flash]** is for setting the Speedlite's **[Flash output]** yourself.
- **[CSP]** (Continuous shooting priority mode) is available when using a compatible Speedlite. This mode automatically reduces flash output by one stop and increases ISO speed by one stop. Useful in continuous shooting, and helps conserve flash battery power.
- Regarding other flash modes, refer to the Instruction Manual of a Speedlite compatible with the respective flash mode.

### Caution

- Adjust [Exposure Compensation](#) as needed in case of overexposure from flash photography with **[CSP]** in **< Tv >** or **< M >** mode.

### Note

- With **[CSP]**, ISO speed is automatically set to **[Auto]**.

## Wireless functions

You can use radio or optical wireless transmission to shoot with wireless multiple-flash lighting.

For details on wireless flash, refer to the Instruction Manual of a Speedlite compatible with wireless flash photography.

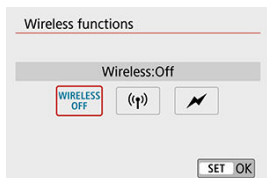

## Firing ratio control

With a macro flash, you can set the firing ratio control.

For details on firing ratio control, refer to the macro flash's Instruction Manual.



## Flash zoom (flash coverage)

With Speedlites equipped with a zooming flash head, you can set the flash coverage.

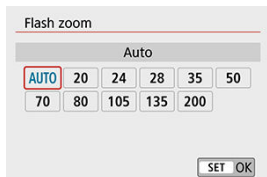

## Shutter synchronization

Normally, set this to **[First-curtain synchronization]** so that the flash fires immediately after the shooting starts. Set to **[Second-curtain synchronization]** and use low shutter speeds for natural-looking shots of subject motion trails, such as car headlights.

Set to **[High-speed synchronization]** for flash photography at higher shutter speeds than the maximum flash sync shutter speed. This is effective when shooting with an open aperture in **< Av >** mode to blur the background behind subjects outdoors in daylight, for example.

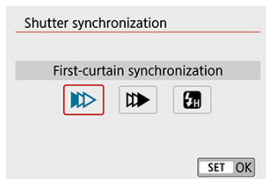

### Caution

- When using second-curtain synchronization, set the shutter speed to 1/80 sec. or slower. If the shutter speed exceeds 1/80 sec., first-curtain synchronization is used automatically even if **[Second-curtain synchronization]** is set.

## Flash exposure compensation

Just as exposure compensation is adjustable, you can also adjust flash output of external Speedlites.

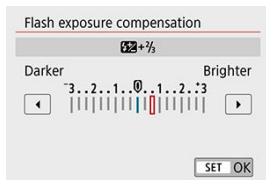

### Caution

- If flash exposure compensation is set with the Speedlite, you cannot set the flash exposure compensation with the camera. Note that the Speedlite's setting overrides the camera's if both are set at the same time.



## Flash exposure bracketing

External Speedlites equipped with flash exposure bracketing (FEB) can change the external flash output automatically as three shots are taken at once.

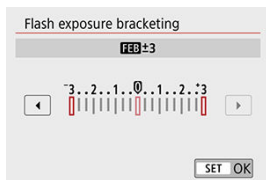

For details on the external Speedlite's Custom Functions, refer to the Speedlite's Instruction Manual.

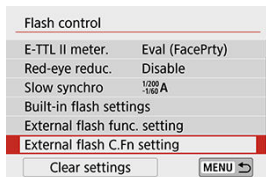

### ⚠ Caution

- With an EL/EX series Speedlite, the Speedlite will always fire at full output if the **[Flash metering mode]** Custom Function is set to **[1:TTL]** (autoflash).
- The external Speedlite's Personal Function (P.Fn) cannot be set or canceled from the camera's **[📷: External flash func. setting]** screen. Set it directly on the external Speedlite.

## 1. Select [Clear settings].

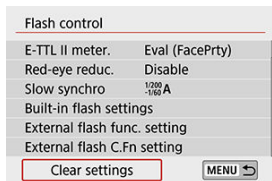

## 2. Select the settings to be cleared.

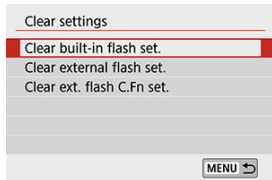

- Select [**Clear built-in flash set.**], [**Clear external flash set.**], or [**Clear ext. flash C.Fn set.**].
- On the confirmation screen, select [**OK**] to clear all flash settings or Custom Function settings.

- [EL/EX Series Speedlites for EOS Cameras](#)
- [Canon Speedlites Other Than the EL/EX Series](#)
- [Non-Canon Flash Units](#)

## EL/EX Series Speedlites for EOS Cameras

---

The camera supports flash photography using all functions of EL/EX series Speedlites (sold separately).

For instructions, refer to the EL/EX series Speedlite's Instruction Manual.

## Canon Speedlites Other Than the EL/EX Series

---

- With an EZ/E/EG/ML/TL series Speedlite set to A-TTL or TTL autoflash mode, the flash can be fired at full output only.  
Set the camera's shooting mode to < **M** > or < **Av** > and adjust the aperture value before shooting.
- When using a Speedlite that has manual flash mode, shoot in the manual flash mode.

### Sync speed

The camera can synchronize with non-Canon compact flash units at up to 1/200 sec. With large studio flash units, the flash duration is longer than that of a compact flash unit and varies depending on the model. Be sure to check before shooting if flash sync is properly performed by test shooting at a sync speed of approx. 1/60 sec. to 1/30 sec.

#### Caution

- Manually lower the built-in flash before attaching an external flash unit.
- Using the camera with a dedicated flash unit or flash accessory for cameras of other manufacturers poses a risk of malfunction and even damage.
- Do not attach a high-voltage flash unit to the camera's hot shoe. It may not be fired.

## Wireless Flash Photography Using Optical Transmission

---



- [Receiver Setup and Positioning](#)
- [Canceling Receiver Auto Power Off](#)
- [Methods of Wireless Flash Photography Using Optical Transmission](#)

You can use the built-in flash as the sender for external Canon Speedlites compatible with optical wireless flash photography to shoot with wireless multiple-flash lighting.

---

## Receiver Setup and Positioning

Referring to the Instruction Manual of the Speedlite (receiver), configure the following settings.

- Set up the Speedlite as a receiver.
- Set the camera and Speedlite to the same channel.
- To control the flash ratio, set the receiver's flash group.
- Position the camera and receiver within the following range.
- Arrange the receiver with its wireless sensor facing the camera.

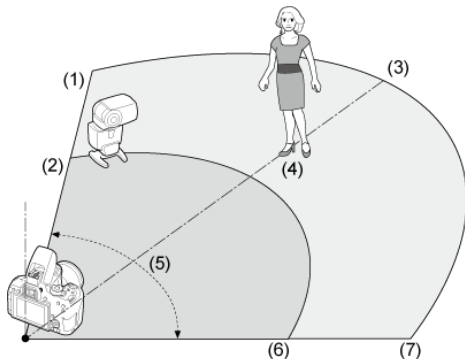

(1) Indoors

(2) Outdoors

(3) Approx. 10 m

(4) Approx. 7 m

(5) Approx. 80°

(6) Approx. 5 m

(7) Approx. 7 m

## Canceling Receiver Auto Power Off

Press the camera's < \* > button. For manual flash, cancel by pressing the receiver's test flash button.

## Methods of Wireless Flash Photography Using Optical Transmission

You can use the camera in the following wireless flash photography. Choose a method of shooting that suits your subject, shooting conditions, number of external flash units, or other details.

	Speedlite		Built-In Flash	Settings		Link
	No. of Units	A:B Firing Ratio		Wireless Functions	Firing Group	
Fully automatic shooting (E-TTL II autoflash)	1	–	–		All	
	1	–	Used		–	
	Multiple	–	–		All	
	Multiple	Settings	–		(A:B)	
	Multiple	–	Used		All and	
	Multiple	Settings	Used		(A:B)	
	<ul style="list-style-type: none"> <li>• Flash exposure compensation</li> </ul>					
<ul style="list-style-type: none"> <li>• FE lock</li> </ul>						

	Speedlite		Built-In Flash	Settings		Link
	No. of Units	A:B Firing Ratio		Wireless Functions	Firing Group	
Manual flash	1/multiple	–	–		All	
	Multiple	Settings	–		(A:B)	
	1/multiple	–	Used		All and	
	Multiple	Settings	Used		(A:B)	

\* / : external Speedlite; / : built-in flash

### Caution

- To control receivers optically, the built-in flash fires even when set not to fire.



- ☑ [Fully Automatic Shooting With One External Flash Unit](#)
- ☑ [Fully Automatic Shooting With Multiple External Flash Units](#)
- ☑ [Flash Exposure Compensation](#)

These instructions describe simple and basic fully automatic wireless flash photography.

## Fully Automatic Shooting With One External Flash Unit

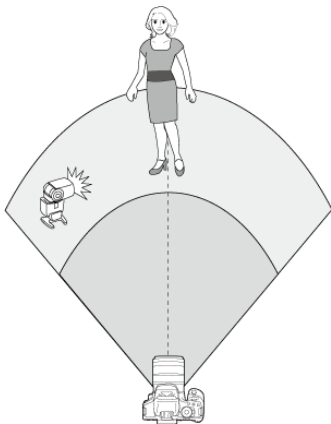

1. **Manually raise the flash.**

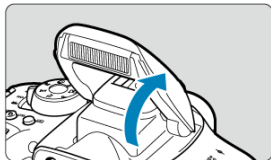

## 2. Select [Flash control].

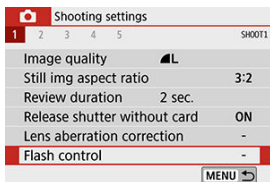

## 3. Select [Evaluative].

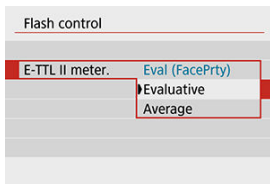

- In [E-TTL II meter.], select [Evaluative].

## 4. Select [Built-in flash settings].

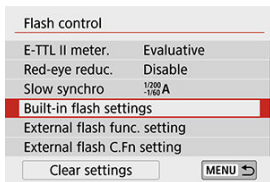

## 5. Select [EasyWireless].

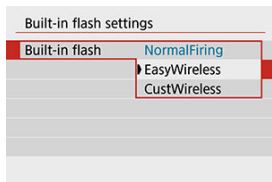

- In [Built-in flash], select [EasyWireless].

## 6. Configure [Channel].

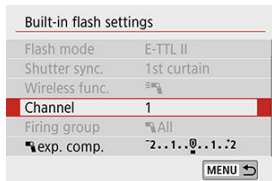

- Set the same channel (1–4) as the receiver.

## 7. Take the picture.

- Just as in normal flash photography, shoot after configuring the camera.
- To stop wireless flash photography, set [Built-in flash] to [NormalFiring].



#### Note

- Set **[E-TTL II meter.]** to **[Evaluative]**, which can usually obtain standard flash exposure. If **[Average]** is set, the flash exposure will be averaged for the entire metered scene. Depending on the scene, flash exposure compensation may be necessary. This setting is for expert users.
- **[EasyWireless]** is a setting option for photography without using the built-in flash, but the flash will still fire in order to control receivers. Note that this firing to control receivers may be visible in your shots, under some shooting conditions.
- Test flash firing function is not available with receivers.

## Fully Automatic Shooting With Multiple External Flash Units

You can have multiple receivers fire as if they were a single flash unit. This is convenient when a high level of flash output is needed.

### Set these basic settings.

- **Flash mode:** E-TTL II
- **E-TTL II meter:** Evaluative
- **Built-in flash:** EasyWireless
- **Channel:** (same as receiver)

Built-in flash settings	
Built-in flash	EasyWireless
Flash mode	E-TTL II
Shutter sync.	1st curtain
Wireless func.	☑
Channel	1
Firing group	☑ All

MENU ↩

All flash units are controlled to fire with the same output and provide standard exposure. All receivers fire as part of the same group, regardless of whether they are assigned to firing group A, B, or C.

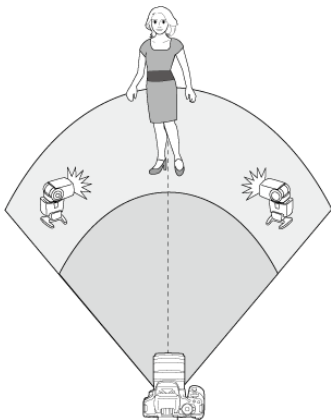



## Flash Exposure Compensation

If the results of shooting with flash look too dark or bright, you can set flash exposure compensation to adjust the flash output.

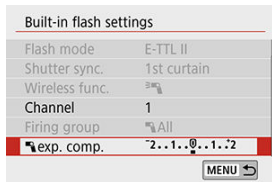
### 1. Select [ Flash exposure compensation].







- If shooting results are too dark, press the <  > key to increase flash output, for brighter results. If shooting results are too bright, press the <  > key to decrease flash output, for darker results.

- ☑ [Fully Automatic Shooting With One External Flash Unit and the Built-in Flash](#)
- ☑ [Fully Automatic Shooting With Multiple External Flash Units](#)
- ☑ [Fully Automatic Shooting With Multiple External Flash Units and the Built-in Flash](#)
- ☑ [Flash Exposure Compensation](#)
- ☑ [FE Lock](#)
- ☑ [Wireless Flash Photography With Manually Set Flash Output](#)

## Fully Automatic Shooting With One External Flash Unit and the Built-in Flash

This fully automatic wireless flash photography uses one external flash unit and the built-in flash.

You can adjust how shadows form on subjects by changing the ratio of flash output from the external flash unit and the built-in flash.

In menus, [  ] and [  ] represent the external flash unit and [  ] and [  ] the built-in flash.

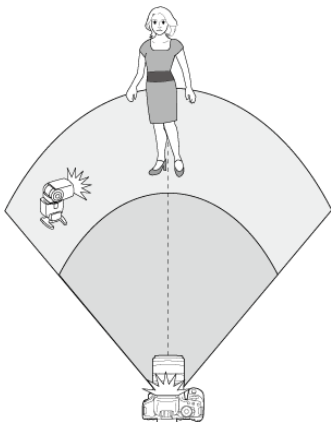

## 1. Manually raise the flash.

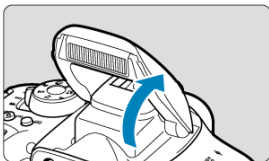

## 2. Select [Flash control].

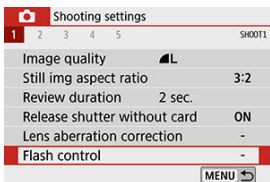

## 3. Select [Evaluative].

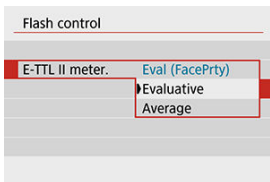

- In [E-TTL II meter.], select [Evaluative].



#### 4. Select [Built-in flash settings].

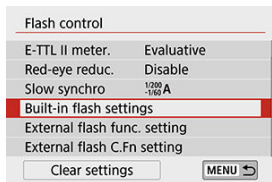

#### 5. Select [CustWireless].

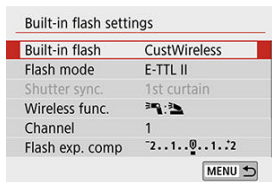

- In [Built-in flash], select [CustWireless].

#### 6. Select [Wireless func.].

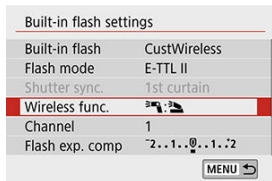

- In [Wireless func.], select [].

## 7. Set a firing ratio and take the picture.

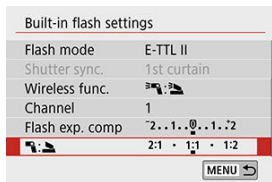

- Select [: >] and set the firing ratio within 8:1 to 1:1. Setting a firing ratio to the right of 1:1 is not possible.



### Note

- If there is not enough flash output from the built-in flash, set a higher ISO speed ().
- Firing ratios from 8:1 to 1:1 correspond to 3:1 to 1:1 (in 1/2-stop increments) when converted to number of stops of exposure.



## Fully Automatic Shooting With Multiple External Flash Units

Multiple receivers can be treated as a single flash unit or, if you prefer to adjust the firing ratio, as separate groups.

The basic settings are as follows, and by adjusting the **[Firing group]** setting, you can set up a variety of wireless multi-flash photography.

### Set these basic settings.

- **Flash mode:** E-TTL II
- **E-TTL II meter.:** Evaluative
- **Wireless func.:** 
- **Channel:** (same as receiver)

Built-in flash settings	
Built-in flash	CustWireless
Flash mode	E-TTL II
Shutter sync.	1st curtain
Wireless func.	
Channel	1
Firing group	 All

MENU 

## [All] Firing multiple receivers as a single flash unit

This is convenient when a high level of flash output is needed. All flash units are controlled to fire with the same output and provide standard exposure.

All receivers fire as part of the same group, regardless of whether they are assigned to firing group A, B, or C.

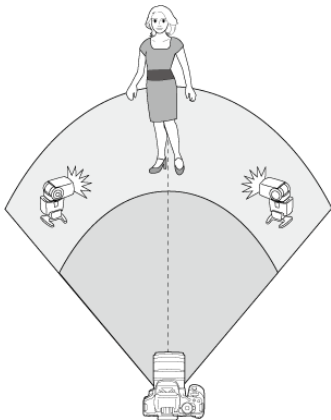

1. Set [Firing group] to [All].

Built-in flash settings	
Flash mode	E-TTL II
Shutter sync.	1st curtain
Wireless func.	[All]
Channel	1
Firing group	[All]
[exp. comp.]	2..1..@..1..2

MENU ↩

2. Take the picture.

## [A:B] Firing multiple receivers in multiple groups

You can divide receivers into flash groups A and B, and you can adjust the relative output of each to obtain the desired lighting.

Referring to the instruction manual of the flash unit, assign some receivers to firing group A and others to firing group B, and arrange them as shown.

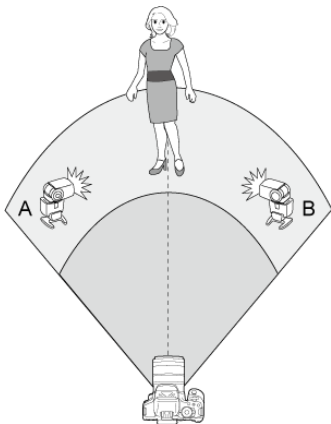

1. Manually raise the flash.

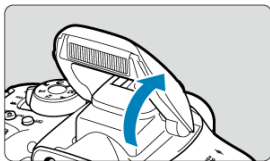

## 2. Select [Flash control].

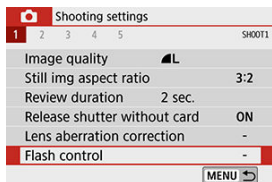

## 3. Select [Evaluative].

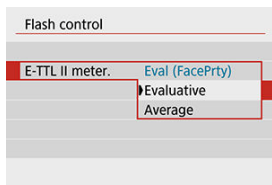

- In [E-TTL II meter.], select [Evaluative].

## 4. Select [Built-in flash settings].

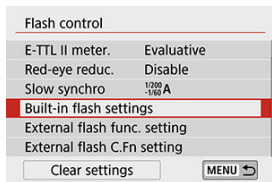

## 5. Select [CustWireless].

Built-in flash settings	
Built-in flash	CustWireless
Flash mode	E-TTL II
Shutter sync.	1st curtain
Wireless func.	
Channel	1
Flash exp. comp	-2..1..0..1..2

MENU

- In [Built-in flash], select [CustWireless].

## 6. Select [Wireless func.].

Built-in flash settings	
Built-in flash	CustWireless
Flash mode	E-TTL II
Shutter sync.	1st curtain
Wireless func.	
Channel	1
Firing group	All

MENU

- Select [].

## 7. Set [Firing group] to [ (A:B)].

Built-in flash settings	
Shutter sync.	1st curtain
Wireless func.	
Channel	1
Firing group	(A:B)
A:B fire ratio	2:1 · 1:1 · 1:2
exp. comp.	-2..1..0..1..2

MENU

## 8. Set the A:B firing ratio and shoot.

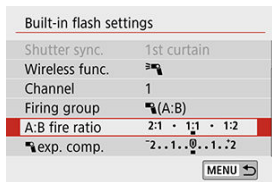

- Select [A:B fire ratio], and set the ratio.

### Caution

- Flash units in group C will not fire when [Firing group] is set to [ (A:B)].

### Note

- Firing ratios from 8:1 to 1:1 to 1:8 correspond to 3:1 to 1:1 to 1:3 (in 1/2-stop increments) when converted to number of stops of exposure.



## Fully Automatic Shooting With Multiple External Flash Units and the Built-in Flash

The built-in flash can be added to [Fully Automatic Shooting With Multiple External Flash Units](#).

The basic settings are as follows, and by adjusting the **[Firing group]** setting, you can set up a variety of wireless multi-flash photography that also uses the built-in flash.

### Set these basic settings.

- **Flash mode:** E-TTL II
- **E-TTL II meter.:** Evaluative
- **Wireless func.:** [☞+☞]
- **Channel:** (same as receiver)

Built-in flash settings	
Built-in flash	CustWireless
Flash mode	E-TTL II
Shutter sync.	1st curtain
Wireless func.	☞+☞
Channel	1
☞ exp. comp.	2..1..@..1..2

### 1. Select **[Firing group]**.

Built-in flash settings	
Shutter sync.	1st curtain
Wireless func.	☞+☞
Channel	1
☞ exp. comp.	2..1..@..1..2
Firing group	All and ☞
☞ exp. comp.	2..1..@..1..2

- Select the firing group, then set the firing ratio, flash exposure compensation, and other required settings before shooting.

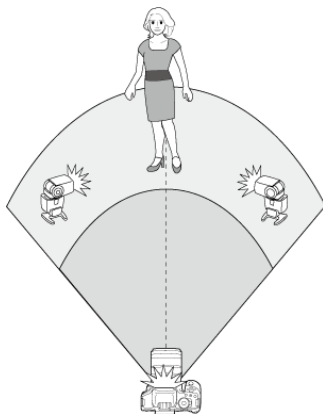

[All and ]

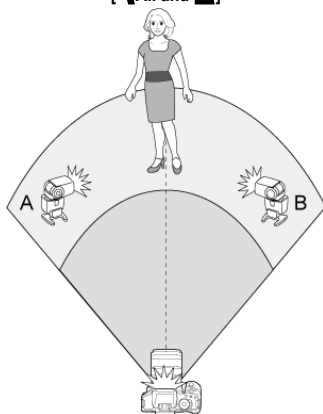

[A:B]

## Flash Exposure Compensation

Available when **[Flash mode]** is set to **[E-TTL II]**. Note that the setting items available for flash exposure compensation (see below) vary depending on **[Wireless func.]** and **[Firing group]** setting details.

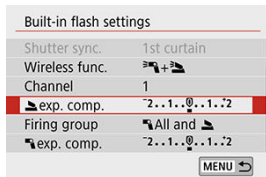

- **[Flash exposure compensation]**

The same amount of flash exposure compensation is set for the built-in flash and all external flash units.

- **[📡 exp. comp.]**

Enables you to apply flash exposure compensation to the built-in flash.

- **[📡 exp. comp.]**

The same amount of flash exposure compensation is set for all external flash units.

## FE Lock

You can lock the flash exposure by pressing the < \* > button when **[Flash mode]** is set to **[E-TTL II]**.

## Wireless Flash Photography With Manually Set Flash Output

Available when [Flash mode] is set to [Manual flash]. Available flash output options (such as [Flash output] and [Group A output]) vary depending on [Wireless func.] setting details (see below).

Built-in flash settings	
Built-in flash	CustWireless
Flash mode	Manual flash
Shutter sync.	1st curtain
Wireless func.	
Channel	1
Firing group	All

MENU

### [Wireless func.:

- [Firing group: All]  
The same manual flash output is set for all external flash units.
- [Firing group: (A:B)]  
Receivers can be assigned to flash group A or B, and you can set the flash output of each.

### [Wireless func.: +

- [Firing group: All and
  - [Firing group: (A:B)
- Enables you to set the flash output separately for external flash units and the built-in flash.
- Receivers can be assigned to flash group A or B, and you can set the flash output of each. You can also set the flash output for the built-in flash.

## Shooting and Recording

---

This chapter describes shooting and introduces menu settings on the shooting ([) tab.

- [Still Photo Shooting](#)
- [Movie Recording](#)

## Still Photo Shooting

---

☆ to the right of page titles indicates functions only available in Creative Zone modes.

- [Tab Menus: Still Photo Shooting \(Viewfinder Shooting\)](#)
- [Tab Menus: Still Photo Shooting \(Live View Shooting\)](#)
- [Image Quality](#)
- [Still Image Aspect Ratio](#)
- [Image Review Time](#)
- [Shutter Release Without Card](#)
- [Lens Aberration Correction](#) ☆
- [Exposure Compensation/AEB Setting](#) ☆
- [ISO Speed Settings \(Still Photos\)](#) ☆
- [Auto Lighting Optimizer](#) ☆
- [Highlight Tone Priority](#) ☆
- [Metering Timer \(Live View Shooting\)](#) ☆
- [White Balance Settings](#) ☆
- [White Balance Correction](#) ☆
- [Color Space](#) ☆
- [Picture Style Selection](#) ☆
- [Picture Style Customization](#) ☆
- [Picture Style Registration](#) ☆
- [Noise Reduction Features](#) ☆
- [Appending Dust Delete Data](#) ☆
- [Anti-Flicker Shooting](#) ☆
- [Continuous AF \(Live View Shooting\)](#)
- [Lens Electronic MF](#) ☆
- [AF-Assist Beam Firing](#)
- [General Still Photo Shooting Precautions](#)

# Tab Menus: Still Photo Shooting (Viewfinder Shooting)

## ● Shooting 1

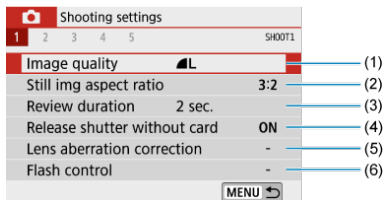

- (1) [Image quality](#)
- (2) [Still img aspect ratio](#) ☆
- (3) [Review duration](#)
- (4) [Release shutter without card](#)
- (5) [Lens aberration correction](#) ☆
- (6) [Flash control](#)

## ● Shooting 2

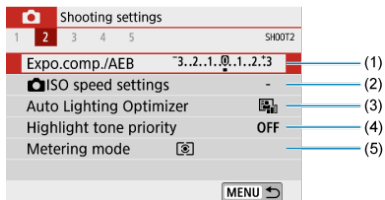

- (1) [Expo.comp./AEB](#) ☆
- (2) [ISO speed settings](#) ☆
- (3) [Auto Lighting Optimizer](#) ☆
- (4) [Highlight tone priority](#) ☆
- (5) [Metering mode](#) ☆

## ● Shooting 3

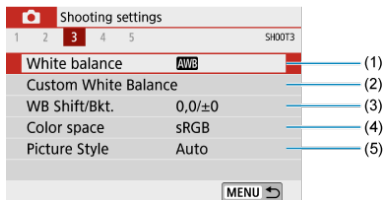

(1) [White balance](#) ☆

(2) [Custom White Balance](#) ☆

(3) [WB Shift/Bkt.](#) ☆

(4) [Color space](#) ☆

(5) [Picture Style](#) ☆

[Picture Style Selection](#) ☆

[Picture Style Customization](#) ☆

[Picture Style Registration](#) ☆

## ● Shooting 4

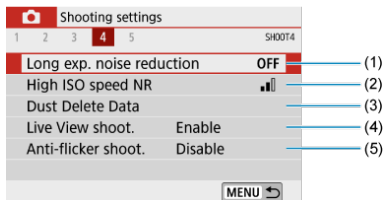

(1) [Long exp. noise reduction](#) ☆

(2) [High ISO speed NR](#) ☆

(3) [Dust Delete Data](#) ☆

(4) [Live View shoot.](#)

(5) [Anti-flicker shoot.](#) ☆



## ● Shooting 5



(1) [Lens electronic MF](#) ☆

(2) [AF-assist beam firing](#)

**In Basic Zone modes, the following screens are displayed.**

## ● Shooting 1

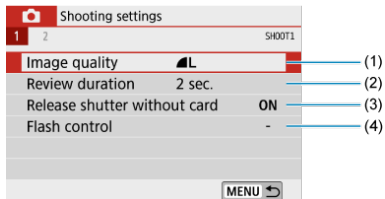

(1) [Image quality](#)

(2) [Review duration](#)

(3) [Release shutter without card](#)

(4) [Flash control](#)

## ● Shooting 2

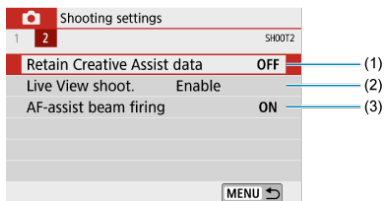

- (1) [Retain Creative Assist data](#)
- (2) [Live View shoot.](#)
- (3) [AF-assist beam firing](#)

## Tab Menus: Still Photo Shooting (Live View Shooting)

### ● Shooting 1

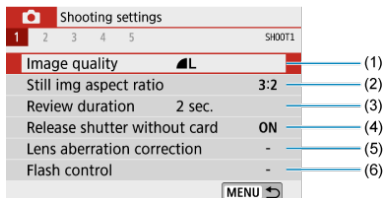

- (1) [Image quality](#)
- (2) [Still img aspect ratio](#)
- (3) [Review duration](#)
- (4) [Release shutter without card](#)
- (5) [Lens aberration correction](#) ☆
- (6) [Flash control](#)

### ● Shooting 2

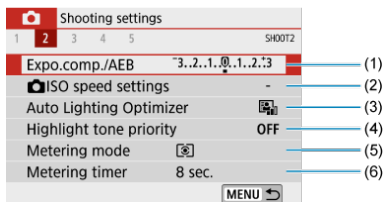

- (1) [Expo.comp./AEB](#) ☆
- (2) [ISO speed settings](#) ☆
- (3) [Auto Lighting Optimizer](#) ☆
- (4) [Highlight tone priority](#) ☆
- (5) [Metering mode](#) ☆
- (6) [Metering timer](#) ☆

## ● Shooting 3

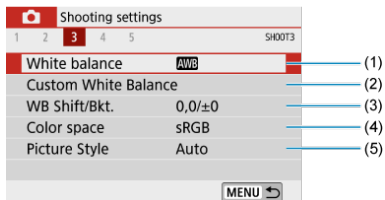

(1) [White balance](#) ☆

(2) [Custom White Balance](#) ☆

(3) [WB Shift/Bkt.](#) ☆

(4) [Color space](#) ☆

(5) [Picture Style](#) ☆

[Picture Style Selection](#) ☆

[Picture Style Customization](#) ☆

[Picture Style Registration](#) ☆

## ● Shooting 4

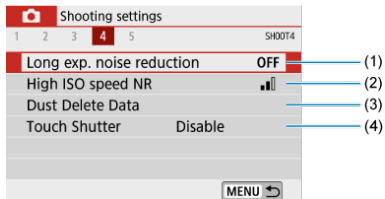

(1) [Long exp. noise reduction](#) ☆

(2) [High ISO speed NR](#) ☆

(3) [Dust Delete Data](#) ☆

(4) [Touch Shutter](#)

## ● Shooting 5

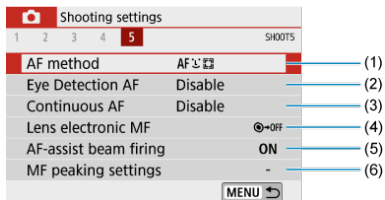

- (1) [AF method](#)
- (2) [Eye Detection AF](#)
- (3) [Continuous AF](#)
- (4) [Lens electronic MF](#) ☆
- (5) [AF-assist beam firing](#)
- (6) [MF peaking settings](#)

**In Basic Zone modes, the following screens are displayed. Note that available setting items vary by shooting mode.**

## ● Shooting 1

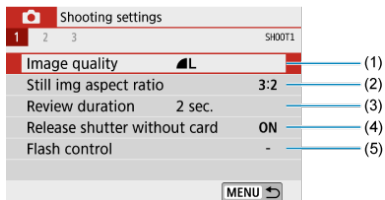

- (1) [Image quality](#)
- (2) [Still img aspect ratio](#)
- (3) [Review duration](#)
- (4) [Release shutter without card](#)
- (5) [Flash control](#)

## ● Shooting 2

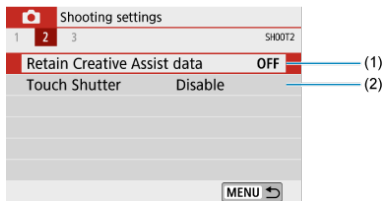

(1) [Retain Creative Assist data](#)

(2) [Touch Shutter](#)

## ● Shooting 3

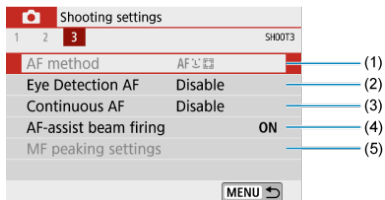

(1) [AF method](#)

(2) [Eye Detection AF](#)

(3) [Continuous AF](#)

(4) [AF-assist beam firing](#)

(5) [MF peaking settings](#)

# Image Quality

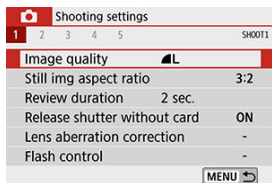

- ☑ [RAW Images](#)
- ☑ [Guide to Image Quality Settings](#)
- ☑ [Maximum Burst for Continuous Shooting](#)

## 1. Select [📷: Image quality].

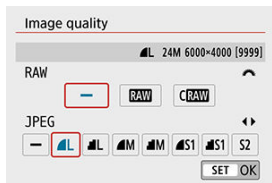

## 2. Set the image quality.



- To select the RAW quality, turn the <  > dial, and to select the JPEG quality, press the < ◀ > ▶ > keys.
- Press <  > to set it.

### ⚠ Caution

- Number of shots available as indicated by [\*\*\*\*] on the image quality setting screen always applies to a setting of [3:2], regardless of the actual aspect ratio setting (📷).



## Note



- If [-] is set for both the RAW image and JPEG image, will be set.
- If you select both RAW and JPEG, each time you shoot, the image will be recorded simultaneously to the card as both a RAW and JPEG image at your specified image qualities. The two images will be recorded with the same file numbers (file extension: .JPG for JPEG and .CR3 for RAW).
- **S2** is in (Fine) quality.
- Meaning of image quality icons: **RAW** RAW, **CRRAW** Compact RAW, JPEG, Fine, Normal, **L** Large, **M** Medium, **S** Small.



## RAW Images

---

RAW images are raw data from the image sensor that are recorded to the card digitally as **RAW** or **CRRAW** (smaller than **RAW**) files, depending on your selection.

RAW images can be processed using [: **RAW image processing**] () to save them as JPEG images. As the RAW image itself does not change, you can process the RAW image to create any number of JPEG images with various processing conditions.

You can use Digital Photo Professional (EOS software) to process RAW images. You can make various adjustments to images depending upon how they will be used and can generate JPEG or other types of images reflecting the effects of those adjustments.

### Note

- To display RAW images on a computer, consider using the EOS application Digital Photo Professional (hereafter DPP).
- Older versions of DPP Ver.4.x do not support display, processing, editing, or other operations with RAW images captured by this camera. If a previous version of DPP (Ver.4.x) is installed, obtain and install the latest version of DPP from the Canon website to update it () , which will overwrite the previous version. Similarly, DPP Ver.3.x or earlier does not support display, processing, editing, or other operations with RAW images captured by this camera.
- Commercially available software may not be able to display RAW images taken with this camera. For compatibility information, contact the software manufacturer.

## Guide to Image Quality Settings

---

See [Specifications](#) for details on file size, number of shots available, maximum burst, and other estimated values.

## Maximum Burst for Continuous Shooting



The approximate maximum burst is shown as a number or other indication at the top of the shooting screen in Live View shooting and in the lower right of the viewfinder in viewfinder shooting.

### Note

- When the maximum burst indicator is “99” in Live View shooting, you can shoot 99 shots or more continuously. The value starts decreasing once it reaches 98 or less.
- When the maximum burst indicator is “9” in viewfinder shooting, you can shoot 9 shots or more continuously. The value starts decreasing once it reaches 8 or less.
- “buSY” display in the viewfinder indicates that the internal buffer memory is full and shooting will stop temporarily. If you stop continuous shooting, the maximum burst will increase. After all captured images have been written to a card, you can once again shoot at the maximum burst listed in [Specifications](#).

# Still Image Aspect Ratio

---

You can change the image's aspect ratio.

---

## 1. Select [CAMERA]: Still img aspect ratio].

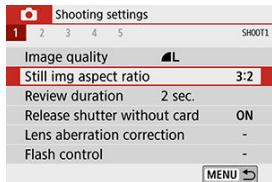

## 2. Set the aspect ratio.

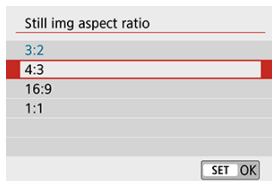





- Select an aspect ratio, then press < (SET) >.

- **JPEG images**

The images will be recorded with the set aspect ratio.

- **RAW images**

The images will always be recorded in the [3:2] aspect ratio. The selected aspect ratio information is added to the RAW image file, which enables Digital Photo Professional (EOS software) to generate an image with the same aspect ratio as set at the time of shooting when you process RAW images with this software.

	Aspect Ratio	Aspect Ratio	Aspect Ratio
	4:3	16:9	1:1
In viewfinder shooting			
In Live View shooting			

 **Note**

- RAW images shot at an aspect ratio of [4:3], [16:9], or [1:1] are displayed during playback with lines indicating the respective aspect ratio, but these lines are not recorded in the image.

## Image Review Time

---

Set to **[Hold]** to keep the captured image displayed after you shoot, or set to **[Off]** if you prefer not to have shots displayed.

---

### 1. Select **[: Review duration]**.

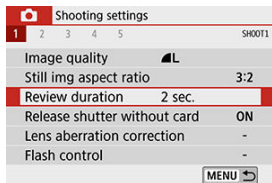

### 2. Set a time option.

#### Note

- When **[Hold]** is set, images are displayed until the time set in **[: Auto power off]** elapses.

# Shutter Release Without Card

---

You can set the camera not to shoot unless there is a card in the camera. The default setting is **[Enable]**.

---

1. Select **[📷: Release shutter without card]**.

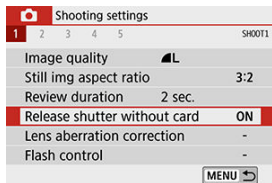

2. Select **[Disable]**.

- [Peripheral Illumination Correction](#)
- [Distortion Correction](#)
- [Digital Lens Optimizer](#)
- [Chromatic Aberration Correction](#)
- [Diffraction Correction](#)

Vignetting, image distortion, and other issues may be caused by lens optical characteristics. The camera can compensate for these phenomena by using **[Lens aberration correction]**.

## 1. Select [📷: Lens aberration correction].

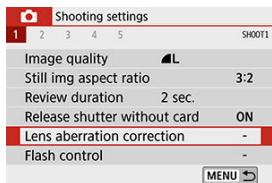

## 2. Select an item.

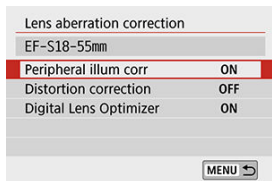

### 3. Select [Enable].

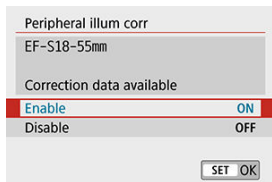

- Confirm that the name of the attached lens and [**Correction data available**] are displayed (except when [**Diffraction correction**] is set).
- If [**Correction data not available**] or [] is displayed, see [Digital Lens Optimizer](#).

## Peripheral Illumination Correction

Vignetting (dark image corners) can be corrected.

### Caution

- Depending on shooting conditions, noise may appear on the image periphery.
- The higher the ISO speed, the lower the correction amount will be.

### Note

- The correction amount applied will be lower than the maximum correction amount that applied with Digital Photo Professional (EOS software).
- Peripheral illumination is corrected automatically in Basic Zone modes when correction data is registered on the camera.



## Distortion Correction

Distortion (image warping) can be corrected.

### Caution

- To correct distortion, the camera captures a narrower image area than the area seen when shooting, which crops the image a little and slightly lowers the apparent resolution.
- Setting distortion correction may change the angle of view slightly.
- When you magnify images, distortion correction is not applied to the images displayed.
- Distortion correction is not applied in movie recording.
- Images with distortion correction applied will not have the Dust Delete Data (DD) appended. Also, the AF point may be displayed out of position, relative to the time of shooting.

### Note

- Distortion is corrected automatically when < **SCN** > mode is set to <  > mode with correction data registered on the camera.

## Digital Lens Optimizer

Various aberrations from lens optical characteristics can be corrected, along with diffraction and low-pass filter-induced loss of resolution.

If [**Correction data not available**] or  is displayed by [**Digital Lens Optimizer**], you can use EOS Utility to add the lens correction data to the camera. For details, refer to the EOS Utility Instruction Manual.

### Caution

- Depending on shooting conditions, noise may be intensified together with the effects of correction. Image edges may also be emphasized. Adjust Picture Style sharpness or set [**Digital Lens Optimizer**] to [**Disable**] as needed before shooting.
- The higher the ISO speed, the lower the correction amount will be.
- For movie recording, [**Digital Lens Optimizer**] will not appear. (Correction is not possible.)

### Note

- Enabling [**Digital Lens Optimizer**] will correct both chromatic aberration and diffraction when you shoot, although these options are not displayed.
- Digital Lens Optimizer is applied automatically in Basic Zone modes with correction data registered on the camera.

## Chromatic Aberration Correction

---

Chromatic aberration (color fringing around subjects) can be corrected.



### Note

- [Chromatic aberr corr] is not displayed when [Digital Lens Optimizer] is enabled.

## Diffraction Correction

---

Diffraction (loss of sharpness caused by the aperture) can be corrected.

### Caution

- Depending on shooting conditions, noise may be intensified together with the effects of correction.
- The higher the ISO speed, the lower the correction amount will be.
- For movie recording, **[Diffraction correction]** will not appear. (Correction is not possible.)

### Note

- "Diffraction correction" corrects diffraction as well as degraded resolution from the low-pass filter and other factors. Therefore, correction is effective even at an aperture close to the open aperture.
- **[Diffraction correction]** is not displayed when **[Digital Lens Optimizer]** is set to **[Enable]**.

### Caution

#### General precautions for lens aberration correction

- Peripheral illumination correction, chromatic aberration correction, distortion correction, and diffraction correction cannot be applied to JPEG images already taken.
- When using a non-Canon lens, setting the corrections to **[Disable]** is recommended even if **[Correction data available]** is displayed.
- Magnifying the periphery of the image may display parts of the image that will not be recorded.
- The correction amount will be less (except for diffraction correction) if the lens used does not have distance information.

 **Note****General notes for lens aberration correction**

- The effect of the lens aberration correction varies depending on the lens used and shooting conditions. Also, the effect may be difficult to discern depending on the lens used, shooting conditions, etc.
- If the correction is difficult to discern, magnifying and checking the image after shooting is recommended.
- Corrections can be applied even when an extender or life-size converter is attached.
- If the correction data for the attached lens is not registered to the camera, the result will be the same as when the correction is set to **[Disable]** (except for diffraction correction).
- If necessary, refer to the EOS Utility Instruction Manual as well.

You can capture three images at different shutter speeds, aperture values, and ISO speeds, as adjusted by the camera. This is called AEB.

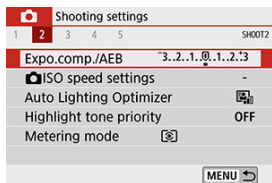

\* AEB stands for Auto Exposure Bracketing.

## 1. Select [CAMERA]: Expo.comp./AEB].

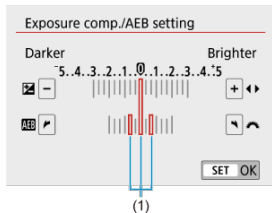

## 2. Set the AEB range.



- Turn the  dial to set the AEB range (1). Press the  < < > > keys to set the exposure compensation level.
- Press <  > to set it.
- When you press the shutter button halfway, the AEB range will be displayed in the viewfinder.

### 3. Take the picture.



Standard exposure



Decreased exposure



Increased exposure

- Three bracketed shots are taken, according to the specified drive mode, in this sequence: Standard exposure, decreased exposure, and increased exposure.
- AEB will not be automatically canceled. To cancel AEB, follow step 2 to turn off the AEB range display.

#### ! Caution

- Exposure compensation in AEB may be less effective with [Auto Lighting Optimizer] (☑) set to an option other than [Disable].

#### 📄 Note

- If the drive mode is set to [□], press the shutter button three times for each shot. When [📷] or [📷] is set and you hold down the shutter button completely, the three bracketed shots will be taken consecutively and the camera will automatically stop shooting. When [📷] or [📷] is set, three consecutive shots are captured after a delay of 10 or 2 sec. When set to [📷], three times the specified number of shots are taken in continuous shooting.
- You can set AEB in combination with exposure compensation.
- AEB is not available with flash, Multi Shot Noise Reduction, Creative filter, or bulb shooting.
- AEB is canceled automatically if the power switch is set to <OFF> or when the flash is fully charged.

[\[AUTO\] ISO Speed](#)

[Maximum \[AUTO\] ISO Speed](#)

Set the ISO speed (image sensor's sensitivity to light) to suit the ambient light level. In Basic Zone modes, ISO speed is set automatically. For details on ISO speed in movie recording, see [ISO Speed in Movie Recording](#).

---

1. Press the <ISO> button (ⓘ6).

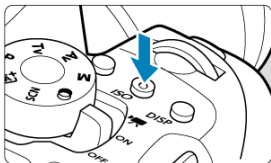



## 2. Set the ISO speed.

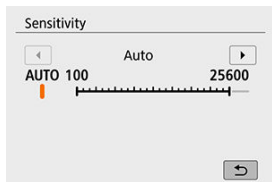

- Select the ISO speed with the <◀> <▶> keys or the <⚙> dial while watching the viewfinder or screen, then press <SET>.
- ISO speed can be set within ISO 100–25600.
- With [AUTO] selected, the ISO speed will be set automatically (☑).

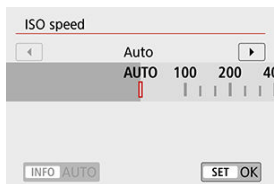

- To specify [AUTO] when setting [ISO speed] in [📷:📷 ISO speed settings] (shown above), you can press the <INFO> button.

## ISO speed guide

- Low ISO speeds reduce image noise but may increase the risk of camera/subject shake or reduce the area in focus (shallower depth of field), in some shooting conditions.
- High ISO speeds enable low-light shooting, a larger area in focus (deeper depth of field), and longer flash range but may increase image noise.

### Note

- Can also be set on the **[ISO speed]** screen in **[ISO speed settings]**.
- Under **[Custom Functions(C.Fn)]**, if **[ISO expansion]** is set to **[1:Enable]**, **"H"** (equivalent to ISO 51200) can also be selected .

### Caution

- If **[Highlight tone priority]** is set to **[Enable]** or **[Enhanced]**, ISO 100/125/160 and **"H"** (equivalent to ISO 51200) cannot be selected .
- Shooting in high temperatures may result in images that look grainier. Long exposures may also cause irregular colors in the image.
- When you shoot at high ISO speeds, noise (such as dots of light and banding) may become noticeable.
- If you use a high ISO speed and flash to shoot a close subject, overexposure may result.
- When shooting in conditions that produce an extreme amount of noise, such as a combination of high ISO speed, high temperature, and long exposure, images may not be recorded properly.
- As **"H"** (equivalent to ISO 51200) is an expanded ISO speed setting, noise (dots of light, banding, etc.) and irregular colors will be more noticeable, and the resolution will be lower compared to the standard setting.

## [AUTO] ISO Speed

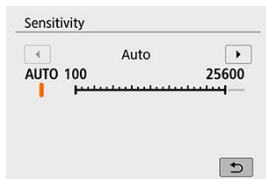

- If the ISO speed is set to **[AUTO]**, the actual ISO speed setting will be displayed in the viewfinder or on the screen when you press the shutter button halfway.
- When **[AUTO]** is set, the ISO speed is indicated in whole-stop increments. However, the ISO speed is actually set in finer increments. Therefore, in the image's shooting information (📷), you may find an ISO speed such as ISO 125 or ISO 640 displayed as the ISO speed.

## Maximum [AUTO] ISO Speed

For ISO Auto, you can set the maximum ISO speed limit within ISO 400–25600.

### 1. Select [CAMERA: CAMERA] ISO speed settings.

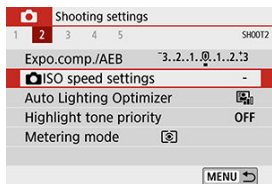

### 2. Select [Max for Auto].

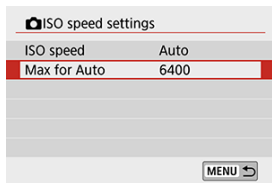

- Select [Max for Auto], then press < (SET) >.

### 3. Select the ISO speed.

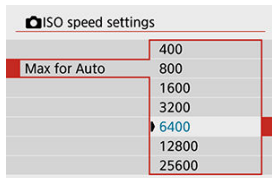

- Select the ISO speed, then press < (SET) >.

Brightness and contrast can be corrected automatically if shots look dark or contrast is too low or high.

## 1. Select [📷: Auto Lighting Optimizer].

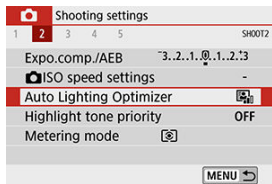

## 2. Set a correction option.

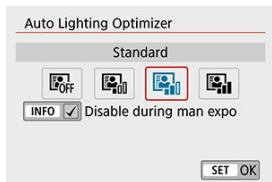

### ⚠ Caution

- Noise may increase and apparent resolution may change, under some shooting conditions.
- If the effect of Auto Lighting Optimizer is too strong and results are not at your preferred brightness, set to [Low] or [Disable].
- If a setting other than [Disable] is set and you use exposure compensation or flash exposure compensation to darken the exposure, the image may still come out bright. If you want a darker exposure, set this function to [Disable].
- Maximum burst is lower with [High]. Image recording to the card also takes longer.



#### Note

- In step 2, if you press the <INFO> button and remove the checkmark [✓] for [Disable during man expo] setting, [📷: Auto Lighting Optimizer] can also be set even in <M> mode.

You can reduce overexposed, clipped highlights.

## 1. Select [📷: Highlight tone priority].

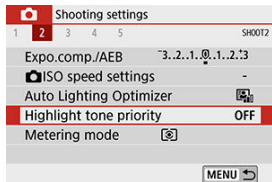

## 2. Set an option.

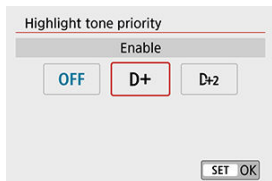

- **[Enable]**: Improves gradation in highlights. The gradation between the grays and highlights becomes smoother.
- **[Enhanced]**: Reduces overexposed highlights even more than **[Enable]**, under some shooting conditions.

### ⚠ Caution

- Noise may increase slightly.
- The available ISO range starts at ISO 200. Expanded ISO speeds cannot be set.
- **[Enhanced]** is not available when recording movies.
- With **[Enhanced]**, results in some scenes may not look as expected.

You can set how long the metering timer runs (which determines the duration of exposure display/AE lock) after it is triggered by an action such as pressing the shutter button halfway.

1. Select [📷: Metering timer].
2. Set a time option.

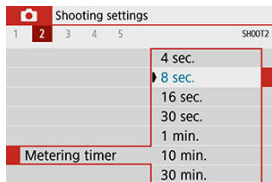



- ☑ [White Balance](#)
- ☑ [\[AWB\] Auto White Balance](#)
- ☑ [\[ \] Custom White Balance](#)
- ☑ [\[K\] Color Temperature](#)

White balance (WB) is for making the white areas look white. Normally, the Auto **[AWB]** (Ambience priority) or **[AWBW]** (White priority) setting will obtain the correct white balance. If natural-looking colors cannot be obtained with Auto, you can select the white balance to match the light source or set it manually by shooting a white object.



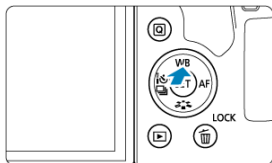



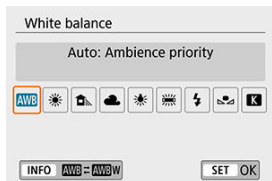



1. Press the <WB> button.



2. Select an option.



(Approx.)

Display	Mode	Color Temperature (K: Kelvin)
	<a href="#">Auto: Ambience priority</a>	3000–7000
	<a href="#">Auto: White priority</a>	
	Daylight	5200
	Shade	7000
	Cloudy, twilight, sunset	6000
	Tungsten light	3200
	White fluorescent light	4000
	Flash	Automatically set*
	<a href="#">Custom</a>	2000–10000
	<a href="#">Color temp.</a>	2500–10000

\* Applicable with Speedlites having a color temperature transmission function. Otherwise, it will be fixed to approx. 6000K.

## White Balance

To the human eye, a white object looks white regardless of the type of lighting. Digital cameras determine white from the color temperature of lighting and, based on this, apply image processing to make color tones look natural in your shots.

## [AWB] Auto White Balance

With [AWB], you can slightly increase the intensity of the image's warm color cast when shooting a tungsten-light scene.

If you select [AWBW], you can reduce the intensity of the image's warm color cast.

### 1. Select [📷: White balance].

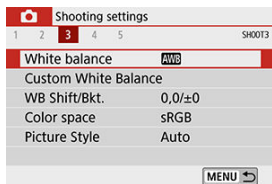

### 2. Select [AWB].

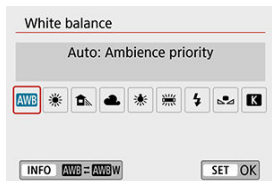

- With [AWB] selected, press the <INFO> button.

### 3. Select an option.

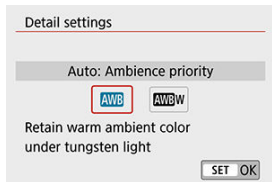

 Caution

**Precautions when set to [AWBW]**

- The warm color cast of subjects may fade.
- When multiple light sources are included in the scene, the warm color cast of the picture may not be reduced.
- When using flash, the color tone will be the same as with [AWB].

## [] Custom White Balance

With custom white balance, you can manually set the white balance for the specific light source of the shooting location. Always follow these steps under the light source you will use when shooting.

### 1. Shoot a white object.

- Aim the camera at a plain white subject, so that white fills the screen.
- Focus manually and shoot with the standard exposure set for the white object.
- You can use any of the white balance settings.

### 2. Select [: Custom White Balance].

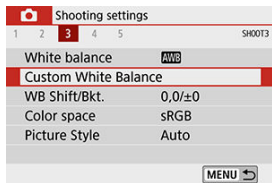

### 3. Import the white balance data.



- Press the < ◀ ▶ > keys to select the image captured in step 1, then press <  >.  
Select [**OK**] to import the data.

4. Select [: White balance].

5. Select [].

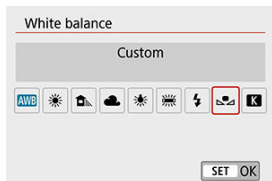

#### Caution

- If the exposure obtained in step 1 differs greatly from the standard exposure, a correct white balance may not be obtained.
- These images cannot be selected: Images captured with Picture Style set to **[Monochrome]**, images with a Creative filter applied before or after shooting, cropped images, or images shot with another camera.
- Images that cannot be used in the setting may be displayed.

#### Note

- Instead of shooting a white object, you can also shoot a gray chart or standard 18% gray reflector (commercially available).

### 1. Select [K]: White balance.

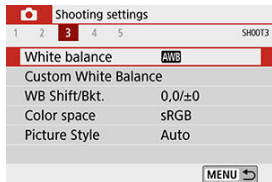

### 2. Set the color temperature.

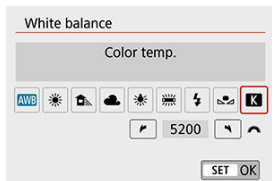

- Select [K].
- Turn the < [Sun] > dial to set the desired color temperature, then press < [SET] >.
- The color temperature can be set from approx. 2500K to 10000K in 100K increments.

#### ! Caution

- When setting the color temperature for an artificial light source, set the white balance correction (magenta or green bias) as necessary.
- If you set [K] to the reading taken with a commercially available color temperature meter, take test shots and adjust the setting to compensate for the difference between the color temperature meter's reading and the camera's color temperature reading.

[White Balance Correction](#)

[White Balance Auto Bracketing](#)

White balance correction has the same effect as using a commercially available color temperature conversion filter or color compensating filter.

## White Balance Correction

### 1. Select [CAMERA]: WB Shift/Bkt.].

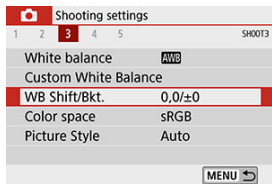



## 2. Set the white balance correction.

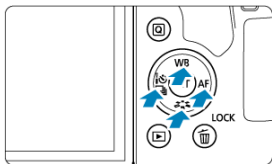

Sample setting: A2, G1

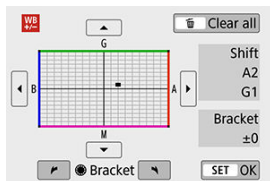

- Press the <▲> <▼> or <◀> <▶> keys to move the “■” mark to your preferred position.
- B is for blue, A for amber, M for magenta, and G for green. White balance is corrected in the direction you move the mark. On the right of the screen, **[Shift]** indicates the direction and correction amount, respectively.
- Pressing the <🗑️> button will cancel all the **[WB Shift/Bkt.]** settings.
- Press <ⓈET> to exit the setting.

### Note

- One level of the blue/amber correction is equivalent to approx. 5 mireds of a color temperature conversion filter. (Mired: Unit of measure for color temperature used to indicate values such as the density of a color temperature conversion filter.)

## White Balance Auto Bracketing

White balance bracketing (WB Bkt.) enables you to capture three images at once with different color tones.

### Set the white balance bracketing amount.

B/A bias  $\pm 3$  levels

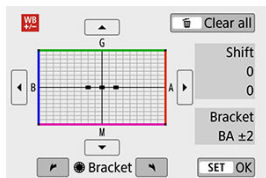

- In step 2 for [White Balance Correction](#), when you turn the  $\langle \odot \rangle$  dial, the "■" mark on the screen will change to "■ ■ ■" (3 points).
- Turning the dial clockwise sets the B/A bracketing, and turning it counterclockwise sets the M/G bracketing.  
On the right, [**Bracket**] indicates the bracketing direction and correction amount.
- Pressing the  $\langle \text{Trash} \rangle$  button will cancel all the [**WB Shift/Bkt.**] settings.
- Press  $\langle \text{SET} \rangle$  to exit the setting.

#### ! Caution

- During white balance bracketing, the maximum burst for continuous shooting will be lower.
- Since three images are recorded for one shot, it takes longer to record the image to the card.

#### 📄 Note

- The images will be bracketed in the following sequence: 1. Standard white balance, 2. Blue (B) bias, and 3. Amber (A) bias, or 1. Standard white balance, 2. Magenta (M) bias, and 3. Green (G) bias.
- You can also set white balance correction and AEB together with white balance bracketing. If you set AEB in combination with white balance bracketing, a total of nine images will be recorded for a single shot.
- In Live View shooting, the white balance icon blinks when white balance bracketing has been set.
- "**Bracket**" stands for bracketing.

The range of reproducible colors is called the “color space.” For normal shooting, sRGB is recommended.

1. Select [📷: Color space].
2. Set a color space option.

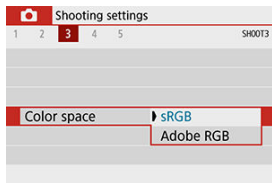

## Adobe RGB

This color space is mainly used for commercial printing and other industrial uses. Recommended when using equipment such as Adobe RGB-compatible monitors or DCF 2.0 (Exif 2.21 or later) compatible printers.

### Note

- File names of still photos shot in the Adobe RGB color space begin with “\_”.
- The ICC profile is not appended. For the descriptions about the ICC profile, refer to the Digital Photo Professional Instruction Manual (EOS software).
- In Basic Zone, [sRGB] is set automatically.

## [Picture Style Characteristics](#)

## [Symbols](#)

Just by selecting a preset Picture Style, you can obtain image characteristics effectively matching your photographic expression or the subject.

### 1. Press the button.

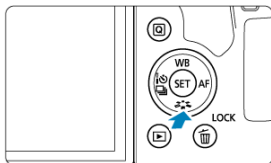

- The Picture Style selection screen will appear.

### 2. Select a Picture Style.

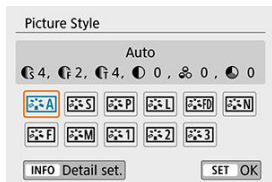

- Select a Picture Style, then press .
- The Picture Style will be set.

#### Note

- You can also make your selection from  **Picture Style**.

## Picture Style Characteristics

- **[A]** **Auto**

The color tone will be adjusted automatically to suit the scene. The colors will look vivid for blue skies, greenery and sunsets, particularly in nature, outdoor, and sunset scenes.



### Note

- If the desired color tone is not obtained with **[Auto]**, use another Picture Style.

- **[S]** **Standard**

The image looks vivid, sharp, and crisp. Suitable for most scenes.

- **[P]** **Portrait**

For nice skin tones. The image looks softer. Suited for close-up portraits.

Skin tone can be adjusted by changing **[Color tone]** as described in [Settings and Effects](#).

- **[L]** **Landscape**

For vivid blues and greens, and very sharp and crisp images. Effective for impressive landscapes.

- **[F]** **Fine Detail**

For detailed rendering of fine subject contours and subtle textures. The colors will be slightly vivid.

- **[N]** **Neutral**

Suited for processing the image with a computer. For natural colors and subdued images with modest brightness and color saturation.

- **[F]** **Faithful**

Suited for processing the image with a computer. The color of a subject that is captured in sunlight at a color temperature of 5200K will be adjusted to match the subject's colorimetric color. For subdued images with modest brightness and color saturation.

-  **Monochrome**

Creates black-and-white images.

 **Caution**

- Color images cannot be recovered from JPEG images shot with the **[Monochrome]** Picture Style.

 **Note**

- You can also set the camera to display < ! > in the viewfinder for when **[Monochrome]** is set ()

-  **User Def. 1-3**

You can register a basic style such as **[Portrait]**, **[Landscape]**, a Picture Style file, etc. and adjust it as desired () . With any User Defined Picture Style that has not yet been registered, pictures will be taken with the same characteristics settings as with the default settings of **[Auto]**.

## Symbols

The Picture Style selection screen has icons for **[Strength]**, **[Fineness]**, or **[Threshold]** for **[Sharpness]** as well as **[Contrast]** and other parameters. The numbers indicate the values for these settings specified for the respective Picture Style.



●	<b>Sharpness</b>	
		<b>Strength</b>
		<b>Fineness</b>
		<b>Threshold</b>
●	<b>Contrast</b>	
●	<b>Saturation</b>	
●	<b>Color tone</b>	
●	<b>Filter effect (Monochrome)</b>	
●	<b>Toning effect (Monochrome)</b>	

### ⚠ Caution

- During movie recording, an asterisk "\*" will be displayed for both **[Fineness]** and **[Threshold]** for **[Sharpness]**. **[Fineness]** and **[Threshold]** will not be applied to movies.

☑ [Settings and Effects](#)

☑ [\[P\] Monochrome Adjustment](#)

You can customize any Picture Style by changing it from the default settings. For details on customizing **[Monochrome]**, see [\[P\] Monochrome Adjustment](#).

## 1. Press the < P > button.

- The Picture Style selection screen will appear.

## 2. Select a Picture Style.

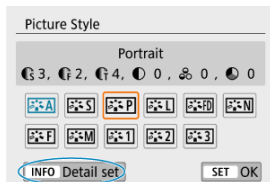

- Select the Picture Style to adjust, then press the < INFO > button.

## 3. Select an option.



- For details on settings and effects, see [Settings and Effects](#).





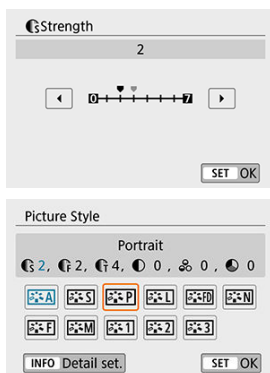



#### 4. Set the effect level.



- Press the < MENU > button to save the adjusted setting and return to the Picture Style selection screen.
- Any settings you change from default values are displayed in blue.

## Settings and Effects

Sharpness				
		<b>Strength</b>	0: Weak outline emphasis	7: Strong outline emphasis
		<b>Fineness</b> <sup>*1</sup>	1: Fine	5: Grainy
		<b>Threshold</b> <sup>*2</sup>	1: Low	5: High
	<b>Contrast</b>		-4: Low contrast	+4: High contrast
	<b>Saturation</b>		-4: Low saturation	+4: High saturation
	<b>Color tone</b>		-4: Reddish skin tone	+4: Yellowish skin tone

\* 1: Indicates the fineness of the outlines to be emphasized. The smaller the number, the finer the outlines that can be emphasized.

\* 2: Sets how much the outline is emphasized based on the difference in contrast between the subject and the surrounding area. The smaller the number, the more the outline will be emphasized when the contrast difference is low. However, noise tends to be more noticeable when the number is smaller.

### Note

- For movie recording, **[Fineness]** and **[Threshold]** for **[Sharpness]** cannot be set (not displayed).
- By selecting **[Default set.]** in step 3, you can restore the parameter settings of the respective Picture Style to their defaults.
- To shoot with the Picture Style you adjusted, first select the adjusted Picture Style, then shoot.

## [] Monochrome Adjustment

### [] Filter effect

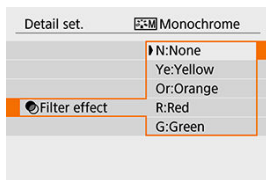

With a filter effect applied to a monochrome image, you can make white clouds or green trees stand out more.

Filter	Sample Effects
<b>N:None</b>	Normal black-and-white image with no filter effects.
<b>Ye:Yellow</b>	The blue sky will look more natural, and the white clouds will look crisper.
<b>Or:Orange</b>	The blue sky will look slightly darker. The sunset will look more brilliant.
<b>R:Red</b>	The blue sky will look quite dark. Fall leaves will look crisper and brighter.
<b>G:Green</b>	Skin tones and lips will appear muted. Green tree leaves will look crisper and brighter.

#### Note

- Increasing the [**Contrast**] will make the filter effect more pronounced.

## [🔍] Toning effect

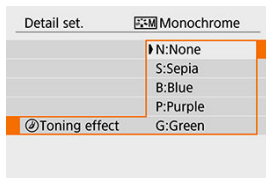

By applying a toning effect, you can create a monochrome image in the selected color. Effective when you want to create memorable images.

You can select a base Picture Style such as **[Portrait]** or **[Landscape]**, adjust it as desired, and register it under **[User Def. 1]**–**[User Def. 3]**. Useful when creating several Picture Styles with different settings.

Picture Styles that you have registered on the camera using EOS Utility (EOS software, [🔗](#)) can also be modified here.

## 1. Press the **< >** button.

- The Picture Style selection screen will appear.

## 2. Select a user-defined style number.

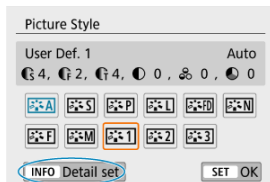

- Select a number from **[User Def. 1]** to **[User Def. 3]**, then press the **< INFO >** button.

## 3. Press **< (SET) >**.

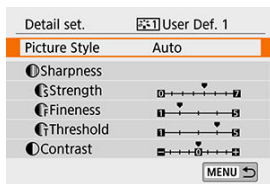

- With **[Picture Style]** selected, press **< (SET) >**.

#### 4. Select the base Picture Style.

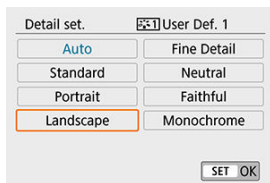

- Select the base Picture Style.
- Also select styles this way when adjusting styles registered to the camera with EOS Utility (EOS software).

#### 5. Select an item.

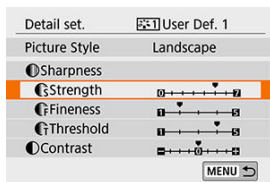

## 6. Set the effect level.

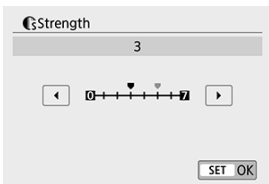

- For details, see [Picture Style Customization](#).

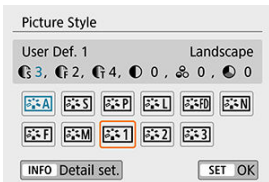

- Press the <MENU> button to save the adjusted setting and return to the Picture Style selection screen.  
The base Picture Style will be indicated on the right of [User Def. \*].  
Blue style names indicate that you have changed the settings from default values.

### Caution

- If a Picture Style is already registered under [User Def. \*], changing the base Picture Style will clear the parameter settings of the previously registered User Defined Picture Style.
- All [User Def. \*] settings are reset when [Clear all camera settings] in [Clear settings] (🔗) is performed.

### Note

- To shoot with a registered Picture Style, select the registered [User Def. \*], then shoot.
- Regarding the procedure to register a Picture Style file to the camera, refer to the EOS Utility Instruction Manual (🔗).

[Long Exposure Noise Reduction](#)

[High ISO Speed Noise Reduction](#)

## Long Exposure Noise Reduction

For images exposed for 1 sec. or longer, noise (dots of light and banding) typical of long exposures can be reduced.

1. Select [📷]: Long exp. noise reduction].

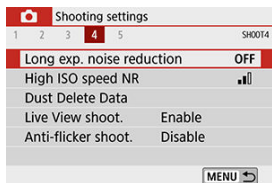



## 2. Set a reduction option.

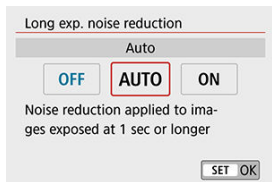

- **[AUTO] Auto**  
For exposures of 1 sec. or longer, noise reduction is performed automatically if noise typical of long exposures is detected. This setting is effective enough in most cases.
- **[ON] Enable**  
Noise reduction is performed for all exposures of 1 sec. or longer. The **[Enable]** setting may reduce noise that cannot be detected with the **[Auto]** setting.

### ! Caution

- With **[Auto]** or **[Enable]** set, noise reduction after you shoot may take as long as exposure for the shot.
- Images may look grainier with the **[Enable]** setting than with the **[Disable]** or **[Auto]** setting.
- With **[Enable]** set, shooting long exposures during Live View display will stop Live View display (and prevent your next shot) until the camera is finished with noise reduction, indicated by **[BUSY]** display. The Live View display will not appear until the noise reduction is complete. (You cannot take another picture.)

## High ISO Speed Noise Reduction

This function reduces the noise generated in the image. This function is especially effective when shooting at high ISO speeds. When shooting at low ISO speeds, the noise in the darker parts of the image (shadow areas) can further be reduced.

### 1. Select [High ISO speed NR].

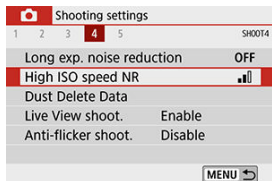

### 2. Set the level.

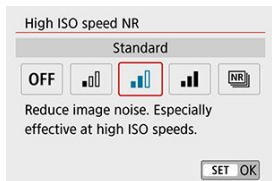

### ● [Multi Shot Noise Reduction]

Applies the noise reduction with higher image quality than [High]. For a single photo, four shots are taken continuously and aligned and merged automatically into a single JPEG image.

If the image quality is set to RAW or RAW+JPEG, you cannot set [Multi Shot Noise Reduction].

 Caution

**[Multi Shot Noise Reduction] Precautions**

- If there is significant misalignment in the image due to camera shake, the noise reduction effect may become smaller.
- Be careful about camera shake in handheld shots. Using a tripod is recommended.
- If you shoot a moving subject, the moving subject may leave afterimages.
- Auto image alignment may not function properly with repetitive patterns (lattice, stripes, etc.) or flat, single-tone images.
- If the subject's brightness changes as the four consecutive shots are taken, irregular exposure in the image may result.
- After shooting, it may take some time to record an image to the card after performing noise reduction and merging the images. "buSY" and "BUSY" appear in the viewfinder and on the screen, respectively, as images are processed. Shooting is not possible until processing is finished.
- **[Multi Shot Noise Reduction]** is not available with bulb shooting, shooting with AEB or white balance bracketing, shooting RAW or RAW+JPEG images, or with features such as long exposure noise reduction.
- Flash photography is not possible. Note that the AF-assist beam may be fired, depending on the : **AF-assist beam firing** setting.
- **[Multi Shot Noise Reduction]** is not available (not displayed) when recording movies.
- The camera automatically switches to **[Standard]** if you set the power switch to < **OFF** >, replace the battery or card, or switch to Basic Zone modes, bulb exposure, or movie recording.

[Preparation](#)

[Dust Delete Data Acquisition](#)

[Dust Delete Data Appending](#)

Dust Delete Data used to erase dust spots can be appended to images in case sensor cleaning leaves dust on the sensor. The Dust Delete Data is used by Digital Photo Professional (EOS software) to erase the dust spots automatically.

---

### Preparation

---

- Prepare a solid white object such as a sheet of paper.
- Set the lens focal length to 50 mm or longer.
- Set the lens's focus mode switch to **<MF>** and set the focus to infinity ( $\infty$ ).

### 1. Select [📷: Dust Delete Data].

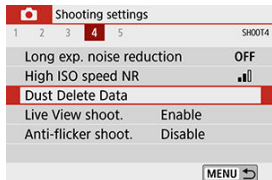

## 2. Select [OK].

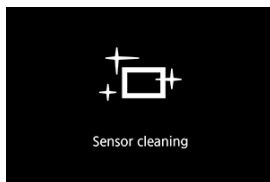
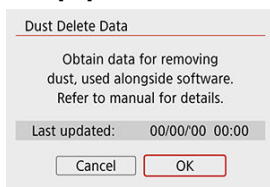

- After the automatic self-cleaning of the sensor is performed, a message will appear. Although there will be a mechanical sound of the shutter during the cleaning, no picture is taken.

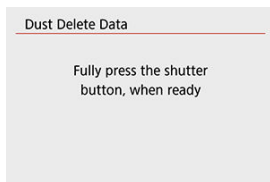

### 3. Shoot a plain white object.

- Shoot with a plain white object (such as a new sheet of white paper) filling the screen, at a distance of 20–30 cm (0.7–1.0 ft.).
- Since the image will not be saved, the data can still be obtained even if there is no card in the camera.

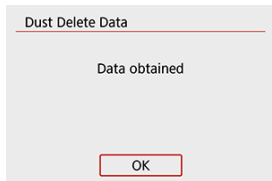

- When the picture is taken, the camera will start collecting the Dust Delete Data. When the Dust Delete Data is obtained, a message will appear.
- If the data is not obtained successfully, an error message will appear. Check the information in [Preparation](#), select **[OK]**, and shoot again.







## Dust Delete Data Appending

Once acquired, Dust Delete Data is appended to still photos captured after that point. Acquiring Dust Delete Data before shooting is recommended.

For details about using Digital Photo Professional (EOS software) to erase dust spots automatically, refer to the Digital Photo Professional Instruction Manual.

File size is essentially unaffected by Dust Delete Data appended to images.

### Caution

- If the object has any pattern or design, it may be recognized as dust data and affect the accuracy of the dust deletion with the Digital Photo Professional (EOS software).
- Dust Delete Data is not added to shots taken under the following conditions.
  - Captured in [] (< **SCN** > mode) shooting
  - Captured in []/[]/[]/[] (<  > mode) shooting
  - Captured with [**Distortion correction**] in [: **Lens aberration correction**] set to [**ON**]



Uneven exposure and color may result if you shoot at fast shutter speeds under flickering light sources such as fluorescent lights, due to uneven vertical exposure. Anti-flicker shooting enables viewfinder shooting at moments when exposure and colors are less affected by flickering.

## 1. Select [📷: Anti-flicker shoot.].

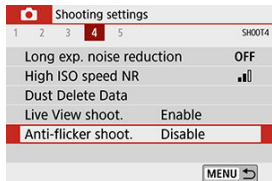

## 2. Select [Enable].

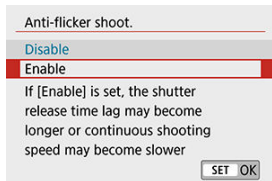

## 3. Take the picture.

## Caution

- When **[Enable]** is set and you shoot under a flickering light source, the shutter-release time lag may become longer. Also, the continuous shooting speed may become slower, and the shooting interval may become irregular.
- Not applied to mirror lockup shots, Live View shooting, or movie recording.
- Flicker at a frequency other than 100 Hz or 120 Hz cannot be detected. Also, if the flickering frequency of the light source changes during continuous shooting, effects of the flicker cannot be reduced.
- In the < **P** > or < **Av** > mode, if the shutter speed changes during continuous shooting or if you shoot multiple shots of the same scene at different shutter speeds, the color tone may become inconsistent. To avoid inconsistent color tone, shoot in < **M** > or < **Tv** > mode at a fixed shutter speed.
- Color tone of captured images may vary between **[Enable]** and **[Disable]**.
- Shutter speed, aperture value, and ISO speed may change when you start shooting with AE lock.
- If the subject is against a dark background or if there is a bright light in the image, flicker may not be properly detected.
- Flicker reduction may not be possible under special lighting.
- Depending on the light source, flicker may not be detected properly.
- Depending on the light sources or shooting conditions, the expected result may not be obtained even if you use this function.

## Note

- Taking test shots in advance is recommended.
- When you shoot with flicker reduction, **[Flicker!]** will light up. If **[Flicker!]** does not appear in the viewfinder, set **[Flicker detection]** in **[☛: Viewfinder display]** to **[Show]** . Under a light source that does not flicker or with no flicker detected, **[Flicker!]** will not be displayed.
- Even if you set **[☑: Anti-flicker shoot.]** to **[Disable]**, with **[Flicker detection]** set to **[Show]**, **[Flicker!]** in the viewfinder will blink to warn you if the camera meters under a flickering light source.
- In Basic Zone, **[Flicker!]** will not be displayed, but the effects of flicker will be reduced when you shoot.
- The expected result may not be obtained for wireless flash photography.

## Continuous AF (Live View Shooting)

This function keeps subjects generally in focus in Live View shooting. The camera is ready to focus immediately when you press the shutter button halfway.

### 1. Select [CAMERA]: Continuous AF].



### 2. Select [Enable].



#### Caution

- Enabling this function reduces the number of shots available, because the lens is driven continuously and battery power is consumed.

For EF or EF-S lenses equipped with electronic manual focusing, you can specify how manual focus adjustment is used with One-Shot AF.

## 1. Select [📷: Lens electronic MF].

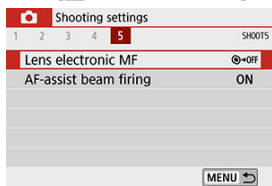

## 2. Select an option.

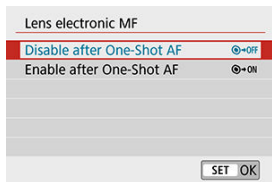

- **Disable after One-Shot AF**

After the AF operation, manual focusing adjustment is disabled.

- **Enable after One-Shot AF**

You can manually adjust the focus after the AF operation if you keep holding down the shutter button halfway.

### ⚠ Caution

- For details on your lens's manual focus specifications, refer to the lens instruction manual.

# AF-Assist Beam Firing

You can specify to use the AF-assist beam of the built-in flash or a Speedlite in viewfinder shooting.

## 1. Select [CAMERA]: AF-assist beam firing].



## 2. Select an option.

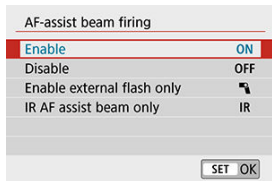

- **[ON] Enable**  
Enables firing of the AF-assist beam, when needed.  
Raise the built-in flash if you will use it to fire the AF-assist beam.
- **[OFF] Disable**  
Disables firing of the AF-assist beam. Set if you prefer not to fire the AF-assist beam.
- **[CAMERA] Enable external flash only**  
Enables firing of the AF-assist beam when needed, only when external Speedlites are used.
- **[IR] IR AF assist beam only**  
Enables infrared AF-assist beam firing by external Speedlites equipped with this feature, when these flash units are attached.

 **Caution**

- If an external Speedlite's **[AF-assist beam firing]** Custom Function is set to **[1:Disabled]**, the AF-assist beam will not be fired.

 **Note**

- The AF-assist beam of an attached EX series Speedlite equipped with an LED light will fire as needed from the Speedlite's LED light in Live View shooting when you specify **[Enable]** or **[Enable external flash only]**.

## General Still Photo Shooting Precautions

---

- [Both Viewfinder and Live View Shooting](#)
- [In Live View Shooting](#)
- [Information Display in Live View Shooting](#)

### Both Viewfinder and Live View Shooting

---

#### Caution

##### Image quality

- When you shoot at high ISO speeds, noise (such as dots of light and banding) may become noticeable.
- Shooting in high temperatures may cause noise and irregular colors in the image.









### Caution

- Do not point the camera toward an intense light source, such as the sun or an intense artificial light source. Doing so may damage the image sensor or the camera's internal components.

### Image quality

- Frequent shooting over an extended period may cause the camera's internal temperature to rise and affect image quality. When you are not shooting, always turn off the camera.
- If you shoot a long exposure while the camera's internal temperature is high, image quality may decline. Stop shooting and wait a few minutes before shooting again.

### White and red icons

- If the camera's internal temperature rises from extended shooting or use in hot environments, a white  or red  icon will appear.
- The white  icon indicates that the image quality of still photos will decline. Stop shooting for a while and allow the camera to cool down.
- Shooting at low ISO speeds instead of high speeds is recommended when the white  icon is displayed.
- The red  icon indicates that shooting will soon end automatically. Shooting will not be possible again until the camera cools down internally, so stop shooting temporarily or turn off the camera and let it cool down a while.
- Shooting in hot environments over extended periods will cause the white  or red  icon to appear sooner. When you are not shooting, always turn off the camera.
- If the camera's internal temperature is high, the quality of images shot with a high ISO speed or long exposure may decline even before the white  icon is displayed.

### Shooting results

- In magnified view, the shutter speed and aperture value will be displayed in red. If you take the picture in magnified view, the exposure may not come out as desired. Return to the normal view before taking the picture.
- Even if you take the picture in magnified view, the image will be captured with the image area of the normal view.



## Images and display

- Under low- or bright-light conditions, the displayed image may not reflect the brightness of the captured image.
- Under low light, noise may be noticeable in image display even at low ISO speeds, but there will be less noise in your shots, because image quality varies between display and captured images.
- The screen or exposure value may flicker if the light source (lighting) changes. In this case, stop shooting temporarily and resume under the light source you will use.
- Pointing the camera at different direction may momentarily prevent correct display of brightness. Wait until the brightness level stabilizes before shooting.
- If there is a very bright light source in the image, the bright area may appear black on the screen. However, the actual captured image will correctly show the bright area.
- In low light, if you set [: **Disp. brightness**] to a bright setting, noise or irregular colors may appear in the image. However, the noise or irregular colors will not be recorded in the captured image.
- When you magnify the image, the image sharpness may look more pronounced than in the actual image.

## Custom Functions

- Some Custom Functions are not available (some settings have no effect).

## Lens and flash

- If the attached lens has an Image Stabilizer and you set the Image Stabilizer switch to < ON >, the Image Stabilizer will operate at all times even if you do not press the shutter button halfway. The Image Stabilizer consumes battery power and may decrease the number of available shots depending on the shooting conditions. When the Image Stabilizer is not necessary, such as when using a tripod, it is recommended that you set the Image Stabilizer switch to < OFF >.
- With EF lenses, focus preset during shooting is only available when using (super) telephoto lenses equipped with this function released in and after the second half of 2011.
- FE lock will not work if the built-in flash is used. FE lock and modeling flash will not work if an external Speedlite is used.



### Note

- With HDMI Cable HTC-100 (sold separately), you can display images on a television (). Note that no sound will be output.

## Information Display in Live View Shooting

---

For details on the icons displayed for still photo shooting, see [Live View Shooting Screen](#).

---





### Note

- When [Exp.SIM] is displayed in white, it indicates that the image is displayed at the brightness level closely matching that of the actual image to be captured.
- If the [Exp.SIM] icon is blinking, it indicates that the image is displayed at a brightness that differs from the actual shooting result because of low- or bright-light conditions. However, the actual image recorded will reflect the exposure setting. Note that the noise may be more noticeable than the actual image recorded.
- Exposure simulation may not be performed under some shooting settings. The [Exp.SIM] icon and histogram will be displayed in gray. The image will be displayed on the screen at the standard brightness. The histogram may not be properly displayed in low- or bright-light conditions.

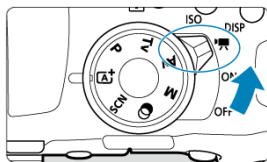
## Movie Recording



For movie recording, set the power switch to .

-  to the right of page titles indicates functions only available in Creative Zone modes (< **P** >, < **Tv** >, < **Av** >, or < **M** >).

### Caution

- When switching from still photo shooting to movie recording, check the camera settings again before recording movies.

- [Tab Menus: Movie Recording](#)
- [Movie Recording](#)
- [HDR Movies](#)
- [Creative Filters](#)
- [Movie Recording Size](#)
- [Digital Zoom](#)
- [Movie Self-Timer](#)
- [Sound Recording](#)
- [Movie Digital IS](#)
- [Time-Lapse Movies](#)
- [Video Snapshots](#)
- [Movie Servo AF](#)
- [Other Menu Functions](#)
- [General Movie Recording Precautions](#)

## Tab Menus: Movie Recording

### ● Shooting 1

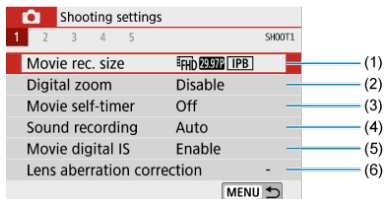

- (1) [Movie rec. size](#)
- (2) [Digital zoom](#)
- (3) [Movie self-timer](#)
- (4) [Sound recording](#)
- (5) [Movie digital IS](#)
- (6) [Lens aberration correction](#) ☆

### ● Shooting 2

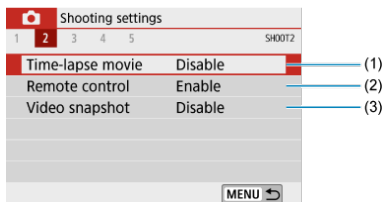

- (1) [Time-lapse movie](#)
- (2) [Remote control](#)
- (3) [Video snapshot](#)

## ● Shooting 3

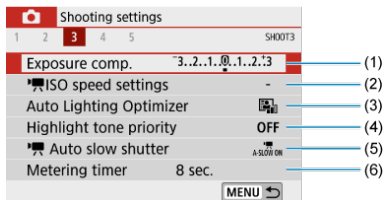

- (1) [Exposure comp.](#) ☆
- (2) [ISO speed settings](#) ☆
- (3) [Auto Lighting Optimizer](#) ☆
- (4) [Highlight tone priority](#) ☆
- (5) [Auto slow shutter](#) ☆
- (6) [Metering timer](#) ☆

## ● Shooting 4

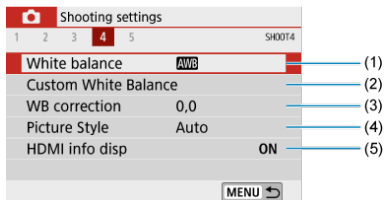

(1) [White balance](#) ☆

(2) [Custom White Balance](#) ☆

(3) [WB correction](#) ☆

(4) [Picture Style](#) ☆

[Picture Style Selection](#) ☆

[Picture Style Customization](#) ☆

[Picture Style Registration](#) ☆

(5) [HDMI info disp](#) ☆

## ● Shooting 5

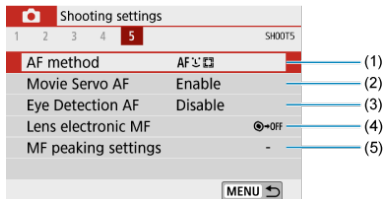

(1) [AF method](#)

(2) [Movie Servo AF](#)

(3) [Eye Detection AF](#)

(4) [Lens electronic MF](#) ☆

(5) [MF peaking settings](#)

## Movie Recording

---

- [Autoexposure Movie Recording](#)
- [Manual Exposure Movie Recording](#) ☆
- [ISO Speed in <M> Mode](#) ☆
- [Available Shutter Speeds](#) ☆
- [Still Photo Shooting](#)
- [Information Display \(Movie Recording\)](#)

### Autoexposure Movie Recording

---

Autoexposure control will take effect to suit the scene's current brightness.

1. Set the power switch to **< ON >**.

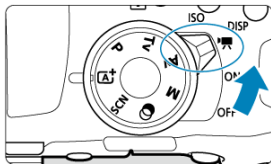

- After the sound of the reflex mirror moving, the image appears on the screen.

2. Set the Mode dial to a mode other than **< SCN >**, **< Q >**, or **< M >**.

### 3. Focus on the subject.

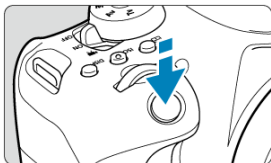



- Before recording a movie, focus with AF (AF-ON) or manual focus (MF).
- By default, [CAMERA]: **Movie Servo AF** is set to **[Enable]** so that the camera always keeps focusing (AF-ON).
- When you press the shutter button halfway, the camera will focus with the current AF method.



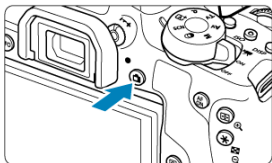

#### 4. Record the movie.







- Press the <  > button to start recording a movie.
- You can also start recording a movie by tapping [] on the screen.

##### Note

- [] is not displayed under the following settings.
  - [Video snapshot] is set to [Enable]
  - [Time-lapse movie] is set to an option other than [Disable]
  - In <  > mode (movie)
  - In < **SCN** > mode (HDR movie)



- While the movie is being recorded, the [] icon will be displayed in the upper right of the screen.
- Sound is recorded by the built-in microphone ().
- To stop recording the movie, press the <  > button again.
- You can also stop recording a movie by tapping [] on the screen.

## ISO speed in Basic Zone modes

- The ISO speed will be set automatically within ISO 100–12800.

## ISO speed in <P>, <Tv>, and <Av> modes

- The ISO speed will be set automatically within ISO 100–12800. The maximum varies depending on the [Max for Auto] setting in [📷: ⚙️ ISO speed settings] (🔗).
- Under [🔧: Custom Functions(C.Fn)], if [2: ISO expansion] is set to [1:Enable], [H(25600)] can also be selected for [Max for Auto].

### ⚠️ Caution

- When the <SCN> mode is set, HDR movie recording takes effect (🔗).
- Even if you set the <Tv> or <Av> mode, movie recording with priority given to shutter speed or aperture value cannot be performed. Autoexposure recording takes effect as in the <P> mode.

### 📖 Note

- In <A+> mode, a scene icon for the scene detected by the camera is displayed in the upper left of the screen (🔗).
- In Creative Zone modes, you can press the <⌘> button (🔗) to lock the exposure (AE lock). After applying AE lock during movie recording, you can cancel it by pressing the <📷> button. (AE lock setting is retained until you press the <📷> button.)
- Exposure compensation in Creative Zone modes can be set in a range of up to ±3 stops.
- ISO speed, shutter speed, and aperture value are not recorded in movie Exif information.
- With autoexposure movie recording (except in time-lapse movie recording), this camera supports the Speedlite's function to turn on the LED light automatically in low-light conditions. For details, refer to the Instruction Manual of the EX series Speedlite equipped with an LED light.

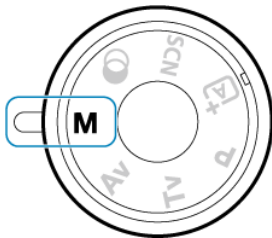

You can manually set the shutter speed, aperture value, and ISO speed for movie recording.

1. Set the power switch to <  >.
2. Set the Mode dial to < **M** >.



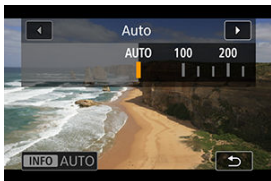

3. Set the ISO speed.

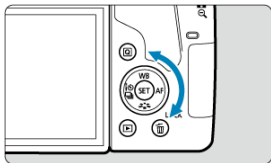
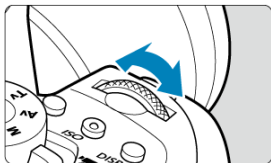

- Press the < **ISO** > button.  
The ISO speed setting screen is displayed.
- Set with the <  > or <  > dial.

#### 4. Set the shutter speed and aperture value.



- Press the shutter button halfway and check the exposure level indicator.
- To set the shutter speed (1), turn the <  > dial, and to set the aperture value (2), turn the <  > dial.







#### 5. Focus and record the movie.

- The procedure is the same as steps 3 and 4 for [Autoexposure Movie Recording](#).

## Caution

- During movie recording, avoid changing the shutter speed, aperture value, or ISO speed, which may record changes in the exposure or create more noise at high ISO speeds.
- When recording a movie of a moving subject, a shutter speed of approx. 1/25 sec. to 1/125 sec. is recommended. The faster the shutter speed, the less smooth the subject's movement will look.
- If you change the shutter speed while recording under fluorescent or LED lighting, image flicker may be recorded.

## Note

- With ISO Auto, exposure compensation can be set in a range of  $\pm 3$  stops ()
- When ISO Auto is set, you can press the  button to lock the ISO speed. After locking the ISO speed during movie recording, you can cancel it by pressing the  button. (ISO speed lock is maintained until you press the  button.)
- If you press the  button and recompose the shot, you can see the exposure level difference on the exposure level indicator compared to when the  button was pressed.
- With the camera ready to shoot in the **<M>** mode, you can display the histogram by pressing the **<INFO>** button.

## ISO Speed in **<M>** Mode



You can set the ISO speed manually or select **[AUTO]**. For details on ISO speed, see [ISO Speed in Movie Recording](#).

## Available Shutter Speeds



Shutter speed in <M> mode can be set in a range of 1/4000–1/8 sec.

### Caution

- The available shutter speeds will differ for time-lapse movie recording ().

## Still Photo Shooting

**Still photos cannot be taken during movie recording.** To take still photos, stop the movie recording and perform viewfinder shooting or Live View shooting.

## Information Display (Movie Recording)



For details on the icons on the movie recording screen, see [Movie Recording Screen](#).

### Caution

#### Precautions for movie recording

- Do not point the camera toward an intense light source, such as the sun or an intense artificial light source. Doing so may damage the image sensor or the camera's internal components.
- If you record something that has fine detail, moire or false colors may result.
- If **[AWB]** or **[AWBW]** is set and the ISO speed or aperture value changes during movie recording, the white balance may also change.
- If you record a movie under fluorescent or LED lighting, the movie image may flicker.
- If you perform AF with a USM lens during movie recording in low light, horizontal banding noise may be recorded in the movie. The same type of noise may occur if you focus manually (**MF**) with certain lenses equipped with an electronic focusing ring.
- Recording a few test movies is recommended if you intend to perform zooming during movie recording. Zooming as you record movies may cause exposure changes or lens sounds to be recorded, an uneven audio level, or loss of focus.
- Large aperture values may delay or prevent accurate focusing.
- Performing AF by pressing the shutter button halfway during movie recording may cause the following kinds of issues: significant temporary loss of focus, recording of changes in movie brightness, temporary stopping of movie recording, or recording of mechanical lens sounds.
- Avoid covering the built-in microphones () with your fingers or other objects.
- Also see [General Movie Recording Precautions](#).
- If necessary, also see [General Still Photo Shooting Precautions](#).

 **Note****Notes for movie recording**

- Each time you record a movie, a new movie file is created on the card.
- The movie's field of view coverage for recording 4K, Full HD, and HD movies is approx. 100%.
- To enable starting or stopping movie recording by pressing the shutter button completely, you can set [**Fully-press**] for [: **Shutter btn function for movies**] to [**Start/stop mov rec**].
- Stereo sound is recorded by the camera's built-in microphones ().
- Any external microphones such as Directional Stereo Microphone DM-E1 (sold separately) connected to the camera's external microphone IN terminal are used instead of the build-in microphones ().
- Most external microphones equipped with a 3.5 mm mini-jack can be used.
- With EF lenses, focus preset during movie recording is available when using (super) telephoto lenses equipped with this function released in and after the second half of 2011.
- YCbCr 4:2:0 (8-bit) color sampling and the BT.709 color space are used for 4K, Full HD, and HD movies.



## HDR Movies

---

You can record high dynamic range movies that retain detail in highlights of high-contrast scenes.

---

1. Set the Mode dial to < SCN >.

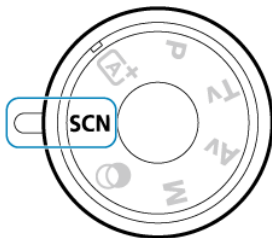

2. Record an HDR movie.



- Record the movie in the same way as normal movie recording (📷).

 **Caution**

- Since multiple frames are merged to create an HDR movie, certain parts of the movie may look distorted. This is more noticeable in shots affected by camera shake, so consider using a tripod. Note that even if a tripod is used for recording, afterimages or noise may become more noticeable, compared to normal playback, when the HDR movie is played back frame-by-frame or in slow motion.
- Not available for Movie digital zoom, video snapshots, time-lapse movies, or Movie digital IS.

 **Note**

- The recording size is **FHD 29.97P IPB** (NTSC) or **FHD 25.00P IPB** (PAL).
- ISO speed is set automatically when you record HDR movies.

## Creative Filters

---

In **< Q >** (creative filters) mode, you can record movies with filter effects applied.

---

1. Set the Mode dial to **< Q >**.

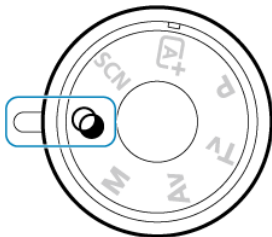

2. Press the **< Q >** button (Ⓠ10).

- The Quick Control screen will appear.

3. Select **[ 1/2 ]**.



- Use the **< ▲ >** **< ▼ >** keys to select **[ 1/2 ]** (**Shooting mode**) in the upper left, then press **< SET >**.

#### 4. Select a filter effect.

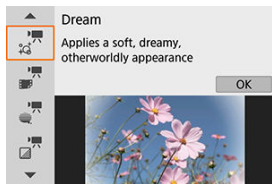

- Use the <▲> <▼> keys to select a filter effect (☑), then press <SET>.
- The image is shown with the filter effect applied.
- For **[Miniature effect movie]**, move the AF point into position for focusing. Move the scene frame if the AF point is outside of it, so that the AF point is aligned with it.

#### 5. Adjust the filter effect level.

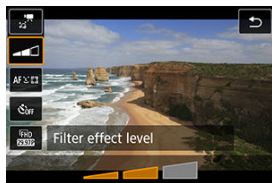

- Press the <Q> button and select the icon below **[Movie self-timer]**.
- Use the <◀> <▶> keys to adjust the effect, then press <SET>.
- When setting up **[Miniature effect movie]**, select the playback speed.

#### 6. Record the movie.













 **Caution**

- A magnified view is not available.
- No histogram is displayed.
- Not available for Movie digital zoom, video snapshots, time-lapse movies, or Movie digital IS.

 **Note**

- The recording size is [FHD 29.97P]/[FHD 23.98P] (NTSC) or [FHD 25.00P] (PAL).
- In Creative Zone modes, Creative filter settings are available from the Quick Control screen ()

## Creative Filter Characteristics

-  **Dream**  
Applies a soft, dreamy, otherworldly appearance. Gives the movie a soft look overall, blurring the periphery of the screen. You can adjust the blurry areas along the screen edges by adjusting the filter effect.
-  **Old Movies**  
Creates an atmosphere like an old film by adding wavering, scratches, and flickering effects to the image. The top and bottom of the screen are masked in black. You can modify the wavering and scratch effects by adjusting the filter effect.
-  **Memory**  
Creates the atmosphere of a distant memory. Gives the movie a soft look overall, reducing brightness of the periphery of the screen. You can modify the overall saturation and the dark areas along the screen edges by adjusting the filter effect.
-  **Dramatic B&W**  
Creates an atmosphere of dramatic realism with high-contrast black and white. You can adjust the graininess and black-and-white effect by adjusting the filter effect.
-  **Miniature effect movie**  
You can record movies with a miniature (diorama) effect.  
To make the scene frame movable, press the <  > button in step 4 (or tap  in the lower right of the screen), so that it changes color. To center the frame again, press the < **INFO** > button. To switch between vertical and horizontal scene frame orientation, tap  in the lower left of the screen. Switching scene frame orientation is also possible with the <  > <  > keys when in horizontal orientation and <  > <  > keys when in vertical orientation. To confirm the position of the scene frame, press <  >. In step 5, set the playback speed to **[5x]**, **[10x]**, or **[20x]** before recording. **[1-point AF]** is used as the AF method, focusing on subjects centered in the white frame. The white frame is hidden during recording.

### Speed and playback time (for a 1-minute movie)

Speed	Playback Time
5x	Approx. 12 sec.
10x	Approx. 6 sec.
20x	Approx. 3 sec.

 Caution

- Subjects such as the sky or white walls may not be rendered with smooth gradation and may have noise or irregular exposure or colors.





- Sound is not recorded.
- Movie Servo AF will not function.
- Editing is not available for movies with a playback time less than 1 sec. (✔).

## Movie Recording Size

---

- [Image Size](#)
- [4K Movie Recording](#)
- [Frame Rate \(fps: frame per second\)](#)
- [Compression Method](#)
- [Movie Recording Format](#)
- [Cards That Can Record Movies](#)
- [Movie Files Exceeding 4 GB](#)
- [Total Movie Recording Time and File Size Per Minute](#)
- [Movie Recording Time Limit](#)

In [: **Movie rec. size**], you can set the image size, frame rate, and compression method. The movie will be recorded as an MP4 file.

Note that the frame rate will be switched automatically according to the [: **Video system**] setting ().

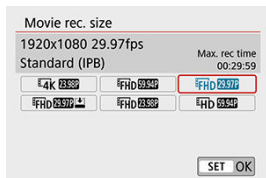



## Image Size

- [4K] 3840×2160

The movie is recorded in 4K quality. The aspect ratio is **16:9**.

- [FHD] 1920×1080

The movie will be recorded in Full High-Definition (Full HD) quality. The aspect ratio is **16:9**.

- [HD] 1280×720

The movie is recorded in High-Definition (HD) quality. The aspect ratio is **16:9**.

### ! Caution



- If you change the [Video system] setting, also set [Movie rec. size] again.
- Normal playback of 4K and [FHD 59.94P/50.00P] movies may not be possible on other devices, because playback is processing-intensive.
- Apparent resolution and noise vary depending on movie recording quality.

### 📄 Note

- Movies cannot be recorded in VGA quality.

## 4K Movie Recording

---

- Recording 4K movies requires a high-performance card. For details, see [Cards That Can Record Movies](#).
- Recording 4K movies greatly increases the processing load, which may cause the camera's internal temperature to increase faster or become higher than for regular movies. **If a red  icon appears during movie recording, the card may be hot, so stop recording the movie and let the camera cool down before removing the card. (Do not remove the card immediately.)**
- From a 4K movie, you can select any frame to save as an approx. 8.3 megapixel (3840×2160) JPEG still image to the card ().

## Frame Rate (fps: frame per second)

---

-  59.94 fps /  29.97 fps /  23.98 fps  
For areas where the TV system is NTSC (North America, Japan, South Korea, Mexico, etc.).
-  50.00 fps /  25.00 fps  
For areas where the TV system is PAL (Europe, Russia, China, Australia, etc.).

## Compression Method

---

- **[IPB] IPB (Standard)**  
Compresses multiple frames at a time efficiently for recording.
- **[IPB] IPB (Light)**  
Since the movie is recorded at a bit rate lower than with IPB (Standard), the file size will be smaller than with IPB (Standard) and the playback compatibility will be higher. This will make the possible recording time longer than with IPB (Standard) (with a card having the same capacity).

## Movie Recording Format

---

- **[MP4] MP4**  
All movies you record with the camera are recorded as movie files in MP4 format (file extension ".MP4").

## Cards That Can Record Movies

For details on cards that can record at each level of movie recording quality, see [Card performance requirements](#).

**Test cards by recording a few movies to make sure they can record correctly at your specified size (📎).**

### Caution

- Format cards before recording 4K movies (📎).
- If you use a slow-writing card when recording movies, the movie may not be recorded properly. Also, if you play back a movie on a card with a slow reading speed, the movie may not be played back properly.
- When recording movies, use high-performance cards with a writing speed sufficiently higher than the bit rate.
- When movies cannot be recorded normally, format the card and try again. If formatting the card does not resolve the problem, refer to the card manufacturer's website, etc.

### Note

- To obtain better performance with the card, formatting the card with the camera before recording movies is recommended (📎).
- To check the card's writing/reading speed, refer to the card manufacturer's website, etc.

## Movie Files Exceeding 4 GB

Even if you record a movie exceeding 4 GB, you can keep recording without interruption.

- **Using SD/SDHC cards formatted with the camera**

If you use the camera to format an SD/SDHC card, the camera will format it in FAT32. With a FAT32-formatted card, if you record a movie and the file size exceeds 4 GB, a new movie file will be created automatically.

When you play back the movie, you will have to play back each movie file individually. Movie files cannot be played back automatically in consecutive order. After the movie playback ends, select the next movie and play it back.

- **Using SDXC cards formatted with the camera**

If you use the camera to format an SDXC card, the camera will format it in exFAT.

When using an exFAT-formatted card, even if the file size exceeds 4 GB during movie recording, the movie will be saved as a single file (rather than being split into multiple files).



### Caution

- When importing movie files exceeding 4 GB to a computer, use either EOS Utility or a card reader (🔗). It may not be possible to save movie files exceeding 4 GB if you attempt this using standard features of the computer's operating system.

## Total Movie Recording Time and File Size Per Minute

---

For details on file sizes and the recording time available at each movie recording size, see [Estimated recording time, movie bit rate, and file size](#).

## Movie Recording Time Limit

---

The maximum recording time per movie is 29 min. 59 sec. Once 29 min. 59 sec. is reached, recording automatically stops. You can start recording a movie again by pressing the <  > button (which records the movie as a new file).

# Digital Zoom

With the recording size set to [FHD 29.97P]/[FHD 23.98P] (NTSC) or [FHD 25.00P] (PAL), you can shoot with approx. 3–10× digital zoom.

1. Set the Mode dial to a mode other than < SCN > or < Q >.
2. Select [📷: Digital zoom].

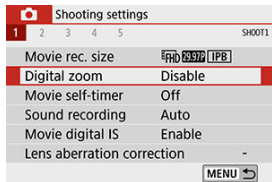

3. Select an option.

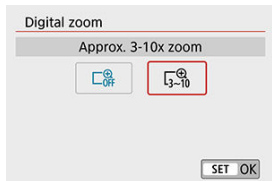

- Select the amount to zoom, then press < (SET) >.

#### 4. Use digital zoom.

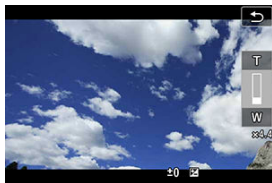

- Press the < ▲ > < ▼ > keys.
- The digital zoom bar will appear.
- Press the < ▲ > key to zoom in or press the < ▼ > key to zoom out.
- When you press the shutter button halfway, the camera will focus with [1-point AF] (fixed at center).
- To cancel digital zoom, set [Disable] in step 2.

#### ⚠ Caution

- Using a tripod to prevent camera shake is recommended.
- Time-lapse movies, Creative filters, and Movie digital IS are not available.
- The maximum ISO speed will be ISO 6400.
- A magnified view is not available.
- Since Movie digital zoom processes the image digitally, the image will look grainier at higher magnifications. Noise, dots of light, etc. may also become noticeable.
- The scene icon will not be displayed.
- Also see [Shooting Conditions That Make Focusing Difficult](#).



# Movie Self-Timer

Movie recording can be started by the self-timer.

## 1. Select [📷: Movie self-timer].

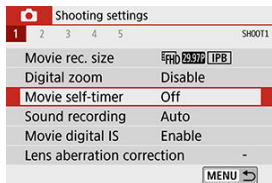

## 2. Select an option.

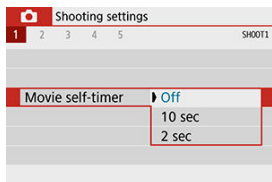

## 3. Record the movie.

- After you tap [●] or press the <📷> button, the camera displays number of seconds left before recording and beeps.

### Note

- To cancel the self-timer, either tap the screen or press <SET>.

# Sound Recording

---

 [Sound Recording/Sound-Recording Level](#)

 [Wind Filter](#) ☆

 [Attenuator](#) ☆

 [External Microphone](#)

You can record movies while recording sound with the built-in stereo microphone or an external stereo microphone. You can also freely adjust the sound-recording level.

Use : **Sound recording** to set sound recording functions.

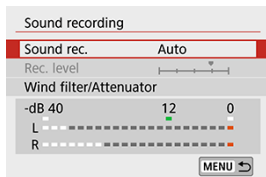

---

## Sound Recording/Sound-Recording Level

---

### ● Auto

The sound-recording level is adjusted automatically. Auto level control will take effect automatically in response to the sound level.

### ● Manual

You can adjust the sound-recording level as needed.

Select **[Rec. level]** and press the < ◀ > ▶ > keys while looking at the level meter to adjust the sound-recording level. Look at the peak hold indicator, and adjust so that the level meter sometimes lights up on the right of the "12" (-12 dB) mark for the loudest sounds. If it exceeds "0", the sound will be distorted.

### ● Disable

Sound will not be recorded.

## Wind Filter

---



Set to **[Auto]** to reduce wind noise automatically when there is wind outdoors. Only activated when the camera's built-in microphone is used. When the wind filter function takes effect, part of the low bass sounds will also be reduced.

## Attenuator

---



Automatically suppresses sound distortion caused by loud noises. Set **[Sound rec.]** to **[Enable]** if distortion occurs when set to **[Auto]** or **[Manual]**.

## External Microphone

If an external microphone equipped with a miniature stereo plug (3.5 mm diameter) is connected to the camera's external microphone IN terminal, the external microphone will be given the priority. Using a microphone such as Directional Stereo Microphone DM-E1 (sold separately) is recommended.

### Caution

- Sounds from Wi-Fi operations may be captured with built-in or external microphones. During sound recording, using the wireless communication function is not recommended.
- When connecting an external microphone to the camera, make sure the plug is fully inserted.
- The camera's built-in microphone will also record mechanical sounds of the lens or sounds of camera/lens operations if AF operations are performed or the camera is operated during movie recording. In this case, using an external microphone may reduce these sounds. If the sounds are still distracting with an external microphone, it may be more effective to remove the external microphone from the camera and position it away from the camera and lens.
- Do not connect anything other than an external microphone to the camera's external microphone IN terminal.

### Note

- In Basic Zone modes, the settings available for **[Sound recording]** are **[On]** or **[Off]**. Set to **[On]** for automatic adjustment of the recording level.
- Audio is also output when the camera is connected to televisions via HDMI, except when **[Sound rec.]** is set to **[Disable]**.
- The sound volume balance between L (left) and R (right) cannot be adjusted.
- Sound is recorded at a 48 kHz/16-bit sampling rate.

# Movie Digital IS

---

The camera's Movie digital IS feature reduces camera shake as movies are recorded. Movie digital IS can provide effective stabilization even when your lens is not equipped with Image Stabilizer. When using a lens equipped with Image Stabilizer, set the lens's Image Stabilizer switch to < ON >.

---

## 1. Select [📷: Movie digital IS].

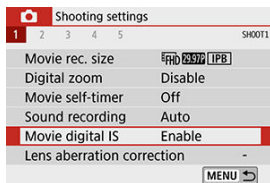

## 2. Select an option.

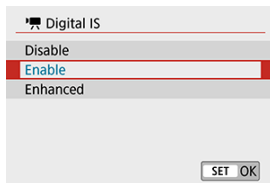

- **Disable** (📷 OFF)  
Image stabilization with Movie digital IS is disabled.
- **Enable** (📷 ON)  
Camera shake will be corrected. The image will be slightly magnified.
- **Enhanced** (📷 ON)  
Compared to when [Enable] is set, stronger camera shake can be corrected. The image will be more magnified.

 **Caution**

- Movie digital IS will not function when the lens's optical Image Stabilizer switch is set to < **OFF** >.
- With a lens whose focal length is longer than 800 mm, Movie digital IS will not function.
- Movie digital IS cannot be set in < **SCN** > or <  > mode or when Movie digital zoom, time-lapse movie, or Creative filter is set.
- The wider the angle of view, the more effective the image stabilization will be. The narrower the angle of view, the less effective the image stabilization will be.
- When using a TS-E lens, fish-eye lens, or non-Canon lens, setting Movie digital IS to **[Disable]** is recommended.
- Effects of Movie digital IS are not applied to images during magnified display.
- Since Movie digital IS magnifies the image, the image looks more grainy. Noise, dots of light, etc. may also become noticeable.
- Depending on the subject and shooting conditions, the subject may blur noticeably (the subject momentarily looks out of focus) due to the effects of the Movie digital IS.
- When Movie digital IS is set, the size of AF points will also change.
- When using a tripod, setting Movie digital IS to **[Disable]** is recommended.
- Certain lenses do not support this function. For details, refer to the Canon website.

# Time-Lapse Movies

Still photos shot at a set interval can be stitched together automatically to create a 4K or Full HD time-lapse movie. A time-lapse movie shows how a subject changes in a much shorter period of time than the actual time it took. It is effective for a fixed-point observation of changing scenery, growing plants, celestial motion, etc.

**Time-lapse movies are recorded in MP4 format at the following quality:**  $\text{4K } 29.97\text{P } \text{[ALL-I]}$  (NTSC)/ $\text{4K } 25.00\text{P } \text{[ALL-I]}$  (PAL) in 4K recording, and  $\text{FHD } 29.97\text{P } \text{[ALL-I]}$  (NTSC)/ $\text{FHD } 25.00\text{P } \text{[ALL-I]}$  (PAL) in Full HD recording.

Note that the frame rate will be switched automatically according to the  $\text{[P: Video system]}$  setting  $\text{[P]}$ .

1. Set the Mode dial to a mode other than < SCN > or <  $\text{[P]}$  >.
2. Select  $\text{[P: Time-lapse movie]}$ .

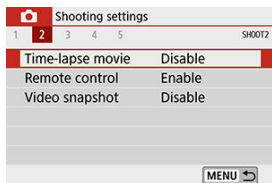

3. Select  $\text{[Time-lapse]}$ .

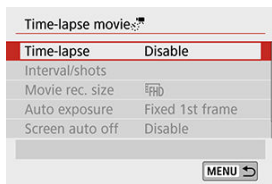

#### 4. Select a scene.

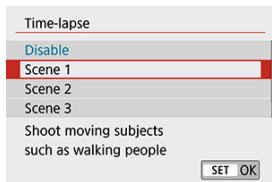

- Select a scene to suit the shooting situation.
- For greater freedom when setting the shooting interval and number of shots manually, select **[Custom]**.

#### 5. Set the shooting interval.

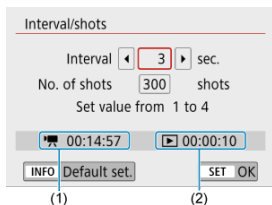

- Select **[Interval/shots]**.
- Select **[Interval]** (sec.). Use the <◀> <▶> keys to set a value, then press <SET>.
- Refer to **[Time required]** (1) and **[Playback time]** (2) to set the number.

#### When **[Custom]** is set

- Select **[Interval]** (min.:sec.).
- Press <SET> to display <⏏>.
- Use the <▲> <▼> keys to set a value, then press <SET>. (Returns to <□>.)
- Select **[OK]** to register the setting.



## 6. Set the number of shots.

Interval/shots

Interval  sec.

No. of shots  shots

Set value from 30 to 900

00:14:57 00:00:10

INFO Default set. SET OK

- Select [**No. of shots**]. Use the <◀><▶> keys to set a value, then press <SET>.
- Refer to [: **Time required**] and [: **Playback time**] to set the number.

### When [Custom] is set

- Select the digit.
- Press <SET> to display <⏏>.
- Use the <▲><▼> keys to set a value, then press <SET>. (Returns to <□>.)
- Check that [: **Playback time**] is not displayed in red.
- Select [OK] to register the setting.

### Caution

- If the card does not have enough free space to record the set number of shots, [**Playback time**] will be displayed in red. Although the camera can continue shooting, the shooting will stop when the card becomes full.
- If the movie file size exceeds 4 GB with the [**No. of shots**] settings and the card is not formatted in exFAT () , [**Playback time**] will be displayed in red. If you keep recording in this condition and the movie file size reaches 4 GB, the time-lapse movie recording will stop.

 **Note**

- With [**Scene \***], available intervals and numbers of shots are restricted, to suit the type of scene.
- For details on cards that can record time-lapse movies, see [Card performance requirements](#).
- If the number of shots is set to 3600, the time-lapse movie will be approx. 2 min. in NTSC and approx. 2 min. 24 sec. in PAL.

## 7. Select the desired movie recording size.

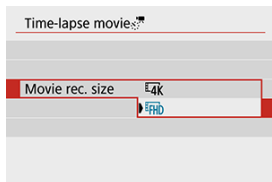

- **4K (3840×2160)**  
The movie is recorded in 4K quality. The aspect ratio is **16:9**.  
The frame rate is 29.97 fps (**29.97P**) for NTSC and 25.00 fps (**25.00P**) for PAL, and movies are recorded in MP4 (**MP4**) format with ALL-I (**ALL-I**) compression.
- **FHD (1920×1080)**  
The movie will be recorded in Full High-Definition (Full HD) quality. The aspect ratio is **16:9**.  
The frame rate is 29.97 fps (**29.97P**) for NTSC and 25.00 fps (**25.00P**) for PAL, and movies are recorded in MP4 (**MP4**) format with ALL-I (**ALL-I**) compression.

## 8. Configure [Auto exposure].

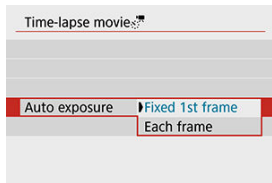

### ● Fixed 1st frame

When taking the first shot, metering is performed to set the exposure automatically to match the brightness. The exposure setting for the first shot will be applied to subsequent shots. Other shooting-related settings for the first shot will also be applied for subsequent shots.

### ● Each frame

Metering is also performed for each subsequent shot to set the exposure automatically to match the brightness. Note that if functions such as Picture Style and white balance are set to **[Auto]**, they will be set automatically for each subsequent shot.

### ⚠ Caution

- With **[Interval]** set to less than 3 sec. and **[Auto exposure]** set to **[Each frame]**, if the brightness differs greatly from the preceding shot, the camera may not shoot at the set interval.
- With **[Auto exposure]** set to **[Each frame]**, ISO speed, shutter speed, and aperture value may not be recorded in the time-lapse movie Exif information in some shooting modes.

## 9. Configure [Screen auto off].

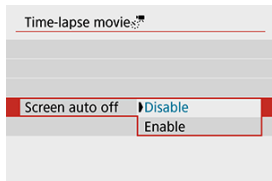

- **Disable**

Even during time-lapse movie recording, the image will be displayed. (The screen turns off only at the time of shooting.) Note that the screen will turn off when approx. 30 min. elapse after the shooting started.

- **Enable**

Note that the screen will turn off when approx. 10 sec. elapse after the shooting started.



### Note

- During time-lapse movie recording, you can press the < **INFO** > button to turn on/off the screen.

## 10. Set the beeper.

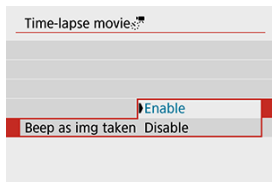

- Select [**Beep as img taken**].

- If [**Disable**] is set, the beeper will not sound for shooting.

## 11. Check the settings.

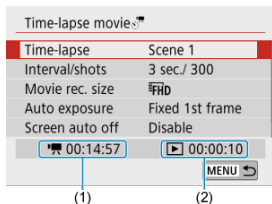

### (1) Time required

Indicates the time required to shoot the set number of shots with the set interval. If it exceeds 24 hours, "\*\*\*\* days" will be displayed.

### (2) Playback time

Indicates the movie recording time (time required to play back the movie) when creating the time-lapse movie in 4K movie or Full HD movie from the still photos taken with the set intervals.

## 12. Close the menu.

- Press the < MENU > button to turn off the menu screen.

### 13. Record the time-lapse movie.





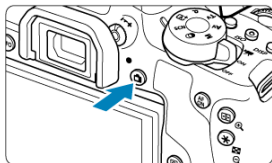





- Press the < INFO > button and check again the "Time required (1)" and "Interval (2)" displayed on the screen.



- Press the <  > button completely to start recording the time-lapse movie.
- AF will not work during time-lapse movie recording.
- "●REC" is displayed in the upper right of the screen as the time-lapse movie is recorded.
- When the set number of shots are taken, the time-lapse movie recording ends.
- To cancel recording time-lapse movies, set [Time-lapse] to [Disable].

## Caution

- Do not point the camera toward an intense light source, such as the sun or an intense artificial light source. Doing so may damage the image sensor or the camera's internal components.
- **[Time-lapse movie]** cannot be set to an option other than **[Disable]** when the camera is connected to a computer with the interface cable, or when an HDMI cable is connected.
- Movie Servo AF will not function.
- If the shutter speed is 1/30 sec. or slower, the exposure of the movie may not be displayed properly (may differ from that of the resulting movie).
- Do not zoom the lens during time-lapse movie recording. Zooming the lens may cause the image to be out of focus, the exposure to change, or the lens aberration correction not to function properly.
- When recording a time-lapse movie under a flickering light, noticeable image flickering, horizontal stripes (noise), or irregular exposures may be recorded.
- Images displayed as time-lapse movies are recorded may look different from the resulting movie (in details such as inconsistent brightness from flickering light sources, or noise from a high ISO speed).
- When recording a time-lapse movie under low light, the image displayed during shooting may look different from what is actually recorded in the movie. In such cases, the **[Exp.SIM]** icon will blink.
- If you move the camera from left to right (panning) or shoot a moving subject during time-lapse movie recording, the image may look extremely distorted.
- During time-lapse movie recording, auto power off will not take effect. Also, you cannot adjust the shooting function and menu function settings, play back images, etc.
- Sound is not recorded for time-lapse movies.
- If the shutter speed exceeds the shooting interval (such as for long exposures), or if a slow shutter speed is set automatically, the camera may not be able to shoot at the set interval. Shooting may also be prevented by shooting intervals nearly the same as the shutter speed.
- If the next scheduled shot is not possible, it will be skipped. This may shorten the recording time of the created time-lapse movie.
- If the time it takes to record to the card exceeds the shooting interval due to the shooting functions set or card performance, some of the shots may not be taken with the set intervals.
- The captured images are not recorded as still photos. Even if you cancel the time-lapse movie recording after only one shot is taken, it will be recorded as a movie file.
- If you connect the camera to a computer with the interface cable and use EOS Utility (EOS software), set **[: Time-lapse movie]** to **[Disable]**. If an option other than **[Disable]** is selected, the camera cannot communicate with the computer.

- During time-lapse movie recording, the lens's Image Stabilizer will not operate.
- If the power switch is set to < OFF >, time-lapse movie recording will be terminated and the setting will be switched to [Disable].
- Even if a flash is used, it will not fire.
- The following operations cancel standby for time-lapse movie recording and switch the setting to [Disable].
  - Selecting either [Clean now ] in [: Sensor cleaning] or [Clear all camera settings] in [: Clear settings]
  - Setting the Mode dial to < SCN > or <  >
- If you start time-lapse movie recording while the white [] () icon is displayed, the image quality of the time-lapse movie may deteriorate. It is recommended that you start time-lapse movie recording after the white [] icon disappears (camera's internal temperature decreases).



#### Note

- Using a tripod is recommended.
- Taking test shots in advance is recommended.
- The movie's field of view coverage for both the 4K and Full HD time-lapse movie recording is approx. 100%.
- To cancel the time-lapse movie recording in progress, press the <  > button. The time-lapse movie shot so far will be recorded on the card.
- If the time required for recording is more than 24 hours but not more than 48 hours, "2 days" will be indicated. If three or more days are required, the number of days will be indicated in 24-hour increments.
- Even if the time-lapse movie's playback time is less than 1 sec., a movie file will still be created. For [Playback time], "00'00"" will be displayed.
- If the shooting time is long, using the household power outlet accessories (sold separately) is recommended.
- YCbCr 4:2:0 (8-bit) color sampling and the BT.709 color space are used for 4K/Full HD time-lapse movies.



## Note

You can use Wireless Remote Control BR-E1 (sold separately) to start and stop the time-lapse movie recording. Set [: **Remote control**] to [**Enable**] beforehand.

### ● With Wireless Remote Control BR-E1

- First, pair the BR-E1 with the camera ().

Camera Status/ Remote Control Setting	<  > (Immediate Release) <2> (2-sec. Delay)	<  > (Movie Recording)
Shooting-ready	As set in the <a href="#">Shutter Button Function for Movies</a> setting	Starts shooting
During time-lapse movie recording		Ends recording

## Guide to Time Available for Time-Lapse Movie Recording

For guidelines on how long you can record time-lapse movies (until the battery runs out), see [Time available for movie recording](#).

# Video Snapshots

[✔ Configuring Video Snapshot Settings](#)

[✔ Creating Video Snapshot Albums](#)

[✔ Adding to an Existing Album](#)

Record a series of short video snapshots, each a few seconds long, and the camera will combine them to create a video snapshot album that shows these highlights of your trip or event.

Video snapshots are available when the movie recording size is set to **FHD 29.97P** (NTSC) / **FHD 25.00P** (PAL).

Video snapshot albums can also be played back with background music (🎵).

## Creating a Video Snapshot Album

Video snapshots 1, 2, and so on



Video snapshot album

## Configuring Video Snapshot Settings

1. Set the Mode dial to a mode other than **<📷>**.

2. Specify **[📷: Video snapshot]**.

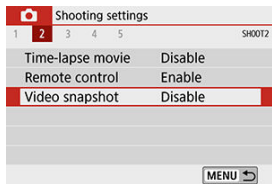

● Select **[Enable]**.

### 3. Specify [Album settings].

Video snapshot	
Video snapshot	Enable
Album settings	New album
Playback time	4 sec.
Playback effect	1x speed
Show confirm msg	Enable
Time required	4 sec.

MENU ↩

- Select [Create a new album].
- Read the message and select [OK].

### 4. Specify [Playback time].

Video snapshot	
Playback time	4 sec.
	6 sec.
	8 sec.

- Specify playback time per video snapshot.

### 5. Specify [Playback effect].

Video snapshot	
Playback effect	1/2x speed
	1x speed
	2x speed

- This setting determines how fast albums are played back.

## 6. Specify [Show confirm msg].

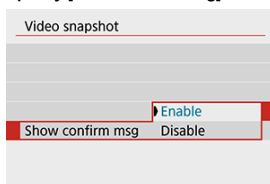

- Select [**Enable**].

## 7. Check the required recording time.

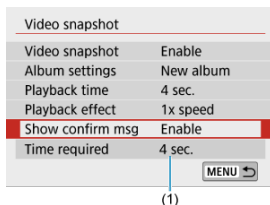

- The time required to record each video snapshot is indicated (1), based on the playback time and effect.



## 8. Close the menu.

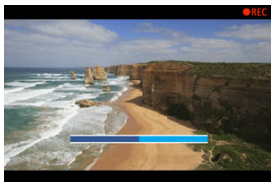

- Press the < **MENU** > button to close the menu.
- A blue bar is displayed to indicate the recording time (2).

### 1. Record the first video snapshot.



- Press the <  > button, then record.
- The blue bar indicating recording time gradually decreases, and after the specified time elapses, recording stops automatically.
- A confirmation message is displayed ().

### 2. Save as a video snapshot album.

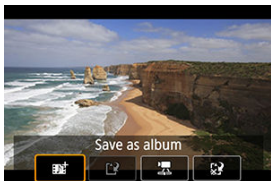

- Select [] **Save as album**.
- The clip is saved as the first video snapshot in the album.

### 3. Record your next video snapshots.

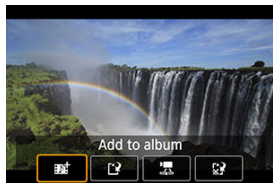





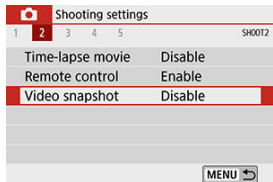

- Repeat step 1 to record the next video snapshot.
- Select [**+** Add to album].
- To create another album, select [**+** Save as a new album].
- Repeat step 3 as needed.

### 4. Stop recording video snapshots.



- Set [**Video snapshot**] to [**Disable**]. To return to normal movie recording, be sure to specify [**Disable**].
- Press the < **MENU** > button to close the menu and return to normal movie recording.

## Options in steps 2 and 3

Option	Description
 Save as album (step 2)	Saves the clip as the first video snapshot in an album.
 Add to album (step 3)	Adds the current video snapshot to the album recorded most recently.
 Save as a new album (step 3)	Creates a new album and saves the clip as the first video snapshot. This album file is different from the one recorded most recently.
 Playback video snapshot (steps 2, 3)	Plays the video snapshot just recorded.
 Do not save to album (step 2)	Deletes the recently recorded video snapshot without saving it to an album. Select <b>[OK]</b> on the confirmation screen.
 Delete without saving to album (step 3)	

### Note

- If you prefer to record the next video snapshot immediately, set **[Show confirm msg]** under **[📷: Video snapshot]** to **[Disable]**. This setting enables you to record the next video snapshot immediately, without a confirmation message.

## Adding to an Existing Album

### 1. Select [Add to existing album].

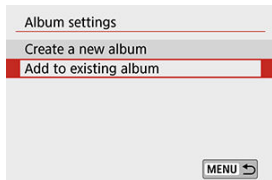

- In step 3 of [Configuring Video Snapshot Settings](#), select **[Add to existing album]**.

### 2. Select an existing album.



- Use the < ◀ ▶ > keys to select an existing album, then press < SET >.
- Select **[OK]**.  
Some video snapshot settings will be updated to match settings of the existing album.

### 3. Close the menu.

- Press the < MENU > button to close the menu.  
The video snapshot recording screen is displayed.



## 4. Record a video snapshot.

- Record the video snapshot, referring to [Creating a Video Snapshot Album](#).

### Caution

- You cannot select an album shot with another camera.

### Caution

#### General video snapshot precautions

- No sound is recorded when you set [**Playback effect**] to [**1/2x speed**] or [**2x speed**].
- Recording time per video snapshot is only approximate. It may differ slightly from the actual recording time indicated during playback, due to the frame rate and other factors.

# Movie Servo AF

With this function enabled, the camera focuses on the subject continuously during movie recording.

## 1. Select [📷: Movie Servo AF].

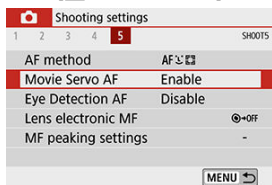

## 2. Select [Enable].

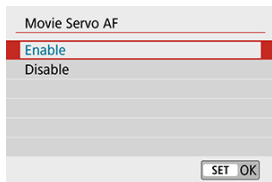

### ● When [Enable] is set:

- The camera focuses on the subject continuously even when you are not pressing the shutter button halfway.
- To keep the focus at a specific position, or if you prefer not to record mechanical sounds from the lens, you can temporarily stop Movie Servo AF by tapping [SERVO AF] in the lower left of the screen.
- When Movie Servo AF is paused, if you return to movie recording after operations such as pressing the <MENU> or <▶> button or changing the AF method, Movie Servo AF will resume.

### ● When [Disable] is set:

- Press the shutter button halfway or press the <AF ON> button to focus.

 Caution

**Precautions when [Movie Servo AF] is set to [Enable]**

- **Shooting conditions that make focusing difficult**
  - A fast-moving subject approaching or moving away from the camera.
  - A subject moving at a close distance to the camera.
  - When shooting with a higher f/number.
  - Also see [Shooting Conditions That Make Focusing Difficult](#).
- Since the lens is driven continuously and the battery power is consumed, the possible movie recording time (🕒) will be shortened.
- The camera's built-in microphone will also record mechanical sounds of the lens or sounds of camera/lens operations if AF operations are performed or the camera is operated during movie recording. In this case, using an external microphone may reduce these sounds. If the sounds are still distracting with an external microphone, it may be more effective to remove the external microphone from the camera and position it away from the camera and lens.
- Movie Servo AF will pause during zooming or magnified view.
- During movie recording, if a subject approaches or moves away or if the camera is moved vertically or horizontally (panning), the recorded movie image may momentarily expand or contract (change in image magnification).

## Other Menu Functions

---



---

- **Lens aberration correction** ☆

Peripheral illumination and chromatic aberration can be corrected as you record movies. For details on lens aberration correction, see [Lens Aberration Correction](#).

## ● Remote control

When [Enable] is set, you can start or stop movie recording using Wireless Remote Control BR-E1 (sold separately). First, pair the BR-E1 with the camera (🔗).

### With Wireless Remote Control BR-E1

For normal movie recording, set the release timing/movie shooting switch to < 📷 >, then press the release button.

For time-lapse movie recording, see [Time-Lapse Movies](#).

- **ISO speed settings** ☆

- **ISO speed**

- In [M] mode, you can set the ISO speed manually. You can also select ISO Auto.

- **Max for Auto**

- You can set the maximum limit for ISO Auto in movie recording in [M] mode or in [M] mode with ISO Auto.

- Under [C.Fn: Custom Functions(C.Fn)], if [2: ISO expansion] is set to [1:Enable], [H(25600)] can also be selected for [Max for Auto].

- **Highlight tone priority** ☆

You can reduce overexposed, clipped highlights as you record movies. For details on Highlight tone priority, see [Highlight Tone Priority](#).

**Caution**

- [Enhanced] is not available (not displayed) when recording movies with [CAM3: Highlight tone priority] set.

## ● Auto slow shutter ☆

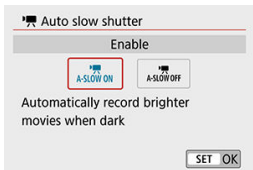

You can choose whether to record movies that are brighter than when set to **[Disable]** by automatically slowing the shutter speed under low light.

Available in  recording mode. Applies when the frame rate of the movie recording size is **59.94P** or **50.00P**.

- **Disable**

Enables you to record movies with smoother, more natural movement, less affected by subject shake than when set to **[Enable]**. Note that under low light, movies may be darker than when set to **[Enable]**.

- **Enable**

Enables you to record brighter movies than when set to **[Disable]** by automatically reducing the shutter speed to 1/30 sec. (NTSC) or 1/25 sec. (PAL) under low light.

### Note

- Setting to **[Disable]** is recommended when recording moving subjects under low light, or when afterimages such as trails may occur.

- **HDMI info disp** ☆

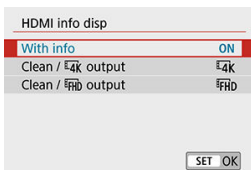

You can configure information display for image output via an HDMI cable.

- **With info**

The image, shooting information, AF points, and other information is shown on the other device via HDMI. Note that the camera screen goes off. Recorded movies are saved to the card.

- **Clean / 4K output**

HDMI output consists solely of 4K movies. Shooting information and AF points are also displayed on the camera, but no image is recorded to the card. Note that Wi-Fi communication is not available.

- **Clean / FHD output**





HDMI output consists solely of Full HD movies. Shooting information and AF points are also displayed on the camera, but no image is recorded to the card. Note that Wi-Fi communication is not available.



## General Movie Recording Precautions

### Caution

#### Red < > internal temperature warning icon

- If the camera's internal temperature increases due to prolonged movie recording or under a high ambient temperature, a red <  > icon will appear.
- The red <  > icon indicates that movie recording will soon be terminated automatically. If this happens, you will not be able to shoot again until the camera's internal temperature decreases, so turn off the power and let the camera cool down a while. Note that the time until movie recording stops automatically when the red <  > icon is displayed varies depending on shooting conditions.
- Recording a movie at a high temperature for a prolonged period will cause the red <  > icon to appear earlier. When you are not recording, always turn off the camera.

#### Recording and image quality

- If the attached lens has an Image Stabilizer and you set the Image Stabilizer switch to < ON >, the Image Stabilizer will operate at all times even if you do not press the shutter button halfway. The Image Stabilizer consumes battery power and may shorten the total movie recording time depending on the shooting conditions. When the Image Stabilizer is not necessary, such as when using a tripod, it is recommended that you set the Image Stabilizer switch to < OFF >.
- If the brightness changes as you record a movie with auto exposure, the movie may appear to stop momentarily. In this case, record movies with manual exposure.
- If there is a very bright light source in the image, the bright area may appear black on the screen. Movies are recorded almost exactly as they appear on the screen.
- Image quality may be lower when recording movies under a combination of conditions such as high ISO speeds, high temperatures, low shutter speeds, and low light.
- Recording movies over an extended period may cause the camera's internal temperature to rise and affect image quality. Turn off the camera when possible if you are not recording movies.
- If you play back a movie with other devices, image or sound quality may decline or playback may not be possible (even if the devices support MP4 format).

- If you use a card with a slow writing speed, an indicator may appear on the right of the screen during movie recording. The indicator shows how much data has not yet been written to the card (remaining capacity of the internal buffer memory), and it increases more quickly the slower the card is. If the indicator (1) becomes full, movie recording will stop automatically.



(1)

- If the card has a fast writing speed, the indicator will either not appear or the level (if displayed) will hardly go upward. First, record a few test movies to see if the card can write fast enough.
- If the indicator indicates that the card is full and movie recording stops automatically, the sound near the end of the movie may not be recorded properly.
- If the card's writing speed is slow (due to fragmentation) and the indicator appears, formatting the card may make the writing speed faster.

#### Audio restrictions

- Note that the following restrictions apply to audio in movie recording.
  - Sound will not be recorded for approx. the last two frames.
  - When you play back movies in Windows, movie images and sound may become slightly out of synchronization.

# Playback

---

This chapter covers topics related to playback—playing back captured still photos and movies—and introduces menu settings on the Playback ([]) tab.

## Caution

- Normal display or selection on this camera may not be possible for images captured on other cameras, or images from this camera that have been edited or renamed on a computer.
- Images that cannot be used with playback functions may be displayed.

- [Tab Menus: Playback](#)
- [Image Playback](#)
- [Index Display \(Multiple-Image Display\)](#)
- [Magnified Image Display](#)
- [Movie Playback](#)
- [Editing a Movie's First and Last Scenes](#)
- [Frame Extraction from 4K Movies or 4K Time-Lapse Movies](#)
- [Playback on a TV Set](#)
- [Protecting Images](#)
- [Rotating Still Photos](#)
- [Changing Movie Orientation Information](#)
- [Erasing Images](#)
- [Print Ordering \(DPOF\)](#)
- [Photobook Set-up](#)
- [Creative Filters](#)
- [RAW Image Processing](#) ☆
- [Creative Assist](#)
- [Quick Control RAW Processing](#) ☆
- [Red-Eye Correction](#)
- [Creating Albums](#)
- [Cropping](#)
- [Resizing](#)
- [Rating Images](#)
- [Slide Show](#)
- [Setting Image Search Conditions](#)
- [Browsing Images with the Main Dial](#)
- [Histogram](#)

- [AF Point Display](#)
- [Resuming from Previous Playback](#)
- [HDMI HDR Output](#)

## Tab Menus: Playback

---

- Playback 1

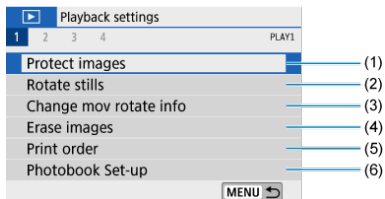

- (1) [Protect images](#)
- (2) [Rotate stills](#)
- (3) [Change mov rotate info](#)
- (4) [Erase images](#)
- (5) [Print order](#)
- (6) [Photobook Set-up](#)

## ● Playback 2

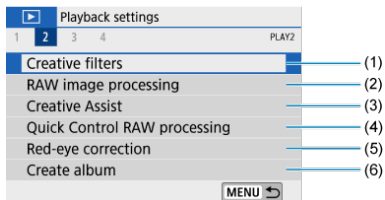

- (1) [Creative filters](#)
- (2) [RAW image processing](#) ☆
- (3) [Creative Assist](#)
- (4) [Quick Control RAW processing](#) ☆
- (5) [Red-eye correction](#)
- (6) [Create album](#)

### ! Caution

- [▶]: RAW image processing] and [▶]: Quick Control RAW processing] are not displayed in Basic Zone modes.

## ● Playback 3

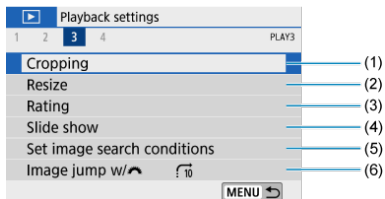

- (1) [Cropping](#)
- (2) [Resize](#)
- (3) [Rating](#)
- (4) [Slide show](#)
- (5) [Set image search conditions](#)
- (6) [Image jump w/ \[sun icon\]](#)

## ● Playback 4

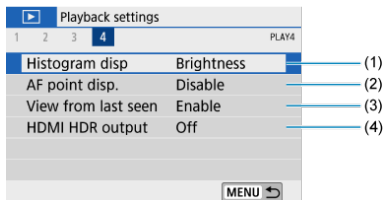

- (1) [Histogram disp](#)
- (2) [AF point disp.](#)
- (3) [View from last seen](#)
- (4) [HDMI HDR output](#)

# Image Playback

---

[Single-Image Display](#)

[Shooting Information Display](#)

## Single-Image Display

---

### 1. Switch to playback.



- Press the <  > button.
- The last image captured or played back is displayed.



## 2. Select an image.

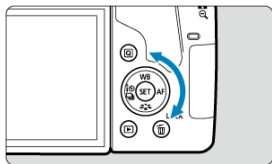



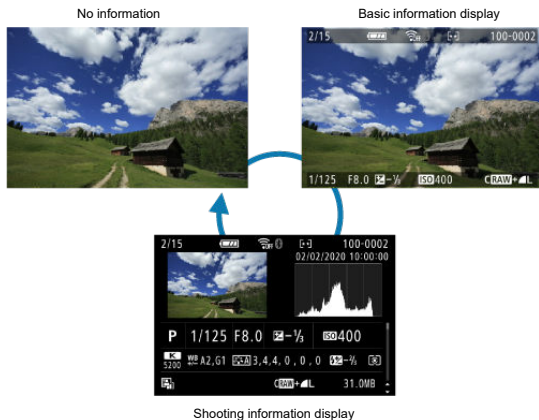

- To play back images starting with the most recent, turn the **< [Dial] >** dial counterclockwise. To play back images starting with the first captured image, turn the dial clockwise.
- Images can also be selected with the **< [Left Arrow] > [Right Arrow] >** keys.
- Each time you press the **< INFO >** button, the display will change.



## 3. Exit the image playback.

- Press the **< [Right Arrow] >** button to exit the image playback and return to shooting standby.

 **Note**

- When RAW images shot with [: **Still img aspect ratio**] set to an option other than [**3:2**] () are played back, frame lines indicating the image area will be displayed.
- If the search conditions are set with [: **Set image search conditions**] (), only the filtered images will be displayed.

## Shooting Information Display

---



With the shooting information screen displayed (), you can press the <▲> <▼> keys to change the information displayed at the bottom of the screen.

## Index Display (Multiple-Image Display)

---

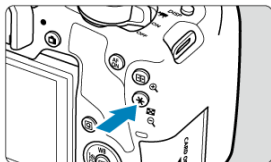
### 1. Switch to the index display.



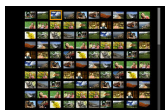
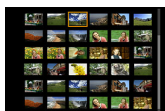

- During image playback, press the <  > button.
- The 4-image index display will appear. The selected image is highlighted with an orange frame. Pressing the <  > button again switches display from 9 images to 36, and then to 100. Pressing the <  > button switches display from 100 images to 36, 9, 4, and then single-image display.



## 2. Select an image.



- Turn <  > or the <  > dial to move the orange frame for image selection.
- Press <  > in the index display to display the selected image in the single-image display.

## Touch Playback

The camera features a touch-screen panel that you can touch to control playback. Supported touch operations are like those used with smartphones and similar devices. First, press the <  > button to prepare for touch playback.

### Browse images

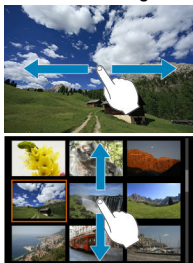

### Jump display

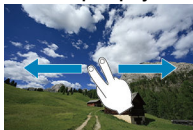

### Index display



### Magnified view





#### Note

- You can also magnify display by double-tapping with one finger.

## Magnified Image Display

---



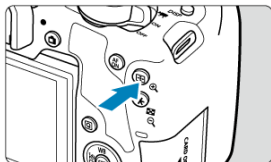



### 1. Switch to magnified view.



- During image playback, press the <  > button.



(1)

- The magnified view will appear. The magnified area position (1) will be displayed in the lower right of the screen.
- Each press of the <  > button magnifies display.
- Each press of the <  ·  > button reduces display. For index display () , press the <  ·  > button again after the final reduction.



## 2. Scroll the image.

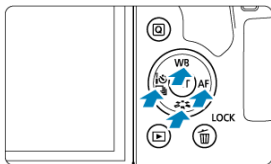

- Press the <▲><▼><◀><▶> keys to scroll images vertically or horizontally in the direction you press.
- To cancel the magnified view, press the <▶> button or tap [MENU▶].

# Movie Playback

---



## 1. Switch to playback.





- Press the <  > button.

## 2. Select a movie.

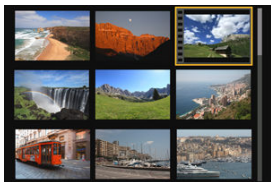

- Use the <  > dial to select the movie to play back.
- In single-image display, the [**SET** ] icon displayed in the upper left of the screen indicates a movie.



- In the index display, perforations at the left edge of a thumbnail indicate a movie. As movies cannot be played back from the index display, press <  > to switch to the single-image display.

3. In the single-image display, press < SET >.



4. Press < SET > to play back the movie.

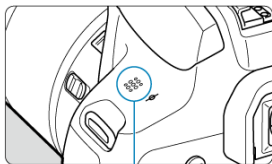



























(1)

(1) Speaker

- The movie will start playing back.
- You can pause playback and display the movie playback panel by pressing < SET >. Press it again to resume the playback.
- Pressing the < ► > key skips forward approx. 4 sec. during playback. Similarly, pressing the < ◀ > key skips back approx. 4 sec.
- You can also adjust the volume during movie playback by using the < ▲ > < ▼ > keys.

## Movie playback panel

Option	Playback Operations
 <b>Play</b>	Pressing <  > toggles between playback and stop.
 <b>Slow motion</b>	Adjusts the slow motion speed with the <  > <  > keys. The slow motion speed is indicated in the upper right of the screen.
 <b>Skip backward</b>	Skips backward approx. 4 sec. each time you press <  >.
 <b>Previous frame</b>	Displays the previous frame each time you press <  >. Holding <  > down will rewind the movie.
 <b>Next frame</b>	Plays the movie frame-by-frame each time you press <  >. Holding <  > down will fast forward the movie.
 <b>Skip forward</b>	Skips forward approx. 4 sec. each time you press <  >.
 <b>Edit</b>	Displays the editing screen (  ).
 <b>Frame Grab</b>	Available when you play 4K or 4K time-lapse movies. Enables you to extract the current frame and save it as a JPEG still image (  ).
 <b>Background music</b>	Plays back a movie with the selected background music (  ).
	Playback position
mm' ss"	Playback time (minutes:seconds)
 <b>Volume</b>	Use the <  > <  > keys to adjust the speaker volume (  ).

## Movie Playback Panel (Video Snapshot Albums)

Option	Playback Operations
Play	Pressing < SET > toggles between playback and stop.
Slow motion	Adjusts the slow motion speed with the < ◀ > < ▶ > keys. The slow motion speed is indicated in the upper right of the screen.
Previous clip	Displays the first frame of the previous video snapshot.
Previous frame	Displays the previous frame each time you press < SET >. Holding < SET > down will rewind the movie.
Next frame	Plays the movie frame-by-frame each time you press < SET >. Holding < SET > down will fast forward the movie.
Next clip	Displays the first frame of the next video snapshot.
Erase clip	Erases the current video snapshot.
Edit	Displays the editing screen (ⓐ).
Background music	Plays back an album with the selected background music (ⓐ).
	Playback position
mm' ss"	Playback time (minutes:seconds)
Volume	Use the < ▲ > < ▼ > keys to adjust the speaker volume (ⓐ).

### Caution

- Adjust the volume using television controls when the camera is connected to a television for movie playback (ⓐ), because volume cannot be adjusted with the < ▲ > < ▼ > keys.
- Movie playback may stop if the card's read speed is too slow or movie files have corrupted frames.

### Note

- For details on the movie recording time available, see [Time available for movie recording](#).

## Editing a Movie's First and Last Scenes

---

1. In single-image display, press  $\langle$  [SET]  $\rangle$ .

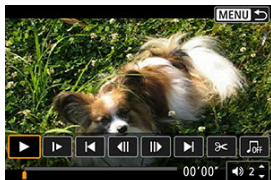

- The movie playback panel will appear.

2. On the movie playback panel, select [ZOOM].

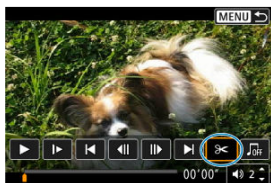

### 3. Specify the part to be edited out.

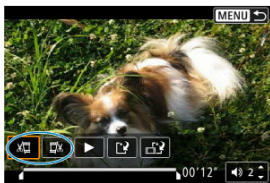

- Select either [Cut beginning] or [Cut end].

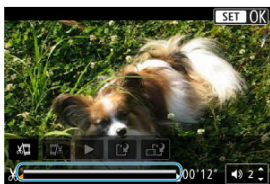

- Press the <◀>>▶> keys to go back or forward one frame (or video snapshot) at a time. Keep holding down the <▶> key to fast forward.
- After deciding which part to edit out, press <SET>. The portion indicated by a line at the bottom of the screen will remain.

### 4. Check the edited movie.

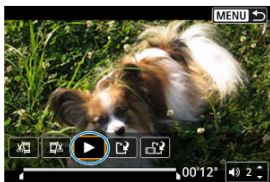

- Select [▶] to play back the edited movie.
- To change the edited part, go back to step 3.
- To cancel the editing, press the <MENU> button.

## 5. Save the image.

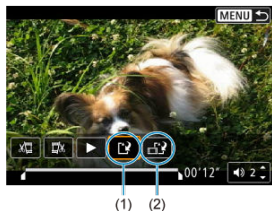

- Select [(1)] (1).
- The save screen will appear.
- To save it as a new file, select **[New file]**. To save it and overwrite the original movie file, select **[Overwrite]**.
- Select [(2)] (2) to save a compressed version of the file. 4K movies are converted to Full HD movies before compression.
- On the confirmation screen, select **[OK]** to save the edited movie and return to the movie playback screen.

### Caution

- Because editing is performed in approx. 1 sec. increments (at the position indicated by [X] at the bottom of the screen), the actual position where movies are trimmed may differ from your specified position.
- Movies recorded with another camera cannot be edited with this camera.
- You cannot edit a movie when the camera is connected to a computer.
- Compress and save is not available for movie recording sizes of **[FHD 29.97P] [IPB]** (NTSC) or **[FHD 25.00P] [IPB]** (PAL).

### Note

- For instructions on editing video snapshot albums, see [Creating Albums](#).



# Frame Extraction from 4K Movies or 4K Time-Lapse Movies

---

From 4K movies or 4K time-lapse movies, you can select individual frames to save as approx. 8.3 megapixel (3840×2160) JPEG still images. This function is called "Frame Grab (4K frame capture)".



---

## 1. Switch to playback.

- Press the <  > button.

## 2. Select a 4K movie or 4K time-lapse movie.



- Select with the < ◀ ▶ > keys.
- On the shooting information screen (  ), 4K movies and 4K time-lapse movies are indicated by an  icon.
- In index display, press <  > to switch to single-image display.

## 3. In the single-image display, press < >.

- The movie playback panel will appear.

4. Select a frame to grab.



- Use the movie playback panel to select the frame to grab as a still photo.
- For movie playback panel instructions, see [Movie Playback Panel](#).

5. Select [Grab].



6. Save the image.

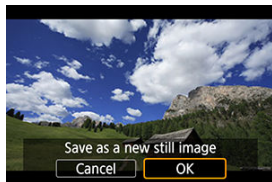

- Select [**OK**] to save the current frame as a JPEG still image.

## 7. Select the image to display.

- Check the destination folder and image file number.
- Select [**View original movie**] or [**View extracted still image**].

### Caution

- Frame grabbing is not possible with Full HD movies, Full HD time-lapse movies, or with 4K movies or 4K time-lapse movies from a different camera.

## Playback on a TV Set

---

By connecting the camera to a television with an HDMI cable, you can play back the captured still photos and movies on the television. Using the HDMI Cable HTC-100 (sold separately) is recommended.

If the image does not appear on the TV screen, check if the [**Video system**] is correctly set to [**For NTSC**] or [**For PAL**] (depending on the video system of your television).

---

### 1. Connect the HDMI cable to the camera.

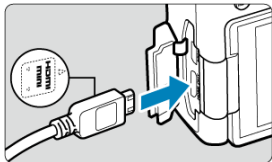

- With the plug's < ▲ **HDMI MINI**> logo facing the front of the camera, insert it into the < **HDMI OUT**> terminal.

### 2. Connect the HDMI cable to the television.

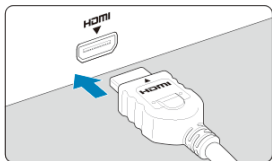

- Connect the HDMI cable to the television's HDMI IN port.

### 3. Turn on the television and switch the television's video input to select the connected port.

### 4. Set the camera's power switch to < ON >.

5. Press the < ▶ > button.

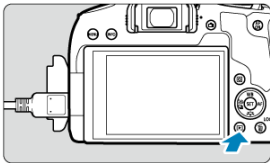

- The image will appear on the TV screen. (Nothing will be displayed on the camera screen.)
- Images are automatically displayed at optimal resolution for connected televisions.

**Caution**

- Adjust movie sound volume with the TV set. The sound volume cannot be adjusted with the camera.
- Before connecting or disconnecting the cable between the camera and television, turn off the camera and television.
- Depending on the television, part of the image displayed may be cut off.
- Do not connect any other device's output to the camera's < **HDMI OUT** > terminal. Doing so may cause a malfunction.
- Certain televisions may not display the images due to incompatibility.
- It may take some time before images are displayed. To avoid delay, set [**⚙**: **HDMI resolution**] to [**1080p**] (**Ⓢ**).
- Touch-screen operations are not supported while the camera is connected to a television.

# Protecting Images

---

- ☑ [Protecting a Single Image](#)
- ☑ [Specifying the Range of Images to be Protected](#)
- ☑ [Protecting All Images in a Folder or on a Card](#)

You can protect important images from being accidentally erased.

---

## Protecting a Single Image

---

1. Select [: Protect images].

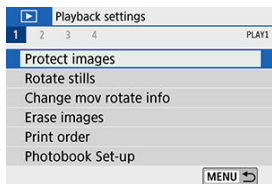

2. Select [Select images].

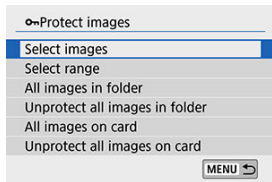





3. Select an image.

- Use the < ◀ > ▶ > keys to select the image to be protected.

#### 4. Protect the image.



- Press <  > to protect the selected image, after which it will be labeled with a <  > icon (1) at the top of the screen.
- To cancel protection and clear the <  > icon, press <  > again.
- To protect another image, repeat steps 3 and 4.

## Specifying the Range of Images to be Protected

While looking at the images in the index display, you can specify the first and last images for a range to protect all the specified images at once.

### 1. Select [Select range].

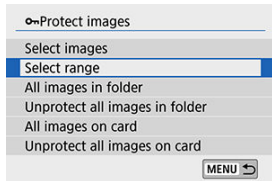

- Select [Select range] in [ ]: Protect images].

### 2. Specify the range of images.



- Select the first image (start point).
- Next, select the last image (end point). The images in the specified range will be protected and the < lock icon > will appear.
- To select another image to be protected, repeat step 2.



## Protecting All Images in a Folder or on a Card

You can protect all the images in a folder or on a card at once.

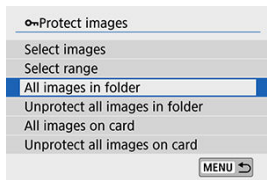

- When you select **[All images in folder]** or **[All images on card]** in **[ ]: Protect images**, all the images in the folder or on the card will be protected.
- To cancel the selection, select **[Unprotect all images in folder]** or **[Unprotect all images on card]**.
- If the search conditions are set with **[ ]: Set image search conditions** (🔍), the display will change to **[All found images]** and **[Unprotect all found]**.

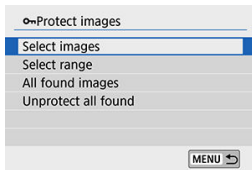

- If you select **[All found images]**, all the images filtered by the search conditions will be protected.
- If you select **[Unprotect all found]**, the protection of all the filtered images will be canceled.

### ⚠ Caution

- If you format the card (🗑), the protected images will also be erased.

### 📄 Note

- Once an image is protected, it cannot be erased by the camera's erase function. To erase a protected image, you must first cancel the protection.
- If you erase all the images (🗑), only the protected images will remain. This is convenient when you want to erase all unnecessary images at once.

# Rotating Still Photos

---

You can use this feature to rotate the displayed image to the desired orientation.

---

## 1. Select [▶]: Rotate stills].

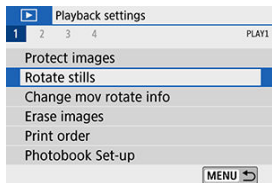

## 2. Select an image.

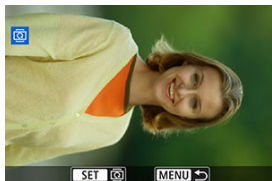

- Use the < ◀ ▶ > keys to select the image to rotate.

## 3. Rotate the image.

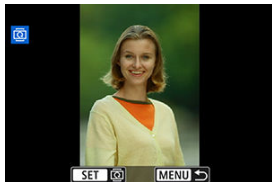

- Each time you press < SET >, the image will rotate clockwise as follows: 90°→270°→0°.
- To rotate another image, repeat steps 2 and 3.



## Note

- If you set [**Auto rotate**] to [**On**] before taking vertical shots, you need not rotate the image with this function.
- If the rotated image is not displayed in the rotated orientation during image playback, set [**Auto rotate**] to [**Off**].

## Changing Movie Orientation Information

---

You can manually change movie orientation information (which determines which side is up).

---

1. Select []: Change mov rotate info].

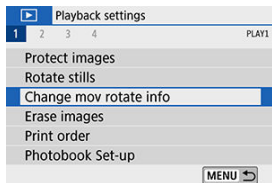

2. Select a movie.

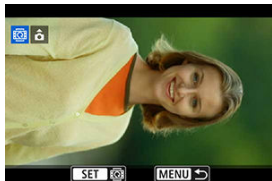

- Use the << >> <> >> keys to select a movie with orientation information to change.

### 3. Press < SET >.

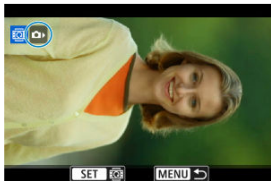

- As you watch the image orientation icon in the upper left of the screen, press < SET > to specify which side is up.



#### Note

- Orientation information of video snapshot albums cannot be changed.
- Movies are played horizontally on the camera, regardless of the [👤: Add 🗨️ rotate info] setting (🔗).

## Erasing Images

---

- [Erasing a Single Image](#)
- [Selecting \(\[✓\]\) Multiple Images to Erase Together](#)
- [Specifying the Range of Images to Be Erased](#)
- [Erasing All Images in a Folder or on a Card](#)

You can either select and erase unnecessary images one by one or erase them in one batch. Protected images (🔒) will not be erased.

### ⚠ Caution

- **Once an image is erased, it cannot be recovered. Make sure you no longer need the image before erasing it. To prevent important images from being erased accidentally, protect them.**

---

## Erasing a Single Image

---

1. **Select the image to be erased.**
  - Press the < ▶ > button.
  - Select with the < ◀ > ▶ > keys.
2. **Press the < 🗑 > button.**



### 3. Erase the images.

JPEG or RAW images or movies

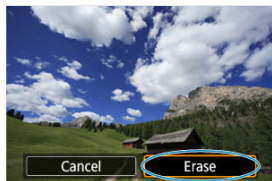

- Select [Erase].

RAW+JPEG images



- Select an item.

## Selecting ([✓]) Multiple Images to Erase Together

By adding checkmarks to the images to be erased, you can erase all those images at once.

### 1. Select [▶]: Erase images].

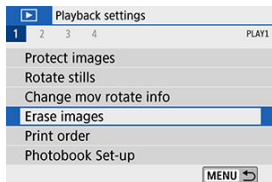

### 2. Select [Select and erase images].

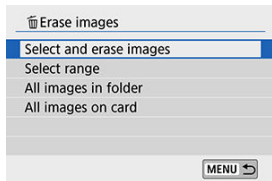

### 3. Select an image.



- Use the < ◀ ▶ > keys to select the image to be erased, then press < (SET) >.
- To select another image to be erased, repeat step 3.



#### 4. Erase the image.

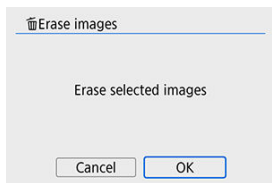

- Press the <  > button, then press **[OK]**.

## Specifying the Range of Images to Be Erased

While looking at the images in the index display, you can specify the first and last images for a range to erase all the specified images at once.

### 1. Select [Select range].

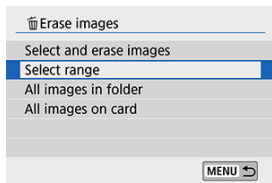

### 2. Specify the range of images.



- Select the first image (start point).
- Next, select the last image (end point).

### 3. Press the < > button.

#### 4. Erase the images.

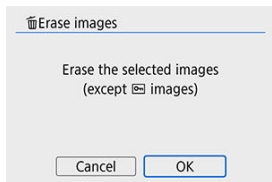

- Select **[OK]**.

## Erasing All Images in a Folder or on a Card

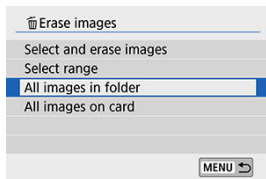

- When [▶]: **Erase images**] is set to [All images in folder] or [All images on card], all the images in the folder or on the card will be erased.
- If the search conditions are set with [▶]: **Set image search conditions**] (🔍), the display will change to [All found images].

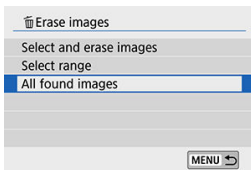

- If you select [All found images], all the images filtered by the search conditions will be erased.

### Note

- To erase all the images including protected images, format the card (🔒).

# Print Ordering (DPOF)

---

 [Setting Print Options](#)

 [Selecting Images for Printing](#)

DPOF (Digital Print Order Format) enables you to print images recorded on the card according to your printing instructions such as the image selection, quantity to print, etc. You can print multiple images in one batch or create a print order for a photofinisher.

You can set the print settings such as print type, date imprinting, file number imprinting, etc. The print settings will be applied to all the images specified for printing. (They cannot be set individually for each image.)

---

## Setting Print Options

---

### 1. Select []: Print order].

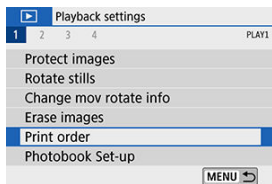

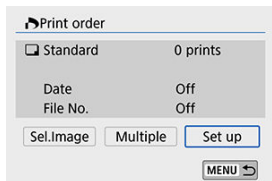

### 2. Select [Set up].



### 3. Set the options as desired.

- Set the **[Print type]**, **[Date]**, and **[File No.]**.

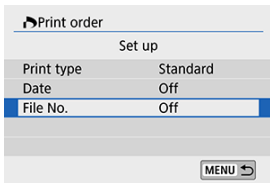

<b>Print type</b>	 <b>Standard</b>	Prints one image on one sheet.
	 <b>Index</b>	Multiple thumbnail images are printed on one sheet.
	 <b>Both</b>	Prints both the standard and index prints.
<b>Date</b>	<b>On</b>	[On] imprints the recorded date of the captured image.
	<b>Off</b>	
<b>File No.</b>	<b>On</b>	[On] imprints the file number.
	<b>Off</b>	

### 4. Exit the setting.



- Press the < **MENU** > button.
- Next, select **[Sel.Image]** or **[Multiple]** to order the images to be printed.

 **Caution**

- If you print an image with a large image size using the **[Index]** or **[Both]** setting () , the index print may not be printed with certain printers. In this case, resize the image () , then print the index print.
- Even if **[Date]** and **[File No.]** are set to **[On]**, the date or file number may not be imprinted, depending on the print type setting and printer.
- With **[Index]** prints, the **[Date]** and **[File No.]** cannot both be set to **[On]** at the same time.
- When printing with DPOF, use the card for which print order specifications are set. You cannot print in the specified print order if you extract just the images from the card for printing.
- Certain DPOF-compliant printers and photofinishers may not be able to print the images as you specified. When using a printer, refer to the printer's instruction manual. When requesting service from a photofinisher, ask in advance.
- Do not use this camera to configure print settings for images with DPOF settings set up on another camera. All the print orders may be overwritten inadvertently. Also, the print order may not be possible, depending on the image type.

## Selecting Images for Printing

### ● Sel.Image

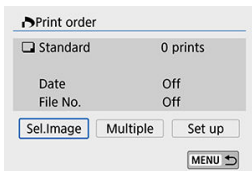

Select and specify the images one by one.

Press the < MENU > button to save the print order to the card.

#### • Standard/Both



Press < SET > to print a copy of the displayed image. By turning the < ⌚ > dial, you can set a print quantity of up to 99 copies.

#### • Index

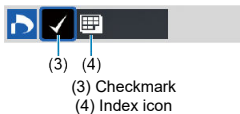

Press < SET > to add a checkmark [✓] to the box. The image will be included in the index print.



## ● Multiple

### • Select range

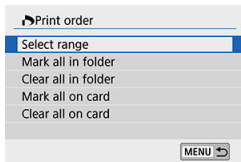

Under **[Multiple]**, select **[Select range]**. Selecting the first and last images of the range marks all the images in the range with a checkmark [✓], and one copy of each image will be specified for printing.

### • All images in a folder

Select **[Mark all in folder]** and select the folder. A print order for one copy of all the images in the folder will be specified.

If you select **[Clear all in folder]** and select the folder, the print order for all the images in the folder will be canceled.

### • All images on a card

If you select **[Mark all on card]**, one copy of all the images on the card will be specified for printing.

If you select **[Clear all on card]**, the print order will be cleared for all the images on the card.

If the search conditions are set with **[▶: Set image search conditions]** (🔍) and you select **[Multiple]**, the display will change to **[Mark all found images]** and **[Clear all found images]**.

## ● All found images

If you select **[Mark all found images]**, one copy of all the images filtered by the search conditions will be specified for printing.

If you select **[Clear all found images]**, all the print order of the filtered images will be cleared.

 **Caution**

- RAW images or movies cannot be specified for printing. Note that RAW images or movies will not be specified for printing even if you specify all images with **[Multiple]**.
- When using a PictBridge-compatible printer, do not specify more than 400 images for one print order. If you specify more than this, the images may not all be printed.

# Photobook Set-up

---

- [Specifying Images Individually](#)
- [Specifying the Image Range for a Photobook](#)
- [Specifying All Images in a Folder or Card](#)

You can specify up to 998 images for printing in a photobook. When you use EOS Utility (EOS software) to import images to a computer, the specified images for a photobook will be copied to a dedicated folder. This function is useful for ordering photobooks online.

---

## Specifying Images Individually

---

1. Select []: Photobook Set-up].

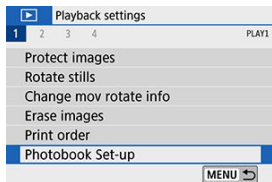

2. Select [Select images].

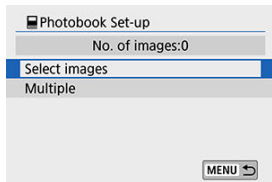

**3. Select the image to be specified.**



- Use the <◀><▶> keys to select the image to be specified for a photobook, then press <Ⓕ>.
- To select other images to be specified for a photobook, repeat step 3.

## Specifying the Image Range for a Photobook

While looking at the images in the index display, you can specify the range (start point to end point) of images to be specified for a photobook at once.

### 1. Select [Multiple].

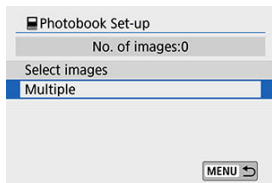

- Under [▶]: **Photobook Set-up**, select **[Multiple]**.

### 2. Select [Select range].

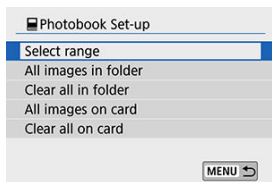

### 3. Specify the range of images.



- Select the first image (start point).
- Next, select the last image (end point). A checkmark [✓] will be appended to all the images within the range between first and last images.

## Specifying All Images in a Folder or Card

You can specify all the images in a folder or on a card at once for a photobook.

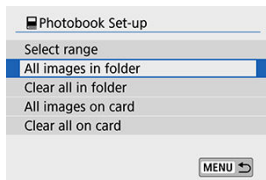

- Under **[▶]: Photobook Set-up**, you can set **[Multiple]** to **[All images in folder]** or **[All images on card]** to specify all the images in the folder or on the card for a photobook.
- To cancel the selection, select **[Clear all in folder]** or **[Clear all on card]**.
- If the search conditions are set with **[▶]: Set image search conditions** (🔍) and you select **[Multiple]**, the display will change to **[All found images]** and **[Clear all found images]**.

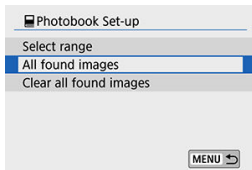

- If you select **[All found images]**, all the found images will be specified for the photobook.
- If you select **[Clear all found images]**, all the photobook order of the filtered images will be cleared.

### ⚠ Caution

- RAW images or movies cannot be specified for the photobook. Note that RAW images or movies will not be specified for the photobook even if you specify all images with **[Multiple]**.
- Do not use this camera to configure photobook settings for images with photobook settings set up on another camera. All the photobook settings may be overwritten inadvertently.

# Creative Filters

---

You can apply the following filter processing to an image and save it as a separate image: Grainy B/W, Soft focus, Fish-eye effect, Art bold effect, Water painting effect, Toy camera effect, and Miniature effect.

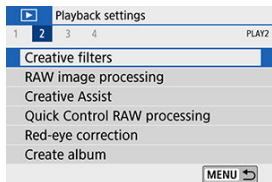

---

## 1. Select [ : Creative filters].



## 2. Select an image.



- Use the < ◀ > ▶ > keys to select an image, then press <  >.
- You can press the <  > button to select the image using the index display.



3. Select a filter effect (🔍).



4. Adjust the filter effect.

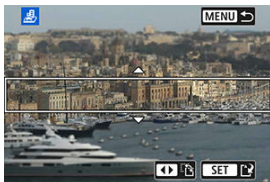

- Adjust the filter effect, then press < (SET) >.
- For **[Miniature effect]**, turn the < 🌞 > or < 🌑 > dial to move the white frame enclosing the area to keep in sharper focus, then press < (SET) >.

5. Save the image.

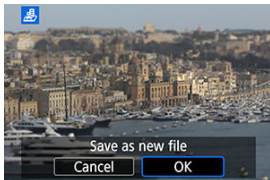

- Select **[OK]**.
- Check the destination folder and image file number, then select **[OK]**.
- To apply filter processing to other images, repeat steps 2–5.



#### Note

- For images captured in RAW+JPEG shooting, filter processing is applied to the RAW image, and the results are saved as a JPEG.
- For RAW images captured at a specific aspect ratio, the resulting image is saved at that aspect ratio after filter processing.
- Images processed using the fish-eye effect filter will not have Dust Delete Data (☑) appended.

## Creative Filter Characteristics

---

-  **Grainy B/W**

Makes the image grainy and black and white. By adjusting the contrast, you can change the black-and-white effect.

-  **Soft focus**

Gives the image a soft look. By adjusting the blur, you can change the degree of softness.

-  **Fish-eye effect**

Gives the effect of a fish-eye lens. The image will have barrel distortion. Depending on the level of this filter effect, the area trimmed along the periphery of the image changes. Also, because this filter effect magnifies the center of the image, the apparent resolution at the center may degrade depending on the number of recorded pixels, so set the filter effect in step 4 while checking the resulting image.

-  **Art bold effect**

Makes the photo look like an oil painting and the subject look more three-dimensional. By adjusting the effect, you can change the contrast and saturation. Note that subjects such as the sky or white walls may not be rendered with a smooth gradation and may look irregular or have significant noise.

-  **Water painting effect**

Makes the photo look like a watercolor painting with soft colors. By adjusting the effect, you can change the color density. Note that night scenes or dark scenes may not be rendered with a smooth gradation and may look irregular or have significant noise.

-  **Toy camera effect**

Shifts colors to those typical of toy cameras and darkens the four corners of the image. Color tone options can be used to change the color cast.

-  **Miniature effect**

Creates a diorama effect. You can change where the image looks sharp. To switch between vertical and horizontal orientation of the sharp area (white frame), press the < ◀ > ▶ > keys in step 4 (or tap  on the screen).

- ☑ [Magnified View](#)
- ☑ [Processing Images with Specified Aspect Ratios](#)
- ☑ [RAW Image Processing Options](#)

You can process **RAW** or **CRAW** images with the camera to create JPEG images. RAW images are not affected, so different conditions can be applied to create JPEGs. You can also use Digital Photo Professional (EOS software) to process RAW images.

---

## 1. Select []: RAW image processing].

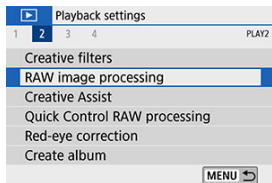

## 2. Select an item, then select images.

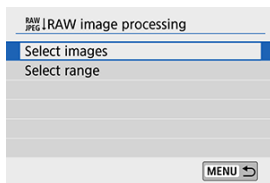

- You can select multiple images to process at once.

### Selecting images



- Use the < ◀ ▶ > keys to select images to process, then press < (SET) >.
- Press the < [Q] > button.

## Selecting range



- Select the first image (start point).
- Next, select the last image (end point).
- Press the < Q > button.

### 3. Set the desired processing conditions.

#### Use shot settings

- Images are processed using image settings at the time of capture.

#### Customize RAW processing



- Select an item with the <▲> <▼> <◀> <▶> keys.
- Turn the <☀> or <⊙> dial to switch the setting.
- Press <SET> to access the function setting screen.
- To return to the image settings at the time of shooting, press the <🗑> button.

#### Comparison screen

- You can switch between the **[After change]** and **[Shot settings]** screens by pressing the <INFO> button and turning the <⊙> dial.
- Items in orange on the **[After change]** screen have been modified since the time of capture.
- Press the <MENU> button.

#### 4. Save the image.

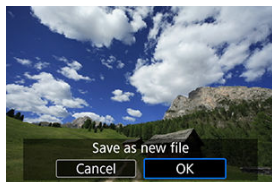

- When using [**Customize RAW processing**], select [**S**] (Save).
- Read the message and select [**OK**].
- To process other images, select [**Yes**] and repeat steps 2–4.

#### 5. Select the image to display.







- Select [**Original image**] or [**Processed img.**].



## Magnified View

---

You can magnify images displayed for **[Customize RAW processing]** by pressing the  button. Magnification varies depending on the **[Image quality]** setting. With the     keys, you can scroll around the magnified image.

To cancel the magnified view, tap **[MENU]**  or press the   button.

## Processing Images with Specified Aspect Ratios

---

JPEG images at the specified aspect ratio are created when you process RAW images shot with **[Still img aspect ratio]**  set to an option other than **[3:2]**.

## RAW Image Processing Options

---

-  **Brightness adjustment**

You can adjust the image brightness up to  $\pm 1$  stop in 1/3-stop increments.

-  **White balance** 



You can select the white balance. If you select **[AWB]**, you can select **[Auto: Ambience priority]** or **[Auto: White priority]**. If you select **[K]**, you can set the color temperature.

-  **Picture Style** 



You can select the Picture Style. You can adjust the sharpness, contrast, and other parameters.

-  **Auto Lighting Optimizer** 

You can set the Auto Lighting Optimizer.

-  **High ISO speed NR** 

You can set the noise reduction processing for high ISO speeds. If the effect is difficult to discern, magnify the image .

-  **Image quality** 

You can set the image quality when creating a JPEG image.

- **sRGB Color space** 

You can select either sRGB or Adobe RGB. Since the camera screen is not compatible with Adobe RGB, the difference in the image will hardly be perceptible when either color space is set.

## ● Lens aberr correction

### • OFF **Peripheral illum corr**

A phenomenon that makes the image corners look darker due to the lens characteristics can be corrected. If **[Enable]** is set, the corrected image will be displayed. If the effect is difficult to discern, magnify the image  and check the four corners. The peripheral illumination correction applied with the camera will be less pronounced than that applied with the Digital Photo Professional (EOS software) at maximum correction amount. If the effects of correction are not apparent, use Digital Photo Professional to apply the peripheral illumination correction.

### • OFF **Distortion correction**

Image distortion due to lens characteristics can be corrected. If **[Enable]** is set, the corrected image will be displayed. The image periphery will be trimmed in the corrected image.

Since the image resolution may look slightly lower, adjust the sharpness with the Picture Style's **[Sharpness]** parameter setting as necessary.

### • OFF **Digital Lens Optimizer**

Correct lens aberration, diffraction, and low-pass filter-induced loss of sharpness by applying optical design values. Selecting **[Enable]** corrects both chromatic aberration and diffraction, although these options are not displayed.

### • OFF **Chromatic aberr corr**

Chromatic aberrations (color fringing along the subject's outline) due to the lens characteristics can be corrected. If **[Enable]** is set, the corrected image will be displayed. If the effect is difficult to discern, magnify the image .

### • OFF **Diffraction correction**

The diffraction by the lens aperture degrading the image sharpness can be corrected. If **[Enable]** is set, the corrected image will be displayed. If the effect is difficult to discern, magnify the image .

 **Caution**

- Processing RAW images in the camera will not produce exactly the same results as processing RAW images with Digital Photo Professional (EOS software).
- If you perform [**Brightness adjustment**], noise, banding, etc. may be intensified with the effects of adjustment.
- When [**Digital Lens Optimizer**] is set, noise may be intensified together with the effects of correction. Image edges may also be emphasized. Adjust Picture Style sharpness or set [**Digital Lens Optimizer**] to [**Disable**], as needed.
- [Dust Delete Data](#) is not added to images when processing is performed with [**Distortion correction**] set to [**Enable**].

 **Note**

- Lens correction data for lenses compatible with this feature is registered (stored) on the camera.
- The effect of the lens aberration correction varies depending on the lens used and shooting conditions. Also, the effect may be difficult to discern depending on the lens used, shooting conditions, etc.
- For details on the correction data used with Digital Lens Optimizer, see [Digital Lens Optimizer](#).

# Creative Assist

---

You can process RAW images by applying your preferred effects and saving as JPEGs.

---

## 1. Select [▶]: Creative Assist].

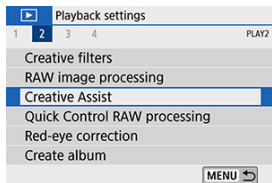

## 2. Select an image.



- Use the < ◀ ▶ > keys to select images to process, then press < (SET) >.

### 3. Select an effect.



- Use the <◀><▶> keys to select the effect.



- By selecting [**Preset**] and pressing <SET>, you can choose [**VIVID**], [**SOFT**], or other preset effects. [**AUTO1**], [**AUTO2**], and [**AUTO3**] are effects recommended by the camera based on image conditions.



- You can select effects such as [**Brightness**] or [**Contrast**] by pressing <SET> and then using the <◀><▶> keys.
- Press <SET> when adjustment is finished.



- To reset the effect, press the < ✖ > button.
- To confirm the effect, press the <  > button.

**4. Select [OK] to save the image.**

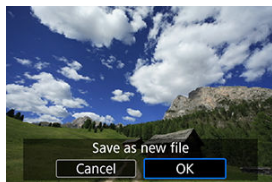

You can select the type of RAW image processing performed from the Quick Control screen.

1. Select [▶]: Quick Control RAW processing].

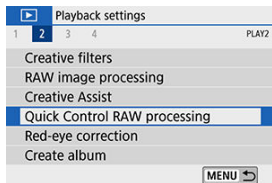

2. Select an item.

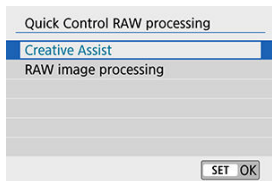

- **Creative Assist**

RAW processing that applies your preferred effect (📷).

- **RAW image processing**

RAW processing according to conditions you specify (📷).



# Red-Eye Correction

---

Automatically corrects relevant portions of images affected by red-eye. The image can be saved as a separate file.

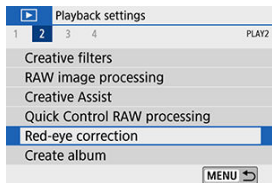

---

1. Select [: Red-eye correction].



2. Select an image with the <  <  > keys.



- After image selection, either tap [] or press <  >.
- White frames are displayed around corrected image areas.

3. Select [OK].

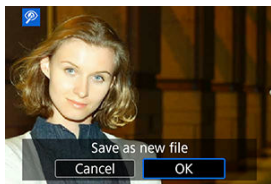

- The image is saved as a separate file.

 **Caution**

- Some images may not be corrected accurately.

# Creating Albums

---

## 1. Select [MENU]: Create album].

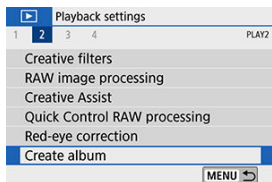





## 2. Select an album to edit.



- Press < SET > to add a checkmark [✓].
- After selection, press the < Q > button.

### 3. Select an editing option.



Option	Description
 <b>Rearrange video snapshots</b>	Use the < ◀ > ▶ > keys to select a video snapshot to move, then press < SET >. Use the < ◀ > < ▶ > keys to move it, then press < SET >.
 <b>Remove video snapshot</b>	Use the < ◀ > ▶ > keys to select a video snapshot to delete, then press < SET >. Selected video snapshots are labeled [  ]. To clear the selection and remove [  ], press < SET > again.
 <b>Play video snapshot</b>	Use the < ◀ > ▶ > keys to select a video snapshot to play, then press < SET >. Use the < ▲ > < ▼ > keys to adjust the volume.

### 4. Finish editing.



- Press the < MENU > button when you are finished editing.
- Select [  ] (Finish editing).

## 5. Save the image.

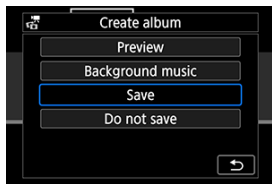

- To play an album with background music, use [**Background music**] to select the music (🎵).
- To check your editing, select [**Preview**].
- Selecting [**Save**] saves the edited album as a new album.

### ⚠ Caution

- Video snapshot albums can only be edited once.

## Selecting Background Music

Albums and slideshows can be played with background music once you copy the music to the card, using EOS Utility (EOS software).

### 1. Select [Background music].

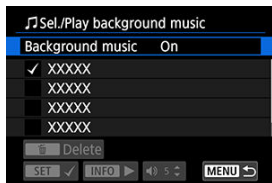

- Set [Background music] to [On].

### 2. Select the background music.

- Use the <▲> <▼> keys to select the music, then press <SET>. For [Slide show], you can select multiple tracks.

### 3. Listen to a sample.

- To listen to a sample, press the <INFO> button.
- Use the <▲> <▼> keys to adjust the volume. Press the <INFO> button again to stop playback.
- To delete the music, use the <▲> <▼> keys to select it, then press the <Delete> button.

#### Note

- For instructions on copying background music to cards, refer to the EOS Utility Instruction Manual.

# Cropping

---

You can crop a captured JPEG image and save it as another image. Cropping an image is possible only with JPEG images. Images shot in RAW cannot be cropped.

---

## 1. Select [Cropping].

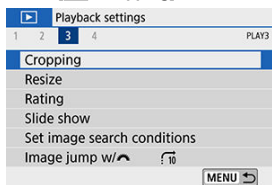

## 2. Select an image.



- Use the <◀><>▶> keys to select the image to crop.

### 3. Set the cropping frame.





- Press < **SET** > to display the cropping frame.
- The image area within the cropping frame will be cropped.
- **Resizing the cropping frame size**  
Use the < **Q** > or < **Q**+**Q** > button to resize the cropping frame. The smaller the cropping frame, the more magnified the cropped image will look.
- **Changing the cropping frame aspect ratio and orientation**  
Use the < **DISP** > dial to select < **ASPECT** >. Press < **SET** > to change the cropping frame's aspect ratio.
- **Moving the cropping frame**  
Use the < **▲** > < **▼** > < **◀** > < **▶** > keys to move the frame vertically or horizontally. Move the cropping frame until it covers the desired image area.
- **Correcting tilt**  
You can correct image tilt by  $\pm 10^\circ$ . Use the < **DISP** > dial to select < **LEVEL** >, then press < **SET** >. While checking tilt relative to the grid, turn the < **DISP** > dial (in  $0.1^\circ$  increments) or tap the left or right arrow (in  $0.5^\circ$  increments) in the upper left of the screen to correct tilt. After completing the tilt correction, press < **SET** >.



#### 4. Check the image area to be cropped.





- Use the <  > dial to select <  >. The image area to crop is displayed.

#### 5. Save the image.



- Use the <  > dial to select <  >.
- Select [OK] to save the cropped image.
- Check the destination folder and image file number, then select [OK].
- To crop another image, repeat steps 2 to 5.

#### Caution

- The position and size of the cropping frame may change depending on the angle set for tilt correction.
- Once a cropped image is saved, it cannot be cropped again or resized.
- AF point display information () and Dust Delete Data () will not be appended to the cropped images.

# Resizing

---

You can resize a JPEG image to make the pixel count lower and save it as a new image. Resizing an image is possible only with JPEG **L/M/S1** images. JPEG **S2** and RAW images cannot be resized.

---

## 1. Select [▶]: Resize].

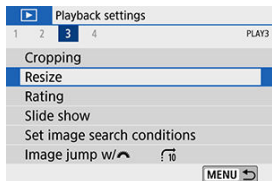

## 2. Select an image.



- Use the <◀><>▶> keys to select the image to resize.

### 3. Select the desired image size.



- Press < **SET** > to display the image sizes.
- Select the desired image size (1).

### 4. Save the image.

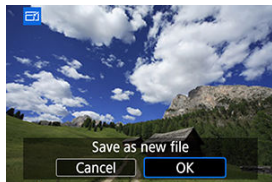

- Select [**OK**] to save the resized image.
- Check the destination folder and image file number, then select [**OK**].
- To resize another image, repeat steps 2 to 4.

#### Note

- For details on image sizes of resized images, see [Still photo pixel count](#).

# Rating Images

---

- [Rating a Single Image](#)
- [Rating by Specifying the Range](#)
- [Rating All Images in a Folder or on a Card](#)

You can rate images on a scale of 1–5 ([\*]/[\* \*]/[\* \* \*]/[\* \* \* \*]/[\* \* \* \* \*]). This function is called rating.  
\* Rating images can help you organize them.

---

## Rating a Single Image

---

1. Select [: Rating].

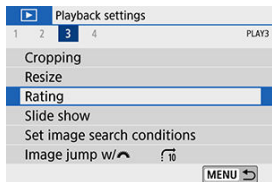

2. Select [Select images].

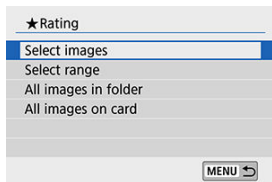

### 3. Select the image to be rated.



- Use the <◀><▶> keys to select the image to rate.

### 4. Rate the image.



- Press <Ⓢ>, and a blue highlight frame will appear as shown in the screen shown above.
- Use the <▲><▼> keys to select a rating mark, then press <Ⓢ>. When you append a rating mark to the image, the number beside the set rating will increase by one.
- To rate another image, repeat steps 3 and 4.

## Rating by Specifying the Range

While looking at the images in the index display, you can specify the first and last images for a range to rate all the specified images at once.

### 1. Select [Select range].

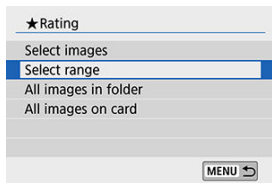

### 2. Specify the range of images.



- Select the first image (start point).
- Next, select the last image (end point).  
A checkmark [✓] will be appended to all the images within the range between first and last images.

### 3. Press the < [Q] > button.

## 4. Rate the images.

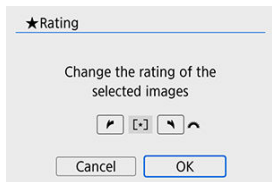

- Turn the <  > dial to select a rating mark, then select [OK]. All the images in the specified range will be rated (same rating) at once.

## Rating All Images in a Folder or on a Card

You can rate all the images in a folder or on a card at once.

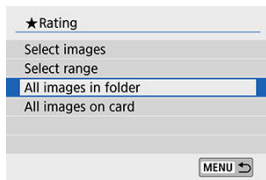

- Under **[▶]: Rating**, when you select **[All images in folder]** or **[All images on card]**, all the images in the folder or on the card will be rated.

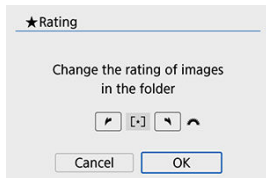

- Turn the **< [Sun] >** dial to select a rating mark, then select **[OK]**.
- When you are not rating images or canceling the rating, select **[OFF]**.
- If the search conditions are set with **[▶]: Set image search conditions** **[🔍]**, the display will change to **[All found images]**.

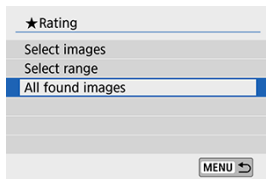

- If you select **[All found images]**, all the images filtered by the search conditions will be rated as specified.





#### Note

- Values next to ratings are displayed as [###] if more than 1,000 images have that rating.
- With [▶]: **Set image search conditions**] and [▶]: **Image jump w/🌅**], you can display only the images given a specific rating.

# Slide Show

---

You can play back the images on the card as an automatic slide show.

---

## 1. Specify the images to be played back.

- To play back all the images on the card, go to step 2.
- If you want to specify the images to be played back in the slide show, filter the images with **[▶]: Set image search conditions** (🔍).

## 2. Select **[▶]: Slide show**.

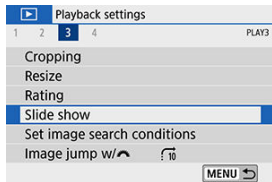

### 3. Set the playback as desired.

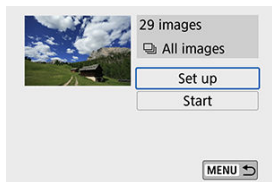

- Select [**Set up**].
- Set the [**Display time**], [**Repeat**] (repeated playback), and [**Transition effect**] (effect when changing images) for the still photos.
- To play background music, use [**Background music**] to select the music (🔍).
- After completing the settings, press the <MENU> button.

#### Display time

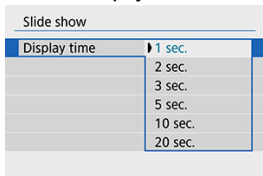

#### Repeat

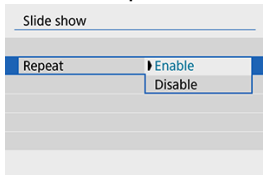

### Transition effect

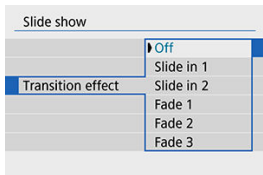

### Background music

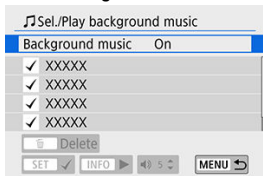

## 4. Start the slide show.

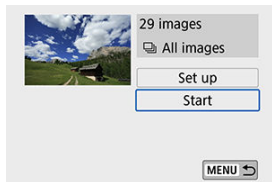









- Select [**Start**].
- After [**Loading image...**] is displayed, the slide show will start.

## 5. Exit the slide show.

- To exit the slide show and return to the setting screen, press the < **MENU** > button.



## Note

- To pause the slide show, press <  >. During pause,  will be displayed in the upper left of the screen. Press <  > again to resume the slide show.
- During the automatic playback of still photos, you can press the < **INFO** > button to switch the display format ().
- During movie playback, you can adjust the sound volume by using the <  > <  > keys.
- During auto playback or when playback is paused, you can press the <  > <  > keys to view another image.
- During auto playback, auto power off will not take effect.
- The display time may differ depending on the image.

## Setting Image Search Conditions

---

You can filter image display according to your search conditions. After setting the image search conditions, you can play back and display only the found images. You can also protect, rate, play a slide show, erase, and apply other operations to filtered images.

---

1. Select [: Set image search conditions].

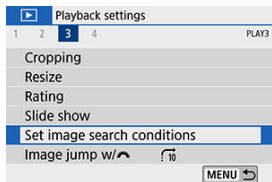

## 2. Set the search conditions.



(1)

- Use the <▲> <▼> keys to select an option.
- Set with the <◀> <▶> keys or the <INFO> button.
- A checkmark [✓] (1) is appended to the left of the item. (Specified as the search condition.)
- If you select the item and press the <INFO> button, the checkmark [✓] will be removed (which cancels the search condition.)

Item	Description
★ Rating	Displays images with the selected (rating) condition.
🕒 Date	Displays images taken on the selected shooting date.
📁 Folder	Displays images in the selected folder.
🔒 Protect	Displays images with the selected (protect) condition.
📁 Type of file	Displays images in the selected file type.

## 3. Apply the search conditions.

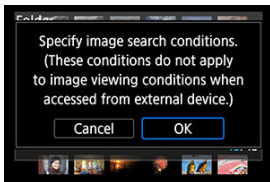

- Press <SET> and read the message displayed.
- Select [OK].  
The search condition is specified.

#### 4. Display the found images.



(2)

- Press the <  > button.  
Only the images that match the set conditions (filtered) will be played back.  
When the images are filtered for display, the screen will have an outer yellow frame (2).

## Clearing the Search Conditions

Access the screen in step 2, then press the <  > button to clear all the search conditions.

### Caution

- If no images match the search conditions, <  > cannot be pressed in step 3.

### Note

- Search conditions may be cleared if you perform power, card, or image editing operations.
- Auto power off time may be extended while the : **Set image search conditions** screen is displayed.



## Browsing Images with the Main Dial

In single-image display, you can turn the <  > dial to jump through the images forward or backward according to the jump method set.

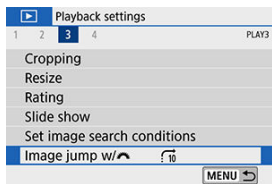

### 1. Select []: Image jump w/.

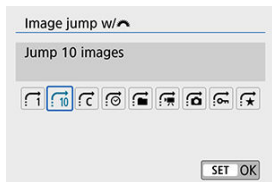

### 2. Select the jump method.



#### Note

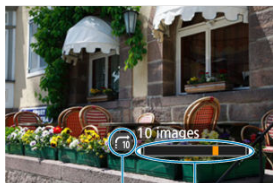

- With [**Jump images by the specified number**], you can turn the <  > dial to select the number of images to jump by.
- When you select [**Display by image rating**], turn the <  > dial to specify the rating (). If you browse images with [**★**] selected, all the rated images will be displayed.

### 3. Browse by jumping.







(1) Jump method

(2) Playback position

- Press the <  > button.
- In single-image display, turn the <  > dial.  
You can browse by the set method.

#### Note

- To search images by shooting date, select [: **Display by date**].
- To search images by folder, select [: **Display by folder**].
- To display either movies or still photos for cards that contain both, select [: **Display movies only**] or [: **Display stills only**].

# Histogram

---

The brightness histogram shows the exposure level distribution and overall brightness. The RGB histogram is for checking the color saturation and gradation.

---

1. Select [: Histogram disp].

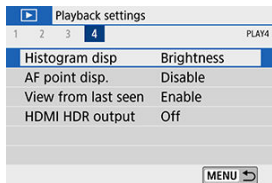

2. Select an item.

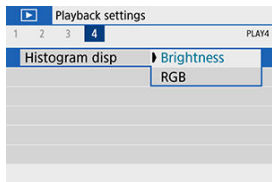

- **[Brightness] display**

This histogram is a graph showing the distribution of the image's brightness level. The horizontal axis indicates the brightness level (darker on the left and brighter on the right) while the vertical axis indicates how many pixels exist for each brightness level. The more pixels there are toward the left, the darker the image. The more pixels there are toward the right, the brighter the image. If there are too many pixels on the left, the shadow detail will be lost. If there are too many pixels on the right, the highlight detail will be lost. The gradation in-between will be reproduced. By checking the image and its brightness histogram, you can see the exposure level inclination and the overall gradation.

### Sample histograms



Dark image



Normal brightness



Bright image

- **[RGB] display**

This histogram is a graph showing the distribution of each primary color's brightness level in the image (RGB or red, green, and blue). The horizontal axis indicates the color's brightness level (darker on the left and brighter on the right), while the vertical axis indicates how many pixels exist for each color brightness level. The more pixels there are toward the left, the darker and less prominent the color. The more pixels there are toward the right, the brighter and denser the color. If there are too many pixels on the left, the respective color information will be lacking. If there are too many pixels on the right, the color will be too saturated with no gradation. By checking the image's RGB histogram, you can see the color's saturation and gradation condition, as well as white balance inclination.

# AF Point Display

---

You can display the AF points that were used to focus, which will be outlined in red on the playback screen. If automatic AF point selection is set, multiple AF points may be displayed.

1. Select [: AF point disp.].

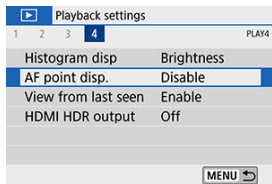

2. Select [Enable].

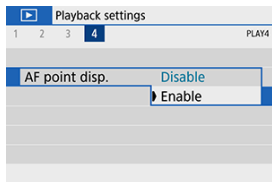

# Resuming from Previous Playback

---

## 1. Select [▶]: View from last seen.

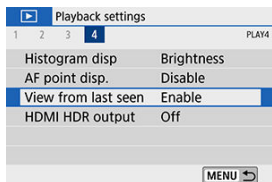

## 2. Select an item.

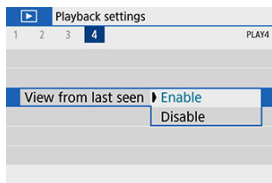

- **[Enable]:** Playback resumes from the last image displayed (except when you have just finished shooting).
- **[Disable]:** Playback resumes from your most recent shot whenever the camera is restarted.

# HDMI HDR Output

You can view RAW images in HDR by connecting the camera to an HDR TV.

## 1. Select [▶]: HDMI HDR output].

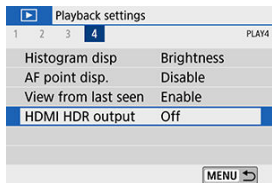

## 2. Select [On].

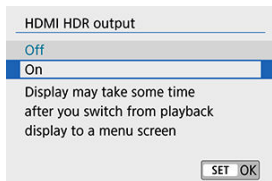

### ! Caution

- Image operations such as RAW processing are not available during HDR display.

### 📄 Note

- Make sure the HDR TV is set up for HDR input. For details on how to switch inputs on the TV, refer to the TV instruction manual.
- Depending on the TV used, images may not look as expected.
- Some image effects and information may not be displayed on an HDR TV.



## Wireless Features

---

This chapter describes how to connect the camera to a smartphone wirelessly via Bluetooth® or Wi-Fi® and send images to devices or Web services, how to control the camera from a computer or wireless remote control, and other operations.

### Caution

#### Important

- Note that Canon cannot be held liable for any loss or damage from erroneous wireless communication settings when using the camera. In addition, Canon cannot be held liable for any other loss or damage caused by use of the camera. When using wireless communication functions, establish appropriate security at your own risk and discretion. Canon cannot be held liable for any loss or damage caused by unauthorized access or other security breaches.

- [Tab Menus: Wireless Settings](#)
- [Wi-Fi/Bluetooth Connection](#)
- [Connecting to a Smartphone](#)
- [Connecting to a Computer via Wi-Fi](#)
- [Connecting to a Printer via Wi-Fi](#)
- [Sending Images to a Web Service](#)
- [Wi-Fi Connection via Access Points](#)
- [Connecting to a Wireless Remote Control](#)
- [Reconnecting via Wi-Fi](#)
- [Registering Multiple Connection Settings](#)
- [Wi-Fi Settings](#)
- [Bluetooth Settings](#)
- [Nickname](#)
- [GPS Device Settings](#)
- [Changing or Deleting Connection Settings](#)
- [Airplane Mode](#)
- [Clearing Wireless Communication Settings to Default](#)
- [View Info Screen](#)
- [Virtual Keyboard Operations](#)
- [Responding to Error Messages](#)
- [Wireless Communication Function Precautions](#)
- [Security](#)
- [Checking Network Settings](#)
- [Wireless Communication Status](#)

## Tab Menus: Wireless Settings

---

### Wireless Settings 1

---

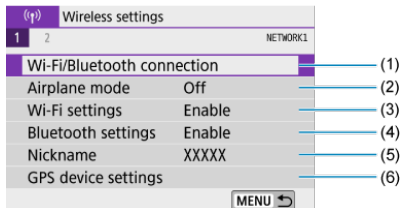

- (1) [Wi-Fi/Bluetooth connection](#)
- (2) [Airplane mode](#)
- (3) [Wi-Fi settings](#)
- (4) [Bluetooth settings](#)
- (5) [Nickname](#)
- (6) [GPS device settings](#)

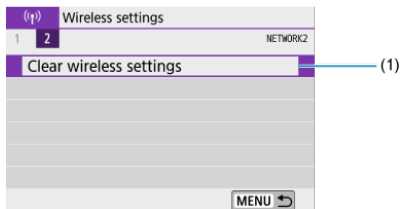

### Wireless Settings 2

---



- (1) [Clear wireless settings](#)

 Caution

- Wireless communication is not available while the camera is connected via an interface cable to a computer or other device.
- Other devices, such as computers, cannot be used with the camera by connecting them with an interface cable while the camera is connected to devices via Wi-Fi.
- The camera cannot be connected via Wi-Fi if there is no card in the camera (except for [  ]). Also, for [  ] and Web services, the camera cannot be connected via Wi-Fi if there are no images saved on the card.
- The Wi-Fi connection will be terminated if you set the camera's power to < OFF >, or open the card slot cover or battery compartment cover.
- With a Wi-Fi connection established, the camera's auto power off does not function.

# Wi-Fi/Bluetooth Connection

## 1. Select [(P): Wi-Fi/Bluetooth connection].

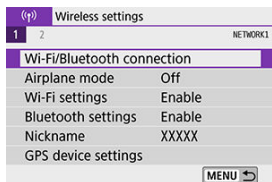

## 2. Select an item for the camera to connect to.



### Connecting to a Smartphone

Control the camera remotely and browse images on the camera over a Wi-Fi connection by using the dedicated Camera Connect app on smartphones or tablets (collectively referred to as “smartphones” in this manual).

### Use with EOS software or other dedicated software

Connect the camera to a computer via Wi-Fi and operate the camera remotely using EOS Utility (EOS software). With the dedicated application Image Transfer Utility 2, images on the camera can also be sent to a computer automatically.

### Printing from Wi-Fi printers

Connect the camera to a printer supporting PictBridge (Wireless LAN) via Wi-Fi to print images.

## **Sending images to a Web service [\(🔗\)](#)**

Send images directly from the camera to the image.canon cloud service for Canon customers after you complete member registration (free of charge). Original files of images sent to image.canon are retained for 30 days, without storage limitations, and can be downloaded to computers or transferred to other Web services.

## **Connecting to a wireless remote control [\(🔗\)](#)**

This camera can also be connected to Wireless Remote Control BR-E1 (sold separately) via Bluetooth for remote control shooting.

## Connecting to a Smartphone

---

- [Turning on Bluetooth and Wi-Fi on a Smartphone](#)
- [Installing Camera Connect on a Smartphone](#)
- [Connecting to a Bluetooth-compatible Smartphone via Wi-Fi](#)
- [Camera Connect Functions](#)
- [Maintaining a Wi-Fi Connection When the Camera Is Off](#)
- [Canceling the Pairing](#)
- [Wi-Fi Connection Without Using Bluetooth](#)
- [Automatic Image Transfer as You Shoot](#)
- [Sending Images to a Smartphone from the Camera](#)
- [Terminating Wi-Fi Connections](#)
- [Settings to Make Images Viewable from Smartphones](#)

You can do the following after pairing the camera with a smartphone compatible with Bluetooth low energy technology (hereafter, "Bluetooth").

- Establish a Wi-Fi connection using only the smartphone (🔗).
- Establish a Wi-Fi connection with the camera even when it is off (🔗).
- Geotag images with GPS information acquired by the smartphone (🔗).
- Control the camera remotely from a smartphone (🔗).

You can also do the following after connecting the camera to a smartphone via Wi-Fi.

- Browse and save images on the camera from a smartphone (🔗).
  - Control the camera remotely from a smartphone (🔗).
  - Send images to a smartphone from the camera (🔗).
-

## Turning on Bluetooth and Wi-Fi on a Smartphone

---

Turn on Bluetooth and Wi-Fi from the smartphone settings screen. Note that pairing with the camera is not possible from the smartphone's Bluetooth settings screen.



### Note

- To establish a Wi-Fi connection via an access point, see [Wi-Fi Connection via Access Points](#).

## Installing Camera Connect on a Smartphone

---

The dedicated app Camera Connect (free of charge) must be installed on the smartphone on which Android or iOS is installed.

- Use the latest version of the smartphone OS.
- Camera Connect can be installed from Google Play or App Store. Google Play or App Store can also be accessed using the QR codes that appear when the camera is paired or connected via Wi-Fi to a smartphone.



### Note

- For the operating system versions supported by Camera Connect, refer to the download site of Camera Connect.
- Sample screens and other details in this guide may not match the actual user interface elements after camera firmware updates or updates to Camera Connect, Android, or iOS.



# Connecting to a Bluetooth-compatible Smartphone via Wi-Fi

## Steps on the camera (1)

1. Select [(Ⓜ)]: Wi-Fi/Bluetooth connection].

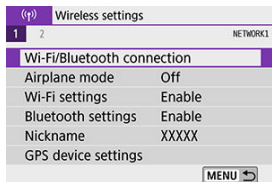

2. Select [☑ Connect to smartphone].



3. Select [Add a device to connect to].

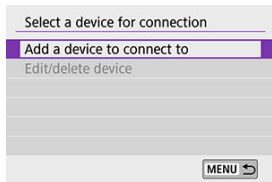

#### 4. Select an item.

Install Camera Connect on the smartphone. Display QR code for download site?

Do not display

Android

iOS

- If Camera Connect is already installed, select [**Do not display**].
- If Camera Connect is not installed, select [**Android**] or [**iOS**], scan the displayed QR code with the smartphone to access Google Play or App Store, and install Camera Connect.

## 5. Select [Pair via Bluetooth].



- Pairing now begins.

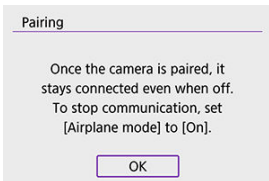

- Select [OK].

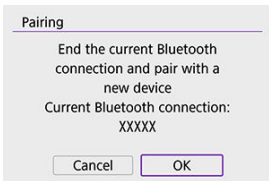

- To pair with a different smartphone after pairing with one initially, select [OK] on the screen shown above.

## Steps on the smartphone (1)

### 6. Start Camera Connect.



### 7. Tap the camera for pairing.

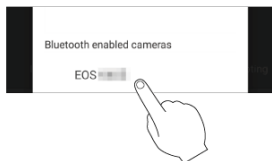

- If you are using an Android smartphone, go to step 9.

### 8. Tap [Pair] (iOS only).

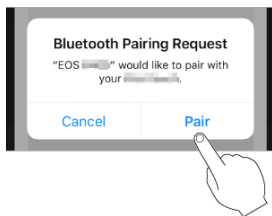

## Steps on the camera (2)

### 9. Select [OK].

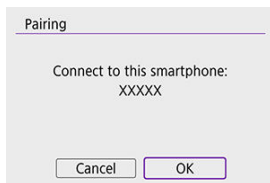

### 10. Press <SET>.

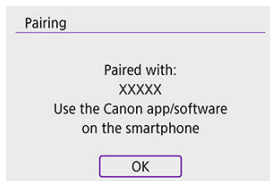

- Pairing is now complete, and the camera is connected to the smartphone via Bluetooth.

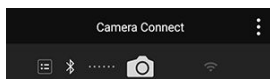

- A Bluetooth icon appears on the main Camera Connect screen.

### Caution

- The camera cannot be connected to two or more devices at the same time via Bluetooth. To switch to a different smartphone for the Bluetooth connection, see [Changing or Deleting Connection Settings](#).
- Bluetooth connection consumes battery power even after the camera's auto power off is activated. Therefore, the battery level may be low when you use the camera.

### Troubleshooting pairing

- Keeping pairing records for previously paired cameras on your smartphone will prevent it from pairing with this camera. Before you try pairing again, remove pairing records for previously paired cameras from your smartphone's Bluetooth settings screen.

### Note

- With a Bluetooth connection established, you can operate the camera to send images to the smartphone ().

## Steps on the smartphone (2)

### 11. Tap a Camera Connect function.

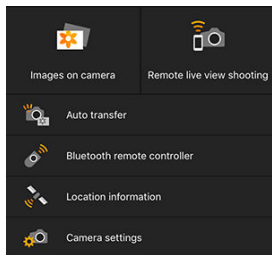

- In iOS, tap **[Join]** when a message is displayed to confirm camera connection.
- For the Camera Connect functions, see [Camera Connect Functions](#).
- When a Wi-Fi connection is established, the screen for the selected function will appear.

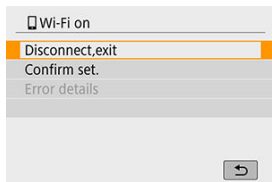

- **[Wi-Fi on]** is displayed on the camera.

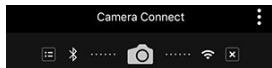

- The Bluetooth and Wi-Fi icons are lit on the main Camera Connect screen.

### The Wi-Fi connection to a Bluetooth-compatible smartphone is now complete.

- For how to terminate the Wi-Fi connection, see [Terminating Wi-Fi Connections](#).
- Terminating the Wi-Fi connection will switch the camera to the Bluetooth connection.
- To reconnect via Wi-Fi, start Camera Connect and tap the function you will use.

## **Wi-Fi on] screen**

### **Disconnect,exit**

- Terminates the Wi-Fi connection.

### **Confirm set.**

- You can check the settings.

### **Error details**

- When a Wi-Fi connection error occurs, you can check the details of the error.



### Images on camera

- Images can be browsed, deleted, or rated.
- Images can be saved on a smartphone.
- Effects can be applied to RAW images from a smartphone ([Creative Assist](#)).

### Remote live view shooting

- Enables remote shooting as you view a live image on the smartphone.

### Auto transfer

- Enables camera and app setting adjustment for automatic transfer of your shots ()

### Bluetooth remote controller

- Enables remote control of the camera from a smartphone paired via Bluetooth. (Not available when connected via Wi-Fi.)
- Auto power off is disabled while you are using the Bluetooth remote controller feature.

### Location information

- Not supported on this camera.

### Camera settings

- Camera settings can be changed.

## Maintaining a Wi-Fi Connection When the Camera Is Off

Even when the camera power switch is set to **<OFF>**, as long as it is paired to a smartphone via Bluetooth, you can use the smartphone to connect via Wi-Fi and browse images on the camera or perform other operations.

If you prefer not to connect via Wi-Fi to the camera when it is off, either set **[Airplane mode]** to **[On]** or set **[Bluetooth settings]** to **[Disable]**.

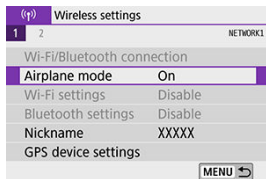

## Canceling the Pairing

Cancel pairing with a smartphone as follows.

1. Select [(p): Wi-Fi/Bluetooth connection].

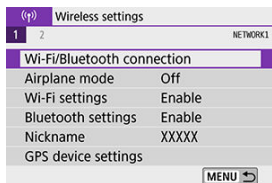

2. Select [☑ Connect to smartphone].



- If the history (☑) is displayed, switch the screen with the < ◀ ▶ > keys.

3. Select [Edit/delete device].

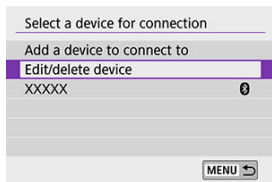

**4. Select the smartphone to cancel pairing with.**

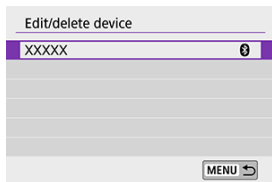

- Smartphones currently paired with the camera are labeled (0).

**5. Select [Delete connection information].**

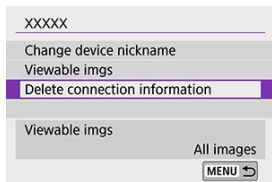

**6. Select [OK].**

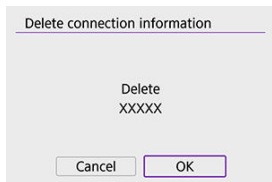

**7. Clear the camera information on the smartphone.**

- In the smartphone's Bluetooth setting menu, clear the camera information registered on the smartphone.

## Wi-Fi Connection Without Using Bluetooth

### Steps on the camera (1)

1. Select [(Ⓜ): Wi-Fi/Bluetooth connection].

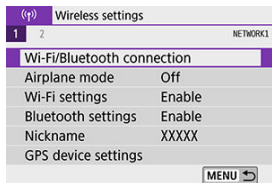

2. Select [☑ Connect to smartphone].



- If the history (Ⓜ) is displayed, switch the screen with the < << >> > keys.

3. Select [Add a device to connect to].

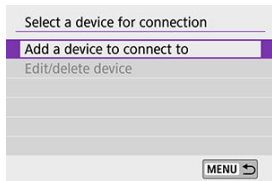

#### 4. Select an item.

Install Camera Connect on the smartphone. Display QR code for download site?

Do not display

Android

iOS

- If Camera Connect is already installed, select **[Do not display]**.

#### 5. Select **[Connect via Wi-Fi]**.

Connect to smartphone

Pair via Bluetooth

**Connect via Wi-Fi**

Establish a Wi-Fi connection, using the camera and smartphone

MENU ↩

SET OK

## 6. Check the SSID (network name) and password.

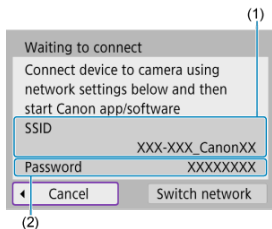

- Check the SSID (1) and Password (2) displayed on the camera screen.
- In **[Wi-Fi settings]**, if you set **[Password]** to **[None]**, the password will not be displayed or required (🔒).

### Note

- By selecting **[Switch network]** in step 6, you can establish a Wi-Fi connection via an access point (🔒).

## Steps on the smartphone

### 7. Operate the smartphone to establish a Wi-Fi connection.

Smartphone's screen (sample)

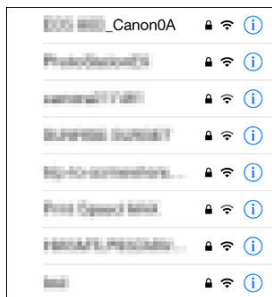

- Activate the smartphone's Wi-Fi function, then tap the SSID (network name) checked in step 6 in [Steps on the camera \(1\)](#).
- For the password, enter the password checked in step 6 in [Steps on the camera \(1\)](#).

### 8. Start Camera Connect and tap the camera to connect to via Wi-Fi.

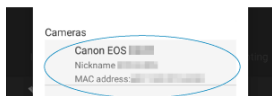



## Steps on the camera (2)

### 9. Select [OK].

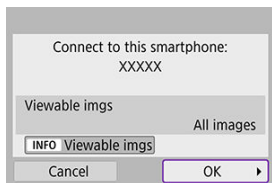

- To specify viewable images, press the <INFO> button. Configure as described in [Settings to Make Images Viewable from Smartphones](#), starting in step 5.

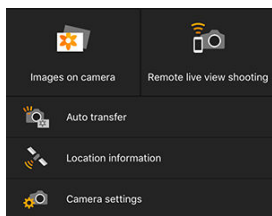

- The main window of Camera Connect will be displayed on the smartphone.

### The Wi-Fi connection to a smartphone is now complete.

- Operate the camera using Camera Connect (📷).
- For how to terminate the Wi-Fi connection, see [Terminating Wi-Fi Connections](#).
- To reconnect via Wi-Fi, see [Reconnecting via Wi-Fi](#).

#### Note

- When connected via Wi-Fi, you can send images to a smartphone from the Quick Control screen during playback (📷).

## Automatic Image Transfer as You Shoot

Your shots can be automatically sent to a smartphone. Before following these steps, make sure the camera and smartphone are connected via Wi-Fi.

### 1. Select [(Wi-Fi icon): Wi-Fi settings].

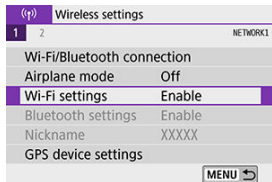

### 2. Select [Send to smartphone after shot].

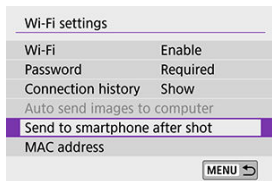

### 3. In [Auto send], select [Enable].

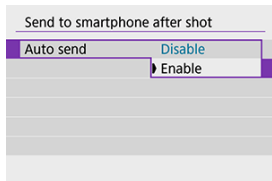

**4. Set [Size to send].**

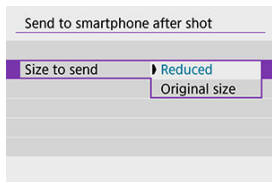

**5. Take the picture.**

## Sending Images to a Smartphone from the Camera

You can use the camera to send images to a smartphone paired via Bluetooth (Android devices only) or connected via Wi-Fi.

### 1. Switch to playback.



### 2. Press the < Q > button.

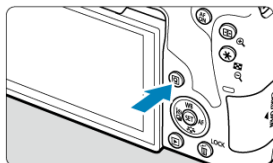

### 3. Select [☎ Send images to smartphone].

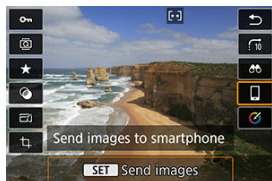

- If you perform this step while connected via Bluetooth, a message is displayed, and the connection switches to a Wi-Fi connection.

### 4. Select sending options and send the images.

## (1) Sending images individually

### 1. Select an image to send.



- Use the <◀▶> keys or <⦿> dial to select an image to send, then press <SET>.
- You can press the <📷🔍> button to select the image using the index display.

### 2. Select [Send img shown].

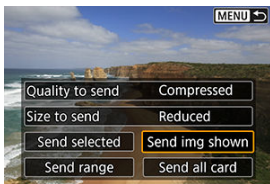

- In [Size to send], you can select the image sending size.
- When sending movies, you can select the image quality of movies to send in [Quality to send].

## (2) Sending multiple selected images

1. Press <SET>.



2. Select [Send selected].

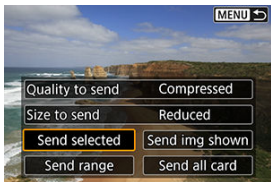

### 3. Select images to send.



- Use the <◀><▶> keys or <⦿> dial to select images to send, then press <SET>.

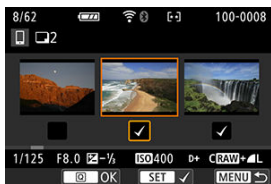

- You can press the <⦿> button to select the images from 3-image display. To return to the single-image display, press the <⦿> button.
- After selecting the images to send, press the <⦿> button.

#### 4. Select [Size to send].

Send images

Quantity to send 2 shots

Quality to send	Compressed
Size to send	Reduced

Cancel Send

- On the displayed screen, select an image size.

Size to send

Original size

Reduced

SET OK

- When sending movies, select the image quality in [Quality to send].

#### 5. Select [Send].

Send images

Quantity to send 2 shots

Quality to send	Compressed
Size to send	Reduced

Cancel Send



### (3) Sending a specified range of images

1. Press <SET>.



2. Select [Send range].

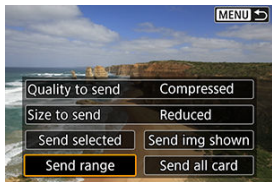

3. Specify the range of images.



- Select the first image (start point).
- Select the last image (end point).
- To cancel the selection, repeat this step.
- You can press the < [Grid Icon] > button to change the number of images shown in the index display.

#### 4. Confirm the range.

- Press the < **Q** > button.

#### 5. Select [Size to send].

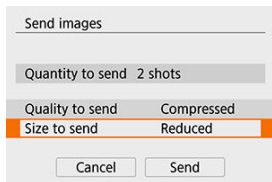

- On the displayed screen, select an image size.

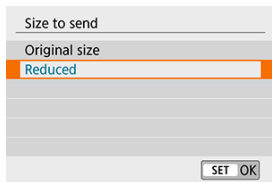

When sending movies, select the image quality in **[Quality to send]**.

#### 6. Select [Send].

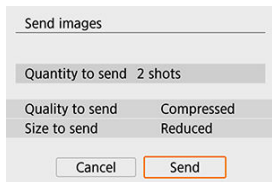

#### (4) Sending all images on the card

1. Press <SET>.



2. Select [Send all card].

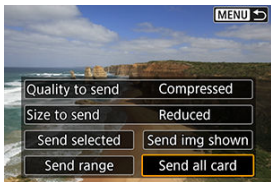

### 3. Select [Size to send].

Send images

Quantity to send 15 shots

Quality to send Compressed

Size to send Reduced

Cancel Send

- On the displayed screen, select an image size.

Size to send

Original size

Reduced

SET OK

- When sending movies, select the image quality in [Quality to send].

### 4. Select [Send].

Send images

Quantity to send 15 shots

Quality to send Compressed

Size to send Reduced

Cancel Send

## (5) Sending images that match the search conditions

Send all the images that match the search conditions set in [Set image search conditions] at once. For [Set image search conditions], refer to [Setting Image Search Conditions](#).

1. Press <SET>.



2. Select [Send all found].

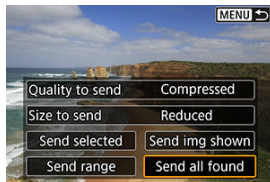

### 3. Select [Size to send].

Send images

Quantity to send 15 shots

Quality to send	Compressed
Size to send	Reduced

Cancel Send

- On the displayed screen, select an image size.

Size to send

Original size

Reduced

SET OK

- When sending movies, select the image quality in [Quality to send].

### 4. Select [Send].

Send images

Quantity to send 15 shots

Quality to send	Compressed
Size to send	Reduced

Cancel Send

## Ending image transfer

### Sending images from the camera when paired via Bluetooth (Android)



- Press the < MENU > button on the image transfer screen.

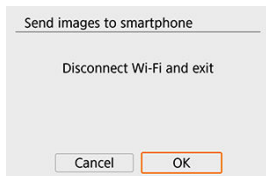

- Select [OK] to end image transfer and the Wi-Fi connection.

### Sending images from the camera over a Wi-Fi connection



- Press the < MENU > button on the image transfer screen.
- To terminate the Wi-Fi connection, see [Terminating Wi-Fi Connections](#).

#### Caution

- During the image transfer operation, a picture cannot be taken even if the camera's shutter button is pressed.

 **Note**

- You can cancel the image transfer by selecting **[Cancel]** during the transfer.
- You can select up to 999 files at a time.
- With a Wi-Fi connection established, disabling the smartphone's power saving function is recommended.
- Selecting the reduced size for still photos applies to all still photos sent at that time. Note that **S2** size still photos are not reduced.
- Selecting compression for movies applies to all movies sent at that time. Note that the camera does not reduce movies with a frame rate of **FHD 29.97P [IPB]** or **FHD 25.00P [IPB]**.
- When you use a battery to power the camera, make sure it is fully charged.



## Terminating Wi-Fi Connections

Perform either of the following operations.

On the Camera Connect screen, tap [X].

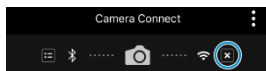

On the [Wi-Fi on] screen, select [Disconnect,exit].

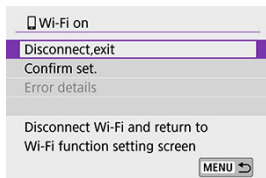

- If the [Wi-Fi on] screen is not displayed, select [(⌂): Wi-Fi/Bluetooth connection].
- Select [Disconnect,exit], then select [OK] on the confirmation screen.

## Settings to Make Images Viewable from Smartphones

Images can be specified after the Wi-Fi connection is terminated.

### 1. Select [(p)]: Wi-Fi/Bluetooth connection].

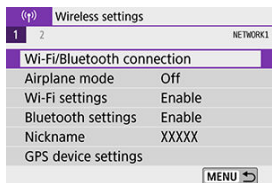

### 2. Select [☐] Connect to smartphone].

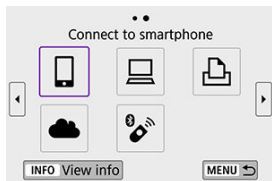

- If the history (p) is displayed, switch the screen with the < > < > keys.

### 3. Select [Edit/delete device].

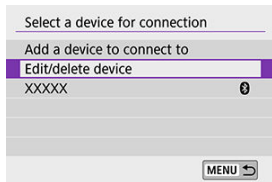

#### 4. Select a smartphone.

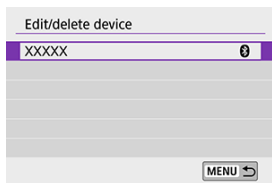

- Select the name of the smartphone on which you want to make the images viewable.

#### 5. Select [Viewable imgs].

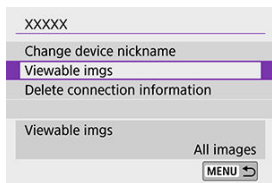

## 6. Select an item.

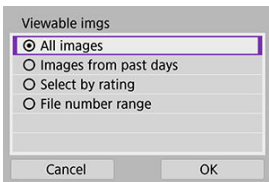

- Select **[OK]** to access the setting screen.

### **[All images]**

- All images stored on the card become viewable.

### **[Images from past days]**

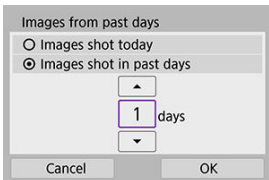

- Specify viewable images on the shooting-date basis. Images shot up to nine days ago can be specified.
- When **[Images shot in past days]** is selected, images shot up to the specified number of days before the current date become viewable. Use the **<▲>** **<▼>** keys to specify the number of days, then press **<SET>** to confirm the selection.
- Once you select **[OK]**, the viewable images are set.

### **! Caution**

- If **[Viewable imgs]** is set to any setting other than **[All images]**, remote shooting is not possible.

### [Select by rating]

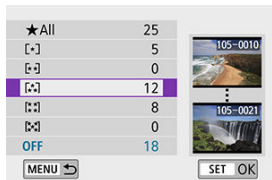

- Specify viewable images depending on whether a rating is appended (or not appended) or by the type of rating.
- Once you select the type of rating, the viewable images are set.

### [File number range] (Select range)

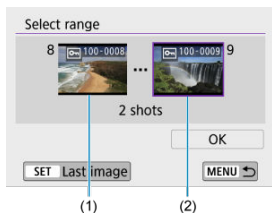

- Select the first and last images from images arranged by the file number to specify the viewable images.
  1. Press  $\langle \text{SET} \rangle$  to display the image selection screen. Use the  $\langle \blacktriangleleft \rangle$   $\langle \blacktriangleright \rangle$  keys or  $\langle \odot \rangle$  dial to select images.  
You can press the  $\langle \text{CHECK} \rangle$  button to select the images using the index display.
  2. Select an image as the starting point (1).
  3. Use the  $\langle \blacktriangleright \rangle$  dial to select an image as the ending point (2).
  4. Select [OK].

 **Caution**

- Movie recording continues if the camera is disconnected from Wi-Fi during remote movie recording.
- With a Wi-Fi connection to a smartphone established, certain functions are unavailable.
- In remote shooting, the AF speed may become slower.
- Depending on the communication status, image display or shutter release timing may be delayed.
- When saving images to a smartphone, you cannot take a picture even if you press the camera's shutter button. Also, the camera screen may turn off.

 **Note**

- With a Wi-Fi connection established, disabling the smartphone's power saving function is recommended.

## Connecting to a Computer via Wi-Fi

---

 [Operating the Camera Using EOS Utility](#)

 [Sending Images on the Camera Automatically](#)

This section describes how to connect the camera to a computer via Wi-Fi and perform camera operations using EOS software or other dedicated software. Install the latest version of software on the computer before setting up a Wi-Fi connection.

For computer operating instructions, refer to the computer user manual.

---

### Operating the Camera Using EOS Utility

---

Using EOS Utility (EOS software), you can import images from the camera, control the camera, and perform other operations.

#### Steps on the camera (1)

1. Select []: **Wi-Fi/Bluetooth connection**].

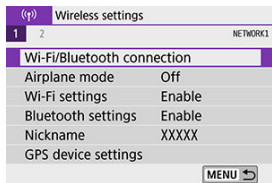

2. Select [ Remote control (EOS Utility)].

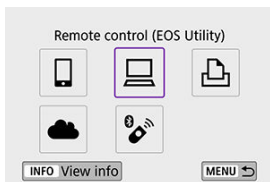

- If the history () is displayed, switch the screen with the < ◀ ▶ > keys.

3. Select [**Add a device to connect to**].

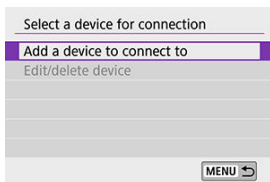

4. Check the SSID (network name) and password.

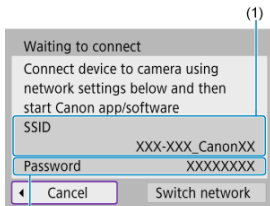

- Check the SSID (1) and Password (2) displayed on the camera screen.
- In [**Wi-Fi settings**], if you set [**Password**] to [**None**], the password will not be displayed or required. For details, see [Wi-Fi Settings](#).



## Steps on the computer (1)

### 5. Select the SSID, then enter the password.

#### Computer's screen (sample)

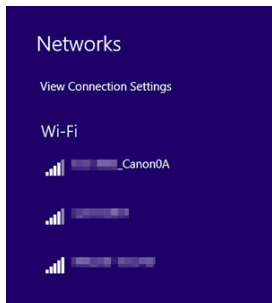

- On the computer's network setting screen, select the SSID checked in step 4 in [Steps on the camera \(1\)](#).
- For the password, enter the password checked in step 4 in [Steps on the camera \(1\)](#).

## Steps on the camera (2)

### 6. Select [OK].

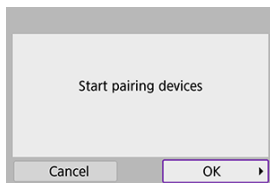

- The following message is displayed. "\*\*\*\*\*" represents the last six digits of the MAC address of the camera to be connected.

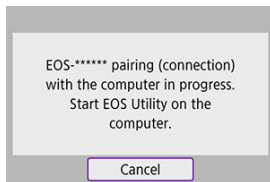

## Steps on the computer (2)

7. Start EOS Utility.

8. In EOS Utility, click [Pairing over Wi-Fi/LAN].

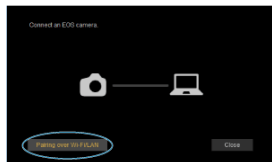

- If a firewall-related message is displayed, select [Yes].

9. Click [Connect].

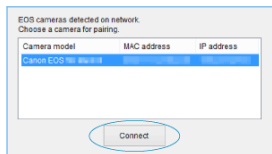

- Select the camera to connect to, then click [Connect].

## Steps on the camera (3)

### 10. Establish a Wi-Fi connection.

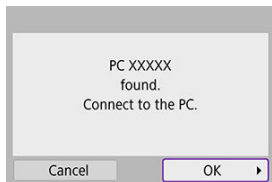

- Select **[OK]**.

## [Wi-Fi on] screen

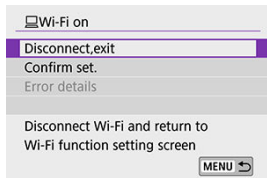

### Disconnect,exit

- Terminates the Wi-Fi connection.

### Confirm set.

- You can check the settings.

### Error details

- When a Wi-Fi connection error occurs, you can check the details of the error.

### The Wi-Fi connection to a computer is now complete.

- Operate the camera using EOS Utility on the computer.
- To reconnect via Wi-Fi, see [Reconnecting via Wi-Fi](#).

### Caution

- If the Wi-Fi connection is terminated while recording a movie with remote shooting, the following will occur.
  - Power switch set to < >: recording continues
  - Power switch set to < ON >: recording stops
- The camera cannot be controlled directly in shooting when it has been switched to movie recording mode via EOS Utility with the power switch set to < ON >.
- With a Wi-Fi connection to EOS Utility established, certain functions are unavailable.
- In remote shooting, the AF speed may become slower.
- Depending on the communication status, image display or shutter release timing may be delayed.
- In Remote Live View shooting, the rate of image transmission is slower compared to a connection via an interface cable. Therefore, moving subjects cannot be displayed smoothly.

## Sending Images on the Camera Automatically

With the dedicated software Image Transfer Utility 2, you can send images on the camera to a computer automatically.

### Steps on the computer (1)

#### 1. Connect the computer and access point and start Image Transfer Utility 2.

- The screen to set up pairing is shown when you follow the instructions displayed the first time Image Transfer Utility 2 starts up.

### Steps on the camera (1)

#### 2. Select [Auto send images to computer].

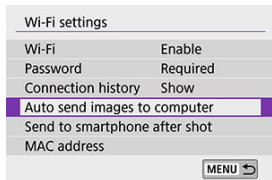

- Select [(Wi-Fi icon): **Wi-Fi settings**].
- Select [**Auto send images to computer**].

#### 3. In [Auto send], select [Enable].

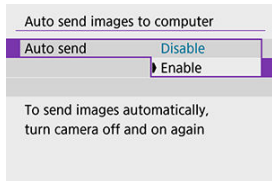

4. Select [OK].

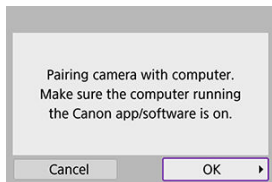

5. Connect to an access point via Wi-Fi.

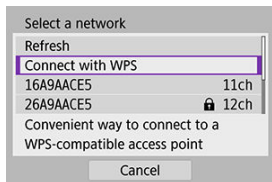

- Establish a Wi-Fi connection between the camera and the access point connected to the computer. For connection instructions, see [Wi-Fi Connection via Access Points](#).

6. Select the computer to pair the camera with.

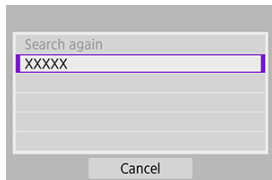

## Steps on the computer (2)

### 7. Pair the camera and computer.

- Select the camera, then click [Pairing].

## Steps on the camera (2)

### 8. Select [Auto send images to computer].

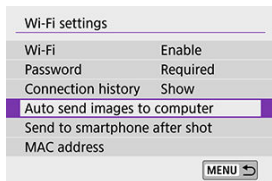

- Select [(ⓘ): Wi-Fi settings].
- Select [Auto send images to computer].

### 9. Select [Image sending options].

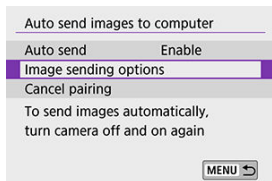



## 10. Select what to send.

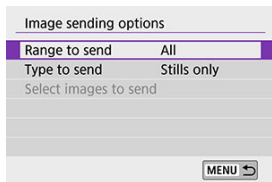

- If you select **[Selected imgs]** in **[Range to send]**, specify the images to send on the **[Select images to send]** screen.
- After the settings are complete, turn the camera off.

Images on the camera are automatically sent to the active computer when you turn the camera on within range of the access point.

### Caution

- If images are not sent automatically, try restarting the camera.

# Connecting to a Printer via Wi-Fi

---

 [Image Printing](#)

 [Print Settings](#)

This section describes how to print images by directly connecting the camera to a printer supporting PictBridge (Wireless LAN) via Wi-Fi. For printer operating instructions, refer to the printer user manual.

---

## 1. Select []: Wi-Fi/Bluetooth connection].

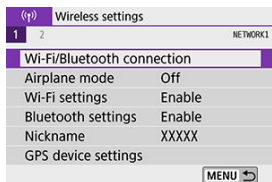

## 2. Select [] Print from Wi-Fi printer].

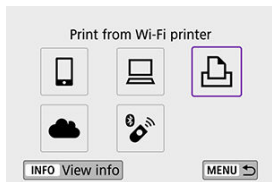

- If the history () is displayed, switch the screen with the < ◀ ▶ > keys.

### 3. Select [Add a device to connect to].

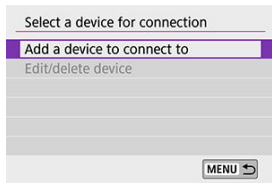

### 4. Check the SSID (network name) and password.

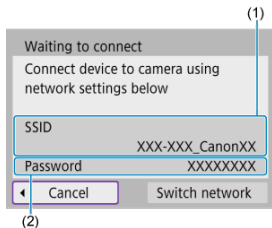

- Check the SSID (1) and Password (2) displayed on the camera screen.
- In **[Wi-Fi settings]**, if you set **[Password]** to **[None]**, the password will not be displayed or required (🔒).

### 5. Set up the printer.

- In the Wi-Fi settings menu of the printer to be used, select the SSID you have checked.
- For the password, enter the password checked in step 4.

## 6. Select the printer.

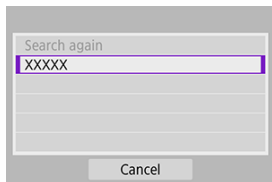

- In the list of detected printers, select the printer to connect to via Wi-Fi.
- If your preferred printer is not listed, selecting [**Search again**] may enable the camera to find and display it.



### Note

- To establish a Wi-Fi connection via an access point, see [Wi-Fi Connection via Access Points](#).

### Printing images individually

#### 1. Select the image to be printed.



- Use the <◀> <▶> keys or <⊙> dial to select an image to print, then press <SET>.
- You can press the <⊠> button to select the image using the index display.

#### 2. Select [Print image].



### 3. Print the image.

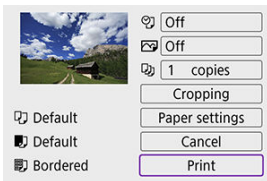

- For the print setting procedures, see [Print Settings](#).
- Select [**P**rint], then [**O**K] to start printing.

## Printing according to specified image options

1. Press < **SET** >.



2. Select [Print order].



3. Set the printing options.

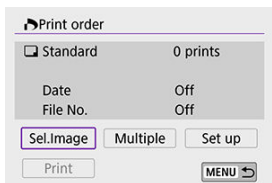

- For the print setting procedures, see [Print Ordering \(DPOF\)](#).
- If the print order is complete before establishing a Wi-Fi connection, go to step 4.

#### 4. Select [Print].

- [Print] can be selected only when an image is selected and the printer is ready to print.

#### 5. Set the [Paper settings] (📄).

#### 6. Print the image.

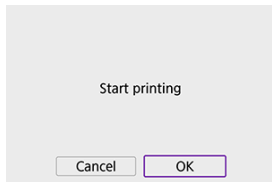

- When [OK] is selected, printing starts.

#### ⚠ Caution

- Shooting is not possible while connected to a printer via Wi-Fi.
- Movies cannot be printed.
- Before printing, be sure to set the paper size.
- Certain printers may not be able to imprint the file number.
- If [Bordered] is set, certain printers may imprint the date on the border.
- Depending on the printer, the date may appear faint if it is imprinted on a bright background or on the border.
- RAW images cannot be printed by selecting [Print order]. When printing, select [Print image] and print.





## Note

- When you use a battery to power the camera, make sure it is fully charged.
- Depending on the image's file size and image quality, it may take some time to start printing after you select [**Print**].
- To stop printing, press <  > while [**Cancel**] is displayed, then select [**OK**].
- When printing with [**Print order**], if you stopped printing and want to resume printing of the remaining images, select [**Resume**]. Note that printing will not resume if any of the following occurs.
  - You change the print order or delete any of the print ordered images before resuming printing.
  - When index is set, you change the paper setting before resuming printing.
- If a problem occurs during printing, see [Notes](#).

## Print Settings

The screen display and setting options vary depending on the printer. Also, certain settings may not be available. For details, refer to the printer's instruction manual.

### Print settings screen

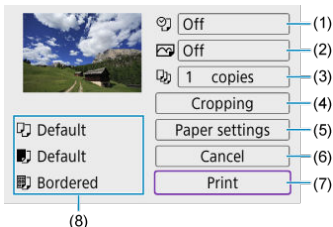

- (1) Sets date or file number printing (☑).
- (2) Sets the printing effects (☑).
- (3) Sets the number of copies to print (☑).
- (4) Sets the print area (☑).
- (5) Sets the paper size, type, and layout (☑, ☑, ☑).
- (6) Returns to the image selection screen.
- (7) Starts the printing.
- (8) The paper size, type, and layout you have set are displayed.

\* Depending on the printer, certain settings may not be selectable.

## Paper settings

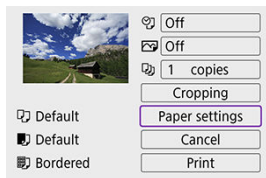

- Select [**Paper settings**].

## [] Setting the paper size

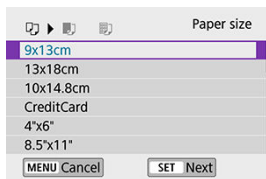

- Select the size of the paper in the printer.

## Setting the paper type

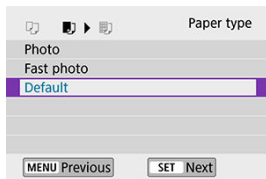

- Select the type of the paper in the printer.

## Setting the page layout

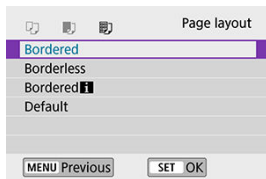



- Select the page layout.

### Caution

- If the image's aspect ratio is different from the printing paper's aspect ratio, the image may be cropped significantly when you print it as a borderless print. Images may also be printed at lower resolution.

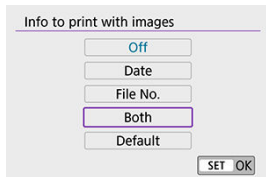
## Setting printing of the date/file number



- Select .
- Select what to print.

## Setting the printing effects (Image optimization)

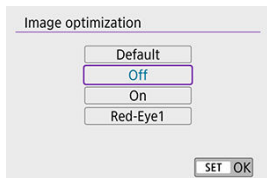

- Select .
- Select printing effects.

### Caution

- If you imprint shooting information on an image shot at an expanded ISO speed (**H**), the correct ISO speed may not be imprinted.
- The **[Default]** setting for printing effects and other options are the printer's own default settings as set by the printer's manufacturer. Refer to the printer's instruction manual to find out what the **[Default]** settings are.

## Setting the number of copies



- Select .
- Select the number of copies to print.

## Cropping the image

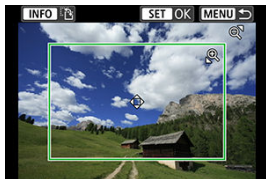

**Set cropping immediately before printing.** Changing other print settings after you crop images may require you to crop the images again.







1. On the print setting screen, select [Cropping].
2. Set the cropping frame size, position, and aspect ratio.

- The image area within the cropping frame will be printed. The shape of the frame (aspect ratio) can be changed with [Paper settings].

### Resizing the cropping frame size

Use the <  > or <   > button to resize the cropping frame.

### Moving the cropping frame

Use the <  > <  > <  > <  > keys to move the frame vertically or horizontally.

### Switching the orientation of the cropping frame

Pressing the < **INFO** > button will toggle the cropping frame between the vertical and horizontal orientations.

3. Press <  > to exit the cropping.

- You can check the cropped image area in the upper left of the print setting screen.

## Caution

- Depending on the printer, the cropped image area may not be printed as you specified.
- The smaller the cropping frame, the lower the resolution at which images are printed.

## Note

### Handling printer errors

- If printing does not resume after you resolve a printer error (no ink, no paper, etc.) and select [**Continue**], operate the buttons on the printer. For details on resuming printing, refer to the printer's instruction manual.

### Error messages

- If a problem occurs during printing, an error message will appear on the camera screen. After fixing the problem, resume printing. For details on how to fix a printing problem, refer to the printer's instruction manual.

### Paper error

- Confirm that paper is loaded correctly.

### Ink error

- Check the printer's ink level and the waste ink tank.

### Hardware error

- Check for any printer problems other than paper and ink problems.

### File error

- The selected image cannot be printed. Images taken with a different camera or images edited with a computer may not be printable.

# Sending Images to a Web Service

---

☑ [Registering image.canon](#)

☑ [Sending Images](#)

This section describes how to send images to image.canon.

---

## Registering image.canon

---

Link the camera to image.canon to send images directly from the camera.

- A computer or smartphone with a browser and internet connection is required.
- You will need to enter an email address used on your computer or smartphone.
- For instructions on using image.canon services and details on countries and regions of availability, visit the site (<https://image.canon/>).
- Separate ISP connection and access point fees may apply.

### Steps on the camera (1)

1. Select [(?): Wi-Fi/Bluetooth connection].

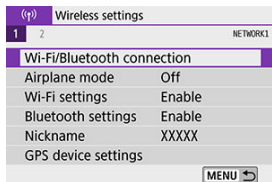

2. Select [(☁️) Upload to Web service].

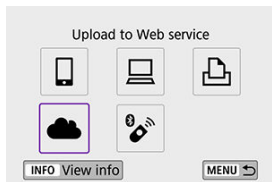



### 3. Select [I Agree].

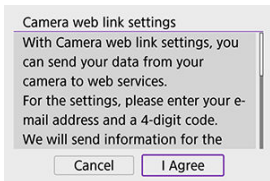

### 4. Establish a Wi-Fi connection.

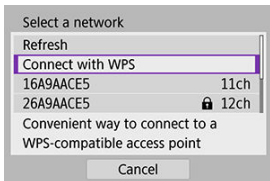

- Connect to an access point via Wi-Fi. Go to step 6 in [Wi-Fi Connection via Access Points](#).

### 5. Enter your email address.

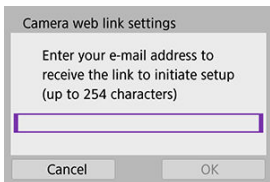

- Enter your email address, then select [OK].

## 6. Enter a four-digit number.

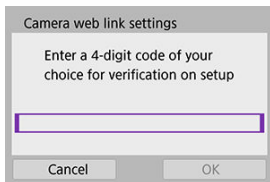

- Enter a four-digit number of your choice, then select **[OK]**.

## 7. Select **[OK]**.

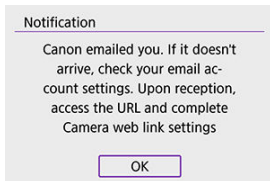

- The [☁️] icon changes to [☁️➡️].

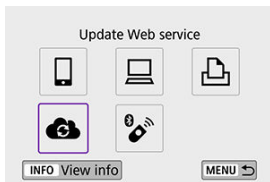

## Steps on the computer or smartphone

### 8. Set up camera web link.

- Access the page in the notification message.
- Follow the instructions to complete the settings on the camera web link settings page.

## Steps on the camera (2)

### 9. Add "image.canon" as a destination.

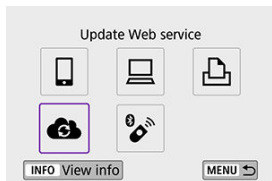

- Select [Cloud].  
image.canon is now added.

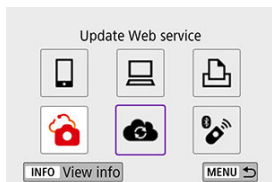

## Sending Images

Images can be sent to image.canon. Original files of images sent to image.canon are retained for 30 days, without storage limitations, and can be downloaded to computers or transferred to other Web services.

### Connecting to image.canon via Wi-Fi

1. Select [(i)]: Wi-Fi/Bluetooth connection].

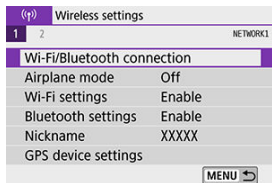

2. Select image.canon.

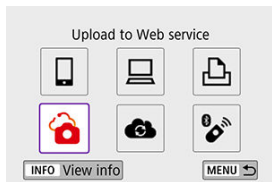

- If the history [(i)] is displayed, switch the screen with the < ◀ ▶ > keys.

## Sending images individually

### 1. Select an image to send.



- Use the <◀>>▶> keys or <⦿> dial to select an image to send, then press <SET>.
- You can press the <☒·Q> button to select the image using the index display.

### 2. Select [Send img shown].



- In [**Size to send**], you can select the image sending size.
- On the screen after images are sent, select [**OK**] to end the Wi-Fi connection.

## Sending multiple selected images

1. Press < **SET** >.



2. Select [Send selected].



3. Select images to send.



- Use the < ◀ > < ▶ > keys or < **SET** > dial to select an image to send, then press < **SET** >.
- You can press the < **Q** > button to select the image from 3-image display. To return to the single-image display, press the < **Q** > button.
- After selecting the images to send, press the < **Q** > button.

#### 4. Select [Size to send].

Send images

Quantity to send 2 shots

Size to send Reduced

Cancel Send

- On the displayed screen, select an image size.

Size to send

Original size

Reduced

SET OK

#### 5. Select [Send].

Send images

Quantity to send 2 shots

Size to send Reduced

Cancel Send

- On the screen after images are sent, select **[OK]** to end the Wi-Fi connection.



## Sending a specified range of images

Specify the range of images to send all the images in the range at once.

1. Press <  >.



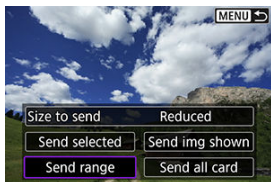

2. Select [Send range].

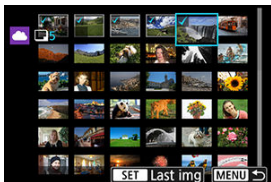

3. Specify the range of images.



- Select the first image (start point).
- Select the last image (end point).  
Images will be selected and [✓] will appear.
- To cancel the selection, repeat this step.
- You can press the <   > button to change the number of images shown in the index display.

#### 4. Confirm the range.

- Press the < **Q** > button.

#### 5. Select [Size to send].

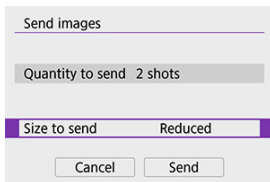

Send images

Quantity to send 2 shots

Size to send Reduced

Cancel Send

- On the displayed screen, select an image size.

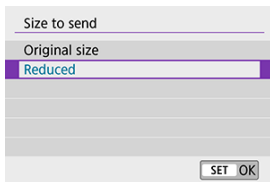

Size to send

Original size

Reduced

SET OK

#### 6. Select [Send].

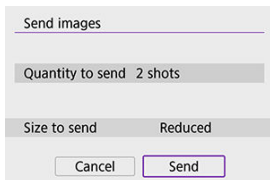

Send images

Quantity to send 2 shots

Size to send Reduced

Cancel Send

- On the screen after images are sent, select **[OK]** to end the Wi-Fi connection.

## Sending all images on the card

1. Press < SET >.



2. Select [Send all card].

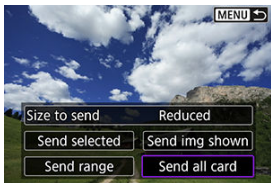

### 3. Select [Size to send].

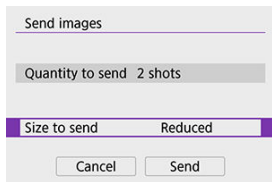

- On the displayed screen, select an image size.

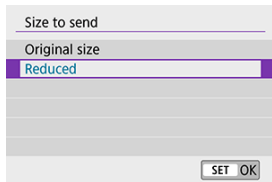

### 4. Select [Send].

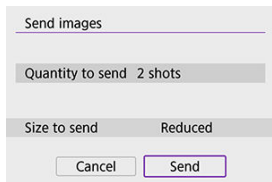

- On the screen after images are sent, select [OK] to end the Wi-Fi connection.

## Sending images that match the search conditions

Send all the images that match the search conditions set in [Set image search conditions] at once. For [Set image search conditions], refer to [Setting Image Search Conditions](#).

1. Press <SET>.



2. Select [Send all found].



### 3. Select [Size to send].

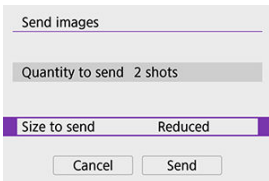

- On the displayed screen, select an image size.

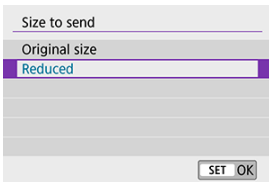

### 4. Select [Send].

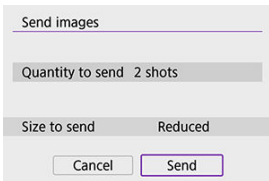

- On the screen after images are sent, select **[OK]** to end the Wi-Fi connection.

#### Caution

- Shooting is not possible when connected via Wi-Fi to image.canon, even if you press the camera's shutter button.



#### Note

- Certain images may not be able to be sent with **[Send range]**, **[Send all card]**, or **[Send all found]**.
- When you reduce the image size, all images to be sent at the same time are resized. Note that movies or **S2** size still photos are not reduced.
- **[Reduced]** is enabled only for still photos shot with cameras of the same model as this camera. Still photos shot with other models are sent without resizing.
- A record of sent images can be checked when you access [image.canon](http://image.canon).
- When you use a battery to power the camera, make sure it is fully charged.

# Wi-Fi Connection via Access Points

[☑ Camera Access Point Mode](#)

[☑ Manual IP Address Setup](#)

This section describes how to join a Wi-Fi network via an access point compatible with WPS (PBC mode).

First, check the position of the WPS button and how long to press it. It may take approx. one minute to establish a Wi-Fi connection.

---

## 1. Select [(W): Wi-Fi/Bluetooth connection].

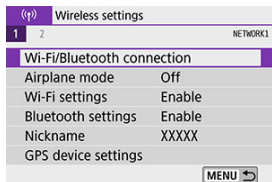

## 2. Select an item.

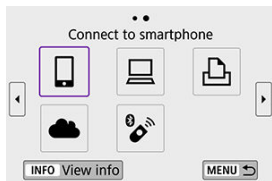

- If the history (W) is displayed, switch the screen with the < ◀ ▶ ▶ > keys.



### 3. Select [Add a device to connect to].

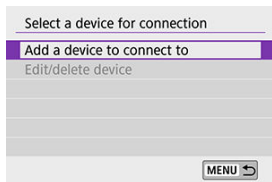

- The following message is displayed if you have selected **[Connect to smartphone]**. If Camera Connect is already installed, select **[Do not display]**.

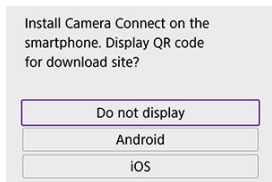

- On the **[Connect to smartphone]** screen displayed next, select **[Connect via Wi-Fi]**.

### 4. Select [Switch network].

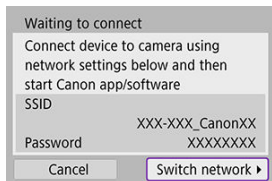

- Displayed when **[Wi-Fi]**, **[Bluetooth]**, or **[USB]** is selected.

## 5. Select [Connect with WPS].

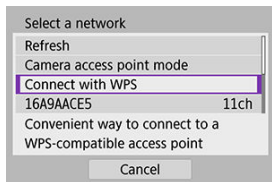

### Note

- For [Camera access point mode] displayed in step 5, see [Camera Access Point Mode](#).

## 6. Select [WPS (PBC mode)].

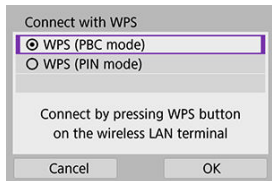

- Select [OK].

## 7. Connect to the access point via Wi-Fi.

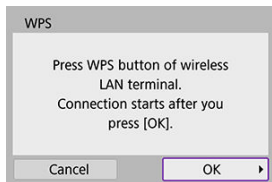

- Press the access point's WPS button.
- Select **[OK]**.

## 8. Select **[Auto setting]**.

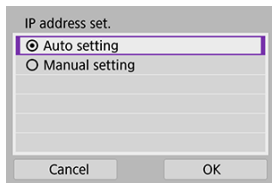

- Select **[OK]** to access the setting screen for the Wi-Fi function.
- If an error occurs with **[Auto setting]**, see [Manual IP Address Setup](#).

## 9. Specify the settings for the Wi-Fi function.

### [📱 Connect to smartphone]

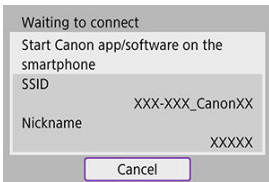

- On the smartphone's Wi-Fi setting screen, tap the SSID (network name) shown on the camera, then enter the password of the access point for the connection.

Go to step 8 in [Wi-Fi Connection Without Using Bluetooth](#).

### [🖨️ Remote control (EOS Utility)]

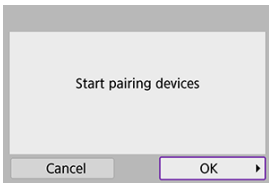

Go to step 7 or 8 in [Steps on the computer \(2\)](#).

### [🖨️ Print from Wi-Fi printer]

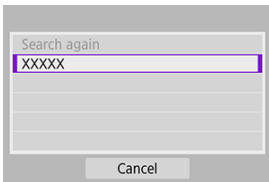

Go to step 6 in [Connecting to a Printer via Wi-Fi](#).

### Registering image.canon

Go to step 5 in [Registering image.canon](#).

## Camera Access Point Mode

---

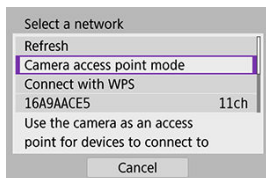

Camera access point mode is a connection mode for connecting the camera directly to each device via Wi-Fi. Displayed when [📺], [🖨️], or [📄] is selected after [(📶): **Wi-Fi/Bluetooth connection**].

## Manual IP Address Setup

The items displayed vary depending on the Wi-Fi function.

### 1. Select [Manual setting].

IP address set.

Auto setting

Manual setting

Cancel OK

- Select [OK].

### 2. Select an item.

IP address set.

IP address	192.168.1.2
Subnet mask	255.255.255.0
Gateway	Disable

Cancel OK

- Select an item to access the screen for numerical input.
- To use a gateway, select [Enable], then select [Address].

Gateway

Enable

Disable

Address

0.0.0.0

Cancel OK

### 3. Enter the desired values.







IP address

192 . 168 . 1 . 3

0 1 2 3 4 5 6 7 8 9

INFO Cancel MENU OK

- Turn the  dial to move the input position in the upper area, and use the   keys to select numbers to enter. Press  to enter the selected number.
- To set the entered numbers and return to the screen for step 2, press the **MENU** button.

### 4. Select [OK].

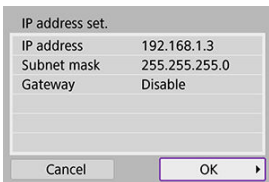

IP address set.

IP address	192.168.1.3
Subnet mask	255.255.255.0
Gateway	Disable

Cancel OK

- When you have completed setting the necessary items, select **[OK]**.
- If you are not sure what to enter, see [Checking Network Settings](#), or ask the network administrator or another person knowledgeable about the network.

## Connecting to a Wireless Remote Control

This camera can also be connected to Wireless Remote Control BR-E1 (sold separately, ) via Bluetooth for remote control shooting.

1. Select []: **Wi-Fi/Bluetooth connection**].

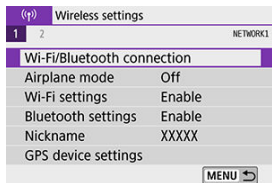

2. Select [] **Connect to Wireless Remote**].

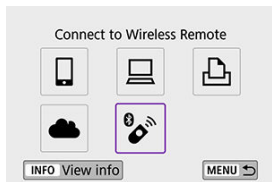

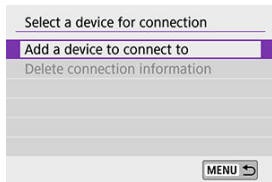

3. Select [**Add a device to connect to**].





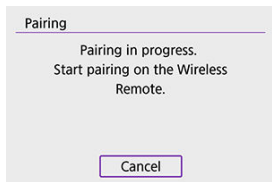



## 4. Pair the devices.



- When the [**Pairing**] screen appears, press and hold the <W> and <T> buttons on the BR-E1 simultaneously for at least 3 sec.
- After a message confirms that the camera is paired with the BR-E1, press <  >.

## 5. Set up the camera for remote shooting.

- When shooting still photos, select [] or [] as the drive mode ().
- When recording movies, set [: **Remote control**] to [**Enable**].
- For instructions after the pairing is complete, refer to the BR-E1's Instruction Manual.

### Caution

- Bluetooth connections consume battery power even after the camera's auto power off is activated.

### Note

- When you will not use Bluetooth, setting this function to [**Disable**] in step 1 is recommended.

## Canceling the Pairing

Before pairing with a different BR-E1, clear the information about the connected remote control.

1. Select [**Wi-Fi/Bluetooth connection**].

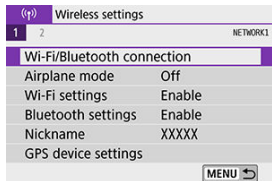

2. Select [**Connect to Wireless Remote**].

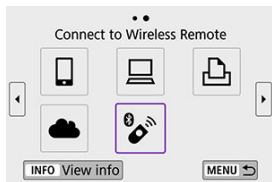

3. Select [**Delete connection information**].

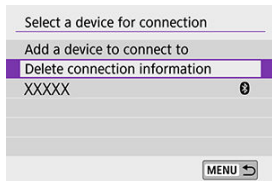

#### 4. Select [OK].

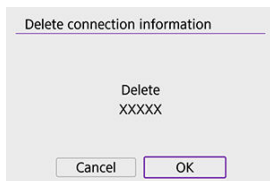

# Reconnecting via Wi-Fi

Follow these steps to reconnect to devices or Web services with registered connection settings.

## 1. Select [(Ⓜ): Wi-Fi/Bluetooth connection].

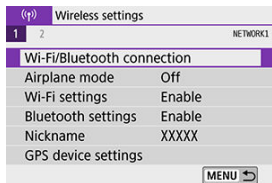

## 2. Select an item.

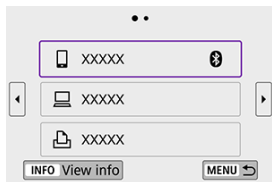

- Select an item to connect to via Wi-Fi from the displayed history. If the item is not displayed, use the <◀> <▶> keys to switch screens.
- If **[Connection history]** is set to **[Hide]**, the history will not be displayed (🔒).

### 3. Operate the connected device.

#### Smartphone

- Start Camera Connect.
- If the smartphone's connection destination has been changed, restore the setting to connect via Wi-Fi to the camera or the same access point as the camera.  
When directly connecting the camera to a smartphone via Wi-Fi, “\_Canon0A” is displayed at the end of the SSID.

#### Computer

- On the computer, start the EOS software.
- If the computer's connection destination has been changed, restore the setting to connect via Wi-Fi to the camera or the same access point as the camera.  
When directly connecting the camera to a computer via Wi-Fi, “\_Canon0A” is displayed at the end of the SSID.

#### Printer

- If the printer's connection destination has been changed, restore the setting to connect via Wi-Fi to the camera or the same access point as the camera.  
When directly connecting the camera to a printer via Wi-Fi, “\_Canon0A” is displayed at the end of the SSID.

# Registering Multiple Connection Settings

You can register up to 10 connection settings for the wireless communication functions.

## 1. Select [(Wi-Fi): Wi-Fi/Bluetooth connection].

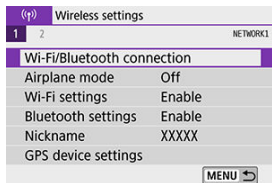

## 2. Select an item.



- If the history (📄) is displayed, switch the screen with the < << >> >> keys.
- For details on [📱 **Connect to smartphone**], see [Connecting to a Smartphone](#).
- For details on [💻 **Remote control (EOS Utility)**], see [Connecting to a Computer via Wi-Fi](#).
- For details on [🖨️ **Print from Wi-Fi printer**], see [Connecting to a Printer via Wi-Fi](#).
- When sending images to a Web service, see [Sending Images to a Web Service](#).

### Note

- To delete connection settings, see [Changing or Deleting Connection Settings](#).

# Wi-Fi Settings

## 1. Select [(Ⓜ): Wi-Fi settings].

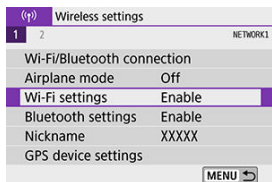

## 2. Select an item.

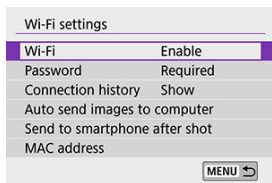

### ● Wi-Fi

When the use of electronic devices and wireless devices is prohibited, such as on board airplanes or in hospitals, set it to **[Disable]**.

### ● Password

Set to **[None]** to allow a Wi-Fi connection to be established without a password (except when connecting to an access point via Wi-Fi).

### ● Connection history

You can set the connection history of devices connected via Wi-Fi to **[Show]** or **[Hide]**.

### ● Auto send images to computer

With the dedicated software Image Transfer Utility 2, you can send images on the camera to a computer automatically (☑).

### ● Send to smartphone after shot

Your shots can be sent to a smartphone automatically (☑).

### ● MAC address

You can check the MAC address of the camera.

# Bluetooth Settings

---

## 1. Select [(Ⓟ): Bluetooth settings].

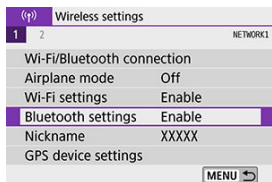

## 2. Select an item.

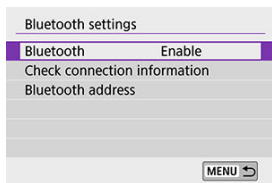

- **Bluetooth**

If you will not use the Bluetooth function, select [**Disable**].

- **Check connection information**

You can check the name and communication status of the paired device.

- **Bluetooth address**

You can check the camera's Bluetooth address.



# Nickname

---

You can change the camera nickname (displayed on smartphones and other cameras) as needed.

---

## 1. Select [(P): Nickname].

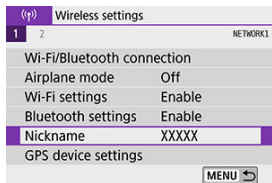

## 2. Enter text using the [Virtual Keyboard Operations](#).



- When you finish entering characters, press the < MENU > button.

# GPS Device Settings

---

[GP-E2](#)

[Smartphone](#)

[GPS Connection Display](#)

You can geotag images with GPS Receiver GP-E2 (sold separately) or a Bluetooth enabled smartphone.

## GP-E2

---

### 1. Attach GP-E2 to the camera.

- Attach GP-E2 to the camera's hot shoe and turn it on. For details, refer to the GP-E2 Instruction Manual.

### 2. Select [(P): GPS device settings].

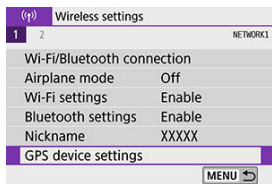

3. In [Select GPS device], select [GPS receiver].

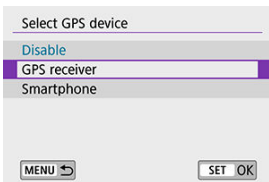

4. Take the picture.

- For details on [Set up], refer to the GP-E2 Instruction Manual.

**!** Caution

**Precautions when using GP-E2**

- Before use, check the countries and regions where use of GPS is allowed, and follow local regulations.
- Update the GP-E2 firmware to Ver. 2.0.0 or later.  
Firmware updating requires an interface cable. For updating instructions, visit the Canon website.
- GP-E2 cannot be connected to the camera with a cable.
- The camera does not record the shooting direction.

## Smartphone

Complete these settings after installing the dedicated Camera Connect app (📷) on the smartphone.

1. On the smartphone, activate location services.

2. Establish a Bluetooth connection.

- Start Camera Connect and pair the camera and smartphone via Bluetooth.

3. Select [(📶): GPS device settings].

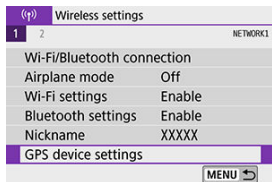

4. In [Select GPS device], select [Smartphone].

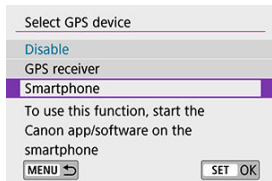

5. Take the picture.

- Images are geotagged with the information from the smartphone.

## GPS Connection Display

You can check the status of smartphone location information acquisition in the GPS connection icon on the screens for still photo shooting or movie recording (📍 and 📍, respectively).

- Gray: Location services are off
- Blinking: Location information cannot be acquired
- On: Location information acquired

For details on how GPS connection status is indicated when GP-E2 is used, refer to the GP-E2 Instruction Manual.

### Geotagging images as you shoot

Images you shoot while the GPS icon is on are geotagged.

### Geotagging information

You can check the location information added to your shots on the shooting information screen (📍).

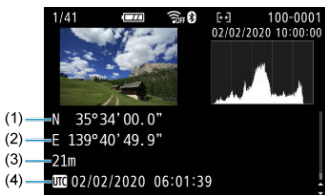

- (1) Latitude
- (2) Longitude
- (3) Elevation
- (4) UTC (Coordinated Universal Time)

 **Caution**

- The smartphone can acquire location information only while it is paired with the camera via Bluetooth.
- Direction information is not acquired.
- Acquired location information may not be accurate, depending on traveling conditions or smartphone status.
- It may take some time to acquire location information from the smartphone after you turn the camera on.
- Location information is no longer acquired after any of the following operations.
  - Pairing with a wireless remote control via Bluetooth
  - Turning the camera off
  - Quitting Camera Connect
  - Deactivating location services on the smartphone
- Location information is no longer acquired in any of the following situations.
  - The camera power turns off
  - The Bluetooth connection is ended
  - The smartphone's remaining battery level is low

 **Note**

- Coordinated Universal Time, abbreviated as UTC, is essentially the same as Greenwich Mean Time.
- For movies, the GPS information initially acquired is added.

# Changing or Deleting Connection Settings

To change or delete the connection settings, terminate the Wi-Fi connection first.

## 1. Select [(F1): Wi-Fi/Bluetooth connection].

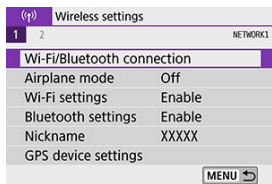

## 2. Select an item.

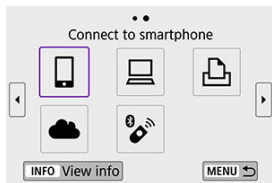

- If the history (📄) is displayed, switch the screen with the < ◀ ▶ > keys.

## 3. Select [Edit/delete device].

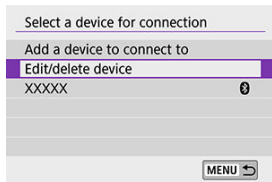

- You can change the Bluetooth connection by selecting a smartphone labeled with (📱) in gray. After the [Connect to smartphone] screen is displayed, select [Pair via Bluetooth], then press < (SET) > on the next screen.

4. Select the device for which to change or delete the connection settings.

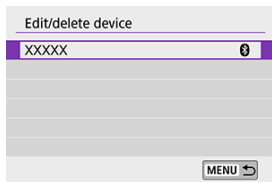

5. Select an option.

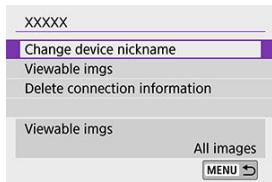

- Change or delete the connection settings on the displayed screen.

- **Change device nickname**

You can change the nickname using the virtual keyboard (📄).

- **Viewable imgs (📄)**

Displayed when [📱 **Connect to smartphone**] is selected. Settings will appear at the bottom of the screen.

- **Delete connection information**

When deleting connection information for a paired smartphone, also delete the camera information registered on the smartphone (📄).

 **Note**

- To delete image.canon connection settings, visit the image.canon website.



# Airplane Mode

You can temporarily disable Wi-Fi and Bluetooth functions.

## 1. Select [**↑**]: Airplane mode].

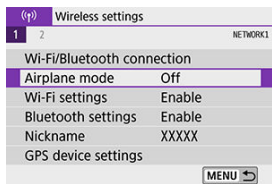

## 2. Set to [On].

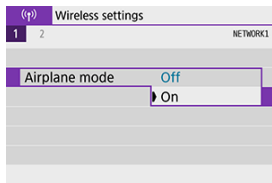

- [**↑**] is displayed on the screen.

### Note

- [**↑**] may not be displayed during Live View shooting, movie recording, or playback, depending on display settings. If it is not displayed, press the <INFO> button repeatedly to access detailed information display.

## Clearing Wireless Communication Settings to Default

All wireless communication settings can be deleted. By deleting the wireless communication settings, you can prevent their information from being exposed when you lend or give your camera to other people.

1. Select [(F): Clear wireless settings].

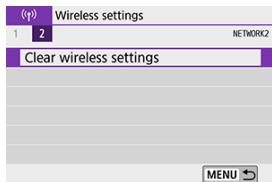

2. Select [OK].



**Caution**

- Performing [(F): **Clear all camera settings**] does not delete the wireless communication setting information.
- If you have paired the camera with a smartphone, on the smartphone's Bluetooth settings screen, delete the connection information of the camera for which you restored default wireless communication settings.

## View Info Screen

---

You can check error details and the camera's MAC address.

---

1. Select [(P): Wi-Fi/Bluetooth connection].

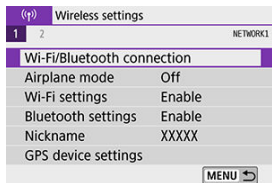

2. Press the <INFO> button.

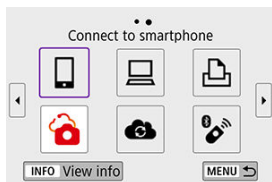

- The [View info] screen will appear.

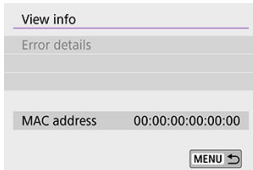





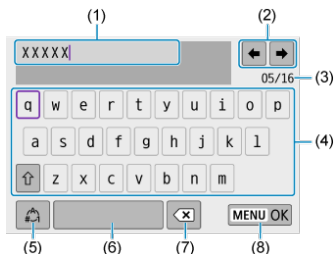

- When an error has occurred, press <(SET)> to display the error content.

## Virtual Keyboard Operations



- 
- (1) Input area, for entering text
  - (2) Cursor keys, for moving in the input area
  - (3) Current no. of characters/no. available
  - (4) Keyboard
  - (5) Switch input modes
  - (6) Space
  - (7) Delete a character in the input area
  - (8) Finish the text entry
- 

- Use the <  > dial to move within (2).
- Use the <  > <  > <  > <  > keys to move within (4)–(8).
- Press <  > to confirm input or when switching input modes.

## Responding to Error Messages

When an error occurs, display the details of the error by following one of the procedures below. Then, eliminate the cause of the error by referring to the examples shown in this chapter.







- On the **[View info]** screen, press <  >.
- Select **[Error details]** on the **[Wi-Fi on]** screen.

<a href="#">11</a>	<a href="#">12</a>	<a href="#">21</a>	<a href="#">22</a>	<a href="#">23</a>	<a href="#">61</a>	<a href="#">63</a>	<a href="#">64</a>
<a href="#">65</a>	<a href="#">66</a>	<a href="#">67</a>	<a href="#">68</a>	<a href="#">69</a>	<a href="#">91</a>	<a href="#">125</a>	<a href="#">126</a>
<a href="#">127</a>	<a href="#">141</a>	<a href="#">142</a>	<a href="#">151</a>	<a href="#">152</a>			

### Note

- When an error occurs, **[Err\*\*]** is displayed in the upper right of the **[Wi-Fi/Bluetooth connection]** screen. It disappears when the camera's power is set to **<OFF>**.

### 11: Connection target not found

- **In the case of , is Camera Connect running?**
  - Establish a connection using Camera Connect ().
- **In the case of , is the EOS software running?**
  - Start the EOS software and reestablish the connection ().
- **In the case of , is the power of the printer on?**
  - Turn on the printer.
- **Are the camera and the access point set to use the same password for authentication?**
  - This error occurs if the passwords do not match when the authentication method for encryption is set to **[Open system]**.  
Check upper- and lower-case letters, and make sure the correct password for authentication is set on the camera ().

### 12: Connection target not found

- **Is the power of the target device and access point on?**
  - Turn on the target device and access point, then wait a while. If a connection still cannot be established, perform the procedures to establish the connection again.

## 21: No address assigned by DHCP server

### What to check on the camera

- **On the camera, IP address is set to [Auto setting]. Is this the correct setting?**
  - If no DHCP server is used, specify the settings after setting the IP address to **[Manual setting]** on the camera (🔗).

### What to check on the DHCP server

- **Is the power of the DHCP server on?**
  - Turn on the DHCP server.
- **Are there enough addresses for assignment by the DHCP server?**
  - Increase the number of addresses assigned by the DHCP server.
  - Remove devices assigned addresses by the DHCP server from the network to reduce the number of addresses in use.
- **Is the DHCP server working correctly?**
  - Check the DHCP server settings to make sure it is working correctly as a DHCP server.
  - If applicable, ask your network administrator to ensure the DHCP server is available.

### What to check on the camera

- **On the camera, does the DNS server's IP address setting match the server's actual address?**
  - Set the IP address to **[Manual setting]**. Then, on the camera, set the IP address that matches the address of the DNS server used (🔗).

### What to check on the DNS server

- **Is the power of the DNS server on?**
  - Turn on the DNS server.
- **Are the DNS server settings for IP addresses and the corresponding names correct?**
  - On the DNS server, make sure IP addresses and the corresponding names are entered correctly.
- **Is the DNS server working correctly?**
  - Check the DNS server settings to make sure it is working correctly as a DNS server.
  - If applicable, ask your network administrator to ensure the DNS server is available.

### What to check on the network as a whole

- **Does the network that you are trying to connect to via Wi-Fi include a router or similar device that serves as a gateway?**
  - If applicable, ask your network administrator for the network gateway address and set it on the camera (🔗, 🔗).
  - Make sure that the gateway address setting is correctly entered on all network devices including the camera.

### What to check on the camera

- **Do the camera and another device connected via Wi-Fi to the same network have the same IP address?**
  - Change the camera's IP address to avoid using the same address as another device on the network. Otherwise, change the IP address of the device that has a duplicate address.
  - If the camera's IP address is set to **[Manual setting]** in network environments using a DHCP server, change the setting to **[Auto setting]** (🔗).



#### Note

#### Responding to error messages 21–23

- Also check the following points when responding to errors numbered 21–23.  
**Are the camera and the access point set to use the same password for authentication?**
  - This error occurs if the passwords do not match when the authentication method for encryption is set to **[Open system]**. Check upper- and lower-case letters, and make sure the correct password for authentication is set on the camera (🔗).



## 61: Selected SSID wireless LAN network not found

- **Are any obstacles blocking the line of sight between the camera and the antenna of the access point?**
  - Move the antenna of the access point to a position clearly visible from the point of view of the camera (🔗).

### What to check on the camera

- **Does the SSID set on the camera match that of the access point?**
  - Check the SSID at the access point, then set the same SSID on the camera.

### What to check at the access point

- **Is the access point turned on?**
  - Turn on the power of the access point.
- **If filtering by MAC address is active, is the MAC address of the camera in use registered at the access point?**
  - Register the MAC address of the camera used to the access point. The MAC address can be checked on the [View info] screen (🔗).

### 63: Wireless LAN authentication failed

- **Are the camera and the access point set to use the same authentication method?**
  - The camera supports the following authentication methods: [Open system], [Shared key], and [WPA/WPA2-PSK].
- **Are the camera and the access point set to use the same password for authentication?**
  - Check upper- and lower-case letters, and make sure the correct password for authentication is set on the camera.
- **If filtering by MAC address is active, is the MAC address of the camera in use registered at the access point?**
  - Register the MAC address of the camera used to the access point. The MAC address can be checked on the [View info] screen (🔗).

### 64: Cannot connect to wireless LAN terminal

- **Are the camera and the access point set to use the same encryption method?**
  - The camera supports the following encryption methods: WEP, TKIP, and AES.
- **If filtering by MAC address is active, is the MAC address of the camera in use registered at the access point?**
  - Register the MAC address of the camera used to the access point. The MAC address can be checked on the [View info] screen (🔗).

### 65: Wireless LAN connection lost

- **Are any obstacles blocking the line of sight between the camera and the antenna of the access point?**
  - Move the antenna of the access point to a position clearly visible from the point of view of the camera.
- **The Wi-Fi connection was lost for some reason, and the connection cannot be restored.**
  - The following are possible reasons: excessive access to the access point from another device, a microwave oven or similar appliance in use nearby (interfering with IEEE 802.11b/g/n (2.4 GHz band)), or influence of rain or high humidity (🔗).

## 66: Incorrect wireless LAN password

- **Are the camera and the access point set to use the same password for authentication?**
  - Check upper- and lower-case letters, and make sure the correct password for authentication is set on the camera.

## 67: Incorrect wireless LAN encryption method

- **Are the camera and the access point set to use the same encryption method?**
  - The camera supports the following encryption methods: WEP, TKIP, and AES.
- **If filtering by MAC address is active, is the MAC address of the camera in use registered at the access point?**
  - Register the MAC address of the camera used to the access point. The MAC address can be checked on the [View info] screen (🔗).

## 68: Cannot connect to wireless LAN terminal. Retry from the beginning.

- **Did you hold down the access point's WPS (Wi-Fi Protected Setup) button for the specified period of time?**
  - Hold down the WPS button for the period of time specified in the access point's instruction manual.
- **Are you trying to establish a connection near the access point?**
  - Try establishing the connection when both devices are within reach of each other.

## 69: Multiple wireless LAN terminals have been found. Cannot connect. Retry from the beginning.

- **Connection is in progress by other access points in Pushbutton Connection mode (PBC mode) of WPS (Wi-Fi Protected Setup).**
  - Wait a while before trying to establish the connection.

## 91: Other error

- **A problem other than error code number 11 to 69 occurred.**
  - Turn the camera's power switch off and on.

## 125: Check the network settings

- **Is the network connected?**
  - Check the connection status of the network.

## 126: Could not connect to server

- **image.canon is under maintenance or temporarily busy.**
  - Try accessing the service again later.

## 127: An error has occurred

- **A problem other than error code number 121 to 126 occurred while the camera is connected to the Web service.**
  - Try again to establish the Wi-Fi connection to image.canon.

## 141: Printer is busy. Try connecting again.

- **Is the printer performing a printing process?**
  - Try again to establish the Wi-Fi connection to the printer after the printing process is finished.
- **Is another camera connected to the printer via Wi-Fi?**
  - Try again to establish the Wi-Fi connection to the printer after the Wi-Fi connection to the other camera has been terminated.

## 142: Could not acquire printer information. Reconnect to try again.

- **Is the power of the printer on?**
  - Try again to establish the Wi-Fi connection after turning on the printer.

## 151: Transmission canceled

- **Automatic image transfer to the computer was somehow interrupted.**
  - To resume automatic image transfer, set the camera's power switch to < **OFF** >, and then set it to < **ON** >.

## 152: Card's write protect switch is set to lock

- **Is the card's write-protect switch set to the locked position?**
  - Slide the card's write-protect switch to the writing position.

## Wireless Communication Function Precautions

---

- [☑ Distance Between the Camera and the Smartphone](#)
- [☑ Installation Location of Access Point Antenna](#)
- [☑ Nearby Electronic Devices](#)
- [☑ Precautions for Using Multiple Cameras](#)

If the transmission rate drops, the connection is lost, or other problems occur when using the wireless communication functions, try the following corrective actions.

---

### Distance Between the Camera and the Smartphone

---

If the camera is too far from the smartphone, a Wi-Fi connection may not be established even when Bluetooth connection is possible. In this case, bring the camera and the smartphone closer together, then establish a Wi-Fi connection.

## Installation Location of Access Point Antenna

---

- When using indoors, install the device in the room where you are using the camera.
- Install the device where people or objects do not come between the device and the camera.

## Nearby Electronic Devices

---

If the Wi-Fi transmission rate drops because of the influence of the following electronic devices, stop using them or move further away from the devices to transmit communication.

- The camera communicates over Wi-Fi via IEEE 802.11b/g/n using radio waves in the 2.4 GHz band. For this reason, the Wi-Fi transmission rate will drop if there are Bluetooth devices, microwave ovens, cordless telephones, microphones, smartphones, other cameras, or similar devices operating on the same frequency band nearby.

## Precautions for Using Multiple Cameras

---

- When connecting multiple cameras to one access point via Wi-Fi, make sure the cameras' IP addresses are different.
- When multiple cameras are connected to one access point via Wi-Fi, the transmission rate drops.
- When there are multiple IEEE 802.11b/g/n (2.4 GHz band) access points, leave a gap of five channels between each Wi-Fi channel to reduce radio wave interference. For example, use channels 1, 6, and 11, channels 2 and 7, or channels 3 and 8.



## Security

---

If security settings have not been properly set, the following problems may occur.

- **Transmission monitoring**  
Third parties with malicious intent may monitor wireless LAN transmissions and attempt to acquire the data you are sending.
- **Unauthorized network access**  
Third parties with malicious intent may gain unauthorized access to the network you are using to steal, modify, or destroy information. Additionally, you could fall victim to other types of unauthorized access such as impersonation (where someone assumes an identity to gain access to unauthorized information) or springboard attacks (where someone gains unauthorized access to your network as a springboard to cover their tracks when infiltrating other systems).

It is recommended to make use of the systems and functions to thoroughly secure your network, preventing these types of problems from occurring.

## Checking Network Settings

---

### Windows

Open the Windows **[Command Prompt]**, then type `ipconfig/all` and press the **<Enter>** key. In addition to the IP address assigned to the computer, the subnet mask, gateway, and DNS server information are also displayed.

### macOS

In macOS, open the **[Terminal]** application, enter `ifconfig -a`, and press the **<Return>** key. The IP address assigned to the computer is indicated in the **[en0]** item next to **[inet]**, in the format `****.***.***.***`.

For information about the **[Terminal]** application, refer to the macOS help.

To avoid using the same IP address for the computer and other devices on the network, change the rightmost number when configuring the IP address assigned to the camera in the processes described in [Manual IP Address Setup](#).

Example: 192.168.1.**10**

# Wireless Communication Status

Wireless communication status can be checked on the screen.

Quick Control screen



- (1) (2) (3)

Information display screen during playback





- (1) (2)

- (1) Wi-Fi function  
 (2) Bluetooth function  
 (3) Wireless signal strength

Communication Status		Screen	
		Wi-Fi Function	Wireless Signal Strength
Not connected	Wi-Fi: Disable	Wi-Fi Off	Off
	Wi-Fi: Enable	Wi-Fi Off	
Connecting		Wi-Fi (Blinking)	Weak Signal
Connected		Wi-Fi	Medium Signal
Sending data		Wi-Fi (←→)	Medium Signal
Connection error		Wi-Fi (Blinking)	Weak Signal

## Bluetooth Function Indicator

Bluetooth Function	Connection Status	Screen
Other than [Disable]	Bluetooth connected	
	Bluetooth not connected	
[Disable]	Bluetooth not connected	Not displayed

# Set-up

---

This chapter describes menu settings on the set-up ([**F**]: Set-up) tab.

- ☆ to the right of page titles indicates functions only available in Creative Zone modes (< **P** >, < **Tv** >, < **Av** >, or < **M** >).
  - [Tab Menus: Set-up](#)
  - [Selecting a Folder](#)
  - [File Numbering](#)
  - [Auto Rotate](#)
  - [Adding Orientation Information to Movies](#)
  - [Formatting](#)
  - [Auto Power Off](#)
  - [Display Brightness](#)
  - [Screen Off/On](#)
  - [Date/Time/Zone](#)
  - [Language](#)
  - [Video System](#)
  - [Touch Control](#)
  - [Beeps](#)
  - [Battery Information](#)
  - [Sensor Cleaning](#)
  - [Viewfinder Display](#)
  - [INFO Button Display Options](#)
  - [Grid Display When Shooting](#)
  - [Shutter Button Function for Movies](#)
  - [Switching AF Point Selection and AE Lock Buttons](#)
  - [HDMI Resolution](#)
  - [Multi-Function Lock](#)
  - [Custom Functions \(C.Fn\)](#) ☆
  - [Clearing Settings](#) ☆
  - [Copyright Information](#) ☆
  - [Other Information](#)

## Tab Menus: Set-up

---

### ● Set-up 1

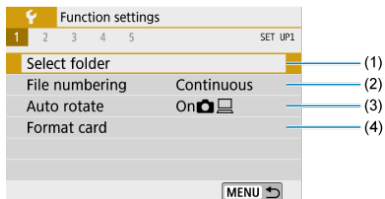

- (1) [Select folder](#)
- (2) [File numbering](#)
- (3) [Auto rotate](#)
- (4) [Format card](#)

### ● Set-up 2

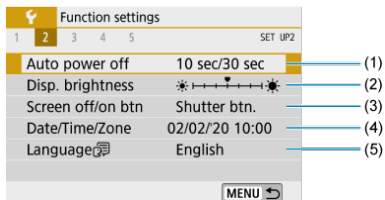

- (1) [Auto power off](#)
- (2) [Disp. brightness](#)
- (3) [Screen off/on btn](#)
- (4) [Date/Time/Zone](#)
- (5) [Language](#)

### ● Set-up 3

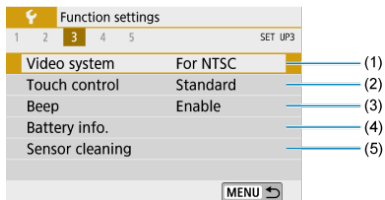

- (1) [Video system](#)
- (2) [Touch control](#)
- (3) [Beep](#)
- (4) [Battery info.](#)
- (5) [Sensor cleaning](#)

### ● Set-up 4

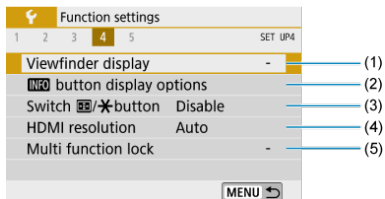

- (1) [Viewfinder display](#)
- (2) [INFO button display options](#)
- (3) [Switch \[INFO\]/\\*button](#)
- (4) [HDMI resolution](#)
- (5) [Multi function lock](#)

## ● Set-up 5

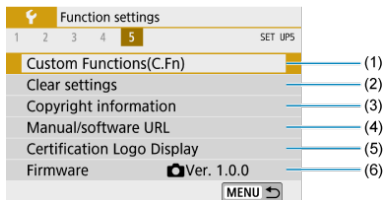

- (1) [Custom Functions\(C.Fn\)](#) ☆
- (2) [Clear settings](#) ☆
- (3) [Copyright information](#) ☆
- (4) [Manual/software URL](#)
- (5) [Certification Logo Display](#) ☆
- (6) [Firmware](#) ☆

### ⚠ Caution

- [Screen off/on btn], [Viewfinder display], [INFO button display options], and [Firmware] are not displayed in Live View shooting or movie recording.

## ● In Live View shooting, the following screen is displayed for [4].

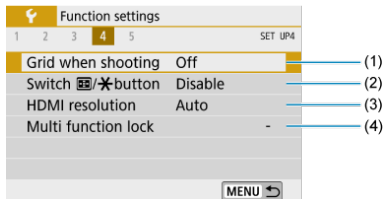

- (1) [Grid when shooting](#)
- (2) [Switch \[INFO\]/\\*button](#)
- (3) [HDMI resolution](#)
- (4) [Multi function lock](#)



- In movie recording, the following screen is displayed for [F1].

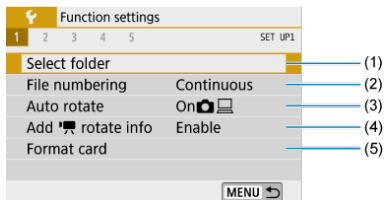

- (1) [Select folder](#)
- (2) [File numbering](#)
- (3) [Auto rotate](#)
- (4) [Add rotate info](#)
- (5) [Format card](#)

- In movie recording, the following screen is displayed for [F4].

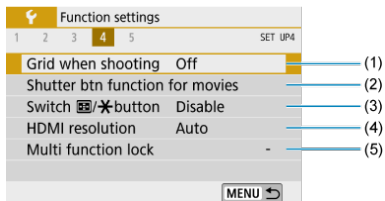

- (1) [Grid when shooting](#)
- (2) [Shutter btn function for movies](#)
- (3) [Switch button](#)
- (4) [HDMI resolution](#)
- (5) [Multi function lock](#)

- In Basic Zone modes, the following screen is displayed for [F5].

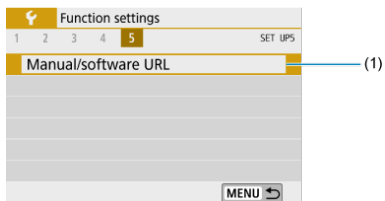

(1) [Manual/software URL](#)

# Selecting a Folder

---

[Creating a Folder](#)

[Selecting a Folder](#)

You can freely create and select the folder where the captured images are to be saved.

---

## Creating a Folder

---

### 1. Select [: Select folder].

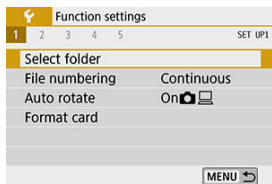

### 2. Select [Create folder].

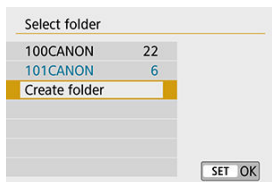

**3. Select [OK].**

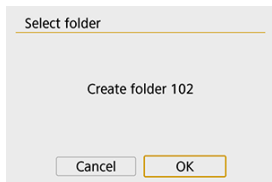

## Selecting a Folder

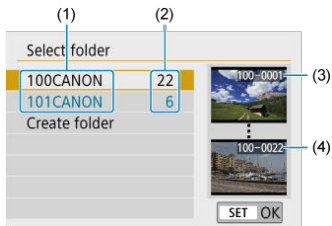

(1) Folder name

(2) Number of images in folder

(3) Lowest file number

(4) Highest file number

- Select a folder on the folder selection screen.
- Captured images are stored in your selected folder.

### Note

#### Folders

- A folder can contain up to 9999 images (file number 0001–9999). When a folder becomes full, a new folder with the folder number increased by one is created automatically. Also, if manual reset (Ⓢ) is executed, a new folder will be created automatically. Folders numbered from 100 to 999 can be created.

#### Creating folders with a computer

- With the card open on the screen, create a new folder named "DCIM". Open the DCIM folder and create as many folders as necessary to save and organize your images. The folder name must follow the format "100ABC\_D". The first three digits are always the folder number from 100 to 999. The last five characters can be any combination of upper- and lower-case letters from A to Z, numerals, and the underscore "\_". The space cannot be used. Also note that two folder names cannot share the same three-digit folder number (for example, "100ABC\_D" and "100W\_XYZ") even if the remaining five characters in each name are different.

# File Numbering

---

- [Continuous](#)
- [Auto Reset](#)
- [Manual Reset](#)

The captured images saved in a folder are assigned a file number from 0001 to 9999. You can change how the image files are numbered.

(Example)  
**IMG\_0001.JPG**  
|  
(1)  
(1) File number

---

## 1. Select [: File numbering].

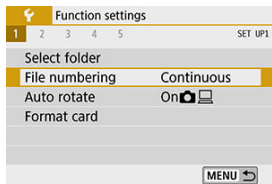

## 2. Set the item.

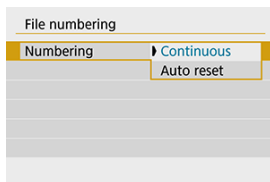

- Select [**Numbering**].
- Select [**Continuous**] or [**Auto reset**].

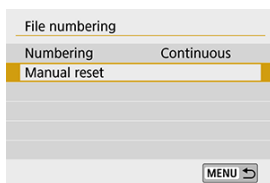

- If you want to reset the file numbering, select [**Manual reset**] (🔗).

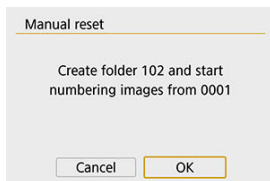

- Select [**OK**] to create a new folder, and the file number will start with 0001.

### ⚠ Caution

- If the file number in folder 999 reaches 9999, shooting will not be possible even if the card still has storage capacity. The screen will display a message telling you to replace the card. Replace it with a new card.

### When you wish to continue the file numbering sequence even after the card is replaced or a new folder is created.

Even after you replace the card or create a new folder, the file numbering continues in sequence up to 9999. This is useful when you want to save images numbered anywhere between 0001 to 9999 on multiple cards or in multiple folders into one folder on a computer. If the replacement card or existing folder already contains images recorded previously, the file numbering of the new images may continue from the file numbering of the existing images on the card or in the folder. If you want to use continuous file numbering, it is recommended that you use a newly-formatted card each time.

#### File numbering after replacing the card

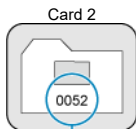
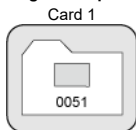

(1)

(1) Next sequential file number

#### File numbering after creating a folder

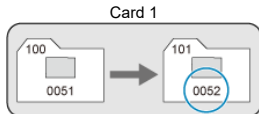



### When you wish to restart the file numbering from 0001 each time the card is replaced or a new folder is created.

When you replace the card or create a folder, the file numbering restarts from 0001 for the new images saved. This is useful if you want to organize images by cards or folders. If the replacement card or existing folder already contains images recorded previously, the file numbering of the new images may continue from the file numbering of the existing images on the card or in the folder. If you want to save images with the file numbering starting from 0001, use a newly formatted card each time.

#### File numbering after replacing the card

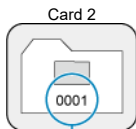
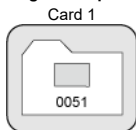

(1)

(1) File numbering is reset

#### File numbering after creating a folder

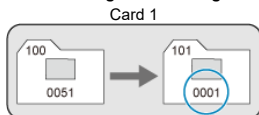

### **When you wish to reset the file numbering to 0001 or to start from file number 0001 in a new folder.**

When you reset the file numbering manually, a new folder is created automatically and the file numbering of images saved to that folder starts from 0001.

This is useful, for example, if you want to use different folders for the images taken yesterday and the ones taken today.

# Auto Rotate

---

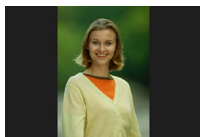



You can change the auto rotation setting that straightens images shot in vertical orientation when they are displayed.

---

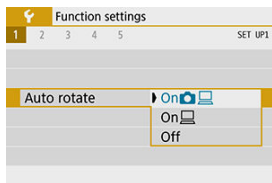
## 1. Select [: Auto rotate].



## 2. Select an item.

- **On**   
Automatically rotates images for display on both the camera and computers.
- **On**   
Automatically rotates images only for display on computers.
- **Off**

### Caution

- Images captured with auto rotation set to **[Off]** will not rotate during playback even if you later set auto rotation to **[On]**.



#### Note

- If a picture is taken while the camera is pointing up or down, auto rotation to the proper orientation for viewing may not be performed correctly.
- If images are not rotated automatically on a computer, try using EOS software.

# Adding Orientation Information to Movies

For movies recorded with the camera held vertically, orientation information indicating which side is up can be added automatically to enable playback in the same orientation on smartphones or other devices.

## 1. Select [📷: Add '📷 rotate info].

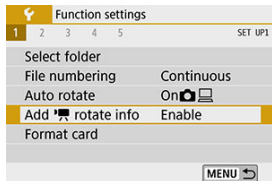

## 2. Select a setting item.

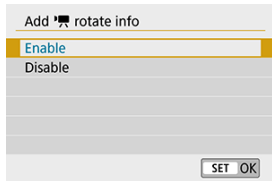

- **Enable**  
Play movies on smartphones or other devices in the orientation in which they were recorded.
- **Disable**  
Play movies horizontally on smartphones or other devices, regardless of the recording orientation.

### Note

- Movies are played horizontally on the camera, regardless of the [📷: Add '📷 rotate info] setting.

# Formatting

---

If the card is new or was previously formatted (initialized) by another camera or computer, format the card with this camera.

## Caution

- **When the card is formatted, all images and data on the card will be erased. Even protected images will be erased, so make sure there is nothing you need to keep. If necessary, transfer the images and data to a computer, etc. before formatting the card.**

## 1. Select [: Format card].

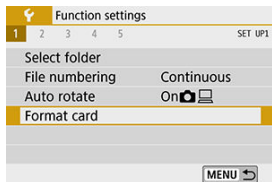

## 2. Format the card.

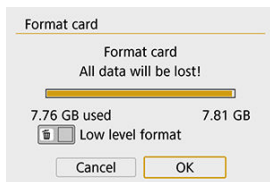

- Select **[OK]**.

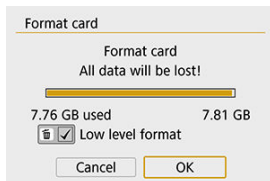

- For low-level formatting, press the  $\langle \checkmark \rangle$  button to add a checkmark  $\checkmark$  to **[Low level format]**, then select **[OK]**.

### Note

- The card capacity displayed on the card format screen may be smaller than the capacity indicated on the card.
- This device incorporates exFAT technology licensed from Microsoft.

## Conditions requiring card formatting

---

- The card is new.
- The card was formatted by a different camera or a computer.
- The card is full of images or data.
- A card-related error is displayed.

### Low-level formatting

- Perform low-level formatting if the card's writing or reading speed seems slow or if you want to totally erase the data on the card.
- Since low-level formatting will format all recordable sectors on the card, the formatting will take longer than normal formatting.
- During low-level formatting, you can cancel formatting by selecting **[Cancel]**. Even in this case, normal formatting will already be complete and you can use the card as usual.

### Card file formats

- **SD/SDHC cards will be formatted in FAT32. SDXC cards will be formatted in exFAT.**
- Individual movies recorded to exFAT cards are recorded as a single file (without splitting them into multiple files) even if they exceed 4 GB, so the resulting movie file will exceed 4 GB.

#### Caution

- It may not be possible to use SDXC cards formatted with this camera in other cameras. Also note that exFAT-formatted cards may not be recognized by some computer operating systems or card readers.
- Formatting or erasing data on a card does not completely erase the data. Be aware of this when selling or discarding the card. When disposing of cards, take steps to protect personal information if necessary, as by physically destroying cards.



# Auto Power Off

You can change the camera's auto power off time.

## 1. Select [: Auto power off].

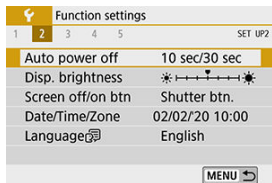

## 2. Select an item.

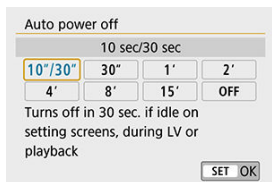

### Note

- The screen turns off in approx. 30 min. even when set to [OFF]. To activate the screen, press the <DISP> button.

# Display Brightness

## 1. Select [☛: Disp. brightness].

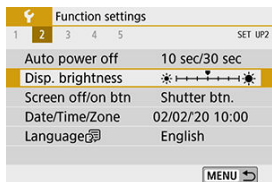

## 2. Make the adjustment.

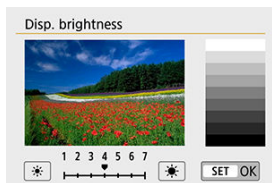

- Referring to the gray chart, use the < ◀ ▶ > keys to adjust the brightness, then press < SET >.

### Note

- To check the image's exposure, referring to the histogram is recommended (☛).

## Screen Off/On

---

You can set the camera so that the screen turns off and on as you press the shutter button halfway in viewfinder shooting.

---

1. Select [: Screen off/on btn].
2. Select an item.

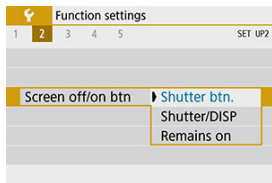

- **Shutter btn.**  
The screen turns off when you press the shutter button halfway. To turn on the screen, release the button.
- **Shutter/DISP**  
Display is cleared and the screen turns off when you press the shutter button halfway. Press the <DISP> button to display the menu screen.
- **Remains on**  
The screen does not turn off when you press the shutter button halfway. To turn off the screen, press the <INFO> button.

## Date/Time/Zone

---

When you turn on the power for the first time or if the date/time/zone have been reset, follow these steps to set the time zone first.

By setting the time zone first, you can simply adjust this setting as needed in the future and the date/time will be updated to match it.

Since the captured images will be appended with the shooting date and time information, be sure to set your date/time.

---

### 1. Select [: Date/Time/Zone].

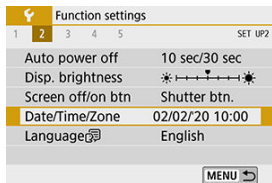

## 2. Set the time zone.

Date/Time/Zone

Time zone ±00:00

02 . 02 . 2020 10 : 00 : 00

mm/dd/yy

☼ London

▼ ▲ OK Cancel

- Use the <◀><▶> keys to select [Time zone].
- Press <SET>.

Zone/Time difference

02/02/2020 10:00:00

Zone

London

Time difference + 00 : 00

▼ ▲ OK Cancel

- Press <SET>.

Time zone

02/02/2020 10:00:00

São Paulo	-03:00
Fernando de Noronha	-02:00
Azores	-01:00
London	±00:00
Paris	+01:00

SET OK

- Use the <▲><▼> keys to select the time zone, then press <SET>.
- If your time zone is not listed, press the <MENU> button, then set the difference from UTC in [Time difference].

Zone/Time difference

02/02/2020 10:00:00

Zone

-----

Time difference + 09 : 15

▼ ▲ OK Cancel

- Use the <◀><▶> keys to select a [Time difference] item (+ -/ hour/minute), then press <ⓈET>.
- Use the <▲><▼> keys to set it, then press <ⓈET>.
- After entering the time zone or time difference, use the <◀><▶> keys to select [OK], then press <ⓈET>.

### 3. Set the date and time.

Date/Time/Zone

(02/02/2020)

02 . 02 . 2020 10 : 00 : 00

mm/dd/yy

☀ London

▼ ▲ OK Cancel

- Use the <◀><▶> keys to select an item, then press <ⓈET>.
- Use the <▲><▼> keys to set it, then press <ⓈET>.

#### 4. Set daylight saving time.

The screenshot shows the 'Date/Time/Zone' menu. At the top, it says 'Date/Time/Zone'. Below that, a grey bar indicates 'Daylight saving time off'. The date is set to '02 . 02 . 2020' and the time to '10 : 00 : 00'. Below the time, it says 'mm/dd/yy'. There is a sun icon with a lightning bolt and a downward arrow, and the text 'London' is displayed in a text field. At the bottom, there are navigation arrows and 'OK' and 'Cancel' buttons.

- Set it as necessary.
- Use the < ◀ > ▶ > keys to select [☀], then press < (SET) >.
- Use the < ▲ > ▼ > keys to select [☀], then press < (SET) >.
- When the daylight saving time is set to [☀], the time set in step 3 will advance by 1 hour. If [☁] is set, the daylight saving time will be canceled and the time will go back by 1 hour.

#### 5. Exit the setting.

The screenshot shows the 'Date/Time/Zone' menu. At the top, it says 'Date/Time/Zone'. Below that, a grey bar indicates '(02/02/2020)'. The date is set to '02 . 02 . 2020' and the time to '10 : 00 : 00'. Below the time, it says 'mm/dd/yy'. There is a sun icon with a lightning bolt and a downward arrow, and the text 'London' is displayed in a text field. At the bottom, there are navigation arrows and 'OK' and 'Cancel' buttons. The 'OK' button is highlighted with a yellow border.

- Use the < ◀ > ▶ > keys to select [OK].

#### ! Caution

- The [Date/Time/Zone] setting may be reset when the camera is stored without the battery, when the battery is depleted, or when it is exposed to freezing temperatures for an extended period. If this happens, set them once again.
- After changing [Zone/Time difference], check that the correct date/time are set.



#### Note

- Auto power off time may be extended while the [👉: **Date/Time/Zone**] screen is displayed.



## 1. Select [: Language ].

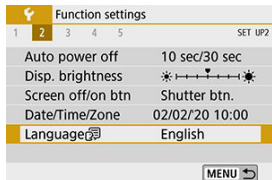

## 2. Set the desired language.



# Video System

---

Set the video system of any television used for display. This setting determines the frame rates available when you record movies.

---

## 1. Select [🔧: Video system].

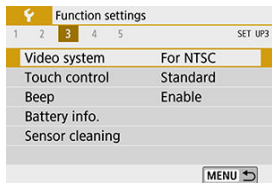

## 2. Select an item.

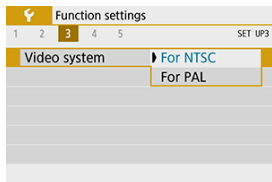

- **For NTSC**  
For areas where the TV system is NTSC (North America, Japan, South Korea, Mexico, etc.).
- **For PAL**  
For areas where the TV system is PAL (Europe, Russia, China, Australia, etc.).

# Touch Control

## 1. Select [**T**: Touch control].

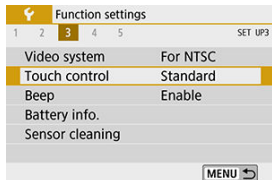

## 2. Select an item.

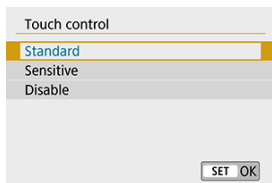

- [Sensitive] provides a more reactive touch-screen panel response than [Standard].
- To disable touch operations, select [Disable].

### ! Caution

#### Precautions for touch-screen operations

- Do not use sharp objects such as fingernails or ballpoint pens for touch operations.
- Do not use wet fingers for touch operations. If the screen has any moisture or if your fingers are wet, the touch-screen panel may not respond or malfunction may occur. In this case, turn off the power and wipe off the moisture with a cloth.
- Attaching any commercially available protective sheet or sticker on the screen may degrade the touch operation response.
- If you quickly perform touch operation when [Sensitive] is set, the touch operation response may be poor.

## 1. Select [🔊: Beep].

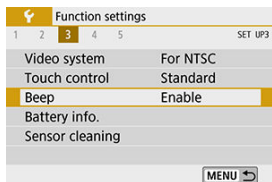

## 2. Select an item.

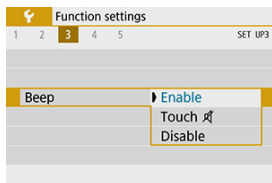

- **Enable**  
The camera beeps after focusing and in response to touch operations.
- **Touch** 🔊  
Disables beeping for touch operations.
- **Disable**  
Disables beeping for focus confirmation, self-timer shooting, and touch operations.

# Battery Information

You can check the conditions of the battery you are using on the screen.

## 1. Select [🔍: Battery info.].

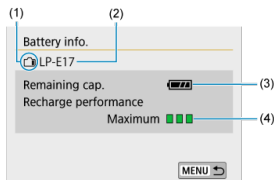
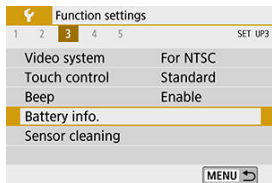

- (1) Battery position
- (2) Model of battery or household power source used.
- (3) The battery level (🔋) is displayed.
- (4) Battery's recharge performance level is displayed in three levels.

: Battery's recharge performance is good.

: Battery's recharge performance is slightly degraded.

: Purchasing a new battery is recommended.

### ⚠ Caution

- Using a genuine Canon Battery Pack LP-E17 is recommended. If you use batteries that are not genuine Canon products, the camera's full performance may not be attained or malfunction may result.



#### Note

- If a battery communication error message is displayed, follow the instructions in the message.

# Sensor Cleaning

---

- [Cleaning Now](#)
- [Cleaning Automatically](#)
- [Cleaning Manually](#) ☆

## Cleaning Now

---

1. Select [: Sensor cleaning].

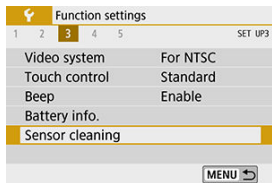

2. Select [Clean now ].

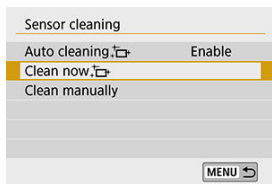

- Select [OK] on the confirmation screen.

### 1. Select [Auto cleaning, ].

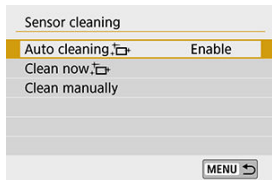

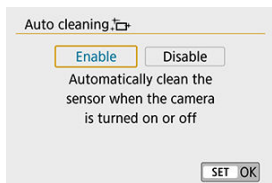

### 2. Select a setting item.



- Use the <◀> <▶> keys to select an item, then press <SET>.

#### Note

- For best results, clean with the camera in a stable position on a desk or other flat surface.
- Even if you repeat the sensor cleaning, the result will not improve much. Note that [Clean now, >] may not be available immediately after cleaning.
- Dots of light may appear in captured images or on the shooting screen if the sensor is affected by cosmic rays or similar factors. By selecting [Clean now, >], their appearance may be suppressed (>).



Dust that could not be removed by automatic cleaning can be removed manually with a commercially available blower or similar tool.

Always use a fully charged battery.

The image sensor is extremely delicate. If the sensor needs to be cleaned directly, having it done by a Canon Service Center is recommended.

## 1. Select [**W**]: Sensor cleaning.

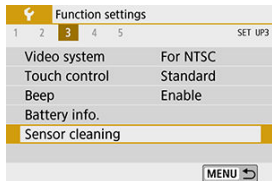

## 2. Select [Clean manually].

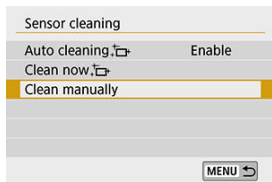

## 3. Select [OK].

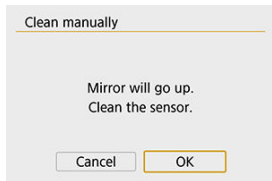

## 4. Remove the lens and clean the sensor.

## 5. End the cleaning.

- Set the power switch to < OFF >.

### Note

- Using the household power outlet accessories (sold separately) is recommended.

### Caution

- **While cleaning the sensor, never do any of the following. If the power is cut off, the shutter will close and the reflex mirror will go back down. These may result in damaging the image sensor, shutter curtains, and reflex mirror.**
  - **Setting the power switch to < OFF >.**
  - **Removing or inserting the battery.**
- The surface of the image sensor is extremely delicate. Clean the sensor with care.
- Use a plain blower without any brush attached. A brush can scratch the sensor.
- Do not insert the blower tip inside the camera beyond the lens mount. If the power is turned off, the shutter will close and the shutter curtains or reflex mirror may get damaged.
- Never use pressurized air or gas to clean the sensor. Pressurized air may damage the sensor, and sprayed gas may freeze on the sensor and scratch it.
- If the battery level becomes low while cleaning the sensor, the beeper will sound as a warning. Stop cleaning the sensor.
- If a smudge that cannot be removed with a blower remains, having the sensor cleaned by a Canon Service Center is recommended.

# Viewfinder Display

---

[Electronic Level](#)

[Grid](#)

[Flicker Detection](#) ☆

## 1. Select [: Viewfinder display].

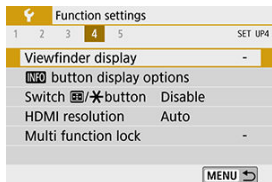

## 2. Select an item.

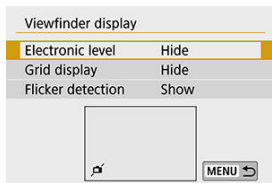

- Select with the <▲> <▼> keys, then press <SET>.

## Electronic Level

The electronic level appears when you press the shutter button halfway. Also available in vertical shooting.

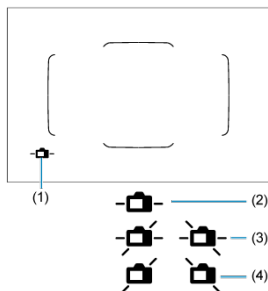

(1) Electronic level

(2) Horizontal

(3) Tilted 1°

(4) Tilted 2° or more

### Caution

- Only horizontal tilt can be checked. (Forward/backward tilt is not displayed.)
- There may be a margin of error of approx.  $\pm 1^\circ$ .

### Note

- An asterisk "\*" to the right of [**☑**: **Viewfinder display**] indicates that the default viewfinder display setting has been changed.

## Grid

---

You can display a grid in the viewfinder to help you check the camera tilt or compose the shot.

## Flicker Detection

---



If you set this function, < **Flicker!** > will appear in the viewfinder when the camera detects flicker caused by the blinking of the light source.



### Note

- If you set [: **Anti-flicker shoot.**] to [**Enable**], you can shoot with reduced unevenness of exposure caused by the flicker ().

# INFO Button Display Options

---

You can select the information displayed on the screen in response to pressing the <INFO> button when the camera is ready to shoot.

---

## 1. Select [: INFO button display options].

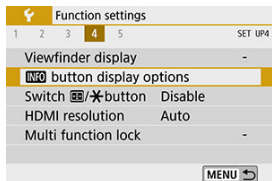

## 2. Select an option.

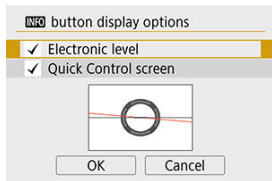

- Select the desired display option, then add a checkmark [✓].
- Select [OK].

## Electronic Level

The red line turns green when the image is essentially straight.

- Only horizontal tilt can be checked. (Forward/backward tilt is not displayed.)

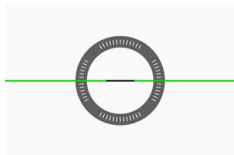
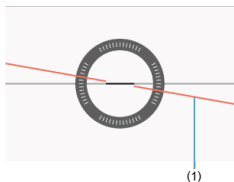

(1) Horizontal

### ⚠ Caution

- There may be a margin of error of approx.  $\pm 1^\circ$ .
- If the camera is very tilted, the electronic level's margin of error will be larger.

### 📄 Note

- The electronic level is not displayed in Live View shooting when the AF method is set to [**L**+Tracking].
- For details on [Quick Control screen], see [Quick Control Screen \(in Viewfinder Shooting\)](#).

## Grid Display When Shooting

---

You can display grid lines in Live View shooting or movie recording to help you level the camera vertically and horizontally.

---

### 1. Display the Live View image.

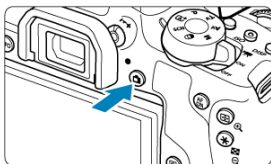

- Press the <  > button.

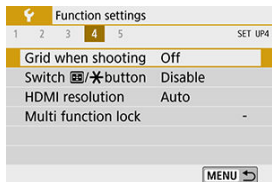

### 2. Select [: Grid when shooting].





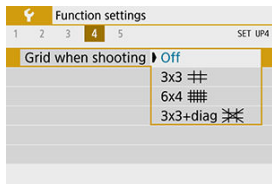



### 3. Select an item.



- **Off**  
No grid display.
- **3x3**   
Displays grid lines in a 3x3 pattern to help you level the camera vertically and horizontally.
- **6x4**   
Displays grid lines in a 6x4 pattern to help you level the camera vertically and horizontally.
- **3x3+diag**   
Displays a grid together with diagonal lines to help you level the camera vertically and horizontally and compose with better balance by aligning the intersections over the subject.

#### Note

- Live View shooting ends when you select [: **Dust Delete Data**] or either [**Clean now**, ] or [**Clean manually**] in [: **Sensor cleaning**]. To start Live View shooting again, press the <  > button.

## Shutter Button Function for Movies

---

You can set the functions performed by pressing the shutter button halfway or completely during movie recording.

---

### 1. Select [: Shutter btn function for movies].

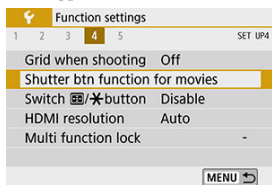

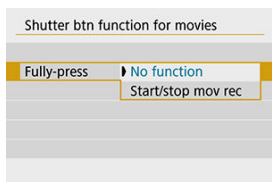
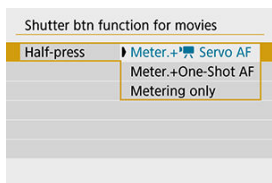

## 2. Select an item.



- **Half-press**  
Specify the function performed by pressing the shutter button halfway.
- **Fully-press**  
Specify the function performed by pressing the shutter button completely.

With **[Fully-press]** set to **[Start/stop mov rec]**, you can start/stop movie recording not only by pressing the movie shooting button but also by pressing the shutter button completely, or by using Wireless Remote Control BR-E1 or Remote Switch RS-60E3.

# Switching AF Point Selection and AE Lock Buttons

You can switch the functions of the  and  buttons, if this is more convenient for your hand size or how you hold the grip.

## 1. Select [: Switch /button].

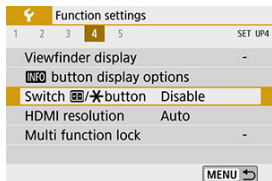

## 2. Select a setting item.

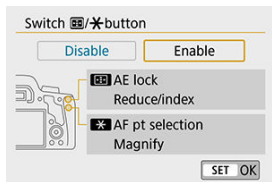

# HDMI Resolution

---

Set the image output resolution used when the camera is connected to a television or external recording device with an HDMI cable.

---

## 1. Select [F: HDMI resolution].

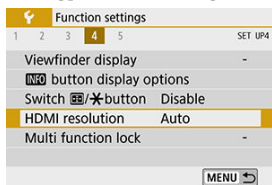

## 2. Select an item.

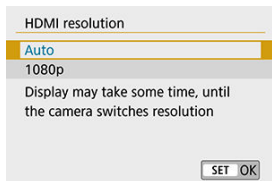

- **Auto**  
Images are automatically displayed at optimal resolution for connected televisions.
- **1080p**  
Output at 1080p resolution. Select if you prefer to avoid display or delay issues when the camera switches resolution.

# Multi-Function Lock

Specify camera controls to lock when the Multi-function lock is enabled. This can help prevent accidentally changing settings.

## 1. Select [: Multi function lock].

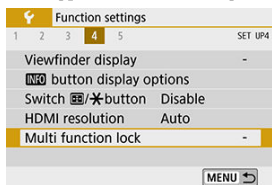

## 2. Select camera controls to lock.

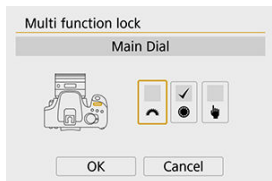

- Press <  > to add a checkmark [✓].
- Select [OK].
- The camera returns to shooting standby, and controls are now locked or unlocked each time you press the < LOCK > button.



## Note

- If it is changed from the default setting, an asterisk "\*" will be displayed on the right edge of [: **Multi function lock**].
- Setting details are reset when [**Clear all camera settings**] in [: **Clear settings**] is performed.
- You can also lock/unlock controls in shooting standby under the following conditions.
  - When displaying the electronic level
  - When the screen is off
  - When the screen is closed

- ☑ [Setting Custom Functions](#)
- ☑ [Custom Functions](#)
- ☑ [Custom Function Setting Items](#)

## Setting Custom Functions

### 1. Select [**C.Fn**: Custom Functions(C.Fn)].

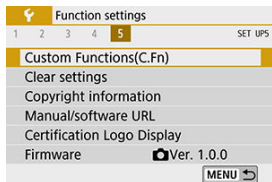

### 2. Select a Custom Function number.

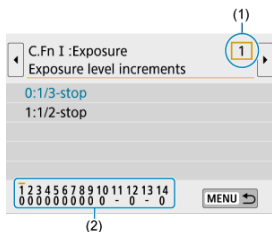

- Use the < ◀ ▶ > keys to select a function number (1), then press < SET >.
- Current Custom Function settings are indicated below the respective function number at the bottom of the screen (2).



### 3. Change the setting as desired.

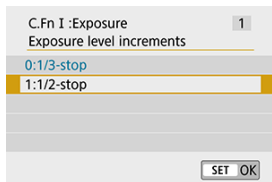

- Select a setting option.
- To set up another Custom Function, repeat steps 2–3.



#### Note

- To clear all Custom Function settings you have configured (except **[Custom Controls]**), select **[Clear all Custom Func. (C.Fn)]** in **[Fn: Clear settings]**.



## Custom Functions

Shaded Custom Functions do not function during Live View (LV) shooting or movie recording. (Settings are disabled.)



### ● C.Fn I: Exposure

		 LV Shooting	 Movie Recording
(1)	<a href="#">Exposure level increments</a>	○	○
(2)	<a href="#">ISO expansion</a>	○	○
(3)	<a href="#">ISO speed setting increments</a>	○	In < <b>M</b> > mode
(4)	<a href="#">Safety shift</a>	○	
(5)	<a href="#">Exposure comp. auto cancel</a>	○	○

### ● C.Fn II: Autofocus/Drive

		 LV Shooting	 Movie Recording
(1)	<a href="#">Auto AF pt sel.:EOS iTR AF</a>		
(2)	<a href="#">AF area selection method</a>	○	○
(3)	<a href="#">AF point display during focus</a>		
(4)	<a href="#">VF display illumination</a>		
(5)	<a href="#">Mirror lockup</a>		

### ● C.Fn III: Operation/Others

		 LV Shooting	 Movie Recording
(1)	<a href="#">Warnings  in viewfinder</a>		
(2)	<a href="#">Screen display when power ON</a>		
(3)	<a href="#">Custom Controls</a>	Varies by settings	
(4)	<a href="#">Retract lens on power off</a>	○	○

## Custom Function Setting Items

Custom Functions are organized into three groups based on the type of function: C.Fn I: Exposure, C.Fn II: Autofocus/Drive, C.Fn III: Operation/Others.

### C.Fn I: Exposure

#### C.Fn 1: Exposure level increments

Sets 1/2-stop increments for the shutter speed, aperture value, exposure compensation, AEB, flash exposure compensation, etc.

- 0:1/3-stop
- 1:1/2-stop

#### Note

- When set to [1:1/2-stop], exposure level display is as follows.



#### C.Fn 2: ISO expansion

Makes "H" (equivalent to ISO 25600) available as an ISO speed you can set. Note that "H" is not available when [📷: Highlight tone priority] is set to [Enable] or [Enhanced].

- 0:Disable
- 1:Enable

#### C.Fn 3: ISO speed setting increments

You can change the manual ISO speed setting increments to a whole-stop.

- 0:1/3-stop
- 1:1-stop

#### Note

- Even if [1:1-stop] is set, ISO speed will be automatically set in 1/3-stop increments when ISO Auto is set.

## C.Fn 4: Safety shift

You can shoot with the shutter speed and aperture value automatically adjusted to enable standard exposure if standard exposure would not be available under your specified shutter speed or aperture value in < **Tv** > or < **Av** > mode.

- **0:Disable**
- **1:Enable**

## C.Fn 5: Exposure comp. auto cancel

- **0:Enable**

When you set the power switch to < **OFF** >, the exposure compensation setting will be canceled.

- **1:Disable**

The exposure compensation setting will not be canceled even if you set the power switch to < **OFF** >.



### Note

- The exposure compensation setting is not canceled after auto power off, even when set to [**0:Enable**].

## C.Fn II: Autofocus/Drive

### C.Fn 6: Auto AF pt sel.:EOS iTR AF

Use this function to autofocus in viewfinder shooting by recognizing people. Applies when the AF area selection mode is set to [Manual select.:Zone AF], [Manual select.:Large Zone AF], or [Auto selection AF].

- **0:EOS iTR AF (Face priority)**

Faces are given greater priority than with [1:Enable] when the camera selects AF points automatically.

In [One-Shot AF] mode, this makes it easier to focus on faces of still human subjects in the AF area.

Also makes it easier to focus on faces in the AF area in [AI Servo AF] mode.

Once focus is achieved, AF points are automatically selected to keep focusing on the faces initially in focus.

- **1:Enable**

The camera selects AF points automatically based on AF information and information on recognized people.

In [One-Shot AF] mode, focusing on a still human subject in the AF area is made easier.

In [AI Servo AF] mode, focusing on a human subject in the AF area is made easier. If no people are detected, the camera focuses on the nearest subject. Once focus is achieved, AF points are automatically selected so that the camera continues to focus on the color of the area it focused on first.

- **2:Disable**





AF points are automatically selected based only on AF information.

#### Caution



- With a setting of [0:EOS iTR AF (Face priority)] or [1:Enable], focusing will take slightly longer than with setting [2:Disable].
- Even with a setting of [0:EOS iTR AF (Face priority)] or [1:Enable], the expected result may not be obtained depending on the shooting conditions and subject.
- Under low light, where external Speedlites for EOS cameras automatically emit an AF-assist beam, AF points are selected automatically based only on AF information. (Information on recognized people is not used for AF.)

## C.Fn 7: AF area selection method

### ● 0: → AF area selection button

After you press the <  > or <  > button in viewfinder shooting, pressing the <  > button changes the AF area selection mode. In Live View shooting, pressing the <  > button changes the AF method.

### ● 1: → Main Dial

After you press the <  > or <  > button, turning the  dial changes the AF area selection mode.

#### Note

- When [1:  → Main Dial] is set, use the < ◀ > < ▶ > keys to move the AF point horizontally.

## C.Fn 8: AF point display during focus

You can set whether to display AF points during AF point selection, before AF begins (shooting standby), when AF begins, during AF, and when subjects are in focus.

○: Displayed, ×: Not displayed



AF point display during focus	AF point selected	Before AF (shooting standby)	During AF	Focus achieved
0: Selected (constant)	○	○	○	○
1: All (constant)	○	○	○	○
2: Selected (pre-AF, focused)	○	○	×	○
3: Selected AF pt (focused)	○	×	×	○
4: Disable display	○	×	×	×

## C.Fn 9: VF display illumination

- **0:Auto**  
The AF points achieving focus in low light or with a dark subject will automatically light up in red.
- **1:Enable**  
The AF points light up in red regardless of the ambient light level.
- **2:Disable**  
The AF points do not light up in red.



### Note

- When you press the  or  button, the AF points will light up in red regardless of this setting.
- The aspect ratio lines, electronic level, and grid in the viewfinder will also light up in red.



## C.Fn 10: Mirror lockup



You can prevent the camera vibration blur due to the mechanical vibrations (mirror shock) inside the camera during shooting with super telephoto lenses or shooting close-ups (macro photography). See [Mirror Lockup](#) for the mirror lockup procedure.

- **0:Disable**
- **1:Enable**

## C.Fn III: Operation/Others

### C.Fn 11: Warnings in viewfinder

The  > icon can be displayed in the field of view of the viewfinder when any of the following functions are set .

Select the function for which you want the warning icon to appear, then press <  > to add a checkmark . Select **[OK]** to register the setting.



- **When monochrome  set**

If the : **Picture Style** is set to **[Monochrome]** , the warning icon will appear.



- **When WB is corrected**

The warning icon appears when white balance correction is set .

- **When  is set**

If : **High ISO speed NR** is set to **[Multi Shot Noise Reduction]** , the warning icon will appear.

#### Note

- If you set any of the checkmarked  functions,  will also appear for the respective setting displayed on the Creative Zone screen .

### C.Fn 12: Screen display when power ON

- **0:Display on**

When you turn on the power, the Quick Control screen will appear .

- **1:Previous display status**

When you turn on the power, the camera starts up with the same screen display as before the power was turned off. For this reason, if you turn off the camera with the screen off, the screen remains blank the next time the camera is turned on, which helps conserve battery power. The menu operations and image playback will be available as usual.



## C.Fn 13: Custom Controls

You can assign frequently used functions to camera buttons or dials according to your preferences for easy operations.

### 1. Select a camera control.

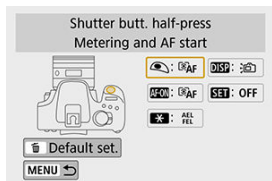

### 2. Select a function to assign.

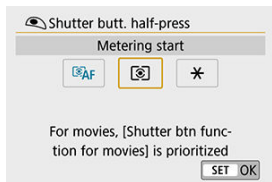



- Press <  > to set it.

#### Note





- With the screen in step 1 displayed, you can press the <  > button to restore the Custom Control settings to their defaults. [Custom Controls] settings are not cleared even if you select [Clear all Custom Func. (C.Fn)].

## Functions available for camera controls

### ● AF

Function			AF-ON	* *	DISP	SET
 AF	Metering and AF start	○	○	○		
AF-OFF	AF stop		○	○		

### ● Exposure

Function			AF-ON	* *	DISP	SET
	Metering start	○				
AEL FEL	AE lock/FE lock		○	○		
* *	AE lock (while button pressed)	○				
* *	AE lock		○	○		
FEL	FE lock		○	○		
	Expo comp (hold btn, turn  )					○
	Flash exp. comp					○







### ● Movies

Function			AF-ON	* *	DISP	SET
 SERVO AF	Pause Movie Servo AF				○	

### ● Image

Function			AF-ON	* *	DISP	SET
	Image quality					○

● **Operation**

Function			AF-ON		DISP	SET
	Screen On/Off				○	○
	Wi-Fi/Bluetooth connection				○	
	Maximize screen brightness (temp)				○	
MENU	Menu display					○
	Flash function settings					○
	Depth-of-field preview					○
OFF	No function (disabled)		○	○		○

### C.Fn 14: Retract lens on power off

You can set whether to retract gear-type STM lenses (such as EF40mm f/2.8 STM) automatically when the camera's power switch is set to <OFF>.

- **0:Enable**
- **1:Disable**

#### **Caution**

- With auto power off, the lens will not retract regardless of the setting.
- Before detaching the lens, make sure that it is retracted.

#### **Note**

- When [**0:Enable**] is set, this function takes effect regardless of the lens's focus mode switch setting (AF or MF).

The camera's shooting function settings and menu settings can be restored to their defaults. This option is available in Creative Zone modes.

---

## 1. Select [**☰**: Clear settings].

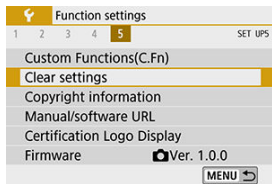

## 2. Select [Clear all camera settings].

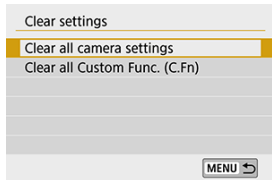

## 3. Select [OK].



 **Note**

- Performing [**Clear all camera settings**] also resets [**Multi function lock**] settings and the locked state of the <LOCK> button.

## ? FAQ

---

- **Clearing all camera settings**

After the procedure above, select [**Clear all Custom Func. (C.Fn)**] in [**Clear settings**] to clear all the Custom Function settings (🔗). Note that [**Custom Controls**] settings are not cleared.

☑ [Checking the Copyright Information](#)

☑ [Deleting the Copyright Information](#)

When you set the copyright information, it will be recorded to the image as Exif information.

## 1. Select [: Copyright information].

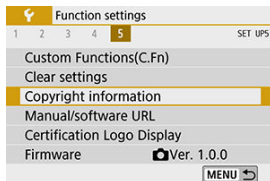





## 2. Select an item.

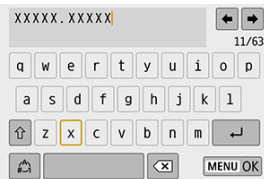

### 3. Enter text.



- Turn the <  > dial to select a character, then press <  > to enter it.
- By selecting [  ], you can change the input mode.
- To delete single characters, select [  ] or press the <  > button.

### 4. Exit the setting.

- Press the < **MENU** > button, then press [ **OK** ].

## Checking the Copyright Information

When you select [ **Display copyright info.** ] in step 2, you can check the [ **Author** ] and [ **Copyright** ] information that you entered.

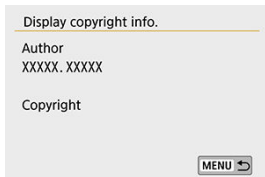

## Deleting the Copyright Information

---

When you select [**Delete copyright information**] in step 2, you can delete the [**Author**] and [**Copyright**] information.

### **Caution**

- If the entry for “Author” or “Copyright” is long, it may not be displayed entirely when you select [**Display copyright info.**].

### **Note**

- You can also set or check the copyright information with EOS Utility (EOS software).



## Other Information

---

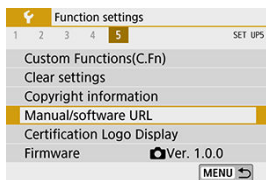

- **Manual/software URL**

To download instruction manuals, select [**F**: **Manual/software URL**] and scan the displayed QR code with a smartphone. You can also use a computer to access the website at the URL displayed and download software.

- **Certification Logo Display** ☆





Select [**F**: **Certification Logo Display**] to display some of the logos of the camera's certifications. Other certification logos can be found on the camera body and packaging.

- **Firmware** ☆

Select [**F**: **Firmware**] to update the firmware of the camera, lens, or other compatible accessories in use.

On the My Menu tab, you can register menu items and Custom Functions you often adjust.

## Caution

- When [: **Menu display**] is set to [**Guided**], the [] tab will not be displayed.  
Change [: **Menu display**] to [**Standard**] ().

- [Tab Menus: My Menu](#)
- [Registering My Menu](#)

## Tab Menus: My Menu

---

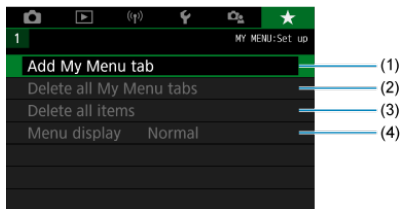

- (1) [Add My Menu tab](#)
- (2) [Delete all My Menu tabs](#)
- (3) [Delete all items](#)
- (4) [Menu display](#)

## Registering My Menu

---

- [Adding My Menu Tabs](#)
- [Registering Menu Items on My Menu Tabs](#)
- [My Menu Tab Settings](#)
- [Deleting All My Menu Tabs/Deleting All Items](#)
- [Menu display](#)

### Adding My Menu Tabs

---

1. Select [Add My Menu tab].

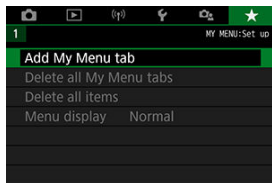

2. Select [OK].

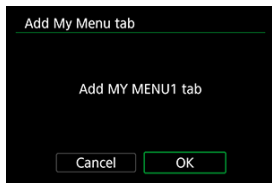

- You can create up to five My Menu tabs by repeating steps 1 and 2.

1. Select [MY MENU\*: Configure].



2. Select [Select items to register].

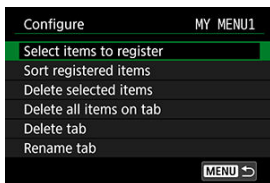

3. Register the desired items.

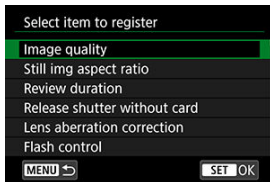

- Select an item, then press < (SET) >.
- Select [OK] on the confirmation screen.
- You can register up to six items.
- To return to the screen in step 2, press the < MENU > button.

## My Menu Tab Settings

You can sort and delete items under the menu tab, and rename or delete the menu tab.

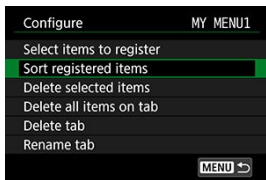

### Sort registered items

You can change the order of the registered items in My Menu. Select **[Sort registered items]**, select an item to rearrange, then press  $\langle \text{SET} \rangle$ . With  $\langle \blacktriangle \rangle$  displayed, turn the  $\langle \text{DIAL} \rangle$  dial to rearrange the item, then press  $\langle \text{SET} \rangle$ .

### Delete selected items/Delete all items on tab

You can delete any of the registered items. **[Delete selected items]** deletes one item at a time, and **[Delete all items on tab]** deletes all the registered items under the tab.

### Delete tab

You can delete the current My Menu tab. Select **[Delete tab]** to delete the **[MY MENU\*]** tab.

#### Caution

- Performing **[Delete tab]** will also clear tab names renamed with **[Rename tab]**.

## Rename tab

You can rename the My Menu tab from **[MY MENU\*]**.

1. Select **[Rename tab]**.

2. Enter text.

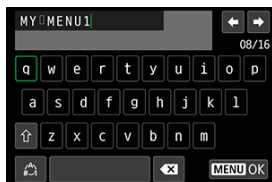

- Select **[X]** or press the **< [X] >** button to delete any unneeded characters.
- Turn the **⊙** dial to select a character, then press **< [SET] >**.
- By selecting **[↕]**, you can change the input mode.

3. Confirm input.

- Press the **< MENU >** button, then select **[OK]**.

## Deleting All My Menu Tabs/Deleting All Items

You can delete all the created My Menu tabs or My Menu items registered under them.

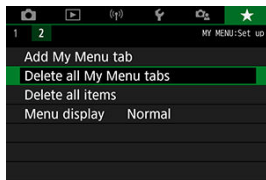

### Delete all My Menu tabs

You can delete all My Menu tabs you created. When you select [**Delete all My Menu tabs**], all the tabs from [**MY MENU1**] to [**MY MENU5**] will be deleted and the [**★**] tab will revert to its default.

#### ! Caution

- Performing [**Delete all My Menu tabs**] will also clear tab names renamed with [**Rename tab**].

### Delete all items

You can delete all the items registered under the [**MY MENU1**] to [**MY MENU5**] tabs. The tab(s) will remain. When [**Delete all items**] is selected, all the items registered under all the created tabs will be deleted.



## Menu display

You can select **[Menu display]** to set the menu screen that is to appear first when you press the < MENU > button.

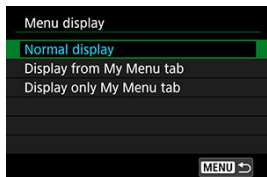

- **Normal display**  
Displays the last displayed menu screen.
- **Display from My Menu tab**  
Displays with the [★] tab selected.
- **Display only My Menu tab**  
Restricts display to the [★] tab ([📷]/[▶]/[(Ⓟ)]/[👤]/[👤] tabs are not displayed).

## Reference

---

This chapter provides reference information on camera features.

- [Importing Images to a Computer](#)
- [Household Power Outlet Accessory](#)
- [Troubleshooting Guide](#)
- [Error Codes](#)
- [System Map](#)
- [ISO Speed in Movie Recording](#)
- [Information Display](#)
- [AF Sensor](#)
- [Compatible Lenses and Autofocusing \(Viewfinder Shooting\)](#)
- [Specifications](#)

## Importing Images to a Computer

---

[Connecting to a Computer via an Interface Cable \(Sold Separately\)](#)

[Card Reader](#)

[Connecting to a Computer via Wi-Fi](#)

You can use EOS software to import images from the camera to a computer. There are three ways to do this.

---

### Connecting to a Computer via an Interface Cable (Sold Separately)

---

1. Install the software ([📄](#)).
2. Connect the camera to the computer with an interface cable (sold separately).

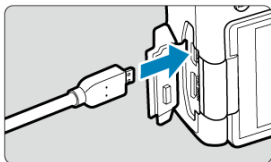

- As an interface cable, you can use a IFC-600PCU cable (sold separately).
  - Insert the cord's plug into the camera's digital terminal (USB Micro-B).
  - Connect the cord's plug to the computer's USB terminal (USB Type-A).
3. Use EOS Utility to import the images.
    - Refer to the EOS Utility Instruction Manual.

## Caution

- With Wi-Fi connection established, the camera cannot communicate with the computer even if they are connected with an interface cable.

## Card Reader

You can use a card reader to import images to a computer.

1. Install the software (📄).
2. Insert the card into the card reader.

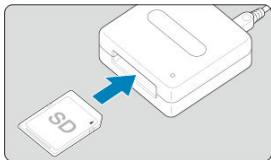

3. Use Digital Photo Professional to import the images.

- Refer to the Digital Photo Professional Instruction Manual.

## Note

- When downloading images from the camera to a computer with a card reader without using EOS software, copy the DCIM folder on the card to the computer.

## Connecting to a Computer via Wi-Fi

You can connect the camera to the computer via Wi-Fi and import images to the computer (📄).

## Household Power Outlet Accessory

---

You can power the camera with a household power outlet by using the DC Coupler DR-E18 and AC Adapter AC-E6N (each sold separately).

---

### 1. Connect the DC coupler's plug.

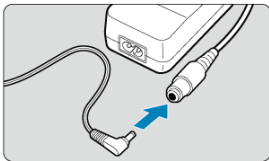

- Connect the DC coupler's plug to the AC Adapter's socket.

### 2. Connect the power cord.

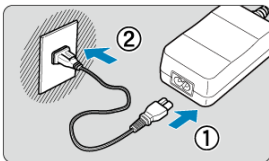

- Connect the power cord as shown in the illustration.
- After using the camera, unplug the power plug from the power outlet.

### 3. Insert the DC coupler.

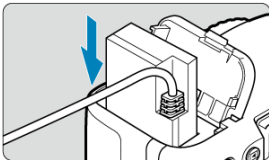

- Open the battery compartment cover and insert the DC coupler securely until it locks.

#### 4. Pull the DC cord through the hole.

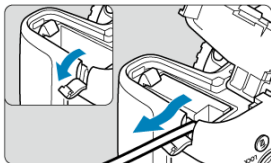

- Open the DC cord hole cover and pass the cord through as shown.
- Close the battery compartment cover.

#### Warning

- Do not connect or disconnect the power cord when the camera's power switch is set to <ON>.

# Troubleshooting Guide

---

- [!\[\]\(6841ca9b0e023296428e7c9e683b9367\_img.jpg\) Power-related problems](#)
- [!\[\]\(e258e347e7683f87061f627f84598eb5\_img.jpg\) Shooting-related problems](#)
- [!\[\]\(1233990ad3f0b7475c568d7bf16af31f\_img.jpg\) Problems with wireless features](#)
- [!\[\]\(18570b67a4686b081406cd3de636c1c3\_img.jpg\) Operation problems](#)
- [!\[\]\(411af059a517db12f1097bc63c4fbe36\_img.jpg\) Display problems](#)
- [!\[\]\(ed2b7fb1e3bd6514676d2ab3c70d5776\_img.jpg\) Playback problems](#)
- [!\[\]\(63f22f364560f085b88206f094473649\_img.jpg\) Sensor cleaning problems](#)
- [!\[\]\(1167d0d640d4660b041f4c30896eb62c\_img.jpg\) Computer connection problems](#)

If a problem occurs with the camera, first refer to this Troubleshooting Guide. If this Troubleshooting Guide does not resolve the problem, contact your dealer or nearest Canon Service Center.

## Power-related problems

### The battery does not charge.

---

- If the battery's remaining capacity (🔋) is 94% or higher, the battery will not be charged.
- Do not use any battery packs other than a genuine Canon Battery Pack LP-E17.

### The charger's lamp blinks at high speed.

---

- If (1) the battery charger or battery has a problem or (2) communication with the battery failed (with a non-Canon battery pack), the protection circuit will stop charging, and the charge lamp will blink in orange at a constant high speed. In the case of (1), unplug the charger's power plug from the power outlet. Detach and reattach the battery to the charger. Wait a few minutes, then reconnect the power plug to the power outlet. If the problem persists, contact your dealer or nearest Canon Service Center.

### The charger's lamp does not blink.

---

- If the internal temperature of the battery attached to the charger is high, the charger will not charge the battery for safety reasons (lamp off). During charging, if the battery's temperature becomes high for any reason, charging will stop automatically (lamp blinks). When the battery temperature goes down, charging will resume automatically.

### The camera is not activated even when the power switch is set to <ON>.

---

- Make sure the battery compartment cover is closed (🔋).
- Make sure the battery is installed properly in the camera (🔋).
- Charge the battery (🔋).
- Make sure the card slot cover is closed (🔋).

### The access lamp still lights or blinks even when the power switch is set to <OFF>.

---

- If the power is turned off while an image is being recorded to the card, the access lamp will remain on or continue to blink for a few seconds. When the image recording is complete, the power will turn off automatically.

### [Battery communication error. Does this battery/do these batteries display the Canon logo?] is displayed.

---

- Do not use any battery packs other than a genuine Canon Battery Pack LP-E17.
- Remove and install the battery again (🔋).
- If the electrical contacts are dirty, use a soft cloth to clean them.



## The battery becomes exhausted quickly.

---

- Use a fully charged battery (🔋).
- The battery performance may have degraded. See [🔋: **Battery info.**] to check the battery's recharge performance level (🔋). If the battery performance is poor, replace the battery with a new one.
- The number of available shots will decrease with any of the following operations:
  - Pressing the shutter button halfway for a prolonged period.
  - Activating the AF frequently without taking a picture.
  - Using the lens's Image Stabilizer.
  - Using the screen frequently.
  - Continuing Live View shooting or movie recording for a prolonged period.
  - Using the wireless communication functions.

## The camera turns off by itself.

---

- Auto power off is in effect. If you do not want auto power off to take effect, set [🔋: **Auto power off**] to [Disable] (🔋).
- Even if [🔋: **Auto power off**] is set to [Disable], the screen will still turn off after the camera is left idle for approx. 30 min. (The camera's power does not turn off.)

## Shooting-related problems

### The lens cannot be attached.

---

- The camera cannot be used with RF or EF-M lenses (🔗).

### The viewfinder is dark.

---

- Install a charged battery in the camera (🔗).

### No images can be shot or recorded.

---

- Make sure the card is properly inserted (🔗).
- Slide the card's write-protect switch to the Write/Erase setting (🔗).
- If the card is full, replace the card or delete unnecessary images to make space (🔗, 🔗).
- Shooting is not possible during One-Shot AF when the focus indicator < ● > in the viewfinder is blinking, or when the AF point is orange during Live View shooting or movie recording. Press the shutter button halfway again to refocus automatically, or focus manually (🔗, 🔗).

### The card cannot be used.

---

- If a card error message is displayed, see [Removal](#).

### An error message is displayed when the card is inserted in another camera.

---

- Since SDXC cards are formatted in exFAT, if you format a card with this camera and then insert it into another camera, an error may be displayed and it may not be possible to use the card.

### I have to press the shutter button twice to take a picture.

---

- Set [10: Mirror lockup] in [🔗: Custom Functions(C.Fn)] to [0:Disable] (🔗).

## The image is out of focus or blurred.

---

- Set the lens's focus mode switch to < AF > (🔍).
- Press the shutter button (🔍) gently to prevent camera shake (🔍).
- With a lens equipped with an Image Stabilizer, set the Image Stabilizer switch to < ON >.
- In low light, the shutter speed may become slow. Use a faster shutter speed (🔍), set a higher ISO speed (🔍), use flash (🔍, 🔍), or use a tripod.
- See [Minimizing blurred photos](#).

## There are fewer AF points or the Area AF frame shape is different.

---

- The number of available AF points, the focusing patterns, and the Area AF frame shape vary by lens.

## The AF point is blinking.

---

- For details on AF points lighting up or blinking when you press the < [AF-ON] > or < [AF-ON] > button, see [Meaning of Lit or Blinking AF Points](#).

## The AF points do not light up in red.

---

- The AF points light up in red when you shoot under low light or when focus is achieved on a dark subject.
- In the < P >, < Tv >, < Av >, or < M > mode, you can set whether to have the AF points light up in red for when focus is achieved (🔍).

## I cannot lock the focus and recompose the shot.

---

- Set the AF operation to One-Shot AF. Focus lock is not possible in the AI Servo AF/Servo AF mode and when servo takes effect in AI Focus AF mode (🔍, 🔍).

## The continuous shooting speed is slow.

---

- The continuous shooting speed for high-speed continuous shooting may be lower, depending on conditions such as these: temperature, battery level, flicker reduction, shutter speed, aperture value, subject conditions, brightness, AF operation, type of lens, live view shooting, use of flash, and shooting settings, etc. For details, see [Drive Mode](#).

## The maximum burst during continuous shooting is lower.

---

- If you shoot a subject that has fine detail such as a field of grass, the file size will be larger, and the actual maximum burst may be lower than the number listed in [Still photo file size / Number of possible shots / Maximum burst for continuous shooting](#).



## Even after I change the card, the maximum burst displayed for continuous shooting does not change.

---

- The maximum burst displayed does not change when you switch cards, even if you switch to a high-speed card. The maximum burst shown in the table on [Still photo file size / Number of possible shots / Maximum burst for continuous shooting](#) is based on Canon's testing card. (The faster the card's writing speed, the higher the actual maximum burst will be.) For this reason, the maximum burst displayed may differ from the actual maximum burst.

## Even if I set a decreased exposure compensation, the image comes out bright.

---

- Set [: Auto Lighting Optimizer] to [Disable] (). When [Low], [Standard], or [High] is set, even if you set a decreased exposure compensation or flash exposure compensation, the image may come out bright.

## I cannot set the exposure compensation when both manual exposure and ISO Auto are set.

---

- See [Exposure Compensation with ISO Auto](#) to set the exposure compensation.

## Not all the lens aberration correction options are displayed.

---

- Although [**Chromatic aberr corr**] and [**Diffraction correction**] are not displayed when [**Digital Lens Optimizer**] is set to [**Enable**], both functions are applied in shooting, as when set to [**Enable**].
- During movie recording, [**Digital Lens Optimizer**], [**Diffraction correction**], or [**Distortion correction**] will not be displayed.

## The built-in flash does not fire.

---

- Shooting with the flash may be temporarily disabled to protect the flash head if the built-in flash is used repeatedly over a short period.

## **The external Speedlite does not fire.**

---

- Make sure the external Speedlite is securely attached to the camera.

## **The Speedlite always fires at full output.**

---

- If you use a flash unit other than an EL/EX series Speedlite, the flash will always fire at full output (🔒).
- The flash always fires at full output when [Flash metering mode] in external flash Custom Function settings is set to [TTL flash metering] (autoflash) (🔒).



## **Flash exposure compensation cannot be set for the external Speedlite.**

---

- If flash exposure compensation is set with the external Speedlite, compensation amount cannot be set with the camera. When the external Speedlite's flash exposure compensation is canceled (set to 0), flash exposure compensation can be set with the camera.

## **Remote control shooting is not possible.**

---

- When taking still photos, set the drive mode to <  > or <  > (🔒). When recording movies, set [: Remote control] to [Enable] (🔒).
- Check the position of the remote control's release timing switch.
- If you are using Wireless Remote Control BR-E1, see [Wireless Remote Control BR-E1](#).
- To use a remote control for time-lapse movie recording, see [Time-Lapse Movies](#).

## **I cannot shoot with Live View.**

---

- Set [: Live View shoot.] to [Enable].

## **The shutter makes two release sounds during Live View shooting.**

---

- If you use flash with Live View shooting, the shutter will make two release sounds each time you shoot.



## **The electronic level is not displayed in Live View shooting.**

---

- The electronic level is not displayed in Live View shooting when the AF method is set to [+Tracking].



## During Live View shooting, a white or red icon is displayed.

---

- It indicates that the camera's internal temperature is high. Image quality of still photos may be worse when a white  icon is displayed. If the red  icon is displayed, it indicates that the Live View shooting will soon stop automatically ().



## Expanded ISO speeds cannot be selected for still photo shooting.

---

- Check the [ISO speed] setting under [:  ISO speed settings].
- Expanded ISO speeds are not available when [: Highlight tone priority] is set to [Enable] or [Enhanced].

## During movie recording, the red icon is displayed.

---

- It indicates that the camera's internal temperature is high. If the red  icon is displayed, it indicates that the movie recording will soon stop automatically ().

## Movie recording stops by itself.

---

- If the card's writing speed is slow, movie recording may stop automatically. For cards that can record movies, see [Card performance requirements](#). To find out the card's writing speed, refer to the card manufacturer's website, etc.
- If you record a movie for 29 min. 59 sec., the movie recording will stop automatically.







## The ISO speed cannot be set for movie recording.

---

- In shooting modes other than < **M** >, the ISO speed is set automatically. In < **M** > mode, you can manually set the ISO speed ().

## The manually set ISO speed changes when switching to movie recording.

---

- [ISO speed] in [:  ISO speed settings] () applies to viewfinder shooting and Live View shooting, and [ISO speed] in [:  ISO speed settings] () applies to movie recording.

## **Expanded ISO speeds cannot be selected for movie recording.**

---

- Check the [ISO speed] setting under [📷:  ISO speed settings].
- Expanded ISO speeds are not available when [📷: Highlight tone priority] is set to [Enable].

## **The exposure changes during movie recording.**

---

- If you change the shutter speed or aperture value during movie recording, the changes in the exposure may be recorded.
- Recording a few test movies is recommended if you intend to perform zooming during movie recording. Zooming as you record movies may cause exposure changes or lens sounds to be recorded, an uneven audio level, or loss of focus.

## **The image flickers or horizontal stripes appear during movie recording.**

---

- Flickering, horizontal stripes (noise), or irregular exposures can be caused by fluorescent lighting, LED lighting, or other light sources during movie recording. Also, changes in the exposure (brightness) or color tone may be recorded. In < **M** > mode, using a slower shutter speed may reduce the problem. The problem may be more noticeable in time-lapse movie recording.

## **The subject looks distorted during movie recording.**

---

- If you move the camera to the left or right (panning) or shoot a moving subject, the image may look distorted.

## **I cannot take still photos during movie recording.**

---

- Still photos cannot be taken during movie recording. To take still photos, stop the movie recording and perform viewfinder shooting or Live View shooting.

### **Cannot pair with a smartphone.**

---

- Use a smartphone compliant with Bluetooth Specification Version 4.1 or later.
- Turn on Bluetooth from the smartphone settings screen.
- Pairing with the camera is not possible from the smartphone's Bluetooth settings screen. Install the dedicated app Camera Connect (free of charge) on the smartphone (📲).
- A previously paired smartphone cannot be paired with the camera again if the camera's registration is retained on the smartphone. In this case, remove the camera's registration retained in the Bluetooth settings on the smartphone and try pairing again (📲).

### **Wi-Fi function cannot be set.**

---

- If the camera is connected to a computer or another device with an interface cable, Wi-Fi functions cannot be set. Disconnect the interface cable before setting any functions (📲).

### **A device connected with an interface cable cannot be used.**

---

- Other devices, such as computers, cannot be used with the camera by connecting them with an interface cable while the camera is connected to devices via Wi-Fi. Terminate the Wi-Fi connection before connecting the interface cable.

### **Operations such as shooting and playback are not possible.**

---

- With a Wi-Fi connection established, operations such as shooting and playback may not be possible. Terminate the Wi-Fi connection, then perform the operation.

### **Cannot reconnect to a smartphone.**

---



- Even with a combination of the same camera and smartphone, if you have changed the settings or selected a different setting, reconnection may not be established even after selecting the same SSID. In this case, delete the camera connection settings from the Wi-Fi settings on the smartphone and set up a connection again.
- A connection may not be established if Camera Connect is running when you reconfigure connection settings. In this case, quit Camera Connect for a moment and then restart it.



## Operation problems





### Settings cannot be adjusted with the < > or < > dial.

---

- Press the < **LOCK** > button to unlock the controls ().
- Check the [: **Multi function lock**] setting ().







### Touch operation is not possible.

---

- Make sure [: **Touch control**] is set to [**Standard**] or [**Sensitive**] ().
- Check the [: **Multi function lock**] setting ().

### A camera button or dial does not work as expected.

---

- Check these settings: [: **Switch /✕ button**], as well as [**AF area selection method**] and [**Custom Controls**] in [: **Custom Functions(C.Fn)**] (, ).
- For movie recording, check the [**Shutter btn function for movies**] setting (, ).

## Display problems

### The menu screen shows fewer tabs and items.

---

- Certain tabs and options do not appear in Basic Zone or for Live View shooting and movie recording.

### The display starts with [★] My Menu, or the [★] tab alone is displayed.

---

- [Menu display] on the [★] tab is set to [Display from My Menu tab] or [Display only My Menu tab]. Set [Normal display] (🔗).

### The file name's first character is an underscore (“\_”).

---

- Set [📷: Color space] to [sRGB]. If [Adobe RGB] is set, the first character will be an underscore (🔗).

### The file name starts with “MVI\_”.

---

- It is a movie file (🔗).

### The file numbering does not start from 0001.

---

- If the card already contains recorded images, the image number may not start from 0001 (🔗).

### The shooting date and time displayed are incorrect.

---

- Make sure the correct date and time are set (🔗).
- Check the time zone and daylight saving time (🔗).

### The date and time are not in the image.

---

- The shooting date and time do not appear in the image. The date and time are recorded in the image data as shooting information. When printing, you can imprint the date and time in the picture, using the date and time recorded in the shooting information (🔗).

### [###] is displayed.

---

- If the number of images recorded on the card exceeds the number the camera can display, [###] will be displayed.

### **In the viewfinder, the AF point display speed is slow.**

---

- In low temperatures, the display speed of the AF points may become slower due to the AF point display device's (liquid crystal) characteristics. The display speed will return to normal at room temperature.

### **The screen does not display a clear image.**

---

- If the screen is dirty, use a soft cloth to clean it.
- The screen display may seem slightly slow in low temperatures or may look black in high temperatures. It will return to normal at room temperature.

## Playback problems

### A red box is displayed on the image.

---

- [▶]: **AF point disp.**] is set to [Enable] (🔗).

### During image playback, the AF points are not displayed.

---

- The AF points are not displayed when the following types of images are played back:
  - Images taken in < **SCN** : 📷 📷 > mode.
  - Images taken in < 📷 : 📷HDR 📷HDR 📷HDR 📷HDR > mode.
  - Images taken with Multi Shot Noise Reduction applied.
  - Cropped images.

### The image cannot be erased.

---

- If the image is protected, it cannot be erased (🔗).

### Still photos and movies cannot be played back.

---

- The camera may not be able to play back images taken with another camera.
- Movies edited with a computer cannot be played back with the camera.

### Only few images can be played back.

---

- The images have been filtered for playback with [▶]: **Set image search conditions**] (🔗). Clear the image search conditions.

### Mechanical sounds or sounds of camera operations can be heard during movie playback.

---

- The camera's built-in microphone will also record mechanical sounds of the lens or sounds of camera/lens operations if AF operations are performed or the camera is operated during movie recording. In this case, using an external microphone may reduce these sounds. If the sounds are still distracting with an external microphone, it may be more effective to remove the external microphone from the camera and position it away from the camera and lens (🔗).

## **The movie appears to freeze momentarily.**

---

- If there is a drastic change in the exposure level during autoexposure movie recording, the recording will stop momentarily until the brightness stabilizes. In such a case, shoot in the < **M** > mode (🔗).

## **No picture appears on the television.**

---

- Make sure [**🔗: Video system**] is set to [**For NTSC**] or [**For PAL**] correctly for the video system of your television.
- Make sure the HDMI cable's plug is inserted all the way in (🔗).

## **There are multiple movie files for a single movie recording.**

---

- If the movie file size reaches 4 GB, another movie file will be created automatically (🔗). However, if you use an SDXC card formatted with the camera, you can record a movie in a single file even if it exceeds 4 GB.

## **My card reader does not recognize the card.**

---

- Depending on the card reader used and the computer's operating system, SDXC cards may not be correctly recognized. In this case, either connect the camera to a computer with an interface cable (sold separately) and use EOS Utility (EOS software, 🔗) or connect the camera to a computer via Wi-Fi (🔗) to import the images on the camera.

## **The image cannot be resized.**

---

- With this camera, you cannot resize JPEG **S2** and RAW images (🔗).

## **The image cannot be cropped.**

---

- With this camera, you cannot crop RAW images (🔗).

## **Dots of light appear on the image.**



---

- White, red, or blue dots of light may appear in captured images if the sensor is affected by cosmic rays or similar factors. Their appearance may be reduced by performing [**Clean now**, 🗑️] under [**🔗: Sensor cleaning**] (🔗).

## Sensor cleaning problems



### The shutter makes a sound during sensor cleaning.

---

- Under [: **Sensor cleaning**], when you select [**Clean now**, ], the shutter will make a mechanical sound during the cleaning, but no picture will be recorded to the card ().

### Automatic sensor cleaning does not work.

---

- If you repeatedly turn the power switch < **ON** > and < **OFF** > within a short time period, the <  > icon may not be displayed ().

## Computer connection problems



### I cannot import images to a computer.

---

- Install EOS Utility (EOS software) on the computer ().
- If the camera is already connected via Wi-Fi, it cannot communicate with any computer connected with an interface cable (sold separately).

### Communication between the connected camera and computer does not work.

---

- When using EOS Utility (EOS software), set [: **Time-lapse movie**] to [**Disable**] ().

## Error Codes

---

If there is a problem with the camera, an error message will appear. Follow the on-screen instructions. If the problem persists, write down the error code (Err xx) and contact a Canon Service Center.

---

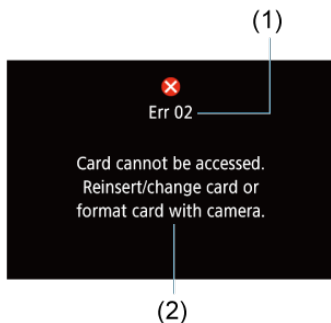

(1) Error number

(2) Cause and countermeasures

## System Map

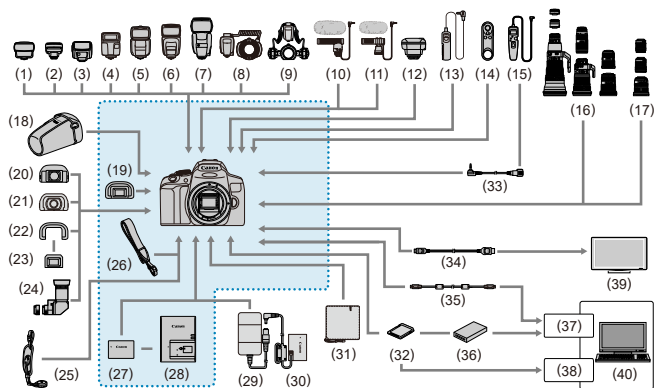

**Bundled accessories**

- (1) Speedlite Transmitter ST-E2
- (2) Speedlite Transmitter ST-E3-RT
- (3) Speedlite 270EX II
- (4) Speedlite EL-100
- (5) Speedlite 430EX III-RT/430EX III
- (6) Speedlite 470EX-AI
- (7) Speedlite 600EX II-RT
- (8) Macro Ring Lite MR-14EX II
- (9) Macro Twin Lite MT-26EX-RT
- (10) Directional Stereo Microphone DM-E1
- (11) Stereo Microphone DM-E100
- (12) GPS Receiver GP-E2<sup>1</sup>
- (13) Remote Switch RS-60E3
- (14) Wireless Remote Control BR-E1
- (15) Timer Remote Controller TC-80N3
- (16) EF lenses
- (17) EF-S lenses
- (18) Semi Hard Case EH26-L/EH27-L
- (19) Eyecup<sup>2</sup>
- (20) Eyepiece Extender EP-EX15 II



(21)	Magnifier MG-Ef
(22)	Rubber Frame Ef
(23)	E-series Dioptic Adjustment Lenses
(24)	Angle Finder C
(25)	Hand Strap E2
(26)	Strap
(27)	Battery Pack LP-E17
(28)	Battery Charger LC-E17
(29)	AC Adapter AC-E6N <sup>3</sup>
(30)	DC Coupler DR-E18 <sup>3</sup>
(31)	Protecting Cloth PC-E1/E2
(32)	SD/SDHC/SDXC memory cards
(33)	Remote Controller Adapter RA-E3 <sup>4</sup>
(34)	HDMI Cable HTC-100 (approx. 2.9m/9.5 ft.)
(35)	Interface Cable IFC-600PCU (approx. 1.0 m/3.3 ft.) <sup>5</sup>
(36)	Card reader
(37)	USB port
(38)	Card slot
(39)	TV/monitor
(40)	Computer

\* 1: Images cannot be tagged with the shooting direction by this camera. Also note that connection via an interface cable is not supported.

\* 2: Eyecup Ef (sold separately) can also be used.

\* 3: AC Adapter Kit ACK-E18 can also be used.





\* 4: Compatible remote control: TC-80N3. Other remote controls cannot be used.

\* 5: Camera end: USB Micro-B; computer end: USB Type-A.









## ISO Speed in Movie Recording

---

### In < > mode

- The ISO speed will be set automatically within ISO 100–12800.
- To expand the maximum available ISO speed in the automatic setting range to H (equivalent to ISO 25600; ), set [Max for Auto] in [:  ISO speed settings] to [H(25600)] with [2: ISO expansion] in [: Custom Functions(C.Fn)] set to [1:Enable] ().

### In < M > mode

- With ISO speed set to [AUTO], the speed is automatically set in a range of ISO 100–12800.
- To expand the maximum available ISO speed in the automatic setting range to H (equivalent to ISO 25600; ) when ISO Auto is specified, set [Max for Auto] in [:  ISO speed settings] to [H(25600)] with [2: ISO expansion] in [: Custom Functions(C.Fn)] set to [1:Enable] ().
- ISO speed can be set manually in a range of ISO 100–12800. Note that you can expand the maximum available speed in the manual setting range to H (equivalent to ISO 25600) by setting [Max for Auto] in [:  ISO speed settings] to [H(25600)] ().

#### Caution

- [H(25600)] is not available when recording 4K movies or 4K time-lapse movies.

## Information Display

---

- [Quick Control Screen \(in Viewfinder Shooting\)](#)
- [Live View Shooting Screen](#)
- [Movie Recording Screen](#)
- [Scene Icons](#)
- [Playback Screen](#)

## Quick Control Screen (in Viewfinder Shooting)

Each time you press the <INFO> button, the information display will change.

- The display will show only the settings currently applied.

### When set to [M]: Shooting screen: Guided]

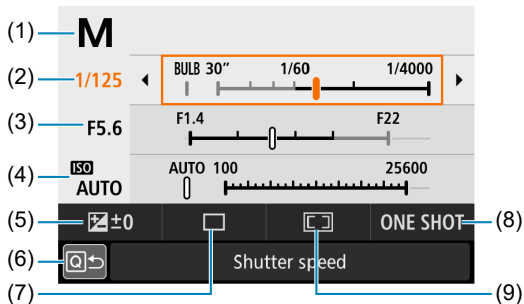

- (1) Shooting mode\*
- (2) Shutter speed
- (3) Aperture value
- (4) ISO speed
- (5) Exposure compensation
- (6) Return
- (7) Drive mode
- (8) AF operation
- (9) AF area selection mode

\* These functions cannot be set with Quick Control.

## When set to [Q]: Shooting screen: Standard

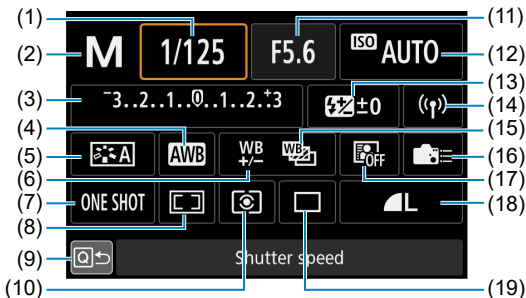

(1) Shutter speed

(2) Shooting mode\*

(3) Exposure compensation/AEB setting

(4) White balance

(5) Picture Style

(6) White balance correction

(7) AF operation

(8) AF area selection mode

(9) Return

(10) Metering mode

(11) Aperture value

(12) ISO speed

(13) Flash exposure compensation

(14) Wi-Fi/Bluetooth connection

(15) White balance bracketing

(16) Custom Controls

(17) Auto Lighting Optimizer

(18) Image quality

(19) Drive mode

\* These functions cannot be set with Quick Control.

## Live View Shooting Screen

Each time you press the <INFO> button, the information display will change.

- The display will show only the settings currently applied.

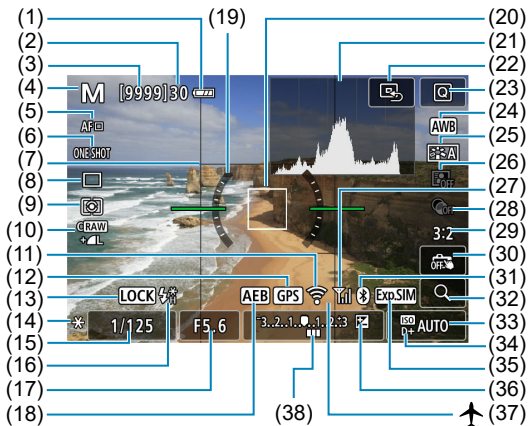

- 
- (1) Battery level
  - (2) Maximum burst
  - (3) Available shots/Sec. until self-timer shoots
  - (4) Shooting mode/Scene icon
  - (5) AF method
  - (6) AF operation
  - (7) Grid
  - (8) Drive mode
  - (9) Metering mode
  - (10) Image quality
  - (11) Wi-Fi function
  - (12) GPS acquisition status
  - (13) Multi-function lock
  - (14) AE lock
  - (15) Shutter speed/Multi-function lock warning
  - (16) Warning to use flash (blinking)/Flash ready (on)/FE lock/High-speed sync
  - (17) Aperture value
  - (18) AEB/FEB
  - (19) Electronic level
  - (20) AF point (1-point AF)
  - (21) Histogram
  - (22) Set AF point to center
  - (23) Quick Control button
  - (24) White balance/White balance correction
  - (25) Picture Style
  - (26) Auto Lighting Optimizer
  - (27) Wi-Fi signal strength
  - (28) Creative filters
  - (29) Still image aspect ratio
  - (30) Touch Shutter
  - (31) Bluetooth function
  - (32) Magnify button
  - (33) ISO speed
  - (34) Highlight tone priority
  - (35) Exposure simulation
  - (36) Exposure compensation
  - (37) Airplane mode
  - (38) Exposure level indicator
-



#### Note

- You can specify the information displayed in response to pressing the < INFO > button (📄).
- The electronic level is not displayed when [AF method] is set to [L+Tracking] or the camera is connected via HDMI to a television.
- Other icons may be displayed temporarily after setting adjustments.



## Movie Recording Screen

Each time you press the <INFO> button, the information display will change.

- The display will show only the settings currently applied.

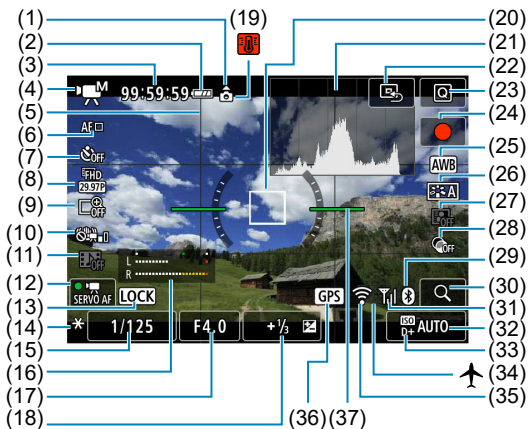

- 
- (1) Movie orientation information
  - (2) Battery level
  - (3) Movie recording time available/Elapsed recording time
  - (4) Movie recording mode
  - (5) Grid
  - (6) AF method
  - (7) Movie self-timer
  - (8) Movie recording size
  - (9) Digital zoom
  - (10) Movie digital IS
  - (11) Video snapshot
  - (12) Movie Servo AF
  - (13) Multi-function lock
  - (14) AE lock
  - (15) Shutter speed/Multi-function lock warning
  - (16) Audio recording level indicator (manual/line input)
  - (17) Aperture value
  - (18) Exposure compensation
  - (19) Temperature warning
  - (20) AF point (1-point AF)
  - (21) Histogram (for manual exposure)
  - (22) Set AF point to center
  - (23) Quick Control button
  - (24) Movie recording start button
  - (25) White balance/White balance correction
  - (26) Picture Style
  - (27) Auto Lighting Optimizer
  - (28) Creative filters
  - (29) Bluetooth function
  - (30) Magnify button
  - (31) Wi-Fi signal strength
  - (32) ISO speed
  - (33) Highlight tone priority
  - (34) Airplane mode
  - (35) Wi-Fi function
  - (36) GPS acquisition status
  - (37) Electronic level
-

### Warning





























- You can specify the information displayed in response to pressing the < INFO > button (🔍).
- The electronic level is not displayed when [AF method] is set to [📷+Tracking] or the camera is connected via HDMI to a television.
- The electronic level, grid lines, or histogram cannot be displayed during movie recording. (The display will disappear when you start recording a movie.)
- When movie recording starts, the movie recording remaining time will change to the elapsed time.

### Note

- Other icons may be displayed temporarily after setting adjustments.

## Scene Icons

In <  > shooting mode, the camera detects the type of scene and sets all settings accordingly. The detected scene type is indicated on the upper left of the screen.

Background \ Subject	Portrait		Non-Portrait			Background Color
		In Motion <sup>*1</sup>	Nature/Outdoor Scene	In Motion <sup>*1</sup>	Close <sup>*2</sup>	
Bright						Gray
Backlit						
Blue Sky Included						Light blue
Backlit						
Sunset	*3				*3	Orange
Spotlight						Dark blue
Dark						
With Tripod <sup>*1</sup>		*3		*3		

\* 1: Not displayed during movie recording.

\* 2: Displayed when the attached lens has distance information. With an extension tube or close-up lens, the icon displayed may not match the actual scene.

\* 3: The icon of the scene selected from the detectable scenes will be displayed.

### Warning

- For certain scenes or shooting conditions, the icon displayed may not match the actual scene.

\* 4: Displayed when all the following conditions apply:

The shooting scene is dark, it is a night scene, and the camera is mounted on a tripod.

\* 5: Displayed with any of the lenses below:

- EF-S18-55mm f/3.5-5.6 IS II
- EF-S55-250mm f/4-5.6 IS II
- EF300mm f/2.8L IS II USM
- EF400mm f/2.8L IS II USM
- EF500mm f/4L IS II USM
- EF600mm f/4L IS II USM
- Image Stabilizer lenses released in and after 2012.

\* 4+\*5: If the conditions in both \*4 and \*5 are met, the shutter speed will slow down.

## Playback Screen

### Basic information display for still photos



- |      |  |
|------|--|
| (1)  | Bluetooth function                                 |
| (2)  | Wi-Fi function                                     |
| (3)  | Airplane mode                                      |
| (4)  | Current image no./Total images/No. of images found |
| (5)  | Battery level                                      |
| (6)  | Shutter speed                                      |
| (7)  | Aperture value                                     |
| (8)  | Exposure compensation amount                       |
| (9)  | Rating   |
| (10) | Image protection                                   |
| (11) | Folder no.-File no.                                |
| (12) | Image quality/Edited image/Cropping                |
| (13) | Highlight tone priority                            |
| (14) | ISO speed  |

## Warning

- If the image was taken by another camera, certain shooting information may not be displayed.
- It may not be possible to play back images taken with this camera on other cameras.

## Detailed information display for still photos

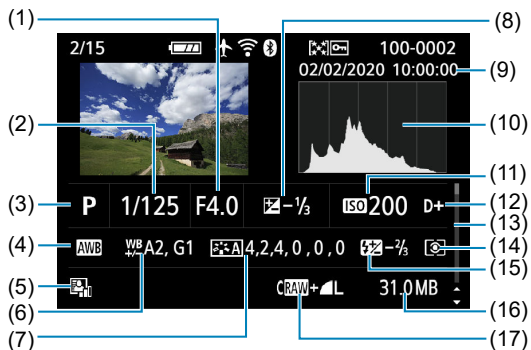

(1)	Aperture value
(2)	Shutter speed
(3)	Shooting mode
(4)	White balance
(5)	Auto Lighting Optimizer
(6)	White balance correction amount
(7)	Picture Style/Settings
(8)	Exposure compensation amount
(9)	Shooting date and time
(10)	Histogram (Brightness/RGB)
(11)	ISO speed
(12)	Highlight tone priority
(13)	Scroll bar
(14)	Metering mode
(15)	Flash exposure compensation amount/Bounce/Multi Shot Noise Reduction
(16)	File size
(17)	Image quality/Edited image/Cropping

\* When you shoot in RAW+JPEG image quality, the RAW image file size will be displayed.

\* Lines indicating the image area will be displayed for images taken with the aspect ratio set () and with RAW or RAW+JPEG set for image quality.

\* For images with added cropping information, lines are shown to indicate the image area.

\* During flash photography without flash exposure compensation, () will be displayed.

\* () indicates images shot with bounce flash photography.

\* () indicates Creative filter shots, or images created and saved by performing RAW image processing, resizing, cropping, or frame-grabbing.

\* () indicates images cropped and then saved.

## Detailed information display for movies

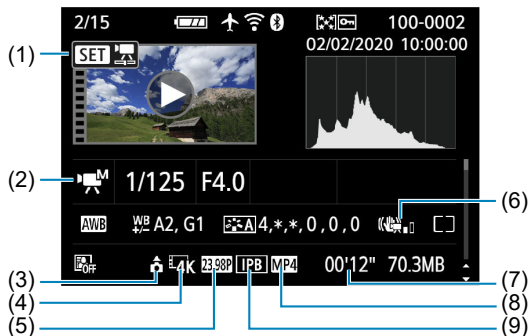

- (1) Movie playback
- (2) Movie recording mode/Time-lapse movie/Video snapshot
- (3) Movie orientation information
- (4) Image size
- (5) Frame rate
- (6) Movie digital IS
- (7) Recording time
- (8) Movie recording format
- (9) Movie compression method

\* For simplicity, explanations are omitted for items that are also included in basic/detailed information display for still photos, which are not shown here.

### Note

- During movie playback, "", "\*" will be displayed for [Fineness] and [Threshold] of [Picture Style]'s [Sharpness].



## AF Sensor

The camera's AF sensor has 45 AF points. AF sensor patterns formed by the AF points are as follows. High-precision AF centered in the viewfinder is possible using lenses with a maximum aperture up to  $f/2.8$ .

### Warning

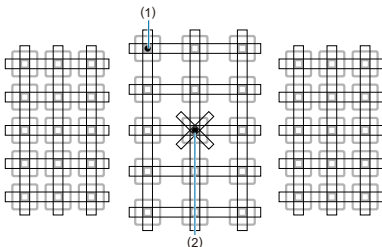

- The number of available AF points, the focusing patterns, and the Area AF frame shape vary by lens. For details, refer to [Compatible Lenses and Autofocusing \(Viewfinder Shooting\)](#).

### Schematic diagram











(1) Cross-type focusing:  $f/5.6$  vertical +  $f/5.6$  horizontal  
(some also supporting  $f/8$ )

(2) Dual cross-type focusing:  $f/2.8$  right diagonal +  $f/2.8$  left diagonal  
 $f/5.6$  vertical +  $f/5.6$  horizontal (also supporting  $f/8$ )

	This focusing sensor is geared to obtain higher-precision focusing for lenses with a maximum aperture value as low as $f/2.8$ . A diagonal cross pattern makes it easier to focus on the subjects that may be difficult to focus. It is provided at the center AF point.
	These focusing sensors are geared for lenses with a maximum aperture value as low as $f/5.6$ (and some supporting $f/8$ ). Since they have a horizontal pattern, they can detect vertical lines. They cover all 45 AF points.
	These focusing sensors are geared for lenses with a maximum aperture value as low as $f/5.6$ (and some supporting $f/8$ ). Since they have a vertical pattern, they can detect horizontal lines. They cover all 45 AF points.

## Compatible Lenses and Autofocusing (Viewfinder Shooting)

---

-  [Group A](#)
-  [Group B](#)
-  [Group C](#)
-  [Group D](#)
-  [Group E](#)
-  [Group F](#)
-  [Group G](#)
-  [Group H](#)
-  [Group Classification of Lenses](#)

### Warning

- Although the camera has 45 AF points, **lenses are classified into 8 groups (A–H) which vary in the number of AF points available, AF point patterns, Area AF frame shapes, and other details.**
- **Using a lens in Groups E to H will have fewer usable AF points.**
- **Lens groups are listed in [Group Classification of Lenses](#). Check which group your lens belongs to.**
- The number of AF points varies depending on your specified [Still Image Aspect Ratio](#).

## Note

- AF points in positions indicated by [ ] blink when the < [ ] > or < [ ] > button is pressed (while [ ]/[ ] points remain lit). For details on AF point blinking/illumination, see [Meaning of Lit or Blinking AF Points](#).
- For updates on "Group Classification of Lenses," visit the Canon website or others.
- Some lenses may not be available in certain countries or regions.

## Group A

Autofocusing with 45 points is possible. All the AF area selection modes are available.

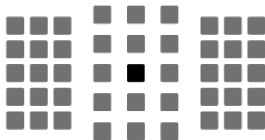

■: Dual cross-type AF point. Offers superior subject tracking and higher focusing precision than other AF points.

■: Cross-type AF point. Offers excellent subject tracking and high-precision focusing.

## Group B

---

Autofocusing with 45 points is possible. All the AF area selection modes are available.



■: Cross-type AF point. Offers excellent subject tracking and high-precision focusing.

## Group C

---

Autofocusing with 45 points is possible. All the AF area selection modes are available.



■: Cross-type AF point. Offers excellent subject tracking and high-precision focusing.

□: AF points sensitive to horizontal lines.

## Group D

---

Autofocusing with 45 points is possible. All the AF area selection modes are available.

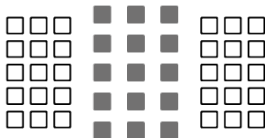

■: Cross-type AF point. Offers excellent subject tracking and high-precision focusing.

□: AF points sensitive to horizontal lines.

## Group E

---

Autofocusing with 35 points is possible. (Not possible with all 45 AF points.) All the AF area selection modes are available. During automatic AF point selection, the outer frame marking the AF area (Area AF frame) will be different from 45-point Automatic selection AF.

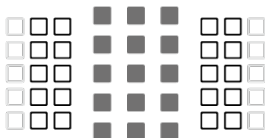

■: Cross-type AF point. Offers excellent subject tracking and high-precision focusing.

□: AF points sensitive to horizontal lines.

◻: Disabled AF points (not displayed).

## Group F

---

Autofocusing with 35 points is possible. (Not possible with all 45 AF points.) All the AF area selection modes are available. During automatic AF point selection, the outer frame marking the AF area (Area AF frame) will be different from 45-point Automatic selection AF.

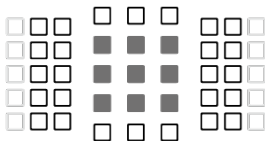

■: Cross-type AF point. Offers excellent subject tracking and high-precision focusing.

▣: AF points sensitive to vertical lines (AF points in the horizontal array at the top and bottom) or horizontal lines (AF points in a vertical array on the left and right).

□: Disabled AF points (not displayed).

## Group G

Autofocusing with 27 points is possible. (Not possible with all 45 AF points.) Large Zone AF (manual selection of zone) cannot be selected in AF area selection mode. During automatic AF point selection, the outer frame marking the AF area (Area AF frame) will be different from 45-point Automatic selection AF.

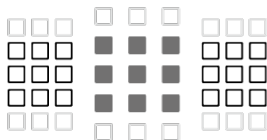

■: Cross-type AF point. Offers excellent subject tracking and high-precision focusing.

□: AF points sensitive to horizontal lines.

□: Disabled AF points (not displayed).

## Group H

Autofocusing is possible only with the center AF point.

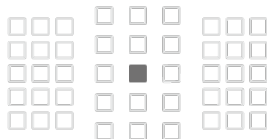

■: Cross-type AF point. Offers excellent subject tracking and high-precision focusing.

□: Disabled AF points (not displayed).

### ⚠ Caution

- If the maximum aperture value is slower than  $f/5.6$  (greater than  $f/5.6$  but not exceeding  $f/8$ ), focus may not be achieved with AF when shooting low-contrast or low-light subjects.
- If the maximum aperture value is slower than  $f/8$  (greater than  $f/8$ ), AF is not possible during viewfinder shooting.

## Group Classification of Lenses

EF-S24mm f/2.8 STM	A
EF-S35mm f/2.8 Macro IS STM	B
EF-S60mm f/2.8 Macro USM	B
EF-S10-18mm f/4.5-5.6 IS STM	D
EF-S10-22mm f/3.5-4.5 USM	B
EF-S15-85mm f/3.5-5.6 IS USM	B
EF-S17-55mm f/2.8 IS USM	A
EF-S17-85mm f/4-5.6 IS USM	B
EF-S18-55mm f/3.5-5.6	C
EF-S18-55mm f/3.5-5.6 USM	C
EF-S18-55mm f/3.5-5.6 II	C
EF-S18-55mm f/3.5-5.6 II USM	C
EF-S18-55mm f/3.5-5.6 III	B
EF-S18-55mm f/3.5-5.6 IS	C
EF-S18-55mm f/3.5-5.6 IS II	B
EF-S18-55mm f/3.5-5.6 IS STM	B
EF-S18-55mm f/4-5.6 IS STM	D
EF-S18-135mm f/3.5-5.6 IS	B
EF-S18-135mm f/3.5-5.6 IS USM	B
EF-S18-135mm f/3.5-5.6 IS STM	B
EF-S18-200mm f/3.5-5.6 IS	B
EF-S55-250mm f/4-5.6 IS	B
EF-S55-250mm f/4-5.6 IS II	B
EF-S55-250mm f/4-5.6 IS STM	B
EF14mm f/2.8L USM	A
EF14mm f/2.8L II USM	A
EF15mm f/2.8 Fisheye	A
EF20mm f/2.8 USM	A
EF24mm f/1.4L USM	A



EF24mm f/1.4L II USM	A
EF24mm f/2.8	A
EF24mm f/2.8 IS USM	A
EF28mm f/1.8 USM	A
EF28mm f/2.8	A
EF28mm f/2.8 IS USM	A
EF35mm f/1.4L USM	A
EF35mm f/1.4L II USM	A
EF35mm f/2	A
EF35mm f/2 IS USM	A
EF40mm f/2.8 STM	A
EF50mm f/1.0L USM	A
EF50mm f/1.2L USM	A
EF50mm f/1.4 USM	A
EF50mm f/1.8	A
EF50mm f/1.8 II	A
EF50mm f/1.8 STM	A
EF50mm f/2.5 Compact Macro	B
EF50mm f/2.5 Compact Macro + LIFE SIZE Converter	B
EF85mm f/1.2L USM	A
EF85mm f/1.2L II USM	A
EF85mm f/1.4L IS USM	A
EF85mm f/1.8 USM	A
EF100mm f/2 USM	A
EF100mm f/2.8 Macro	B
EF100mm f/2.8 Macro USM	E
EF100mm f/2.8L Macro IS USM	B
EF135mm f/2L USM	A
EF135mm f/2L USM + Extender EF1.4x I/II/III	A
EF135mm f/2L USM + Extender EF2x I/II/III	B
EF135mm f/2.8 (Softfocus)	A
EF180mm f/3.5L Macro USM	B
EF180mm f/3.5L Macro USM + Extender EF1.4x I/II/III	F

EF200mm f/1.8L USM	A
EF200mm f/1.8L USM + Extender EF1.4x I/II/III	A*
EF200mm f/1.8L USM + Extender EF2x I/II/III	B*
EF200mm f/2L IS USM	A
EF200mm f/2L IS USM + Extender EF1.4x I/II/III	A
EF200mm f/2L IS USM + Extender EF2x I/II/III	B
EF200mm f/2.8L USM	A
EF200mm f/2.8L USM + Extender EF1.4x I/II/III	B
EF200mm f/2.8L USM + Extender EF2x I/II/III	B
EF200mm f/2.8L II USM	A
EF200mm f/2.8L II USM + Extender EF1.4x I/II/III	B
EF200mm f/2.8L II USM + Extender EF2x I/II/III	B
EF300mm f/2.8L USM	A
EF300mm f/2.8L USM + Extender EF1.4x I/II/III	B*
EF300mm f/2.8L USM + Extender EF2x I/II/III	B*
EF300mm f/2.8L IS USM	A
EF300mm f/2.8L IS USM + Extender EF1.4x I/II/III	B
EF300mm f/2.8L IS USM + Extender EF2x I/II/III	B
EF300mm f/2.8L IS II USM	A
EF300mm f/2.8L IS II USM + Extender EF1.4x I/II/III	B
EF300mm f/2.8L IS II USM + Extender EF2x I/II/III	B
EF300mm f/4L USM	B
EF300mm f/4L USM + Extender EF1.4x I/II/III	B
EF300mm f/4L USM + Extender EF2x I/II/III	H (f/8)
EF300mm f/4L IS USM	B
EF300mm f/4L IS USM + Extender EF1.4x I/II/III	B
EF300mm f/4L IS USM + Extender EF2x I/II/III	H (f/8)
EF400mm f/2.8L USM	A
EF400mm f/2.8L USM + Extender EF1.4x I/II/III	B*
EF400mm f/2.8L USM + Extender EF2x I/II/III	B*
EF400mm f/2.8L II USM	A
EF400mm f/2.8L II USM + Extender EF1.4x I/II/III	B*
EF400mm f/2.8L II USM + Extender EF2x I/II/III	B*

EF400mm f/2.8L IS USM	A
EF400mm f/2.8L IS USM + Extender EF1.4x I/II/III	B
EF400mm f/2.8L IS USM + Extender EF2x I/II/III	B
EF400mm f/2.8L IS II USM	A
EF400mm f/2.8L IS II USM + Extender EF1.4x I/II/III	B
EF400mm f/2.8L IS II USM + Extender EF2x I/II/III	B
EF400mm f/2.8L IS III USM	A
EF400mm f/2.8L IS III USM + Extender EF1.4x	B
EF400mm f/2.8L IS III USM + Extender EF1.4x II	B
EF400mm f/2.8L IS III USM + Extender EF1.4x III	B
EF400mm f/2.8L IS III USM + Extender EF2x	B
EF400mm f/2.8L IS III USM + Extender EF2x II	B
EF400mm f/2.8L IS III USM + Extender EF2x III	B
EF400mm f/4 DO IS USM	B
EF400mm f/4 DO IS USM + Extender EF1.4x I/II/III	B
EF400mm f/4 DO IS USM + Extender EF2x I/II/III	H (f/8)
EF400mm f/4 DO IS II USM	B
EF400mm f/4 DO IS II USM + Extender EF1.4x I/II/III	B
EF400mm f/4 DO IS II USM + Extender EF2x I/II/III	H (f/8)
EF400mm f/5.6L USM	B
EF400mm f/5.6L USM + Extender EF1.4x I/II/III	H (f/8)
EF500mm f/4L IS USM	B
EF500mm f/4L IS USM + Extender EF1.4x I/II/III	B
EF500mm f/4L IS USM + Extender EF2x I/II/III	H (f/8)
EF500mm f/4L IS II USM	B
EF500mm f/4L IS II USM + Extender EF1.4x I/II/III	B
EF500mm f/4L IS II USM + Extender EF2x I/II/III	H (f/8)
EF500mm f/4.5L USM	B
EF500mm f/4.5L USM + Extender EF1.4x I/II/III	H (f/8)*
EF600mm f/4L USM	B
EF600mm f/4L USM + Extender EF1.4x I/II/III	B*
EF600mm f/4L USM + Extender EF2x I/II/III	H (f/8)*
EF600mm f/4L IS USM	B

EF600mm f/4L IS USM + Extender EF1.4x I/II/III	B
EF600mm f/4L IS USM + Extender EF2x I/II/III	H (f/8)
EF600mm f/4L IS II USM	B
EF600mm f/4L IS II USM + Extender EF1.4x I/II/III	B
EF600mm f/4L IS II USM + Extender EF2x I/II/III	H (f/8)
EF600mm f/4L IS III USM	B
EF600mm f/4L IS III USM + Extender EF1.4x	B
EF600mm f/4L IS III USM + Extender EF1.4x II	B
EF600mm f/4L IS III USM + Extender EF1.4x III	B
EF600mm f/4L IS III USM + Extender EF2x	H
EF600mm f/4L IS III USM + Extender EF2x II	H
EF600mm f/4L IS III USM + Extender EF2x III	H
EF800mm f/5.6L IS USM	E
EF800mm f/5.6L IS USM + Extender EF1.4x I/II/III	H (f/8)
EF1200mm f/5.6L USM	E
EF1200mm f/5.6L USM + Extender EF1.4x I/II/III	H (f/8)*
EF8-15mm f/4L Fisheye USM	B
EF11-24mm f/4L USM	C
EF16-35mm f/2.8L USM	A
EF16-35mm f/2.8L II USM	A
EF16-35mm f/2.8L III USM	A
EF16-35mm f/4L IS USM	B
EF17-35mm f/2.8L USM	A
EF17-40mm f/4L USM	B
EF20-35mm f/2.8L	A
EF20-35mm f/3.5-4.5 USM	C
EF22-55mm f/4-5.6 USM	F
EF24-70mm f/2.8L USM	A
EF24-70mm f/2.8L II USM	A
EF24-70mm f/4L IS USM	B
EF24-85mm f/3.5-4.5 USM	D
EF24-105mm f/3.5-5.6 IS STM	B
EF24-105mm f/4L IS USM	B

EF24-105mm f/4L IS II USM	B
EF28-70mm f/2.8L USM	A
EF28-70mm f/3.5-4.5	E
EF28-70mm f/3.5-4.5 II	E
EF28-80mm f/2.8-4L USM	B
EF28-80mm f/3.5-5.6	E
EF28-80mm f/3.5-5.6 USM	E
EF28-80mm f/3.5-5.6 II	E
EF28-80mm f/3.5-5.6 II USM	E
EF28-80mm f/3.5-5.6 III USM	E
EF28-80mm f/3.5-5.6 IV USM	E
EF28-80mm f/3.5-5.6 V USM	E
EF28-90mm f/4-5.6	B
EF28-90mm f/4-5.6 USM	B
EF28-90mm f/4-5.6 II	B
EF28-90mm f/4-5.6 II USM	B
EF28-90mm f/4-5.6 III	B
EF28-105mm f/3.5-4.5 USM	B
EF28-105mm f/3.5-4.5 II USM	B
EF28-105mm f/4-5.6	F
EF28-105mm f/4-5.6 USM	F
EF28-135mm f/3.5-5.6 IS USM	B
EF28-200mm f/3.5-5.6	B
EF28-200mm f/3.5-5.6 USM	B
EF28-300mm f/3.5-5.6L IS USM	B
EF35-70mm f/3.5-4.5	E
EF35-70mm f/3.5-4.5A	E
EF35-80mm f/4-5.6	F
EF35-80mm f/4-5.6 PZ	E
EF35-80mm f/4-5.6 USM	F
EF35-80mm f/4-5.6 II	E
EF35-80mm f/4-5.6 III	F
EF35-105mm f/3.5-4.5	B

EF35-105mm f/4.5-5.6	H
EF35-105mm f/4.5-5.6 USM	H
EF35-135mm f/3.5-4.5	B
EF35-135mm f/4-5.6 USM	C
EF35-350mm f/3.5-5.6L USM	D
EF38-76mm f/4.5-5.6	E
EF50-200mm f/3.5-4.5	B
EF50-200mm f/3.5-4.5L	B
EF55-200mm f/4.5-5.6 USM	D
EF55-200mm f/4.5-5.6 II USM	D
EF70-200mm f/2.8L USM	A
EF70-200mm f/2.8L USM + Extender EF1.4x I/II/III	B**
EF70-200mm f/2.8L USM + Extender EF2x I/II/III	B**
EF70-200mm f/2.8L IS USM	A
EF70-200mm f/2.8L IS USM + Extender EF1.4x I/II/III	B
EF70-200mm f/2.8L IS USM + Extender EF2x I/II/III	B
EF70-200mm f/2.8L IS II USM	A
EF70-200mm f/2.8L IS II USM + Extender EF1.4x I/II/III	B
EF70-200mm f/2.8L IS II USM + Extender EF2x I/II/III	B
EF70-200mm f/2.8L IS III USM	A
EF70-200mm f/2.8L IS III USM + Extender EF1.4x	B
EF70-200mm f/2.8L IS III USM + Extender EF1.4x II	B
EF70-200mm f/2.8L IS III USM + Extender EF1.4x III	B
EF70-200mm f/2.8L IS III USM + Extender EF2x	B
EF70-200mm f/2.8L IS III USM + Extender EF2x II	B
EF70-200mm f/2.8L IS III USM + Extender EF2x III	B
EF70-200mm f/4L USM	B
EF70-200mm f/4L USM + Extender EF1.4x I/II/III	B
EF70-200mm f/4L USM + Extender EF2x I/II/III	H (f/8)
EF70-200mm f/4L IS USM	B
EF70-200mm f/4L IS USM + Extender EF1.4x I/II/III	B
EF70-200mm f/4L IS USM + Extender EF2x I/II/III	H (f/8)
EF70-200mm f/4L IS II USM	B

EF70-200mm f/4L IS II USM + Extender EF1.4x	B
EF70-200mm f/4L IS II USM + Extender EF1.4x II	B
EF70-200mm f/4L IS II USM + Extender EF1.4x III	B
EF70-200mm f/4L IS II USM + Extender EF2x	H
EF70-200mm f/4L IS II USM + Extender EF2x II	H
EF70-200mm f/4L IS II USM + Extender EF2x III	H
EF70-210mm f/3.5-4.5 USM	B
EF70-210mm f/4	B
EF70-300mm f/4-5.6 IS USM	B
EF70-300mm f/4-5.6 IS II USM	B
EF70-300mm f/4-5.6L IS USM	B
EF70-300mm f/4.5-5.6 DO IS USM	B
EF75-300mm f/4-5.6	B
EF75-300mm f/4-5.6 USM	C
EF75-300mm f/4-5.6 II	B
EF75-300mm f/4-5.6 II USM	B
EF75-300mm f/4-5.6 III	B
EF75-300mm f/4-5.6 III USM	B
EF75-300mm f/4-5.6 IS USM	B
EF80-200mm f/2.8L	A
EF80-200mm f/4.5-5.6	D
EF80-200mm f/4.5-5.6 USM	E
EF80-200mm f/4.5-5.6 II	E
EF90-300mm f/4.5-5.6	D
EF90-300mm f/4.5-5.6 USM	D
EF100-200mm f/4.5A	B
EF100-300mm f/4.5-5.6 USM	C
EF100-300mm f/5.6	B
EF100-300mm f/5.6L	B
EF100-400mm f/4.5-5.6L IS USM	B
EF100-400mm f/4.5-5.6L IS USM + Extender EF1.4x I/II/III	H (f/8)
EF100-400mm f/4.5-5.6L IS II USM	B
EF100-400mm f/4.5-5.6L IS II USM + Extender EF1.4x I/II	H (f/8)

EF100-400mm f/4.5-5.6L IS II USM + Extender EF1.4x III	G (f/8)
EF200-400mm f/4L IS USM Extender 1.4x	B
EF200-400mm f/4L IS USM Extender 1.4x: Built-in Ext. 1.4x	B
EF200-400mm f/4L IS USM Extender 1.4x + Extender EF1.4x I/II/III	B
EF200-400mm f/4L IS USM Extender 1.4x: Built-in Ext. 1.4x + Extender EF1.4x I/II/III	H (f/8)
EF200-400mm f/4L IS USM Extender 1.4x + Extender EF2x I/II	H (f/8)
EF200-400mm f/4L IS USM Extender 1.4x + Extender EF2x III	G (f/8)
TS-E17mm f/4L	B
TS-E24mm f/3.5L	B
TS-E24mm f/3.5L II	B
TS-E45mm f/2.8	A
TS-E50mm f/2.8L Macro	B
TS-E90mm f/2.8	A
TS-E90mm f/2.8L Macro	B
TS-E135mm f/4L Macro	B

#### Caution

- If Extender EF2x (I/II/III) is attached to the EF180mm f/3.5L Macro USM lens, AF is not possible.
- Precise autofocus may not be achieved if you use a lens and Extender EF1.4x III/EF2x III combination marked with an asterisk or a lens and extender in a combination marked with two asterisks. In this case, refer to the Instruction Manual of the lens or extender used.

#### Note

- If you use a TS-E lens, manual focusing is required. TS-E lens group designations apply only when tilt or shift is not used.



# Specifications

---

## Type

**Type:** Digital AF/AE single-lens reflex camera

**Lens mount:** Canon EF mount

**Compatible lenses:** Lenses in Canon EF product group (including EF-S lenses, excluding EF-M lenses)

**Lens focal length:** Approx. 1.6 times the focal length indicated on the lens

## Image sensor

**Type:** CMOS sensor

Screen size	Approx. 22.3 × 14.9 mm
Effective pixels*	Approx. 24.1 megapixels
Dual Pixel CMOS AF	Supported

\* Rounded to the nearest 100,000.

## Recording system

**Image recording format:** Compliant to Design rule for Camera File system 2.0 and Exif 2.31\*







\* Supports time difference information

## Image type and extension







Image type		Extension
Stills	JPEG	JPG
	RAW	CR3
	C-RAW	

## Still photo recording

### Image type in still photo recording

Image quality		Resolution (Pixels)
JPEG	 / 	24 megapixels (6000 × 4000)
	 / 	Approx. 10.6 megapixels (3984 × 2656)
	 / 	Approx. 5.9 megapixels (2976 × 1984)
	<b>S2</b>	Approx. 3.8 megapixels (2400 × 1600)
RAW	<b>RAW / CRAW</b>	24 megapixels (6000 × 4000)

### Still photo pixel count

Image quality	Pixel count			
	Aspect ratio			
	3:2	4:3	16:9	1:1
 / 	24 megapixels (6000 × 4000)	Approx. 21.3 megapixels* (5328 × 4000)	Approx. 20.2 megapixels* (6000 × 3368)	16 megapixels (4000 × 4000)
 / 	Approx. 10.6 megapixels (3984 × 2656)	Approx. 9.5 megapixels (3552 × 2664)	Approx. 8.9 megapixels* (3984 × 2240)	Approx. 7.1 megapixels (2656 × 2656)
 / 	Approx. 5.9 megapixels (2976 × 1984)	Approx. 5.3 megapixels (2656 × 1992)	Approx. 5.0 megapixels* (2976 × 1680)	Approx. 3.9 megapixels (1984 × 1984)
<b>S2</b>	Approx. 3.8 megapixels (2400 × 1600)	Approx. 3.4 megapixels* (2112 × 1600)	Approx. 3.2 megapixels* (2400 × 1344)	Approx. 2.6 megapixels (1600 × 1600)
<b>RAW / CRAW</b>	24 megapixels (6000 × 4000)			

\* Values for Recording Pixels are rounded off to the nearest 100,000th.













\* JPEG images are generated in the set aspect ratio.

\* RAW/C-RAW images are generated in [3:2], and the set aspect ratio is appended.

\* Aspect ratios are slightly different than indicated for image sizes marked with an asterisk.

\* These aspect ratios (M, S1, and S2) and pixel counts also apply to resizing.

## Still photo file size / Number of possible shots / Maximum burst for continuous shooting

Image quality	File size (Approx. MB)	Possible shots (Approx.)* <sup>1</sup>	Maximum burst (Approx.)* <sup>1</sup>
 L	8.4	3600	170
 L	4.5	6610	170
 M	4.6	6480	167
 M	2.6	11400	167
 S1	3.1	9690	163
 S1	1.8	16010	163
S2	1.8	16340	164
 RAW	27.2	1120	40
 CRAW	15.8	1930	75
 RAW +  L	35.6	850	35
 CRAW +  L	24.2	1250	57

\* 1: Number of shots available and standard maximum burst in viewfinder shooting with a 32 GB UHS-I card conforming to Canon testing standards.

\* File size, number of possible shots, and maximum burst vary depending on shooting conditions (including subject, memory card brand, ISO speed, Picture Style, and Custom Function).

## Movie recording

### Movie recording format: MP4

#### Estimated recording time, movie bit rate, and file size

Movie recording size			Total recording time (approx.)			Movie bit rate File size
			8 GB	32 GB	128 GB	
4K UHD	23.98 fps 25.00 fps	IPB (Standard)	8 min.	35 min.	2 hr. 21 min.	Approx. 120 Mbps Approx. 861 MB/min.
Full HD	59.94 fps 50.00 fps	IPB (Standard)	17 min.	1 hr. 10 min.	4 hr. 43 min.	Approx. 60 Mbps Approx. 432 MB/min.
	29.97 fps 23.98 fps 25.00 fps	IPB (Standard)	35 min.	2 hr. 20 min.	9 hr. 23 min.	Approx. 30 Mbps Approx. 217 MB/min.
	29.97 fps 25.00 fps	IPB (Light)	1 hr. 26 min.	5 hr. 47 min.	23 hr. 11 min.	Approx. 12 Mbps Approx. 88 MB/min.
HD	59.94 fps 50.00 fps	IPB (Standard)	40 min.	2 hr. 42 min.	10 hr. 49 min.	Approx. 26 Mbps Approx. 188 MB/min.

#### Movie recording notes

\* Bit rate indicates video output only, audio is not included.

\* File size and time indicates video output + audio

\* With : **Movie digital IS** set to **[Disable]**.

\* Movie recording stops automatically when the recording time reaches 29:59.

#### Card performance requirements

Movie recording size			Card performance requirements
4K UHD	23.98 fps / 25.00 fps	IPB (Standard)	UHS-I/UHS Speed Class 3 or higher
Full HD	59.94 fps / 50.00 fps	IPB (Standard)	SD Speed Class 10 or higher
	29.97 fps / 23.98 fps / 25.00 fps	IPB (Standard)	SD Speed Class 6 or higher
	29.97 fps / 25.00 fps	IPB (Light)	SD Speed Class 4 or higher
HD	59.94 fps / 50.00 fps	IPB (Standard)	SD Speed Class 4 or higher
4K UHD Time-lapse movie	29.97 fps / 25.00 fps	ALL-I	Read speed of 40 MB/s or higher
Full HD Time-lapse movies	29.97 fps / 25.00 fps	ALL-I	Read speed of 20 MB/s or higher

\* With : **Movie digital IS** set to **[Disable]**.

## Recording microphone

Built-in microphone: Stereo microphones

External microphone terminal: 3.5 mm diameter stereo mini jack

## Recording media

**Recording media:** SD, SDHC, and SDXC memory cards

SD speed class	Supported
UHS speed class	Supported
UHS-I	Supported * Supports high-speed writing

## Viewfinder

**Type:** Eye-level SLR type, with pentamirror

**Focusing screen:** Fixed

**Coverage:** Vertical/horizontal: Approx. 95%

\* Eyepoint: Approx. 19 mm

\* Lens: EF50mm f/1.8 STM

**Magnification / angle of view:** Approx. 0.82x / Approx. 23.2°

\* Lens: EF50mm f/1.8 STM at infinity

\* Diopter:  $-1 \text{ m}^{-1}$

**Dioptric adjustment range:** Approx.  $-3.0 - +1.0 \text{ m}^{-1}$  (dpt)

**Eyepoint:** Approx. 19 mm (at  $-1 \text{ m}^{-1}$  from eyepiece lens end)

## Screen

**Type:** TFT color, liquid-crystal monitor

**Screen size:** Approx. 7.5 cm (3.0 in.) (3:2)

**Dot count:** Approx. 1,040,000 dots

**Angle of view:** Approx. 170° vertically and horizontally

**Brightness adjustment:** Adjustable to one of seven brightness levels

**Touch-screen panel detection system:** Capacitive sensing

## HDMI

**HDMI video/audio output:** HDMI mini OUT terminal (Type C), CEC not compatible

**HDMI resolution:** Auto / 1080p

## Autofocus in optical viewfinder shooting (still photo)

**Focusing method:** TTL secondary image-forming phase-difference detection using AF-dedicated sensor

### Focusing operation

Autofocus	One-Shot AF
	AI Focus AF * Automatic switching between One-Shot AF and AI Servo AF
	AI Servo AF
Manual focus	Supported

## Autofocus in Live View shooting (still photo) and movie shooting

Item	Live View shooting (still photo)	Movie recording
Focus detection method	Dual Pixel CMOS AF	<ul style="list-style-type: none"><li>• Dual Pixel CMOS AF</li><li>• Contrast detection*</li></ul> <p>* For 4K UHD movies/4K UHD time-lapse movies</p>
AF area	Approx. 88% (horizontal) × 100% (vertical) Approx. 80% (horizontal) × 80% (vertical) * Varies depending on the lens used	Approx. 88% (horizontal) × 100% (vertical) Approx. 80% (horizontal) × 95% (vertical) * Varies depending on the lens used
Number of AF area available for automatic selection	Max. 143 zones	Max. 117 zones
Selectable positions for AF point	Max. 3975 positions	Max. 3375 positions
Eye Detection AF	Supported	Supported
Focusing brightness range	EV -4 – 18 (center AF point) * At 23°C/73°F, f/1.2, ISO 100, One-Shot AF	EV -2 – 18 (center AF point) * At 23°C/73°F, f/1.2, ISO 100, One-Shot AF * At 23.98 fps

## Exposure control

### Metering functions under various shooting conditions

Item	Still photo shooting		Movie recording
	Optical viewfinder	Live View	
Metering mode	216-zone (18 × 12) metering using approx. 220,000 pixel RGB+IR metering sensor TTL full-aperture metering	384-zone (24 × 16) metering using image sensor output signals	
Evaluative metering	Supported		Supported * When faces are detected with  +Tracking]
Partial metering	Supported: Approx. 6.5% of the screen	Supported: Approx. 5.8% of the screen	–
Spot metering	Supported: Approx. 2.0% of the screen	Supported: Approx. 2.9% of the screen	–
Center-weighted average metering	Supported		Supported * When no faces are detected
Metering brightness range * At 23°C/73°F, ISO 100	EV 1 – 20	EV –2 – 20	EV 0 – 20

### Exposure control under various shooting conditions (Creative Zone)

Item	Still photo shooting	Movie recording
Shutter speed	1/4000 – 30 sec., Bulb	1/4000 – 1/8 sec.
ISO speed (Recommended exposure index)	ISO 100*1 – 25600*2 (in 1/3-stop increments)	<ul style="list-style-type: none"> <li>• 4K UHD: ISO 100*1 – 6400 (in 1/3-stop increments)</li> <li>• Full HD / HD: ISO 100 – 12800*3 (in 1/3-stop increments)</li> </ul>
ISO Auto (Recommended exposure index)	<ul style="list-style-type: none"> <li>• Without flash firing: ISO 100*1 – 25600*4</li> <li>• Flash firing: ISO 100*1 – 1600*4+5</li> <li>• Bulb exposure: ISO 400</li> </ul>	<ul style="list-style-type: none"> <li>• 4K UHD: ISO 100*1 – 6400</li> <li>• Full HD / HD: ISO 100*1 – 12800*3+4+6</li> </ul>
Max. for ISO Auto	ISO 400 – 25600 (in 1-stop increments)	ISO 6400 – 12800*3 (in 1-stop increments)

\* 1: ISO 200 with : **Highlight tone priority**] set to **[Enable]** or **[Enhanced]**.

\* 2: H (equivalent to ISO 51200) with **[2: ISO expansion]** in : **Custom Functions(C.Fn)]** set to **[1:Enable]**.

\* 3: H (equivalent to ISO 25600) with **[2: ISO expansion]** in : **Custom Functions(C.Fn)]** set to **[1:Enable]**.

\* 4: Varies depending on **[Max for Auto]** setting.

\* 5: Maximum limit may be lower depending on the ISO speed set by variable control of maximum ISO Auto limit for E-TTL.

\* 6: ISO 6400 when Digital zoom is set.

## Built-in flash

**Type:** Retractable flash in the pentamirror housing

**Retraction method:** Manual

**Guide number:** G. No.: Approx. 12 (ISO 100, m) / 39.4 (ISO 100, feet)

## External flash

**Sync contacts:** Hot shoe: X-sync contact

\* Maximum flash sync speed: 1/200 sec.

**Flash mode:** E-TTL II metering

## Drive

### Drive mode and continuous shooting speed

Drive mode	Viewfinder shooting	Live View shooting
Single shooting	Yes	
High-speed continuous* <sup>1</sup>	Max. approx. 7.0 shots/sec.	Max. approx. 7.5 shots/sec.
Low-speed continuous	Max. approx. 3.0 shots/sec.	Max. approx. 3.0 shots/sec.
Self-timer:10 sec / remote control* <sup>2</sup>	Yes (BR-E1: Supported / RC-6: Not supported)	
Self-timer:2 sec / remote control* <sup>2</sup>	Yes (BR-E1: Supported)	
Self-timer:Continuous	Yes (2 – 10 shots)	

\* 1: 1/1000 sec. or faster shutter speed, EF50mm f/1.8 STM lens, open aperture, with a fully charged Battery Pack LP-E17, and at room temperature (23°C/73°F)

\* 2: Remote control icon  displayed only when paired with BR-E1



## Playback

Item	Stills	Movies
Magnify zoom display	1.5x – 10x * Can be activated by double-tapping	–
AF point display	Supported	–
Highlight alert	Supported * Detailed information display only	
Rating	OFF / ★ to ★★★★★ Select images / Select range / All images in folder / All images on card	
Image search	Search conditions: Rating / Date / Folder / Protect / Type of file	
Protect	Select images / Select range / All images in folder / Unprotect all images in folder / All images on card / Unprotect all images on card	
In-camera RAW processing	Supported	–
Resize	Supported	–
Cropping	Supported	–

## Print ordering (DPOF)

**System:** Compliant with DPOF Version 1.1

## Customization (C.Fn)

**Custom Function:** 14 Custom Functions can be configured.

## External interface

### Digital terminal

Terminal type	Micro-B
Transmission	Hi-Speed USB (USB 2.0)
Applications	For PC communication

**HDMI mini OUT terminal:** Type C (Resolution switches automatically)

**External microphone input terminal:** Compatible with the 3.5 mm diameter stereo mini plug

**Remote control terminal:** Remote Switch RS-60E3 type terminal supported

## Power source

**Battery:** Battery Pack LP-E17 × 1

## AC power source

AC adapter	AC-E6N
DC coupler	DR-E18

## Possible shots

Shooting method	Temperature	Shooting conditions	
		AE: 100%	AE: 50% / FA: 50% * CIPA testing standards
Viewfinder shooting	+23°C / 73°F	Approx. 1240 shots	Approx. 800 shots
	0°C / 32°F	Approx. 1120 shots	Approx. 730 shots
Live View shooting	+23°C / 73°F	Approx. 360 shots	Approx. 310 shots
	0°C / 32°F	Approx. 330 shots	Approx. 290 shots

\* With a fully charged LP-E17

## Time available for movie recording

Conditions of use		Temperature	Available operating time
Time available for movie recording	4K UHD, 23.98 fps, IPB (Standard)	+23°C / 73°F	Approx. 1 hr. 45 min.
		+23°C / 73°F	Approx. 2 hr. 30 min.
	Full HD, 29.97 fps, IPB (Standard)	0°C / 32°F	Approx. 2 hr. 20 min.
Full HD Interval: 5 sec.		Screen on	+23°C / 73°F
	Screen off	+23°C / 73°F	Approx. 2 hr. 50 min.

\* With a fully charged LP-E17

## Battery information

Remaining capacity	4-level indicator
Recharge performance	3-level indicator

## Wi-Fi

### Standards compliance

Wi-Fi standards	Transmission method
IEEE802.11b	DS-SS modulation
IEEE802.11g	OFDM modulation
IEEE802.11n	

### Transmission frequency (Center frequency)

Frequency	2412 – 2462 MHz
Channels	1 – 11 channels

### Connection, authentication, and data encryption methods

Connection method	Authentication	Encryption
Camera access point	WPA2-PSK	AES
	Open	Disable
Infrastructure	Open	WEP
		Disable
	Shared key	WEP
	WPA-PSK	TKIP AES
WPA2-PSK		

## Bluetooth

**Standards compliance:** Bluetooth Specification Version 4.1 compliant (Bluetooth Low Energy Technology)

**Transmission method:** GFSK modulation

## Dimensions and weight

Dimensions (W×H×D)	Approx. 131.0 × 102.6 × 76.2 mm / 5.16 × 4.04 × 3.00 in.
Weight	Approx. 515 g / 18.17 oz. (including battery pack and card)/Approx. 471 g / 16.61 oz. (body only)

## Operating environment

Working temperature range	0 – 40°C (32 – 104°F)
Working humidity	85% or less

- All data above is based on Canon testing standards and CIPA (Camera & Imaging Products Association) testing standards and guidelines.
- Dimensions and weight listed above are based on CIPA Guidelines (except weight for camera body only).
- Product specifications and appearance are subject to change without notice.
- If a problem occurs with a non-Canon lens attached to the camera, contact the respective lens manufacturer.

# Trademarks and Licensing

---

[✔ Trademarks](#)

[✔ About MPEG-4 Licensing](#)

[✔ Accessories](#)

## Trademarks

---

- Adobe is a trademark of Adobe Systems Incorporated.
- Microsoft and Windows are trademarks or registered trademarks of Microsoft Corporation in the United States and/or other countries.
- App Store and macOS are trademarks of Apple Inc., registered in the U.S. and other countries.
- Google Play and Android are trademarks of Google LLC.
- IOS is a trademark or registered trademark of Cisco in the U.S. and other countries and is used under license.
- QR Code is a trademark of Denso Wave Inc.
- SDXC logo is a trademark of SD-3C, LLC.
- HDMI, HDMI logo, and High-Definition Multimedia Interface are trademarks or registered trademarks of HDMI Licensing LLC.
- The Wi-Fi CERTIFIED logo and the Wi-Fi Protected Setup mark are trademarks of the Wi-Fi Alliance.
- The Bluetooth® word mark and logos are registered trademarks owned by Bluetooth SIG, Inc. and any use of such marks by Canon Inc. is under license. Other trademarks and trade names are those of their respective owners.
- All other trademarks are the property of their respective owners.

## About MPEG-4 Licensing

---

"This product is licensed under AT&T patents for the MPEG-4 standard and may be used for encoding MPEG-4 compliant video and/or decoding MPEG-4 compliant video that was encoded only (1) for a personal and non-commercial purpose or (2) by a video provider licensed under the AT&T patents to provide MPEG-4 compliant video. No license is granted or implied for any other use for MPEG-4 standard."

THIS PRODUCT IS LICENSED UNDER THE AVC PATENT PORTFOLIO LICENSE FOR THE PERSONAL USE OF A CONSUMER OR OTHER USES IN WHICH IT DOES NOT RECEIVE REMUNERATION TO (i) ENCODE VIDEO IN COMPLIANCE WITH THE AVC STANDARD ("AVC VIDEO") AND/OR (ii) DECODE AVC VIDEO THAT WAS ENCODED BY A CONSUMER ENGAGED IN A PERSONAL ACTIVITY AND/OR WAS OBTAINED FROM A VIDEO PROVIDER LICENSED TO PROVIDE AVC VIDEO. NO LICENSE IS GRANTED OR SHALL BE IMPLIED FOR ANY OTHER USE. ADDITIONAL INFORMATION MAY BE OBTAINED FROM MPEG LA, L.L.C. SEE [HTTP://WWW.MPEGLA.COM](http://www.mpegla.com)

\* Notice displayed in English as required.

## Accessories

---

### **Use of genuine Canon accessories is recommended**

This product is designed to achieve optimum performance when used with genuine Canon accessories. Therefore, using this product with genuine accessories is highly recommended. Canon shall not be liable for any damage to this product and/or accidents such as malfunction, fire, etc. caused by the failure of non-genuine Canon accessories (e.g., a leakage and/or explosion of a battery). Please note that repairs arising out of the malfunction of non-genuine accessories will not be covered by the warranty for repairs, although you may request such repairs on a chargeable basis.

#### **Caution**

- Battery Pack LP-E17 is dedicated to Canon products only. Using it with an incompatible battery charger or product may result in malfunction or accidents for which Canon cannot be held liable.