

LED projector

User Manual

ZenBeam L2



COPYRIGHT AND WARRANTY INFORMATION

No part of this manual, including the products and software described in it, may be reproduced, transmitted, transcribed, stored in a retrieval system, or translated into any language in any form or by any means, except documentation kept by the purchaser for backup purposes, without the express written permission of ASUSTeK COMPUTER INC. ("ASUS").

Product warranty or service will not be extended if: (1) the product is repaired, modified or altered, unless such repair, modification or alteration is authorized in writing by ASUS; or (2) the serial number of the is defaced or missing.

ASUS PROVIDES THIS MANUAL "AS IS" WITHOUT WARRANTY OF ANY KIND, EITHER EXPRESS OR IMPLIED, INCLUDING BUT NOT LIMITED TO THE IMPLIED WARRANTIES OR CONDITIONS OF MERCHANTABILITY OR FITNESS FOR A PARTICULAR PURPOSE. IN NO EVENT SHALL ASUS, ITS DIRECTORS, OFFICERS, EMPLOYEES OR AGENTS BE LIABLE FOR ANY INDIRECT, SPECIAL, INCIDENTAL, OR CONSEQUENTIAL DAMAGES (INCLUDING DAMAGES FOR LOSS OF PROFITS, LOSS OF BUSINESS, LOSS OF USE OR DATA, INTERRUPTION OF BUSINESS AND THE LIKE), EVEN IF ASUS HAS BEEN ADVISED OF THE POSSIBILITY OF SUCH DAMAGES ARISING FROM ANY DEFECT OR ERROR IN THIS MANUAL OR PRODUCT.

Products and corporate names appearing in this manual may or may not be registered trademarks or copyrights of their respective companies, and are used only for identification or explanation and to the owners' benefit, without intent to infringe.

SPECIFICATIONS AND INFORMATION CONTAINED IN THIS MANUAL ARE FURNISHED FOR INFORMATIONAL USE ONLY, AND ARE SUBJECT TO CHANGE AT ANY TIME WITHOUT NOTICE, AND SHOULD NOT BE CONSTRUED AS A COMMITMENT BY ASUS. ASUS ASSUMES NO RESPONSIBILITY OR LIABILITY FOR ANY ERRORS OR INACCURACIES THAT MAY APPEAR IN THIS MANUAL, INCLUDING THE PRODUCTS AND SOFTWARE DESCRIBED IN IT.

Copyright © 2023 ASUSTeK COMPUTER INC. All Rights Reserved.

LIMITATION OF LIABILITY

Circumstances may arise where because of a default on ASUS' part or other liability, you are entitled to recover damages from ASUS. In each such instance, regardless of the basis on which you are entitled to claim damages from ASUS, ASUS is liable for no more than damages for bodily injury (including death) and damage to real property and tangible personal property; or any other actual and direct damages resulted from omission or failure of performing legal duties under this Warranty Statement, up to the listed contract price of each product.

ASUS will only be responsible for or indemnify you for loss, damages or claims based in contract, tort or infringement under this Warranty Statement.

This limit also applies to ASUS' suppliers and its reseller. It is the maximum for which ASUS, its suppliers, and your reseller are collectively responsible.

UNDER NO CIRCUMSTANCES IS ASUS LIABLE FOR ANY OF THE FOLLOWING: (1) THIRD-PARTY CLAIMS AGAINST YOU FOR DAMAGES; (2) LOSS OF, OR DAMAGE TO, YOUR RECORDS OR DATA; OR (3) SPECIAL, INCIDENTAL, OR INDIRECT DAMAGES OR FOR ANY ECONOMIC CONSEQUENTIAL DAMAGES (INCLUDING LOST PROFITS OR SAVINGS), EVEN IF ASUS, ITS SUPPLIERS OR YOUR RESELLER IS INFORMED OF THEIR POSSIBILITY.

SERVICE AND SUPPORT

Visit our multi-language web site at <https://www.asus.com/support>.

Table of Contents

About this manual	5
Conventions used in this manual	6
Typography.....	6
Multi-language versions	6
Safety precautions	7
Using your LED projector.....	7
Servicing and replacement of parts	7
Caring for your LED projector	8
Battery precautions	8
Proper disposal.....	9

Chapter 1: Getting to know your LED projector

Features	12
Top view.....	12
Front view.....	14
Rear view	16
Bottom view	20
LED projector remote control	21
Replacing the battery	24

Chapter 2: Setting up

Getting started.....	26
Install the Android TV Box.....	26
Connect your LED projector to the power adapter.....	29
Connect the LED projector to other devices	32
Adjust the height of the LED projector.....	35
Press the power button.....	37
Auto adjust the image focus	38

Chapter 3: Using the on-screen display menu

Using your LED projector for the first time	40
On-screen display (OSD) home page.....	41
Configuration menu options	43

Using screen casting or mirroring.....	51
Screen casting.....	51
Screen mirroring	52
Using Android TV	53
Navigating Android TV	53
Downloading and installing an app	55
Using the Android TV Box with another host device.....	56
Using Light Wall	57
Starting Light Wall.....	57
Light Wall main menu	58
Updating your LED projector.....	60
Adjusting the volume on the Android TV box.....	61
Putting your LED projector in Standby mode.....	62
Powering off your LED projector	63
Appendices	
Specifications for ZenBeam L2 LED projector	72
Supported PC Timings.....	75

About this manual

This manual provides information about the hardware and software features of your LED projector through the following chapters:

Chapter 1: Getting to know your LED projector

This chapter details the parts of your LED projector and its accompanying remote control.

Chapter 2: Setting up

This chapter shows you how to set up your LED projector and use its parts for input device connection.

Chapter 3: Using the on-screen display menu

This chapter talks about the features of your LED projector's on-screen display menu and how to navigate it using the control panel.

Appendices

This section includes safety notices for your LED projector.

Conventions used in this manual

To highlight key information in this manual, some text are presented as follows:

IMPORTANT! This message contains vital information that must be followed to complete a task.

NOTE: This message contains additional information and tips that can help complete tasks.

WARNING! This message contains important information that must be followed to keep you safe while performing tasks and prevent damage to your LED projector's data and components.

Typography

Bold This indicates a menu or an item that must be selected.

Italic This indicates a section that you can refer to in this manual.

Multi-language versions

Download other language versions of this User Manual via this website:
<https://www.asus.com/support>

Safety precautions

Using your LED projector

- Refer to the manual and take note of the safety instructions before operating your LED projector.
- Follow the notes and warnings stated in the user manual.
- Do not place your LED projector on uneven or unstable surfaces.
- Do not use your LED projector in smoky environments. Smoke residue may cause build-up on critical parts and damage the LED projector or decrease its performance.
- Keep the LED projector's plastic packages out of the reach of children.
- Do not block or place anything near the LED projector's ventilation holes. Doing so may cause internal heat build-up that can degrade picture quality and damage the projector.
- Ensure that the operating voltage of your LED projector matches the voltage of your power source.

Servicing and replacement of parts

- Do not disassemble or attempt to service this LED projector by yourself. Contact your local ASUS service center for assistance.
- When replacing parts of your LED projector, purchase items as specified by ASUS and contact your local service center for assistance.

Caring for your LED projector

- Switch off then unplug the LED projector from the power outlet before cleaning it.
- When cleaning the LED projector's housing, use a clean soft cloth dampened with water or a mix of water and neutral detergent. Wipe it dry using a soft dry cloth.
- Ensure that the lens is cool before cleaning it. Gently wipe the lens using a lens cleaning paper. Do not touch the lens with your hands.
- Do not use liquid or aerosol cleaners, benzene, or thinners on your LED projector.
- Never operate this LED projector immediately after moving it from a cold location. When the LED projector is exposed to a drastic change in temperature, moisture may condense on the lens and its other internal parts. To prevent this, use the unit two (2) hours after an extreme or sudden change in temperature occurs.

Battery precautions

- When replacing the battery, do not replace it with an incorrect type that can defeat the safeguard.
- Do not dispose the battery into fire or a hot oven, or mechanically crushing or cutting the battery, as doing so may lead to an explosion.
- Leaving the battery in an environment with extremely high temperature may lead to an explosion, or the leakage of flammable liquid or gas.
- A battery subjected to extremely low air pressure may lead to an explosion, or the leakage of flammable liquid or gas.
- When the main power input is disconnected from the device, the disconnected device should still remain readily operable.

Proper disposal



Do not throw your LED projector in municipal waste. This product has been designed to enable proper reuse of parts and recycling. The symbol of the crossed out wheeled bin indicates that the product (electrical, electronic equipment and mercury-containing button cell battery) should not be placed in municipal waste. Check local regulations for disposal of electronic products.



Do not throw the battery in municipal waste. The symbol of the crossed out wheeled bin indicates that the battery should not be placed in municipal waste.

Chapter 1:
***Getting to know your LED
projector***

Features

Top view

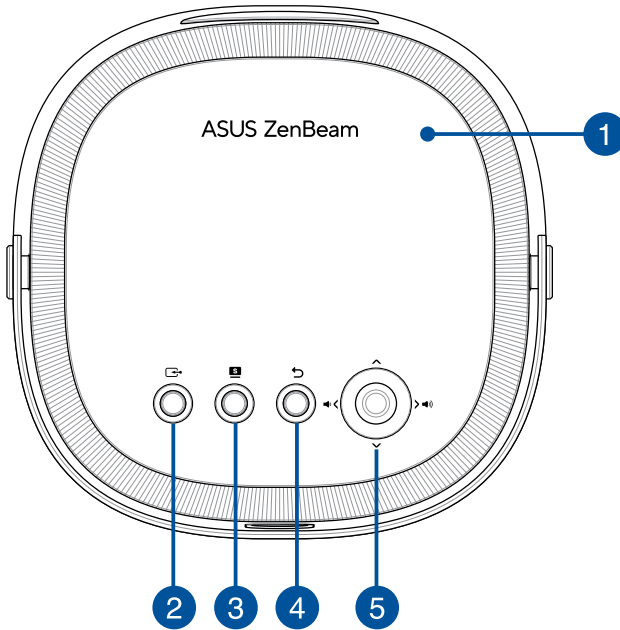

1 Projector Cover

This removable magnetic cover allows access to the connectors for installing the Android TV box bundled with your LED projector.

2 Input

This button is used to change the input source.

Available options: **Android TV**, **HDMI**, and **USB-C**.

3 Splendid

This button is used to access the Splendid menu to select one of preset display modes. For more details on the options in this menu, refer to the *Configuration menu options* section.

NOTE: The Splendid menu cannot be accessed when **Auto HDR/HLG** is enabled, and HDR video content is being projected.

4 Back

This button is used to return to the previous menu or page.

5 Joystick Navigation button

This button allows you to navigate the on-screen display menu and select menu settings and also corresponds to specific projector settings as indicated below.

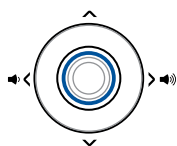

Open main menu/OK
(push center down)

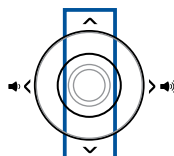

Adjust focus
(up/down)

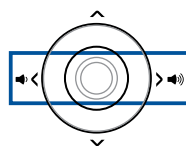

Adjust volume
(left/right)

NOTE:

- The buttons on the projector cover are only for controlling the projector and cannot control Android TV. For control of Android TV, use the remote control that came with the Android TV box.
 - For more information on using the control panel buttons to access your LED projector's settings, refer to *Chapter 3: Using your LED projector*.
-

Front view

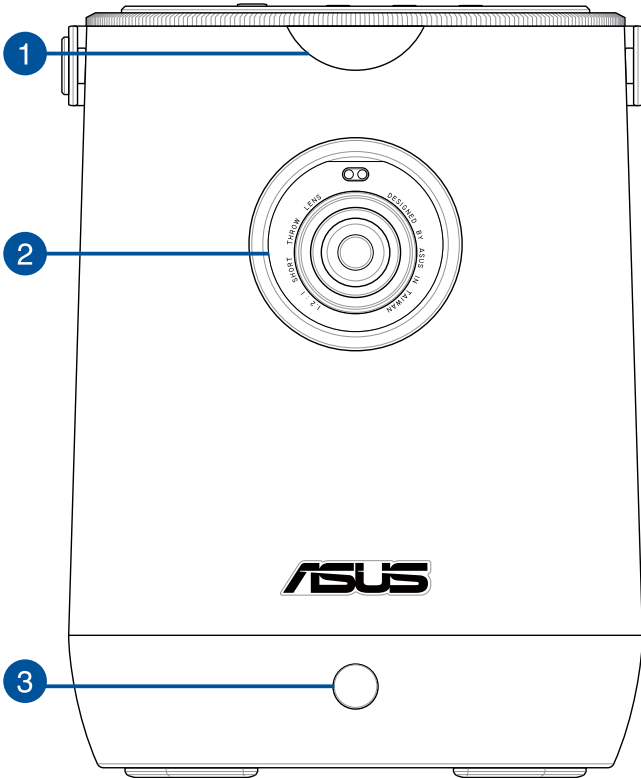

1 Front Remote sensor

The remote sensor detects signal from your LED projector's remote control, allowing you to access the LED projector's control panel from a distance of up to 3 meters and a receiving angle of ± 30 degrees when the remote is directly in front of the remote sensor.

2 Lens

The lens projects video or image files onscreen from your input device.

WARNING! Do not touch the lens using your hands or any sharp object.

NOTE: Remove the clear protective film covering the lens before use.

3 Auto-focus Camera

This camera makes it possible for the projector to quickly and automatically adjust the focus of images.

NOTE: If you drop or hit your LED projector against a hard surface, the camera may become misaligned, and the **Auto Focus**, **Auto Keystone**, **Smart Avoidance**, and **Screen Alignment** features may not work as intended. However, you will still be able to make adjustments manually. If you notice any abnormality, contact your local ASUS service center for assistance.

Rear view

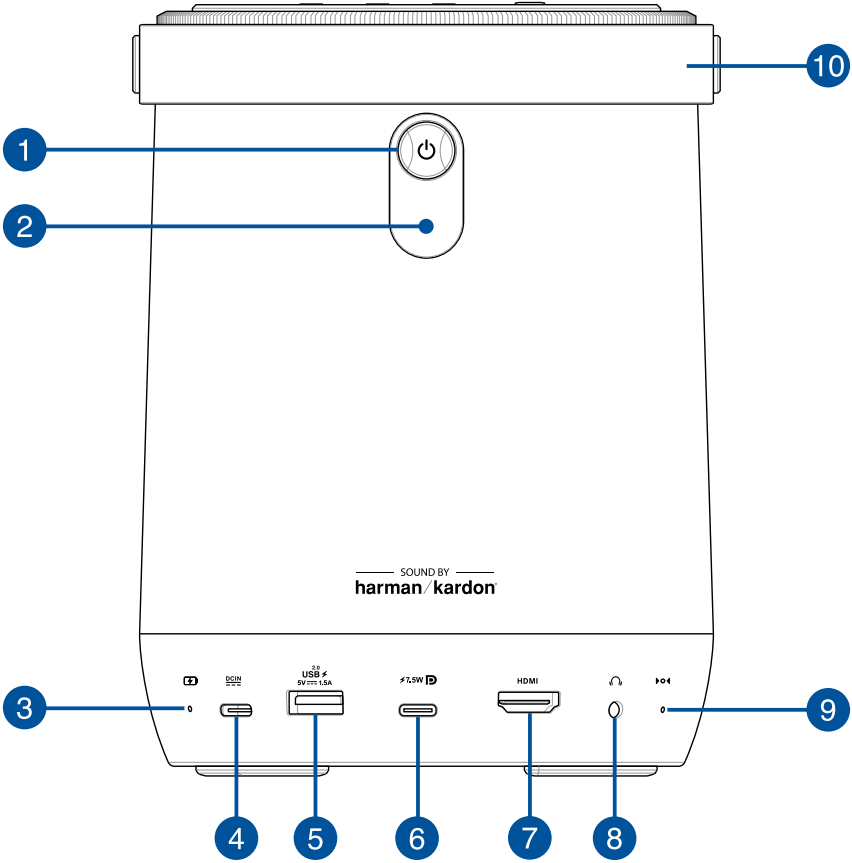

1 Power button

Press this power button to turn on or turn off your LED projector. The LED indicator on this button indicates the following scenarios for your LED projector:

LED Color	Status
White	The LED projector is powered on, and the battery power is more than 25%.
White (breathing)	The LED projector is in standby mode, and the battery power is more than 25%.
Red	The LED projector is running on battery mode only, and the battery power is less than 25%.
Red (breathing)	The LED projector is in standby mode, and the battery power is less than 25%.

2 Rear Remote sensor

The remote sensor detects signal from your LED projector's remote control, allowing you to access the LED projector's control panel from a distance of up to 3 meters and a receiving angle of ± 30 degrees when the remote is directly behind the remote sensor.

3 Battery charge indicator

This LED indicator lights up when the LED projector is plugged to a power source using its power adapter.

IMPORTANT! Use only the bundled power adapter to charge the battery pack and supply power to your LED projector.

LED Color	Status
Red	Battery charging
Green	Battery fully charged

4 Power (DC) input port

Insert the bundled power adapter into this port to charge the battery pack and supply power to your LED projector.

IMPORTANT! Use only the bundled power adapter to charge the battery pack and supply power to your LED projector.

WARNING! The adapter may become warm to hot while in use. DO NOT cover the adapter and keep it away from your body while it is connected to a power source.

5 USB 2.0 Type-A port

This USB 2.0 port provides up to 5 V / 1.5 A of output voltage and current. You can connect your mobile device to this port to keep it charged while using it with your LED projector.

6 USB Type-C® port

This USB Type-C® port provides the following:

- DisplayPort (DP) Alt-mode signal that supports a 1920 x 1080 resolution
- USB power delivery with a maximum of 5 V / 1.5 A output
- Maximum resolution of 1920 x 1080.

7 HDMI™ port

This port is for the HDMI™ (High-Definition Multimedia Interface) connectors. This port is HDCP compliant for HD DVD, Blu-ray, and other protected content playback.

NOTE: This port will support a resolution of up to 3840 x 2160. The resolution may be affected by the cabling and output device.

8 Audio output jack port

The audio output jack port allows you to connect your LED projector to amplified speakers or headphones.

9 Manual reset pinhole

If your LED projector is unresponsive, insert a straightened paper clip into this pinhole to turn off your LED projector, then press the power button to turn on your LED projector again.

10 Leather handle

This handle allows you to easily carry your LED projector without the need for a bag.

Bottom view

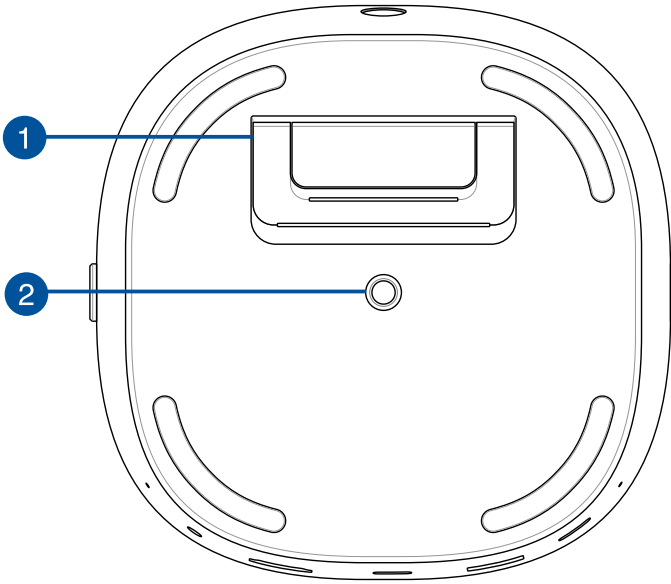

1 Built-in stand

This LED projector comes with a built-in stand that allows you to tilt the projector at a 4 or 8 degree angle.

2 Tripod socket

Attach the LED projector to a tripod with a 1/4-20UNC mounting screw using this socket.

NOTE: This socket should only be used with tripods that are less than 1 meter in height.

LED projector remote control

NOTE: Actual appearance may vary depending on the model.

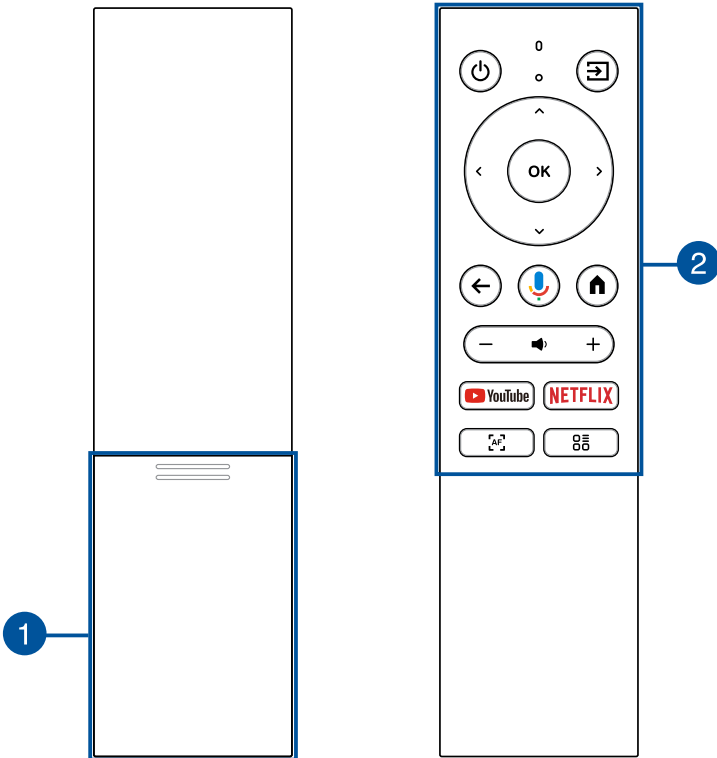

1 Battery compartment

The battery compartment allows you to install two (2) AAA batteries to power your LED projector's remote control.

NOTE: For more details on using the battery compartment, refer to the *Replacing the battery* section in this manual.

2**Remote control buttons**

These buttons allow you to navigate your LED projector's on-screen display menu from a distance of up to 3 meters.

**Power**

Press this button to turn your LED projector on or off.

**Input**

Press this button to change the input source.

**Up**

Press this button to move up.

**Down**

Press this button to move down.

**Left**

Press this button to move left.

**Right**

Press this button to move right.

**OK**

Press this button to launch the OSD menu or confirm a menu selection.

**Back**

Press this button to go back to the previous screen.

**Google Assistant**

Press this button to turn on the microphone to talk to Google Assistant to give a command or ask a question.

**Home**

Press this button to return to the home page.

— **Volume down**

Press this button to decrease the volume. Long press to mute.

+ **Volume up**

Press this button to increase the volume.

 **YouTube**

Press this button for quick access to YouTube.

NETFLIX **Netflix**

Press this button for quick access to Netflix.

 **Autofocus**

Press this button to activate autofocus.

 **On-screen Display (OSD) menu**

Press this button to bring up the OSD menu.

NOTE:

- You may use the remote control or navigate using either the remote control or the joystick navigation button on your LED projector to navigate through the on-screen display. For more details on the on-screen display menu, refer to the *Using the on-screen display menu* section.
 - When using Android TV, use the remote control to adjust the volume.
-

Replacing the battery

- A. Push the battery compartment downwards to remove the battery compartment cover.

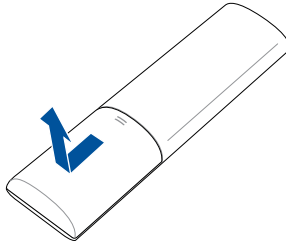

- B. Remove the old batteries, then insert two (2) new AAA batteries into the battery compartment.

NOTE: Take note of the direction of the batteries when installing them.

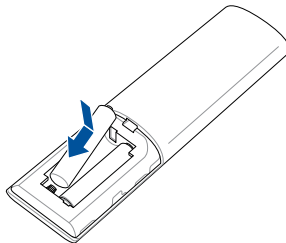

- C. Slide the battery compartment cover back onto the remote control, then push upwards to secure it.

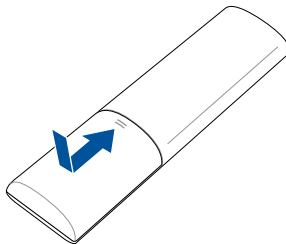

Chapter 2: **Setting up**

Getting started

This LED projector allows you to plug and play your devices, so you can easily open multimedia files and hear audio straight from its built-in Harman Kardon speakers.

For your safety and to maintain the quality of this unit, refer to the following steps when operating your LED projector.

Install the Android TV Box

- A. Wedge your fingers under the edge of the magnetic projector cover and use the tips of your fingers to lift the cover from the body.
- B. Unlock the retaining clip and rotate it into a vertical position to allow access to the cavity for the Android TV box.

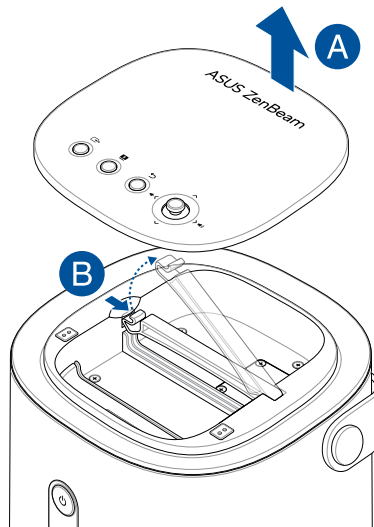

- C. Connect the mini USB cable from your LED projector to the micro USB port on the Android TV box.

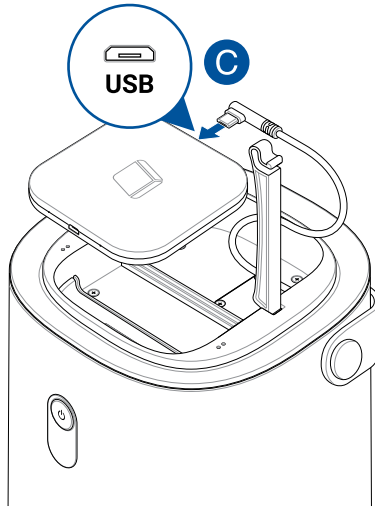

- D. Align and connect the HDMI port on the Android TV to the HDMI connector on your LED projector by gently sliding the Android TV box towards the HDMI connector.

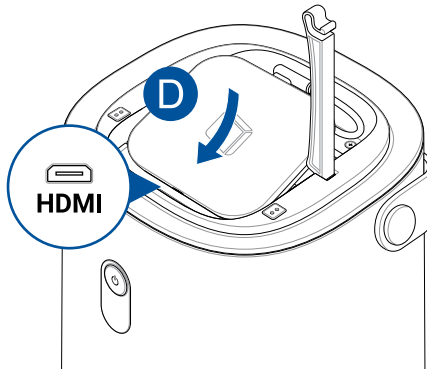

- E. Return the retaining clip to its original horizontal position, and press down until you hear a soft click.
- F. Replace the magnetic project cover.

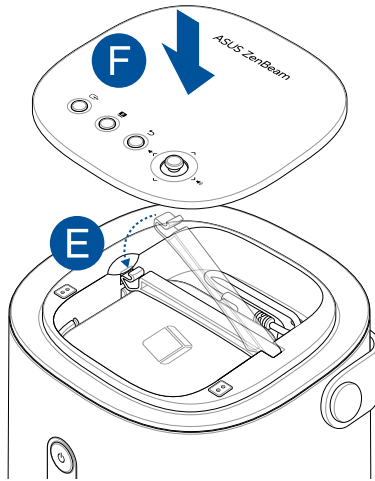

To watch a video tutorial that guides you through the Android TV box installation process, go to <https://www.youtube.com/watch?v=SLrs83-oo-s>.



NOTE:

- The cable and connectors within the top cavity are designed to work only with the bundled Android TV box.
 - To connect other Android TV boxes to your LED projector, use the HDMI and USB 2.0 ports on the rear side of your LED projector. Refer to the *Rear view* section for the location of the ports.
 - To use the bundled Android TV box with another host device, refer to *Using the Android TV box with another host device* in the Appendices.
-

Connect your LED projector to the power adapter

- A. Connect the AC/DC power cord to the power adapter.
- B. Connect the DC power connector to your LED projector.
- C. Connect the AC power cord to a power source.

Power adapter information:

- Input voltage: 100-240Vac
- Input frequency: 50-60Hz
- Rating output current: 4.5A max. (90W)
- Rating output voltage: 20V

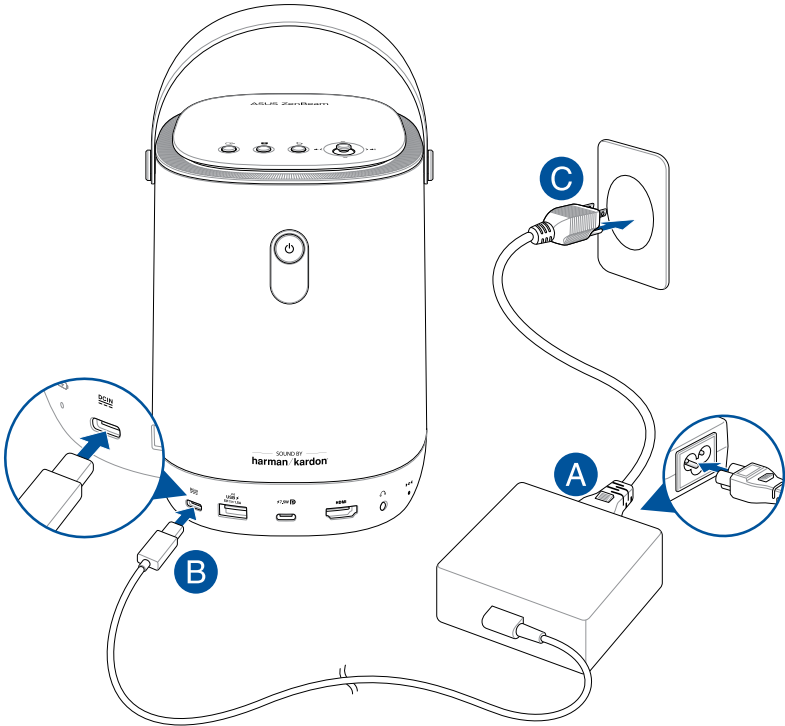

IMPORTANT!

- Use only the bundled power adapter to charge the internal battery and supply power to your LED projector.
 - Only connect your LED projector to a USB-C adapter or mobile charger that supports at least 20 V / 3 A PD when using the USB-C® port as a power (DC) input port.
 - Ensure that your LED projector is connected to the power adapter before turning it on for the first time. We strongly recommend that you use a grounded wall socket while using your LED projector on power adapter mode.
 - The socket outlet must be easily accessible and near your LED projector.
 - To disconnect your LED projector from its main power supply, unplug your LED projector from the power socket.
-

WARNING!

Read the following precautions for your LED projector's battery.

- The battery used in this device may present a risk of fire or chemical burn if removed or disassembled.
 - Follow the warning labels for your personal safety.
 - Risk of explosion if battery is replaced by an incorrect type.
 - Do not dispose of in fire.
 - Never attempt to short-circuit your LED projector's battery.
 - Never attempt to disassemble and reassemble the battery.
 - Discontinue usage if leakage is found.
 - The battery and its components must be recycled or disposed of properly.
 - Keep the battery and other small components away from children.
-

AC power cord requirements

Use the correct AC plug type according to your current location.

IMPORTANT! Contact your sales dealer if the AC power cord bundled with your LED projector does not match your local power source.

NOTE: We highly recommend that you use a video source device that also uses a grounding type plug to prevent signal interference due to voltage fluctuations.

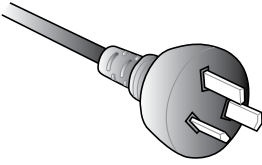

For Australia and Mainland China

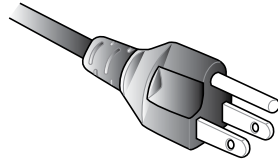

For U.S.A., Canada, and Taiwan

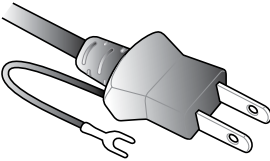

For Japan

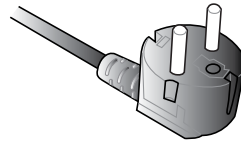

For Continental Europe

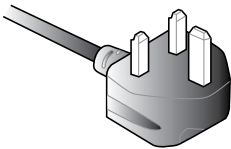

For U.K.

Connect the LED projector to other devices

A. USB Type-C® DP input

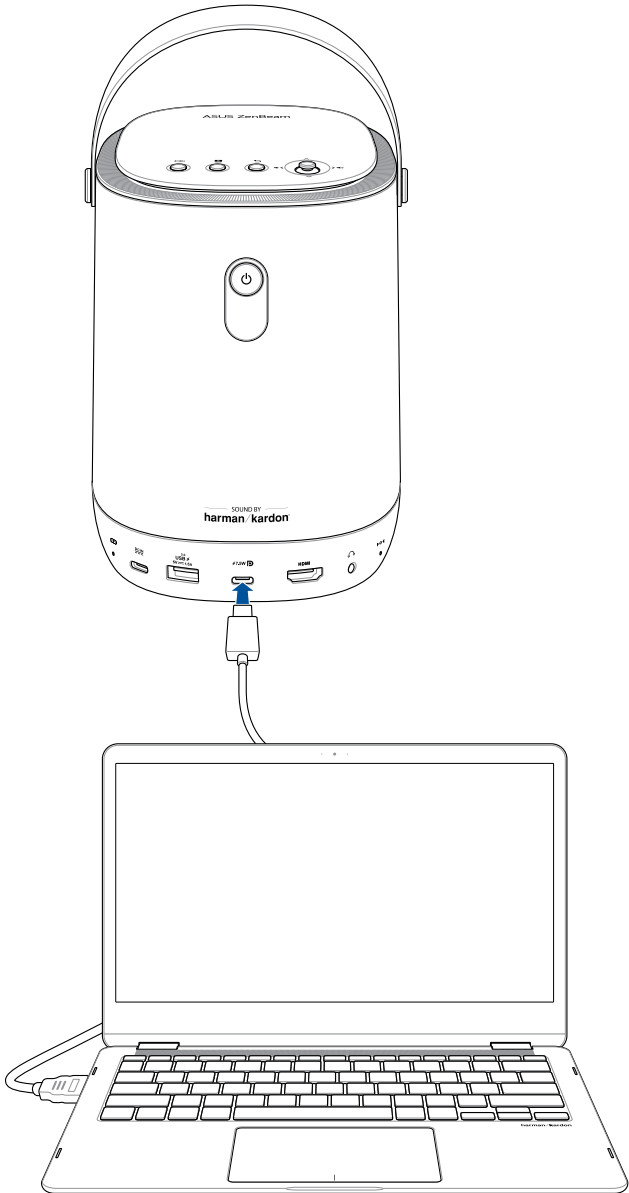

B. Audio output jack

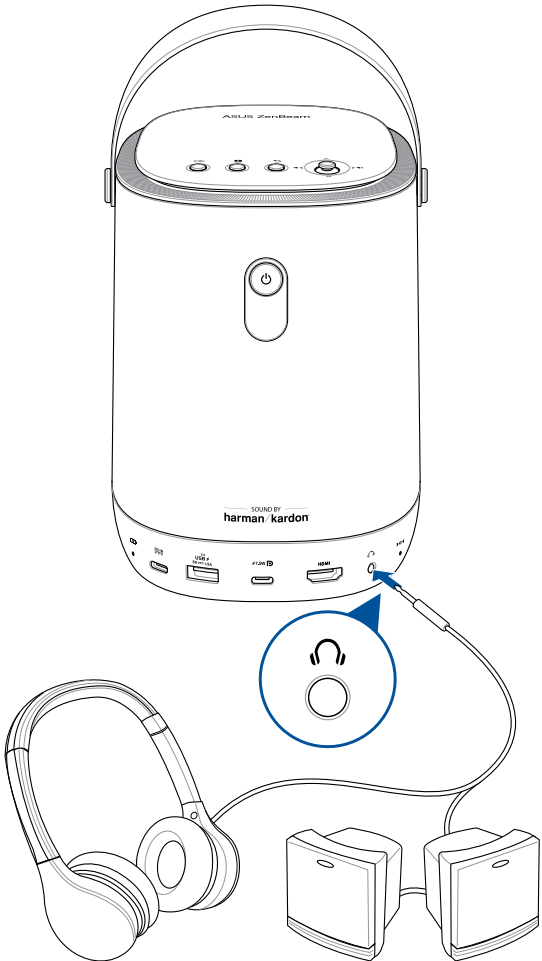

C. HDMI™ input

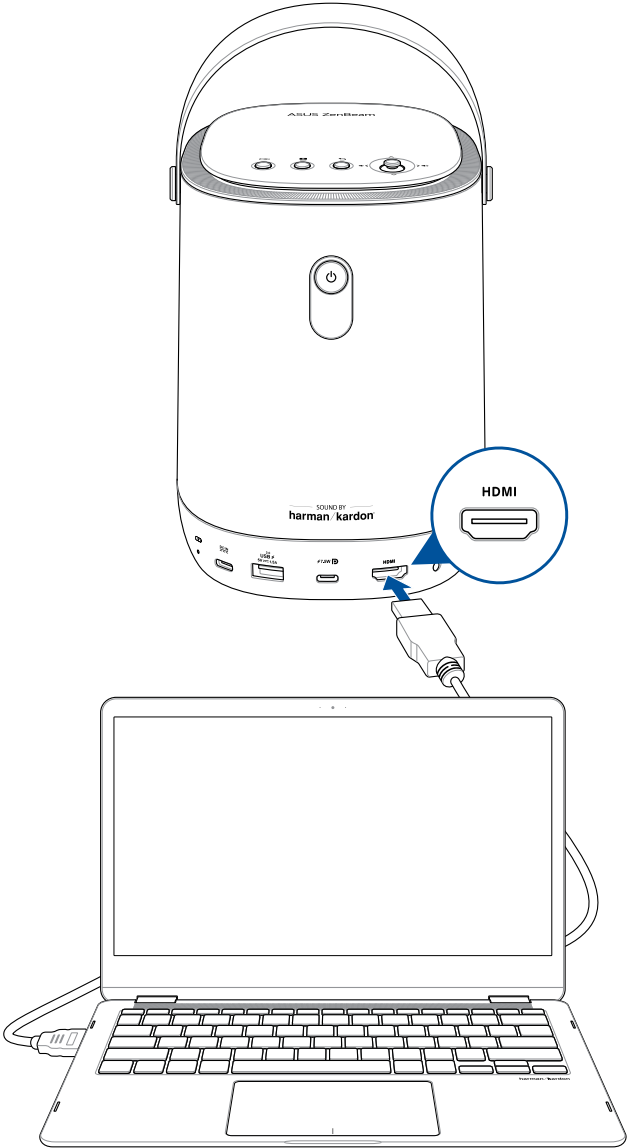

Adjust the height of the LED projector

Your LED projector comes with a built-in stand that helps adjust the image height onscreen.

WARNING! Ensure that the built-in stand is fully retracted before placing the LED projector inside the projector bag.

NOTE:

- Place the LED projector on a stable flat surface.
 - Keep a space of 30 cm or more between the LED projector and any obstructions to prevent overheating.
 - Consult your dealer for special installation procedures like suspending the LED projector from the ceiling.
-

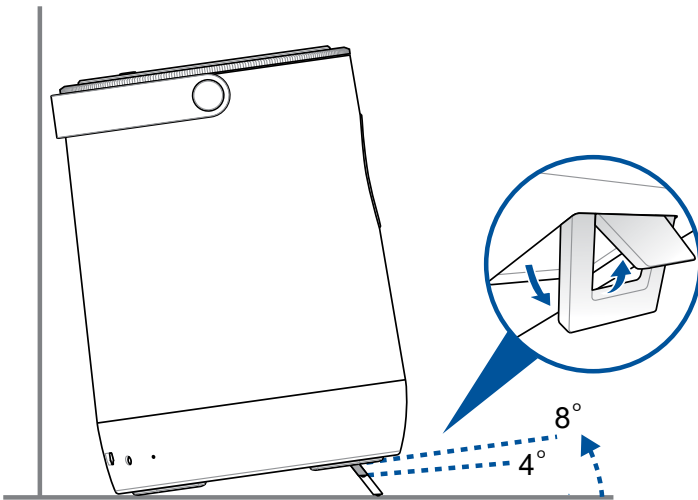

Screen size and projection distance table

Adjust the LED projector's distance from the screen using the table below.

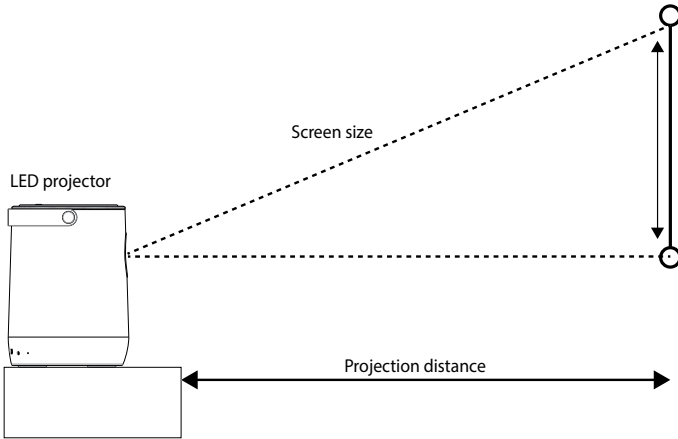

Screen Size						Projection Distance	
Diagonal		Horizontal		Vertical			
inch	mm	inch	mm	inch	mm	inch	mm
30	762	26.14	664	14.72	374	31.29	795
40	1016	34.88	886	19.60	498	41.77	1061
50	1270	43.58	1107	24.52	623	52.24	1327
60	1524	52.28	1328	29.40	747	62.71	1593
70	1778	61	1550	34.33	872	73.07	1856
80	2032	69.72	1771	39.21	996	83.54	2122
90	2286	78.42	1992	44.13	1121	94.05	2389
100	2540	87.12	2213	49.05	1246	104.48	2654
110	2794	95.86	2435	53.93	1370	114.96	2920
120	3048	104.56	2656	58.85	1495	125.39	3185

NOTE: This LED projector's throw ratio is 1.2:1. (Throw Ratio = Throw Distance / Image Width)

Press the power button

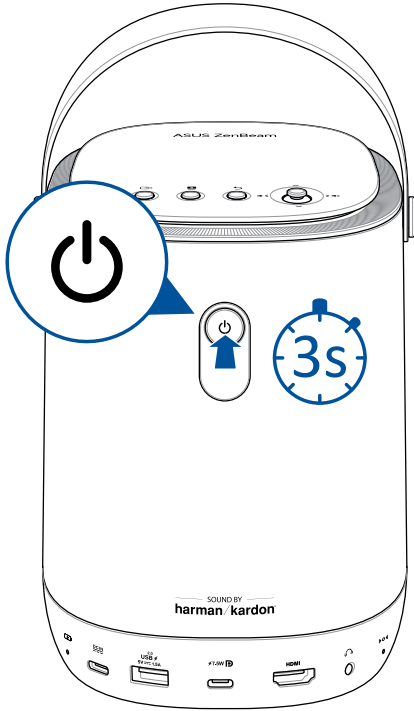



Auto adjust the image focus

Each time that you power on or move your LED projector while it is on triggers autofocus. After autofocus is complete, it will automatically switch and remain in manual focus mode for 3 seconds to allow you to manually adjust the focus as needed. Push up and down on the joystick navigation button (refer to the *Top view* section for the location of the joystick navigation button) to further adjust the focus of the image.

Press the **Autofocus** button  on the remote control at any time to trigger autofocus.

NOTE:

- Press the **Autofocus** button  on the remote control at any time to trigger autofocus; press and hold  on the remote control to trigger manual focus.
 - Use a still image when adjusting the on-screen display.
-

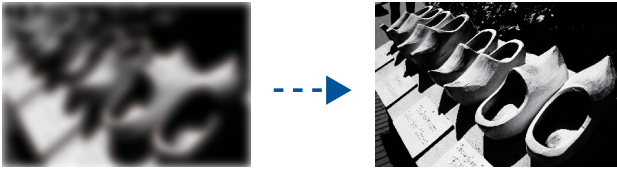

Chapter 3:
***Using the on-screen
display menu***

Using your LED projector for the first time

Refer to the following steps when using your LED projector for the first time.

NOTE: Ensure that your LED projector is connected to the power adapter before turning it on for the first time. We strongly recommend that you use a grounded wall socket while using your LED projector in power adapter mode.

1. Set up your LED projector, and then press the **Power** button.
2. Use the **Left** and **Right** buttons on your LED projector or on your remote control to browse through the available language options.
3. After you have selected your preferred language, press the **OK** button on your LED projector or on your remote control to set this language for use on your LED projector.
4. Follow the on-screen instructions for installing the Android TV box that came with your LED projector.
5. Pair the Android TV remote control with your LED projector by holding the remote control near the TV box and simultaneously pressing the **Volume down** and **OK** buttons on the remote control for approximately 10 seconds until they are paired.
6. Next, select an available network for the LED projector to connect to. You may skip this step for the time being and choose to set up a network connection at a later time.
7. (optional) If you selected an available network to connect to, enter the password for the network connection if required.
8. You may now start using your LED projector for any of the following:
 - To display supported files from your input device
 - To watch media using the Android TV app
 - To mirror the screen of your phone or tablet.

NOTE: To mirror iOS device screens, you will first need to download and install a third party Android app, such as AirScreen, from Google Play Store on your Android TV box.

NOTE: All screenshots are for reference only and may be updated without prior notice. Screenshots may also vary depending on the product model.

On-screen display (OSD) home page

The OSD home page of your LED projector allows you to access all the different functions of your LED projector. Press  on the remote control to open the OSD home page, and then navigate using either the remote control or the joystick navigation button on your LED projector.

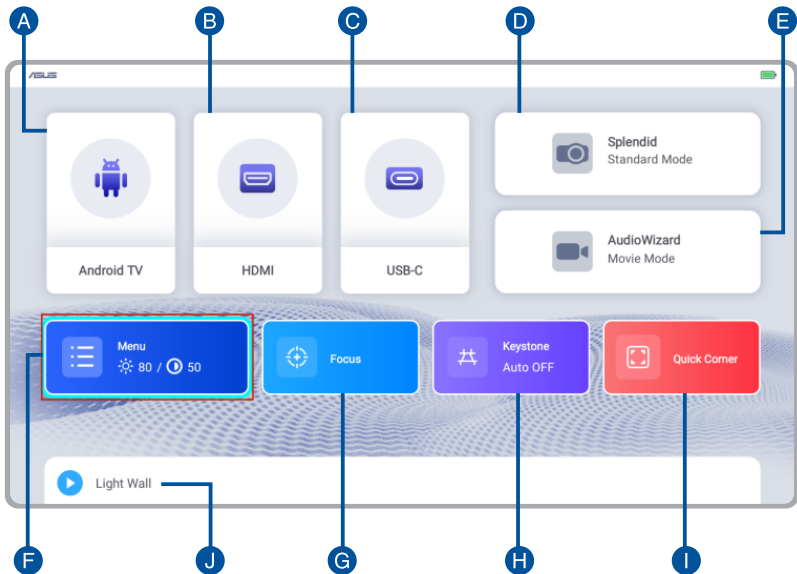

A. **Android TV:** Quick access to Android TV.

IMPORTANT! Not all apps are supported by this LED projector; some apps may require functions not supported by this LED projector, or may be limited to selected firmware versions.

- B. **HDMI:** Toggle to input from an HDMI source.
- C. **USB-C®:** Toggle to accept input from a USB-C source with support for USB-C DP Alt Mode data/video transfers and 7.5 W (5 V / 1.5 A) power delivery.
- D. **Splendid:** Select one of the preset display modes.
- E. **AudioWizard:** Select an preset audio mode.
- F. **Menu:** Opens up a menu to configure settings for your LED projector. Refer to the *Configuration menu options* section for details of each option.
- G. **Focus:** Allows you to manually adjust focus.
- H. **Keystone:** Allows you to correct distorted images resulting from an angled projection.

NOTE: Turn on Auto Keystone for your LED projector to quickly self adjust. To manually adjust keystone, turn off Auto Keystone and then use the **Up** and **Down** buttons on the remote control (or the push the joystick navigation button up and down) to adjust vertical keystone and the **Left** and **Right** buttons on the remote control (or push the joystick navigation button left and right) to adjust horizontal keystone.

- I. **Quick Corner:** Allows you to adjust each corner of your projection onscreen.
- J. **Light Wall:** Helps you set the mood for the room you are in with special ambient lighting effects.

Configuration menu options

Picture

The options under this menu allow you to adjust and fine tune the projection onscreen. Scroll down to display the other menu items.

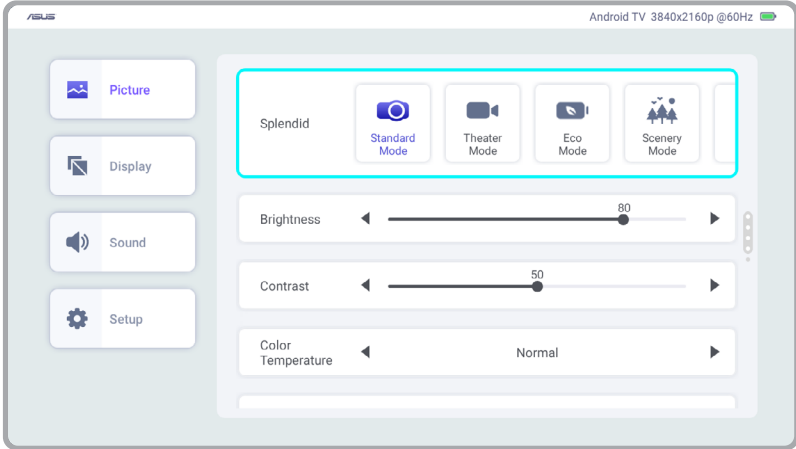

- **Splendid** - Select this menu option to use one of preset display modes.

NOTE:

- The Splendid menu cannot be accessed when **Auto HDR/HLG** is enabled, and HDR video content is being projected.
- Available options while plugged into the power adapter: **Bright Mode, Standard Mode, Theater Mode, Eco Mode, Scenery Mode, Game Mode, and User Mode.**
- Available options in battery mode: **Battery Mode High, Battery Mode Middle, Battery Mode Low, and User Mode.**

Available options: **Bright Mode, Standard Mode, Theater Mode, Eco Mode, Scenery Mode, Game Mode, and User Mode.**

- **Brightness** - Select this menu option to adjust the brightness of your projection onscreen.
- **Contrast** - Select this menu option to adjust the contrast of your projection onscreen.
- **Color Temperature** - This option allows you to adjust the color temperature of your LED projector.
- **Wall Color** - This option allows you to choose a color that is closest to the color of the wall being projected on to automatically adjust for color differences.

Display

The options under this menu allow you to adjust how the projection onscreen is displayed. Scroll down to display the other menu items.

NOTE: If you drop or hit your LED projector against a hard surface, the camera may become misaligned, and the **Auto Focus**, **Auto Keystone**, **Smart Avoidance**, and **Screen Alignment** features may not work as intended. However, you will still be able to make adjustments manually. If you notice any abnormality, contact your local ASUS service center for assistance.

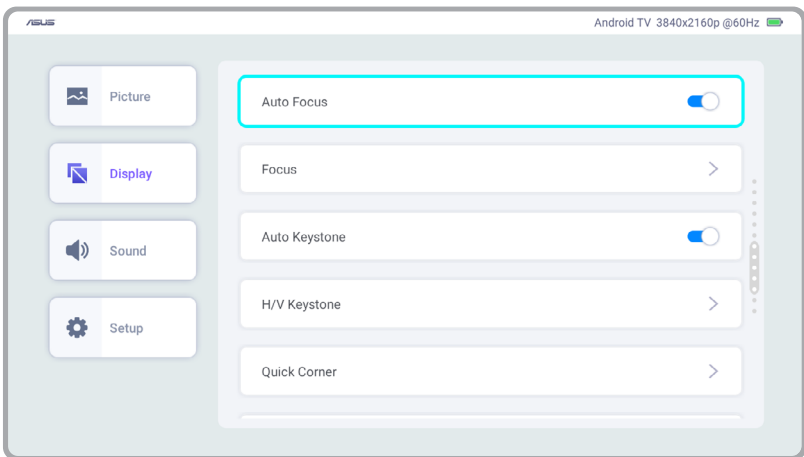

- **Auto Focus** - This option allows you to enable / disable autofocus.
- **Focus** - This option allows you to manually adjust the focus.
- **Auto Keystone** - This option allows you to enable / disable auto keystone correction.
- **H/V Keystone** - This option allows you to manually correct distorted images caused by horizontal or vertical angled projection.

NOTE: Use the **Left** and **Right** buttons on your LED projector or on your remote control to adjust the horizontal keystone, and use the **Up** and **Down** buttons to adjust the vertical keystone.

- **Quick Corner** - This option allows you to adjust each of the four corners of the projected image individually for precise alignment.
 - **Smart Avoidance** - This options allows you to enable / disable Smart Avoidance, which is a feature that automatically detects obstacles that may interfere with the projected image and adjusts the projected image to prevent an obstructed view.
-

NOTE:

- Only obstacles on the projected surface can be detected. Smart Avoidance cannot accurately detect obstacles or shadows between the LED projector and the projected surface.
 - Smart Avoidance adjusts the projected image while ensuring that the aspect ratio remains consistent with the video output (e.g., 16:9).
-

- **Screen alignment** - This option allows your LED projector to optimize the projected image based on the maximum viable projected surface, leveraging auto keystone correction and other technologies.
-

NOTE:

- Ensure that all four (4) detection points are within the alignment frame (not on or outside the frame).
 - The four corners of the alignment frame must be within the projected image.
 - Screen alignment does not restrict the projected image size but instead adjusts the aspect ratio of the projected image to fit the alignment frame (aspect ratio as determined by the alignment frame is prioritized over the video's original aspect ratio).
-

- **Projection Position** - This option allows you to change the way your projections are oriented onscreen based on the current location of your LED projector.
- **Mirror Mode** - Select this menu option to have the projection onscreen be a horizontal reflection of the input source.
- **Auto HDR/HLG** - Select this menu option to toggle on and off Auto HDR/HLG.

- **HDMI EDID** - Select this menu option to allow the source device to retrieve EDID from your LED projector.

Available options: **1.4a** and **2.0 (only for HDMI port)**

- **HDMI Format** - This option allows you to select the HDMI format based on the input source and the desired visual output.

Available options: **Auto**, **HDMI Full Range (0~255)**, and **Limited Range (16~235)**

NOTE: Set to **Auto** to allow your LED projector to automatically switch between full range and limited range based on the information coming from the input source.

- **Aspect Ratio** - Select this menu option to adjust the screen ratio of your projection onscreen.

Sound

The options under this menu allow you to adjust the LED projector's sound settings.

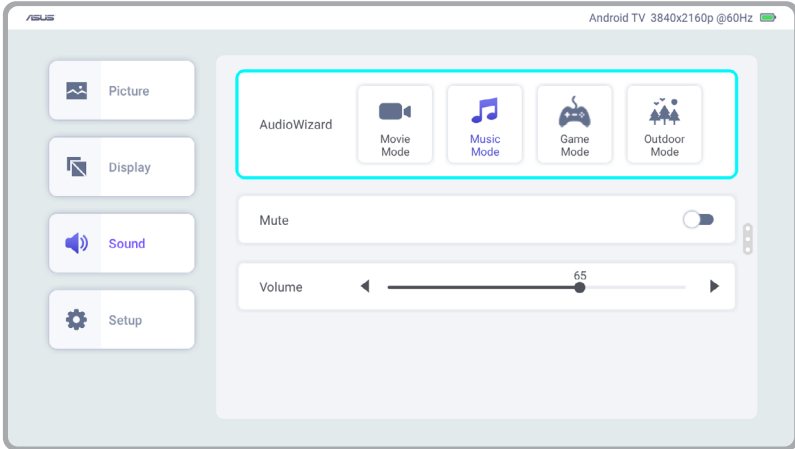

- **AutoWizard** - This option allows you to select a preset audio mode that is best suits the type of audio content being played.
Available options: **Movie Mode**, **Music Mode**, **Game Mode**, and **Outdoor Mode**.
- **Mute** - Toggle this option ON to mute.
- **Volume** - This option allows you to adjust the volume of the audio file being played on your LED projector.

NOTE: If the volume on your LED projector is low even after setting it to its maximum level, it may be that the volume on the Android TV box is set too low. To increase the volume of the Android TV box, refer to the *Adjusting the volume on the Android TV box* section.

Setup

The options under this menu allow you to configure system settings for your LED projector. Scroll down to display the other menu items.

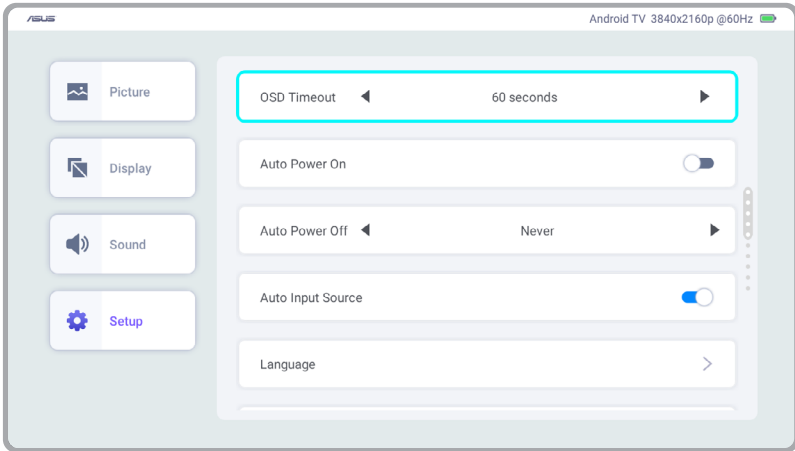

- **OSD Timeout** - This option allows you to set the number of seconds before the on-screen display menu disappears from your projection onscreen.
- **Auto Power On** - This option allows your LED projector to automatically turn on when it is connected to a power source.
- **Auto Power Off** - This option allows you to set the number of minutes before your LED projector automatically shuts down when not in use.
- **Auto Input Source** - This option allows your LED projector to automatically search for connected input sources.
- **Language** - This option allows you to select the language to use on your LED projector's on-screen display menu.
- **Auto Keystone Correction** - This option allows you to further finetune the projected image after using auto keystone and save your customized correction settings for future use.

- **About** - This option allows you to see an overview of information about your LED projector.
- **Reset All** - This option allows you to reset all the settings you have currently set up for your LED projector.
- **System Update** - This option allows you to update the software for your LED projector. Refer to the *Updating your LED projector* section for step-by-step instructions.

Using screen casting or mirroring

The bundled Android TV box with Chromecast built-in allows you to stream from your mobile device (screen casting) or project your mobile device's screen (screen mirroring) to your LED projector. The setup process may differ slightly between Android and iOS mobile devices.

NOTE: A key benefit of screen casting is that it allows you to continue using your mobile device for other things without disrupting what is streaming to your LED projector.

Screen casting

To cast from a Chromecast-enabled app:

1. Open a Chromecast-enabled app, such as YouTube or Netflix.
2. Tap the **Cast** icon  at the top of the app's Home page.
3. From the device list, select **HAKO mini**.
4. Once connected, tap **Play** and your content will start playing from the projector.

Screen mirroring

For Android devices

To mirror your Android device screen:

1. Make sure that the Wi-Fi on your Android device is turned on and connected to the same Wi-Fi network as your LED projector.
2. Download and install the Google Home app  on your Android device.
3. Once installed, open the Google Home app and allow location access when prompted.
4. From the device list, select **HAKO mini**.
5. Tap **Cast my screen** and your entire Android device screen should be mirrored onto the projection onscreen.

For iOS devices

To mirror your iOS device screen:

1. Make sure that the Wi-Fi on your iOS device is turned on and connected to the same Wi-Fi network as your LED projector.
2. Download and install a third-party app, such as AirScreen, on your LED projector.
3. Once installed, open the app and follow the on-screen instructions.
4. When you see a QR code displayed on the projected image, scan it with your iOS device to connect to your LED projector.
5. Swipe down from the upper-right corner of your iOS device's screen to open Control Center, and then tap **Screen Mirroring**.
6. From the device list, select **AS-HAKOmini[AirPlay]**, and your entire iOS device screen should be mirrored onto the projection onscreen.

Using Android TV

Your LED projector is powered with Android TV to provide you an easy way to enjoy the entertainment you love on a big screen.

IMPORTANT! Not all apps are supported by this LED projector; some apps may require functions not supported by it, or may be limited to selected firmware versions.

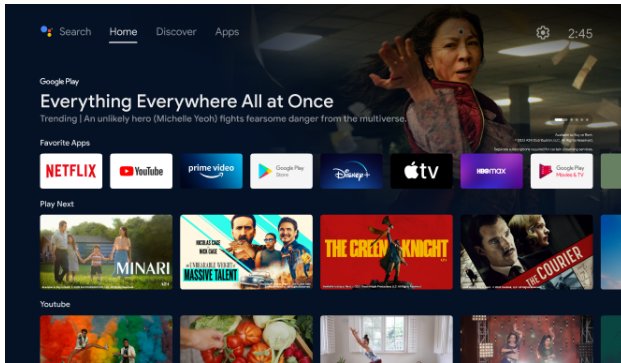

Navigating Android TV

Use the directional buttons on your remote control to navigate through the app or you can also use your mobile device as a virtual remote control to navigate Android TV if you have either the Google Home or Google TV app installed.

To use your mobile device as a remote with Google Home:

1. Make sure that your mobile device is paired with your LED projector and connected on the same Wi-Fi network.
2. Open the Google Home app on your mobile device.
3. Tap **Devices** at the bottom of the app, and then select **HAKO mini**.
4. Tap **Remote** (on an iPhone) or **Open remote** (on an Android phone) and enter the code shown on the projected image to use your mobile device as a virtual remote control.



NOTE: Full remote may be unavailable if you do not have the latest software installed on your LED projector and on your mobile device.

To your mobile device as a remote with Google TV:

1. Make sure that your mobile device is paired with LED projector and connected on the same Wi-Fi network.
2. Open the Google TV app on your mobile device.
3. Near the bottom right of the app, tap **Connect TV**, and then select **HAKO mini**.
4. Tap the **Remote** icon , and enter the code shown on the projected image to use your mobile device as a virtual remote control.

NOTE: Full remote may be unavailable if you do not have the latest software installed on your LED projector and on your mobile device.

Downloading and installing an app

Go to the **Discover** and **Apps** tabs to browse through apps to download. You may also select  **Search** in the Android TV app or press the Google Assistant button  on your remote control to use the voice search function to find a specific app to download and install.

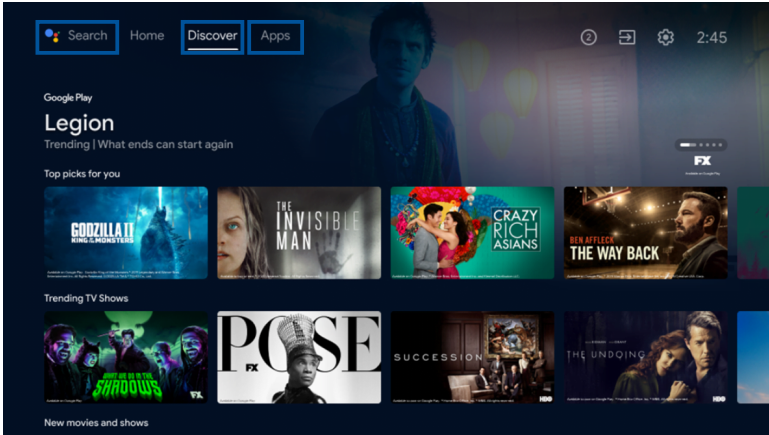

Using the Android TV Box with another host device



Follow the steps below to use the bundled Android TV box with another host device, such as a TV.

1. Connect the Android TV box to the host device as shown in the illustration.

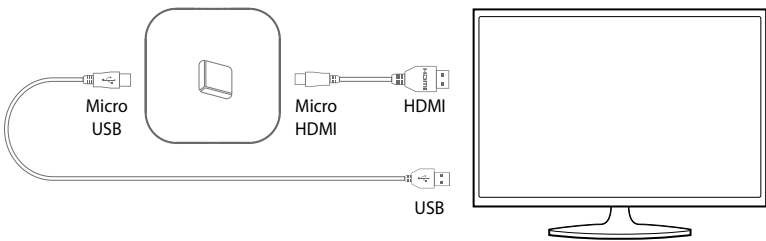
CAUTION! Before making any connections, ensure to power off all devices and disconnect them from their power source to prevent electrical hazards and potential damage to the devices.



NOTE:

- The micro HDMI to HDMI and micro USB to USB cables are not included and must be purchased separately.
 - Make sure that the USB port on the host device can supply a minimum of 5 V / 1.5 A power output. If it cannot supply this power output, you will need to using a power adapter to connect to an AC power outlet.
-
2. Plug your host device's power cord to an AC outlet, and turn on the host device.
 3. Press and hold simultaneously  and  on the remote control for at least 5 seconds or until the LED indicators on the remote control turns from solid red to blinking red and then turns off to initiate Bluetooth pairing between the remote control and the Android TV box.

Using Light Wall

With the Light Wall feature that's included with your LED projector, you can set the ideal ambiance for your mood by selecting one of more than 25 ready-made animations to project onto a surface of your choice.

Starting Light Wall

1. Press  on the remote control to bring up the OSD menu.
2. Navigate to Light Wall at the bottom of the Home page using the remote control, and press **OK**.

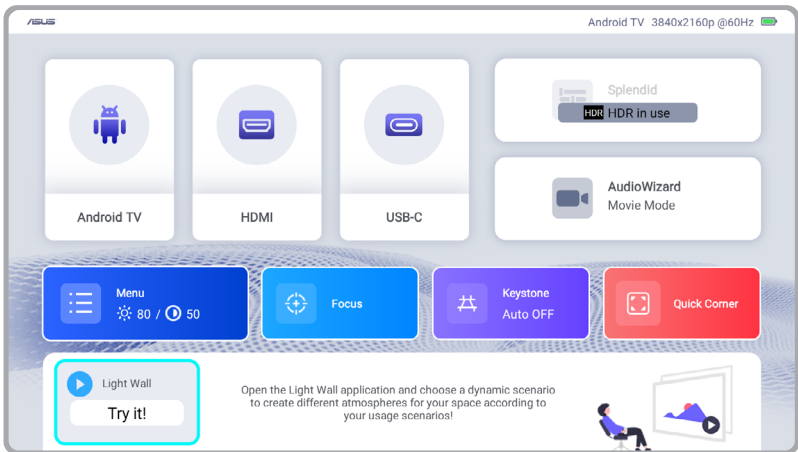

Light Wall main menu

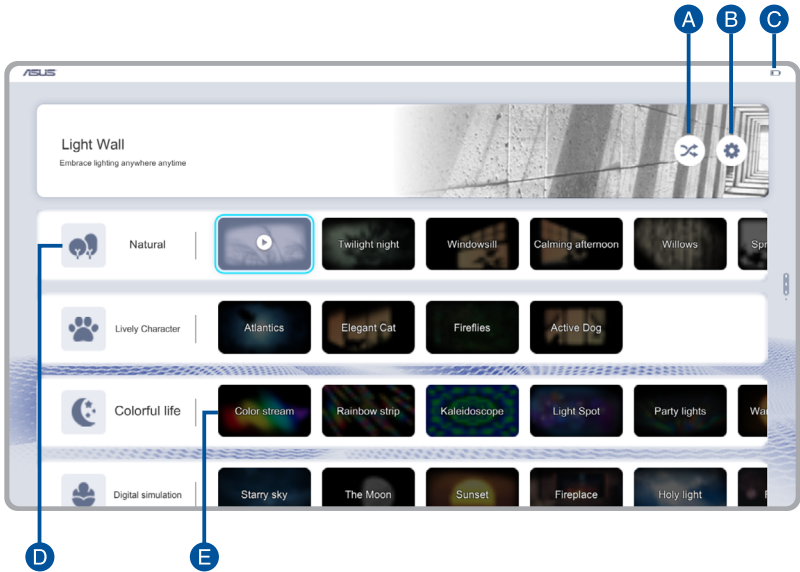

- A. **Shuffle:** Select to start the random playback of animations in the scenario or environment theme selected in Light Wall setting .
- B. **Light Wall settings:** Select to access a menu to configure settings for Light Wall.

Battery status - This option allows you to turn on or off the battery indicator onscreen.

idle Mode - This option allows you to turn on or off auto playback when your LED projector is idle.

Idle Style - This option allows you to select a theme or environment for the random playback of scenario animations when your LED projector is idle and also for when you enter random playback mode.

shuffle - This options allows you to select the theme to use for random playback.

- C. **Battery status:** Shows the current battery charge level. You can hide this status indicator in Light Wall setting .
- D. **Scenario theme:** Choose from one of the four available themes for playback.
- E. **Animation:** Select one of the ready-made animations to play to set the mood for the room.

NOTE: To exit playback, press the **Back** button on your LED projector or the remote control.

Updating your LED projector



1. Go to the ASUS support site and download the latest software update for your LED projector.
2. After downloading, extract the file and save L2update.bin to the root directory of a USB Type-A flash drive.

NOTE: Make sure that the flash drive is formatted as FAT32.

3. Insert the USB flash drive to the USB 2.0 Type-A port on your LED projector. Refer to the *Rear view* section for the location of this port.
4. Press  on the remote control to bring up the OSD menu.
5. Navigate to **Menu** using the remote control, and press **OK**.
6. Select **Setup**, then **System Update** to start the update.

IMPORTANT! Ensure the projector remains connected to a power supply and is not turned off during the update.

Adjusting the volume on the Android TV box



1. Press and hold simultaneously  and  on the remote control for at least 5 seconds to activate Android TV mode.

NOTE: Android TV mode is activated when the LED indicator on the remote control turns from solid red to blinking red and then turns off.

2. Use the **Volume up** and **Volume down** buttons on your remote control to adjust the volume to your desired level.

NOTE:

- When you adjust the volume in Android TV mode, the volume bar is displayed in green. For LED projector mode, it is displayed in purple. This allows you to easily differentiate whether you are adjusting the volume for the Android TV box or the LED projector.
- To enhance the LED projector's audio output, we suggest that you set the volume of the Android TV box to its maximum level.

3. Press and hold simultaneously  and  on the remote control for at least 5 seconds to return to LED projector mode.

NOTE: LED projector mode is activated when the LED indicator on the remote control turns from solid blue to blinking red and then turns off.

Putting your LED projector in Standby mode

To put your LED projector into Standby mode, press the Power button on it or the remote control, then select the **Standby** option.

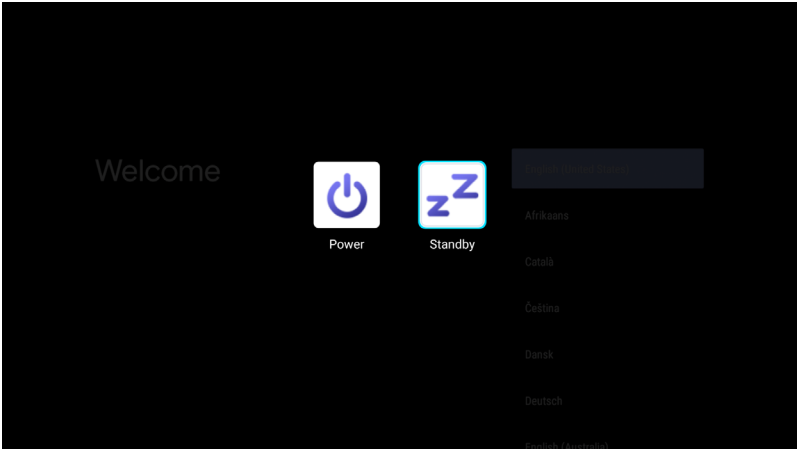

Powering off your LED projector

Powering off by a short press on the power button

You can power off the LED projector by pressing the power button on your LED projector or remote control, then selecting the **Power** option using the joystick navigation button on your LED projector.

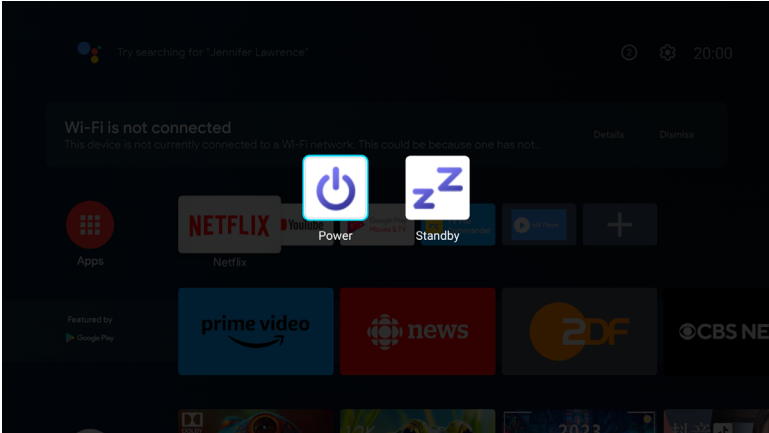

Powering off by long pressing the power button

Long press on the power button on your LED projector or remote control to prompt a pop-up. To power off your LED projector, press the power button again, or click **OK**.

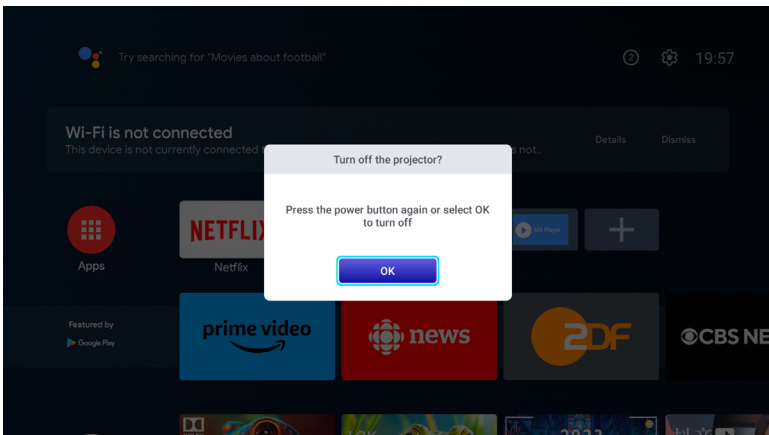

Appendices

Federal Communications Commission Statement

This device complies with part 15 of the FCC Rules. Operation is subject to the following two conditions: (1) This device may not cause harmful interference, and (2) this device must accept any interference received, including interference that may cause undesired operation.

NOTE: This equipment has been tested and found to comply with the limits for a Class B digital device, pursuant to part 15 of the FCC Rules. These limits are designed to provide reasonable protection against harmful interference in a residential installation. This equipment generates, uses and can radiate radio frequency energy and, if not installed and used in accordance with the instructions, may cause harmful interference to radio communications.

The device should be installed and operated with a minimum distance of 20 cm between the radiator and your body.

RF Exposure Statement of Statement for Canada

The radiated output power of the Wireless Device is below the Industry Canada (IC) radio frequency exposure limits. The Wireless Device should be used in such a manner such that the potential for human contact during normal operation is minimized.

The device should be installed and operated with a minimum distance of 20 cm between the radiator and your body.

La puissance de sortie émise par l'appareil de sans fil Dell est inférieure à la limite d'exposition aux fréquences radio d'Industry Canada (IC). Utilisez l'appareil de sans fil Dell de façon à minimiser les contacts humains lors du fonctionnement normal.

L'appareil doit être installé et actionné avec une distance de 20 cm entre le radiateur et votre corps.

Compliance Statement of Innovation, Science and Economic Development Canada (ISED)

This device complies with Innovation, Science and Economic Development Canada licence exempt RSS standard(s). Operation is subject to the following two conditions: (1) this device may not cause interference, and (2) this device must accept any interference, including interference that may cause undesired operation of the device.

This Class B digital apparatus complies with Canadian ICES-003. Canada: 5.150-5.250 GHz, indoor use only.

Déclaration de conformité de Innovation, Sciences et Développement économique Canada (ISED)

Le présent appareil est conforme aux CNR d'Innovation, Sciences et Développement économique Canada applicables aux appareils radio exempts de licence. L'exploitation est autorisée aux deux conditions suivantes : (1) l'appareil ne doit pas produire de brouillage, et (2) l'utilisateur de l'appareil doit accepter tout brouillage radioélectrique subi, même si le brouillage est susceptible d'en compromettre le fonctionnement.

Cet appareil numérique de la classe B est conforme à la norme ICES-003 du Canada. Canada: 5,150 GHz - 5,250 GHz, utilisation en intérieur uniquement.

HDMI Trademark Notice

The terms HDMI, HDMI High-Definition Multimedia Interface, and the HDMI Logo are trademarks or registered trademarks of HDMI Licensing Administrator, Inc.

QR Code Trademark Notice

QR Code is a registered trademark of DENSO WAVE INCORPORATED.

Global Environmental Regulation Compliance and Declaration

ASUS follows the green design concept to design and manufacture our products, and makes sure that each stage of the product life cycle of ASUS product is in line with global environmental regulations. In addition, ASUS disclose the relevant information based on regulation requirements.

Please refer to <https://csr.asus.com/english/Compliance.htm> for information disclosure based on regulation requirements ASUS is complied with:

Japan JIS-C-0950 Material Declarations

EU REACH SVHC

Korea RoHS

ASUS Recycling/Takeback Services

ASUS recycling and takeback programs come from our commitment to the highest standards for protecting our environment. We believe in providing solutions for you to be able to responsibly recycle our products, batteries, other components as well as the packaging materials. Please go to <https://csr.asus.com/english/Takeback.htm> for detailed recycling information in different regions.

Simplified EU Declaration of Conformity

ASUSTek Computer Inc. hereby declares that this device is in compliance with the essential requirements and other relevant provisions of Directive 2014/53/EU. Full text of EU declaration of conformity is available at <https://www.asus.com/support>.

The Wi-Fi operating in the band 5150-5350 MHz shall be restricted to indoor use for countries listed in the table below:

AT	BE	BG	CZ	DK	EE	FR
DE	IS	IE	IT	EL	ES	CY
LV	LI	LT	LU	HU	MT	NL
NO	PL	PT	RO	SI	SK	TR
FI	SE	CH	HR	UK(NI)		

Simplified UKCA Declaration of Conformity

ASUSTek Computer Inc. hereby declares that this device is in compliance with the essential requirements and other relevant provisions of The Radio Equipment Regulations 2017 (S.I. 2017/1206). Full text of UKCA declaration of conformity is available at <https://www.asus.com/support/>.

The Wi-Fi operating in the band 5150-5350MHz shall be restricted to indoor use for the country listed below:

UK

CE RED RF Output Table (Directive 2014/53/EU)

Function	Frequency	Maximum Output Power (EIRP)
Wi-Fi	2412 - 2472 MHz	< 20 dBm
	5150 - 5250 MHz	< 20 dBm
	5250 - 5350 MHz	< 20 dBm
	5470 - 5725 MHz	< 20 dBm
Bluetooth LE	2402 - 2480 MHz	< 10 dBm
Bluetooth BR+EDR	2402 - 2480 MHz	< 10 dBm

UKCA RF Output Table (The Radio Equipment Regulations 2017)

Function	Frequency	Maximum Output Power (EIRP)
Wi-Fi	2412 - 2472 MHz	< 20 dBm
	5150 - 5250 MHz	< 20 dBm
	5250 - 5350 MHz	< 20 dBm
	5470 - 5725 MHz	< 20 dBm
Bluetooth LE	2402 - 2480 MHz	< 10 dBm
Bluetooth BR+EDR	2402 - 2480 MHz	< 10 dBm



电子电气产品有害物质限制使用标识：图中之数字为产品之环保使用期限。仅指电子电气产品中含有的有害物质不致发生外泄或突变，从而对环境造成污染或对人身、财产造成严重损害的期限。

部件名称	有害物质的名称及含量					
	铅 Lead (Pb)	汞 Mercury (Hg)	镉 Cadmium (Cd)	六价铬 Hexavalent chromium (Cr+6)	多溴联苯 Polybrominated biphenyls (PBB)	多溴二苯醚 Polybrominated diphenyl ethers (PBDE)
塑胶外框	○	○	○	○	○	○
五金件	×	○	○	○	○	○
光机	○	○	○	○	○	○
风扇	○	○	○	○	○	○
线路板组件	×	○	○	○	○	○
电线	○	○	○	○	○	○
扬声器	○	○	○	○	○	○
散热模组	○	○	○	○	○	○
适配器	×	○	○	○	○	○
遥控器	×	○	○	○	○	○
包装材料	○	○	○	○	○	○

备注 1. 线路板组件包括印刷线路板及其构成的零部件，如电阻、电容、集成电路、连接器等。
本表格依据 SJ/T 11364 的规定编制。

备注 2. ○：指该项有害物质在该部件所有均质材料中的含量均在 GB/T 26572 规定的限量要求下。

备注 3. ×：指该有害物质至少在该部件的某一均质材料汇总的含量超过 GB/T 26572 规定的限量要求，但符合欧盟 RoHS 法规要求（属于豁免部分）

「產品之限用物質含有情況」之相關資訊，請參考下表。

單元 Unit	限用物質及其化學符號 Restricted substances and its chemical symbols					
	鉛 Lead (Pb)	汞 Mercury (Hg)	鎘 Cadmium (Cd)	六價鉻 Hexavalent chromium (Cr+6)	多溴聯苯 Polybrominated biphenyls (PBB)	多溴二苯醚 Polybrominated diphenyl ethers (PBDE)
塑膠外框 Plastic Frame	○	○	○	○	○	○
金屬機構 Hardware	—	○	○	○	○	○
光機 Optical engine	○	○	○	○	○	○
風扇 Fan	○	○	○	○	○	○
印刷電路板 PCB	—	○	○	○	○	○
電纜 Wire	○	○	○	○	○	○
揚聲器 Speaker	○	○	○	○	○	○
散熱模組 Heat dissipation module	○	○	○	○	○	○
電源供應器 Adapter	—	○	○	○	○	○
遙控器 Remote control	—	○	○	○	○	○
包裝材料 Packing material	○	○	○	○	○	○

備考 1: “超出 0.1 wt %” 及 “超出 0.01 wt %” 係指限用物質之百分比含量超出百分比含量基準值。
 Note 1: “Exceeding 0.1 wt %” and “exceeding 0.01 wt %” indicate that the percentage content of the restricted substance exceeds the reference percentage value of presence condition.

備考 2: “○” 係指該項限用物質之百分比含量未超出百分比含量基準值。
 Note 2: “○” indicates that the percentage content of the restricted substance does not exceed the percentage of reference value of presence.

備考 3: “—” 係指該項限用物質為排除項目。
 Note 3: The “—” indicates that the restricted substance corresponds to the exemption.

Specifications for ZenBeam L2 LED projector

		ZenBeam L2
Display	Display Technology	0.23" DLP®
	Light Source	R/G/B LED
	Light Source Life	30,000 hours
	True Resolution (native)	Full HD 1080p (1920 x 1080)
	Light Output (Max)	960 LED lm / 400 ANSI lm
	Contrast Ratio	400:1 (typical)
	Display Colors	16.7 million colors
Projection Lens	Throw Ratio	1.2:1 (38" @ 1m)(@16:9)
	Projection Distance / Size	0.8 m~3.2 m
	Projection Offset	100% ± 5%
	Zoom Ratio	N/A
	Focus	Auto Focus
Video Features	Picture Modes	7 modes (Bright / Standard / Theater / Eco / Scenery / Game / User)
	Keystone adjustment	<ul style="list-style-type: none"> • ± 40 degree vertical and • ± 30 degree horizontal keystone correction
	Auto Keystone	Yes (vertical and horizontal)
	Aspect Ratio	Auto / 16:9 / 4:3
	Projector Placement	Front Table, Rear Table, Rear Ceiling, Front Ceiling
	Wireless Projection	Yes, supported by Android TV box
	Bluetooth	N/A
Audio Features	Built-in speaker	1 x 10 W speaker with smart AMP/sound by harman/kardon

(continued on the next page)

		ZenBeam L2
Power	Power On Mode	<90 W
	Standby Mode	<0.5 W
	Battery	<ul style="list-style-type: none"> • 17,700 mAh (typ. 65 Whr, 6-cell Lithium-ion battery) • Up to 3.5 hrs (Battery Mode Low)
Noise	Acoustic Noise	30 dB (Standard) / 28 dB (Eco)
Interface	Signal Input	<ul style="list-style-type: none"> • 1 x HDMI • 1 x micro HDMI (internal) for Android TV box • 1 x USB Type-C DP Alt Mode
	Audio Output	Earphone out (3.5 mm Mini-jack)
	USB Port	1 x USB 2.0 Type-A
	Wi-Fi	No
	Bluetooth	No
	Mechanical Design	Tripod Socket
Stand		Yes, 2-step
Ceiling Mount		No
Dimension	Physical Dimension (WxDxH)	132 x 172 x 132 mm
	Box Dimension (WxDxH)	210 x 265 x 177 mm
Weight	Net Weight (Est.)	1.57 kg
	Gross Weight (Est.)	2.8 kg
Operating Temperature		0 ~ 40° C
Operating Humidity		20 ~ 90%

(continued on the next page)

	ZenBeam L2
Accessories	Android TV Box, Pouch, Power Adapter, Power Cord, Remote Control, QSG, Warranty Card, 2 x AAA Batteries
Regulation Approvals	cTUVus / FCC / CE ICE-003 / CB / IEC62471 / BSMI / RCM / VCCI / CEC / BC / C-Tick

NOTE:

- Specifications are subject to change without prior notice.
 - Product availability may vary by region.
 - All brand and product names mentioned are trademarks of their respective companies.
-

Supported PC Timings

HDMI (PC)

Resolution	Mode	Refresh rate (Hz)	H-frequency (kHz)	Clock (MHz)
720 x 400	720x400_70	70.087	31.469	28.322
640 x 480	VGA_60	59.940	31.469	25.175
	VGA_72	72.809	37.861	31.500
	VGA_75	75.000	37.500	31.500
	VGA_85	85.008	43.269	36.000
800 x 600	SVGA_56	56.250	35.156	36.000
	SVGA_60	60.317	37.879	40.000
	SVGA_72	72.188	48.077	50.000
	SVGA_75	75.000	46.875	49.500
	SVGA_85	85.061	53.674	56.250
1024 x 768	XGA_60	60.004	48.363	65.000
	XGA_70	75.069	56.476	75.000
	XGA_75	75.029	60.023	78.750
	XGA_85	84.997	68.667	94.500
1152 x 864	1152 x 864_75	75.000	67.500	108.000
1024 x 576	BenQ NB Timing	60.000	35.820	46.966
1024 x 600	BenQ NB Timing	64.995	41.467	51.419
1280 x 720	1280 x 720_60	60.000	45.000	74.250
1280 x 768	1280 x 758_60 (reduced blinking)	60.000	47.396	68.250
	1280 x 768_60	59.870	47.776	79.500
1280 x 800	WXGA_60	59.810	49.702	83.500
	WXGA_75	74.934	62.795	106.500
	WXGA_85	84.880	71.554	122.500
1280 x 1024	SXGA_60	60.020	63.981	108.000
	SXGA_75	75.025	79.976	135.000
	SXGA_85	85.024	91.146	157.500
1280 x 960	1280 x 960_60	60.000	60.000	108.000
	1280 x 960_85	85.002	85.938	148.500
1360 x 768	1360 x 768_60	60.015	47.712	85.500
1440 x 900	WXGA+_60 (reduced blinking)	60.000	55.469	88.750
	WXGA+_60	59.887	55.935	106.500
1400 x 1050	SXGA+_60	59.978	65.317	121.750
1600 x 1200	UXGA	60.000	75.000	162.000
1680 x 1050	1680 x 1050_60 (reduced blinking)	59.883	64.674	119.000
	1680 x 1050_60	59.954	65.290	146.250
640 x 480 @ 67 Hz	MAC13	66.667	35.000	30.240
832 x 624 @ 75 Hz	MAC16	74.546	49.722	57.280
1024 x 768 @ 75 Hz	MAC19	74.930	60.241	80.000
1152 x 870 @ 75 Hz	MAC21	75.060	68.680	100.000
1920 x 1080 @ 60 Hz	1920 x 1080_60	60.000	67.500	148.500
1920 x 1200 @ 60 Hz	1920 x 1080_60 (reduced blinking)	59.950	74.038	154.000
1920 x 1080 (VESA)	1920 x 1080_60 (for auditorium model)	59.963	67.158	173.000

HDMI (Video)

Timing	Resolution	Horizontal frequency (kHz)	Vertical frequency (Hz)	Dot Clock frequency (MHz)
480i	720 x 480	15.73	59.94	13.50
480p	720 x 480	31.47	59.94	27.00
576i	720 x 576	15.63	50	13.50
576p	720 x 576	31.25	50	27.00
720/50p	1280 x 720	37.50	50	74.25
720/60p	1280 x 720	45.00	60	74.25
1080/50i	1920 x 1080	28.13	50	74.25
1080/60i	1920 x 1080	33.75	60	74.25
1080/24p	1920 x 1080	27.00	24	74.25
1080/25p	1920 x 1080	28.13	25	74.25
1080/30p	1920 x 1080	33.75	30	74.25
1080/50P	1920 x 1080	56.25	50	148.50
1080/60P	1920 x 1080	67.50	60	148.50

DisplayPort

Resolution	Mode	Refresh rate (Hz)	H-frequency (kHz)	Clock (MHz)
640 x 480	VGA_60	59.940	31.469	25.175
800 x 600	SVGA_60	60.317	37.879	40.000
	SVGA_75	75.000	46.875	49.500
1024 x 768	XGA_60	60.004	48.363	65.000
1280 x 800	WXGA_60	59.810	49.702	83.500
1600 X 1200	UXGA	60.000	75.000	162.000
1680 X 1050	1680 X 1050_60	59.954	65.290	146.250
1920 x 1080	1920 x 1080_60	60.000	67.500	148.500

For more information on this product, please refer to the label located on the bottom of the device.