

Intel® Server System R1000SP Family Service Guide

A Guide for Technically Qualified Assemblers of Intel® identified Subassemblies/Products

Order Number: G76656-001

Disclaimer

Disclaimer

Information in this document is provided in connection with Intel® products. No license, express or implied, by estoppel or otherwise, to any intellectual property rights is granted by this document. Except as provided in Intel®'s Terms and Conditions of Sale for such products, Intel® assumes no liability whatsoever, and Intel® disclaims any express or implied warranty, relating to sale and/or use of Intel® products including liability or warranties relating to fitness for a particular purpose, merchantability, or infringement of any patent, copyright or other intellectual property right. Intel® products are not designed, intended or authorized for use in any medical, life saving, or life sustaining applications or for any other application in which the failure of the Intel® product could create a situation where personal injury or death may occur. Intel® may make changes to specifications and product descriptions at any time, without notice.

Intel® server boards contain a number of high-density VLSI and power delivery components that need adequate airflow for cooling. Intel®'s own chassis are designed and tested to meet the intended thermal requirements of these components when the fully integrated system is used together. It is the responsibility of the system integrator that chooses not to use Intel® developed server building blocks to consult vendor datasheets and operating parameters to determine the amount of airflow required for their specific application and environmental conditions. Intel Corporation cannot be held responsible if components fail or the server board does not operate correctly when used outside any of their published operating or non-operating limits.

Intel, Intel Pentium, and Intel Xeon are trademarks or registered trademarks of Intel Corporation or its subsidiaries in the United States and other countries.

* Other names and brands may be claimed as the property of others.

Copyright © 2012 Intel Corporation. All Rights Reserved.

Safety Information

Important Safety Instructions

Read all caution and safety statements in this document before performing any of the instructions. See also Intel® Server Boards and Server Chassis Safety Information on the Intel® Server Deployment Toolkit 3.0 CD and/or at <http://www.intel.com/support/motherboards/server/sb/cs-010770.htm>.

Wichtige Sicherheitshinweise

Lesen Sie zunächst sämtliche Warnung und Sicherheitshinweise in diesem Dokument, bevor Sie eine der Anweisungen ausführen. Beachten Sie hierzu auch die Sicherheitshinweise zu Intel® Serverplatinen und Servergehäusen auf der Intel® Server Deployment Toolkit 3.0 CD oder unter <http://www.intel.com/support/motherboards/server/sb/cs-010770.htm>.

Consignes de sécurité

Lisez attention toutes les consignes de sécurité et les mises en garde indiquées dans ce document avant de suivre toute instruction. Consultez Intel Server Boards and Server Chassis Safety Information sur le Intel® Server Deployment Toolkit 3.0 CD ou bien rendez-vous sur le site <http://www.intel.com/support/motherboards/server/sb/cs-010770.htm>.

Instrucciones de seguridad importantes

Lea todas las declaraciones de seguridad y precaución de este documento antes de realizar cualquiera de las instrucciones. Vea Intel® Server Boards and Server Chassis Safety Information en el Intel® Server Deployment Toolkit 3.0 CD y/o en <http://www.intel.com/support/motherboards/server/sb/cs-010770.htm>.

重要安全指导

在执行任何指令之前，请阅读本文档中的所有注意事项及安全声明。和/或 <http://www.intel.com/support/motherboards/server/sb/cs-010770.htm> 上的 *Intel® Server Boards and Server Chassis Safety Information*（《Intel® 服务器主板与服务器机箱安全信息》）。

Warnings

Heed safety instructions: Before working with your server product, whether you are using this guide or any other resource as a reference, pay close attention to the safety instructions. You must adhere to the assembly instructions in this guide to ensure and maintain compliance with existing product certifications and approvals. Use only the described, regulated components specified in this guide. Use of other products/components will void the UL listing and other regulatory approvals of the product and will most likely result in noncompliance with product regulations in the region(s) in which the product is sold.

System power on/off: The power button DOES NOT turn off the system AC power. To remove power from the system, you must unplug the AC power cord from the wall outlet. Make sure the AC power cord is unplugged before you open the chassis, add, or remove any components.

Hazardous conditions, devices and cables: Hazardous electrical conditions may be present on power, telephone, and communication cables. Turn off the server and disconnect the power cord, telecommunications systems, networks, and modems attached to the server before opening it. Otherwise, personal injury or equipment damage can result.

Electrostatic discharge (ESD) and ESD protection: ESD can damage disk drives, boards, and other parts. We recommend that you perform all procedures in this chapter only at an ESD workstation. If one is not available, provide some ESD protection by wearing an antistatic wrist strap attached to chassis ground—any unpainted metal surface—on your server when handling parts.

ESD and handling boards: Always handle boards carefully. They can be extremely sensitive to ESD. Hold boards only by their edges. After removing a board from its protective wrapper or from the server, place the board component side up on a grounded, static free surface. Use a conductive foam pad if available but not the board wrapper. Do not slide board over any surface.

Installing or removing jumpers: A jumper is a small plastic encased conductor that slips over two jumper pins. Some jumpers have a small tab on top that you can grip with your fingertips or with a pair of fine needle nosed pliers. If your jumpers do not have such a tab, take care when using needle nosed pliers to remove or install a jumper; grip the narrow sides of the jumper with the pliers, never the wide sides. Gripping the wide sides can damage the contacts inside the jumper, causing intermittent problems with the function controlled by that jumper. Take care to grip with, but not squeeze, the pliers or other tool you use to remove a jumper, or you may bend or break the pins on the board.

Preface

About this Manual

This manual is written for system technicians who are responsible for troubleshooting, upgrading, and repairing this server system. This document provides a brief overview of the features of the server board/chassis, a list of accessories or other components you may need, troubleshooting information, and instructions on how to add and replace components on the Intel® Server System R1000SP family products. For the latest revision of this manual, go to http://www.intel.com/p/en_US/support/.

Manual Organization

Chapter 1 provides a brief overview of the Intel® Server System R1000SP family. In this chapter, you will find a list of the server system features, and figures of the system and components to help you identify your system components and their locations.

Chapter 2 provides instructions on adding and replacing components. Use this chapter for step-by-step instructions and diagrams for installing or replacing components such as the fan, power supply, and front panel board, among other components.

Chapter 3 provides instructions on using the utilities that are shipped with the board or that may be required to update the system. This includes information for navigating through the BIOS Setup screens, performing a BIOS update, and resetting the password or BIOS defaults.

The back of this manual provides technical specifications, regulatory information, LED Decoder, "getting help" information, and Intel® Server Issue Report Form.

Additional Information and Software

For additional information about this family of products or any of their supported accessories, refer to the following resources available at http://www.intel.com/p/en_US/support/.

Table 1. Server System References

For this information or software	Use this Document or Software
For in-depth technical information about this product	<i>Intel® Server System R1000SP Product Family Technical Product Specification</i> <i>Intel® Server Board S1400SP Technical Product Specification</i>
For a quick guide of how to assemble the server system and install components	<i>Intel® Server System R1000SP Product Family Quick Integration Guide</i>
For product list and supported Intel® spares and accessories	<i>Spares and Accessories List and Configuration Guide</i>
For server configuration guidance and compatibility	Intel® Server Configurator tool http://serverconfigurator.intel.com/sct_app.aspx
For system power budget guidance	Power Budget Tool
For system firmware updates and onboard device drivers and software to manage your Intel® Server System.	Intel® Server Deployment & Management DVD
Product Safety and Regulatory document	<i>Intel Server Products - Product Safety and Regulatory Compliance Document</i>

Table of Contents

Safety Information	iii
Preface	v
1 Server System Features	1
Server System Feature Overview	2
Server System Components.....	3
Hot Swap Hard Drive Bay and Front Panel Options.....	4
Front Panel	4
Back Panel.....	5
Server Board Components.....	6
Intel® Light-Guided Diagnostics	7
System Recovery Jumpers.....	8
Peripheral Devices.....	9
Hard Disk Drive Carriers.....	9
Slimline Optical Drive Support.....	9
Bezel	10
Hot-Swap SAS/SATA Backplane	10
4 x 3.5-inch Hard Drive Backplane	10
8 x 2.5-inch Hard Drive Backplane	11
Advanced Management Options	11
2 Hardware Installations and Upgrades	12
Before You Begin.....	12
Tools and Supplies Needed	12
System Reference	12
Cable Routing.....	12
For system with 4 x 3.5" fixed hard drive bay:.....	13
For system with 4 x 3.5" hot swap hard drive bay:	14
For system with 8 x 2.5" hard drive bay:.....	15
Fan Connections.....	16
Removing and Installing the Front Bezel.....	17
Removing the Front Bezel.....	17
Installing the Front Bezel.....	18
Removing and Installing the System Cover	18
Removing the System Cover	18
Installing the System Cover.....	19
Removing and Installing the Air Duct.....	20
Removing the Air Duct.....	20
Installing the Air Duct	20
Removing and Installing Processor	21
Removing Processor Heatsink	21
Installing the Processor.....	21
Installing Processor Heatsink	23
Removing the Processor	24
Installing and Removing Memory	24
Installing Memory	24
Removing Memory.....	25

Installing and Removing Hot-swap Hard Drive	25
Installing a Hard Disk Drive into 3.5" Hard Drive Carrier.....	25
Installing a Hard Disk Drive into 2.5" Hard Drive Carrier.....	27
Removing and Installing the PCI Riser Assembly	28
Removing the PCI Riser Assembly	28
Installing the PCI Riser Assembly.....	29
Installing and Removing a PCI Add-in Card.....	29
Installing a PCI Add-in Card	29
Removing a PCI Add-in Card.....	30
Replacing a PCI Riser Card.....	30
Removing a PCI Riser Card	31
Installing a PCI Riser Card.....	31
Installing and Removing a Slimline Optical Drive	31
Installing a Slimline Optical Drive	31
Removing a Slimline Optical Drive	32
Installing and Removing Intel® I/O Expansion Module.....	33
Installing Intel® I/O Expansion Module	33
Removing Intel® I/O Expansion Module.....	33
Installing and Removing the Intel® RAID C600 Upgrade Key.....	34
Installing the Intel® RAID C600 Upgrade Key	34
Removing the Intel® RAID C600 Upgrade Key.....	34
Installing and Removing the Intel® Remote Management Module 4.....	34
Installing the Intel® RMM4 Lite.....	34
Install the Intel® RMM4 NIC	35
Removing the Intel® RMM4 Lite	35
Removing the Intel® RMM4 NIC.....	35
Installing and Removing the Intel® RAID Smart Battery	36
Installing the Intel® RAID Smart Battery	36
Removing the Intel® RAID Smart Battery	37
Replacing the Fixed Power Supply	37
Replacing the Redundant Power Supply	38
Installing and Removing the Server Board	39
Removing the Server Board.....	39
Installing the Server Board	40
Replacing the Backup Battery	41
Replacing a System Fan	42
Replacing the Backplane	43
Removing the Backplane.....	43
Installing the Backplane	43
Installing and Removing the Rack Handles	44
Installing the Rack Handles.....	44
Removing the Rack Handles	44
3 Server Utilities	45
Using the BIOS Setup Utility	45
Entering BIOS Setup	45
If You Cannot Access Setup.....	45
Setup Menus	45
Upgrading the BIOS	46
Clearing the Password	47
Restoring the BIOS Defaults	47

Table of Contents

Appendix A: Technical Reference..... 48
 Power Supply Input Voltages 48
 Power Supply Output Voltages 48
 System Environmental Specifications 48

Appendix B: Regulatory and Compliance Information 50

Appendix C: Getting Help..... 51
 Warranty Information 51

Appendix D: Intel® Server Issue Report Form 52

List of Figures

Figure 1. Intel® Server System R1000SP.....	1
Figure 2. Intel® Server System R1000SP Components	3
Figure 3. 3.5" Fixed Hard Drive Bay - 4 Drive Configuration	4
Figure 4. 3.5" Hot Swap Hard Drive Bay - 4 Drive Configuration	4
Figure 5. 2.5" Hard Drive Bay - 8 Drive Configuration	4
Figure 6. Front Panel Options.....	4
Figure 7. Back Panel Feature Identification.....	5
Figure 8. Server Board Connector and Component Locations	6
Figure 9. Intel® Light-Guided Diagnostic LEDs - Server Board	7
Figure 10. Configuration Jumpers	8
Figure 11. Optional Peripherals (8x2.5-inch hard drive bays as shown).....	9
Figure 12. Front view of Front Bezel.....	10
Figure 13. 4 x 3.5-inch Hard Drive Backplane Components (Front View).....	10
Figure 14. 4 x 3.5-inch Hard Drive Backplane Components (Rear View)	10
Figure 15. 8 x 2.5-inch Hard Drive Backplane Components (Front View).....	11
Figure 16. 8 x 2.5-inch Hard Drive Backplane Components (Rear View)	11
Figure 17. Cable Routing – 4 x 3.5" Fixed HDD.....	13
Figure 18. Cable Routing – 4 x 3.5" Hot Swap HDD	14
Figure 19. Cable Routing – 8 x 2.5" HDD.....	15
Figure 20. Fixed System Fan Order.....	16
Figure 21. Redundant System Fan Order.....	16
Figure 22. Connecting the Fan Power Cables to the Mother Board	17
Figure 23. Removing the Front Bezel.....	18
Figure 24. Installing the Front Bezel	18
Figure 25. Removing the System Cover	19
Figure 26. Installing the System Cover.....	19
Figure 27. Removing the Air Duct.....	20
Figure 28. Installing the Air Duct	20
Figure 29. Removing Processor Heatsink.....	21
Figure 30. Installing Processor – Open the Socket Lever	22
Figure 31. Installing Processor – Open the Load Plate.....	22
Figure 32. Installing Processor – Install the Processor	22
Figure 33. Installing Processor – Remove the Cover.....	23
Figure 34. Installing Processor – Close the Load Plate	23
Figure 35. Installing Processor – Latch the Locking Lever	23
Figure 36. Installing Processor Heatsink	24
Figure 37. Installing Memory	25
Figure 38. Installing Hard Disk Drive – Removing 3.5" HDD carrier	25
Figure 39. Installing Hard Disk Drive – Removing 3.5" HDD interface bracket.....	26
Figure 40. Installing Hard Disk Drive – Installing 3.5" HDD	26
Figure 41. Installing Hard Disk Drive – Installing 2.5" HDD	26
Figure 42. Installing Hard Disk Drive – Inserting 3.5" HDD assembly	27
Figure 43. Installing Hard Disk Drive – Removing 2.5" HDD carrier	27
Figure 44. Installing Hard Disk Drive – Removing plastic drive blank	27
Figure 45. Installing Hard Disk Drive – Installing 2.5" HDD	28
Figure 46. Installing Hard Disk Drive – Inserting 2.5" HDD assembly	28
Figure 47. Removing PCI Riser Assembly.....	28

List of Figures

Figure 48. Installing PCI Riser Assembly	29
Figure 49. Installing a PCI Add-In Card.....	30
Figure 50. Removing a PCI Add-In Card	30
Figure 51. Removing the PCI Riser Card	31
Figure 52. Installing the PCI Riser Card.....	31
Figure 53. Installing the Plastic Guide to the Optical Drive	32
Figure 54. Installing an Optical Drive	32
Figure 55. Removing the Slimline Optical Drive	32
Figure 56. Installing Intel® I/O Expansion Module	33
Figure 57. Removing an I/O Expansion Module	33
Figure 58. Installing the Intel® RAID C600 Upgrade Key	34
Figure 59. Installing the Intel® RMM4 Lite.....	35
Figure 60. Installing the Intel® RMM4 NIC	35
Figure 61. Removing the Intel® RMM4 NIC.....	36
Figure 62. Installing the Intel® RAID Smart Battery	36
Figure 63. Removing the Intel® RAID Smart Battery	37
Figure 64. Removing the fixed power supply module.....	37
Figure 65. Installing the fixed power supply module	38
Figure 66. Removing the redundant power supply module	38
Figure 67. Installing the redundant power supply module.....	39
Figure 68. Removing the Air Duct.....	39
Figure 69. Removing the Server Board	40
Figure 70. Installing the Server Board.....	40
Figure 71. Installing the Air Duct	41
Figure 72. Replacing the Backup Battery	42
Figure 73. Replacing a system fan.....	42
Figure 74. Removing the backplane	43
Figure 75. Installing the backplane.....	44
Figure 76. Installing the Rack Handle	44
Figure 77. Removing the Rack Handle.....	44

List of Tables

Table 1. Server System References.....	v
Table 2. Intel® Server System R1000SP Feature Summary.....	2
Table 3. BIOS Setup: Keyboard Command Bar	45
Table 4. Power Supply Output Capability	48
Table 5. System Environmental Limits Summary	48

1 Server System Features

This chapter briefly describes the main features of the Intel® Server System R1000SP family. This includes illustrations of the products, a list of the server system features, and diagrams showing the location of important components and connections on the server systems.



Figure 1. Intel® Server System R1000SP

AF005840

Server System Feature Overview

The following table summarizes the features of the server systems:

Table 2. Intel® Server System R1000SP Feature Summary

Server System	Integrated Server Board
Intel® Server System R1000SP product family	Intel® Server Board S1400SP

Feature	Description
Processor Support	Support for one Intel® Xeon® processor E5-2400 processor in an FC-LGA 1356 Socket B2 package with Thermal Design Power up to 95W
Memory	<ul style="list-style-type: none"> ▪ Three memory channels, six memory DIMMs (Two memory DIMMs per channel) ▪ Support for 1066/1333 MT/s Unbuffered (UDIMM) LVDDR3 or DDR3 memory ▪ Support for 1066/1333/1600 MT/s ECC Registered (RDIMM) DDR3 memory ▪ Support for 1066/1333 MT/s ECC Registered (RDIMM) LVDDR3 memory ▪ No support for mixing of RDIMMs and UDIMMs ▪ No support for LRDIMMs ▪ No support for Quad Rank DIMMs
Chipset	Intel® C602 (-A) chipset with support for storage option upgrade keys
External I/O connections	<ul style="list-style-type: none"> ▪ Video (back and front video connectors) ▪ RJ-45 Serial-A Port ▪ Two RJ-45 Network Interface Connectors supporting 10/100/1000Mb for system with S1400SP2, four RJ-45 Network Interface Connectors supporting 10/100/1000Mb for system with S1400SP4 ▪ USB 2.0 connectors - 4 on back panel + 2 on front panel
Internal I/O connectors/headers	<ul style="list-style-type: none"> ▪ One Type-A USB 2.0 connector ▪ One internal 2x5 pin serial port B header¹
I/O Module Accessory Options	<p>The following I/O modules utilize a single proprietary on-board connector. An installed I/O module can be supported in addition to standard on-board features and any add-in expansion cards.</p> <ul style="list-style-type: none"> ▪ Quad port 1 GbE based on Intel® Ethernet Controller I350 – AXX4P1GBPWL IOM ▪ Dual RJ-45 port 10GbE-T I/O Module based on Intel® Ethernet Controller x540 – AXX10GBTWLIOM ▪ Dual SFP+ port 10GbE module based on Intel® 82599 10 GbE controller – AXX10GBNIAIOM ▪ Single Port FDR 56GT/S speed Infiniband* module with QSFP connector – AXX1FDRIBIOM ▪ Dual port FDR 56GT/S speed Infiniband* module with QSFP connector – AXX2FDRIBIOM
System Fan Options	<p>Fixed system fan option:</p> <ul style="list-style-type: none"> ▪ Four 40mmx28mm single-rotor fans <p>Redundant system fan option:</p> <ul style="list-style-type: none"> ▪ Five 40mmx56mm dual-rotor fans
Riser Cards Options	<p>Support for one 1U PCI Express* riser card:</p> <ul style="list-style-type: none"> ▪ Single add-in card slot – PCI Express* Gen3 x8 electrical with x16 physical
Video	<ul style="list-style-type: none"> ▪ Integrated 2D Video Controller ▪ 16 MB DDR3 Memory
On-board storage controllers and options	<ul style="list-style-type: none"> ▪ Two AHCI SATA connectors at 6Gbps ▪ One AHCI 4-port mini-SAS connector, supporting four SATA ports at 3Gbps ▪ Two SCU 4-port mini-SAS connectors, supporting up to eight SAS/SATA ports total at 3Gbps with optional Intel® C600 RAID Upgrade Keys One eUSB 2x5 pin connector to support 2mm low-profile eUSB solid state devices

Feature	Description
Security	Intel® Trusted Platform Module (TPM) - AXXTPE5 (Accessory Option)
Server Management	<ul style="list-style-type: none"> ▪ Integrated Baseboard Management Controller, IPMI 2.0 compliant ▪ Support for Intel® Server Management Software ▪ Intel® Remote Management Module 4 Lite – Accessory option ▪ Intel® Remote Management Module 4 Management NIC – Accessory option
Power Supply Options	Fixed power supply option: <ul style="list-style-type: none"> ▪ AC 350W Silver Redundant power supply option: <ul style="list-style-type: none"> ▪ AC 450W Gold
Storage Bay Options	<ul style="list-style-type: none"> ▪ 4x 3.5" SATA fixed hard drive bays + Optical Drive support ▪ 4x 3.5" SATA/SAS hot swap hard drive bays + Optical Drive support ▪ 8x 2.5" SATA/SAS hot swap hard drive bays
Supported Rack Mount Kit Accessory Options	<ul style="list-style-type: none"> ▪ Value rack mount rail kit – Intel Product Code – AXXVRAIL ▪ Tool-less rack mount rail kit – Intel Product Code – AXXPRAIL ▪ Cable Management Arm – Intel Product Code – AXX1U2UCMA (*supported with AXXPRAIL only) ▪ 2-post fixed mount bracket kit – Intel Product Code – AXX2POSTBRCKT

Note: Internal 2x5 pin serial port B header does not function in systems configured with AC 450W Gold power supply.

Server System Components

This section helps you identify the components of your server system. If you are near the system, you can also use the *Quick Reference Label* provided on the inside of the chassis cover to assist in identifying components.

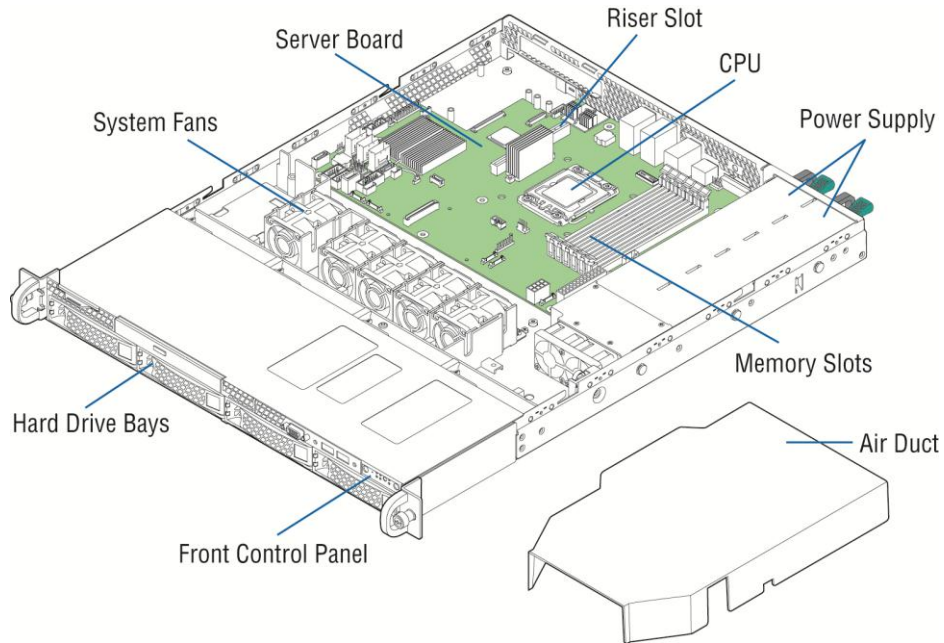

AF005707

Figure 2. Intel® Server System R1000SP Components

Hot Swap Hard Drive Bay and Front Panel Options

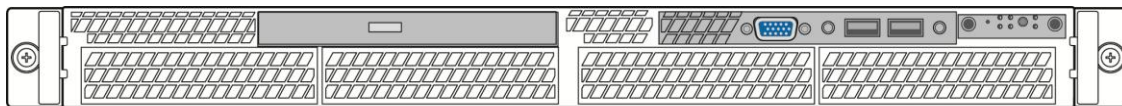

AF005724

Figure 3. 3.5" Fixed Hard Drive Bay - 4 Drive Configuration

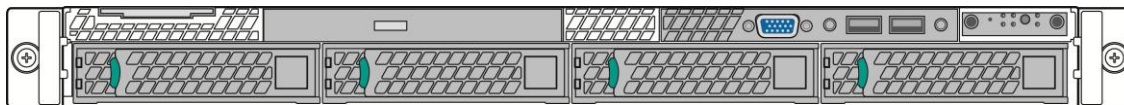

AF004121

Figure 4. 3.5" Hot Swap Hard Drive Bay - 4 Drive Configuration

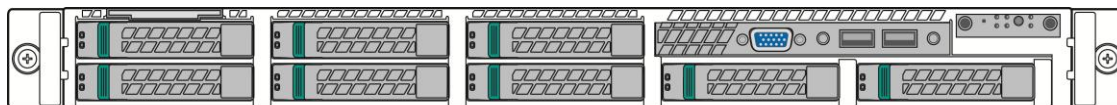

AF004120

Figure 5. 2.5" Hard Drive Bay - 8 Drive Configuration

Front Panel

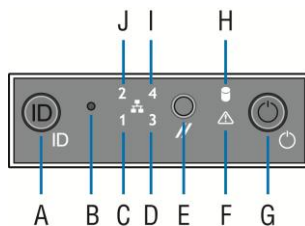

AF004003

Label	Description	Label	Description
A	System ID Button w/Integrated LED	F	System Status LED
B	NMI Button (recessed, tool required for use)	G	Power Button w/Integrated LED
C	NIC-1 Activity LED	H	Hard Drive Activity LED
D	NIC-3 Activity LED	I	NIC-4 Activity LED
E	System Cold Reset Button	J	NIC-2 Activity LED

Figure 6. Front Panel Options

Back Panel

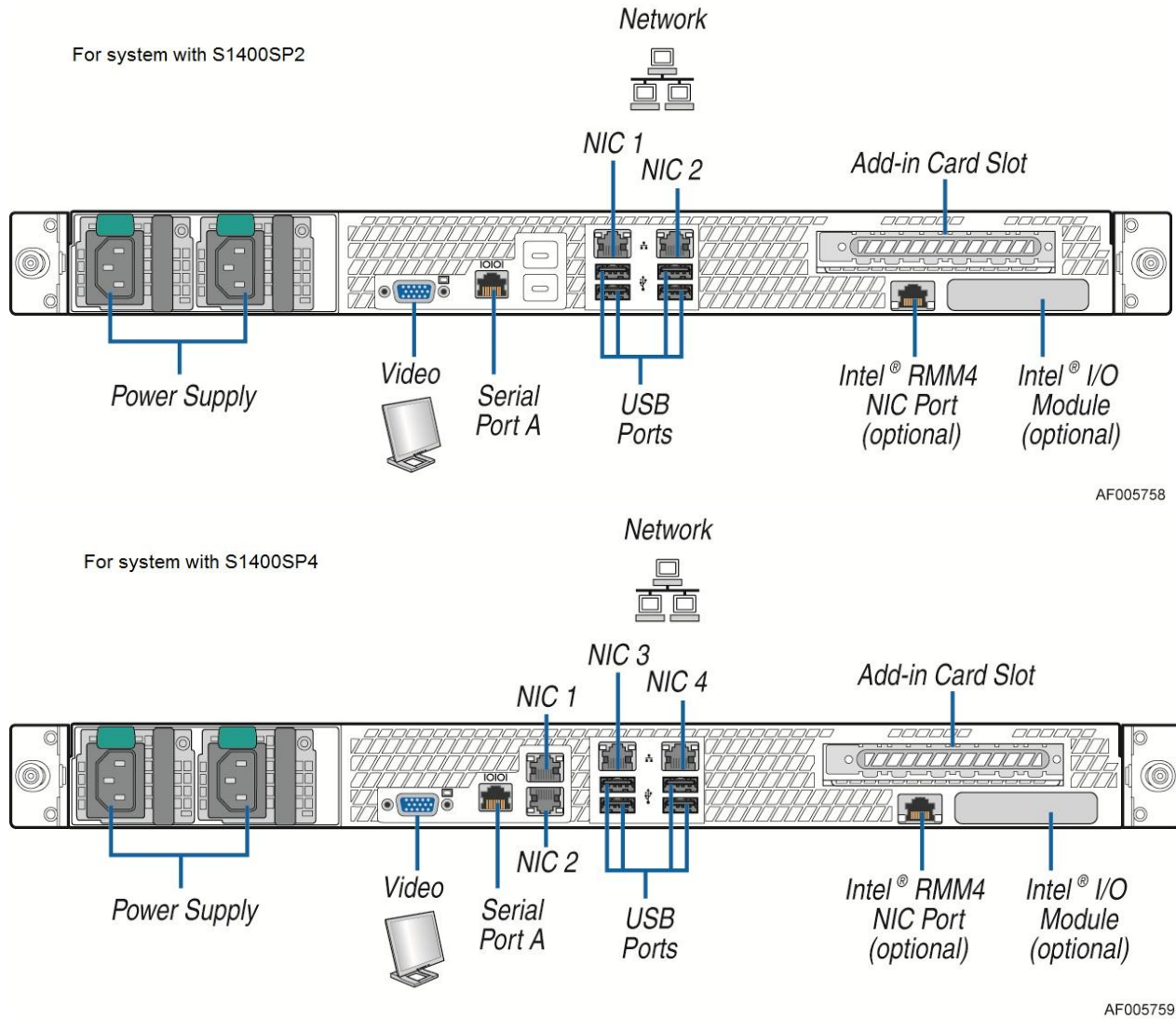
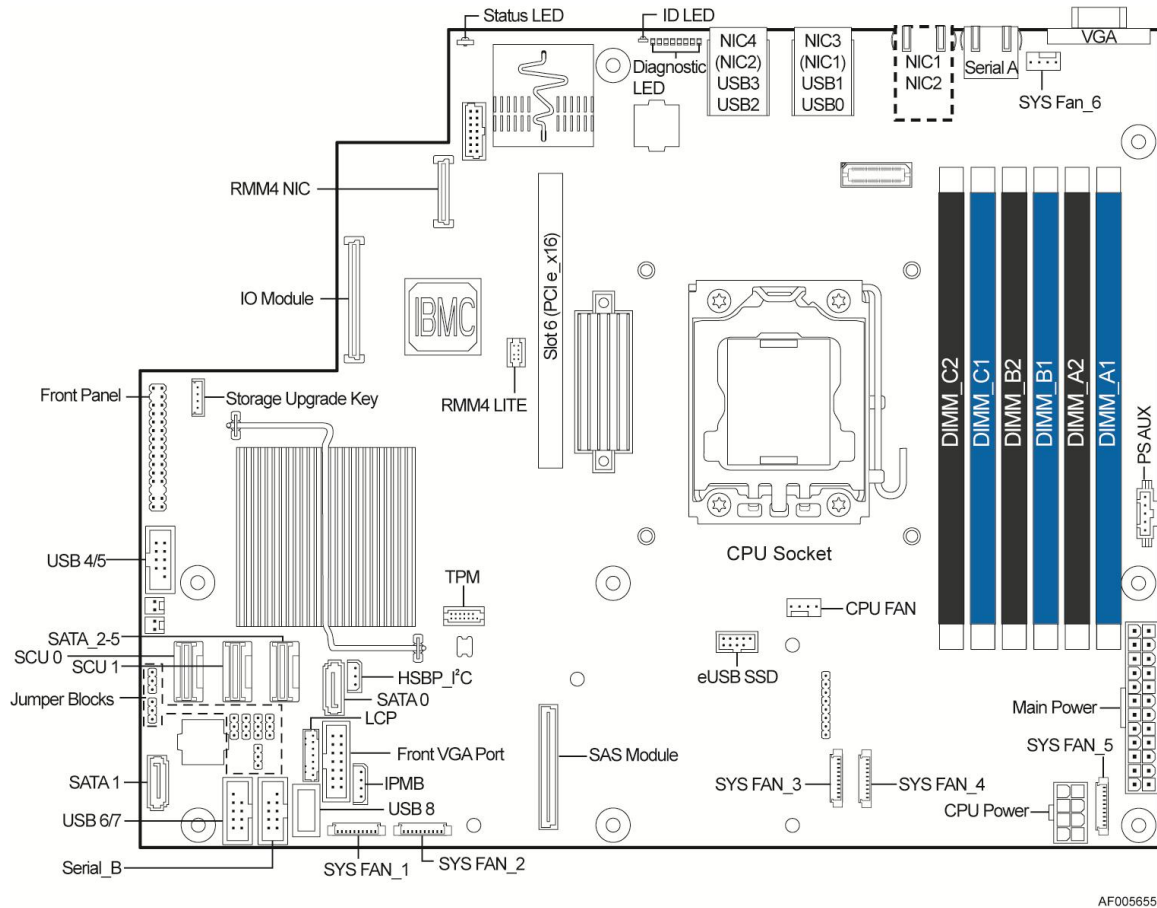

Figure 7. Back Panel Feature Identification

Server Board Components

This section helps you identify the components and connectors on the server board.



AF005655

Figure 8. Server Board Connector and Component Locations

Intel® Light-Guided Diagnostics

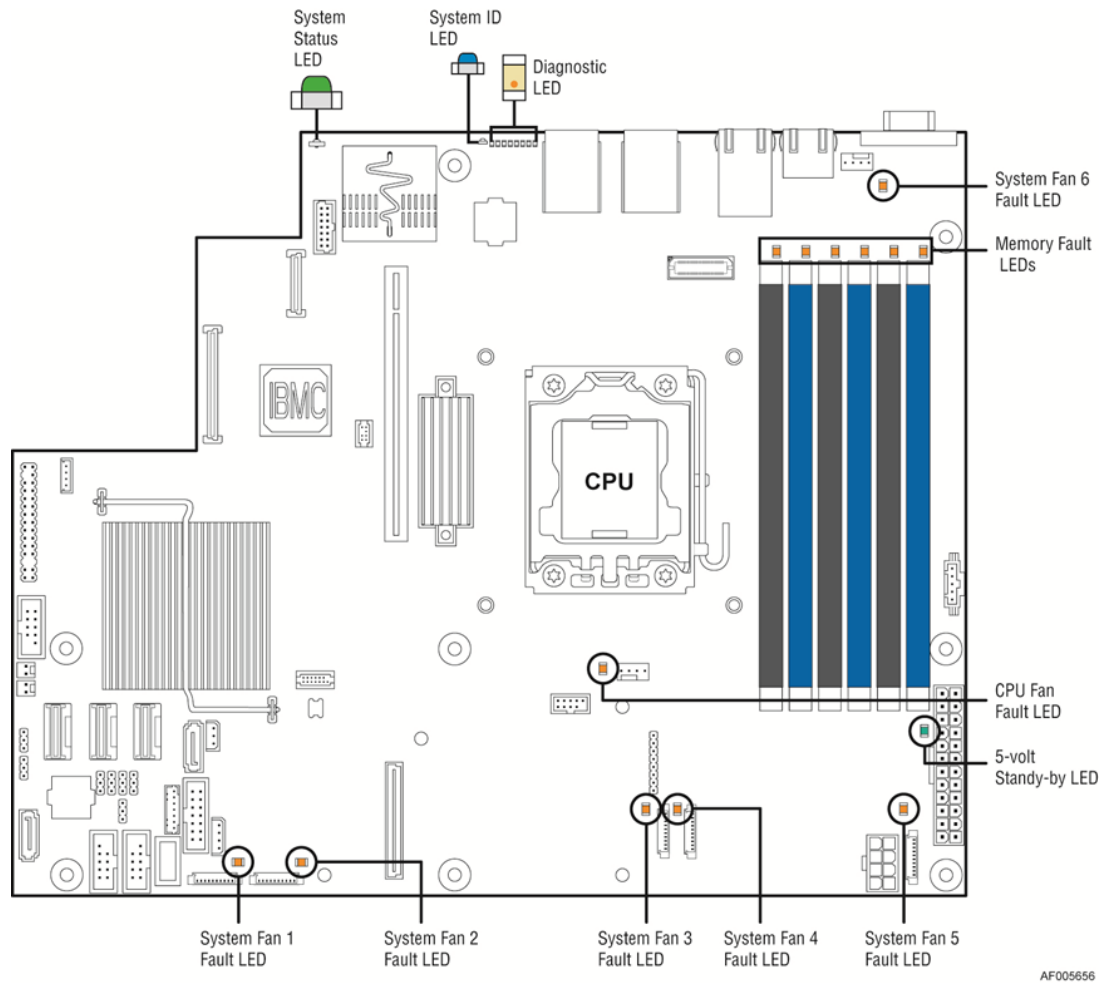

Figure 9. Intel® Light-Guided Diagnostic LEDs - Server Board

The server system contains the following diagnostic LEDs, each providing the following functions:

1. The System Identification LED on the front and back panel helps identify the server from among several servers. The ID LED is off by default, and blue when activated by button or software.
2. The System Status LED on the front and back panels shows the overall health of the system (green, blinking green, blinking amber, amber, off).
3. POST Code Diagnostic LEDs on the server board change color or state (off, green, red, and amber) according to the POST sequence.
4. System power good LED on the server board is illuminated when system power is good.
5. The 12V-STBY LED on the server board is illuminated (green) when power is applied.
6. Fan Fault LEDs help identify failed and failing fans. The fan fault LEDs turn on (amber) if there is a fan fault.

- DIMM Fault LEDs on the server board help identify failed and failing DIMM slots. The DIMM fault LEDs turn on (amber) if there is a DIMM fault.

System Recovery Jumpers

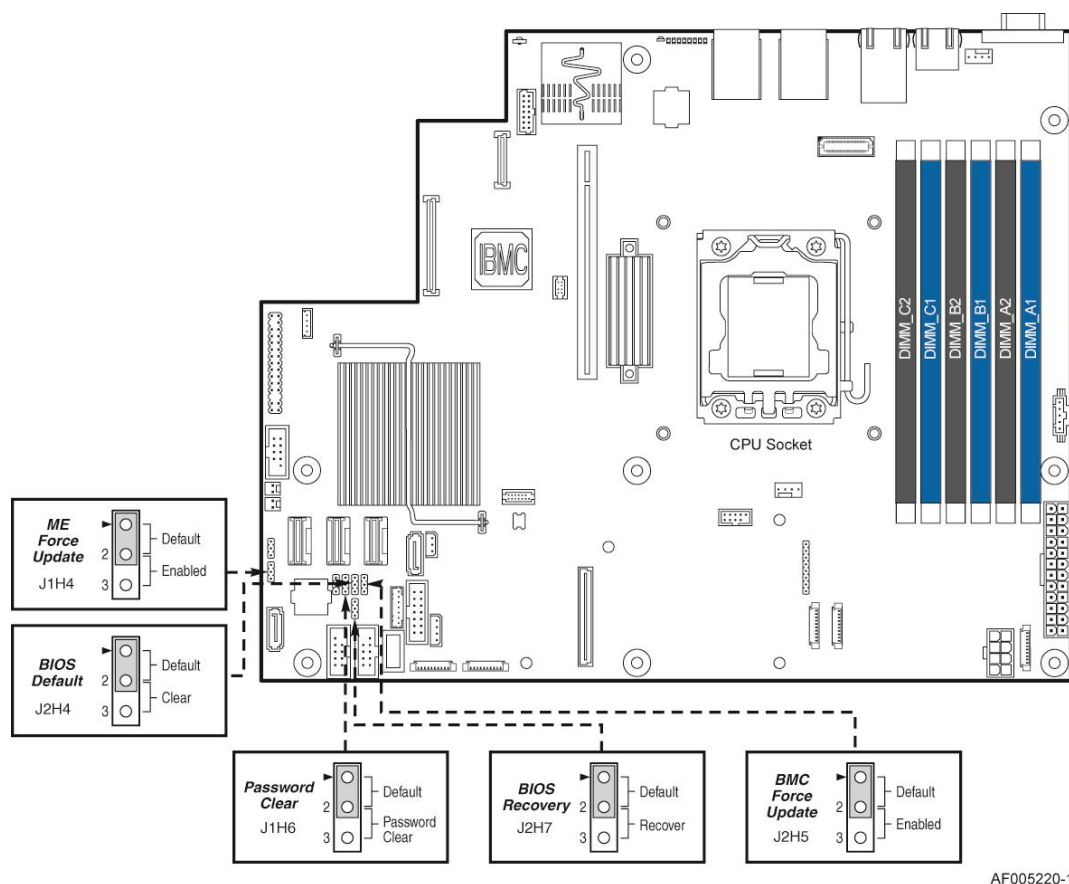

AF005220-1

Jumper Name	Jumper Purpose
BMC Force Update	If pins 2-3 are selected, the Integrated BMC Force Update Mode is enabled. These pins should be selected on 1-2 for normal system operation.
BIOS Recover	If pins 2-3 are selected, the system can only boot from EFI-bootable recovery media with the recovery BIOS image. The main system BIOS will not boot. These pins should be selected on 1-2 for normal system operation.
Password Clear	If pins 2-3 are selected, administrator and user passwords are cleared within five to ten seconds after the system is powered on. These pins should be selected on 1-2 for normal system operation.
ME Force Update	If pins 2-3 are selected, the ME Force Update Mode is enabled. These pins should be selected on 1-2 for normal system operation.
BIOS Default	If pins 2-3 are selected, the BIOS settings are cleared on the next reset. These pins should be selected on 1-2 for normal system operation.

Figure 10. Configuration Jumpers

Peripheral Devices

The Intel® Server System R1000SP provides locations and hardware for installing hard drives, CD-ROM drive, or DVD-ROM drive. The following figure shows the available options:

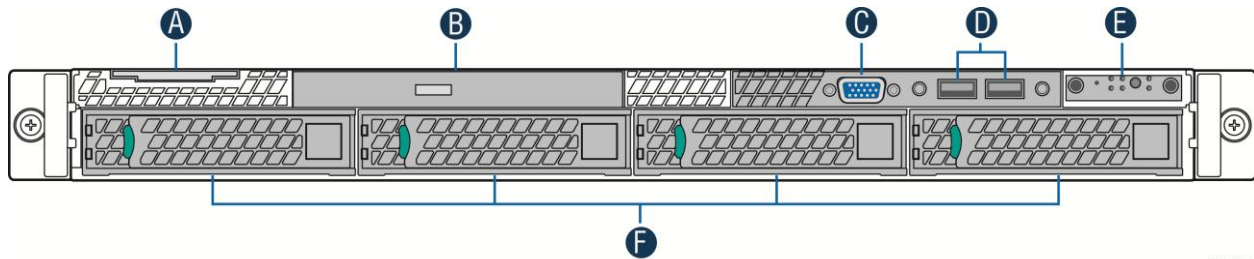

AF004581

A	System Label Pull-out
B	Slimline Optical Drive Bay
C	Video Port
D	USB Ports
E	Front Control Panel
F	Hard Disk Drive Bays

Figure 11. Optional Peripherals (8x2.5-inch hard drive bays as shown)

Hard Disk Drive Carriers

The Intel® Server System R1000SP ships with either 3.5-inch or 2.5 inch hard disk drive carrier, and with different maximum number of hard disk drives.

Note: SAS drives are only supported when proper Intel® RAID C600 Upgrade Key or Intel® Integrated RAID Module is installed.

For instructions on installing hard drives, see [“Installing a Hot-swap Hard Disk Drive”](#).

Note:

1. Drives can consume up to 17 watts of power each. Drives must be specified to run at a maximum ambient temperature of 45°C.
2. The Intel® Server System R1000SP does not support all SAS or Serial ATA (SATA) hard drives. For a web link to a list of supported hard drives, see [“Additional Information and Software”](#).

Slimline Optical Drive Support

The system has support for a single optical drive. The optical drive is NOT hot-swappable. The system power must be turned off to insert or remove the slimline optical drive. For instructions on installing an optical drive, see [“Installing or Removing a Slimline Optical Drive”](#).

Intel® makes the following optical drive accessory kits available for this server system:

- Slimline DVD-ROM Drive: AXXSATADVDRM
- Slimline DVD-RW Drive: AXXSATADVDRWROM

Note: For a complete list of supported peripherals, go to http://serverconfigurator.intel.com/sct_app.aspx.

Bezel

The front bezel is available as optional accessory for the server system:

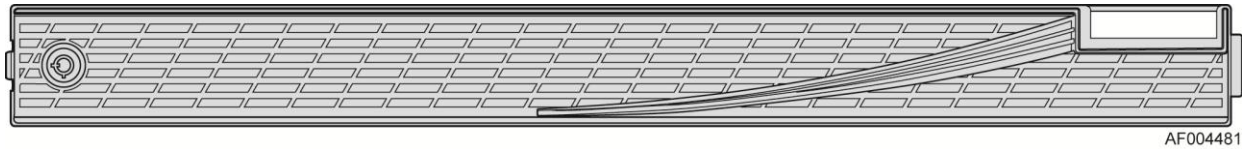

Figure 12. Front view of Front Bezel

Hot-Swap SAS/SATA Backplane

The Hot-Swap SAS/SATA backplane serves as an interface between the motherboard and the system drives. The following diagrams show the location for each connector found on the backplane.

4 x 3.5-inch Hard Drive Backplane

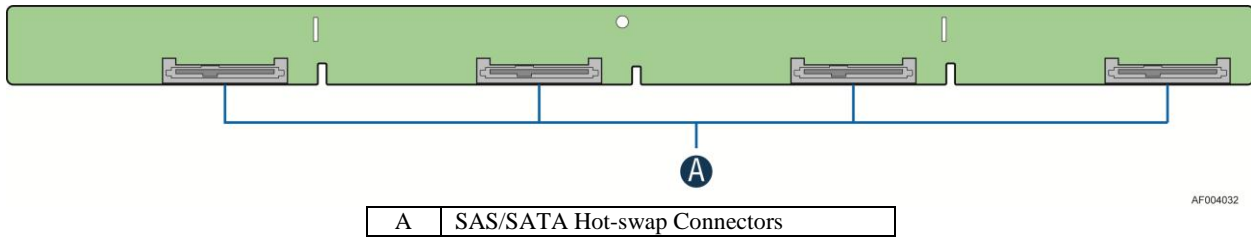

Figure 13. 4 x 3.5-inch Hard Drive Backplane Components (Front View)

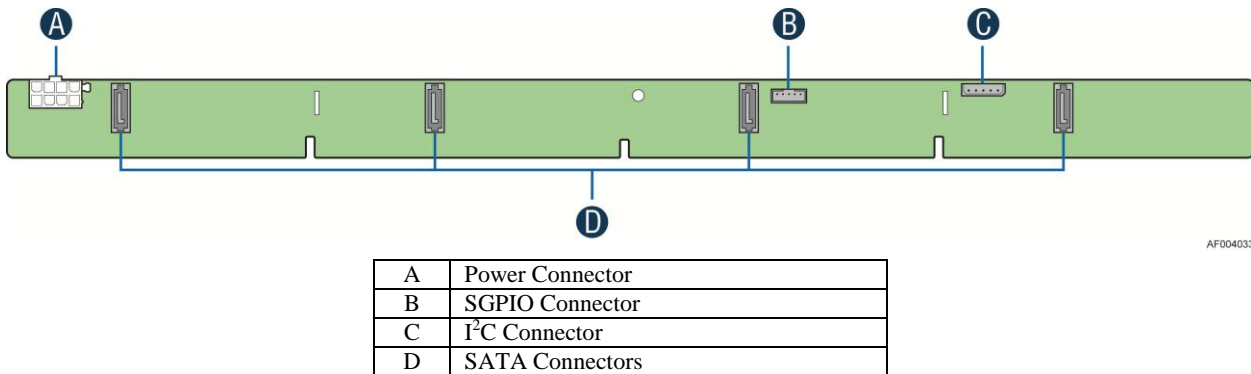

Figure 14. 4 x 3.5-inch Hard Drive Backplane Components (Rear View)

8 x 2.5-inch Hard Drive Backplane

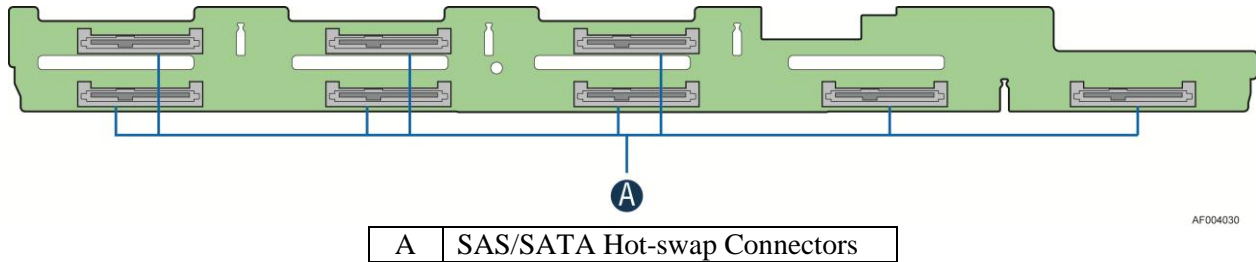

Figure 15. 8 x 2.5-inch Hard Drive Backplane Components (Front View)

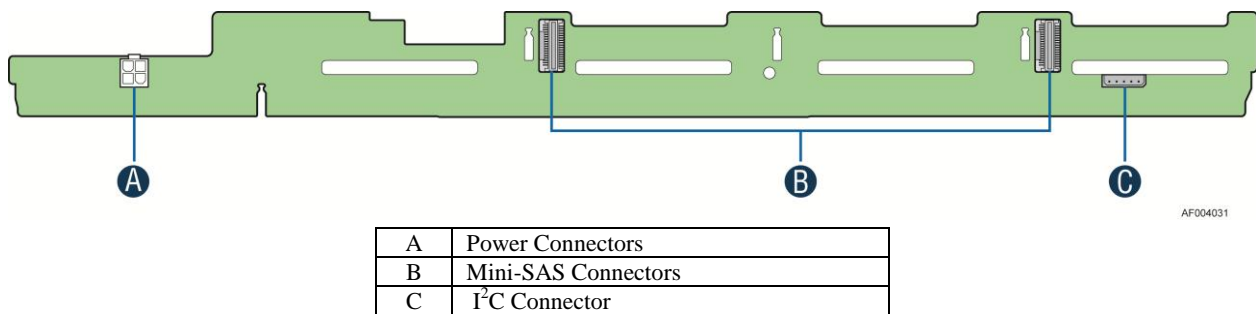

Figure 16. 8 x 2.5-inch Hard Drive Backplane Components (Rear View)

Advanced Management Options

Intel[®] Remote Management Module 4

The Intel[®] Remote Management Module 4 plugs into a dedicated connector on the server board and provides additional server management functionality to the server board. This module provides a dedicated web server for viewing server information and remote control of the system. It also provides Remote KVM Redirection and USB Media Redirection allowing USB devices attached to the remote system to be used on the managed server. For instructions on installing the Intel[®] Remote Management Module 4, see [“Installing and Removing the Intel[®] Remote Management Module 4”](#).

2 Hardware Installations and Upgrades

Before You Begin

Before working with your server product, pay close attention to the “[Safety Information](#)” at the beginning of this manual.

Note: Whenever you service the system, you must first power down the server and unplug all peripheral devices and the power cord.

Tools and Supplies Needed

- Phillips* (cross head) screwdriver (#2 bit)
- Needle nosed pliers
- Anti-static wrist strap and conductive foam pad (recommended)

System Reference

All references to left, right, front, top, and bottom assume the reader is facing the front of the chassis as it would be positioned for normal operation.

Cable Routing

When you add or remove components from your server system, make sure your cables are routed correctly before reinstalling the server system cover. Use caution to make sure no cables or wires are pinched and that the airflow from the fans is not blocked. Use the following figures to determine the correct cable routing.

Note: Red lines are for power connection and the dotted lines are for optional device connection.

For system with 4 x 3.5" fixed hard drive bay:

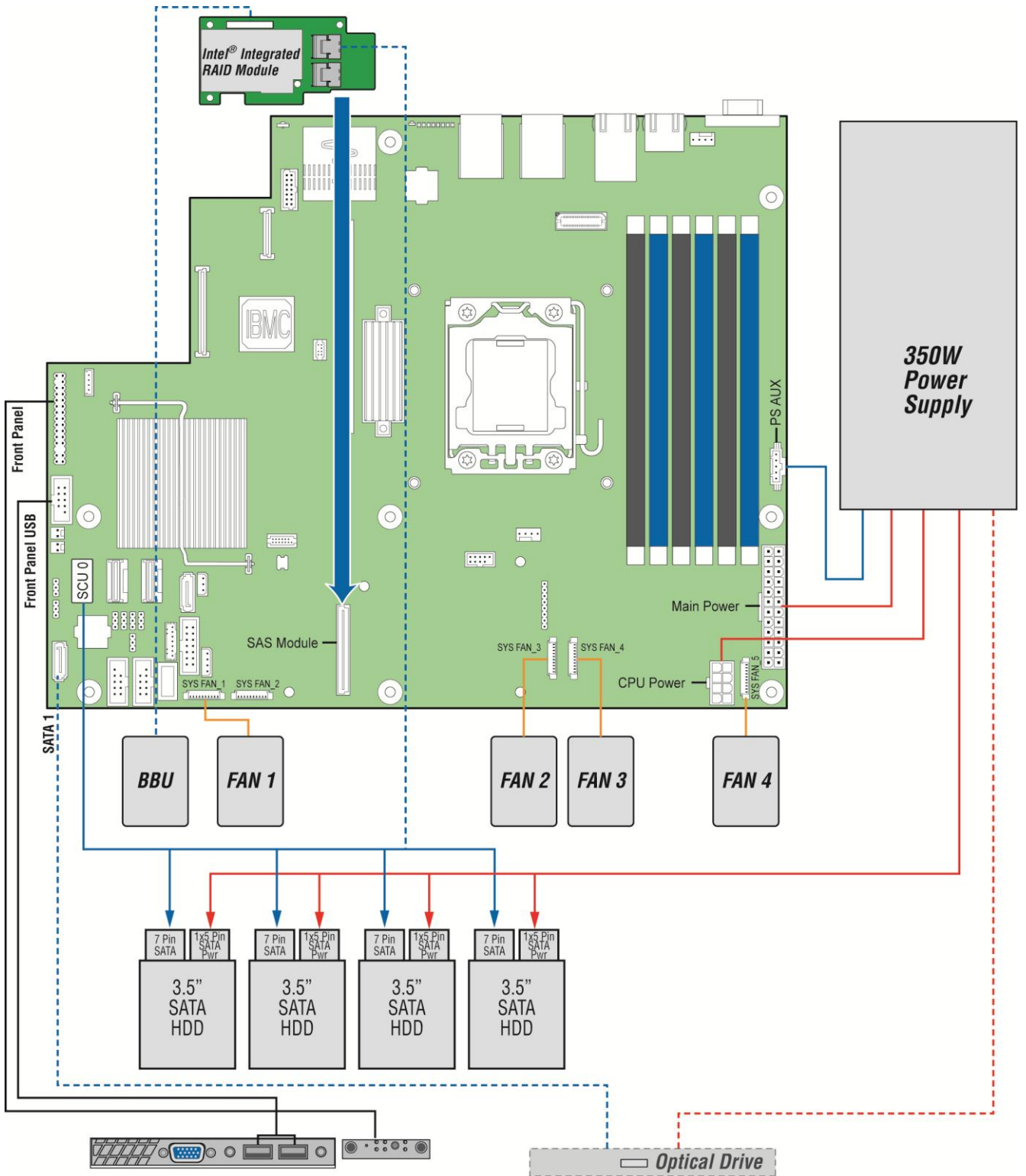

AF005735

Figure 17. Cable Routing – 4 x 3.5" Fixed HDD

For system with 8 x 2.5" hard drive bay:

Note:

1. To activate the port SCU1 (4-7) on the server board, a proper Intel® RAID C600 Upgrade Key must be installed. For instructions, see Intel® RAID C600 Upgrade Key Installation Guide.
2. An optical drive can be installed to replace the Front Panel I/O.

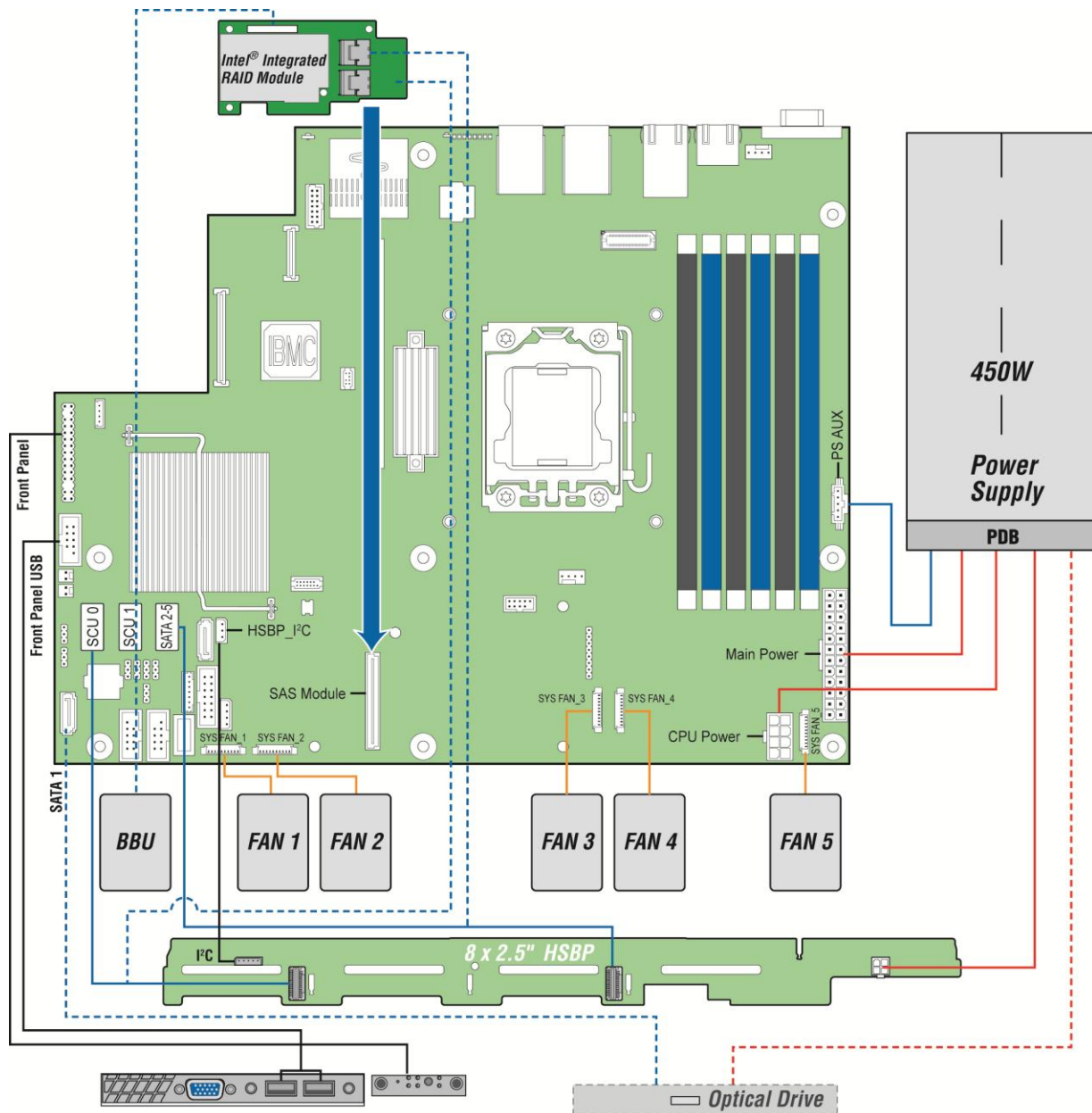

AF005734

Figure 19. Cable Routing – 8 x 2.5" HDD

Fan Connections

Use the following figures to determine the proper fan connections:

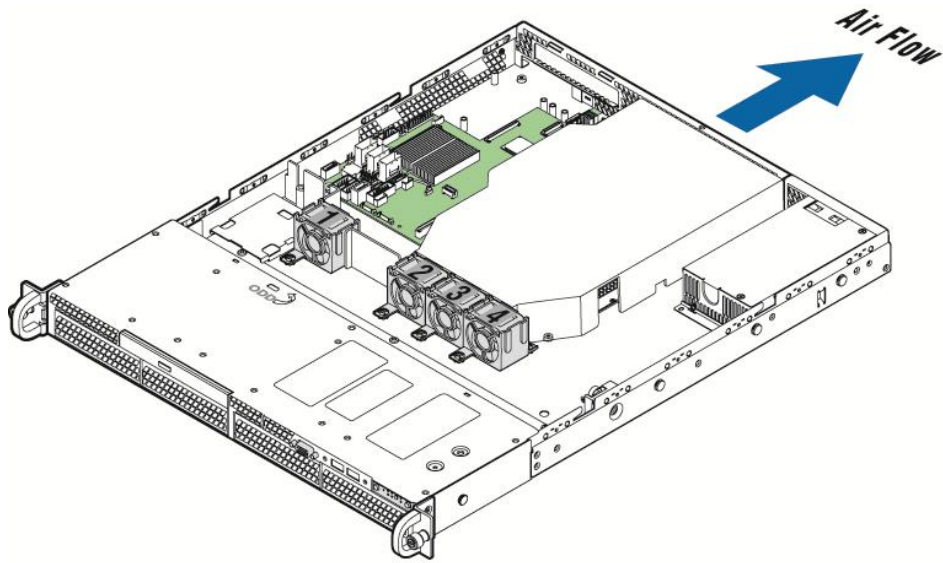

AF005762

Figure 20. Fixed System Fan Order

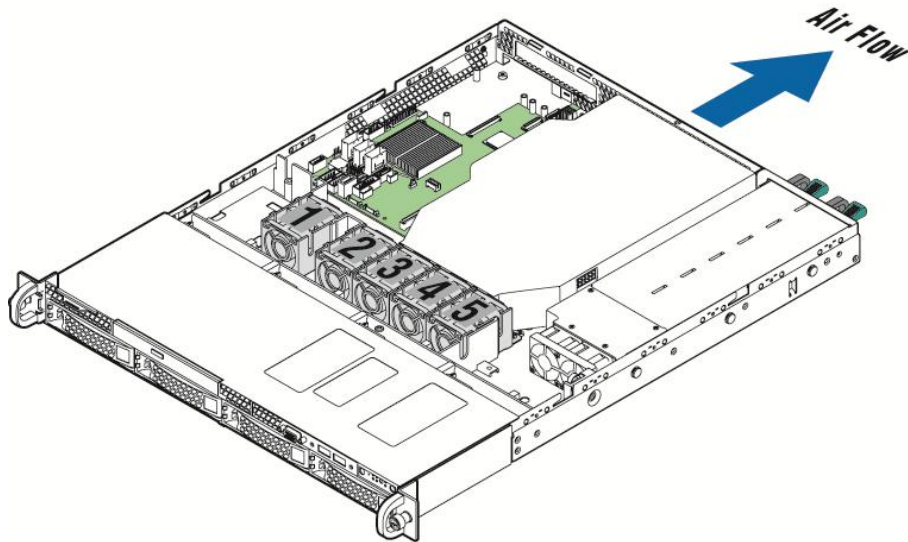

AF005763

Figure 21. Redundant System Fan Order

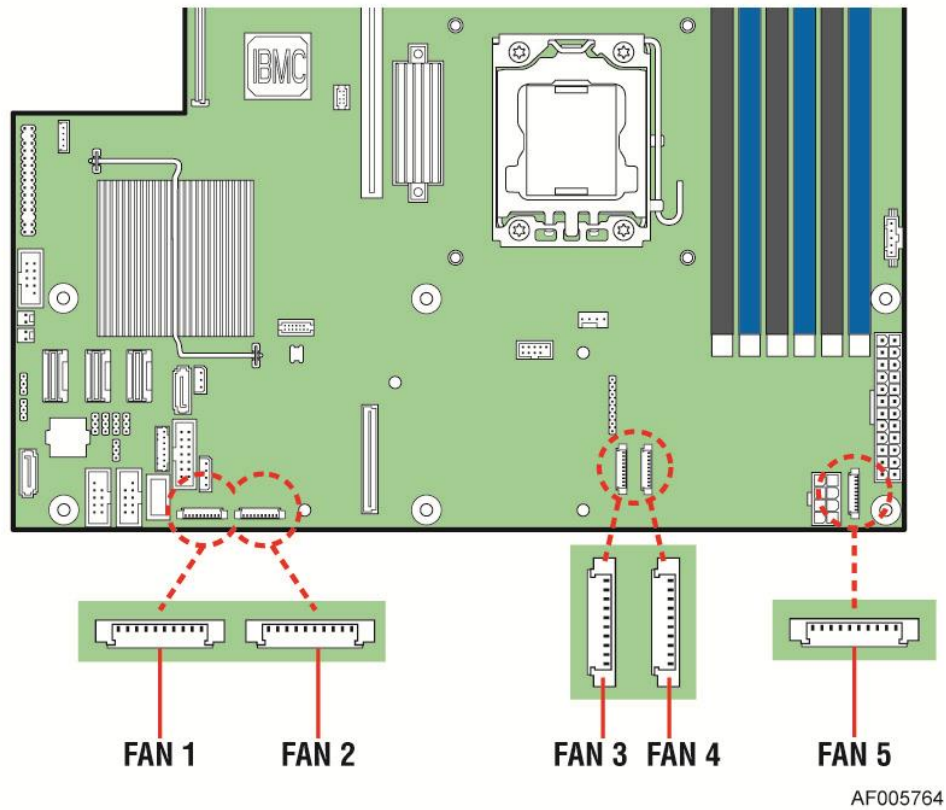

Figure 22. Connecting the Fan Power Cables to the Mother Board

Removing and Installing the Front Bezel

Removing the Front Bezel

If your system includes a front bezel, follow these steps to remove the front bezel:

1. Unlock the bezel if it is locked.
2. Remove the left end of front bezel from rack handle (see letter **A**).
3. Rotate the front bezel anticlockwise to release the latches on the right end from the rack handle (see letter **B**).

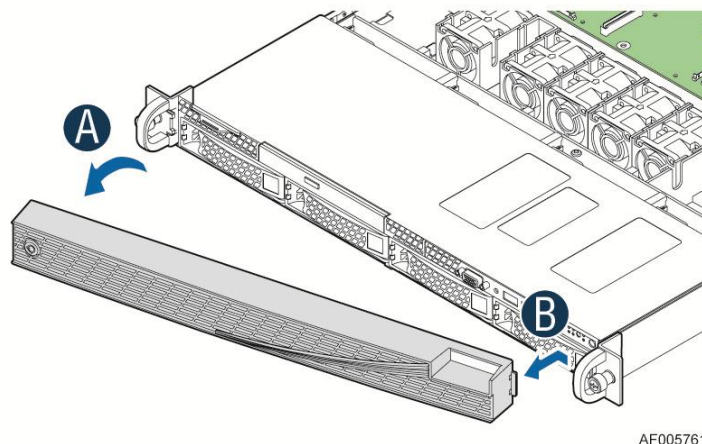

AF005761

Figure 23. Removing the Front Bezel

Installing the Front Bezel

Note: Before installing the bezel, you must install the rack handles.

1. Lock the right end of the front bezel to the rack handle (see letter **A**).
2. Push in the left side of the bezel until it clicks into place (see letter **B**).
3. Lock the bezel if needed.

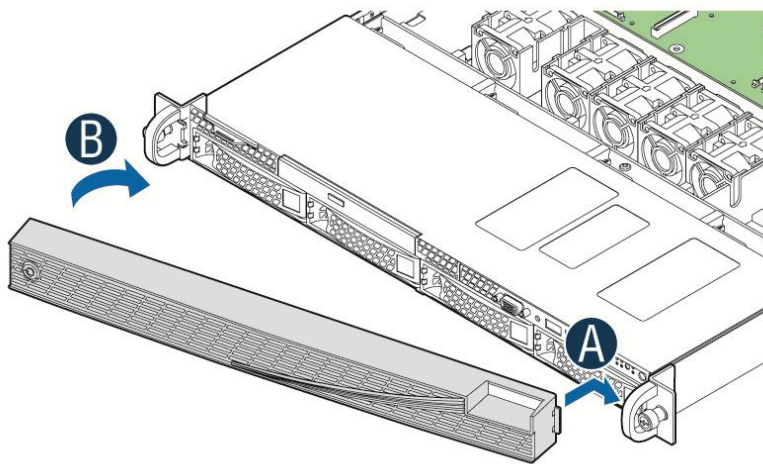

AF005760

Figure 24. Installing the Front Bezel

Removing and Installing the System Cover

Removing the System Cover

The server system must be operated with the system cover in place to ensure proper cooling. You will need to remove the top cover to add or replace components inside of the server. Before removing the top cover, power down the server and unplug all peripheral devices and the power cable(s).

Note: A non-skid surface or a stop behind the server system may be needed to prevent the server system from sliding on your work surface.

1. Observe the safety and ESD precautions at the beginning of this book.
2. Turn off all peripheral devices connected to the server. Turn off the server.
3. Disconnect the power cord.
4. Remove the four screws (see letter **A**).
5. Slide cover back and lift upward (see letter **B**).

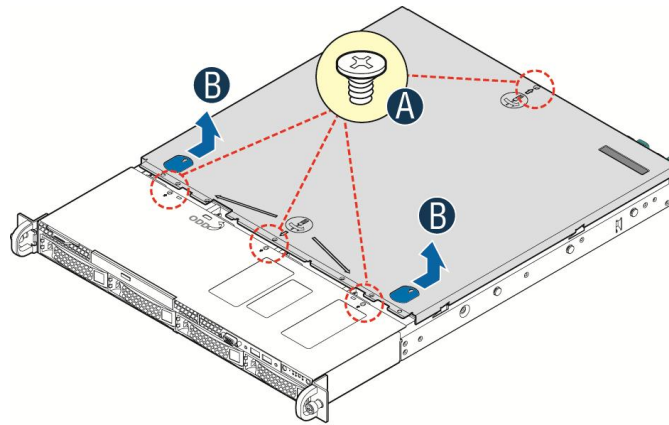

AF005841

Figure 25. Removing the System Cover

Installing the System Cover

1. Place the top cover on system and slide towards the front of chassis until the recessed front edge is fully engaged (see letter **A**).
2. Install the three screws at the front and torque to 7-9in-lbs, then install the screw at the back and torque to 7-9in-lbs (see letter **B**).

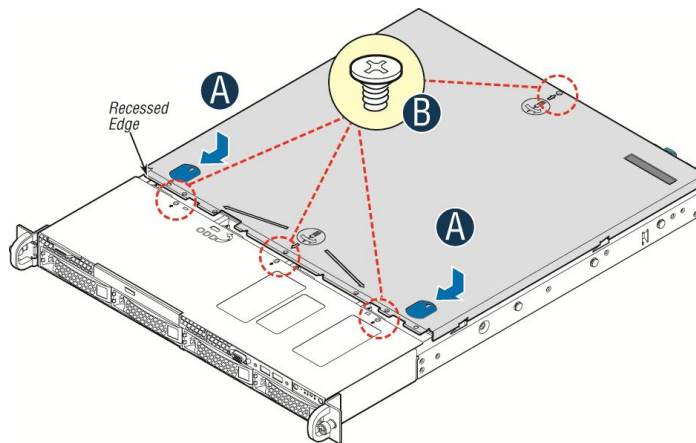

AF005842

Figure 26. Installing the System Cover

Removing and Installing the Air Duct

Always operate your server system with the air duct in place. The air duct is required for proper airflow within the server system.

Removing the Air Duct

Remove the air duct by lifting straight up.

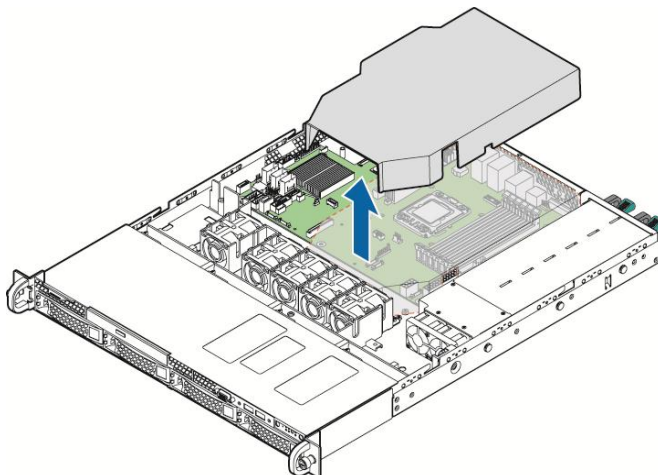

AF005757

Figure 27. Removing the Air Duct

Installing the Air Duct

Align the two holes on the air duct with the alignment pins on the chassis and install the air duct into place.

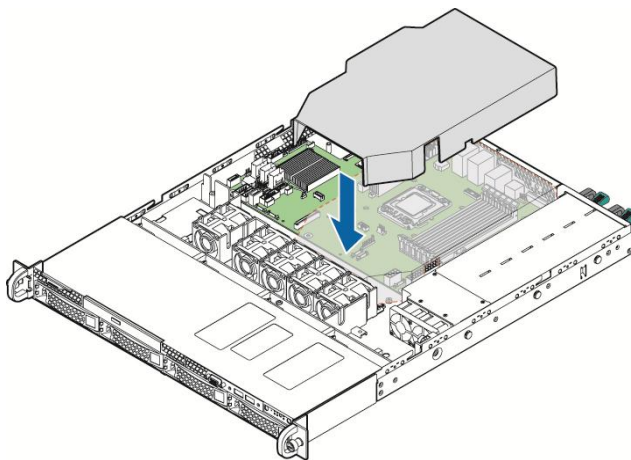

AF005756

Figure 28. Installing the Air Duct

Removing and Installing Processor

The heatsink has thermal interface material (TIM) on the underside of it. Use caution so that you do not damage the thermal interface material. Use gloves to avoid sharp edges.

Removing Processor Heatsink

The heatsink is attached to the server board/processor socket with captive fasteners. Using a #2 Phillips* screwdriver, loosen the four screws located on the heatsink corners in a diagonal manner using the following procedure:

1. Using a #2 Phillips* screwdriver, start with screw 1 and loosen it by giving it two rotations and stop (see letter **A**). (IMPORTANT: Do not fully loosen.)
2. Proceed to screw 2 and loosen it by giving it two rotations and stop (see letter **B**). Similarly, loosen screws 3 and 4. Repeat steps A and B by giving each screw two rotations each time until all screws are loosened.
3. Lift the heatsink straight up (see letter **C**).

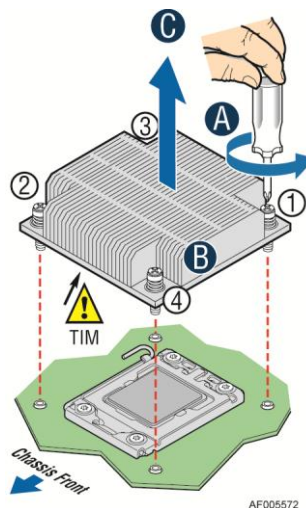

Figure 29. Removing Processor Heatsink

Installing the Processor

Caution:

1. *Processor must be appropriate: You may damage the server board if you install a processor that is inappropriate for your server. For a web link to the list of compatible processor(s), see “[Additional Information and Software](#)”.*
2. *ESD and handling processors: Reduce the risk of electrostatic discharge (ESD) damage to the processor by doing the following:*
 - a. *Touch the metal chassis before touching the processor or server board. Keep part of your body in contact with the metal chassis to dissipate the static charge while handling the processor.*
 - b. *Avoid moving around unnecessarily.*
3. *Protective socket cover needs to be removed for proper cooling of the processor; failure to remove the cover could result in damage to the system.*

1. Open the Socket Lever. Push the level handle down and away from the socket to release it (see letter **A**). Rotate the lever open all the way (see letter **B**).

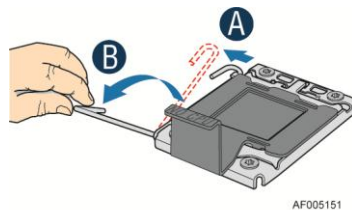

Figure 30. Installing Processor – Open the Socket Lever

2. Open the Load Plate. Press the locking lever slightly to raise the load plate (see letter **A**). Open the load plate all the way (see letter **B**).

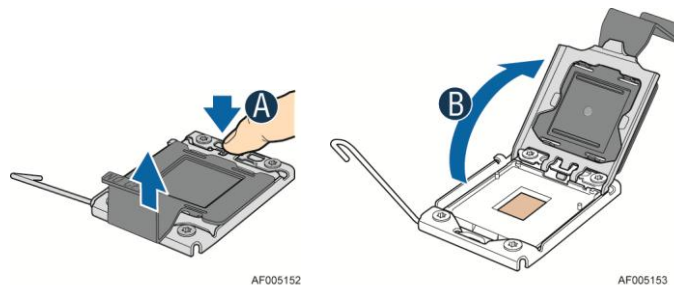

Figure 31. Installing Processor – Open the Load Plate

3. Install the Processor. Take the processor out of the box and remove the protective shipping cover. Orient the processor with the socket so that the orientation notches on the processor align with the two orientation posts on the socket (see letter **A**).

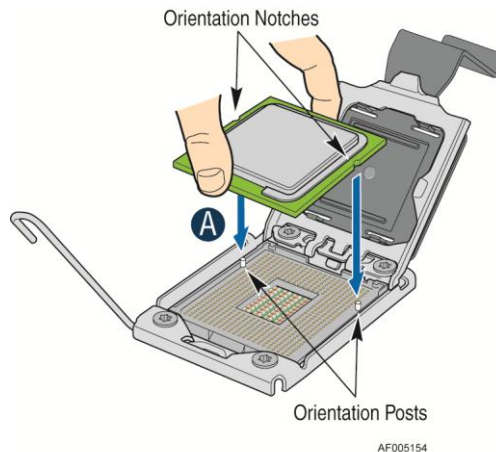

Figure 32. Installing Processor – Install the Processor

Note: The underside of the processor has components that may damage the socket pins if installed improperly. Processor must align correctly with the socket opening before installation. **DO NOT DROP** processor into socket!

4. Press the protective cover to remove it from the load plate. Close the Load Plate and Socket Lever.

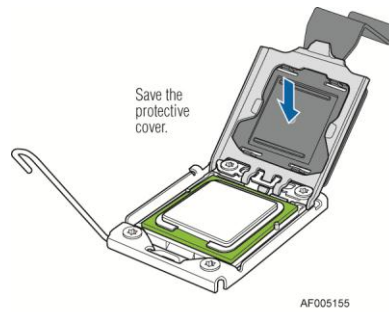

Figure 33. Installing Processor – Remove the Cover

5. Close the load plate all the way as shown.

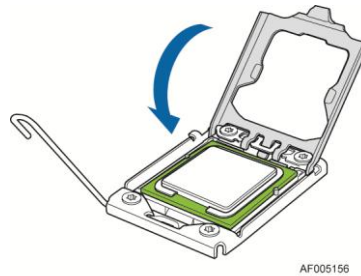

Figure 34. Installing Processor – Close the Load Plate

6. With your finger, push down on the load plate lever as shown. Close the socket lever and ensure that the load plate tab engages under the socket lever when fully closed (see letter **B**).

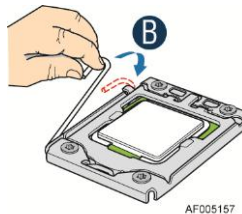

Figure 35. Installing Processor – Latch the Locking Lever

Installing Processor Heatsink

1. Remove the protective film on the TIM if present (see letter **A**).
2. Align heatsink fins to the front and back of the chassis for correct airflow. Airflow goes from front-to-back of chassis (see letter **B**).

Each heatsink has four captive fasteners and should be tightened in a diagonal manner using the following procedure:

3. Using a #2 Phillips* screwdriver, start with screw 1 and engage screw threads by giving it two rotations and stop (see letter **C**). (Do not fully tighten.)
4. Proceed to screw 2 and engage screw threads by giving it two rotations and stop (see letter **D**). Similarly, engage screws 3 and 4.
5. Repeat steps C and D by giving each screw two rotations each time until each screw is lightly tightened up to a maximum of 8 inch-lbs torque (see letter **E**).

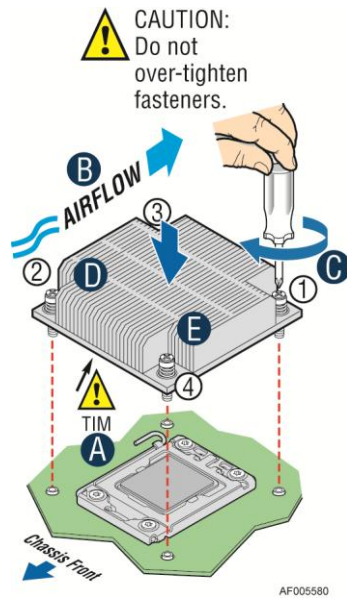

Figure 36. Installing Processor Heatsink

Removing the Processor

1. Remove the processor heatsink; see Figure 29
2. Open the socket lever; see Figure 30
3. Open the load plate; see Figure 31
4. Remove the processor.

Installing and Removing Memory

Installing Memory

1. Locate the DIMM sockets. Make sure the clips at either end of the DIMM socket(s) are pushed outward to the open position (see letter **A**).
2. Holding the DIMM by the edges, remove it from its anti-static package. Position the DIMM above the socket. Align the notch on the bottom edge of the DIMM with the key in the DIMM socket (see letter **B**).
3. Insert the bottom edge of the DIMM into the socket (see letter **C**). When the DIMM is inserted, push down on the top edge of the DIMM until the retaining clips snap into place (see letter **D**). Make sure the clips are firmly in place (see letter **E**).

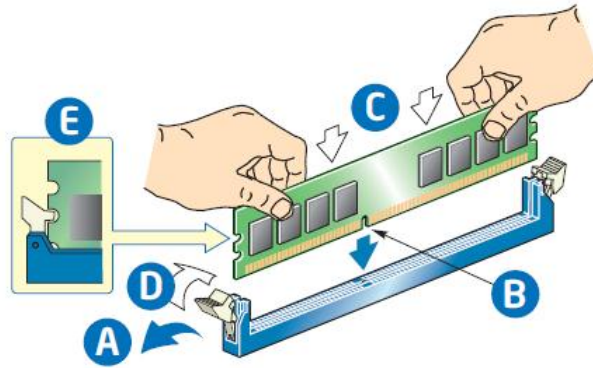

Figure 37. Installing Memory

Removing Memory

1. Locate the DIMM sockets. Gently spread the retaining clips at each end of the socket. The DIMM lifts from the socket.
2. Holding the DIMM by the edges, lift it from the socket, and store it in an anti-static package.

Installing and Removing Hot-swap Hard Drive

Caution: If you do not install all drives, empty drive bays must be occupied by carriers with plastic drive blank provided to maintain proper system cooling.

Installing a Hard Disk Drive into 3.5" Hard Drive Carrier

1. Remove the drive carrier by pressing the green button and opening the lever (see letter **A**). Slide the carrier out (see letter **B**).

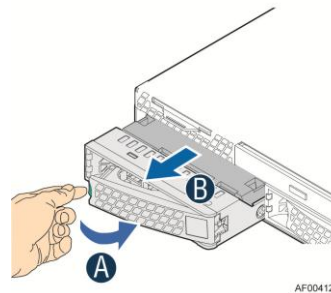

Figure 38. Installing Hard Disk Drive – Removing 3.5" HDD carrier

2. Remove the four screws securing the HDD interface bracket and remove the HDD interface bracket (see letter **C**).

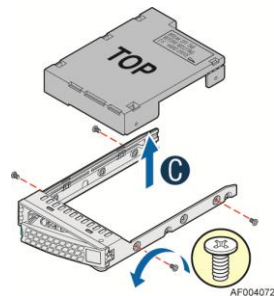

Figure 39. Installing Hard Disk Drive – Removing 3.5" HDD interface bracket

3. Install the hard disk drive using the same four screws as shown. Make sure the connector end of the drive matches the backplane connector (see letter **D**).

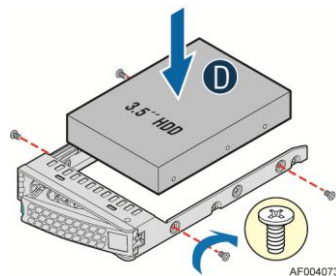

Figure 40. Installing Hard Disk Drive – Installing 3.5" HDD

For installing 2.5" Hard Disk Drive as option:

- i. Break off the tab on the HDD interface bracket (see letter **d1**).
- ii. Install the HDD interface bracket from top.
- iii. Secure the bracket with three screws as shown (see letter **d2**).
- iv. Slide the 2.5" HDD into the bracket to align the screw holes with the right and left rail (see letter **d3**).
- v. Secure the hard disk drive using the four screws for 2.5" HDD (see letter **d4**).

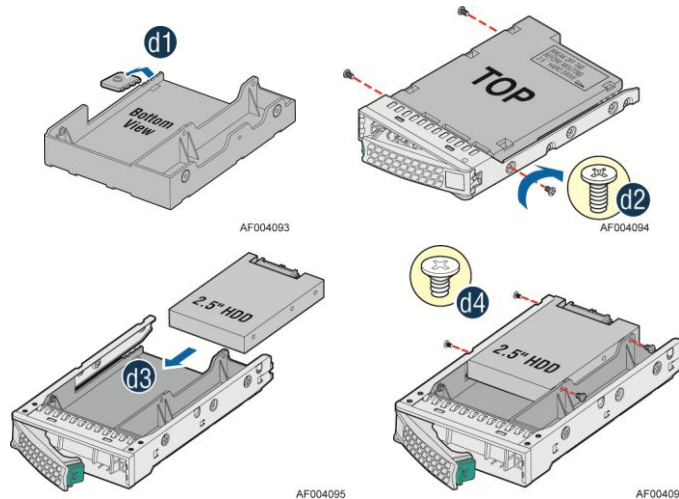

Figure 41. Installing Hard Disk Drive – Installing 2.5" HDD

4. With the lever open, insert the hard disk drive assembly into the chassis (see letter **E**). Push in the lever to lock it in place (see letter **F**).

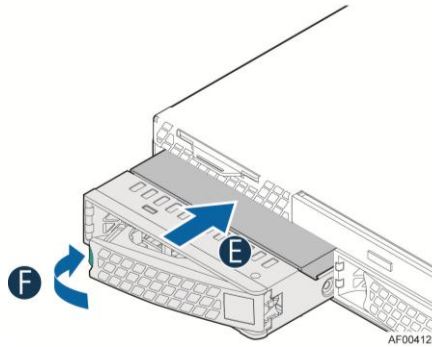

Figure 42. Installing Hard Disk Drive – Inserting 3.5" HDD assembly

Installing a Hard Disk Drive into 2.5" Hard Drive Carrier

1. Remove the drive carrier by pressing the green latch to unlock (see letter **A**). Pull out the black lever and slide the carrier out (see letter **B**).

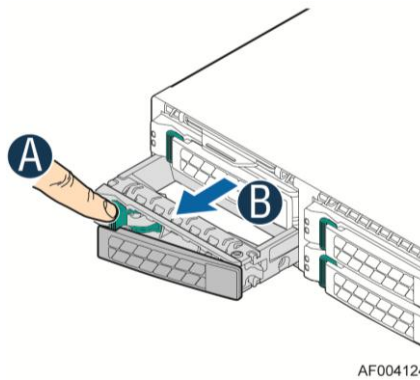

Figure 43. Installing Hard Disk Drive – Removing 2.5" HDD carrier

2. Remove the four screws securing the plastic drive blank from the 2.5" HDD carrier (see letter **C**). Disengage the plastic drive blank from the HDD carrier. Remove the plastic drive blank from the 2.5" HDD carrier (see letter **D**).

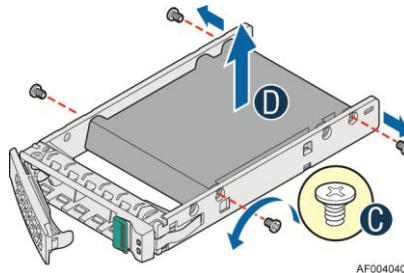

Figure 44. Installing Hard Disk Drive – Removing plastic drive blank

3. Install the hard disk drive using the four screws as shown. Make sure the connector end of the drive matches the backplane connector (see letter **E**).

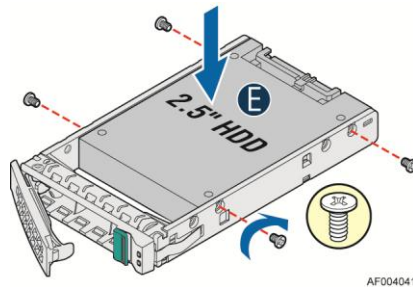

Figure 45. Installing Hard Disk Drive – Installing 2.5" HDD

4. With the lever open, insert the hard disk drive assembly into the chassis, then push in the lever to lock it into place (see letter F).

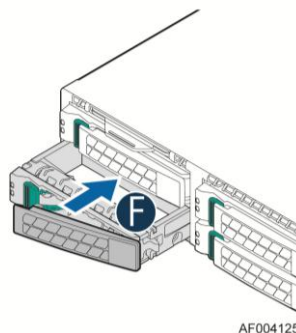

Figure 46. Installing Hard Disk Drive – Inserting 2.5" HDD assembly

Removing and Installing the PCI Riser Assembly

Removing the PCI Riser Assembly

Disconnect any cables attached to any add-in cards. Grasp the riser assembly with both hands and pull up to remove from system.

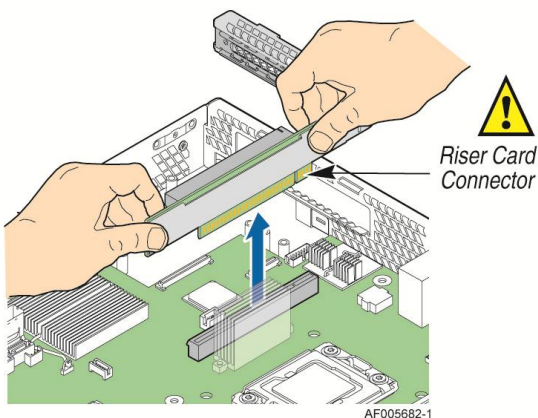

Figure 47. Removing PCI Riser Assembly

Do one of the following:

- If you need to add or replace a PCI add-in card, see “[Installing and Removing a PCI Add-in Card](#)”.

- If you need to add or replace a PCI riser card, see “[Replacing a PCI Riser Card](#)”.
- If you removed the PCI riser assembly for another procedure, continue with that procedure.

Installing the PCI Riser Assembly

1. Position the riser card edge connector over the server board riser socket and align the two hooks on the back edge of the riser assembly with the slots on the back of the chassis, then press straight down into riser socket.

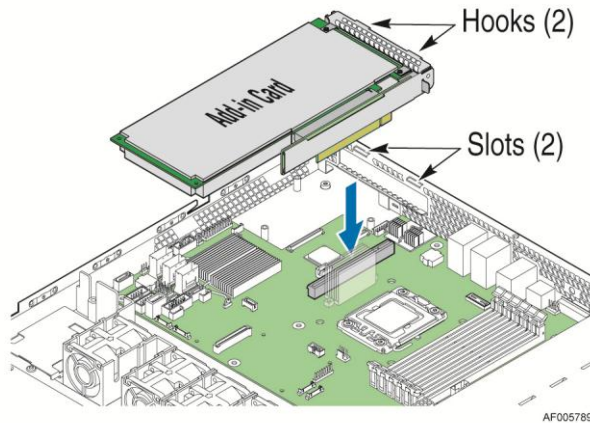

Figure 48. Installing PCI Riser Assembly

2. Connect any cables to add-in cards that require them. See your add-in card documentation for information and add-in card requirements.

Installing and Removing a PCI Add-in Card

Installing a PCI Add-in Card

1. Remove the PCI riser assembly. For instructions, see “[Removing the PCI Riser Assembly](#)”.
2. Remove the filler panel from the add-in card slot and remove the screw as shown (see letter **A**).
3. Insert add-in card until it sits in the riser connector (see letter **B**).
4. Secure add-in card with screw as shown (see letter **C**).

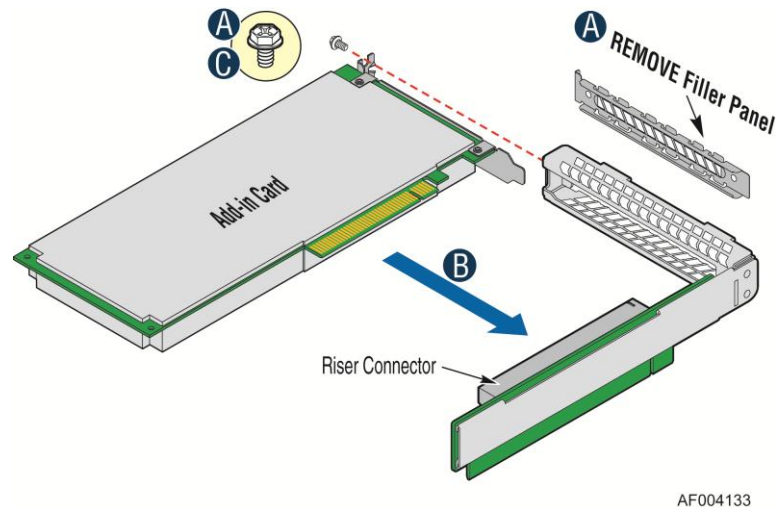

Figure 49. Installing a PCI Add-In Card

Removing a PCI Add-in Card

1. Remove the PCI riser assembly. For instructions, see “[Removing the PCI Riser Assembly](#)”.
2. Remove the screw as shown (see letter **A**).
3. Remove the PCI add-in card from the riser card connector (see letter **B**).

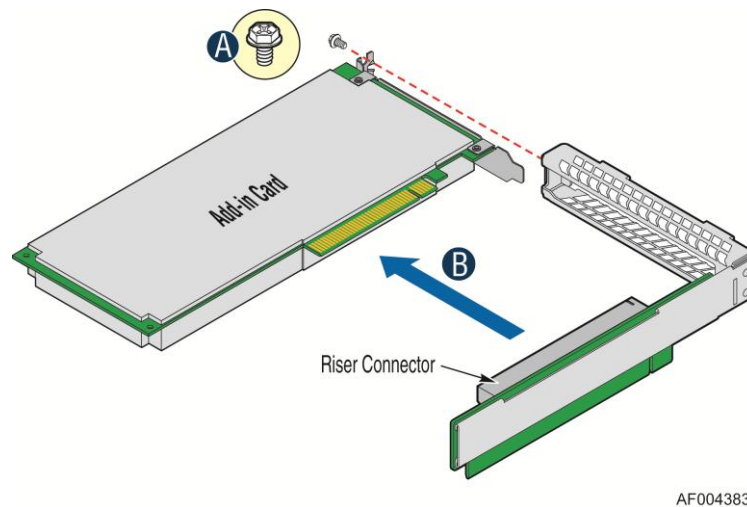

Figure 50. Removing a PCI Add-In Card

Note: Make sure that all empty add-in card slots have filler panels installed.

Replacing a PCI Riser Card

Caution: PCI riser cards are NOT hot-swappable. Before removing or replacing the riser card, you must first take the server out of service, turn off all peripheral devices connected to the system, turn off the system by pressing the power button, and unplug the power cord from the system or wall outlet.

Note: To eliminate the possibility of installing the replacement connector on the wrong side of the PCI riser assembly, replace one connector at a time.

Removing a PCI Riser Card

1. Disconnect any cables attached to any add-in cards.
2. Remove the PCI riser assembly. For instructions, see “[Removing the PCI Riser Assembly](#)”.
3. Remove any add-in cards from the PCI riser card. For instructions, see “[Removing a PCI Add-in Card](#)”.
4. Remove the two screws securing the PCI Riser Card (see letter **A**).
5. Remove from the riser card from riser assembly (see letter **B**).

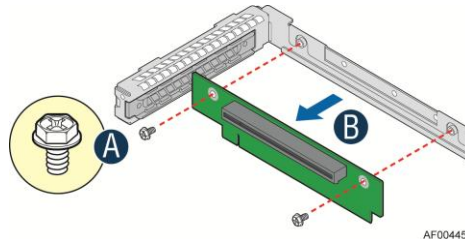

Figure 51. Removing the PCI Riser Card

Installing a PCI Riser Card

1. Place the riser card onto the riser assembly (see letter **A**).
2. Secure the riser card using the two screws (see letter **B**).

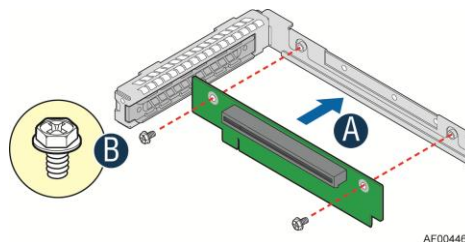

Figure 52. Installing the PCI Riser Card

Installing and Removing a Slimline Optical Drive

Caution: The slimline optical drive is **NOT** hot-swappable. Before removing or replacing the drive, you must first take the server out of service, turn off all peripheral devices connected to the system, turn off the system by pressing the power button, and unplug the power cord from the system or wall outlet.

To maintain proper system cooling, a filler panel must be installed if you do not install a device at this location.

Installing a Slimline Optical Drive

1. Install the plastic guide onto the back of the drive and attach with two screws as shown (see letter **A**).

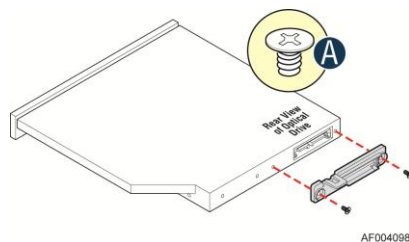

Figure 53. Installing the Plastic Guide to the Optical Drive

2. Insert the optical drive into chassis opening and push all the way until it stops (see letter **B**).
3. Connect the cables as shown (see letter **C**).

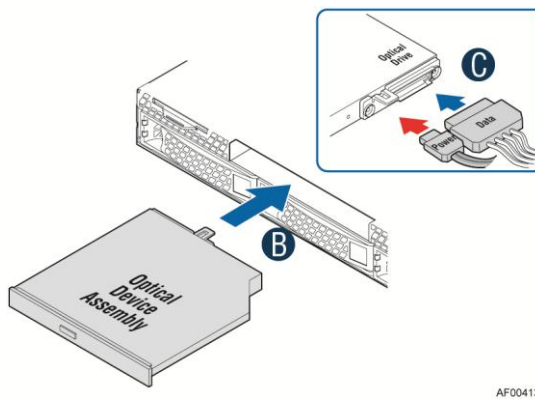

Figure 54. Installing an Optical Drive

Removing a Slimline Optical Drive

1. Remove the cables (see letter **A**).
2. Lift up the blue tab to release the optical drive (see letter **B**).
3. Slide the optical drive out (see letter **C**).

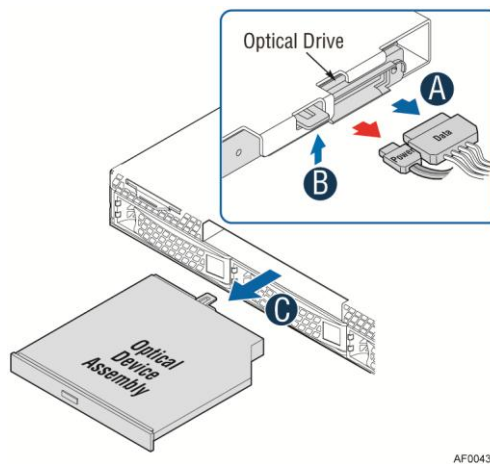

Figure 55. Removing the Slimline Optical Drive

4. If no device will be installed in this location, install a filler panel in this location.

Installing and Removing Intel® I/O Expansion Module

Installing Intel® I/O Expansion Module

1. Squeeze the sides of the filler panel to disengage it from the server system back panel and remove it (see letter **A**).
2. Position the module over the server board, fit the front of the module into the back panel slot (see letter **B**).
3. Attach the module to the server board connector (see letter **C**).
4. Secure the module with the three screws as shown (see letter **D**).

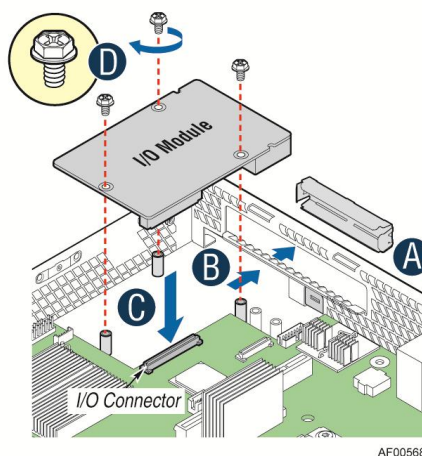

Figure 56. Installing Intel® I/O Expansion Module

Removing Intel® I/O Expansion Module

1. Remove the three screws as shown (see letter **A**).
2. Remove the module out of the server system (see letter **B**).

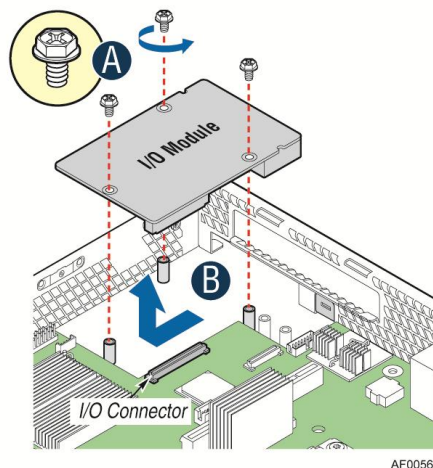

Figure 57. Removing an I/O Expansion Module

3. Install the I/O expansion module filler panel into the system back panel.

Installing and Removing the Intel® RAID C600 Upgrade Key

Installing the Intel® RAID C600 Upgrade Key

Locate the white 4-pin key header next to the SCU_0 and SCU-1 miniSAS connectors. Carefully pick up the Intel® RAID C600 Upgrade Key. Match the Key and connector orientation and press down to install.

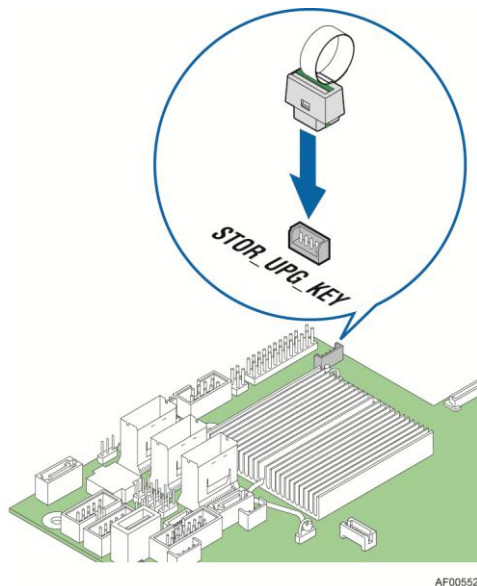

Figure 58. Installing the Intel® RAID C600 Upgrade Key

Removing the Intel® RAID C600 Upgrade Key

Pull up the key to remove it from the mother board.

Installing and Removing the Intel® Remote Management Module 4

Installing the Intel® RMM4 Lite

1. Locate the RMM4 Lite connector next to the POST diagnostic LEDs.
2. Carefully pick up the Intel® RMM4 Lite module.
3. Match the alignment pin of the module and the connector on the server board and press to install.

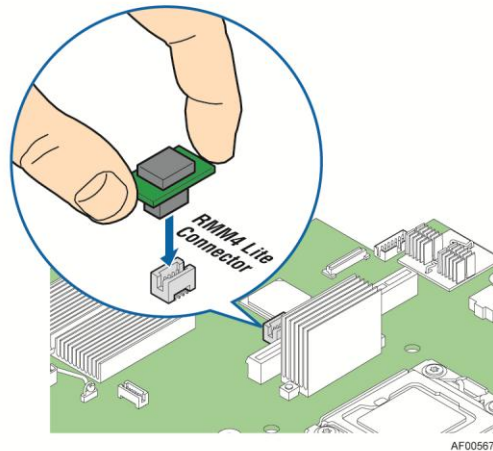

Figure 59. Installing the Intel® RMM4 Lite

Install the Intel® RMM4 NIC

1. Push out and remove the metal cover on the chassis where the NIC RJ-45 receptacle will align (see letter **A**).
2. Position the module over the server board, fit the front of the module into the back panel slot, and attach the module to the server board connector (see letter **B**).
3. Secure the module with the two screws as shown (see letter **C**).

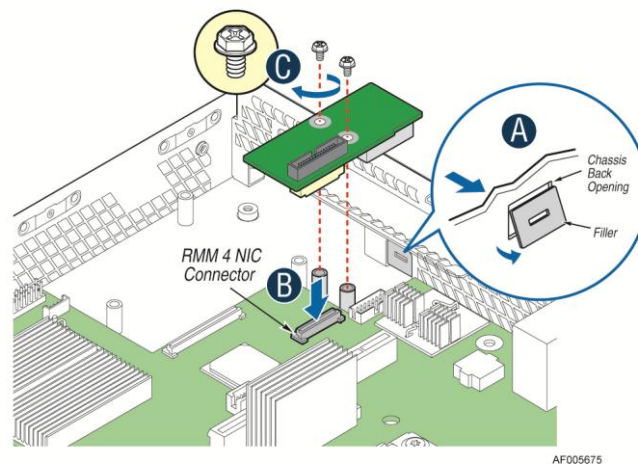

Figure 60. Installing the Intel® RMM4 NIC

Removing the Intel® RMM4 Lite

Pull up the RMM4 Lite module to remove it from the mother board.

Removing the Intel® RMM4 NIC

1. Remove the two screws as shown (see letter **A**).

2. Remove the module out of the server system (see letter **B**).

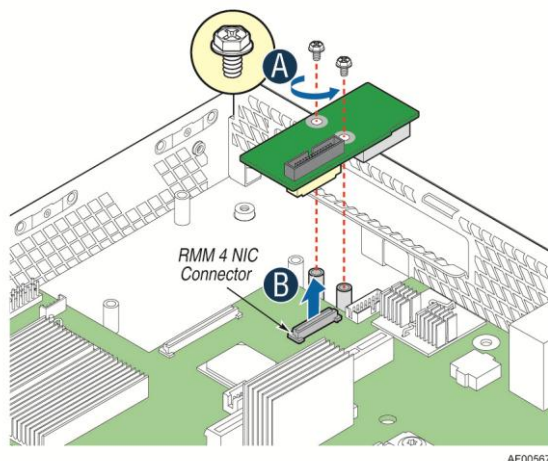

Figure 61. Removing the Intel® RMM4 NIC

Installing and Removing the Intel® RAID Smart Battery

Installing the Intel® RAID Smart Battery

1. Connect the cable between the BBU and the RAID card. For details, see *Intel® RAID Smart Battery User's Guide*.
2. Locate the BBU bracket inside the chassis. Align the tabs on the plastic battery holder with mounting holes on the BBU bracket (see letter **A**).
3. Slide the plastic battery holder toward the rear of the system until the tabs engage with the mounting holes in the BBU bracket (see letter **B**).

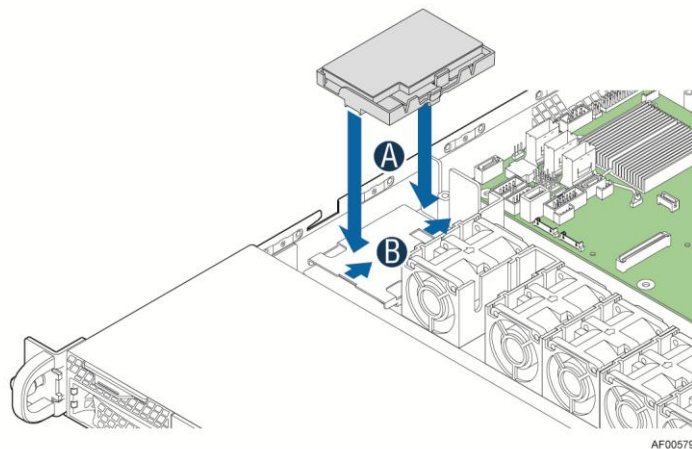

Figure 62. Installing the Intel® RAID Smart Battery

Removing the Intel® RAID Smart Battery

1. Slide the plastic battery holder toward the front of the system to disengage it from the BBU bracket (see letter **A**).
2. Lift the battery up to remove it from the server chassis (see letter **B**).

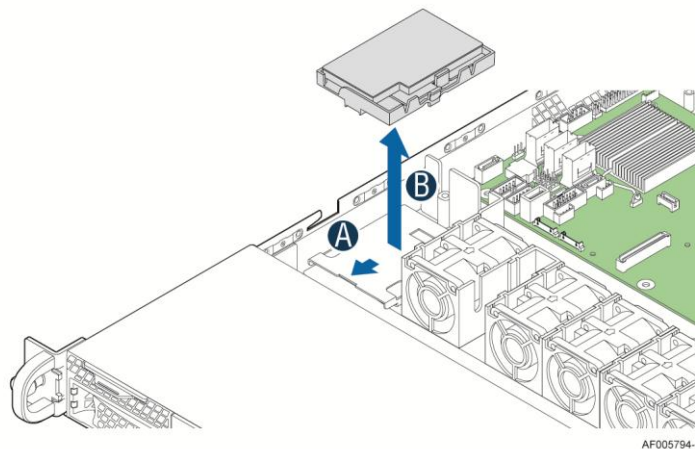

Figure 63. Removing the Intel® RAID Smart Battery

Replacing the Fixed Power Supply

Caution: Before replacing the power supply, you must first take the server out of service, turn off all peripheral devices connected to the system, turn off the system by pressing the power button, and unplug the AC power cord from the system or wall outlet.

The power supply can be replaced if it fails. To replace the power supply, follow these steps:

1. Unsecure the three screws from the rear side as shown (See Letter **A**), and remove the power supply (See Letter **B**).

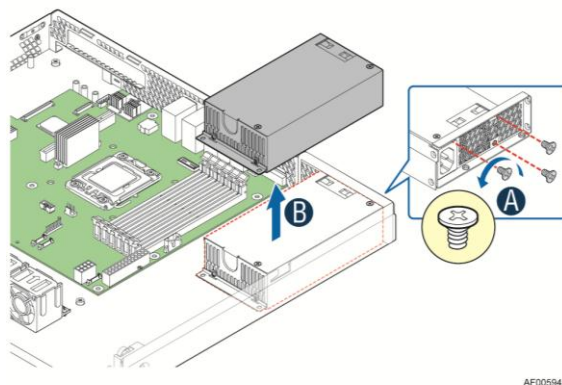

Figure 64. Removing the fixed power supply module

2. Insert the power supply into the chassis (See Letter **A**) and secure it with the screws (See Letter **B**).

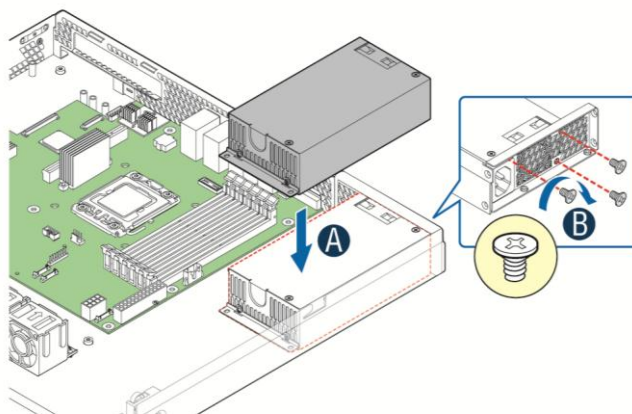

Figure 65. Installing the fixed power supply module

Replacing the Redundant Power Supply

Caution: The power supply is only hot-swappable if you have a redundant system with two power supplies installed. If you only have one power supply installed, before removing or replacing the power supply, you must first take the server out of service, turn off all peripheral devices connected to the system, turn off the system by pressing the power button, and unplug the AC power cord from the system or wall outlet.

The power supply can be replaced if it fails. To replace the power supply, follow these steps:

1. Push the green latch in the direction shown while pulling out of the system by the handle.

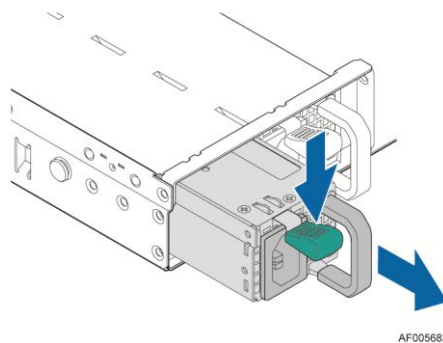

Figure 66. Removing the redundant power supply module

2. Insert the power supply module into the power supply cage and push all the way until it clicks into place.

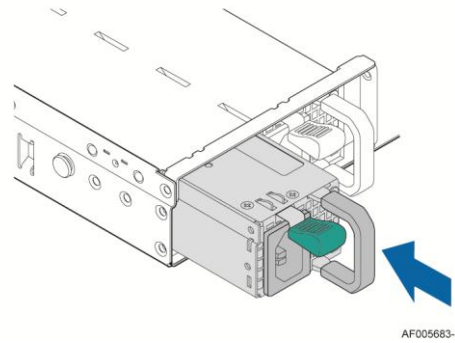

Figure 67. Installing the redundant power supply module

Installing and Removing the Server Board

Removing the Server Board

1. Lift the air duct straight up to remove from the server board.
2. Disconnect all cables from the server board.

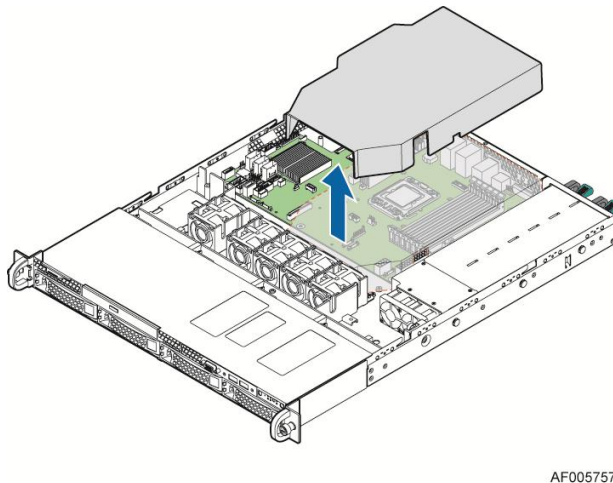
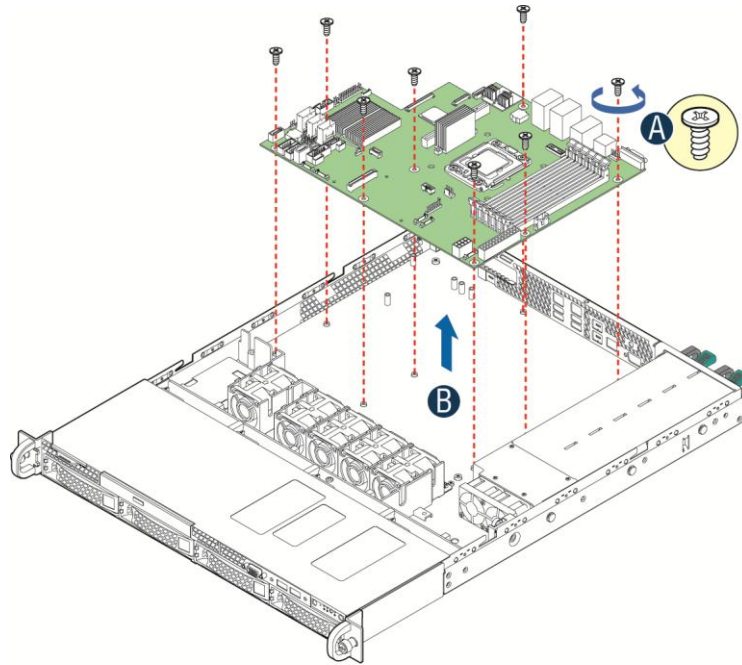

Figure 68. Removing the Air Duct

3. Remove the screws from the server board (see letter **A**).
4. Lift the server board from the server system (see letter **B**).



AF005938

Figure 69. Removing the Server Board

Installing the Server Board

1. Place the server board into the server system (see letter **A**).
2. Secure the server board with the screws (see letter **B**).

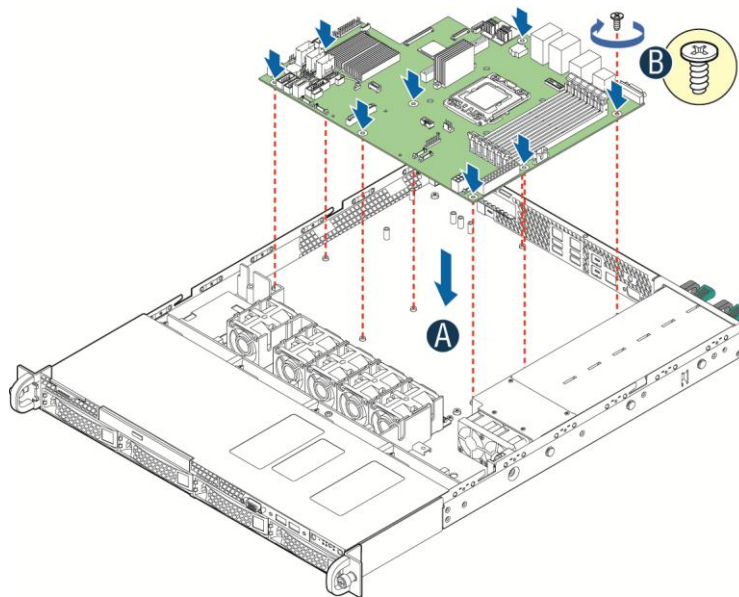

AF005937

Figure 70. Installing the Server Board

3. Install air duct onto the server board.

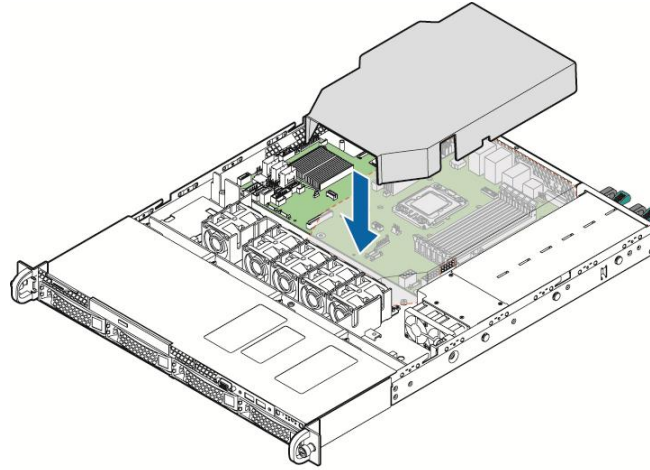

AF005756

Figure 71. Installing the Air Duct

4. Connect all power cables to the server board.

Replacing the Backup Battery

The lithium battery on the server board powers the RTC for up to 10 years in the absence of power. When the battery starts to weaken, it loses voltage, and the server settings stored in CMOS RAM in the RTC (for example, the date and time) may be wrong. Contact your customer service representative or dealer for a list of approved devices.

Warning: *Danger of explosion if battery is incorrectly replaced. Replace only with the same or equivalent type recommended by the equipment manufacturer. Discard used batteries according to manufacturer's instructions.*

Advarsel: Lithiumbatteri - Eksplosionsfare ved fejlagtig håndtering. Udskiftning må kun ske med batteri af samme fabrikat og type. Levér det brugte batteri tilbage til leverandøren.

Advarsel: Lithiumbatteri - Eksplosjonsfare. Ved utskifting benyttes kun batteri som anbefalt av apparatfabrikanten. Brukt batteri returneres apparatleverandøren.

Varning: Explosionsfara vid felaktigt batteribyte. Använd samma batterityp eller en ekvivalent typ som rekommenderas av apparattillverkaren. Kassera använt batteri enligt fabrikantens instruktion.

Varoitus: Paristo voi räjähtää, jos se on virheellisesti asennettu. Vaihda paristo ainoastaan laitevalmistajan suosittelemaan tyyppiin. Hävitä käytetty paristo valmistajan ohjeiden mukaisesti.

1. Locate the battery on the server board.
2. Gently press the metal clip as shown to release the battery (see letter **A**).
3. Remove the battery from the plastic socket (see letter **B**).

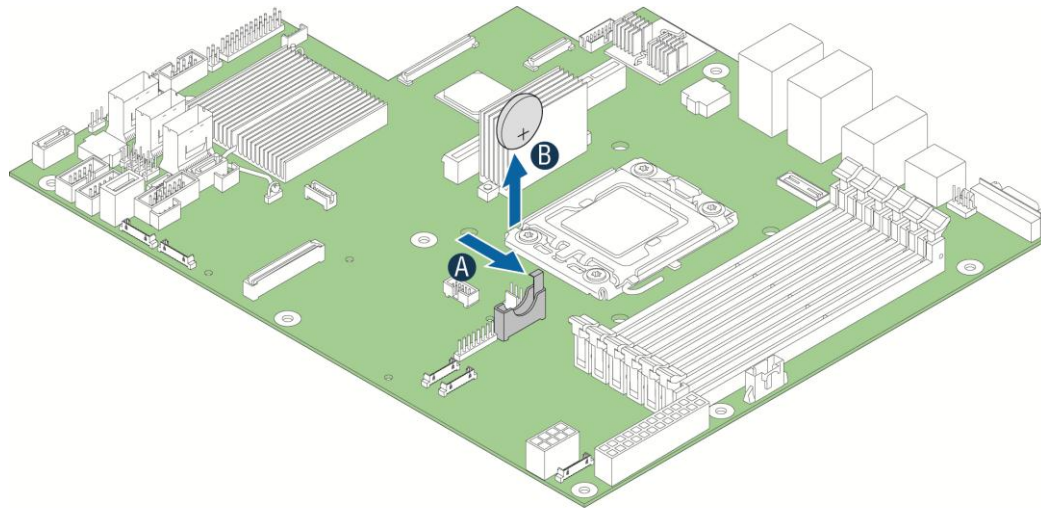

AF005939

Figure 72. Replacing the Backup Battery

4. Dispose of the battery according to local ordinance.
5. Remove the new lithium battery from its package, and, being careful to observe the correct polarity, insert it in the battery socket.

Note: You will need to run the BIOS Setup to restore the configuration settings to the RTC.

Replacing a System Fan

Note: The system fans cannot be hot swapped. System power must be removed when replacing a system fan.

1. Disconnect the fan cable (see letter A).
2. Pull system fan straight up to remove it from the fan holder (see letter B).

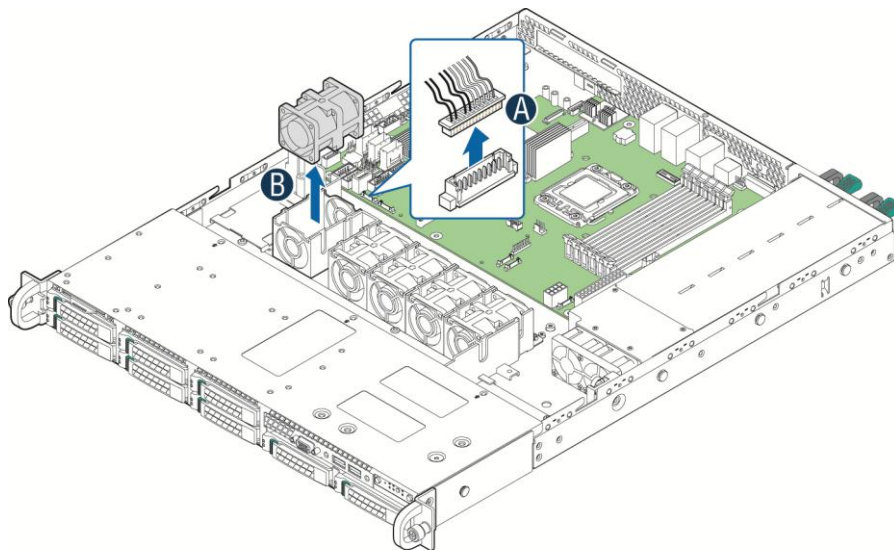

AF005680

Figure 73. Replacing a system fan

3. Replace the system fan.

Replacing the Backplane

Removing the Backplane

1. Remove all hot-swap drive carriers, regardless of whether or not a drive is installed in the carrier.
2. Disconnect all cables from the backplane.
3. Remove the screw (see letter **A**).
4. Pull up the backplane (see letter **B**).
5. Remove the backplane from the server chassis (see letter **C**).

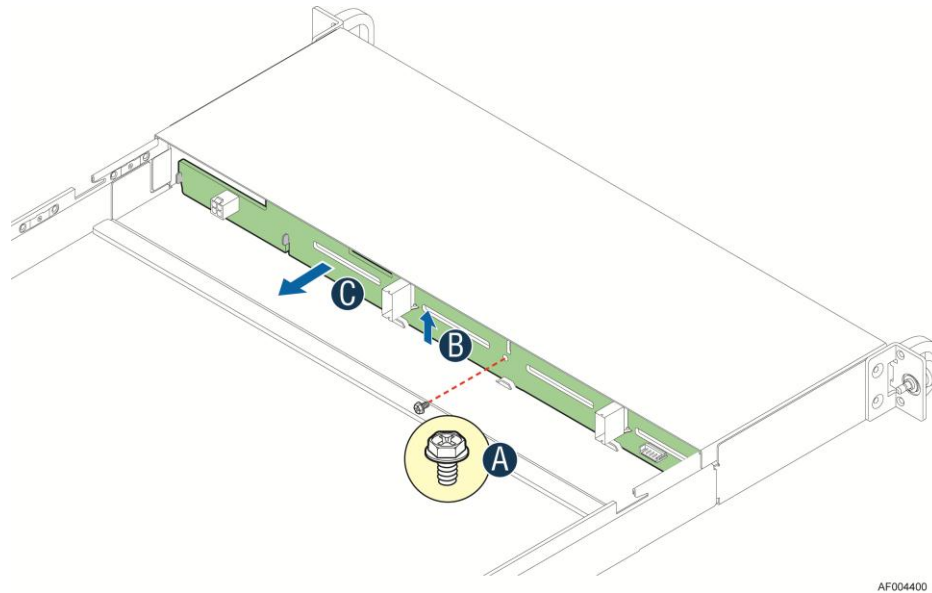

Figure 74. Removing the backplane

Installing the Backplane

1. Remove all hot-swap drive carriers, regardless of whether or not a drive is installed in the carrier.
2. Hold the backplane only by the edges. Do not push or pull on any components on the backplane. Position the backplane in place at the front of the server system (see letter **A**).
3. Slide the backplane into the server system guides (see letter **B**).
4. Secure the backplane with the screw as shown (see letter **C**).

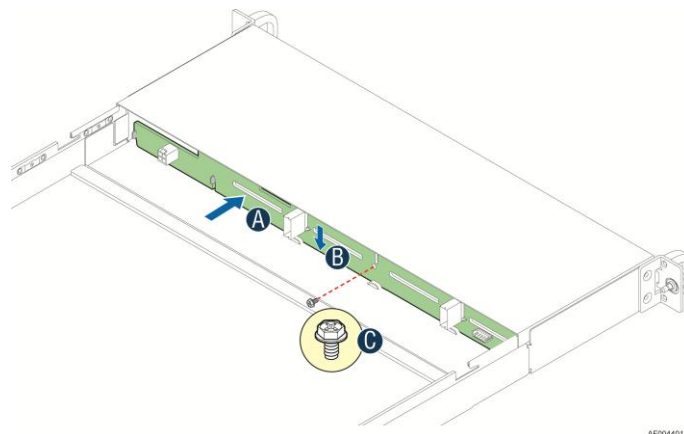

Figure 75. Installing the backplane

5. Connect cables to backplane; please refer to “Cable Routing”.

Installing and Removing the Rack Handles

Installing the Rack Handles

Align the rack handle with the two holes on the side of the server system and attach the rack handle to the server system with two screws as shown.

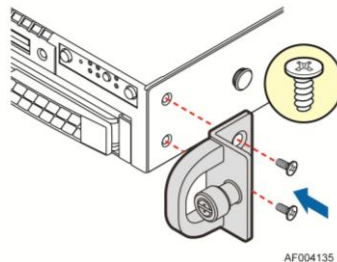

Figure 76. Installing the Rack Handle

Removing the Rack Handles

Remove the two screws holding the rack handle in place, and remove the rack handle from the server system as shown.

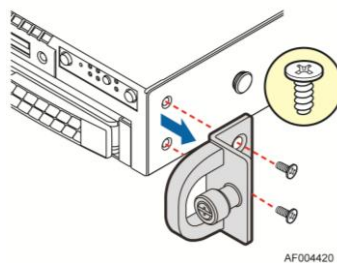

Figure 77. Removing the Rack Handle

3 Server Utilities

Using the BIOS Setup Utility

This section describes the BIOS Setup utility options, which is used to change server configuration defaults. You can run the BIOS Setup with or without an operating system being present. For information about specific BIOS setup screens, see the *Intel® Server Board S1400SP Technical Product Specification*. For a web link to this document, see [“Additional Information and Software”](#).

Entering BIOS Setup

To enter the BIOS Setup using a keyboard (or emulated keyboard), press the <F2> function key during boot time when the OEM or Intel Logo Screen or the POST Diagnostic Screen is displayed.

The following instructional message is displayed on the Diagnostic Screen or under the Quiet Boot Logo Screen:

Press <F2> to enter setup, <F6> Boot Menu, <F12> Network Boot

Note: *With a USB keyboard, it is important to wait until the BIOS “discovers” the keyboard and beeps – until the USB Controller has been initialized and the USB keyboard activated, key presses will not be read by the system.*

When the Setup Utility is entered, the Main screen is displayed initially. However, serious errors cause the system to display the Error Manager screen instead of the Main screen.

It is also possible to cause a boot directly to Setup using an IPMI 2.0 command “Get/Set System Boot Options”. For details on that capability, see the explanation in the IPMI description.

If You Cannot Access Setup

If you are not able to access the BIOS Setup, you might need to restore the BIOS default settings. For instructions, see [“Restoring the BIOS Defaults”](#).

Setup Menus

The bottom right portion of the Setup screen provides a list of commands that are used to navigate through the Setup utility. These commands are displayed at all times.

Each Setup menu page contains a number of features. Each feature is associated with a value field, except those used for informative purposes. Each value field contains configurable parameters. Depending on the security option chosen and in effect by the password, a menu feature’s value may or may not be changed. If a value cannot be changed, its field is made inaccessible and appears grayed out.

Table 3. BIOS Setup: Keyboard Command Bar

Key	Option	Description
<Enter>	Execute Command	The <Enter> key is used to activate submenus when the selected feature is a submenu, or to display a pick list if a selected option has a value field, or to select a subfield for multi-valued features like time and date. If a pick list is displayed, the <Enter> key selects the currently highlighted item, undoes the pick list, and returns the focus to the parent menu.

Key	Option	Description
<Esc>	Exit	<p>The <Esc> key provides a mechanism for backing out of any field. When the <Esc> key is pressed while editing any field or selecting features of a menu, the parent menu is re-entered.</p> <p>When the <Esc> key is pressed in any submenu, the parent menu is re-entered. When the <Esc> key is pressed in any major menu, the exit confirmation window is displayed and the user is asked whether changes can be discarded. If “No” is selected and the <Enter> key is pressed, or if the <Esc> key is pressed, the user is returned to where they were before <Esc> was pressed, without affecting any existing settings. If “Yes” is selected and the <Enter> key is pressed, the setup is exited and the BIOS returns to the main System Options Menu screen.</p>
↑	Select Item	The up arrow is used to select the previous value in a pick list, or the previous option in a menu item's option list. The selected item must then be activated by pressing the <Enter> key.
↓	Select Item	The down arrow is used to select the next value in a menu item's option list, or a value field's pick list. The selected item must then be activated by pressing the <Enter> key.
←	Select Menu	The left and right arrow keys are used to move between the major menu pages. The keys have no effect if a sub-menu or pick list is displayed.
<Tab>	Select Field	The <Tab> key is used to move between fields. For example, <Tab> can be used to move from hours to minutes in the time item in the main menu.
-	Change Value	The minus key on the keypad is used to change the value of the current item to the previous value. This key scrolls through the values in the associated pick list without displaying the full list.
+	Change Value	The plus key on the keypad is used to change the value of the current menu item to the next value. This key scrolls through the values in the associated pick list without displaying the full list. On 106-key Japanese keyboards, the plus key has a different scan code than the plus key on the other keyboards, but will have the same effect.
<F9>	Setup Defaults	<p>Pressing the <F9> key causes the following to display:</p> <div style="border: 1px solid black; padding: 10px; text-align: center;"> <p>Load Optimized Defaults?</p> <p>Yes No</p> </div> <p>If “Yes” is highlighted and <Enter> is pressed, all Setup fields are set to their default values. If “No” is highlighted and <Enter> is pressed, or if the <Esc> key is pressed, the user is returned to where they were before <F9> was pressed without affecting any existing field values.</p>
<F10>	Save and Exit	<p>Pressing the <F10> key causes the following message to display:</p> <div style="border: 1px solid black; padding: 10px; text-align: center;"> <p>Save configuration and reset?</p> <p>Yes No</p> </div> <p>If “Yes” is highlighted and <Enter> is pressed, all changes are saved and the Setup is exited. If “No” is highlighted and <Enter> is pressed, or the <Esc> key is pressed, the user is returned to where they were before <F10> was pressed without affecting any existing values.</p>

Upgrading the BIOS

Follow the instructions in the readme file that came with the BIOS upgrade. When the update completes, remove the bootable media from which you performed the upgrade.

Caution: Do not power down the system during the BIOS update process! The system will reset automatically when the BIOS update process is completed.

Note: You may encounter a CMOS Checksum error or other problem after reboot. If this happens, shut down the system and boot it again. CMOS checksum errors require that you enter Setup, load BIOS defaults, check your settings, save your settings, and exit Setup.

Clearing the Password

If the user or administrator password(s) is lost or forgotten, moving the password clear jumper into the "clear" position clears both passwords. The password clear jumper must be restored to its original position before a new password(s) can be set.

1. Power down the system. Do not unplug the power cord.
2. Open the server system. For instructions on removing the system cover, see [“Removing the System Cover”](#).
3. Locate the Password Clear jumper block at board.
4. Move the jumper from the normal operation position, that is, Password Clear Protect position (covering pins 1 and 2) to the Password Clear Erase position (covering pins 2 and 3). See [“System Recovery Jumpers”](#).
5. Wait ten seconds.
6. Move the Password Clear jumper back to the Password Clear Protect position (covering pins 1 and 2).
7. Close the server system.
8. Power up the server.

The password is now cleared and can be reset by going into the BIOS setup.

Restoring the BIOS Defaults

If you need to restore the BIOS default settings, the BIOS Default jumper will need to be used.

1. Power down the system; do not disconnect the AC power.
2. Open the server system. For instructions on removing the system cover, see [“Removing the System Cover”](#).
3. Locate the BIOS Default jumper block at board.
4. Move the jumper from the normal operation position (covering pins 1 and 2) to the Set Default position (covering pins 2 and 3). See [“System Recovery Jumpers”](#).
5. Wait five seconds.
6. Return the BIOS Default jumper to the normal position (covering pins 1 and 2).
7. Close the server system.
8. Power up the system.

The BIOS defaults settings are now restored and can be reset by going into the BIOS setup.

Appendix A: Technical Reference

Power Supply Input Voltages

460W power supply module

- 100 - 127 V at 50/60 Hz 5.8 A
- 200 - 240 V at 50/60 Hz 2.9 A

750W power supply module

- 100 - 127 V at 50/60 Hz 8.2 A
- 200 - 240 V at 50/60 Hz 4.4 A

Power Supply Output Voltages

The following table lists the total wattage available from the power subsystem for each voltage. For information about calculating the power usage for your configuration, please use the Power Budget Tool.

Table 4. Power Supply Output Capability

Voltage	Maximum Current
12V	62.0A
12VSB	2.1A

System Environmental Specifications

The following table defines the system level operating and non-operating environmental limits.

Table 5. System Environmental Limits Summary

Parameter		Limits
Temperature		
	Operating	ASHRAE Class A2 – Continuous Operation. 10°C to 35°C (50°F to 95° F) with the maximum rate of change not to exceed 10°C per hour
		ASHRAE Class A3 – Includes operation up to 40°C for up to 900 hrs per year.
		ASHRAE Class A4 – Includes operation up to 45°C for up to 90 hrs per year.
	Shipping	-40°C to 70°C (-40°F to 158°F)
Altitude		
	Operating	Support operation up to 3050m with ASHRAE class deratings.
Humidity		
	Shipping	50% to 90%, non-condensing with a maximum wet bulb of 28°C (at temperatures from 25°C to 35°C)
Shock		
	Operating	Half sine, 2g, 11 mSec

Appendix A: Technical Reference

Parameter		Limits
	Unpackaged	Trapezoidal, 25g, velocity change is based on packaged weight
	Packaged	Product Weight: ≥ 40 to < 80 Non-palletized Free Fall Height = 18 inches Palletized (single product) Free Fall Height = NA
Vibration		
	Unpackaged	5 Hz to 500 Hz 2.20 g RMS random
	Packaged	5 Hz to 500 Hz 1.09 g RMS random
AC-DC		
	Voltage	90 Hz to 132 V and 180 V to 264 V
	Frequency	47 Hz to 63 Hz
	Source Interrupt	No loss of data for power line drop-out of 12 mSec
	Surge Non-operating and operating	Unidirectional
	Line to earth Only	AC Leads 2.0 kV I/O Leads 1.0 kV DC Leads 0.5 kV
ESD		
	Air Discharged	12.0 kV
	Contact Discharge	8.0 kV
Acoustics Sound Power Measured		
	Power in Watts	<300 W ≥ 300 W ≥ 600 W ≥ 1000 W
	Servers/Rack Mount BA	7.0 7.0 7.0 7.0

See the *Intel® S1400SP Product Family Power Budget and Thermal Configuration Tool* for system configuration requirements and limitations.

Appendix B: Regulatory and Compliance Information

Please refer to the *Server Products Regulatory and Safety* document for the product regulatory compliance reference. The document can be downloaded from http://www.intel.com/p/en_US/support/.

Appendix C: Getting Help

If you encounter an issue with your server system, follow these steps to obtain support:

1. Visit the following Intel® support web page: http://www.intel.com/p/en_US/support/. This web page provides 24x7 support when you need it to get the latest and most complete technical support information on all Intel® Enterprise Server and Storage Platforms. Information available at the support site includes:
 - Latest BIOS, firmware, drivers, and utilities
 - Product documentation, installation, and quick start guides
 - Full product specifications, technical advisories, and errata
 - Compatibility documentation for memory, hardware add-in cards, chassis support matrix, and operating systems
 - Server and chassis accessory parts list for ordering upgrades or spare parts
 - A searchable knowledgebase to search for product information throughout the support site
2. If you are still unable to obtain a solution to your issue, send an email to Intel®'s technical support center using the online form available at <http://www.intel.com/support/feedback.htm?group=server>.
3. Lastly, you can contact an Intel® support representative using one of the support phone numbers available at <http://www.intel.com/support/feedback.htm?group=server> (charges may apply). Intel® customer support suggests filling out the issue report form available at “[Intel® Server Issue Report Form](#)” to better service the issue.

Intel® also offers Channel Program members around-the-clock 24x7 technical phone support on Intel® server boards, server chassis, server RAID controller cards, and Intel® Server Management at <http://www.intel.com/reseller/>.

Note: You will need to log in to the Reseller site to obtain the 24x7 number.

Warranty Information

To obtain warranty information, visit the following Intel® web site:
http://www.intel.com/p/en_US/support/warranty.

Appendix D: Intel® Server Issue Report Form

Issue Report Form (Rev 3.6)

Note: Filling out this form completely is required for any escalation.

Customer Contact Information:

Customer Support Case#:

Intel® Server Board or System:

(Example: S1400SP, R1000SP)

Server Chassis:

(Example P4000M. If third-party chassis used, indicate make and model.)

Base Board Information: (Some information maybe found by accessing BIOS and going through the Server Management menu > System Information)

Baseboard PBA/TA/AA # (Example: 123456-789):

- can be found on the white sticker label on the baseboard.

System BIOS Version:

Intel® Remote Management Module Firmware Version (if applicable):

Intel® Management Module BMC Revision (if applicable):

BMC Version:

FRU/SDR Version:

Has the latest BIOS been tried? (Yes/No):

Has the latest BMC been tried? (Yes/No):

Has the latest RMM Firmware been tried? (Yes/No):

Has the latest FRU/SDR been tried? (Yes/No):

Processor information:

	Type	Speed	sSpec	Thermal Solution
Processor 1				
Processor 2				

Thermal solution (Heat sink) examples:
 (1U, Passive w/air ducting, Active w/fan, and so on)

Memory:

Manufacturer	Part Number	DRAM Part Number	On Intel® tested list?

Add-in adapters (Example: NICs, Management Adapters, Serial Expansion Cards, PCI-Express* Adapters, RAID Controllers, SCSI Controllers, and so on):

Type	Slot	Manufacturer	Model	Firmware

Other third party hardware (Example: Example: KVM, Chassis, and so on):

Description/Use	Manufacturer	Model	Firmware

Storage Devices (Example: SCSI, SATA, SAS, USB, Tape, and so on):

Manufacturer	Model	Type	Size	Firmware	In Hot Swap Bay?

Appendix D: Intel® Server Issue Report Form

Manufacturer	Model	Type	Size	Firmware	In Hot Swap Bay?

Operating System Information (Example: RedHat* Enterprise Linux, Microsoft Windows Server 2003*, Service pack 1, OEM CD):

Manufacturer:

Version:

Language version (English, Arabic, and Chinese (Simplified)):

Service Pack Level or Kernel Revision:

Distribution (OEM/Retail):

Intel® RAID Controller: (Example SRCU42E)

RAID controller part number (PBA number):

RAID controller firmware version:

Has the latest RAID firmware been tried? (Yes/No):

RAID driver version:

Has the latest RAID driver been tried? (Yes/No):

RAID volumes configuration (disks & RAID level):

RAID volume use (Boot device/Data Volume):

Is BBU (Battery Backup Unit) installed? (Yes/No):

BBU part number:

Detailed description of issue:

Troubleshooting tried:

Steps to replicate the issue:

Issue impact statements:

Do you have any potential Intel® system, or component purchases that this issue is holding up? If yes, please provide a brief description below.

Do you have systems already purchased that are not being delivered to your customers because of this issue? If yes, please provide a brief description below.

Have you returned systems or components to your place of purchase because of this issue? If yes, please provide a brief description below.

*All other brands and names are property of their respective owners.